

Nemko Test Report No.:

3L0189RUS1

Applicant:

Communication Components
89 Leuning Street 299 Forest Avenue
Hackensack, NJ 07606

Equipment Under Test:

DAB-1819-100

In Accordance With:

FCC Part 24, Subpart E
Broadband PCS Repeaters

Tested By:

Nemko Dallas Inc.
802 N. Kealy
Lewisville, Texas 75057-3136

Authorized By:

Tom Tidwell, Frontline Manager

Date:

5/6/2003

Total Number of Pages:

30

Table of Contents

Section 1. Summary of Test Results3
Section 2. General Equipment Specification.....5
Section 3. RF Power Output.....7
Section 4. Occupied Bandwidth8
Section 5. Spurious Emissions at Antenna Terminals11
Section 7. Test Equipment List20
ANNEX A - TEST DETAILS21
ANNEX B - TEST DIAGRAMS.....27

EQUIPMENT: DAB-1819-100

Section 1. Summary of Test Results

Manufacturer: Communication Components, Inc.

Model No.: DAB-1819-100

Serial No.: None

General: **All measurements are traceable to national standards.**

These tests were conducted on a sample of the equipment for the purpose of demonstrating compliance with FCC Part 24, Subpart E.

New Submission

Production Unit

Class II Permissive Change

Pre-Production Unit

THIS TEST REPORT RELATES ONLY TO THE ITEM(S) TESTED.

THE FOLLOWING DEVIATIONS FROM, ADDITIONS TO, OR EXCLUSIONS FROM THE TEST SPECIFICATIONS HAVE BEEN MADE.: NONE

See " Summary of Test Data".

Nemko Dallas Inc. authorizes the above named company to reproduce this report provided it is reproduced in its entirety and for use by the company's employees only.

Any use which a third party makes of this report, or any reliance on or decisions to be made based on it, are the responsibility of such third parties. Nemko Dallas Inc. accepts no responsibility for damages, if any, suffered by any third party as a result of decisions made or actions based on this report. This report applies only to the items tested.

EQUIPMENT: **DAB-1819-100**

Summary Of Test Data

NAME OF TEST	PARA. NO.	SPEC.	RESULT
RF Power Output	24.232	<100W	Complies
Occupied Bandwidth (GSM EDGE))	24.238	Input/Output	Complies
Spurious Emissions at Antenna Terminals	24.238(a)	-13 dBm	Complies

Footnotes:

Section 2. General Equipment Specification

Frequency Bands:	Downlink:	<input checked="" type="checkbox"/> Block A : 1930 – 1945 MHz <input checked="" type="checkbox"/> Block D : 1945 – 1950 MHz <input checked="" type="checkbox"/> Block B : 1950 – 1965 MHz <input checked="" type="checkbox"/> Block E : 1965 – 1970 MHz <input checked="" type="checkbox"/> Block F : 1970 – 1975 MHz <input checked="" type="checkbox"/> Block C : 1975 – 1990 MHz						
Frequency Bands:	Uplink:	<input type="checkbox"/> Block A : 1850 – 1865 MHz <input type="checkbox"/> Block B : 1865 – 1870 MHz <input type="checkbox"/> Block C : 1870 – 1885 MHz <input type="checkbox"/> Block D : 1885 – 1890 MHz <input type="checkbox"/> Block E : 1890 – 1895 MHz <input type="checkbox"/> Block F : 1895 – 1910 MHz						
Type of Modulation and Designator:		<table style="width: 100%; border: none;"> <tr> <td style="text-align: center;">GSM EDGE (G7W)</td> <td style="text-align: center;">GSM (GXW)</td> <td style="text-align: center;">NADC (DXW)</td> </tr> <tr> <td style="text-align: center;"><input checked="" type="checkbox"/></td> <td style="text-align: center;"><input checked="" type="checkbox"/></td> <td style="text-align: center;"><input type="checkbox"/></td> </tr> </table>	GSM EDGE (G7W)	GSM (GXW)	NADC (DXW)	<input checked="" type="checkbox"/>	<input checked="" type="checkbox"/>	<input type="checkbox"/>
GSM EDGE (G7W)	GSM (GXW)	NADC (DXW)						
<input checked="" type="checkbox"/>	<input checked="" type="checkbox"/>	<input type="checkbox"/>						
System Gain:		10 dB						
Output Impedance:		50 ohms						
RF Output (Rated):	Uplink	Not tested. The Uplink path is always connected with coaxial connections to a BTS.						
RF Output (Rated):	Downlink	Per channel: 100 W Total: 100 W						
Frequency Translation:		<table style="width: 100%; border: none;"> <tr> <td style="text-align: center;">F1-F1</td> <td style="text-align: center;">F1-F2</td> <td style="text-align: center;">N/A</td> </tr> <tr> <td style="text-align: center;"><input checked="" type="checkbox"/></td> <td style="text-align: center;"><input type="checkbox"/></td> <td style="text-align: center;"><input type="checkbox"/></td> </tr> </table>	F1-F1	F1-F2	N/A	<input checked="" type="checkbox"/>	<input type="checkbox"/>	<input type="checkbox"/>
F1-F1	F1-F2	N/A						
<input checked="" type="checkbox"/>	<input type="checkbox"/>	<input type="checkbox"/>						
Band Selection:		<table style="width: 100%; border: none;"> <tr> <td style="text-align: center;">Software</td> <td style="text-align: center;">Duplexer</td> <td style="text-align: center;">Fullband</td> </tr> <tr> <td style="text-align: center;"><input type="checkbox"/></td> <td style="text-align: center;"><input type="checkbox"/></td> <td style="text-align: center;"><input checked="" type="checkbox"/></td> </tr> </table>	Software	Duplexer	Fullband	<input type="checkbox"/>	<input type="checkbox"/>	<input checked="" type="checkbox"/>
Software	Duplexer	Fullband						
<input type="checkbox"/>	<input type="checkbox"/>	<input checked="" type="checkbox"/>						

EQUIPMENT: DAB-1819-100

Description of Modifications for Class II Permissive Change

The modulation parameter for GSM EDGE (G7W) is being added. No hardware or software changes have been made.

Description of Operation

The EUT is an RF Single Channel Amplifier to boost either a PCS. The amplifier would be operated in an equipment rack and the antenna would be mounted on a pole or tower. The forward direction is wireless but the reverse direction is connected directly to a Base Station Transmitter via coaxial cables.

System Diagram

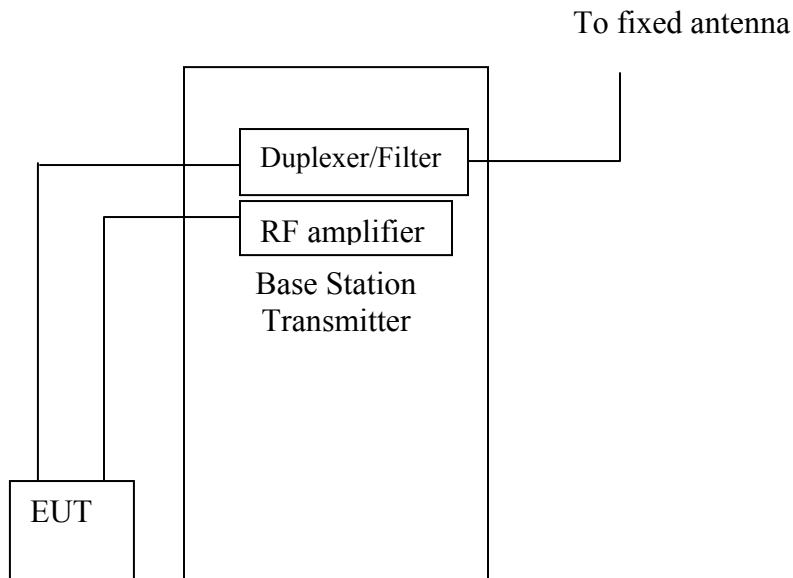

EQUIPMENT: **DAB-1819-100**

Section 3. RF Power Output

NAME OF TEST: RF Power Output	PARA. NO.: 2.1046
TESTED BY: D. Light	DATE:3/5/03

Test Results: Complies.

Measurement Data:

Frequency (MHz)	Modulation Type	Per Channel Output Power (dBm)	Composite Output Power (dBm)
1930.2*	EDGE	31.7	** N/A
1930.3	EDGE	50.0	N/A
1989.7	EDGE	50.0	N/A
1989.8*	EDGE	32.6	N/A
Intermodulation (Lower bandedge)	EDGE	41.0	***43.0
Intermodulation (Upper bandedge)	EDGE	40.4	43.4

*Power must be reduced at the bandedges to meet emission requirements. Refer to plots in Section 5 of this document.

** This is one carrier only.

***This reading was measured with two carriers at each bandedge.

Note-Intermodulation characteristics are being reported but the amplifier is meant for single channel use only.

Equipment Used: 1036-1629-1055-1064

Measurement Uncertainty: +/- 1.7 dB

EQUIPMENT: **DAB-1819-100**

Section 4. Occupied Bandwidth

NAME OF TEST: Occupied Bandwidth (GSM EDGE)	PARA. NO.: 2.1049
TESTED BY: David Light	DATE:

Test Results: Complies.

Test Data: See attached plot(s).

Measurement Uncertainty: +/- 1.6 dB

EQUIPMENT: **DAB-1819-100**

Test Data – Occupied Bandwidth



Nemko Dallas, Inc.

Dallas Headquarters:
 802 N. Kealy
 Lewisville, TX 75057
 Tel: (972) 436-9600
 Fax: (972) 436-2667

Data Plot		Occupied Bandwidth		Complete <u> x </u>
Page 1 of 2	Job No.: 2L0101R	Date: 5/9/2003		Preliminary: <u> </u>
Specification: 24.38	Temperature(°C): 23			
Tested By: Eldon Berry	Relative Humidity(%) 50			
E.U.T.: PCS Band GSM Booster				
Configuration: TX				
Sample Number: 1				
Location: Lab 1	RBW: Refer to plots		Measurement	
Detector Type: Peak	VBW: Refer to plots		Distance: <u> </u> m	
Test Equipment Used				
Antenna: <u> </u>	Directional Coupler: 1055			
Pre-Amp: <u> </u>	Cable #1: 1627			
Filter: <u> </u>	Cable #2: <u> </u>			
Receiver: 1036	Cable #3: <u> </u>			
Attenuator #1: 1064	Cable #4: <u> </u>			
Attenuator #2: 1604	Mixer: <u> </u>			
Additional equipment used: <u> </u>				
Measurement Uncertainty: +/-1.7 dB				

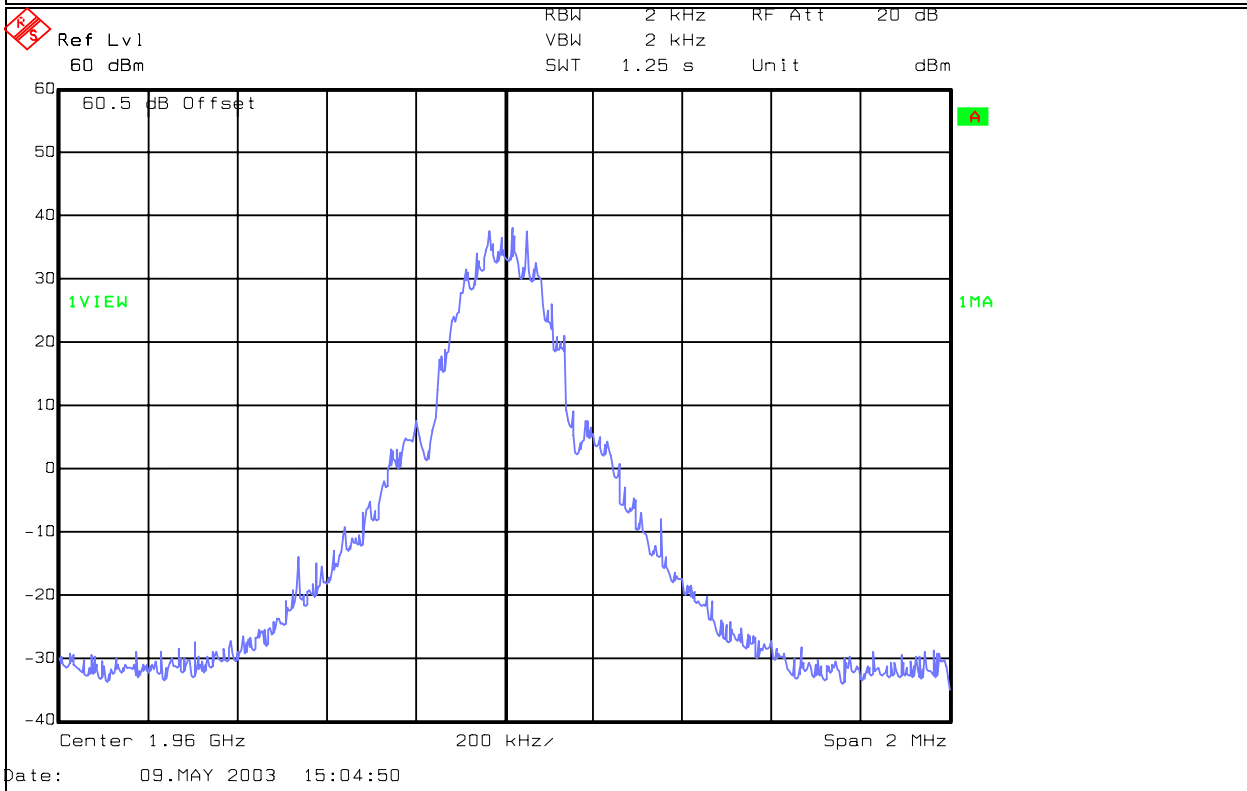

Date: 09.MAY 2003 15:04:50

Notes: **100 watt amp output plot**

EQUIPMENT: DAB-1819-100

Test Data – Occupied Bandwidth



Dallas Headquarters:
 802 N. Kealy
 Lewisville, TX 75057
 Tel: (972) 436-9600
 Fax: (972) 436-2667

Nemko Dallas, Inc.

Data Plot		Occupied Bandwidth	
Page 2 of 2			
Job No.:	2L0101R	Date:	5/9/2003
Specification:	24.4	Temperature(°C):	23
Tested By:	Eldon Berry	Relative Humidity(%)	50
E.U.T.:	PCS Band GSM Booster		
Configuration:	TX		

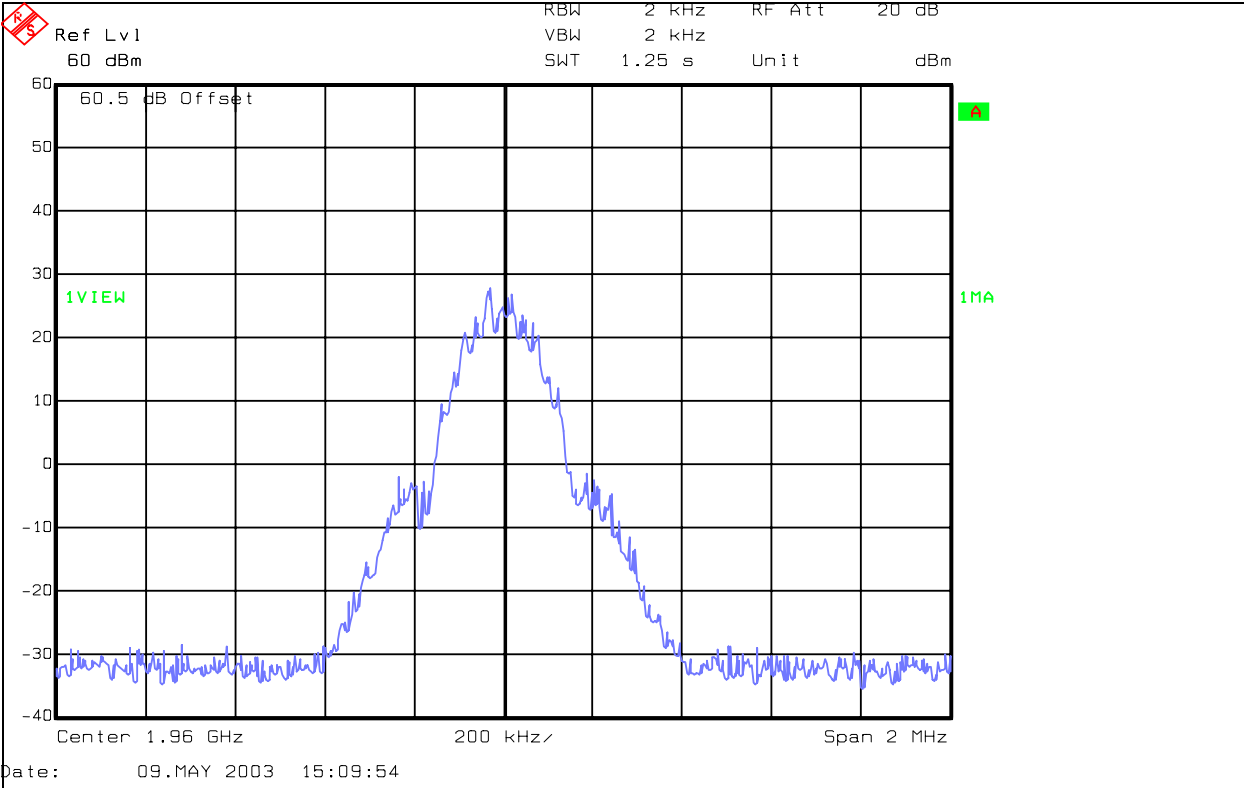

Notes: 100 watt amp input plot

EQUIPMENT: **DAB-1819-100**

Section 5. Spurious Emissions at Antenna Terminals

NAME OF TEST: Spurious Emissions @ Antenna Terminals	PARA. NO.: 2.1051
TESTED BY: David Light	DATE:

Test Results: Complies.

Test Data: See attached plot(s).

**Measurement
Uncertainty:** +/- 1.7 dB

Note-Intermodulation characteristics are being reported but the amplifier is meant for single channel use only.

Nemko Dallas

FCC PART 24, SUBPART E
BROADBAND PCS REPEATERS
PROJECT NO.: **3L0189RUS1**

EQUIPMENT: **DAB-1819-100**

EQUIPMENT: **DAB-1819-100**

Test Data – Spurious Emissions at Antenna Terminals



Dallas Headquarters:
 802 N. Kealy
 Lewisville, TX 75057
 Tel: (972) 436-9600
 Fax: (972) 436-2667

Nemko Dallas, Inc.

<u>Data Plot</u>		<u>Spurious Emissions at Antenna Terminals</u>	
Page 1 of 7		Date: <u>5/6/2003</u>	Complete <u>x</u>
Job No.: <u>3L0189R</u>	Temperature(°C): <u>22</u>	Preliminary: _____	
Specification: <u>PART 24</u>	Relative Humidity(%): <u>40</u>		
Tested By: <u>David Light</u>			
E.U.T.: <u>PCS Band Amplifier</u>			
Configuration: <u>TX</u>			
Sample Number: <u>1</u>			
Location: <u>Lab 1</u>	RBW: <u>Refer to plots</u>	Measurement	
Detector Type: <u>Peak</u>	VBW: <u>Refer to plots</u>	Distance: <u>N/A</u> m	
Test Equipment Used			
Antenna: _____	Directional Coupler: <u>1055</u>		
Pre-Amp: _____	Cable #1: <u>1627</u>		
Filter: _____	Cable #2: _____		
Receiver: <u>1036</u>	Cable #3: _____		
Attenuator #1: <u>1604</u>	Cable #4: _____		
Attenuator #2: _____	Mixer: _____		
Additional equipment used: _____			
Measurement Uncertainty: <u>+/-1.7 dB</u>			

Ref Lvl 50 dBm	Marker 1 [11] 32.19 dBm 1.98969900 GHz	RBW 2 kHz	RF Att 10 dB
		VBW 2 kHz	
		SWT 640 ms	Unit dBm

Center 1.99 GHz 100 kHz/ Span 1 MHz

Date: 05.MAY 2003 15:04:42

Notes: <u>UpperBandedge</u>
<u>1989.7 MHz CF @ 100 Watts output (Rated power)</u>

EQUIPMENT: DAB-1819-100

Test Data – Spurious Emissions at Antenna Terminals



Dallas Headquarters:
 802 N. Kealy
 Lewisville, TX 75057
 Tel: (972) 436-9600
 Fax: (972) 436-2667

Nemko Dallas, Inc.

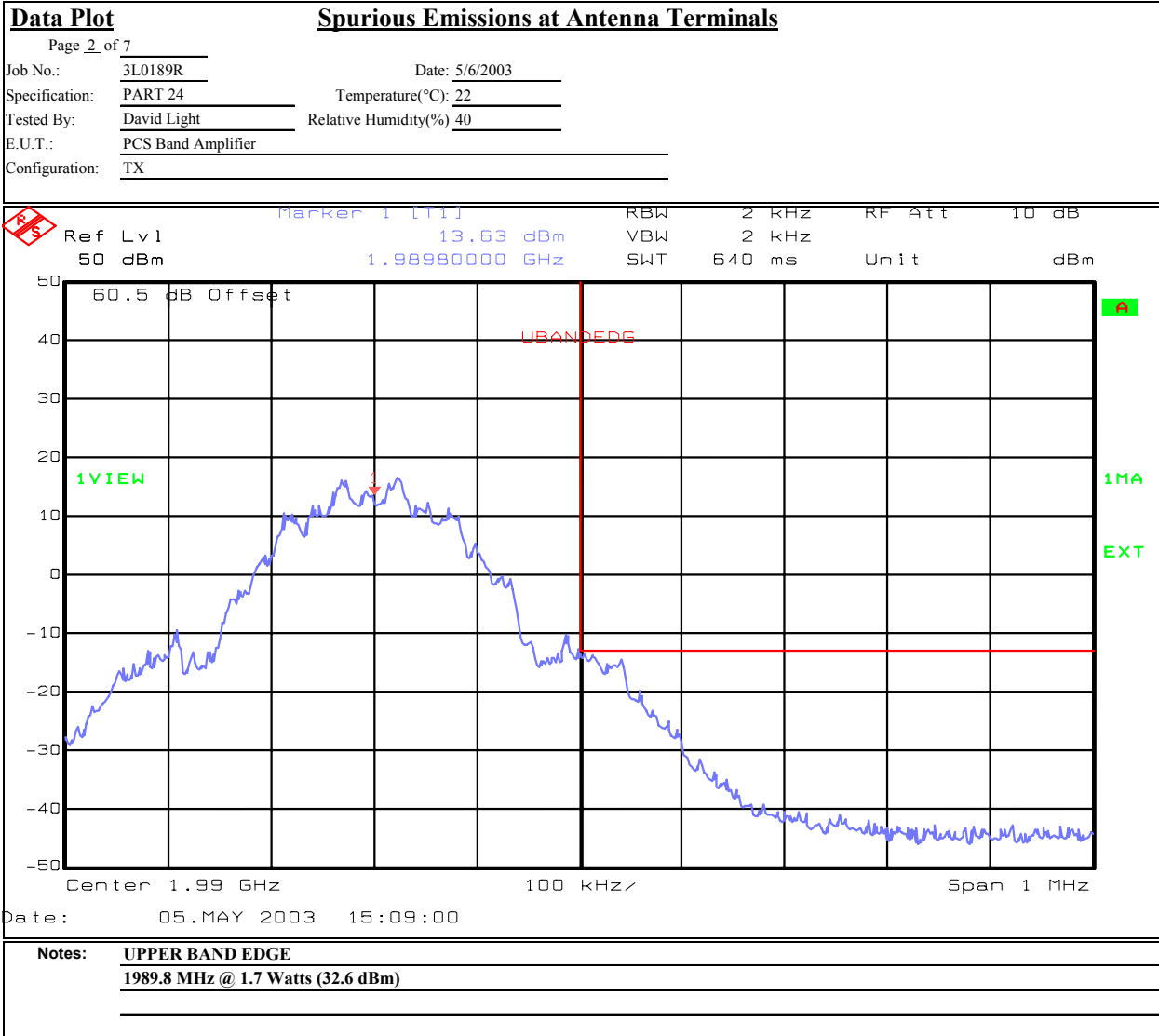

EQUIPMENT: DAB-1819-100

Test Data – Spurious Emissions at Antenna Terminals



Nemko Dallas, Inc.

Dallas Headquarters:
 802 N. Kealy
 Lewisville, TX 75057
 Tel: (972) 436-9600
 Fax: (972) 436-2667

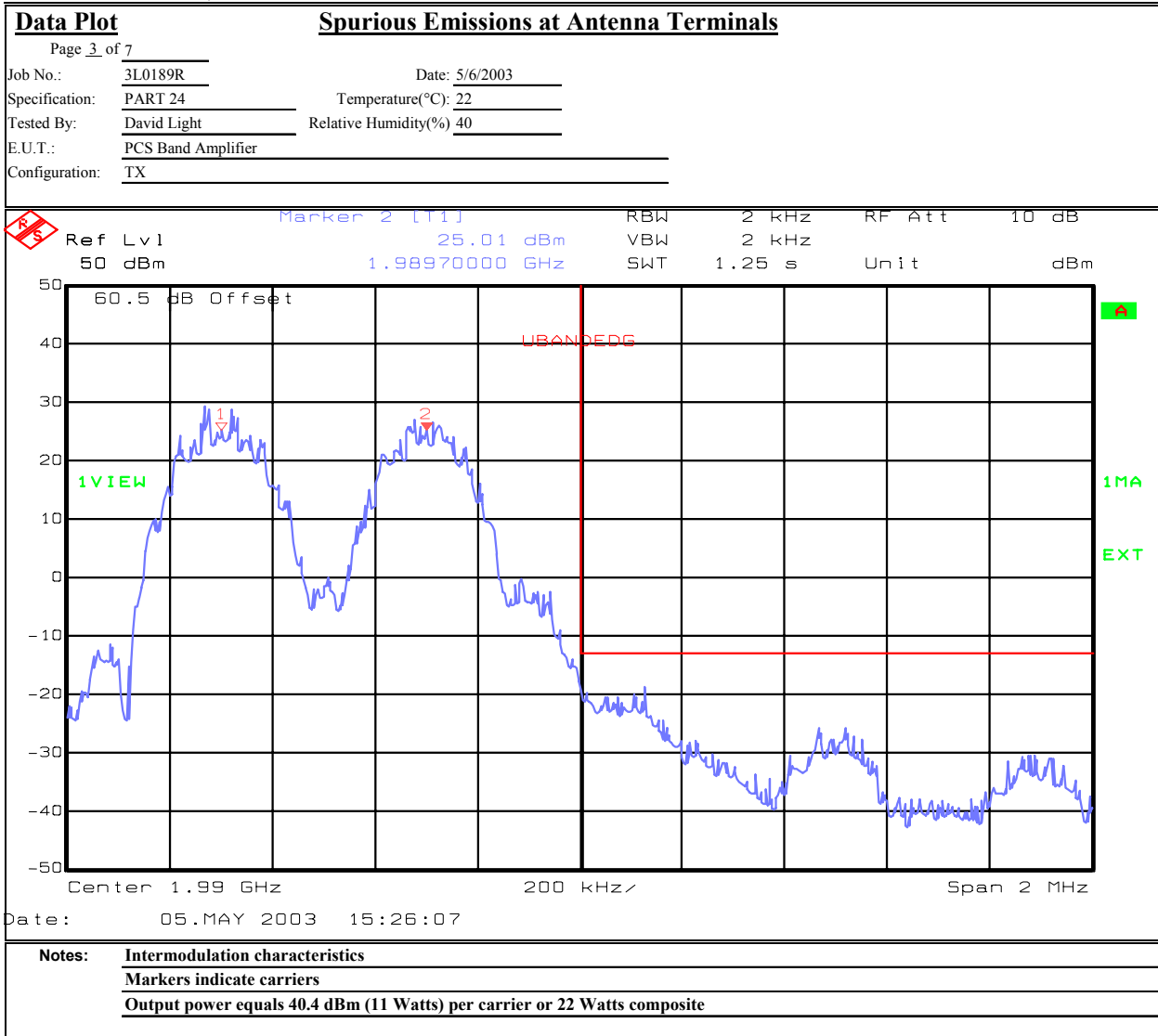

EQUIPMENT: DAB-1819-100

Test Data – Spurious Emissions at Antenna Terminals



Nemko Dallas, Inc.

Dallas Headquarters:
 802 N. Kealy
 Lewisville, TX 75057
 Tel: (972) 436-9600
 Fax: (972) 436-2667

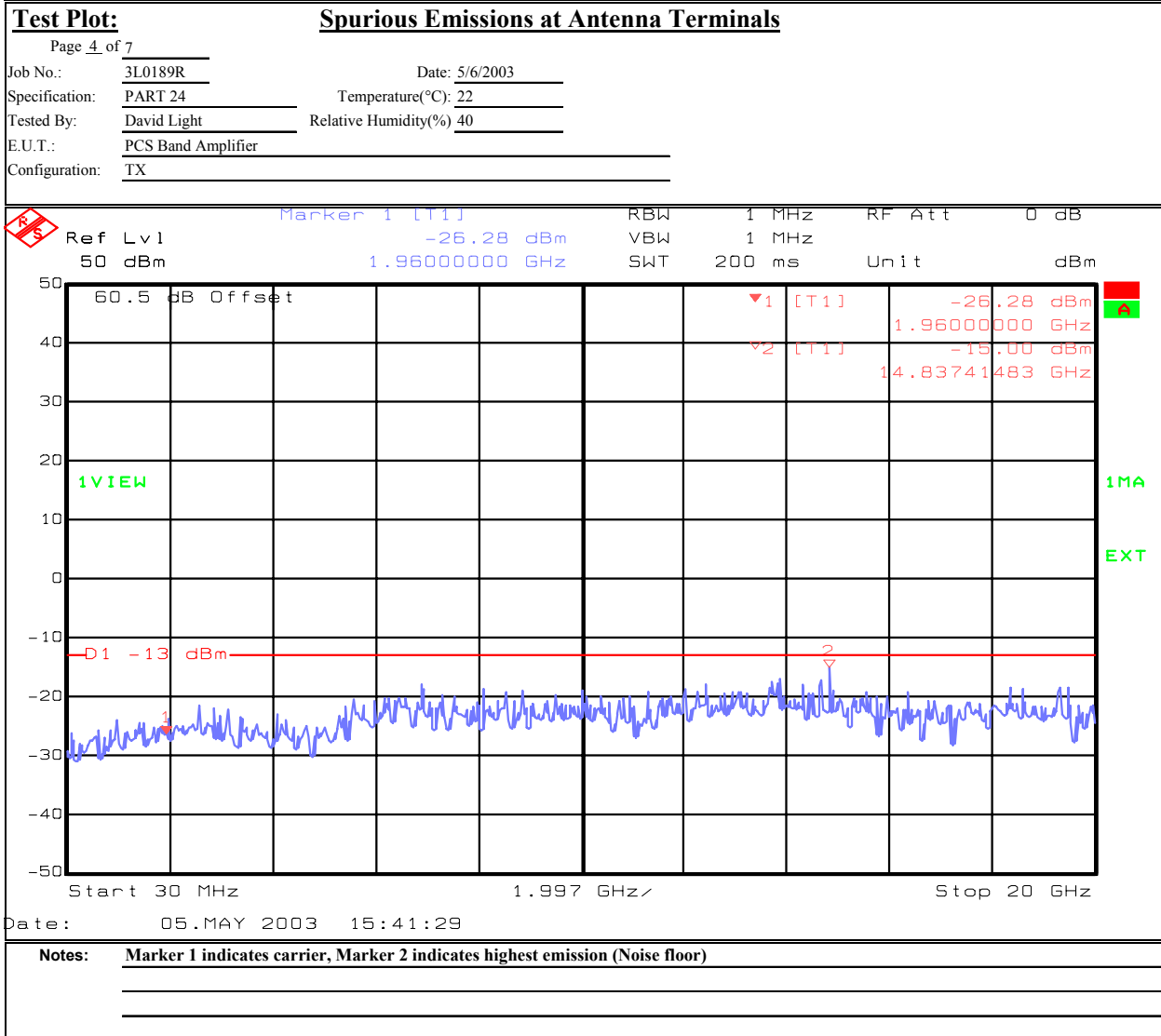

EQUIPMENT: DAB-1819-100

Test Data – Spurious Emissions at Antenna Terminals



Nemko Dallas, Inc.

Dallas Headquarters:
 802 N. Kealy
 Lewisville, TX 75057
 Tel: (972) 436-9600
 Fax: (972) 436-2667

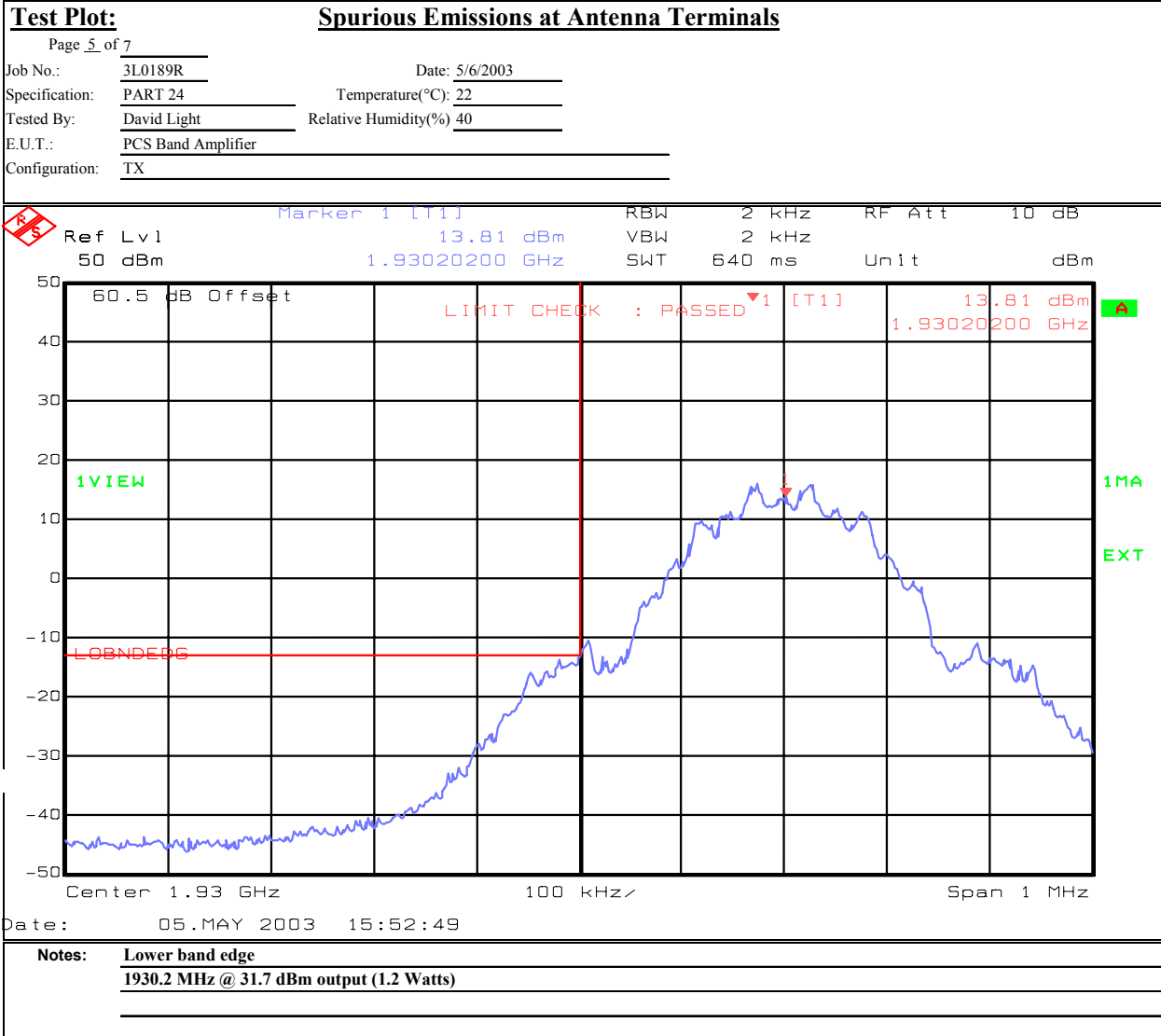

EQUIPMENT: DAB-1819-100

Test Data – Spurious Emissions at Antenna Terminals



Nemko Dallas, Inc.

Dallas Headquarters:
 802 N. Kealy
 Lewisville, TX 75057
 Tel: (972) 436-9600
 Fax: (972) 436-2667

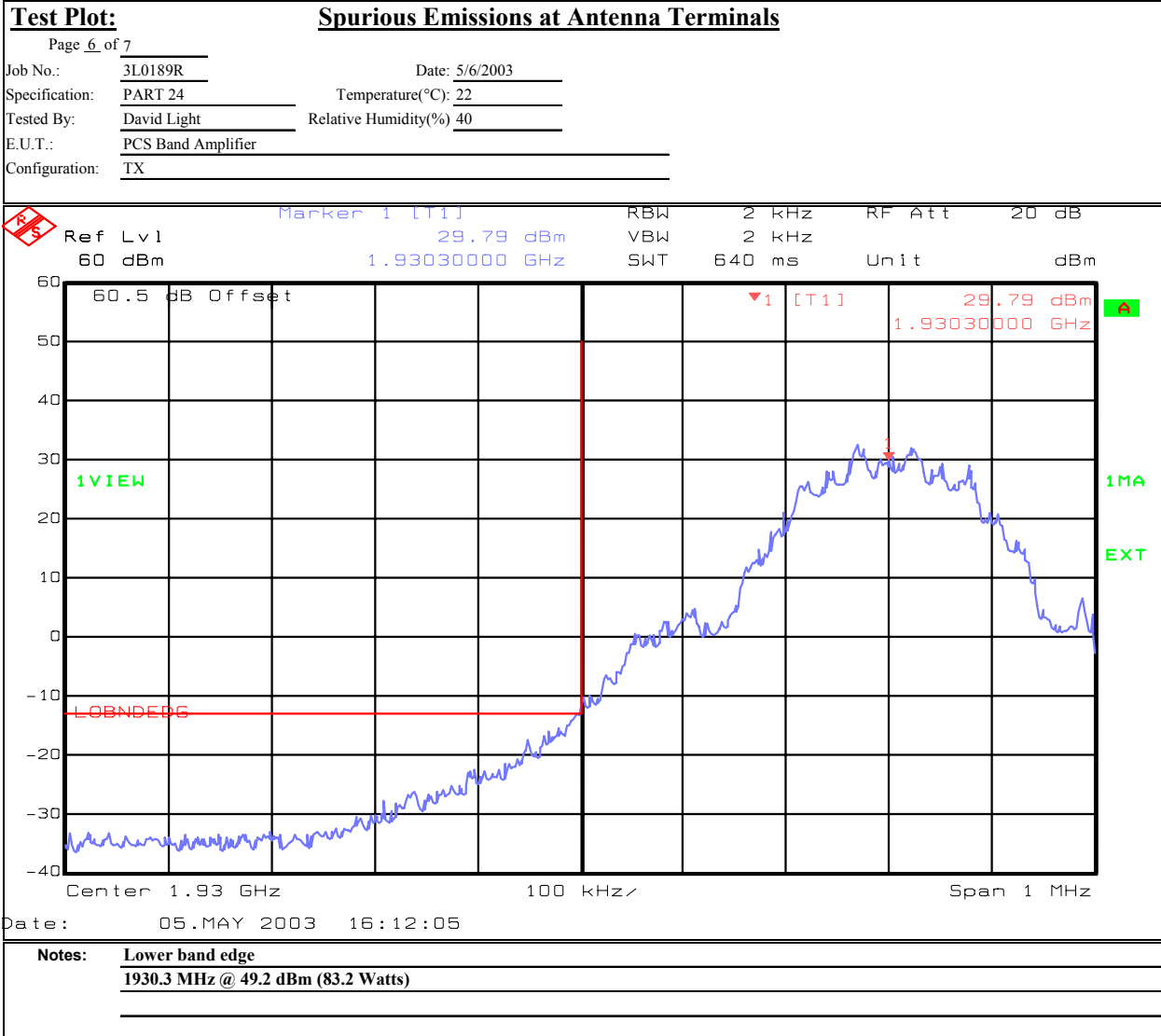

EQUIPMENT: DAB-1819-100

Test Data – Spurious Emissions at Antenna Terminals



Nemko Dallas, Inc.

Dallas Headquarters:
 802 N. Kealy
 Lewisville, TX 75057
 Tel: (972) 436-9600
 Fax: (972) 436-2667

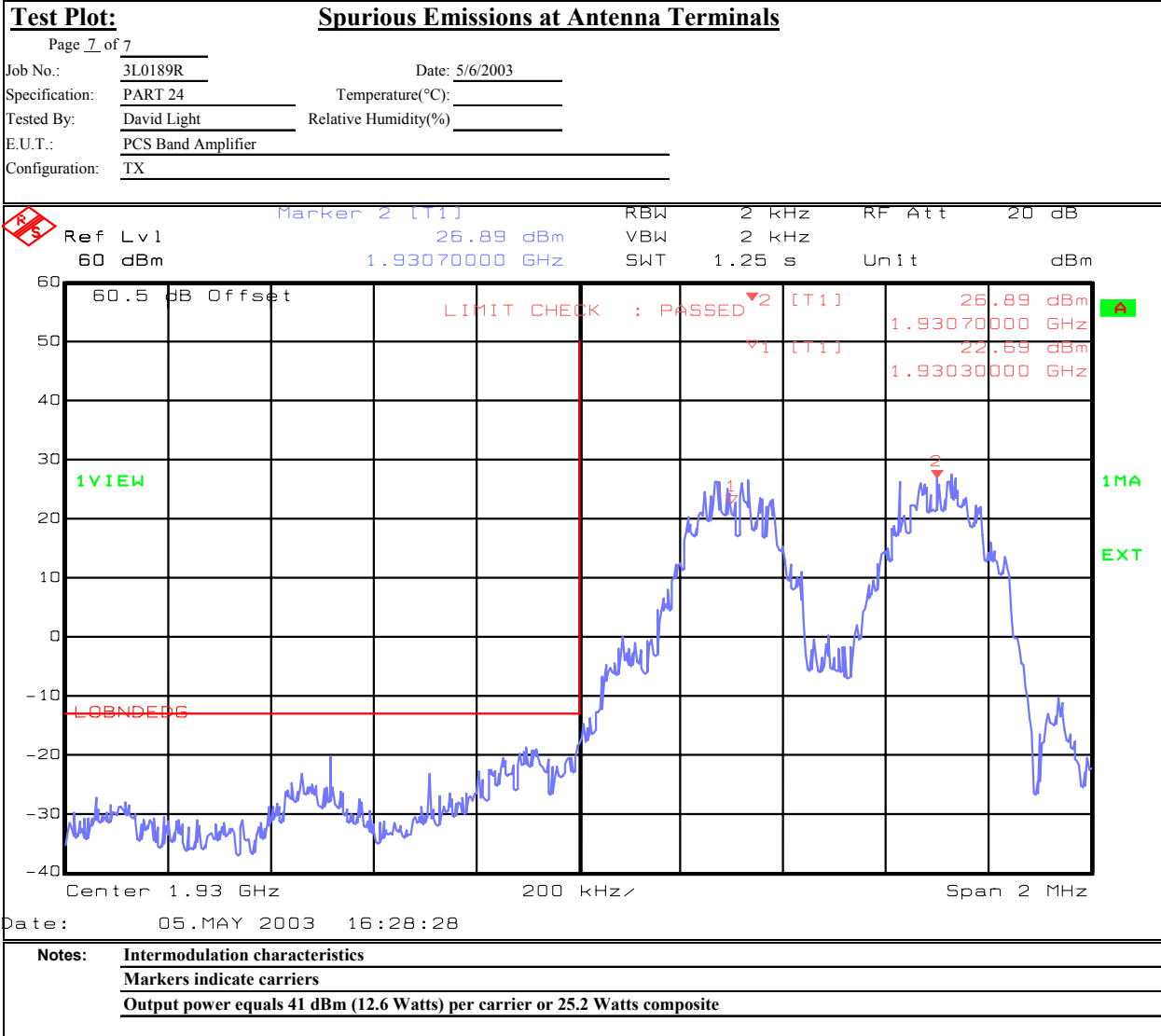

EQUIPMENT: **DAB-1819-100**

Section 7. Test Equipment List

Nemko ID	Description	Manufacturer Model Number	Serial Number	Calibration Date	Calibration Due
1036	SPECTRUM ANALYZER	ROHDE & SCHWARZ FSEK30	830844/006	12/18/01	12/19/03
1055	DUAL DIRECTIONAL COUPLER	NARDA 3022	73393	Cal Not Req	N/A
1064	ATTENUATOR	NARDA 776B-20	NONE	CBU	N/A
1604	ATTENUATOR	NARDA 776B-20	NONE	N/A	N/A
1627	CABLE, 5 ft	MEGAPHASE 10312 1GVT4	N/A	CBU	N/A

ANNEX A - TEST DETAILS

NAME OF TEST: RF Power Output**PARA. NO.: 2.1046**

Minimum Standard: Para. No.24.232. Base stations are limited to 1640 watts peak E.I.R.P. with an antenna height up to 300 meters HAAT. In no case may the peak output power of a base station transmitter exceed 100 watts.

Method Of Measurement:Detachable Antenna:

The peak power at antenna terminals is measured using an in-line peak power meter. Power output is measured with the maximum rated input level.

Integral Antenna:

If the antenna is not detachable from the circuit then the Peak Power Output is derived from the peak radiated field strength of the fundamental emission by using the plane wave relation $GP/4\pi R^2 = E^2/120\pi$ and proceeding as follows:

$$P = \frac{E^2 R^2}{30G} = \frac{E^2 3^2}{30G}$$

where,

P = the equivalent isotropic radiated power in watts

E = the maximum measured field strength in V/m

R = the measurement range (3 meters)

G = the numeric gain of the transmit antenna in relation to an isotropic radiator

EQUIPMENT: DAB-1819-100

NAME OF TEST: Occupied Bandwidth

PARA. NO.: 2.1047

Minimum Standard: Para. No. 24.238(b). The emission bandwidth is defined as the width of the signal between two points, one below the carrier center frequency and one above the carrier center frequency, outside of which all emissions are attenuated at least 26 dB.

Method Of Measurement:

CDMA

Spectrum analyzer settings:

RBW: 30 kHz

VBW: \geq RBW

Span: 5 MHz

Sweep: Auto

Mask: Set markers to -26 dB from peak of CW.

GSM

RBW: 3 kHz

VBW: \geq RBW

Span: 2 MHz

Sweep: Auto

Mask: Set markers to -26 dB from peak of CW.

NADC

RBW: 1 kHz

VBW: \geq RBW

Span: 1 MHz

Sweep: Auto

Mask: Set markers to -26 dB from peak of CW.

NAME OF TEST: Spurious Emission at Antenna Terminals PARA. NO.: 2.1051

Minimum Standard: Para. No.24.238(a). On any frequency outside a licensee’s frequency block, the power of any emission shall be attenuated below the transmitter power by at least 43 + 10 log (P) dB.

Method Of Measurement:

Spectrum analyzer settings:

CDMA

RBW: 1 MHz (> 1 MHz from Band Edge)
RBW: 30 kHz (< 1MHz from Band Edge)
VBW: ≥ RBW
Sweep: Auto
Video Avg: 6 Sweeps

GSM

RBW: 1 MHz (> 1 MHz from Band Edge)
RBW: 3 kHz (< 1 MHz from Band Edge)
VBW: ≥ RBW
Sweep: Auto
Video Avg: Disabled

NADC

RBW: 1 MHz (> 1 MHz from Band Edge)
RBW: 3 kHz (< 1 MHz from Band Edge)
VBW: ≥ RBW
Sweep: Auto
Video Avg: Disabled

To demonstrate compliance at band edges the frequency of the input signal is set to the lowest and highest assigned channel and the center frequency of the spectrum analyzer is set to the upper and lower edges of the appropriate frequency block.

EQUIPMENT: **DAB-1819-100**

NAME OF TEST: Field Strength of Spurious Radiation	PARA. NO.: 2.1053
---	--------------------------

Minimum Standard: Para. No.24.238(a). On any frequency outside a licensee’s frequency block, the power of any emission shall be attenuated below the transmitter power by at least $43 + 10 \log (P)$ dB.

Test Method: TIA/EIA-603-1992, Section 2.2.12

The antenna substitution method was used to determine the equivalent radiated power at spurious frequencies. The spurious emissions were measured at a distance of 3 meters. The EUT was then replaced with a reference substitution antenna with a known gain referenced to a dipole. This antenna was fed with a signal at the spurious frequency. The level of the signal was adjusted to repeat the previously measured level. The resulting erp is the signal level fed to the reference antenna corrected for gain referenced to a dipole.

EQUIPMENT: DAB-1819-100

NAME OF TEST: Frequency Stability	PARA. NO.: 2.1055
--	--------------------------

Minimum Standard: Para. No. 24.235. The frequency stability shall be sufficient to ensure that the fundamental emission stays within the authorized frequency block.

Method Of Measurement:

Frequency Stability With Voltage Variation

The E.U.T. is placed in an environmental chamber and allowed to stabilize at +20 degrees Celsius for at least 15 minutes. The frequency counter and signal generator are phase locked with the same 10 MHz reference frequency by connecting the 10 MHz ref. out of the counter to the 10 MHz ref, in of the signal generator. With the voltage input to the E.U.T. set to 85% S.T.V., the frequency is measured in 30 second intervals for a period of 5 minutes. This procedure is repeated at 100% S.T.V. and 115% S.T.V.

Frequency Stability With Temperature Variation

The input voltage to the E.U.T. is set to S.T.V. and the temperature of the environmental chamber is varied in 10 degree steps from -30 degrees C to +50 degrees C. The E.U.T. is allowed to stabilize at each temperature and the frequency is measured in 30 second intervals for a period of 5 minutes.

ANNEX B - TEST DIAGRAMS

EQUIPMENT: DAB-1819-100

Para. No. 2.985 - R.F. Power Output

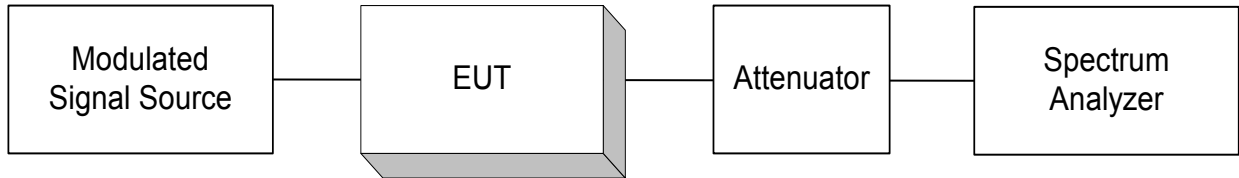

Para. No. 2.989 - Occupied Bandwidth

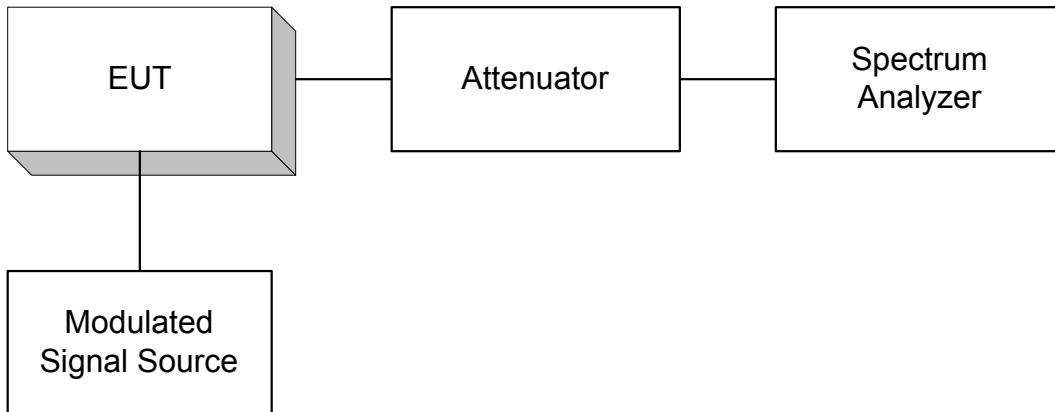

EQUIPMENT: DAB-1819-100

Para. No. 2.991 Spurious Emissions at Antenna Terminals

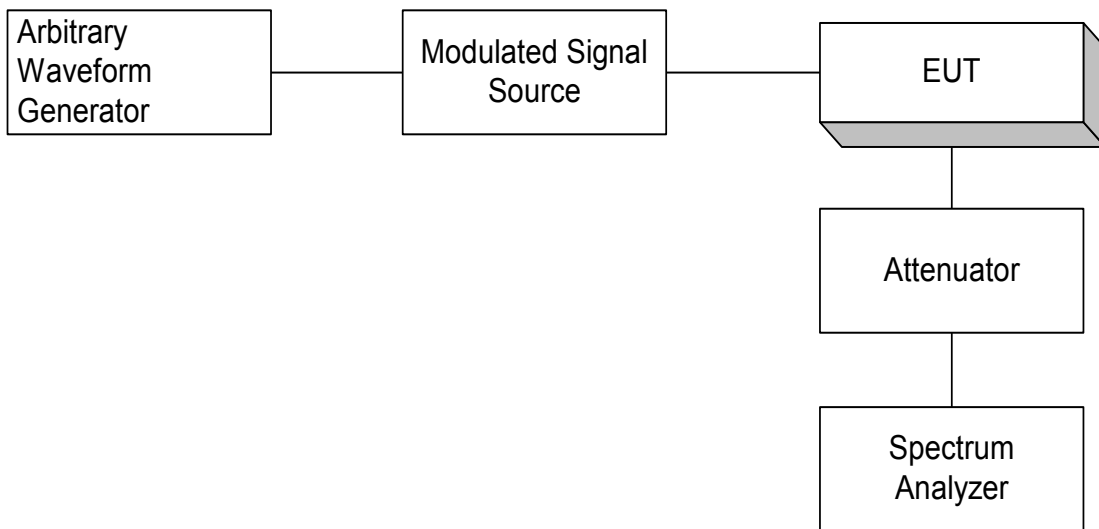
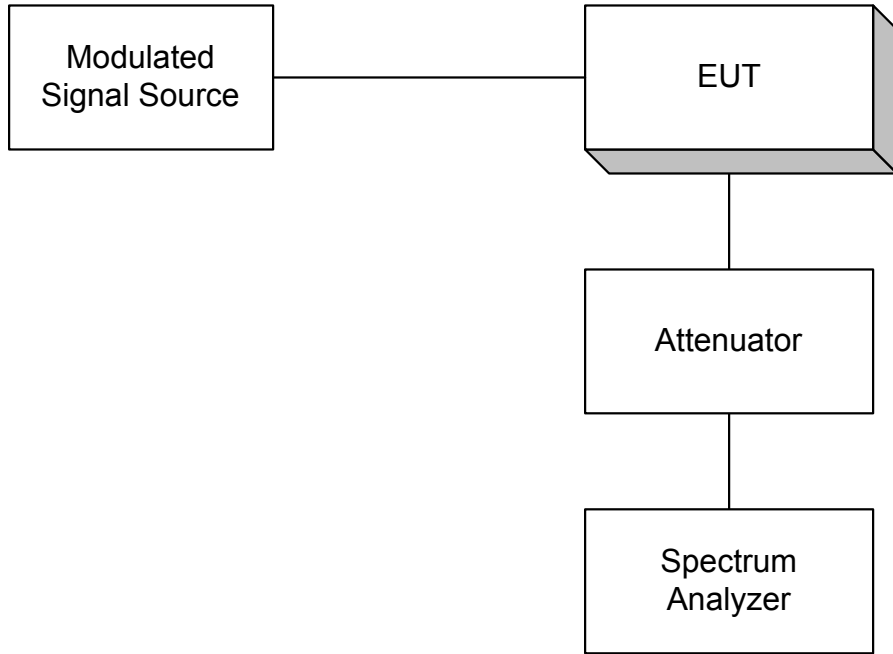

EQUIPMENT: DAB-1819-100

Para. No. 2.993 - Field Strength of Spurious Radiation

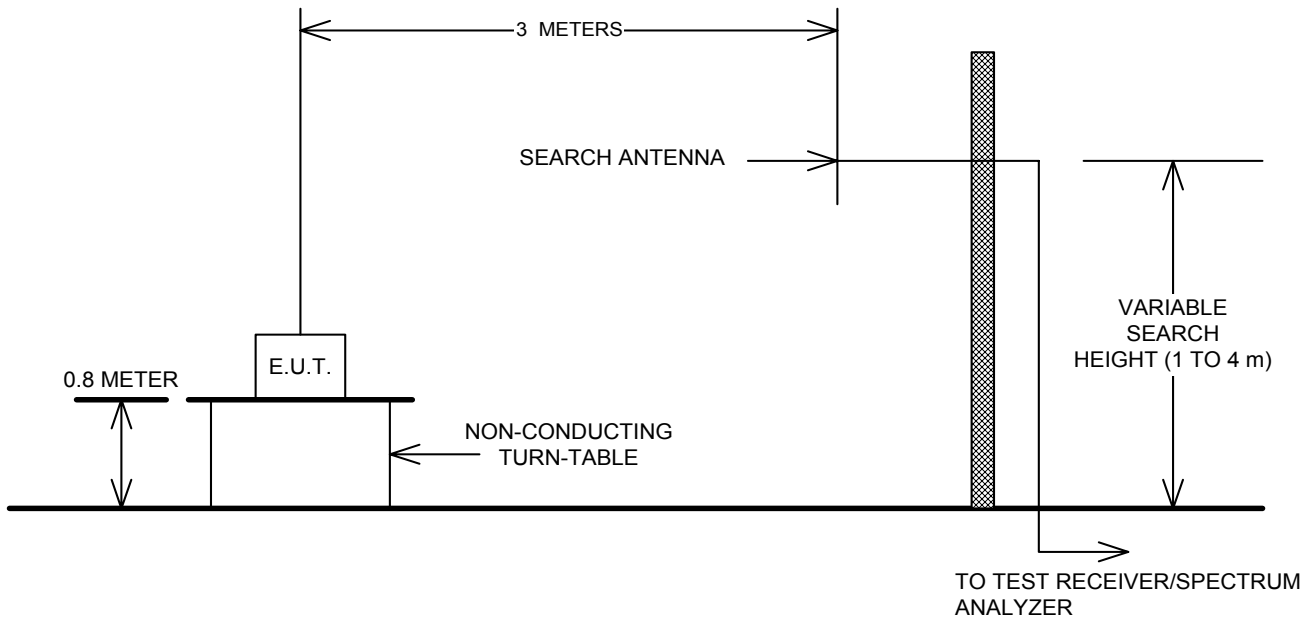

Para. No. 2.995 - Frequency Stability

