



WherePort III User Guide





Typographical Conventions



Warnings call attention to a procedure or practice that could result in personal injury if not correctly performed. Do not proceed until you fully understand and meet the required conditions.



Cautions call attention to an operation procedure or practice that could damage the product if not correctly performed. Do not proceed until understanding and meeting these required conditions.

Note

Notes provide information that can be helpful in understanding the operation of the product.



Document Revision History

Revision	Change Description	Date	Initials
A	Release per ECO C01013	2/23/06	G.Phillips
B	Updated per ECO C02336	12/07/10	D. Bowman



Contents

- WherePort III User Guide..... 1**
- 1 Regulatory Information6**
- 1.1 FCC and IC Requirements.....6
- 1.2 EU Compliance Information (WPT-3200).....6
- 1.3 Regulatory - Other.....7
- CMIIT ID: 2007DJ4325The WherePort 7**
- The WherePort8**
- 1.4 This Guide9
- 1.5 The WherePort.....9
- 1.6 Health Tag.....10
- 1.7 WherePort Mounting.....10
- 2 The WhereTag 12**
- 2.1 WhereTag Responses.....12
- 2.2 Using the WherePort ID15
- 3 Magnetic Communication Basics..... 16**
- 3.1 Magnetic Fields16
- 3.2 Coverage Areas.....18
- 3.3 Power Level20
- 3.4 Phases22
- 3.5 Sequencing.....23
- 3.6 Dual WherePorts24
- 3.7 Interference25
- 3.8 The Field Meter26
- 3.9 The WherePort LED26
- 3.10 Capture Area Simulator.....27
- 4 WherePort in the Field.....27**
- 4.1 Zones28
- 4.2 Area Coverage.....28
- 4.3 Portals.....28
- 4.4 Multi-Floor Installations.....31
- 4.5 Locked WherePorts31
- 4.6 Multiple WherePorts32
- 4.7 Sequenced WherePorts.....35
- 4.8 Summary.....36
- 5 Working through an Application38**
- 5.1 Warehouse and Shipping Facility.....38
- 5.2 Positioning the WherePorts40
- 6 Using the Simulator..... 42**



- 6.1 Simulator Controls and Features.....42**
- 6.2 WherePort Configuration43**
- 6.3 Sample Graphs.....46**
- 6.4 Adjacent WherePorts.....49**
- 7 Command Summary.....50**
- 7.1 Initial Power Up50**
- 7.2 Passwords50**
- 7.3 Command Execution51**
- 7.4 Tag Responses to Commands.....51**
- 7.5 Commands52**
 - 7.5.1 Message Length 52
 - 7.5.2 Power 52
 - 7.5.3 Phase 52
 - 7.5.4 WherePort ID 53
 - 7.5.5 Tag Id..... 53
 - 7.5.6 Response 53
 - 7.5.7 Count..... 54
 - 7.5.8 Interval 54
 - 7.5.9 Trigger..... 54
 - 7.5.10 Data..... 54
 - 7.5.11 EXE..... 55
 - 7.5.12 Sequence Mode..... 55
 - 7.5.13 Sequence Mode Message Number..... 55
 - 7.5.14 Version 56
 - 7.5.15 XPW 56
 - 7.5.16 HWT (1)..... 56
 - 7.5.17 Loader 56
 - 7.5.18 GQ..... 56
- 8 Installation.....60**
- 8.1 WherePort Parts60**
- 8.2 Also Required (not included)61**
- 8.3 Installation Procedure62**



1 REGULATORY INFORMATION

1.1 FCC and IC Requirements

This device complies with Part 15 rules. Operation is subject to the following two conditions:

1. This device may not cause harmful interference, and
2. This device must accept any interference received, including interference that may cause undesired operation. The user is cautioned that any changes or modifications not expressly approved by Zebra Enterprise Solutions could void the user's authority to operate the equipment.

See the FCC registration label, located on the bottom of the equipment for the FCC registration and identity.

Canadian DOC Compliance Statement

This device complies with Industry Canada licence-exempt RSS standard(s). Operation is subject to the following two conditions: (1) this device may not cause interference, and (2) this device must accept any interference, including interference that may cause undesired operation of the device.

Le présent appareil est conforme aux CNR d'Industrie Canada applicables aux appareils radio exempts de licence. L'exploitation est autorisée aux deux conditions suivantes : (1) l'appareil ne doit pas produire de brouillage, et (2) l'utilisateur de l'appareil doit accepter tout brouillage radioélectrique subi, même si le brouillage est susceptible d'en compromettre le fonctionnement.

1.2 EU Compliance Information (WPT-3200)

Table 1 EU Compliance - Approved for use in the following countries

AT	BE	BG	CY	CZ	DK	EE
FI	FR	DE	GR	HU	IE	IT
LV	LT	LU	MT	NL	PL	PT
RO	SK	SI	ES	SE	GB	
IS	LI	NO	CH			



1.3 Regulatory - Other



Complies With
iDA Standards
DA103846

TRA
REGISTERED No:
ER0039124/10
DEALER No:
0015939/08

CMIIT ID: 2007DJ4325



THE WHEREPORT

The WherePort III is a location indicator that is part of the Zebra Enterprise Solutions (ZES) Real Time Locating System (Figure 1). The WherePort transmits a localized magnetic field. Since the field is confined (programmable from approximately 3 feet to 25 feet) it is a reliable indicator of the location of key sites in the facility. When WhereTags pass through the WherePort field they transmit the ID of the WherePort. The WhereTag response can be programmed to indicate needed information about the status of the asset or object to which the tag is attached.

WherePorts are mounted to fixed locations such as gates, loading docks, or cells along an assembly line so that information required about the movement of assets through the facility will be gathered by the RTLS. As tagged assets pass through the fields the tag transmits the WherePort ID that pinged it and any other programmed status information.

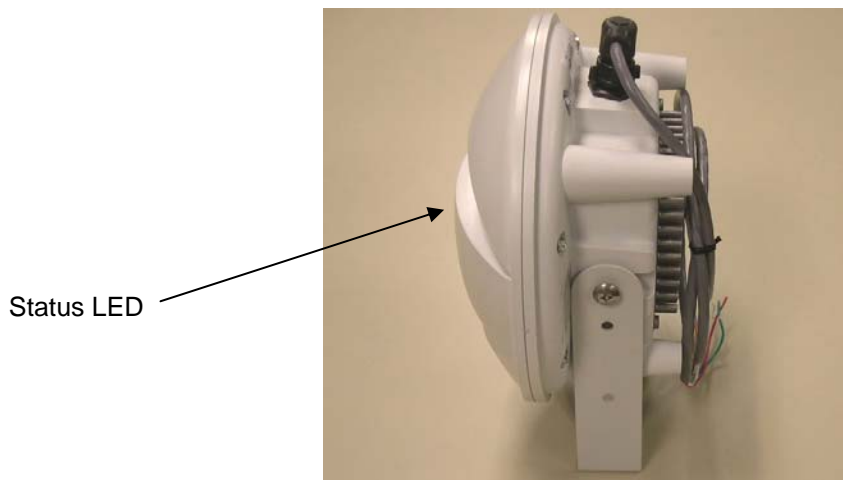

Figure 1 WherePort

The VSS system is programmed with the location of each WherePort and their ID. When a WhereTag transmits a message that includes the ID of the WherePort field that it is in, the system knows where the WhereTag is. This is particularly important when locating transitions is important or where the layout of the site makes it difficult to have enough sensors to accurately locate the tag using RTLS.



1.4 This Guide

This guide presents the basic principles of WherePort communication and the major issues for placing them on a site. It is intended to support both the planning for and the implementation of an RTLS application using WherePorts.

It describes the WherePort, the WhereTag and its responses, the characteristics of the magnetic field, and how the WherePort is used in a variety of applications. For more detailed information about the WhereTag see the WhereTag Users Guide.

Also included is a description of the simulator program and how it is used to determine effective WherePort site placement and configuration.

1.5 The WherePort

The WherePort is a round, dome shaped device, (9 inches in diameter and 5.25 inches high). It is powered by either 24 VAC or 36 VDC. A mobile version is available that uses only DC power (12-36 VDC; 1.5A). The complete specifications are shown in [Table 2](#). The wiring schematic is shown in [Figure 2](#).

The WherePort is configured using commands sent through the RS-232 interface. These commands are described in Appendix B.

Table 2 WherePort Specifications

Size	9.0 x 5.25 in. (229 x 133 mm)
Weight	2.3 lbs (1.0 Kg)
Voltage	24 VAC or 36 VDC Voltage (standard) 12-36VDC (AC Voltage is not allowed) (mobile)
Current	250 mAmp max (standard) 1.67A Max. (mobile)
PwrDiss	4.2 Watts (max)
Operating Temperature	-40 to +55 °C
Storage Temperature	-40 to +70 °C
Humidity	0 to 100% Non-condensing
AC/DC Power Connection	2 wires (black and white) For mobile versions, positive input is connected to white wire and negative input is connected to black wire.
Phase Synchronization	2 wires from previous WherePort (green/orange) 2 wires to following WherePort (red/blue)
Configuration Interface	12 pin round, weather tight connector (provided by Zebra Enterprise Solutions) with custom cable (com port)

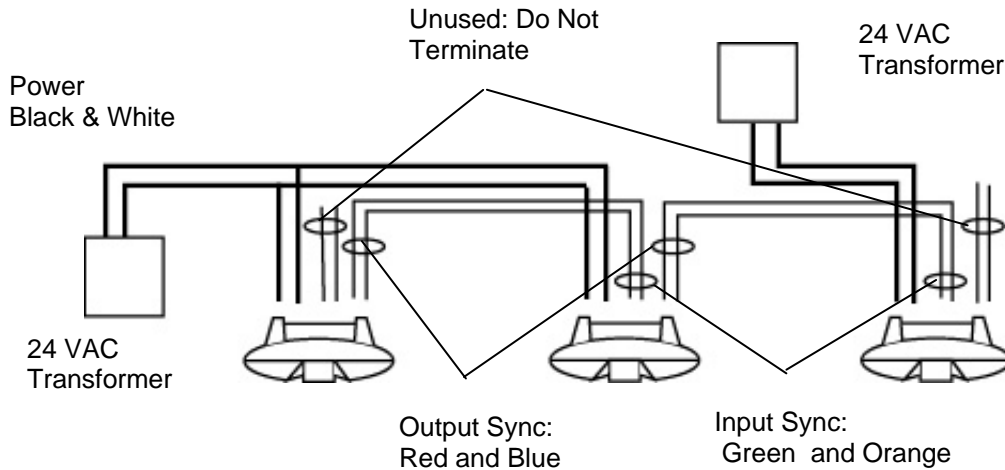

Figure 2 Wiring Schematic for Power and Synchronization
Each 24 VAC transformer supports no more than two WherePorts.

1.6 Health Tag

A WhereTag that is programmed to blink when there is no signal from the WherePort may be mounted to each WherePort. This optional tag is called a health tag because a signal from this tag indicates that there is something wrong with the WherePort that has caused it to stop signaling.

1.7 WherePort Mounting

The WherePort is mounted using a bracket (Figure 3). It can be mounted from the back, the top, or the bottom. For details on installing the WherePort see the *Installation Instructions*. A ruggedized mounting bracket is also available (Figure 4).

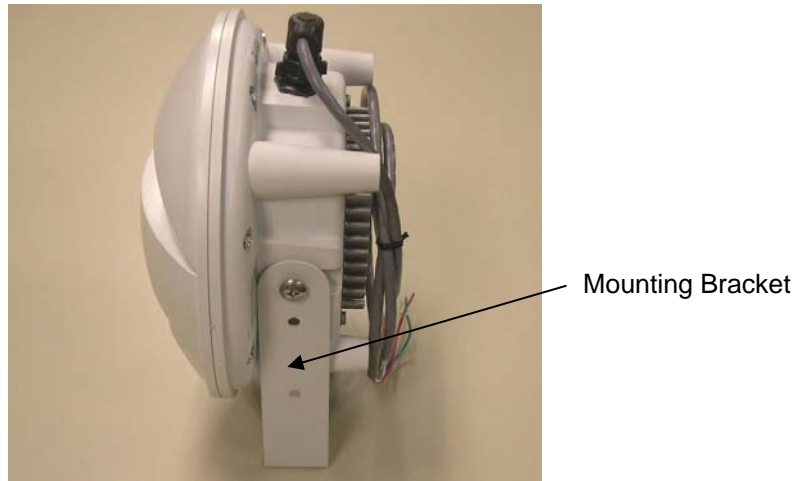

Figure 3 WherePort Mounting Bracket

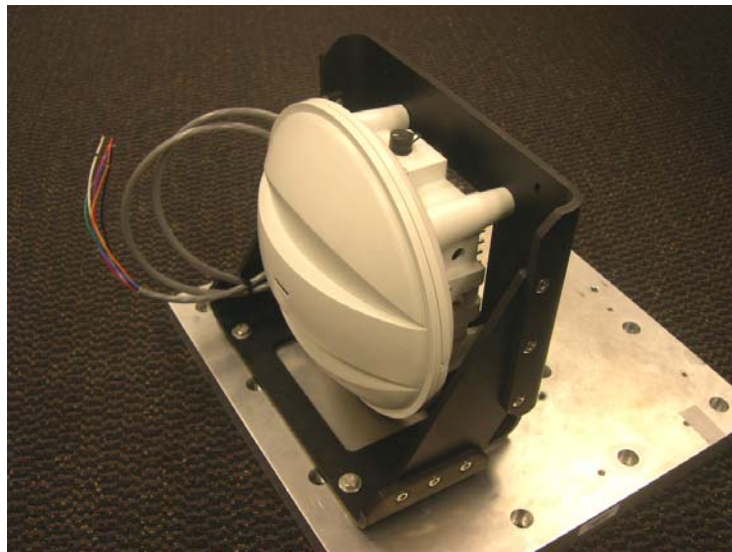

Figure 4 Ruggedized Mounting Bracket



2 THE WHERETAG

The WhereTag (Figure 5) is pinged by the WherePort and responds by transmitting a data message to the RTLS. The WhereTag is a small device with a magnetic pick up coil and a RF transmitter. It is mounted to movable assets such as trailers, vehicle assemblies, or storage bins. It transmits a programmable blink signal. When operating without the WherePort, the blink is received by at least three sensors which enable the system to locate the tag accurately on the site.

The WherePort signal is received by a pick up coil in the WhereTag. In the WhereTag III the coil is oriented along the length of the tag. In WhereTag II it is rotated 30° away from the length of the tag.



Figure 5 The WhereTag III and WhereTag III ST
The solid line shows the orientation of the pick up coil for both WhereTags.

2.1 WhereTag Responses

The tag can be programmed to respond in a variety ways when it detects a WherePort signal. There are three defined modes (see Figure 6).

- Mode 1** The tag enters the field, blinks and then blinks again if it is still in the field after the retrigger time out.
- Mode 2** The tag enter the field, blinks and then does not blink again until it leaves the field and the retrigger time out expires.
- Mode 3** The tag enters the field, blinks and then blinks again after it has left the field and the retrigger time out expires.

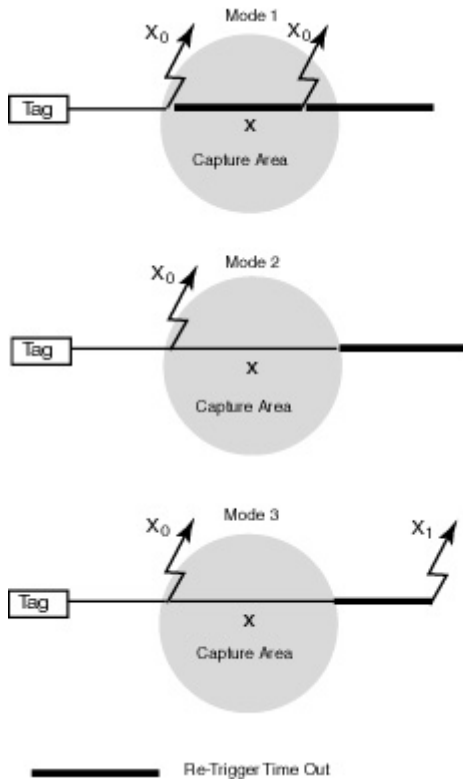

Figure 6 The WhereTag in a WherePort Capture Area

In mode 1, the re-trigger is set for a time interval after the WherePort blink. When this interval elapses, the tag will transmit a blink if the tag is still in the same WherePort field. Without the re-trigger interval being set, the tag will continue blinking in response to the WherePort signal.

If the tag enters a new field, it will transmit a blink, even if the set interval has not elapsed (see Figure 2).

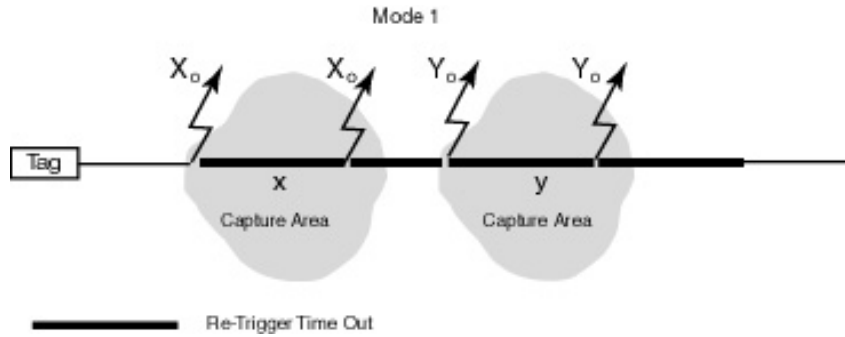

Figure 7 Retrigger Mode 1 and a New Capture Area

In mode 2 the tag must both leave the WherePort field and the specified interval elapse before a WherePort blink will occur. If the tag enters a new WherePort field it will immediately transmit a blink (Figure 2).

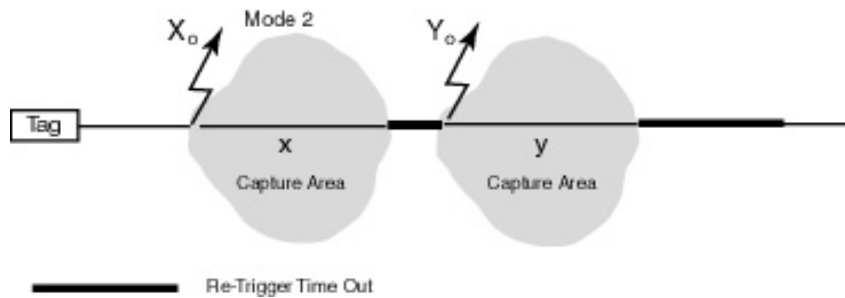

Figure 8 Retrigger Mode 2 and a New Capture Area

In mode 3, the set interval must elapse and the tag leave the field, and then the tag will transmit a blink to indicate that it has left the field. If the tag enters a new field, the tag transmits a blink when it enters the field. If the re-trigger time out is reached before a new field is entered a blink is transmitted which indicates the tag is out of the field.

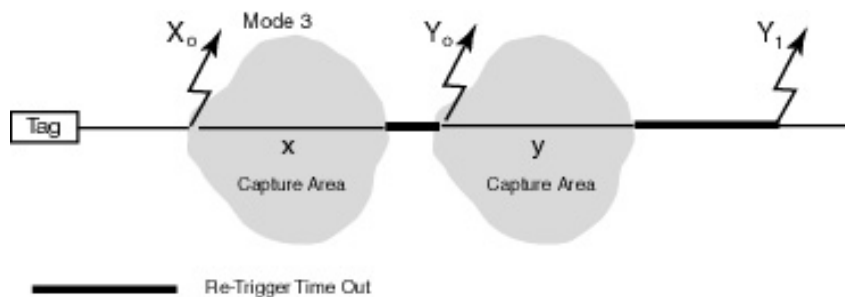

Figure 9 Retrigger Mode 3 and a New Capture Area



2.2 Using the WherePort ID

The tag response can also be changed by the WherePort. Ports with ids from 0 to 255 are used only when the alternate blink mode is required. These reserved ids are split evenly between IDs (128 – 255) to mark the entrance of tag into the field and ids (0 - 127) to mark the exit of a tag from the field. The significance of other tag IDs is shown in [Table 3](#).

WherePorts can turn tags on and off as they enter and leave a site. As an example, WhereTags can be permanently mounted to trailers. These trailers need to be tracked while they are on the site, but not after they leave. There is no need for the tag to continue to blink while it is off site. WherePorts positioned at entry and exit gates can turn the tags on when the trailers enter the yard, and off when they leave.

Table 3 WherePort IDs

ID Range	Tag Response	
	Standard WP Response	Added Function
0 - 127	Yes	Exit Alternate Blink Mode
128 - 255	Yes	Enter Alternate Blink Mode
256 - 32,767	Yes	
32,768 - 65,534	Yes (ID - 32,768 reported)	
65,535	Yes +	Response is data register



3 MAGNETIC COMMUNICATION BASICS

The WherePort signal is carried by a magnetic field. The field’s shape and size is determined by the orientation of the coil and the power level. It is not possible to aim the field. One of the characteristics of a magnetic field is that it drops off rapidly. This produces a well-defined, localized field. These characteristics make the WherePort an excellent device for monitoring tagged assets

3.1 Magnetic Fields

The magnetic field of the WherePort extends nearly equally in all directions creating an elliptical field (Figure 10). The field has a direction that is determined by the position of the coil that creates it.

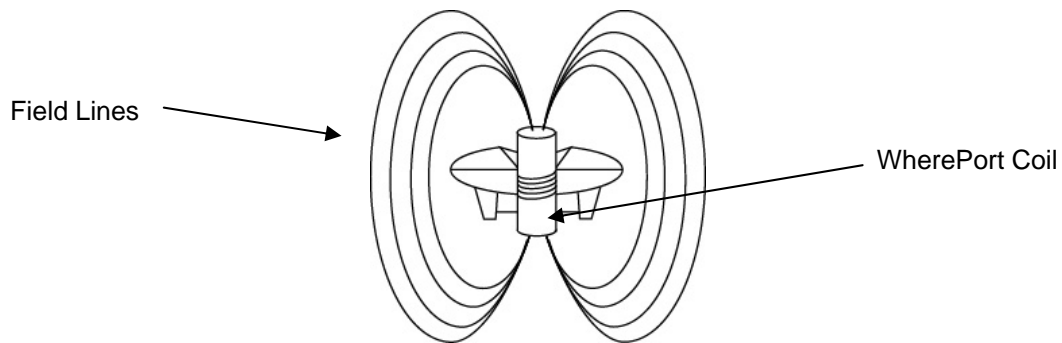

Figure 10 WherePort Field

The field extends in all directions around the WherePort. The direction of the field is suggested by the way the field lines are drawn from the coil.

The field is detected and the signal received by a coil in the WhereTag. The orientation of the WherePort’s coil in relation to the orientation of the tag’s coil affects its ability to detect the signal. The optimum orientation is when the WherePort coil and the WhereTag coil are parallel to each other. The worst orientation is when the coils are perpendicular to each other. As the coils move from optimum to worst the ability of the Tag to detect the WherePort signal decreases (Figure 11).

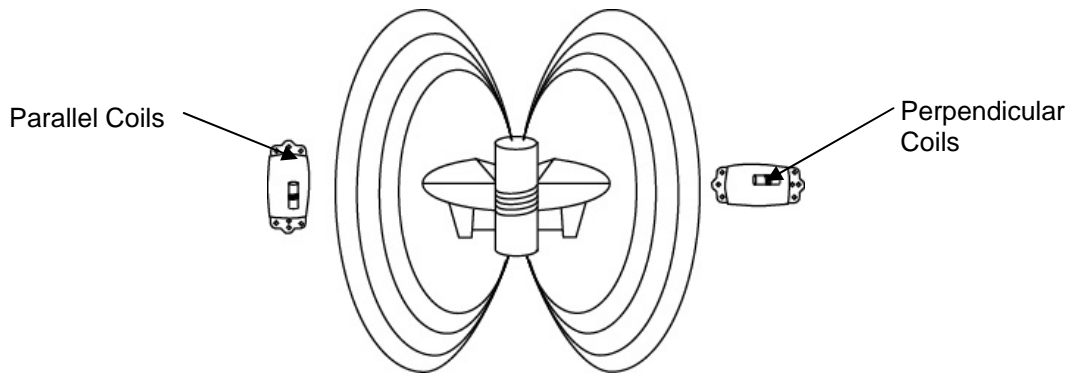

Figure 11 Orientation

When the coil in the tag and the port are parallel the range is the greatest. When the coils are perpendicular the range is the shortest.

The relative positions of the two coils, WherePort transmitting and WhereTag receiving, determine the range in which the tag will receive the signal. This range is the coverage area, or guaranteed capture area (Figure 12). The guaranteed capture area is different for each orientation of the tag and the power level of the WherePort.

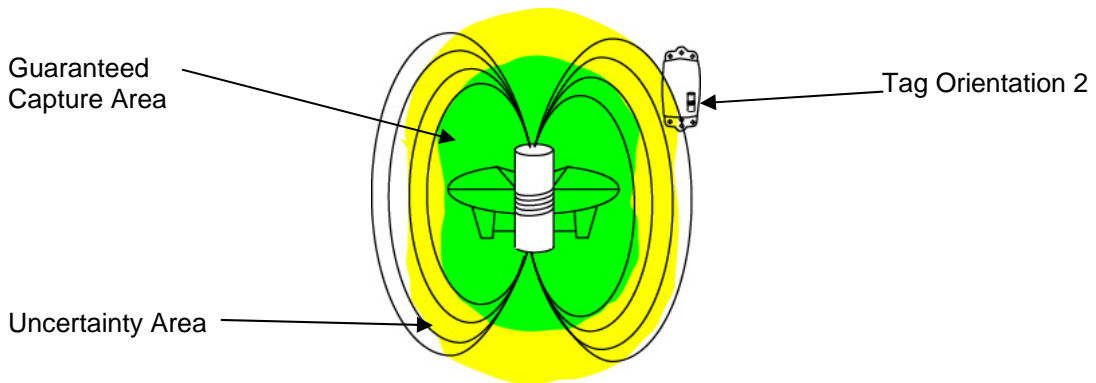

Figure 12 Capture Area

The capture area is shown by the dark shaded area. This shape varies with the orientation of the tag and the power level of the WherePort. The lightly shaded area is the uncertainty area.



3.2 Coverage Areas

The size of the coverage area is significant as well as its location or placement. It is important that the tag be released from a field when it is no longer in the area being monitored by the WherePort.

There are three areas that are described for the field.

Guaranteed Capture	All WhereTags at a given orientation will always be pinged in this area.
Uncertainty	A WhereTag may or may not be pinged in this area.
Guaranteed Release	A WhereTag will never be pinged beyond this range.

Since a tag may or may not be pinged in the uncertainty area, this area presents the most challenge for a planner. If a single WherePort is installed, a tag that needs to be pinged may not be and a tag that needs to be released may not be. These coverage areas must be well understood to be able to set up a site. In the examples that follow these principles will be translated into real applications.

A WhereTag moving through a WherePort field will typically change its orientation with respect to the WherePort. As the orientation changes the effective range of the WherePort will change.

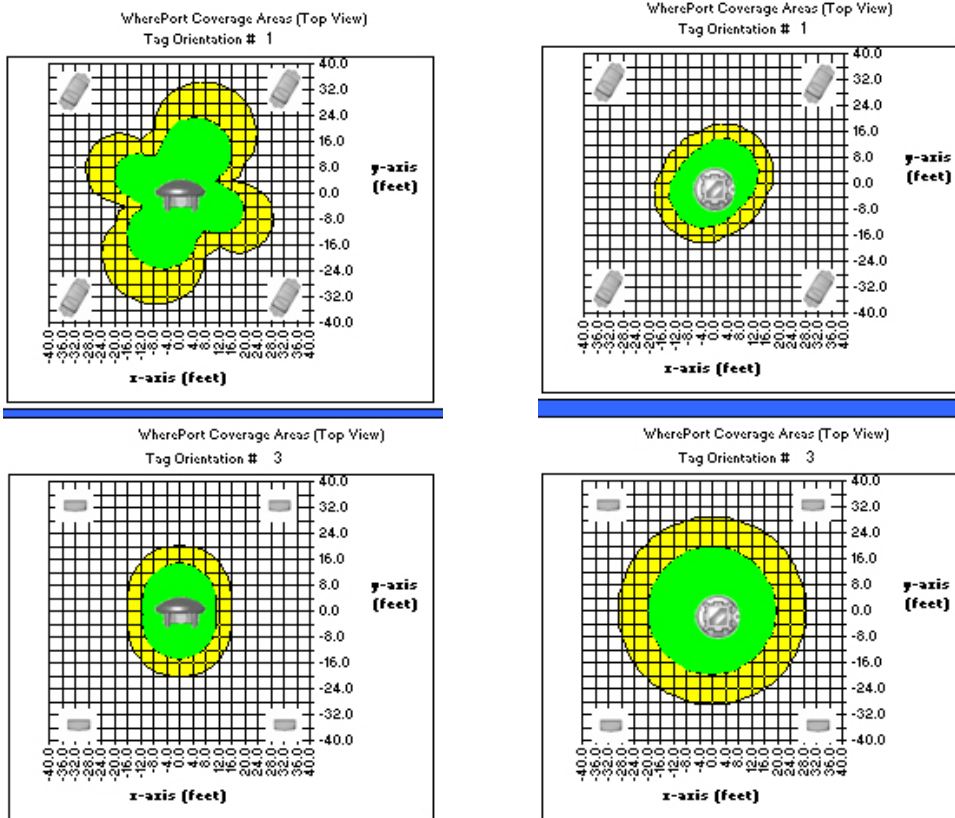

Figure 13 Orientation and Capture Area

Two maps are shown for two different WherePort mountings, horizontal (left) and vertical (right). The two maps show two different tag orientations for each of the mountings.

Figure 13 shows the effects of WherePort and Tag orientation on the guaranteed capture area. These maps are taken from the Simulation software.



3.3 Power Level

The size of the field is determined by the power setting for the WherePort. There are nine power levels for the WherePort III. Setting the power level to 0 turns off the WherePort magnetic field. Table 4 shows the approximate capture and release ranges for each of the power levels when the tag's orientation is random and when it is fixed as it moves through the field.

Table 4 Power Levels, Random and Optimum Fixed Tag Orientations

Power Level	Capture Range		Release Range	
	Random	Optimum Fixed	Random	Optimum Fixed
0	Off	Off	Off	Off
1	1.0	2.5	4.0	4.0
2	2.0	3.8	6.0	6.0
3	3.0	6	9.0	9.0
4	4.0	8	12.0	12.0
5	6.0	11	17.0	17.0
6	8.0	14	21.0	21.0
7	10.0	19	30.0	30.0
8	12.0	25	37.5	37.5

Random orientation means that the tag may take any of the possible positions relative to the WherePort. Fixed tag orientation means that the motion of the object to which the tag is attached will always present the tag in the same position relative to the WherePort. A major difference between the random and the fixed orientation is the size of the uncertainty area. It is significantly reduced when the tag has both a fixed and an optimum orientation in the field.

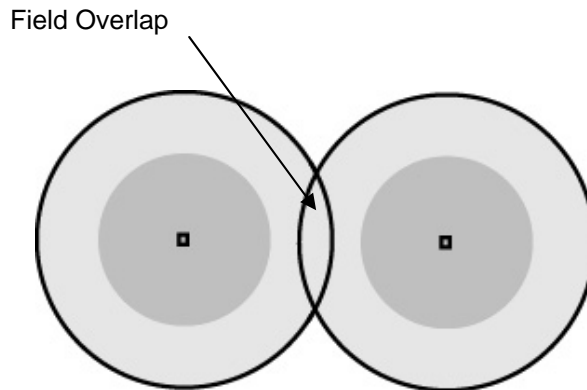

Figure 14 Overlapping Uncertainty Areas

Coverage Overlaps

When positioning WherePorts it is not always possible to prevent their fields from overlapping. Overlapping the uncertainty areas of two WherePorts does not produce a guaranteed capture area. It produces an area where a tag may be pinged by either one or the other WherePorts or none.

When the fields of two WherePorts must be overlapped to cover a large area (Figure 14) it is necessary to set the phases of the two WherePorts. Both WherePorts (or more if more fields are overlapping) must also have the same ID number. If the phases are not set, it may be impossible or difficult for a tag in the field to accurately report the ID of the WherePort for the field it is in.



3.4 Phases

When two or more WherePorts are used to cover a large area they must be phased to reduce the interference between the two fields. WherePorts mounted on the ceiling might be set to 0° and on a wall 90°. Figure 15 shows the correct phase settings for four orientations of the WherePort. The phases are set with reference to the orientation of the master WherePort.

A WherePort set to 0° phase is defined as the master and all the other WherePorts are then connected to it using the phase wire connections. Phased WherePorts must all have the same ID.

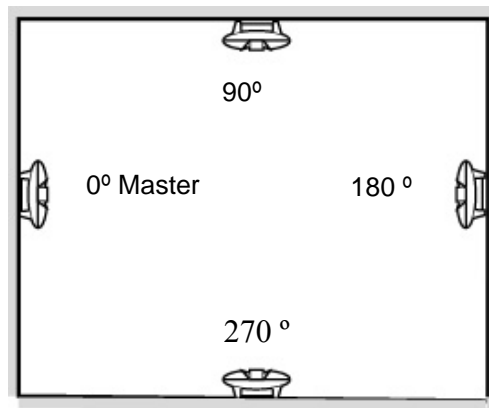

Figure 15 Phase and WherePort Orientation



3.5 Sequencing

WherePorts that have been connected electronically can also operate in the sequence mode. Sequenced WherePorts do not transmit at the same time. The first WherePort sends its message and then shuts off its field while the next WherePort in the sequence sends its message. The number of times each WherePort sends its message is set using the CMCn command. The number of WherePorts in the chain is set using the CMWn command. See [Figure 16](#) through [Figure 18](#).

The master WherePort LED in a group of sequenced WherePorts is green when active. The slave WherePort LEDs are yellow when they are active. The LEDs are all off when the WherePorts are not active.

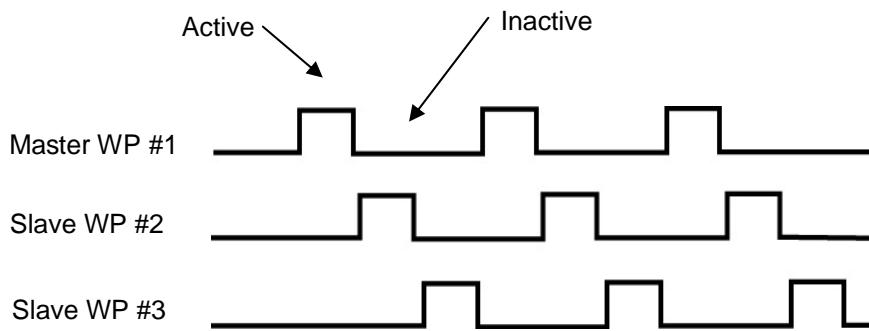

Figure 16 Mode 1

One WherePort is active at a time. A master and two slaves are shown. WhereWand WPSeq Count (or RS232 CMWn) = 2.

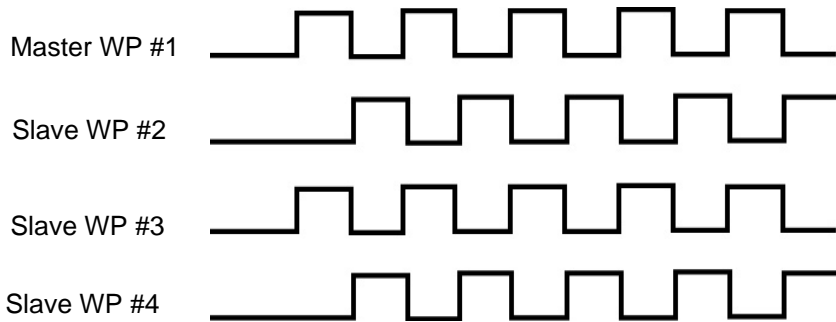

Figure 17 Mode 2

More than one WherePort may be active at a time. A master and three slaves are shown. One and three are active while 2 and 4 are inactive. WhereWand WPSeq Count (or RS232 CMWn) = 1.

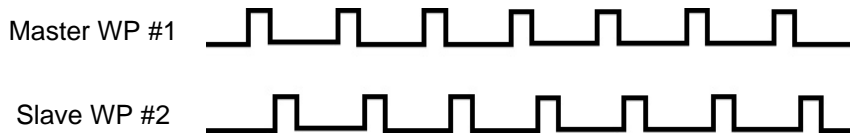

Figure 18 Mode 3

All WherePorts may be off part of the time. A master and one slave are shown. One is active, then two, then both are inactive. WhereWand WPSeq Count (or RS232 CMWn) = 2 or higher.

With sequencing, WherePorts that might have conflicting fields if they were on at the same time, can be placed to indicate position or transitions. An example is narrow parking lanes in a warehouse facility.

3.6 Dual WherePorts

The dual WherePort is a bracket with two WherePorts mounted to it, oriented 90° from each other (Figure 19). They ensure a guaranteed capture range and eliminate the need for multiple mounting sites. Typically the dual WherePort is used when the orientation of the tag can not be fixed. They also simplify placement in locations that are larger than the guaranteed capture range of a single WherePort (see Figure 20). Dual WherePorts are always phased with one set as the master at 0° and the other at 90°.



Figure 19 Dual Where Port

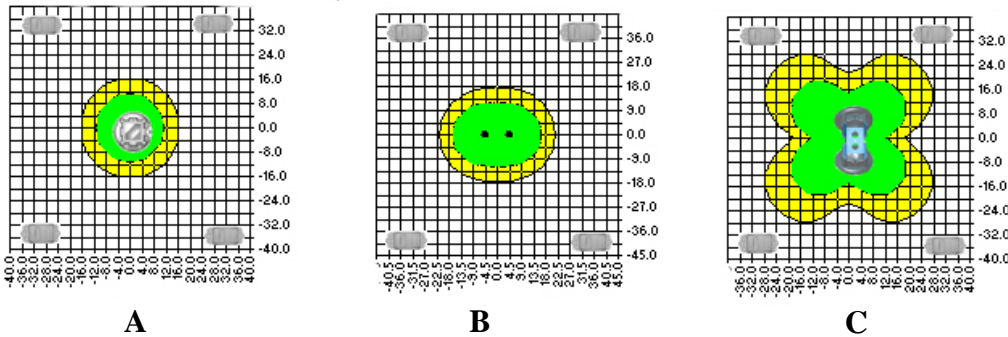

Figure 20 Coverage Pattern

A single (A), adjacent (B), and dual WherePort (C) field are shown. The fields shown are for WherePorts at power level 8 and mounted at the same height as the WhereTag.

3.7 Interference

Steel objects and some devices can interfere with the WherePort field and change its shape and range.

Some kinds of structures will affect the range of the WherePort. Mounting the WherePort on the broad face of a steel I-beam reduces the coverage on the front and back of the WherePort.

The field can also be extended or ducted by steel in windows, metal studs, conduit, or duct work. This is most likely to occur when the WherePort is within one to two feet of the steel and the tag is also close to the steel. This could lead to an unwanted increase in the size of the field.

Magnetic interference can block communication between the WherePort and the tag. The most common sources of magnetic interference are CRT monitors, electric motors, vehicle RFID anti-theft ignition systems, and other WherePorts. A WherePort may not ping a tag that is within one to two feet of an operational monitor or industrial motor. The field strength meter can be used to check for interference.



Figure 21 Magnetic Field Meter

3.8 The Field Meter

The field meter is a WhereTag connected to a voltage meter so that it can detect and display the strength of the WherePort field (Figure 21). By walking around an installed WherePort the strength of the signal throughout the area to be monitored can be measured. The tag can be positioned to match its mounting position on the tracked asset. Experimenting with the field meter can help to clarify the coverage area of the WherePort.

After the installation of WherePorts at a facility, the field meter is used to test that the field coverage is as it was planned to be. If gaps or problems with the coverage are found they can be corrected before the facility is put into operation. See the *Magnetic Field Meter User's Guide (P/N D0755)*.

3.9 The WherePort LED

On the top of the WherePort is an LED that indicates the status of the WherePort (see Table 5).

Table 5 LED Status Indicator

Condition	WherePorts	LED Status
Power up reset	All	Red
Power = 0	All	Red
Phased	Master	Green
Phased	Slave	Yellow
Sequenced	Master, field on	Green



Sequenced	Master, field off	No color
Sequenced	Slave, field on	Yellow
Sequenced	Slave, field off	No color

3.10 Capture Area Simulator

The capture area simulator calculates and maps the capture area for several different WherePort and WhereTag orientations. The simulator is described in Chapter 6.

4 WHEREPORT IN THE FIELD

The basic principles of the WherePort must be translated into applications in the field. Doors, corridors, rooms, parking lots do not necessarily conform to the requirements of the WherePort field. In this chapter several common situations are discussed in order to illustrate how the characteristics of the WherePort affect their positioning on a site.

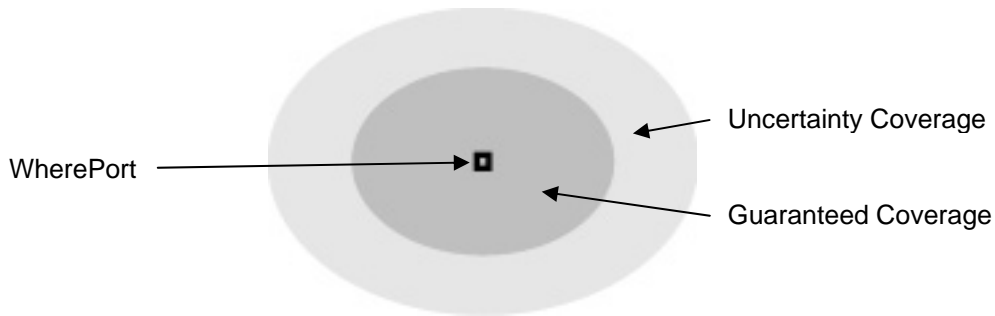

Figure 22 WherePort Coverage

In the applications that follow the WherePort field will be illustrated as shown in [Figure 22](#). The illustration shows only two dimensions of what is always a three dimensional field. The field can be imagined as a series of waves that are further apart as they move out from the coil. The overall shape is like an ellipsoid, an egg shaped object, extending out in all directions from the WherePort.

In the examples that follow, the WherePort field is described. It must be remembered that the capture area is what is important. The field is shown to simplify the presentation.



4.1 Zones

In some applications it is not necessary to be able to determine the precise position of an asset. All that is needed is to know when the asset is in one or more key zones of the facility. Fewer antennas are required to define zones.

While accuracy may not be essential, reliability will be. By placing one or more WherePorts in a zone, the system can reliably determine that a tag asset has entered and is still in a zone.

4.2 Area Coverage

There may, however, be many areas where different activities occur that must be monitored. Well positioned WherePorts can define these areas of interest by pinging tagged assets as they enter them. Examples are assembly stations in a factory, loading docks, or different types of rooms in a hospital. One or more WherePorts mounted at the station will ping a tag whenever the tag enters the area. If more than one port is placed in a large area, they must all have the same ID.

The WherePort can be particularly important if the structure of the facility obstructs the line of sight visibility to location sensors or location antennas. The garages in a repair facility may have metal walls. Multiple sensors, likely four, would need to be mounted around the bay to guarantee a signal that locates a vehicle in the bay.

When more areas are to be monitored, more issues must be considered in planning the location of the WherePorts.

- What will the orientation of the tag be as it moves through the area?
- Will tags be pinged while they are moving past but not through the area?
- Are there sources of interference that may restrict the capture area?
- Will WherePorts be close enough to each other that their fields may overlap?

4.3 Portals

An additional complexity may arise if the best way to monitor assets is to detect when an asset enters or leaves the area through a door, gate, or similar portal. WherePorts mounted at the portals of these areas will ping a tag, indicating that the tagged asset has passed through and is not in the area.

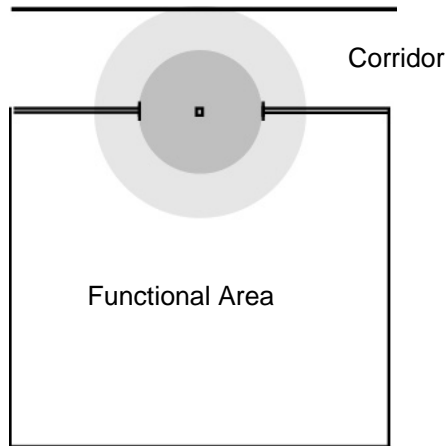

Figure 23 WherePort in a Doorway

To enter the room, an object must pass through the guaranteed capture range of the WherePort.

The placement of a WherePort in the doorway might seem simple. [Figure 23](#) shows this installation. Any tagged asset passing through the doorway must pass through the guaranteed capture range. However, an object passing down the corridor would also be pinged by the WherePort. If the WherePort is mounted to the top of the doorway, it might be below a space on the floor above that is part of the application as well. The WherePort field might extend far enough into the second floor to ping a WhereTag moving through a completely separate part of the facility.

The WherePort may need to be mounted inside the room to prevent pinging traffic along the corridor. Its power level may need to be reduced so that the range does not extend beyond the actual portal. The placement of the tag on the asset may need to be adjusted, perhaps by placing it closer to top of a vehicle, so that only the portal WherePort will ping it.

When an area is monitored using portals, all portals must be covered. If a path into the area is not covered by a WherePort, tagged assets may enter or leave through the uncovered path.

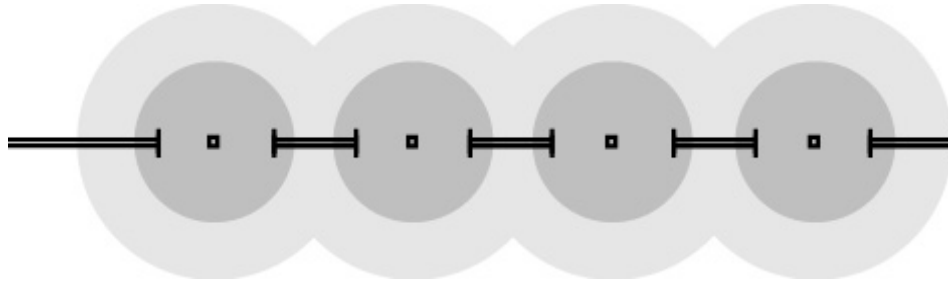

Figure 24 Loading Dock Doors

Spacing of loading dock doors makes it impossible to assign unique WherePort IDs to each of the doors.

If, instead of a single door, a series of doors (for example on a loading dock) or bays are too close together, the fields may overlap so that it is not possible to assign a unique WherePort ID to each of the doors. Even if the doors are far enough apart so that the fields do not overlap, the fields may cover so much of the adjacent area that false pings are created by tags that are passing by and not arriving at the doors (see [Figure 24](#)).

Some of these issues might be solved by sequencing the WherePorts, which will be covered later in this chapter.

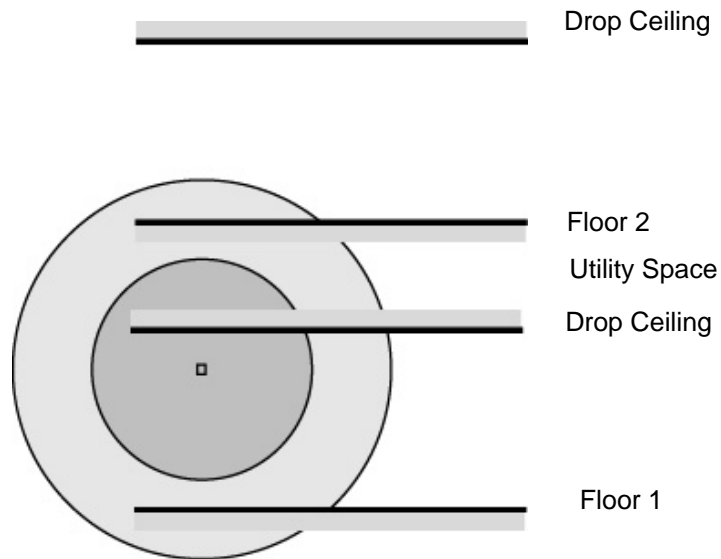

Figure 25 Multi-Floor Schematic

Shows a floor configuration so that the WherePort field extends into the second floor.

4.4 Multi-Floor Installations

When activities are tracked on several floors, the vertical position of the WherePort and the extent of its field must be carefully considered. If the field extends into the floor above, a tag moving on the upper floor may be activated by the WherePort on the lower floor. This will produce an incorrect location for the tag.

The height of the floor together with the utility space between floors must be considered so that the WherePort is mounted at a height that prevents tags on the floor above from being activated (Figure 25).

The WherePort power setting can be set so that the range is reduced. The tags may also be mounted lower on the asset to permit lower placement of the WherePort.

4.5 Locked WherePorts

There may be areas on a site where once a tagged asset has entered it should not be located using RTLS. Movement along an assembly line may be more accurately tracked using only the WherePort signals. Where room coverage is needed the RTLS algorithm could indicate that a tag is outside a room when it is not.



WherePorts are defined as locked using the software of the SystemBuilder. No setting in the WherePort is needed. After a tag pings that it has detected a locked WherePort the tag will be ignored until it is unlocked. It is unlocked by detecting an unlocked WherePort.

Tag movement must be clearly understood to make sure that a tag that enters a locked WherePort field will also enter an unlocked WherePort field. If a tag is inadvertently locked by a WherePort it will be ignored by the system until it enters the field of an unlocked WherePort.

Typically locked WherePorts are used to track tags into a relatively small and confined space. While tags are in this space they will be ignored. Upon leaving the space they will pass an unlocked WherePort and from then on be tracked normally.

4.6 Multiple WherePorts

Some locations require more than one WherePort to insure adequate coverage. Examples include a large parking lot, a long corridor, a large number of loading dock doors, or a large doorway.

If a space is large enough, separate WherePorts with separate IDs may be used. Problems arise with areas that must be monitored uniquely that are larger than the coverage area of single WherePort. In this case the possible mounting options must be considered.

The placement of WherePorts with overlapping coverage requires attention to a number of issues. The first is phasing. Whenever the coverage fields of two or more WherePorts overlap, the phases of the WherePorts must be set. When WherePorts are phased, one is always designated as the master with its phase set to 0 (see [Figure 26](#)) and all phased WherePorts must be set to the same ID.

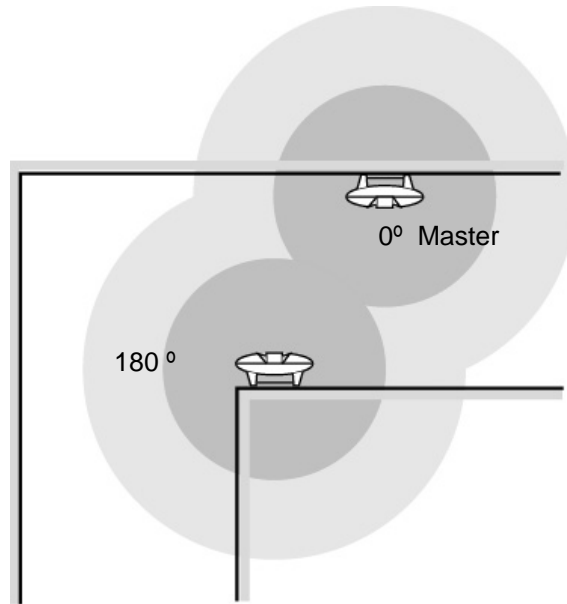

Figure 26 Phasing for Wall Mounted WherePorts
Viewed from the top.

Figure 26 shows a corridor or large space with WherePorts mounted on the different walls to effectively cover the entire area. This means that the phase of each WherePort must be set as indicated.

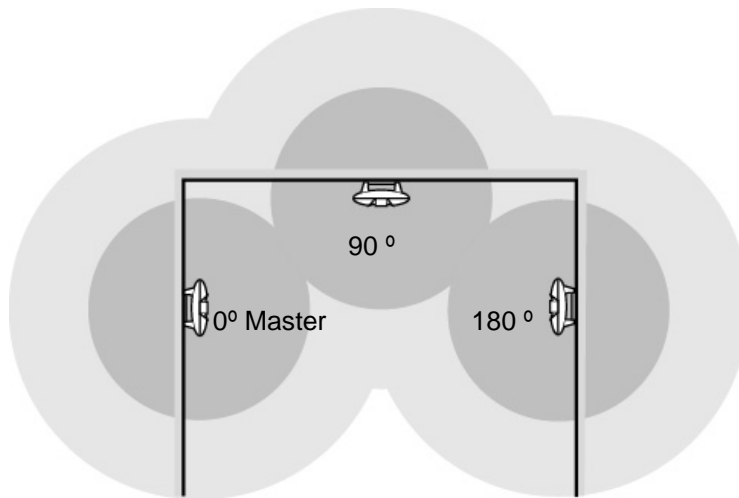

Figure 27 Phasing for Ceiling and Wall WherePorts



A large doorway may require three WherePorts to reliably detect the passage of a tagged asset through it. In the example shown in [Figure 27](#) coverage requires a WherePort on each side of the doorway and on the ceiling. Again each WherePort must be phased accordingly.

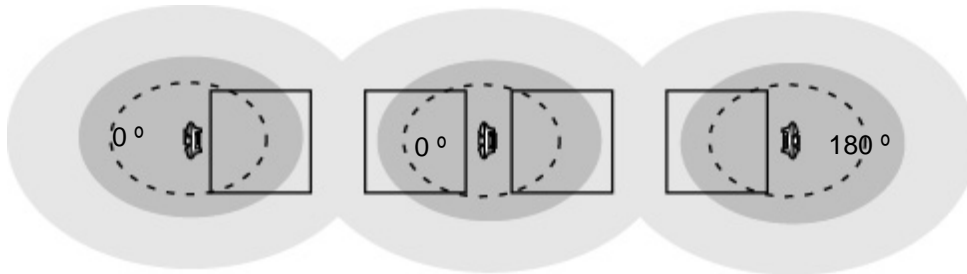

Figure 28 Loading Dock Door Options
Viewed from the side.

Loading dock doors are frequently too close together for each of them to be monitored by a different WherePort. If unique identification of passage through a given door is required, a more complex solution will be required.

[Figure 28](#) and [Figure 29](#) show two ways of solving the problem. The example in [Figure 28](#) uses a WherePort to cover two doors. Since these WherePorts are mounted in different orientation on the walls, their phases must be set as well. [Figure 29](#) shows a WherePort mounted above each door. The phases for these ports can all be set to 0 but they must still be phased together with one of the ports identified as the master.

The orientation of the tags will also affect the location of the WherePorts. If the tag orientation is horizontal, then the top solution is best so that the WherePort field will be maximized. If the tags are oriented vertically, then the lower solution, with the WherePorts mounted over the doors, will be best.

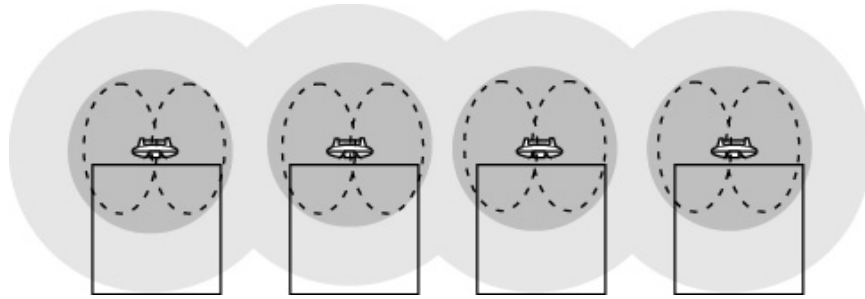

Figure 29 Over the Door WherePort Mounting

The dotted line ellipse shows the approximate shape of the coverage area if the tag is oriented horizontally rather than vertically.

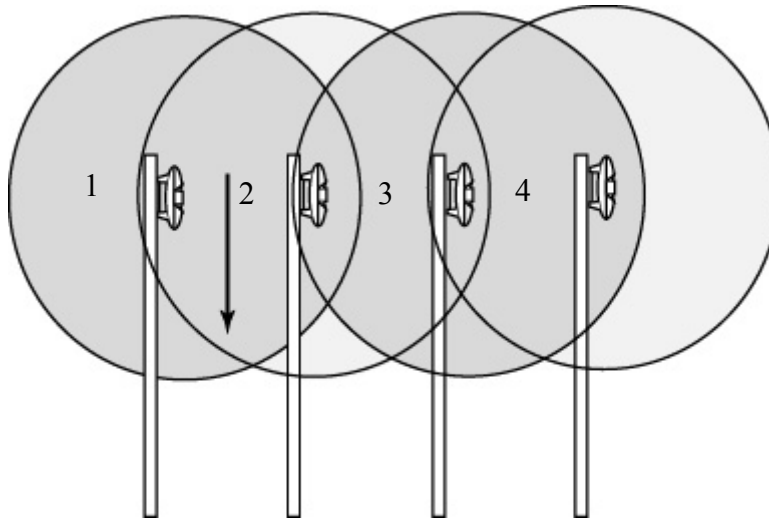

Figure 30 Sequenced WherePorts on Parking Lanes

4.7 Sequenced WherePorts

Figure 30 shows the use of sequenced WherePorts to accurately identify which lane a vehicle has entered. Sequenced WherePorts are turned on and off. WherePorts 1 and 3 are on while 2 and 4 are off and then 2 and 4 are on while 1 and 3 are off. If a tag is pinged by 1 and 2 it is in lane 1. If it is pinged by 3 and 2 it is in lane 2.



4.8 Summary

Each application will present a unique combination of the principles demonstrated by the examples in this chapter and thus require different configurations to create a successful application. In the next chapter, guidelines for planning and designing an application will be discussed.



5 WORKING THROUGH AN APPLICATION

To effectively place WherePorts the site and the required information from the site must be carefully studied. In this chapter a simple site will be presented and issues about WherePort placement will be discussed and mounting locations for WherePorts found.

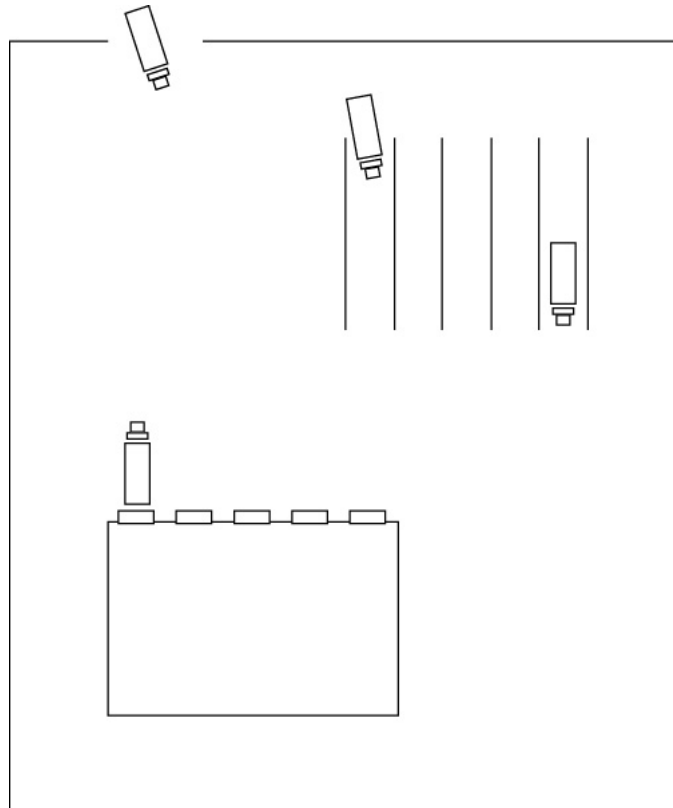

Figure 31 The Warehouse Site

5.1 Warehouse and Shipping Facility

Events or positions that need to be monitored in some way.

What must be tracked.

- Trailers entering the yard
- Trailers at the loading dock
- Trailers in the waiting, parking area
- Trailers leaving the yard



Issues affecting the placement of the WherePort.

Are there any obstacles or structures that will affect the field?

Where will the WhereTags be mounted?

Will their orientation be controlled while they are in a WherePort field?

The first and most important step in creating a successful WherePort application is to define what information must be obtained from the WherePort. Is the passage of an asset past a particular point important?

How does the use of WherePorts fit with the RTLS? Is it impossible to mount enough sensors or do physical barriers make it impossible to get reliable location signals? Is the RTLS unable to accurately track when an asset has reached a precise location? Both aspects of the installation must be considered to make sure that the most accurate and reliable information that is critical to operation is obtained.

Within a large area covered by RTLS more precise information about the location of an asset may be needed. This can be done by installing a WherePort at this location.

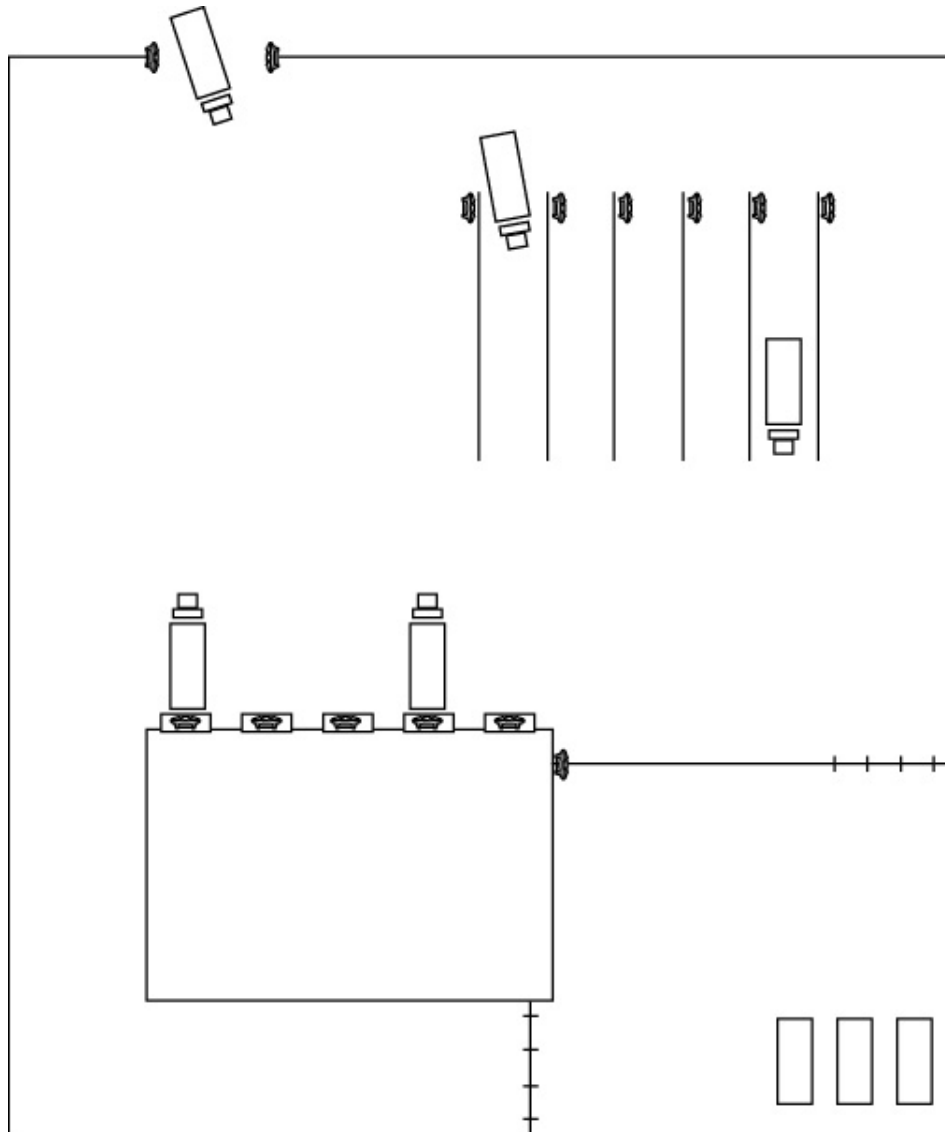

Figure 32 WherePorts Mounted on the Site

5.2 Positioning the WherePorts

What will the tags be mounted to and how will the objects move? Will the tag maintain its orientation as it moves through the site or will it move? Will it move only in the horizontal dimension or will it be set up on end and changed vertically as it moves? Will the tag be mounted close to the floor or some distance above it? How much flexibility will there be in the mounting of the tag? The orientation of the tag with respect to the WherePort is one of the most important determinants of the coverage field.

What kinds of interference are on the site?



identifying where on the site this information must be gathered, and determining
Creating a map of the site.

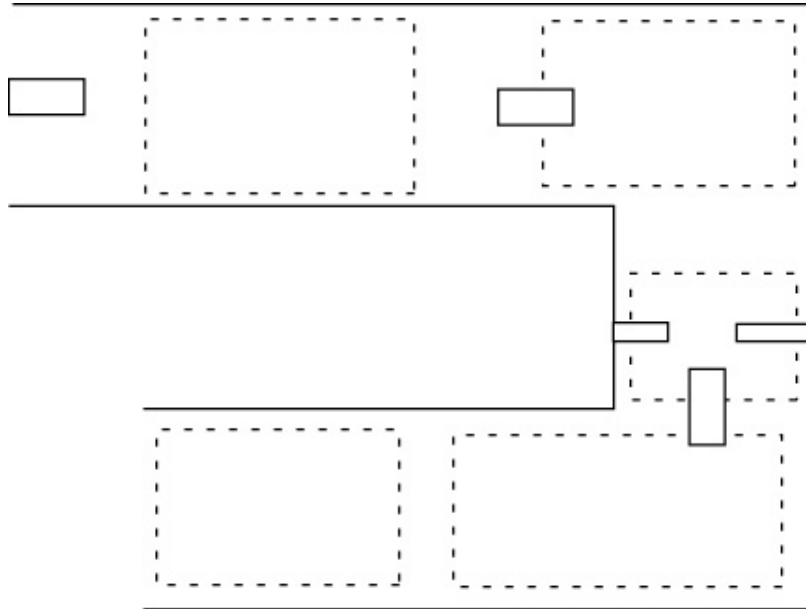



6 USING THE SIMULATOR

The WherePort simulator (ZES p/n D0910) is a tool for exploring the best solutions for WherePort placement and for better understanding the basic characteristics of WherePort communication.

Because of the number of variables that affect the response of the tag to the WherePort field, it is helpful to examine the response using the simulator. The number and placement of WherePorts, the orientation of the tag while it is in the field, and the distance of the WherePort from the tag all interact to determine this response.

6.1 Simulator Controls and Features

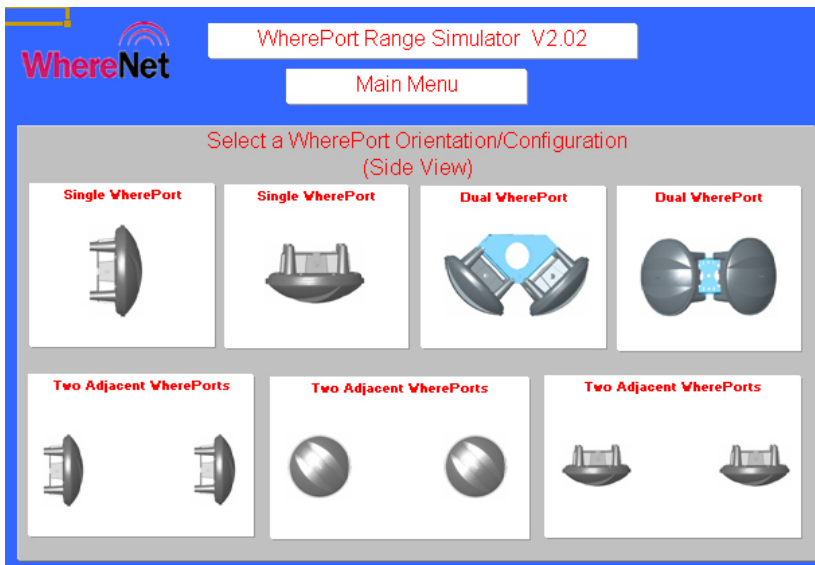

Figure 33 Starting the WherePort Simulator

Figure 33 shows the starting screen of the simulator. There are seven options for WherePort placement:

Single WherePort	Mounted vertically
Single WherePort	Mounted horizontally
Dual WherePort	Mounted horizontally
Dual WherePort	Mounted Vertically



Two Adjacent WherePorts
Two Adjacent WherePorts
Two Adjacent WherePorts

Mounted vertically, facing sideways
 Mounted vertically, facing forward
 Mounted horizontally

The magnetic field extends in all directions from the WherePort. Its position does, however, affect the direction of the field and therefore its relation to the position of the tag. It is the direction of the field that is important when reviewing the different orientations of the WherePort.

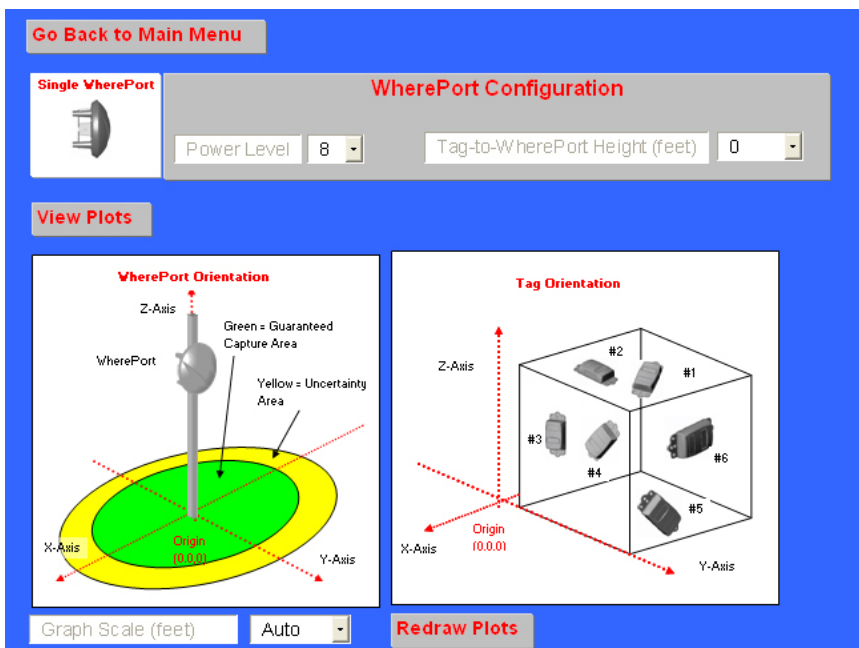

Figure 34 Configuration Screen

6.2 WherePort Configuration

The WherePort position to be simulated is configured on the WherePort configuration screen (Figure 34). There are two parameters that must be set:

- Power Level** Select a power lever from 1 to 8. The highest power level is 8.
- Tag to WherePort Height (feet)** The relationship between the height of the WherePort position and the WhereTag position (0 to 20 feet).

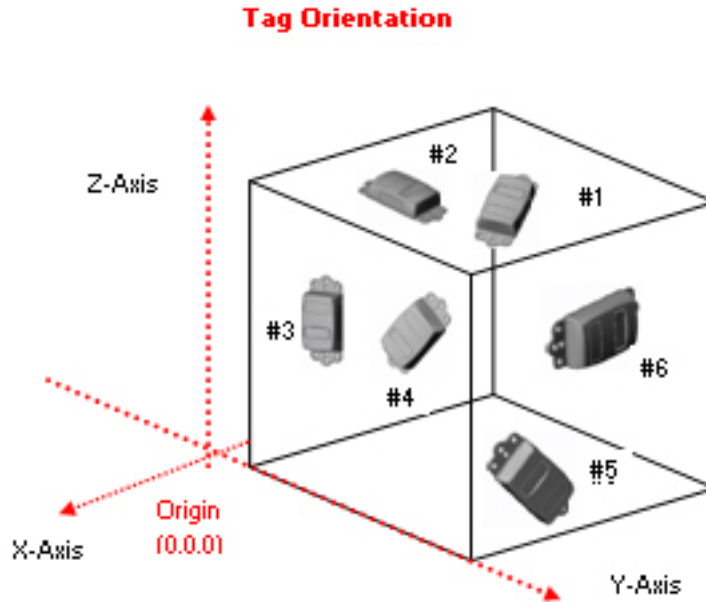

Figure 35 Tag Orientations for the Graphs

The graphs are calculated based on the tags maintaining the same orientation while it moves. Its orientation to the field will therefore change.

For each WherePort position, graphs are drawn for six different WhereTag orientations. These orientations and the number designations of each are shown in [Figure 35](#). The tag orientation is with reference to the position of the WherePort.

There are also options for controlling the presentations of the graphs. The scale sets the dimensions of the graph. A five foot scale displays the capture area for five feet in each direction. A sample graph is shown in [Figure 36](#).

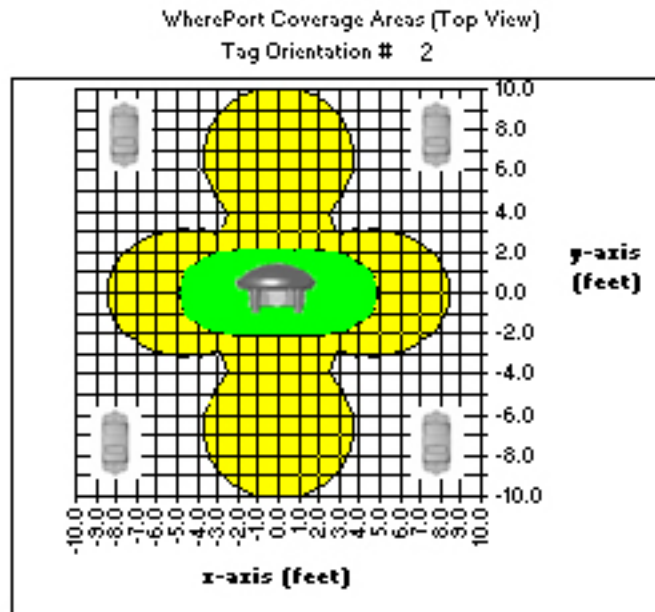

Figure 36 Sample Graph

The graph shows the guaranteed capture area in green and the uncertainty area in yellow for a single WherePort, mounted horizontally, with a power level of 4, and a tag to WherePort height of 4 feet for a tag with orientation 2. The scale is 10.

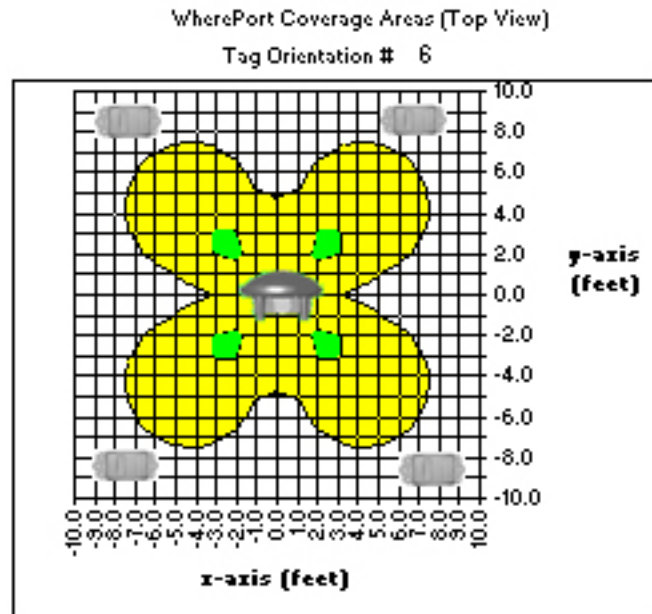

Figure 37 Sample Graph

Shows the same configuration as Figure 4 except the tag is in the 6 orientation.

6.3 Sample Graphs

The importance and usefulness of the simulator can be shown by looking at two graphs showing two different tag orientations while all other options are identical. [Figure 36](#), with orientation 2, shows a guaranteed capture area that is approximately ten feet long and four feet wide. [Figure 37](#), with orientation 6, has four very small guaranteed capture areas that are not contiguous. These settings would likely not be effective for any application.

[Figure 38](#) and [Figure 39](#) use the same settings as [Figure 36](#) and [Figure 37](#) except the power setting is 8 instead of 4.

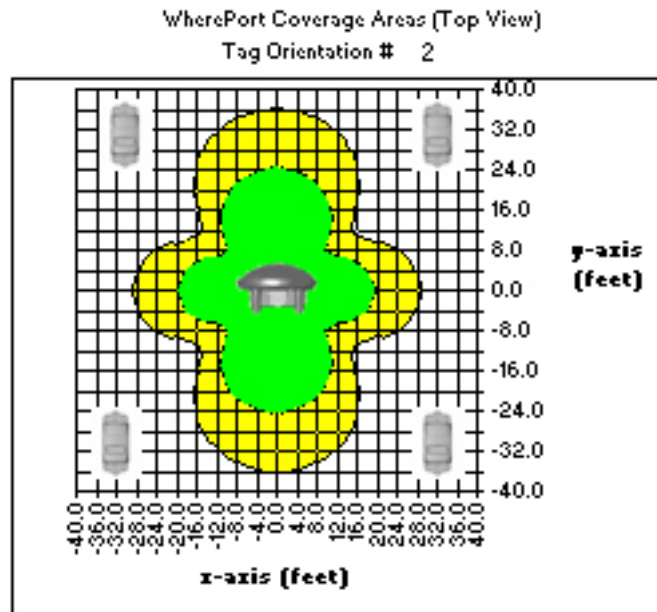

Figure 38 Power Level Comparison Tag Orientation 2

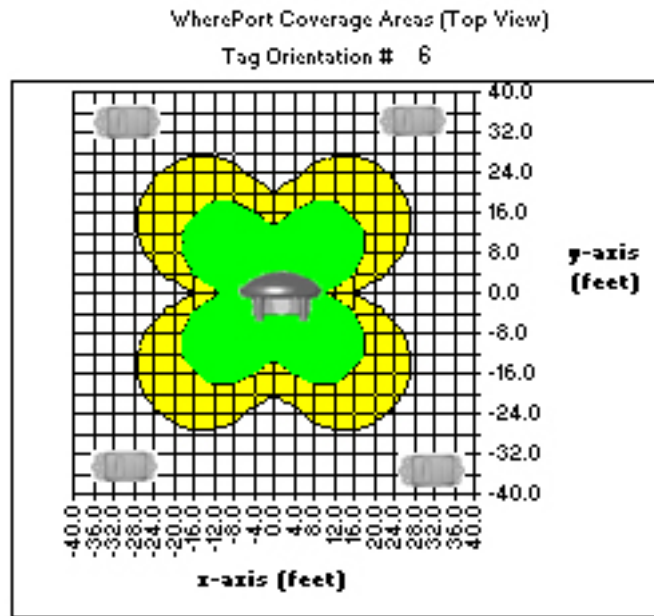

Figure 39 Power Level Comparison Tag Orientation 6

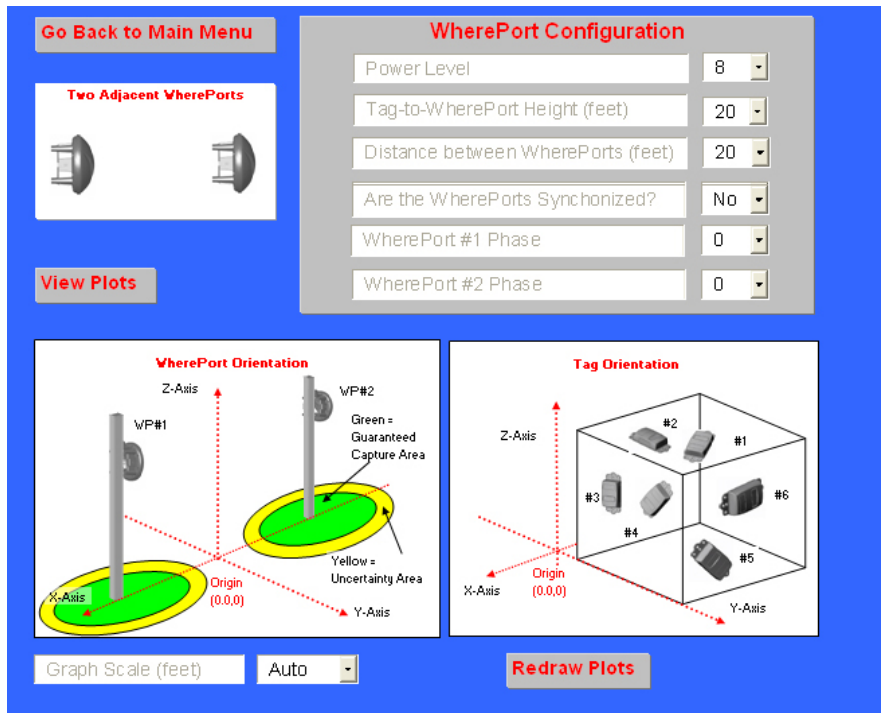

Figure 40 Adjacent WherePort Configuration

6.4 Adjacent WherePorts

Adjacent WherePorts require that some additional variables be set:

- Power Level** Select a power lever from 1 to 8. The highest power level is 8.
- Tag to WherePort Height** Set from 0 to 20 feet.
- Distance between WherePorts (feet)** 0 to 50 feet in five foot increments.
- Are the WherePorts Synchronized** Yes or no (wired together).
- WherePort #1 Phase** 0, 90, 180, or 270.
- WherePort #2 Phase** 0, 90, 180, or 270.



7 COMMAND SUMMARY

This section describes the commands used to configure the WherePort.

All commands and responses are ASCII character strings.

ACK responses are the three character string 'ACK' and not the 0x06 non-printable character. Similarly, NAK responses are the three character string 'NAK' and not the 0x15 non-printable character.

All numbers (represented by 'n' in command list) sent are the ASCII representation of the value. For example, the number 14 is sent as the two ASCII character string '14' and not the single byte 0x0E. The number 7 is sent as the single ASCII character '7' and not the single byte 0x07.

7.1 Initial Power Up

When the WherePort is initially powered up, it will transmit the following string.

```
{CR}{LF}
WhereNet{CR}{LF}
WherePort vx.xx <CR><LF> (where x.xx is the firmware version)
```

7.2 Passwords

Every command must start with a four character password followed by a colon. For example, if the password is 1234 the query command would be entered as follows:

```
1234:VER?<CR><LF>
```

The WherePort will respond with NAK to any command that does not start with the correct password.

The WherePort ignores space characters, carriage return characters, and the line feed character because it signals the end of a command. These three characters (0x0D, 0x0A, 0x20) may not be used in passwords. All other byte values are legal.

The password is set to the default value of 1234. The only command that does not require the password is the HWT n command. The HWT n command sets and queries the password. To access the password, the host must send the following three commands in order. Any other command, or any change to the sequence will reset the access flags. The sequence of commands is:

- HWT 3 Set flag 1 of 3 only if all 3 flags are cleared.
- HWT 4 Set flag 2 of 3 only if flag 1 is set and 2 and 3 are clear.
- HWT 5 Set flag 3 of 3 only if flags 1 and 2 are set and 3 is clear.
- HWT 6 Set password to 1234 only if all 3 access flags are set.



The password can be set using the `****:XPW ****` command. Changes to the password will take effect immediately. The changes affect only the current session unless the host sends the WherePort an execute command (`****:EXE`). Only after receiving an execute command will the new password be written into flash memory and read on power up. Without the execute command, the password will return to its previous value if the WherePort is powered down.

7.3 Command Execution

The following commands require the execute command (`****:EXE`) before they will be saved in flash memory and sent to the magnetic field generator:

`MSG, PWR, PHS, WID, TID, RSP, CNT, INT, TRG, DAT, CMW, CMC, XPW`

A query command will return the newly entered values, even though the execute command has not been sent. The WherePort will not be operating under these values until the execute command is sent.

7.4 Tag Responses to Commands

Unless noted otherwise, all commands will produce one of the following responses by the WhereTag

ACK	message OK
NAK	message not recognized or bad format
NAK2	message parameter out of range

There are two other possible acknowledgments that are used primarily by data commands. Their use will be noted in the command summary.

NAK3	The tag is busy and will not blink data
BSY...ACK	The tag is busy with a WherePort blink. The command will be responded to when the tag completes the WherePort blink and is not busy, at which time a ACK response will be sent.
SSS n	Response to a query where SSS is the command and n is the parameter.

All tag response strings consist of a carriage return / line feed, the actual response string, another carriage return / line feed, and are followed by the > prompt character.

`{CR}{LF} ACK{CR}{LF}>`



7.5 Commands

7.5.1 Message Length

Set the length, in bits, of the WherePort message. There are six possible values.

n	Value
1	10 bit
2	28 bit
3	44 bit
4	144 bit
5	144 bit with payload CRC1
6	144 bit with payload CRC2

Example

```
MSG 1<cr>
```

Sets the message length to 10 bits.

Considerations

Message length affects the dwell time when using sequenced WherePorts.

7.5.2 Power

Set power level, from 0 to 8. When set to 0 the WherePort power is off.

```
PWR n<cr>
```

Increasing the power level increases the range.

Example

```
PWR 8<cr>
```

Sets the power level to 8.

Considerations

Lower power levels are used to make sure the capture area of the WherePort is restricted to the zone or area to be monitored.

7.5.3 Phase

Set the phase.

```
PHS n<cr>
```

Valid range for n is 0 through 3 where 0 equals 0°, 1-90°, 2-180°, and 3-270°.

*Example*

```
PHS 2<cr>
```

Sets the phase to 2.

Considerations

When WherePort fields overlap, the phase of each WherePort must be set to match to placement of the ports.

7.5.4 WherePort ID

Sets the WherePort Id. The valid range is 0 to 32,767.

```
WID n<cr>
```

Example

```
WID 4<cr>
```

Sets the WID to 4.

Considerations

WherePort IDs 0 through 255 are used for an alternate blink mode. When a WhereTag is pinged by a WherePort with an ID less than or equal to 255 the tag is converted to the alternate blink mode.

CAUTION Do not use the alternate blink mode without consulting the Zebra Enterprise Solutions technical staff.

7.5.5 Tag Id

Set the tag ID (for 144 bit messages only). The valid range is 0 to 4,294,967,295.

```
TID n<cr>
```

Example

```
TID 4<cr>
```

Sets the tag id to 4.

Considerations

The tag ID is only set using a 144 bit message.

7.5.6 Response

Sets the tag WherePort response blink type (applies only to 27 bit and 44 bit messages)

```
RSP n<cr>
```

- 1 72 bit
- 2 144 bit

WherePort III User Guide

*Example*

```
RSP 1<cr>
```

Set the response blink type to 72 bits.

7.5.7 Count

Set the WherePort response blink count (44 bit message only).

```
CNT n<cr>
```

Valid range for n is 0 through 15.

Example

```
CNT 4<cr>
```

Sets the blink count to 4.

7.5.8 Interval

Set the WherePort response blink interval (44 bit message only) where n is 0 to 7.

```
INT n<cr>
```

7.5.9 Trigger

Set the re-trigger response (44 bit message only).

```
TRG n<cr>
```

Where n is a value 0 through 15.

Example

```
TRG 4<cr>
```

Sets the re-trigger response to .

7.5.10 Data

Set the 96 bit data payload (144 bit message only).

```
DAT [string]<cr>
```

String of 24 ASCII-HEX characters; set the 96 bit data payload (144 bit message only).

String of 22 ASCII-HEX characters: set the 96 bit data payload, payload CRC automatically calculated (144 bit message only).

Example

```
DAT string<cr>
```

WherePort III User Guide



A string of 24 ASCII-HEX characters to set the 96-bit data payload of the WherePort.

7.5.11 EXE

EXE n<cr>

Send message to magnetic field generator and the flash memory.

7.5.12 Sequence Mode

Set number of WherePort in the chain for sequencing mode.

CMW n<cr>

Where n is a value of 1 through 15. A value of 0 disables sequence mode. A value of 1 means that there is a master and 1 slave.

Example

CMW 2<cr>

Sets the number of WherePorts in the chain to 3, one master and 2 slaves.

7.5.13 Sequence Mode Message Number

CMC n<cr>

N is a value from 0 to 15. Sets the number of messages to send for each WherePort in sequence mode. 0 disables sequencing mode.

The dwell time (how long it takes to send the programmed number of messages) increases as the number of messages increases. Table 1 lists the dwell times for the available combinations of message lengths and message numbers. The types are listed in the left column. The number of messages are listed in the body of the table. The dwell time is shown in the header column.

Table 1 Dwell Time (in seconds)

Message Type	0.2	0.5	1.0	2.0	3.0	4.0	5.0	10	15	20
1	25	64	128	255						
2	12	30	60	120	181	255				
3	8	20	41	82	123	164	205			
4	3	7	14	27	41	55	68	137	205	255
5	3	7	14	27	41	55	68	137	205	255
6	3	7	14	27	41	55	68	137	205	255



7.5.14 Version

Set the software version number.

```
VER m.nn<cr>
```

Where m is the major version and nn is the minor version.

Example

```
VER 2.01<cr>
```

Sets the WherePort software version number to 2.01.

7.5.15 XPW

Set the password to the four character ssss.

```
XPW ssss<cr>
```

7.5.16 HWT (1)

Used to test the ISP port pins and set the WherePort password access flags.

```
HWT n<cr>
```

Where n is a value of 1 through 6. A value of 6 sets the default password.

Example

```
HWT 2<cr>
```

7.5.17 Loader

```
LDR n/a WherePort Loader vm.nn
```

Enter loader mode to allow firmware update. Will time out after 80 seconds if there is no transfer. Transfer format is xmodem 128 byte.

7.5.18 GQ

There are five different GQ commands. A number of arguments are possible for several of these commands. The commands govern the operation of the WherePort when the mode is changed by the system in response to a particular tag.

```
GQ1
```

Set message length = 10 bit

Execute immediately

```
GQ1 n
```

Set WPID = n, where $0 \leq n \leq 7$



	Set message length = 10 bit Execute immediately
GQ2	Set message length = 28 bit Execute immediately
GQ2 n	Set WPID = n, where $0 \leq n \leq 32,767$ Set message length = 10 bit Execute immediately
GQ3 n, m, p, q	n = 0x0-0x7FFF m = 0x0-0xF p = 0x1-0x7 q = 0x0-0xF Arguments are in upper case ASCII-Hex format Set message length = 44 bit Set WPID = n Set CNT = m Set INT = p Set TRG = q Execute immediately
GQ4	Set message length = 144 bit Execute immediately
GQ4 n	Set Tag ID n = 0 to 7FFF Argument is in ASCII-Hex format Set message length = 144 bit (CRC) Execute immediately



GQ4 s

Set message length = 144 bit (CRC)
Set data string = s (22 or 24 chars)
String is in ASCII-Hex format
Execute immediately

GQ4 n, s

n = 0 to 7FFF
s = string
Set message length = 144 bit (CRC)
Set Tag ID = n
Set data string = s (22 or 24 chars)
Execute immediately

GQ5 n

N = 0 to 7FFF
Set message length = 144 bit (CRC)
Set Tag ID = n
Execute immediately

GQ5 s

Set message length = 144 bit (CRC)
Set data string = s (22 or 24 chars)
Execute immediately

GQ5 n, s

n = 0 to 7FFF
s = string
Set message length = 144 bit (CRC)
Set Tag ID = n
Set data string = s (22 or 24 chars)
Execute immediately

GQ6 n

0 to 7FFF
Set message length = 144 bit (CRC)



Set Tag ID = n

Execute immediately

GQ6 s

Set message length = 144 bit (CRC)

Set data string = s (22 or 24 chars)

Execute immediately

GQ6 n, s

n = 0 to 7FFF

s = string

Set message length = 144 bit (CRC)

Set Tag ID = n

Set data string = s (22 or 24 chars)

Execute immediately





8 INSTALLATION

The lists of required parts, both supplied with the WherePort (Figure 41) and required but not supplied, and the instructions for mounting WherePorts in typical locations follow.

 **Caution** - Use of Zebra external power supply is limited to indoor use and a max 40° C environment. Outdoor installations will require installation of a limited power source by the installer.

 **Warning - Electrical Shock:** No operator serviceable parts inside. Refer servicing to qualified personnel. To prevent electrical shock, do not remove covers.

 **Caution** - The WherePort III must be installed by a qualified service technician.

 **Caution** – Sync cable use is limited to indoor to indoor installation or outdoor to outdoor installation. Sync cables must not be installed between indoor and outdoor installations.

8.1 WherePort Parts

1. 1/4 x 1/2 in (12mm) screw (2)
2. Lock washer (2)
3. Flat washer (2)
4. Rubber bushing (2)
5. Bracket (1)
6. WherePort (1)
7. Tag Bracket (1)
8. Power/Sync Cable (1)

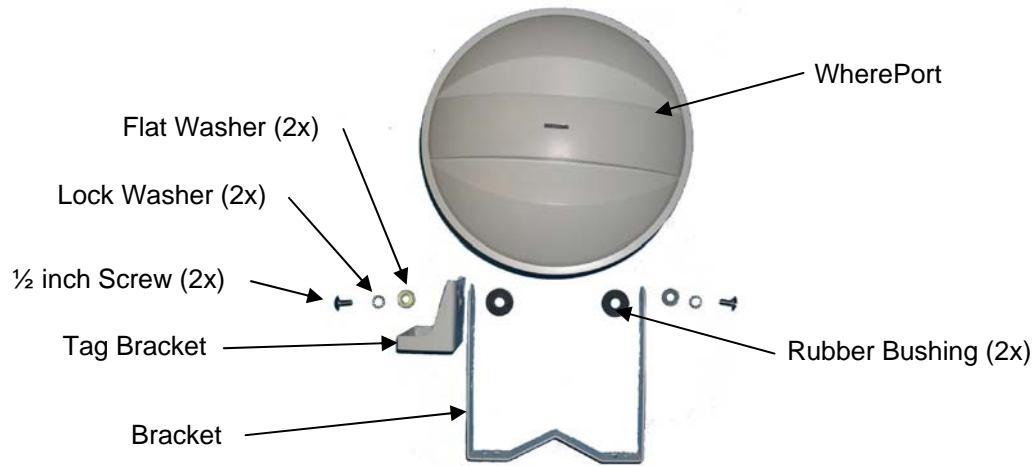

Figure 41 Installation Kit

The power/synchronization cable is not shown.

8.2 Also Required (not included)

1. Power supply, North American PS-025-00
2. Power supply, International PS-030-00
3. Power supply, vehicle 12 V, PS-200-00
4. Interconnect cabling Belden p/n 9156
5. WhereWand Programmer WND-2010 or WND-2200
6. Cable Assembly, WhereWand I to WherePort III CBL-300-00
7. Cable Assembly, WhereWand II to WherePort III CBL-320-00

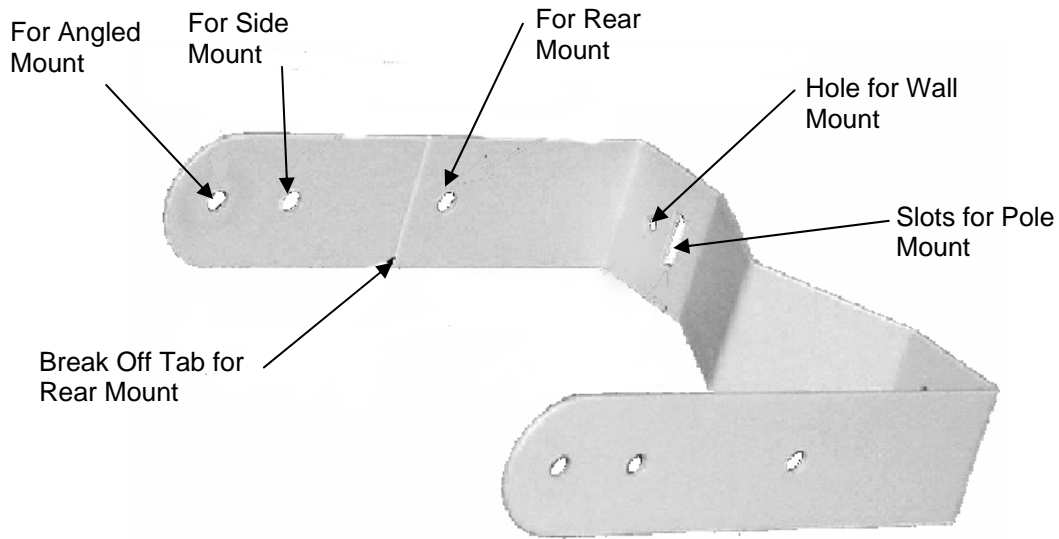

Figure 42 Mounting Bracket

8.3 Installation Procedure

- Step 1 Determine mounting location based on Zebra Enterprise Solutions site design worksheet.
- Step 2 Determine orientation of WherePort compared to mounting surface.
Choose bracket hole depending on pole mount, side mount, or rear mount.
Break bracket tab for rear mount (Figure 42). Mount bracket to wall using # 8 (4 mm) screws (not supplied) or 1/2 in (12 mm) straps for pole mount.
- Step 3 Mount WherePort to bracket using supplied hardware.

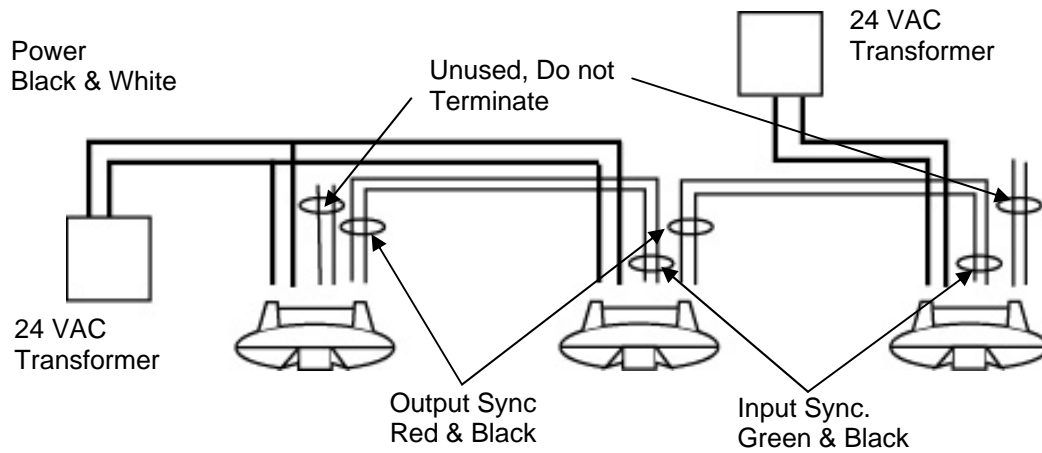

Figure 43 Wiring Schematic for Synchronized WherePorts

Since there are more the two WherePorts there are two 24 volt AC power supplies.

Step 4 Connect wiring: white & black pair to power; red & blue pair to following WherePort; green & orange pair to previous WherePort (Figure 43).

Note: Do not connect more than two WherePorts to an AC transformer.

Step 5 Use WhereWand and programming cable assembly to set the ID, power, and phase per the site design worksheet and WhereWand User Guide D0071. If desired, the WherePort can be programmed prior to installation.



A

Glossary

blink	A signal sent by a WhereTag to the RTLS system. A blink may contain 1 to 8 sub-blinks.
coverage area	The area in which a WhereTag will be pinged by a WherePort signal.
dual WherePort	Two WherePorts on a bracket, oriented at 90 degrees to each other.
guaranteed WP capture area	The part of the WherePort field where a tag will be pinged.
WP health tag	A WhereTag mounted to a WherePort to indicate if the WherePort is operating correctly.
WP field	The magnetic field produced by the WherePort. It is not the same as the coverage area.
guaranteed WP release area	The point beyond which it is certain that a tag will not be pinged.
locked	A tag may be locked by a WherePort. A locked tag is invisible to the RTLS system. Must be paired with a WherePort that unlocks the tag.
master	In a group of phased WherePorts, one must be set as the master. The phase setting for the master is 0.
orientation	Magnetic coils have an orientation. The relationship between the orientation of the pick up coil in the WhereTag and the transmit coil in the WherePort affects the range of the WherePort.
phase	WherePort setting required when uncertainty areas of coverage overlap between two or more WherePorts. The possible phase settings are 0, 90, 180, and 270.
ping	What a WherePort does to a WhereTag when the tag is in the field.
sequence	WherePorts linked together which transmit at intervals set by the master WherePort in the sequence.



simulator	A software package for experimenting with coverage areas.
slave	All WherePorts other than the maser in a group of sequenced or phased WherePorts.
uncertainty area	The part of the WherePort field where a tag may be pinged but where it is also possible that it will not be pinged.
WherePort ID	A number from 0 to 32,000 that identifies each WherePort to the system.

B

Index

- alternate blink mode, *11*
- dual WherePort, *18*
- field meter, *20*
- guaranteed capture**, *14*
- guaranteed release**, *14*
- health tag, *6*
- interference, *19*
- LED, *20*
- magnetic field, *12*
- modes, *8*
- mounting bracket, *6*
- overlapping fields, *16*
- phase, *17*
- phased
 - master, *27*
- power level, *15*
- sequenced, *29*
- simulator, *21*
- specifications, *5*
- uncertainty, *14*
- WherePort ID, *4*
- WhereTag coil orientation, *8*
- WhereTag response modes**, *8*