

# ENGINEERING TEST REPORT

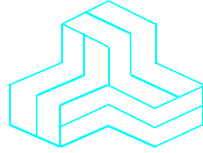

**1W Dual Frequency 900MHz/2.4GHz Digital Data Link**  
**Model: pDDL900**  
**FCC ID: NS917PDDL900**

*Applicant:*

**Microhard Systems Inc.**  
150 Country Hills Landing NW  
Calgary, Alberta  
Canada T3K 5P3

*In Accordance With*

**Federal Communications Commission (FCC)**  
**Part 15, Subpart C, Section 15.247**  
**Digital Modulation Systems (DTS) Operating in 2400 – 2483.5 MHz Band**

**UltraTech's File No.: 17MCRS101\_FCC15C247D2G4**

This Test report is Issued under the Authority of  
Tri M. Luu  
Vice President of Engineering  
UltraTech Group of Labs

Date: April 13, 2017

Report Prepared by: Dan Huynh

Tested by: Hung Trinh

Issued Date: April 13, 2017

Test Dates: November 9 - December 1, 2016  
January 31 - February 21, 2017  
April 5, 2017

- *The results in this Test Report apply only to the sample(s) tested, and the sample tested is randomly selected.*
- *This report must not be used by the client to claim product endorsement by any agency of the US Government.*
- *This test report shall not be reproduced, except in full, without a written approval from UltraTech*

## UltraTech

3000 Bristol Circle, Oakville, Ontario, Canada L6H 6G4  
Tel.: (905) 829-1570 Fax.: (905) 829-8050  
Website: [www.ultratech-labs.com](http://www.ultratech-labs.com), Email: [vic@ultratech-labs.com](mailto:vic@ultratech-labs.com), Email: [tri@ultratech-labs.com](mailto:tri@ultratech-labs.com)



91038



1309



46390-2049



AT-1945



SL2-IN-E-1119R



Korea  
KCC-RRR  
CA2049

**TABLE OF CONTENTS**

**EXHIBIT 1. INTRODUCTION..... 1**

1.1. SCOPE ..... 1

1.2. RELATED SUBMITTAL(S)/GRANT(S) ..... 1

1.3. NORMATIVE REFERENCES ..... 1

**EXHIBIT 2. PERFORMANCE ASSESSMENT..... 2**

2.1. CLIENT INFORMATION ..... 2

2.2. EQUIPMENT UNDER TEST (EUT) INFORMATION ..... 2

2.3. EUT’S TECHNICAL SPECIFICATIONS..... 3

2.4. ASSOCIATED ANTENNA DESCRIPTIONS ..... 3

2.5. LIST OF EUT’S PORTS..... 3

2.6. ANCILLARY EQUIPMENT ..... 4

**EXHIBIT 3. EUT OPERATING CONDITIONS AND CONFIGURATIONS DURING TESTS..... 5**

3.1. CLIMATE TEST CONDITIONS ..... 5

3.2. OPERATIONAL TEST CONDITIONS & ARRANGEMENT FOR TESTS..... 5

**EXHIBIT 4. SUMMARY OF TEST RESULTS ..... 6**

4.1. LOCATION OF TESTS ..... 6

4.2. APPLICABILITY & SUMMARY OF EMC EMISSION TEST RESULTS ..... 6

4.3. MODIFICATIONS INCORPORATED IN THE EUT FOR COMPLIANCE PURPOSES..... 6

**EXHIBIT 5. TEST DATA ..... 7**

5.1. POWER LINE CONDUCTED EMISSIONS [§15.207(a)]..... 7

5.2. OCCUPIED BANDWIDTH [§ 15.247(a)(2)] ..... 14

5.3. PEAK CONDUCTED OUTPUT POWER - DTS [§ 15.247(b)(3)] ..... 59

5.4. TRANSMITTER BAND-EDGE & SPURIOUS CONDUCTED EMISSIONS [§ 15.247(d)] ..... 68

5.5. TRANSMITTER SPURIOUS RADIATED EMISSIONS AT 3 METERS [§§ 15.247(d), 15.209 & 15.205] ..... 122

5.6. POWER SPECTRAL DENSITY [§ 15.247(e)]..... 127

5.7. RF EXPOSURE REQUIRMENTS [§§ 15.247(i), 1.1310 & 2.1091]..... 172

**EXHIBIT 6. TEST EQUIPMENT LIST ..... 175**

**EXHIBIT 7. MEASUREMENT UNCERTAINTY ..... 176**

7.1. LINE CONDUCTED EMISSION MEASUREMENT UNCERTAINTY ..... 176

7.2. RADIATED EMISSION MEASUREMENT UNCERTAINTY ..... 176

## EXHIBIT 1. INTRODUCTION

### 1.1. SCOPE

<b>Reference:</b>	FCC Part 15, Subpart C, Section 15.247
<b>Title:</b>	Code of Federal Regulations (CFR), Title 47 – Telecommunication, Part 15 – Radio Frequency Devices
<b>Purpose of Test:</b>	Equipment Certification for Digital Modulation Systems (DTS) Operating Under §15.247
<b>Test Procedures:</b>	<ul style="list-style-type: none"><li>▪ ANSI C63.4</li><li>▪ ANSI C63.10</li><li>▪ FCC KDB Publication No. 558074 D01 DTS Meas Guidance v03r05</li></ul>
<b>Environmental Classification:</b>	<input checked="" type="checkbox"/> Commercial, industrial or business environment <input checked="" type="checkbox"/> Residential environment

### 1.2. RELATED SUBMITTAL(S)/GRANT(S)

None.

### 1.3. NORMATIVE REFERENCES

Publication	Year	Title
47 CFR Parts 0-19	2017	Code of Federal Regulations (CFR), Title 47 – Telecommunication
ANSI C63.4	2014	American National Standard for Methods of Measurement of Radio-Noise Emissions from Low-Voltage Electrical and Electronic Equipment in the Range of 9 KHz to 40 GHz
ANSI C63.10	2013	American National Standard of Procedures for Compliance Testing of Unlicensed Wireless Devices
FCC, KDB Publication No. 558074 D01 DTS Meas Guidance v03r05	2016	Guidance for Performing Compliance Measurements on Digital Transmission Systems (DTS) Operating Under §15.247

## EXHIBIT 2. PERFORMANCE ASSESSMENT

### 2.1. CLIENT INFORMATION

APPLICANT	
<b>Name:</b>	Microhard Systems Inc.
<b>Address:</b>	150 Country Hills Landing NW Calgary, Alberta Canada T3K 5P3
<b>Contact Person:</b>	Mr. Hany Shenouda Phone #: 403 248-0028 Fax #: 403 248 2762 Email Address: shenouda@microhardcorp.com

MANUFACTURER	
<b>Name:</b>	Microhard Systems Inc.
<b>Address:</b>	150 Country Hills Landing NW Calgary, Alberta Canada T3K 5P3
<b>Contact Person:</b>	Mr. Hany Shenouda Phone #: 403 248-0028 Fax #: 403 248-2762 Email Address: shenouda@microhardcorp.com

### 2.2. EQUIPMENT UNDER TEST (EUT) INFORMATION

The following information (with the exception of the Date of Receipt) has been supplied by the applicant.

<b>Brand Name:</b>	Microhard Systems Inc.
<b>Product Name:</b>	1W Dual Frequency 900MHz/2.4GHz Digital Data Link
<b>Model Name or Number:</b>	pDDL900
<b>Serial Number:</b>	Test Sample
<b>Type of Equipment:</b>	Digital Transmission System (DTS)
<b>Input Power Supply Type:</b>	External DC Power Supply
<b>Primary User Functions of EUT:</b>	The pDDL900 is a high power, OEM, Dual Frequency, Wireless Digital Data Link. The pDDL900 is designed to provide high performance wireless capabilities in a compact and rugged OEM module for system integration.

**2.3. EUT’S TECHNICAL SPECIFICATIONS**

Transmitter			
<b>Equipment Type:</b>	<ul style="list-style-type: none"> <li>• Mobile</li> <li>• Base Station (fixed use)</li> </ul>		
<b>Intended Operating Environment:</b>	<ul style="list-style-type: none"> <li>▪ Commercial, industrial or business environment</li> <li>▪ Residential environment</li> </ul>		
<b>Power Supply Requirement:</b>	3.3 VDC		
<b>RF Output Power Rating:</b>	7 – 30 dBm typical		
<b><sup>1</sup>Tx Gain Setting:</b>	0-70		
<b>Operating Frequency Range:</b>	Bandwidth	<sup>2</sup> Data Rate 1, 2, 3	<sup>2</sup> Data Rate 4, 5, 6, 7
	1 MHz and 2 MHz	2402 - 2482 MHz	2402 - 2482 MHz
	4 MHz	2403 - 2480 MHz	2403 - 2480 MHz
	8 MHz	2407 - 2477 MHz	2407 - 2477 MHz
<b>RF Output Impedance:</b>	50 Ω		
<b>Duty Cycle:</b>	Continuous		
<b>Modulation Type:</b>	COFDM		
<b>Antenna Connector Types:</b>	U.FL		

<sup>1</sup>TX gain setting is a factory tune-up parameter, not available to end users

<sup>2</sup>Refer to operational description exhibit for more information on data rates and operational restrictions, 1MHz bandwidth at data rate 3 shall be disabled.

**2.4. ASSOCIATED ANTENNA DESCRIPTIONS**

Antenna Type	Maximum Gain (dBi)
Rubber Ducky	2.5
Patch Antenna	14
Yagi Antenna	14.5
Omni Directional Antenna	15

**2.5. LIST OF EUT’S PORTS**

Port Number	EUT’s Port Description	Number of Identical Ports	Connector Type	Cable Type (Shielded/Non-shielded)
1	RF port	2	U.FL	Shielded cable
2	DC supply and I/O port	1	Pin header	Direct connection (no cable)

## 2.6. ANCILLARY EQUIPMENT

The EUT was tested while connected to the following representative configuration of ancillary equipment necessary to exercise the ports during tests:

<b>Ancillary Equipment # 1</b>	
Description:	Test Jig
Brand name:	Microhard Systems Inc.
Model Name or Number:	N/A
Connected to EUT's Port:	I/O Port

<b>Ancillary Equipment # 2</b>	
Description:	AC/DC Adapter
Brand name:	BI Switching Power Supply
Model Name or Number:	BI30-120200-AdU
Connected to EUT's Port:	Test Jig of the EUT

**EXHIBIT 3. EUT OPERATING CONDITIONS AND CONFIGURATIONS DURING TESTS**

**3.1. CLIMATE TEST CONDITIONS**

The climate conditions of the test environment are as follows:

Temperature:	21 to 23 °C
Humidity:	45 to 58%
Pressure:	102 kPa
Power Input Source:	3.3 VDC

**3.2. OPERATIONAL TEST CONDITIONS & ARRANGEMENT FOR TESTS**

<b>Operating Modes:</b>	The transmitter was operated in a continuous transmission mode with the carrier modulated as specified in the Test Data.
<b>Special Test Software:</b>	Test software provided by the Applicant to operate the EUT at each channel frequency continuously and in the range of typical modes of operation.
<b>Special Hardware Used:</b>	Test Jig
<b>Transmitter Test Antenna:</b>	The EUT is tested with the antenna fitted in a manner typical of normal intended use as non-integral antenna equipment as described with the test results.

<b>Transmitter Test Signals</b>	
<b>Frequency Band(s):</b>	2402 - 2482 MHz 2403- 2480 MHz 2407 – 2477 MHz
<b>Frequency(ies) Tested:</b>	2402 MHz, 2403 MHz, 2407 MHz, 2442 MHz, 2477 MHz, 2480 MHz, 2482 MHz
<b>RF Power Output:</b> (measured maximum output power at antenna terminals)	29.99 dBm Peak
<b>Normal Test Modulation:</b>	COFDM
<b>Modulating Signal Source:</b>	Internal

## EXHIBIT 4. SUMMARY OF TEST RESULTS

### 4.1. LOCATION OF TESTS

All of the measurements described in this report were performed at Ultratech Group of Labs located in the city of Oakville, Province of Ontario, Canada.

- AC Power Line Conducted Emissions were performed in UltraTech's shielded room, 24'(L) by 16'(W) by 8'(H).
- Radiated Emissions were performed at the Ultratech's 3-10 TDK Semi-Anechoic Chamber situated in the Town of Oakville, province of Ontario. This test site been calibrated in accordance with ANSI C63.4, and found to be in compliance with the requirements of Sec. 2.948 of the FCC Rules. The descriptions and site measurement data of the Oakville 3-10 TDK Semi-Anechoic Chamber has been filed with FCC office (FCC File No.: 91038) and Industry Canada office (Industry Canada File No.: 2049A-3). Expiry Date: 2020-03-27.

### 4.2. APPLICABILITY & SUMMARY OF EMC EMISSION TEST RESULTS

FCC Section(s)	Test Requirements	Compliance (Yes/No)
15.203	Antenna requirements	Yes
15.207(a)	AC Power Line Conducted Emissions	Yes
15.247(a)(2)	6 dB Bandwidth	Yes
15.247(b)(3)	Peak Conducted Output Power - DTS	Yes
15.247(d)	Band-Edge and RF Conducted Spurious Emissions at the Transmitter Antenna Terminal	Yes
15.247(d), 15.209 & 15.205	Transmitter Spurious Radiated Emissions	Yes
15.247(e)	Power Spectral Density	Yes
15.247(i), 1.1307, 1.1310, 2.1091	RF Exposure	Yes

### 4.3. MODIFICATIONS INCORPORATED IN THE EUT FOR COMPLIANCE PURPOSES

None.



**EXHIBIT 5. TEST DATA**

**5.1. POWER LINE CONDUCTED EMISSIONS [§15.207(a)]**

**5.1.1. Limit(s)**

The equipment shall meet the limits of the following table:

Frequency of emission (MHz)	Conducted Limits (dB $\mu$ V)	
	Quasi-peak	Average
0.15–0.5 .....	66 to 56* .....	56 to 46*
0.5–5 .....	56 .....	46
5–30 .....	60 .....	50

\*Decreases linearly with the logarithm of the frequency

**5.1.2. Method of Measurements**

ANSI C63.4

**5.1.3. Test Arrangement**

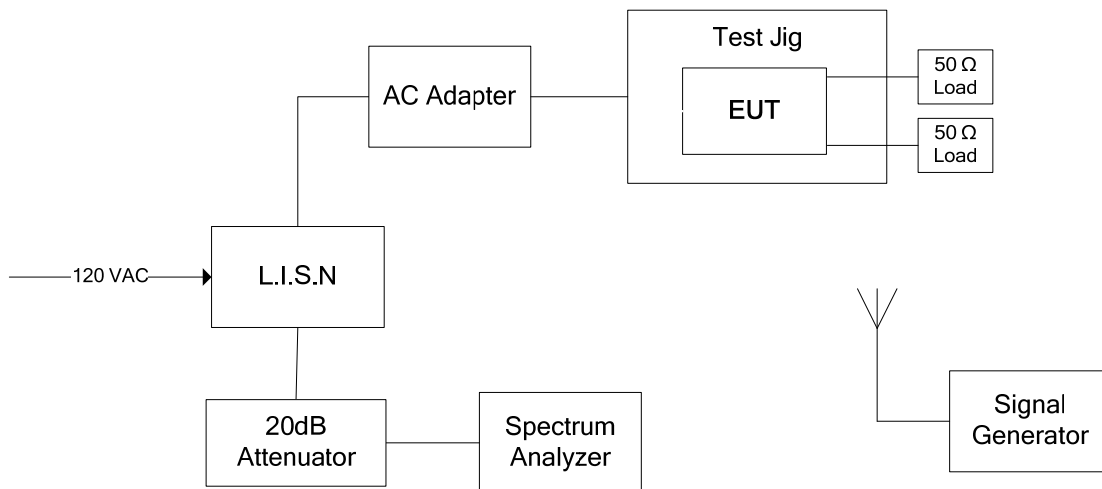

5.1.4. Test Data

Plot 5.1.4.1. Power Line Conducted Emissions (Test Configuration 1: Tx Mode at 2440 MHz)  
 Line Voltage: 120 VAC; Line Tested: Hot

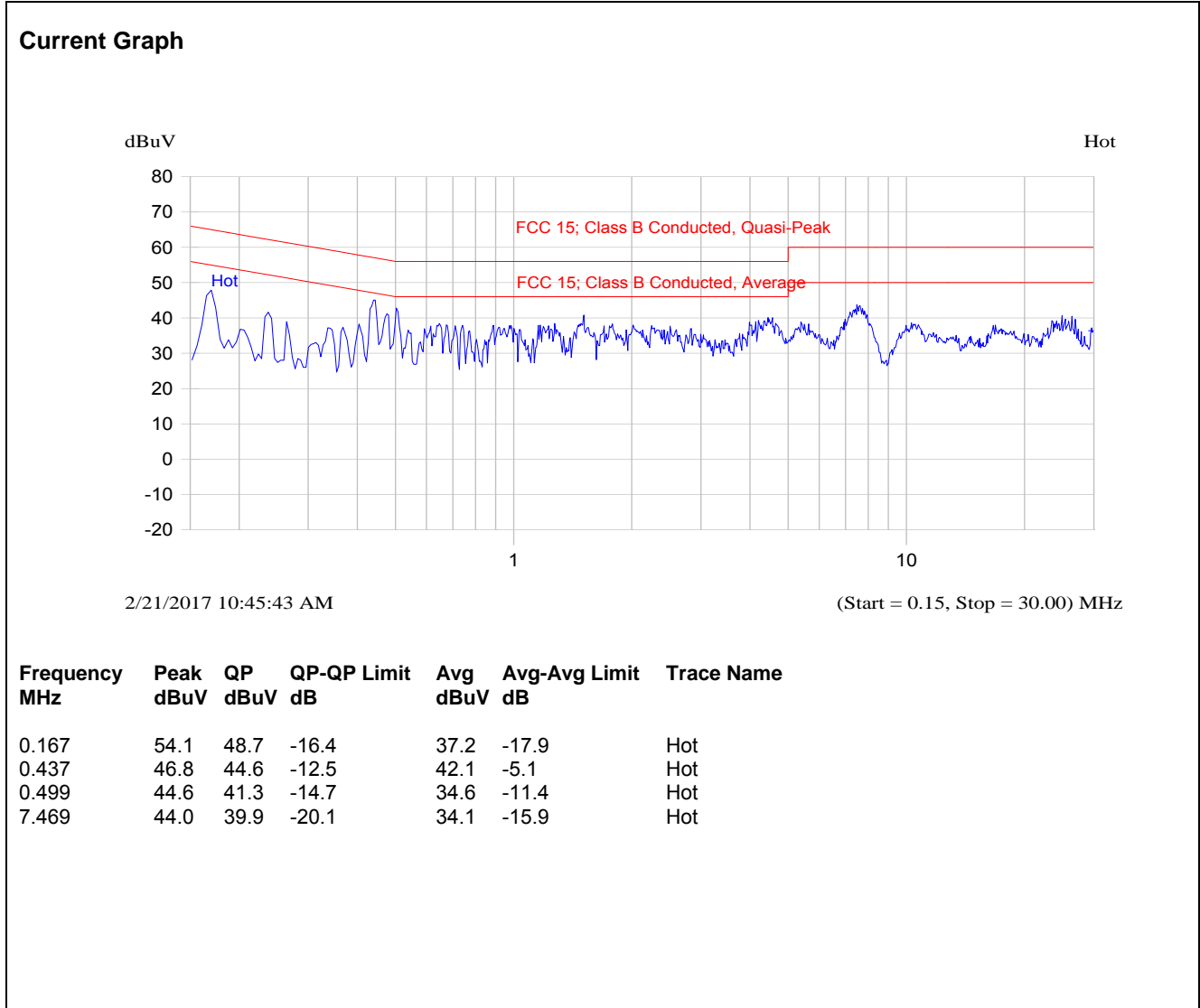

**Plot 5.1.4.2.** Power Line Conducted Emissions (Test Configuration 1: Tx Mode at 2440 MHz)  
 Line Voltage 120 VAC; Line Tested: Neutral

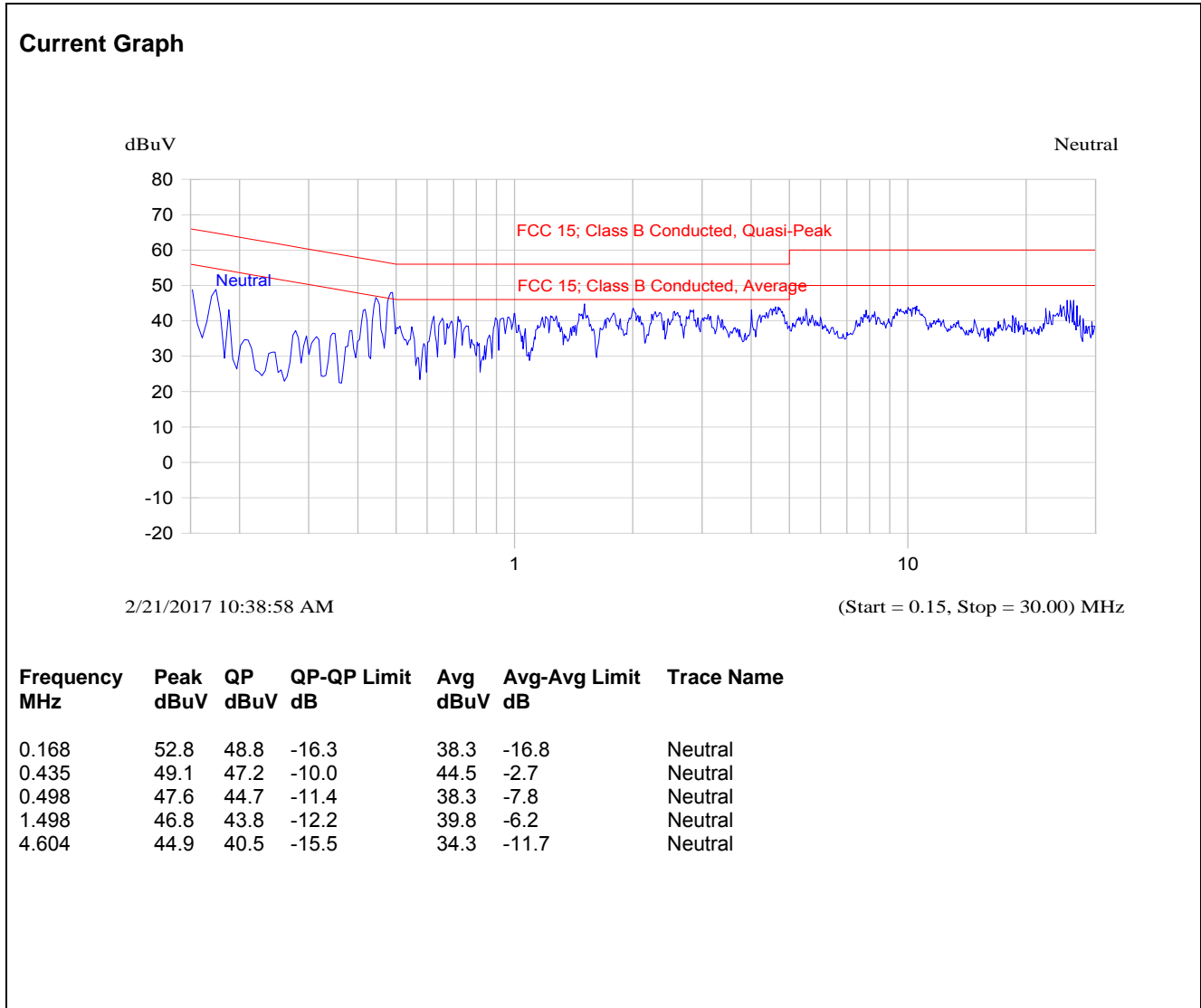

**Plot 5.1.4.3. Power Line Conducted Emissions (Test Configuration 2: Tx Mode at 915 MHz)**  
 Line Voltage 120 VAC; Line Tested: Neutral

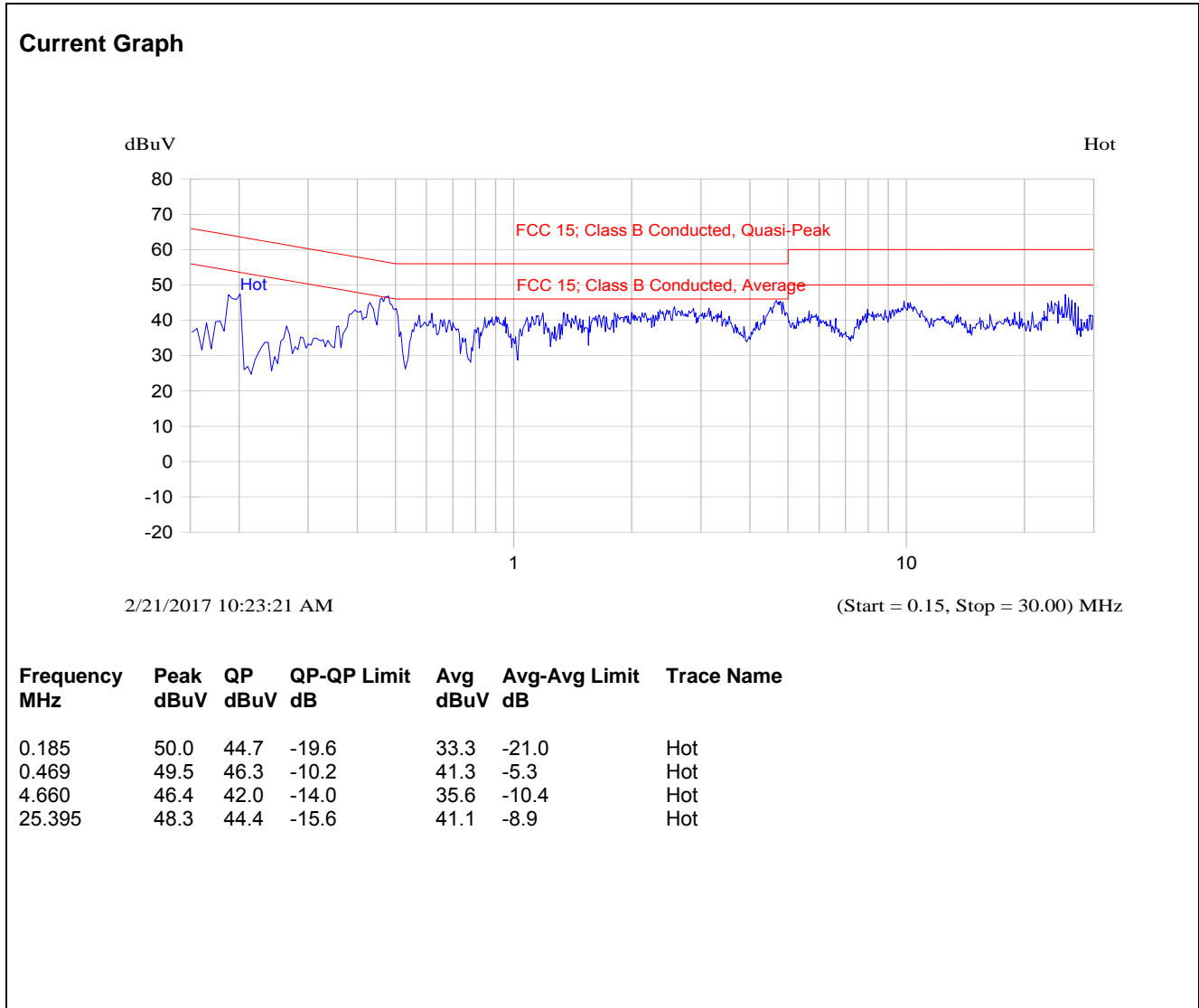

**Plot 5.1.4.4.** Power Line Conducted Emissions (Test Configuration 2: Tx Mode at 915 MHz)  
 Line Voltage 120 VAC; Line Tested: Neutral

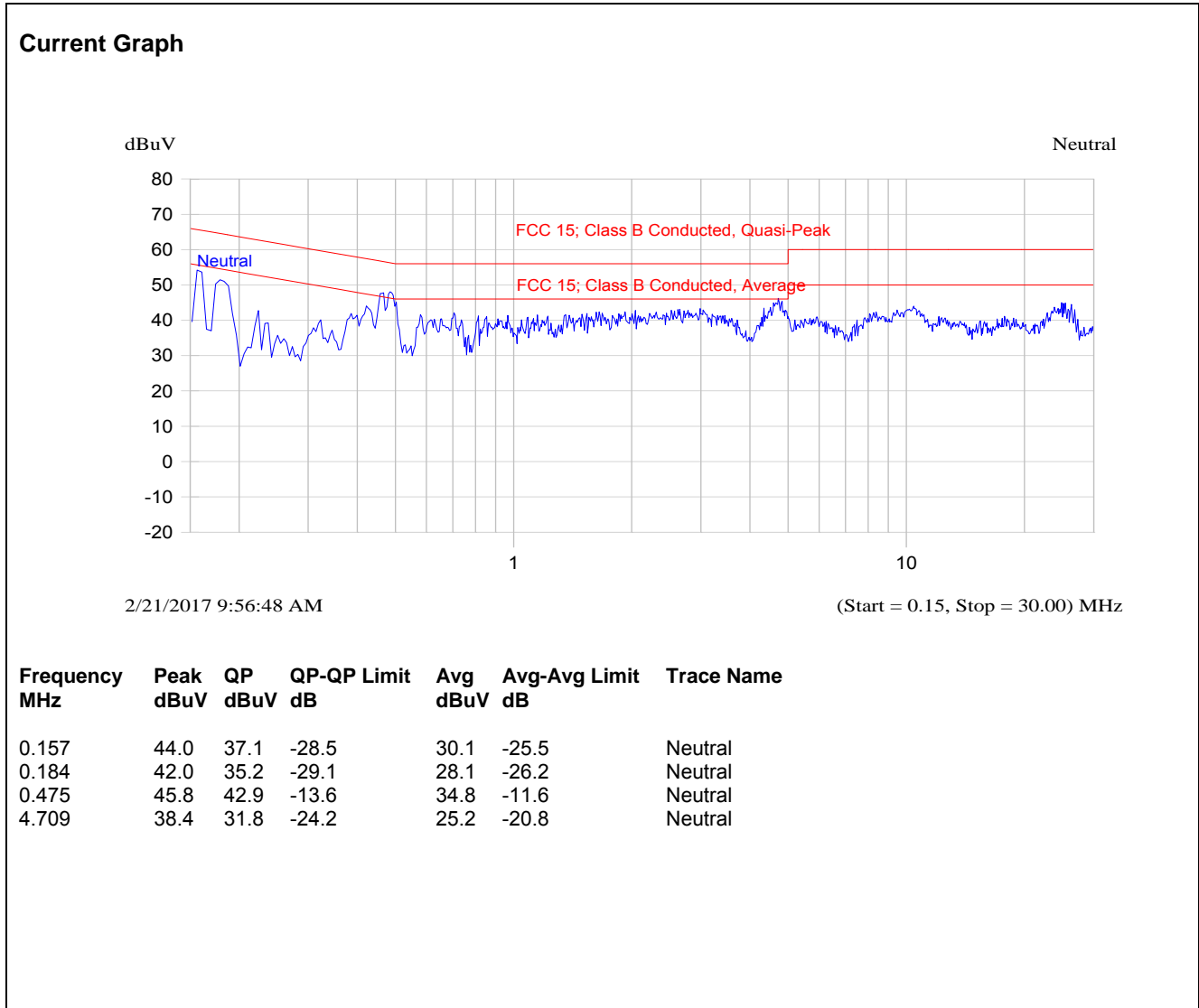

**Plot 5.1.4.5.** Power Line Conducted Emissions (Test Configuration 3: Rx Mode at 915 MHz)  
 Line Voltage 120 VAC; Line Tested: Neutral

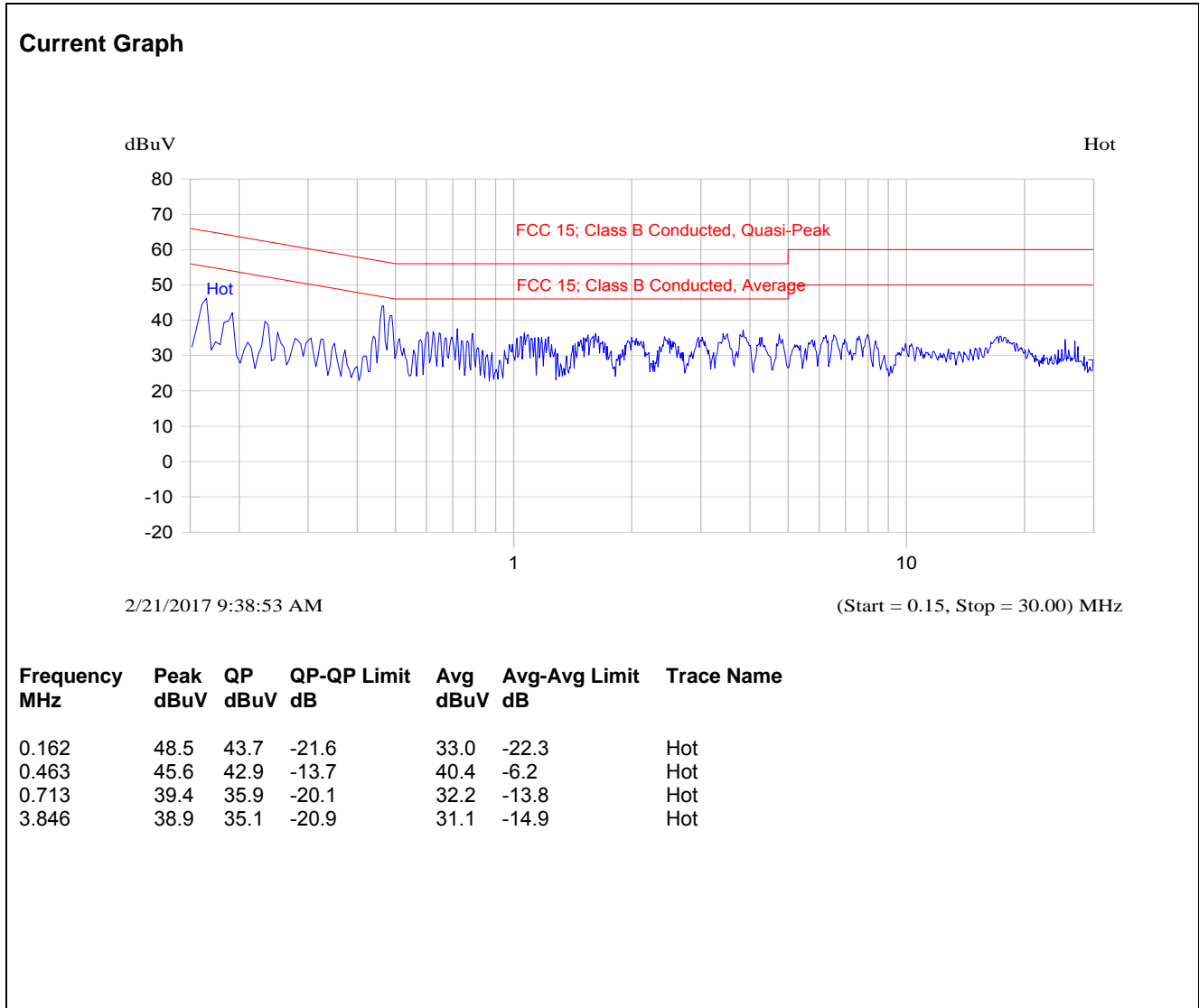

**Plot 5.1.4.6.** Power Line Conducted Emissions (Test Configuration 3: Rx Mode at 915 MHz)  
 Line Voltage 120 VAC; Line Tested: Neutral

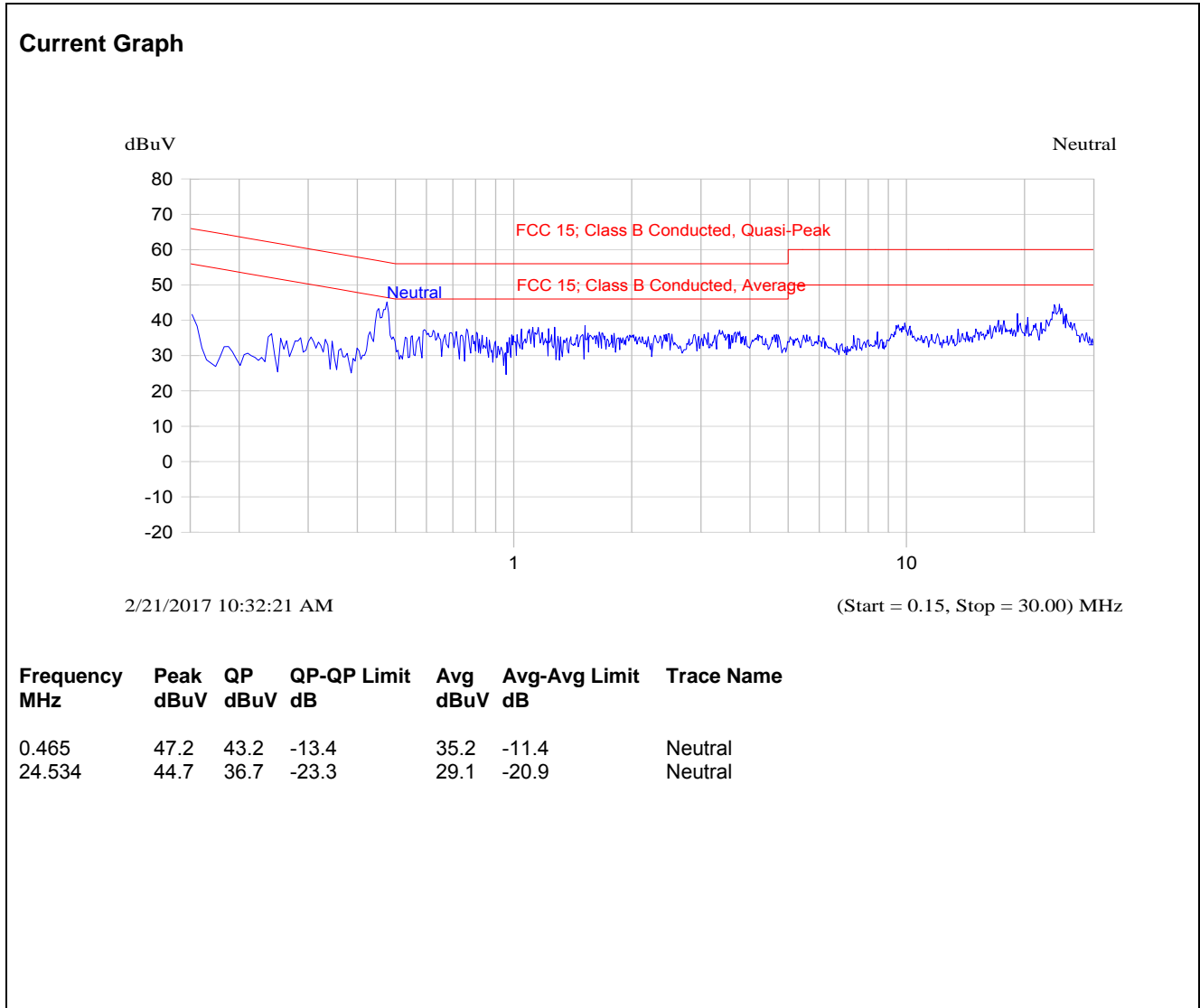

**5.2. OCCUPIED BANDWIDTH [§ 15.247(a)(2)]**

**5.2.1. Limit(s)**

The minimum 6 dB bandwidth shall be at least 500 kHz.

**5.2.2. Method of Measurements**

KDB 558074D01 DTS Meas Guidance v03r05, Section 8.1 DTS bandwidth Option 1 or 2 methods

**5.2.3. Test Arrangement**

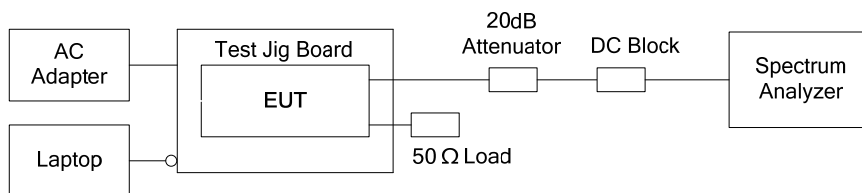

**5.2.4. Test Data**

Operating Mode	Data Rate	Frequency (MHz)	6dB BW (MHz)	Min. Limit (kHz)
Bandwidth: 1 MHz TX Gain: 26	1	2402	0.513	500
		2442	0.509	500
		2482	0.512	500
	2	2402	0.527	500
		2442	0.523	500
		2482	0.529	500
Bandwidth: 2 MHz TX Gain: 32	1	2402	0.942	500
		2442	0.949	500
		2482	0.942	500
	2	2402	0.984	500
		2442	0.978	500
		2482	0.974	500
	3	2402	0.936	500
		2442	0.920	500
		2482	0.894	500



Operating Mode	Data Rate	Frequency (MHz)	6dB BW (MHz)	Min. Limit (kHz)
Bandwidth: 4 MHz TX Gain: 43	1	2403	1.827	500
		2442	1.833	500
		2480	1.833	500
	2	2403	1.853	500
		2442	1.904	500
		2480	1.917	500
	3	2403	1.827	500
		2442	1.840	500
		2480	1.955	500
Bandwidth: 8 MHz TX Gain: 50	1	2407	4.535	500
		2442	4.535	500
		2477	4.567	500
	2	2407	3.910	500
		2442	3.910	500
		2477	4.776	500
	3	2407	4.038	500
		2442	4.103	500
		2477	4.022	500

Operating Mode	Data Rate	Frequency (MHz)	6dB BW (MHz)	Min. Limit (kHz)
Bandwidth: 1 MHz TX Gain: 43	4	2402	1.054	500
		2442	1.042	500
		2482	1.050	500
	5	2402	1.066	500
		2442	1.046	500
		2482	1.054	500
	6	2402	1.058	500
		2442	1.058	500
		2482	1.066	500
	7	2402	1.046	500
		2442	1.050	500
		2482	1.054	500
Bandwidth: 2 MHz TX Gain: 45	4	2402	2.075	500
		2442	2.107	500
		2482	2.115	500
	5	2402	2.059	500
		2442	2.099	500
		2482	2.115	500
	6	2402	2.139	500
		2442	2.083	500
		2482	2.123	500
	7	2402	2.099	500
		2442	2.099	500
		2482	2.083	500

**ULTRATECH GROUP OF LABS**

3000 Bristol Circle, Oakville, Ontario, Canada L6H 6G4  
 Tel. #: 905-829-1570, Fax. #: 905-829-8050, Email: [vic@ultratech-labs.com](mailto:vic@ultratech-labs.com), Website: <http://www.ultratech-labs.com>

File #: 17MCRS101\_FCC15C247D2G4

April 13, 2017

*All test results contained in this engineering test report are traceable to National Institute of Standards and Technology (NIST)*

Operating Mode	Data Rate	Frequency (MHz)	6dB BW (MHz)	Min. Limit (kHz)
Bandwidth: 4 MHz TX Gain: 50	4	2403	4.154	500
		2442	4.154	500
		2480	4.139	500
	5	2403	4.168	500
		2442	4.139	500
		2480	4.168	500
	6	2403	4.168	500
		2442	4.183	500
		2480	4.197	500
	7	2403	4.168	500
		2442	4.154	500
		2480	4.154	500
Bandwidth: 8 MHz TX Gain: 55	4	2407	8.301	500
		2442	8.301	500
		2477	8.301	500
	5	2407	8.333	500
		2442	8.333	500
		2477	8.333	500
	6	2407	8.333	500
		2442	8.333	500
		2477	8.333	500
	7	2407	8.333	500
		2442	8.333	500
		2477	8.333	500

**ULTRATECH GROUP OF LABS**

3000 Bristol Circle, Oakville, Ontario, Canada L6H 6G4  
 Tel. #: 905-829-1570, Fax. #: 905-829-8050, Email: [yic@ultratech-labs.com](mailto:yic@ultratech-labs.com), Website: <http://www.ultratech-labs.com>

File #: 17MCRS101\_FCC15C247D2G4

April 13, 2017

*All test results contained in this engineering test report are traceable to National Institute of Standards and Technology (NIST)*

Plot 5.2.4.1. 6 dB Bandwidth, Bandwidth: 1 MHz, TX Gain: 26, Data Rate 1, 2402 MHz

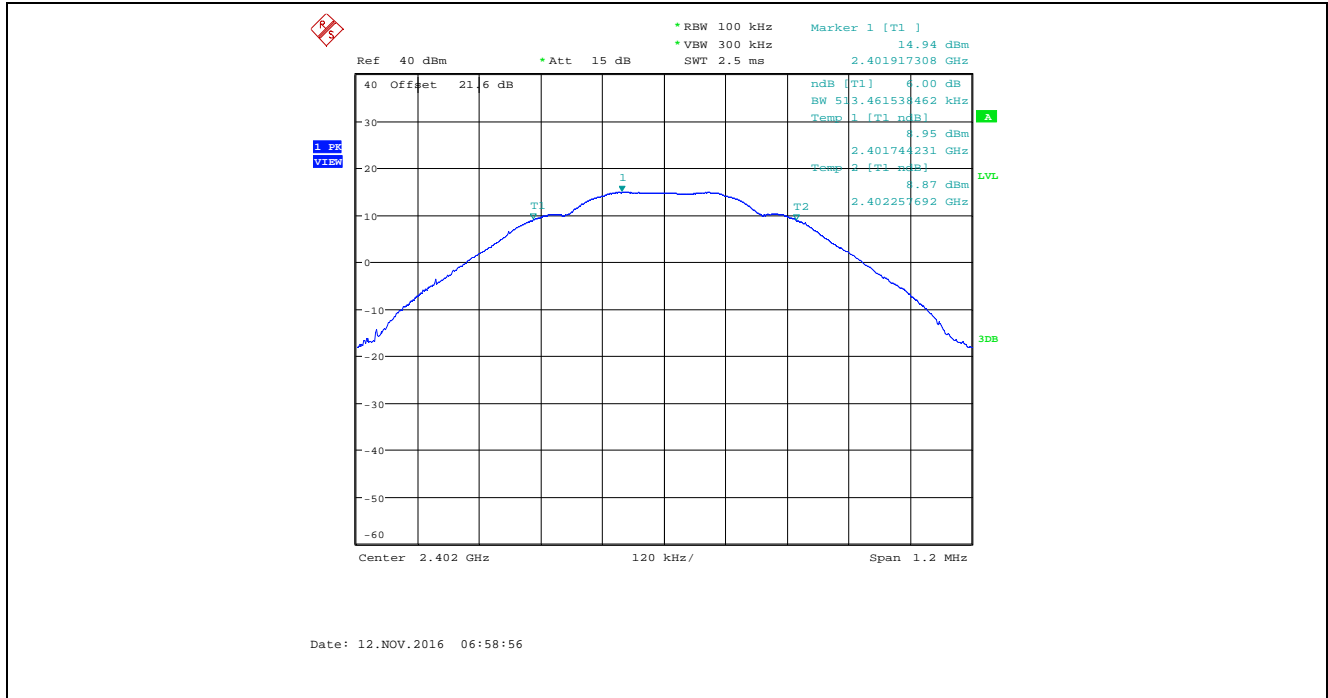

Plot 5.2.4.2. 6 dB Bandwidth, Bandwidth: 1 MHz, TX Gain: 26, Data Rate 1, 2442 MHz

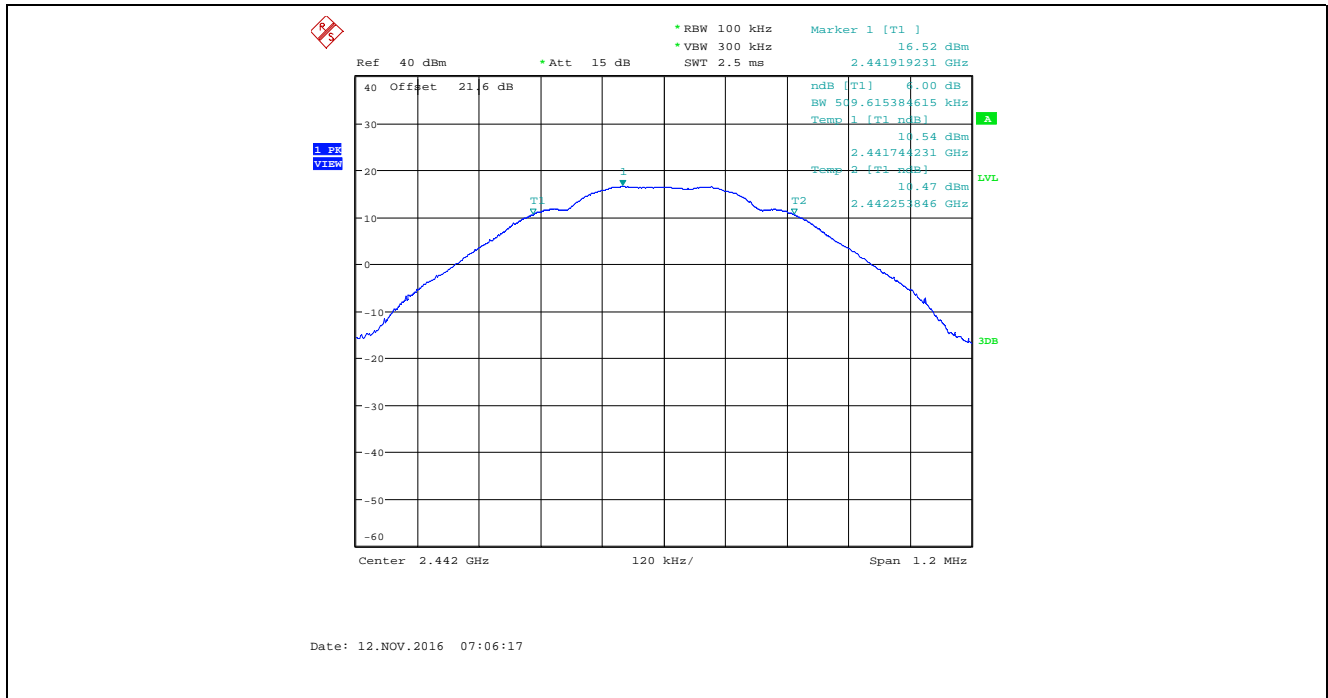

Plot 5.2.4.3. 6 dB Bandwidth, Bandwidth: 1 MHz, TX Gain: 26, Data Rate 1, 2482 MHz

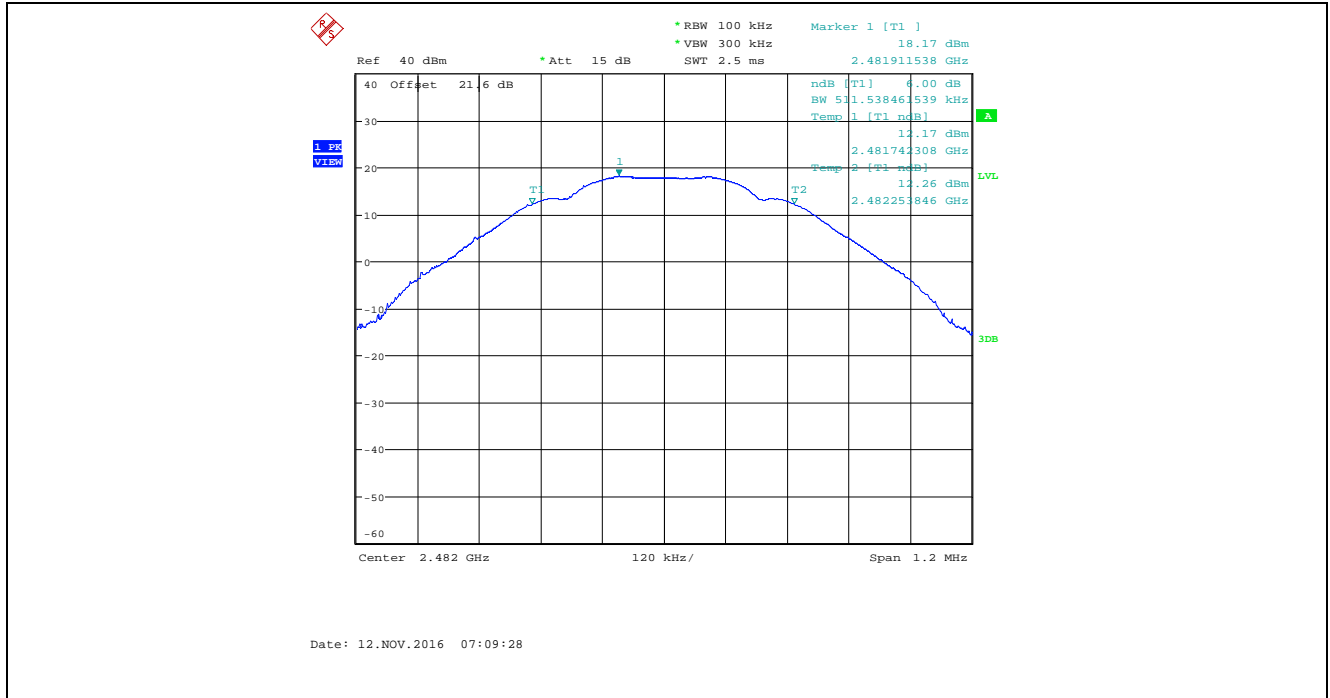

Plot 5.2.4.4. 6 dB Bandwidth, Bandwidth: 1 MHz, TX Gain: 26, Data Rate 2, 2402 MHz

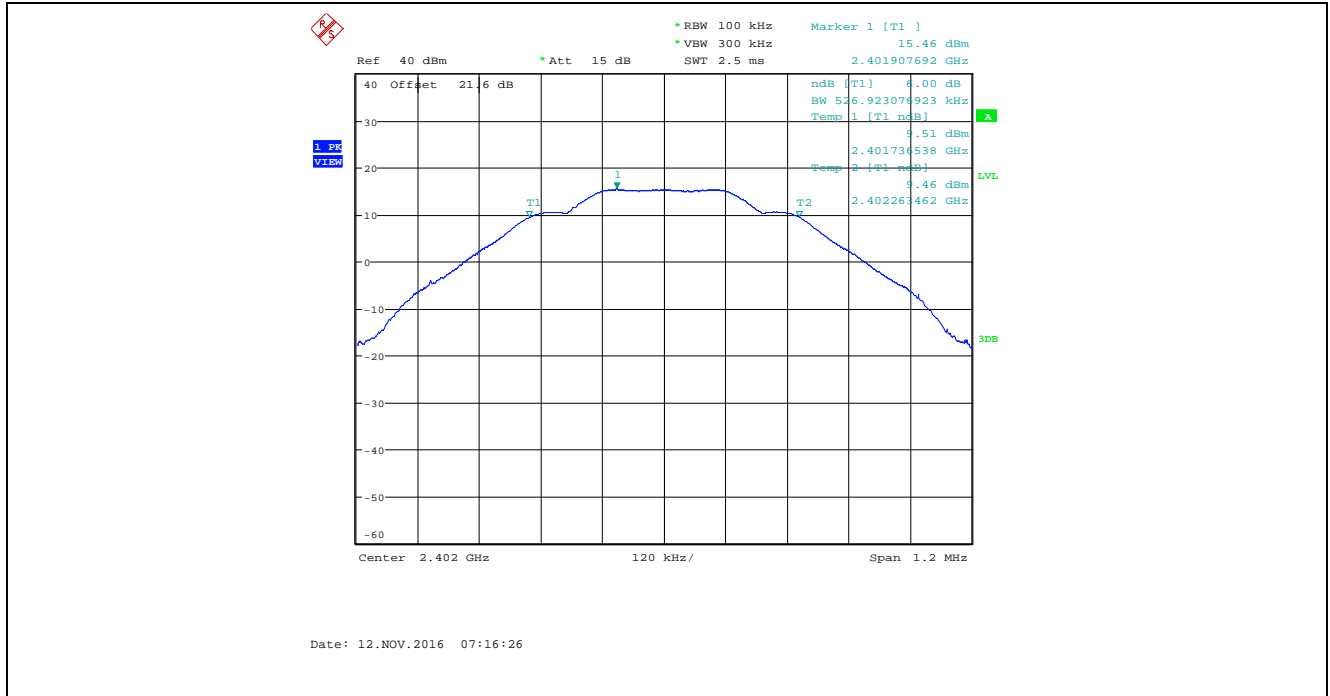

Plot 5.2.4.5. 6 dB Bandwidth, Bandwidth: 1 MHz, TX Gain: 26, Data Rate 2, 2442 MHz

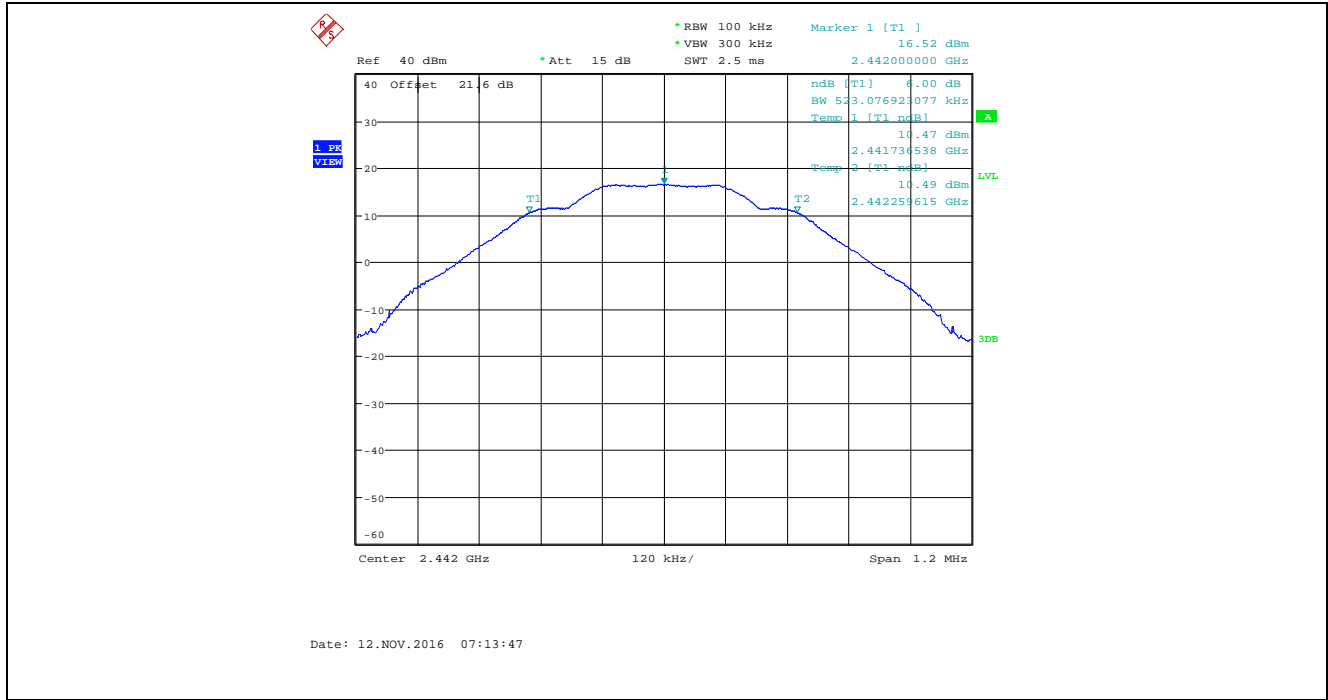

Plot 5.2.4.6. 6 dB Bandwidth, Bandwidth: 1 MHz, TX Gain: 26, Data Rate 2, 2482 MHz

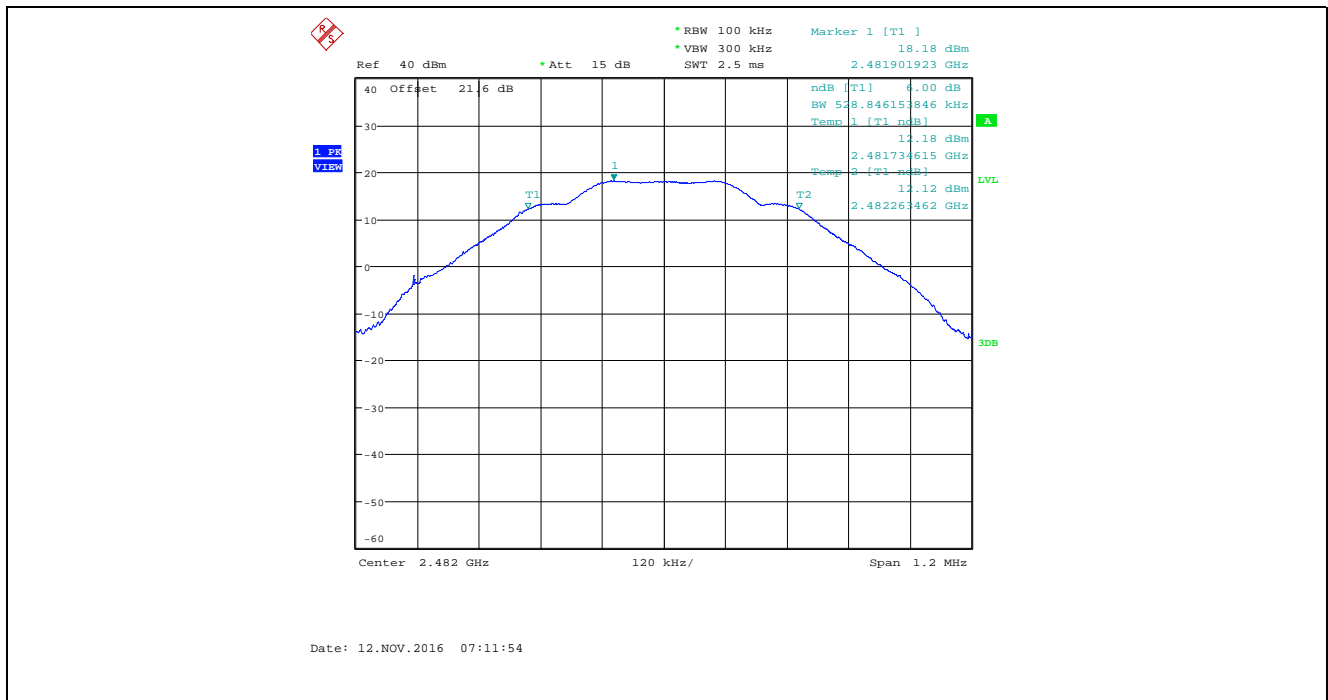

Plot 5.2.4.7. 6 dB Bandwidth, Bandwidth: 2 MHz, TX Gain: 32, Data Rate 1, 2402 MHz

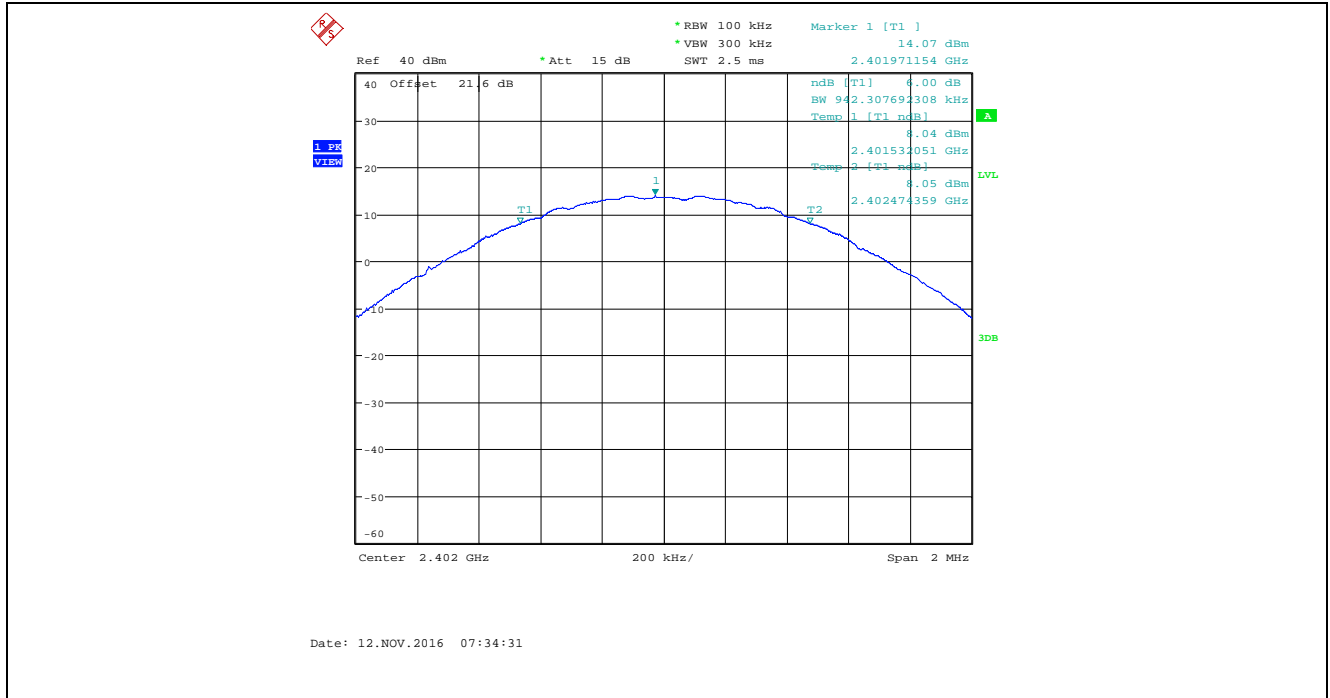

Plot 5.2.4.8. 6 dB Bandwidth, Bandwidth: 2 MHz, TX Gain: 32, Data Rate 1, 2442 MHz

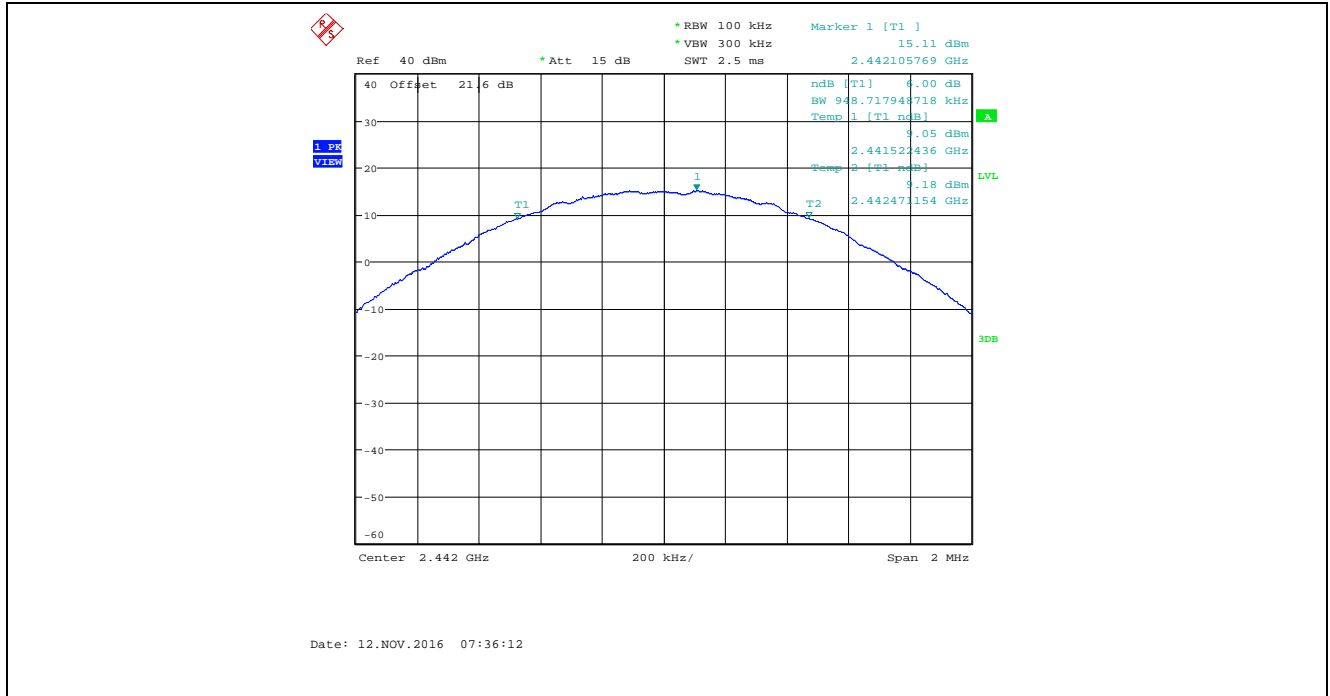

Plot 5.2.4.9. 6 dB Bandwidth, Bandwidth: 2 MHz, TX Gain: 32, Data Rate 1, 2482 MHz

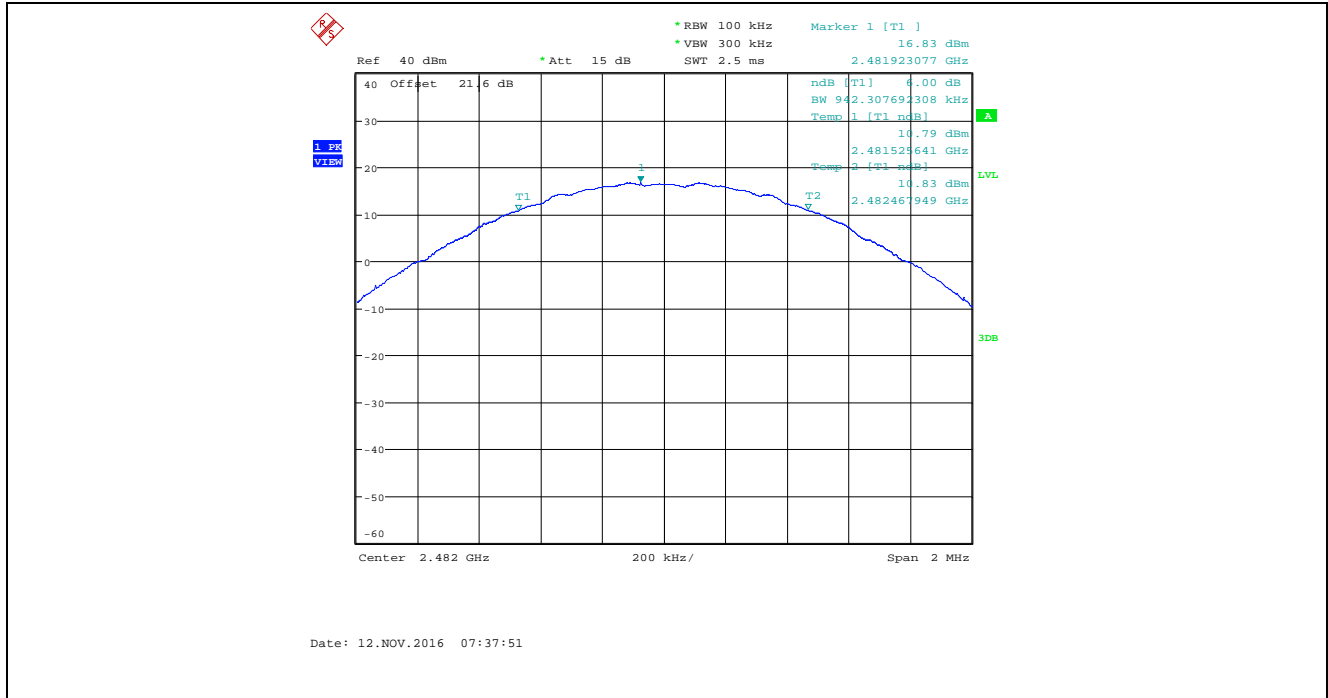

Plot 5.2.4.10. 6 dB Bandwidth, Bandwidth: 2 MHz, TX Gain: 32, Data Rate 2, 2402 MHz

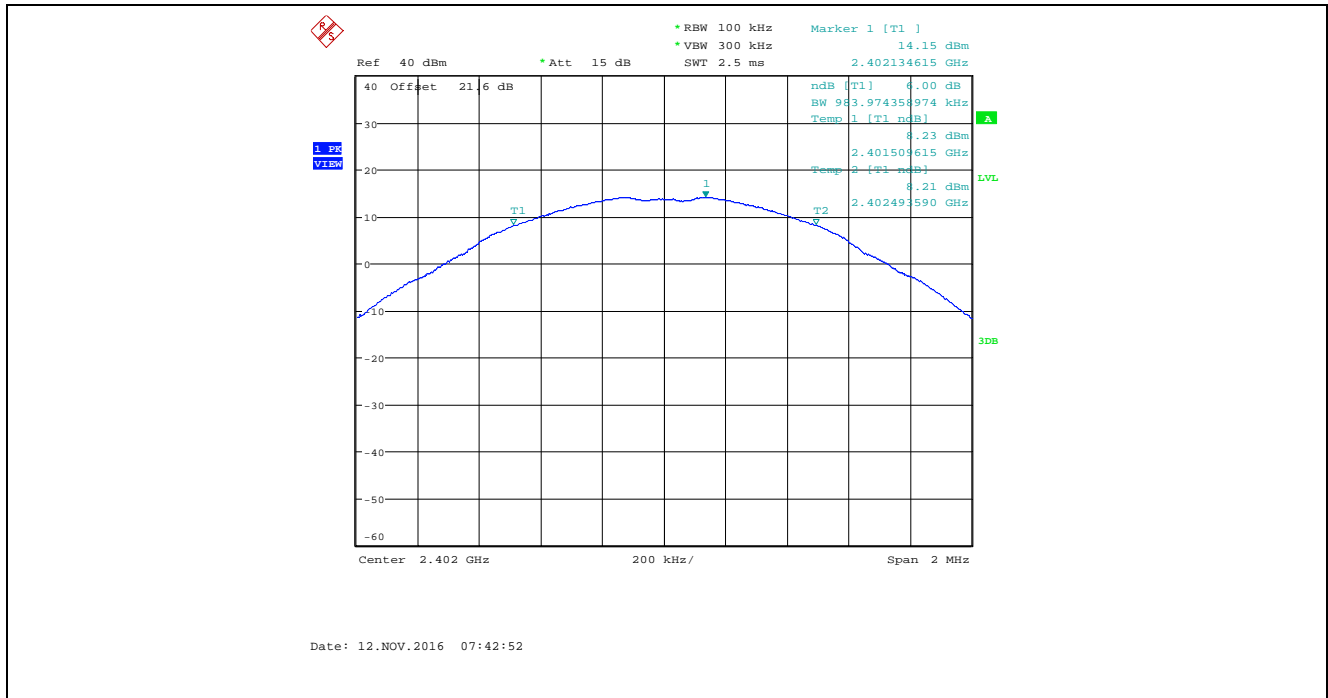



Plot 5.2.4.11. 6 dB Bandwidth, Bandwidth: 2 MHz, TX Gain: 32, Data Rate 2, 2442 MHz

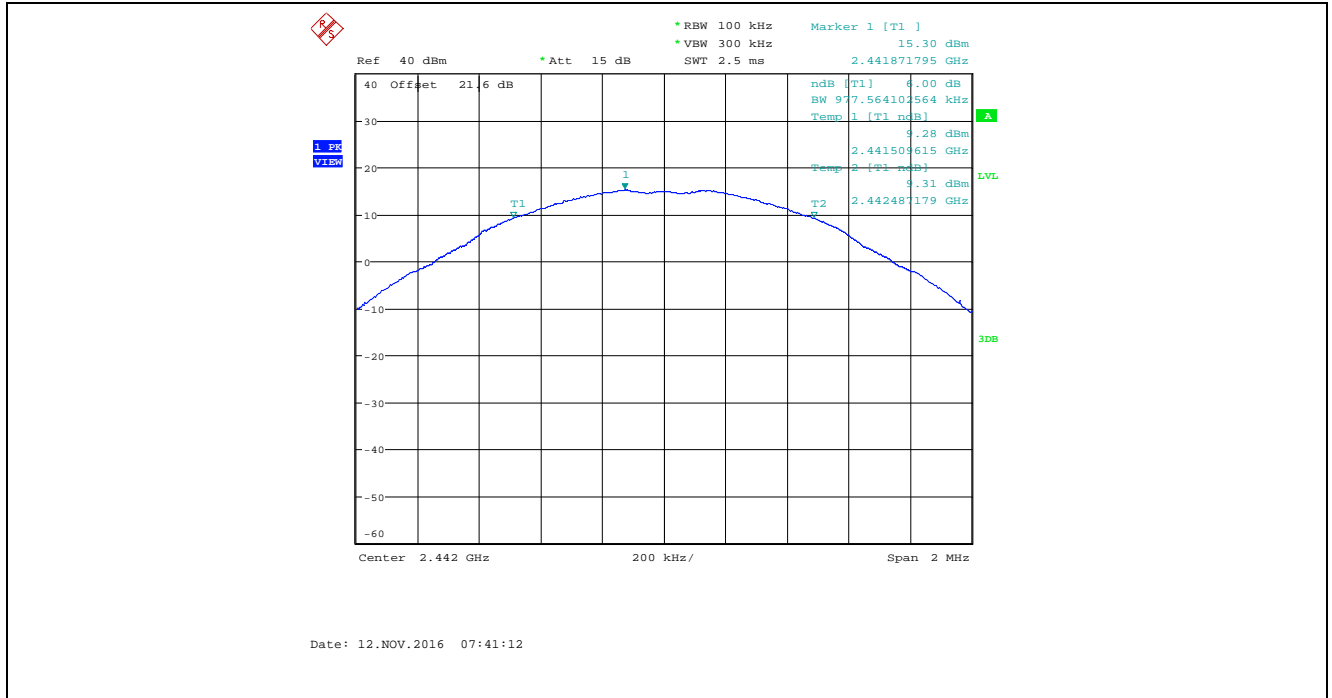

Plot 5.2.4.12. 6 dB Bandwidth, Bandwidth: 2 MHz, TX Gain: 32, Data Rate 2, 2482 MHz

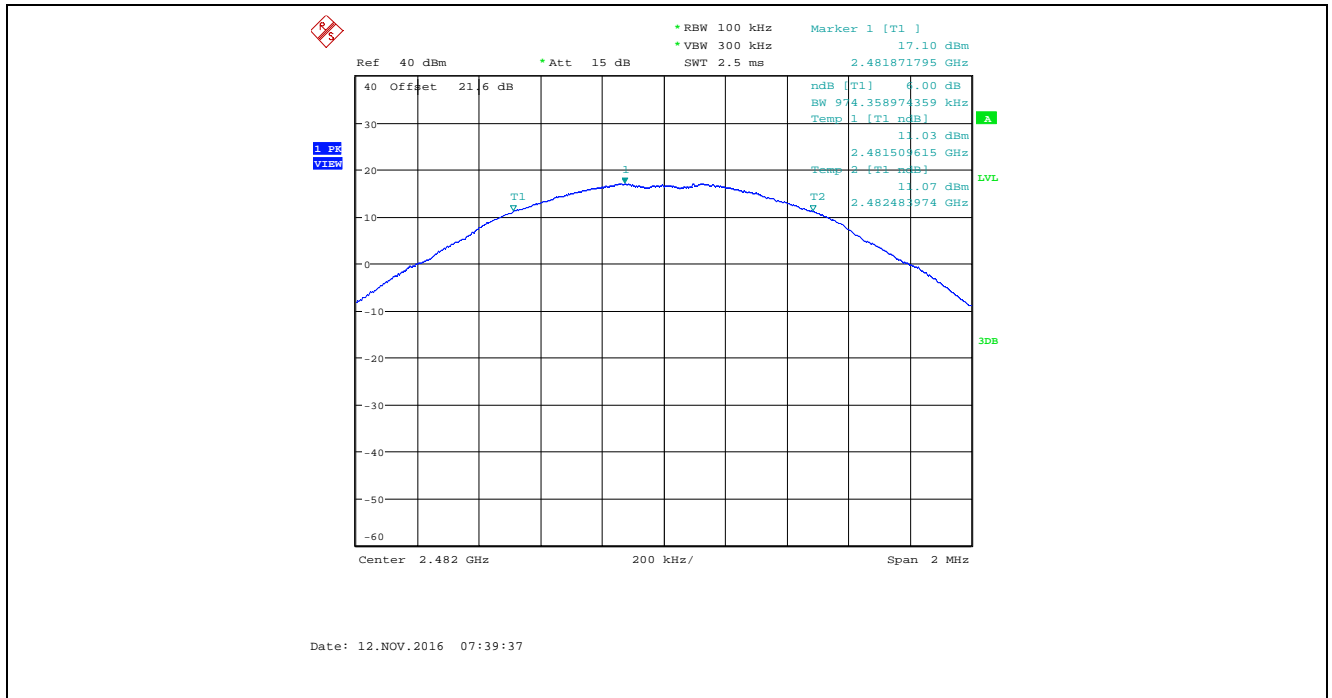

Plot 5.2.4.13. 6 dB Bandwidth, Bandwidth: 2 MHz, TX Gain: 32, Data Rate 3, 2402 MHz

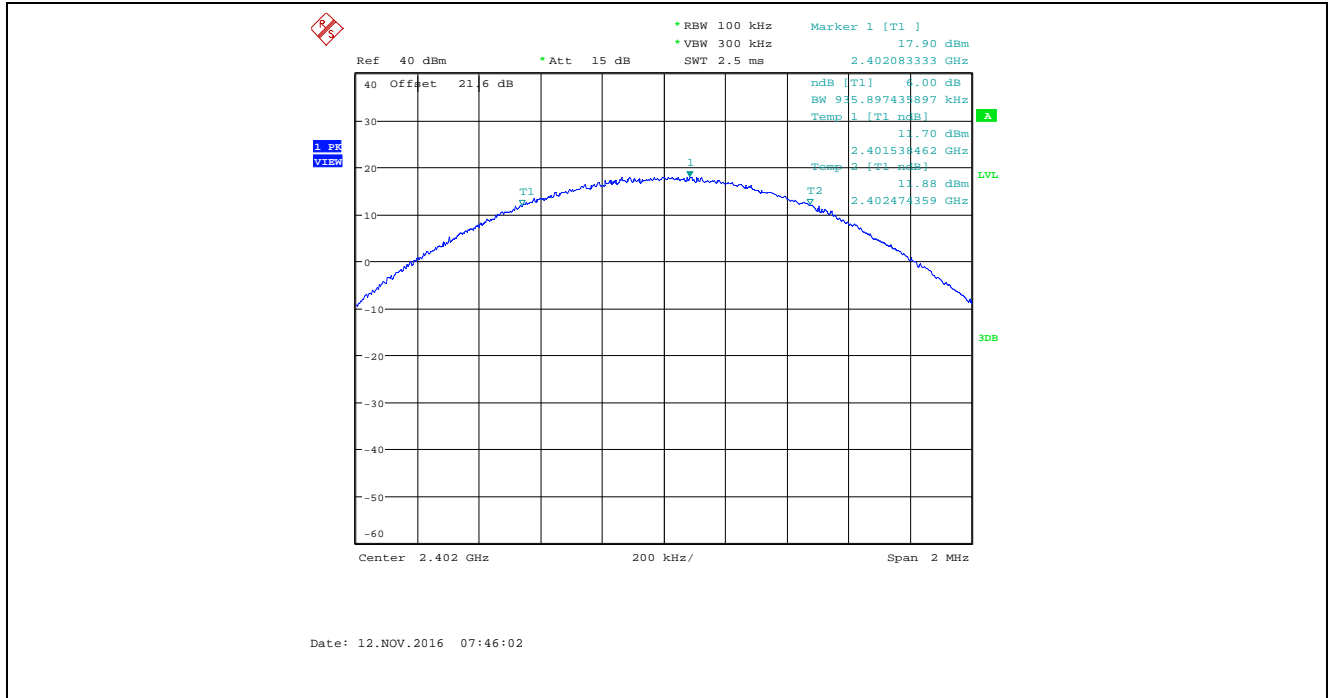

Plot 5.2.4.14. 6 dB Bandwidth, Bandwidth: 2 MHz, TX Gain: 32, Data Rate 3, 2442 MHz

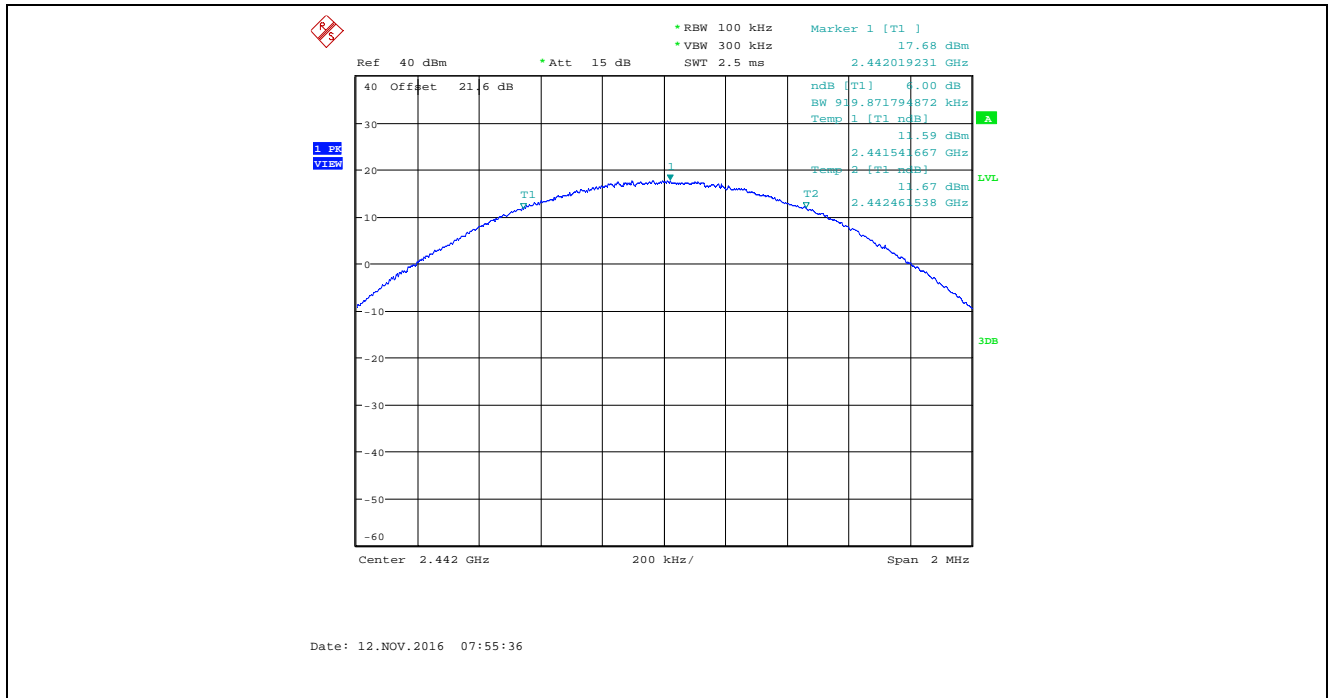

Plot 5.2.4.15. 6 dB Bandwidth, Bandwidth: 2 MHz, TX Gain: 32, Data Rate 3, 2482 MHz

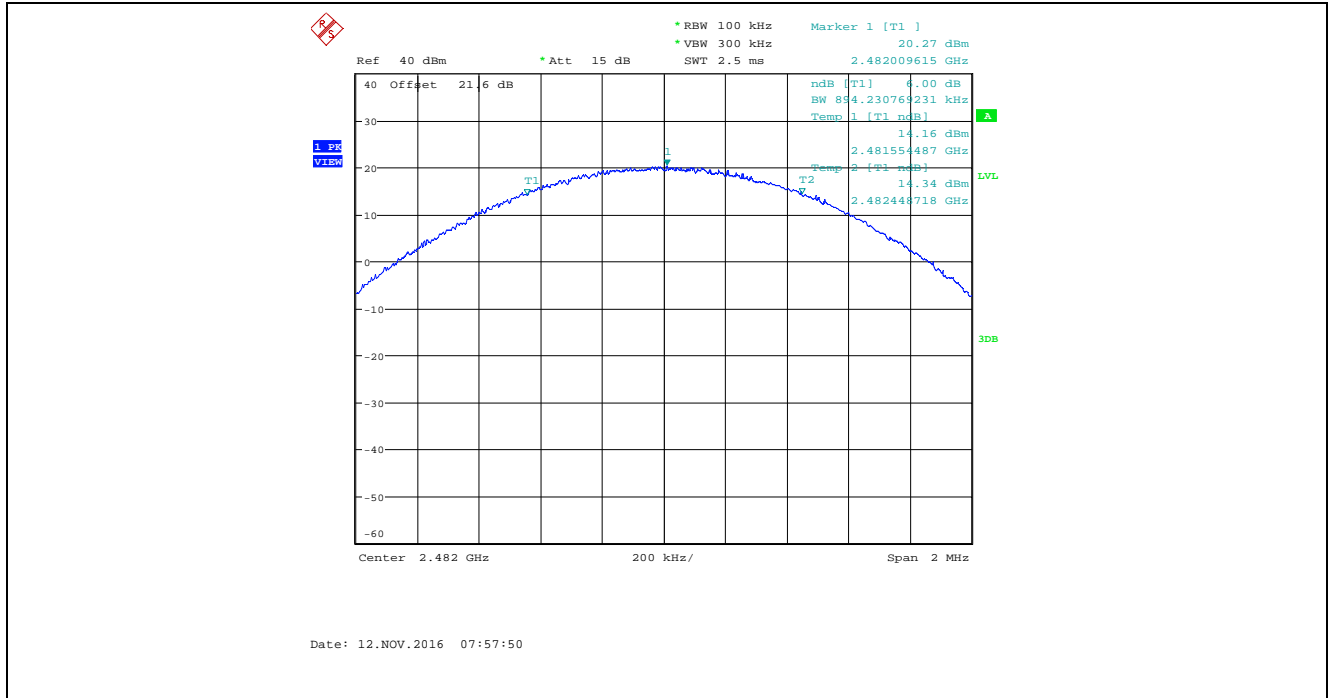

Plot 5.2.4.16. 6 dB Bandwidth, Bandwidth: 4 MHz, TX Gain: 43, Data Rate 1, 2403 MHz

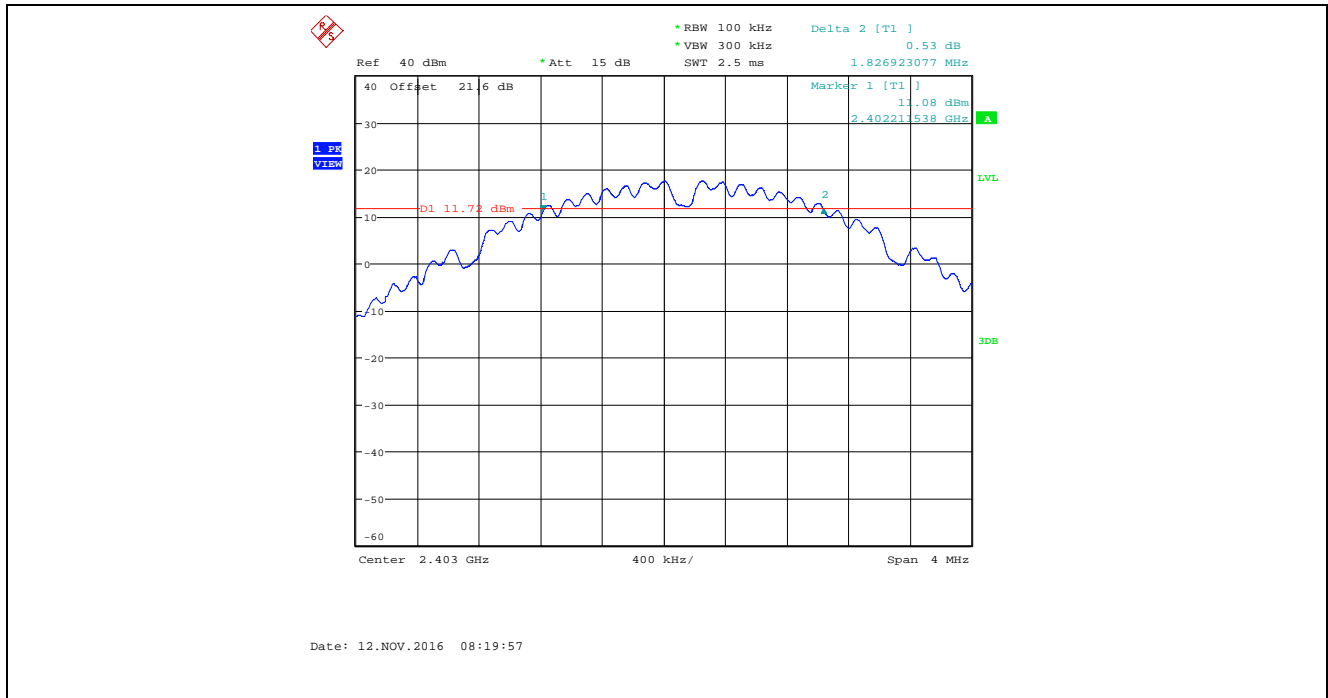

Plot 5.2.4.17. 6 dB Bandwidth, Bandwidth: 4 MHz, TX Gain: 43, Data Rate 1, 2442 MHz

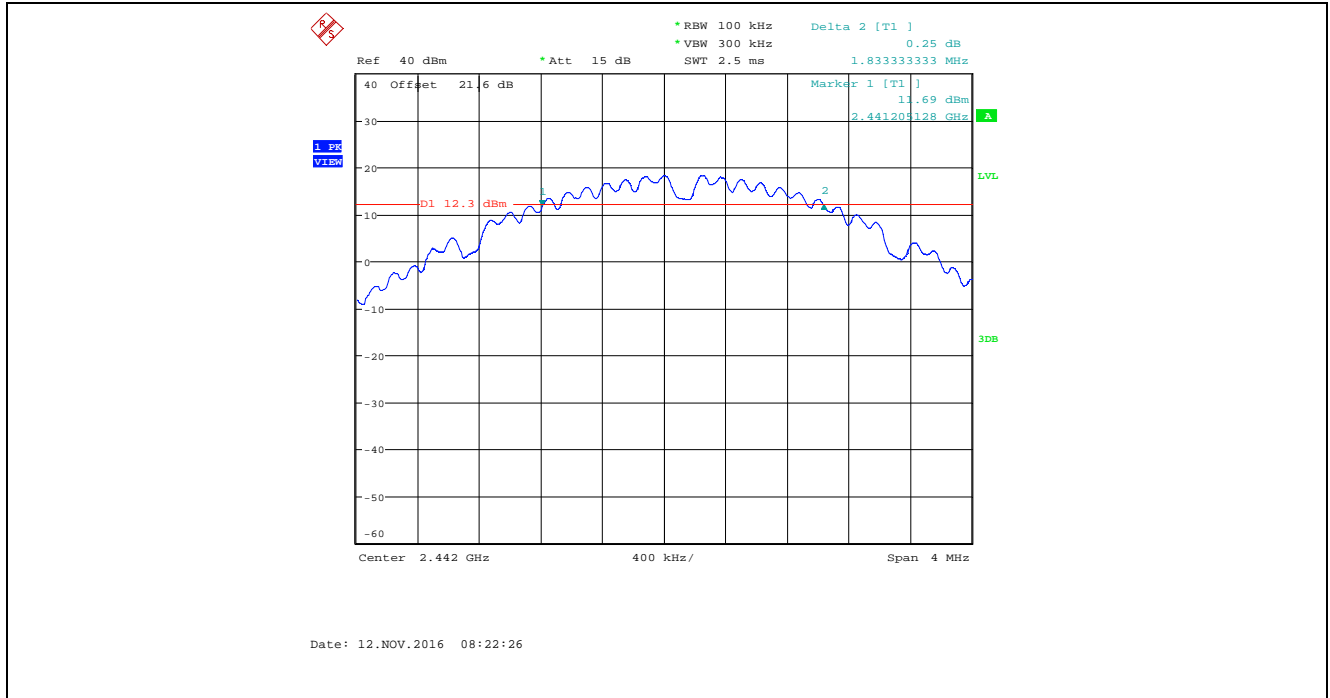

Plot 5.2.4.18. 6 dB Bandwidth, Bandwidth: 4 MHz, TX Gain: 43, Data Rate 1, 2480 MHz

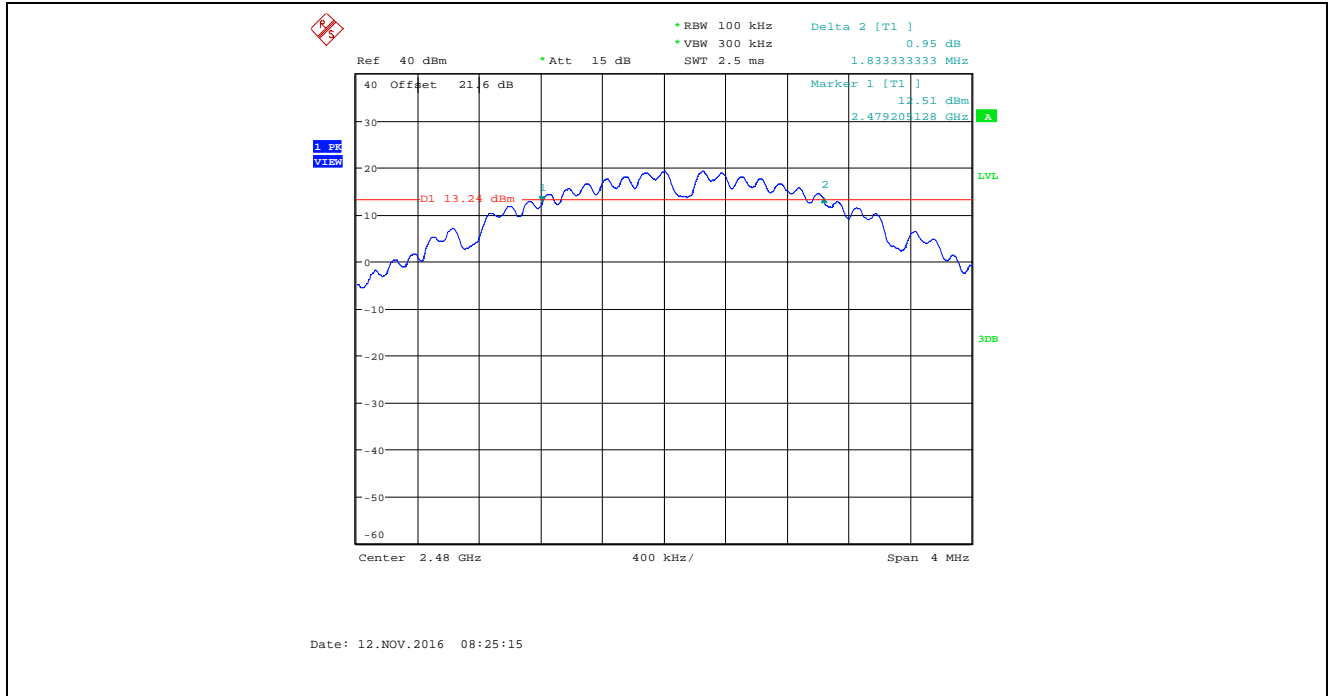

Plot 5.2.4.19. 6 dB Bandwidth, Bandwidth: 4 MHz, TX Gain: 43, Data Rate 2, 2403 MHz

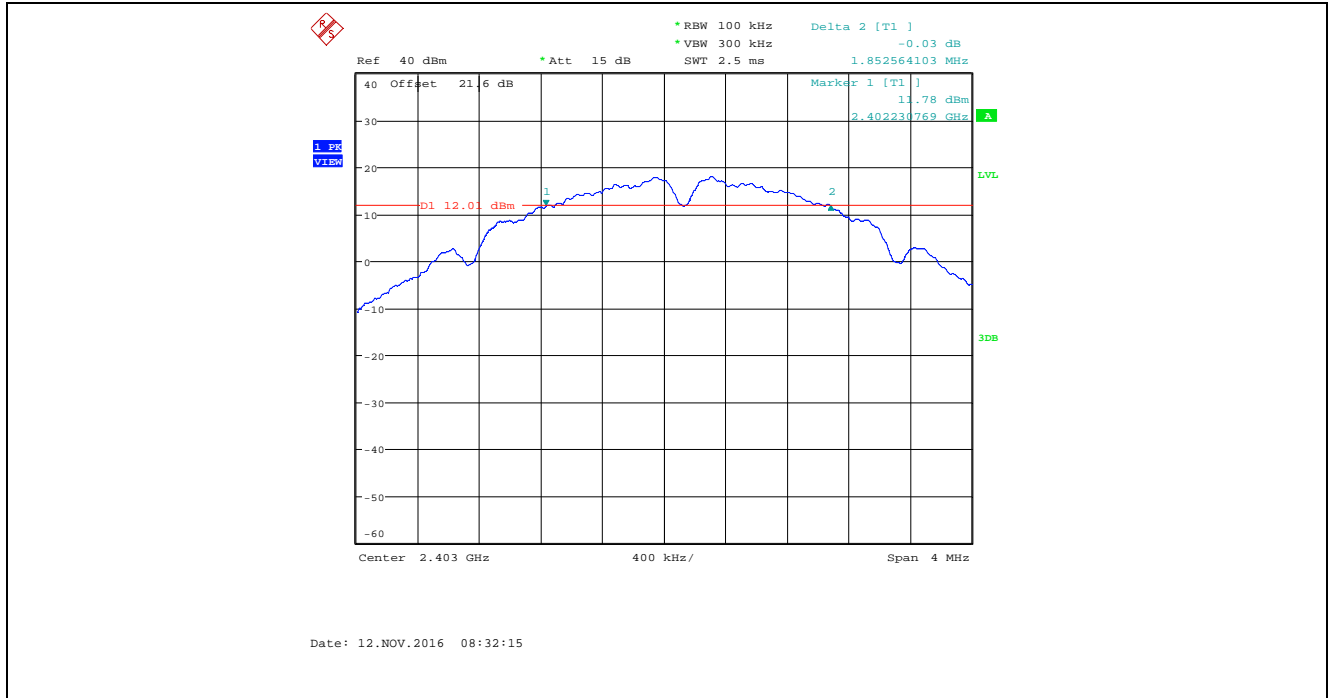

Plot 5.2.4.20. 6 dB Bandwidth, Bandwidth: 4 MHz, TX Gain: 43, Data Rate 2, 2442 MHz

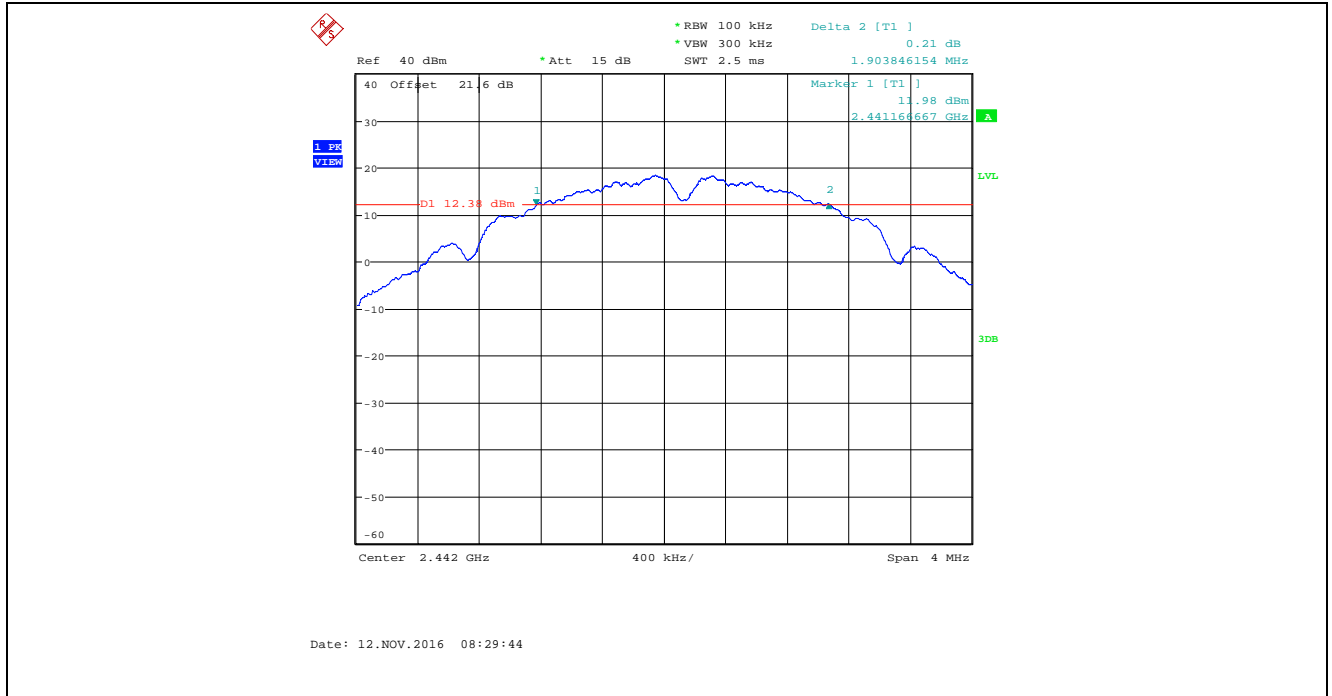

Plot 5.2.4.21. 6 dB Bandwidth, Bandwidth: 4 MHz, TX Gain: 43, Data Rate 2, 2480 MHz

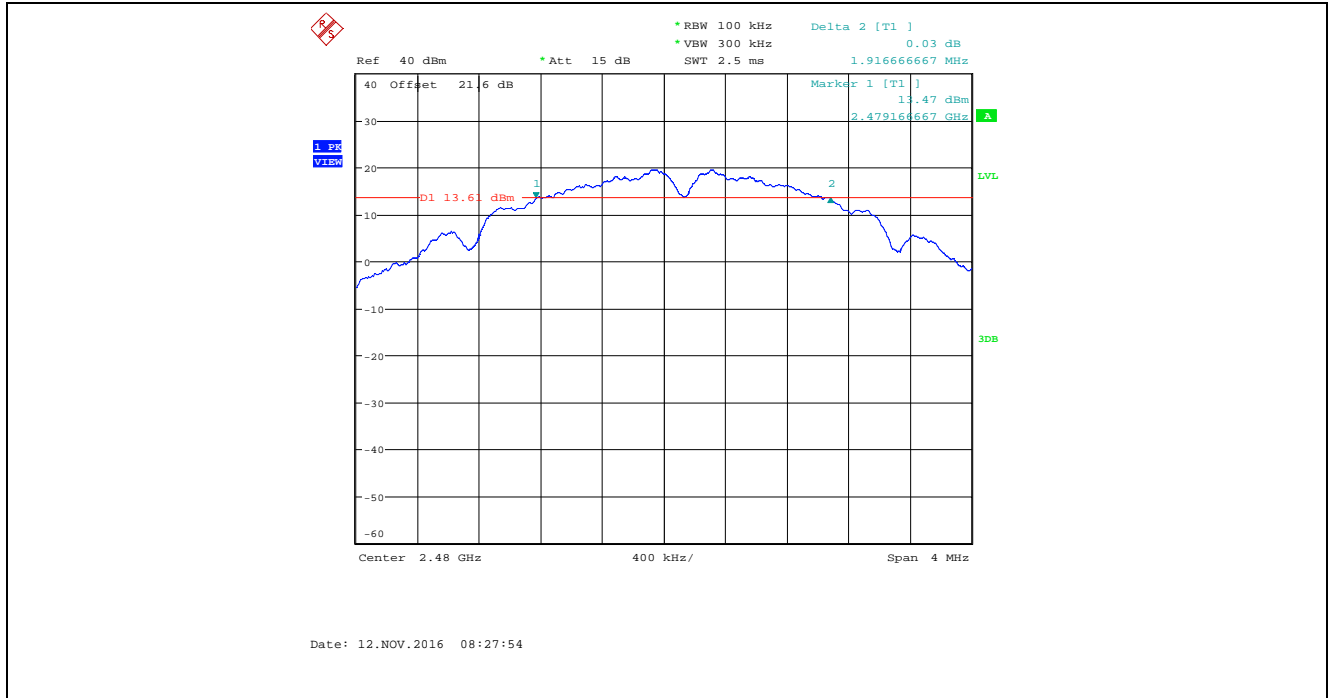

Plot 5.2.4.22. 6 dB Bandwidth, Bandwidth: 4 MHz, TX Gain: 43, Data Rate 3, 2403 MHz

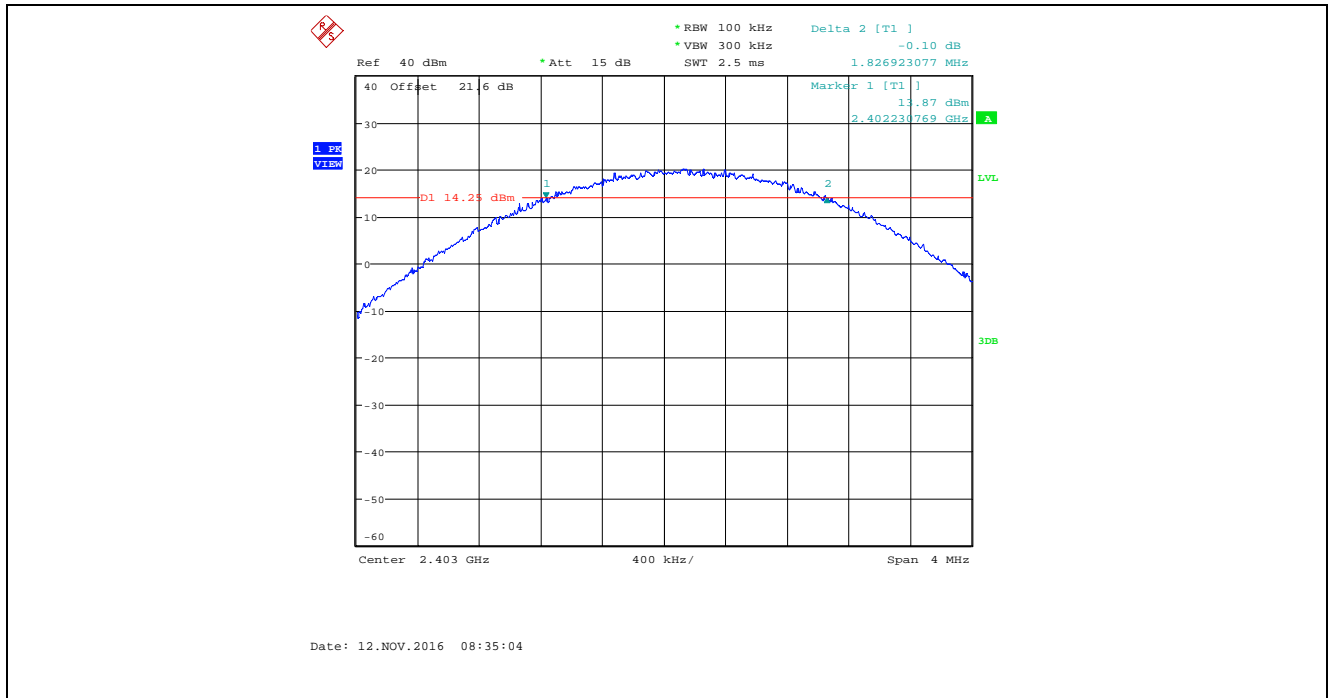

Plot 5.2.4.23. 6 dB Bandwidth, Bandwidth: 4 MHz, TX Gain: 43, Data Rate 3, 2442 MHz

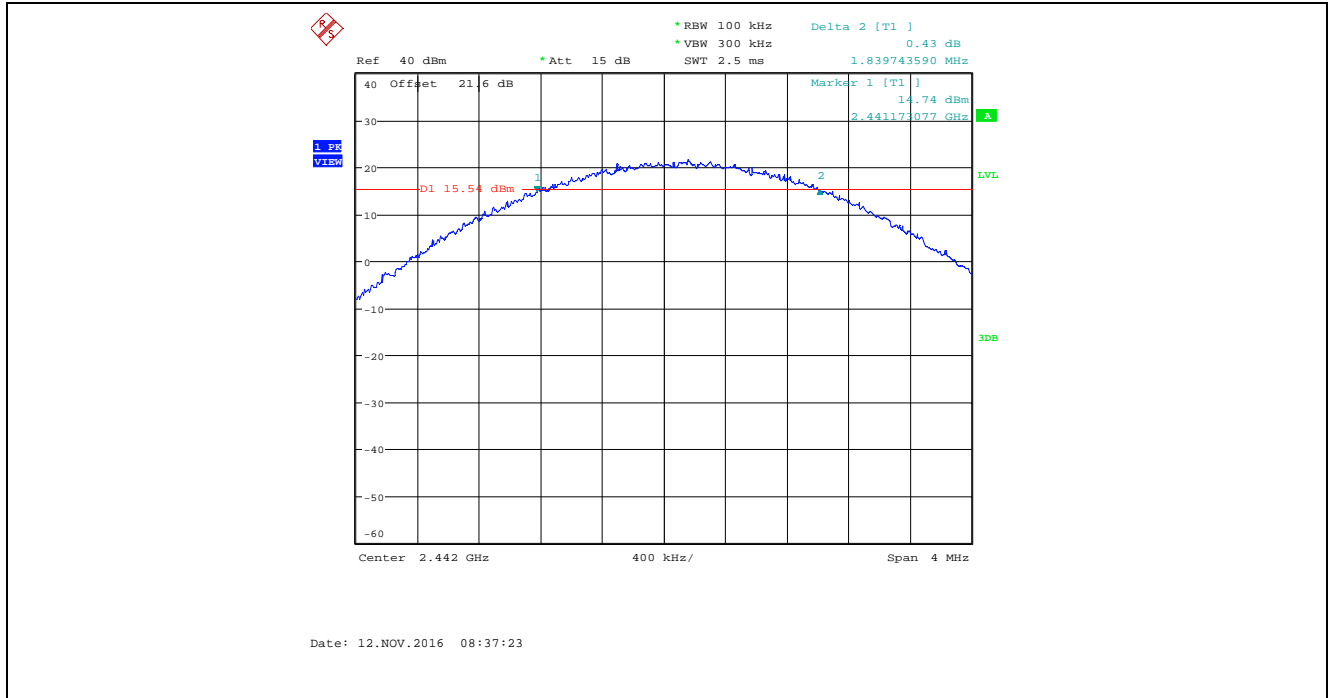

Plot 5.2.4.24. 6 dB Bandwidth, Bandwidth: 4 MHz, TX Gain: 43, Data Rate 3, 2480 MHz

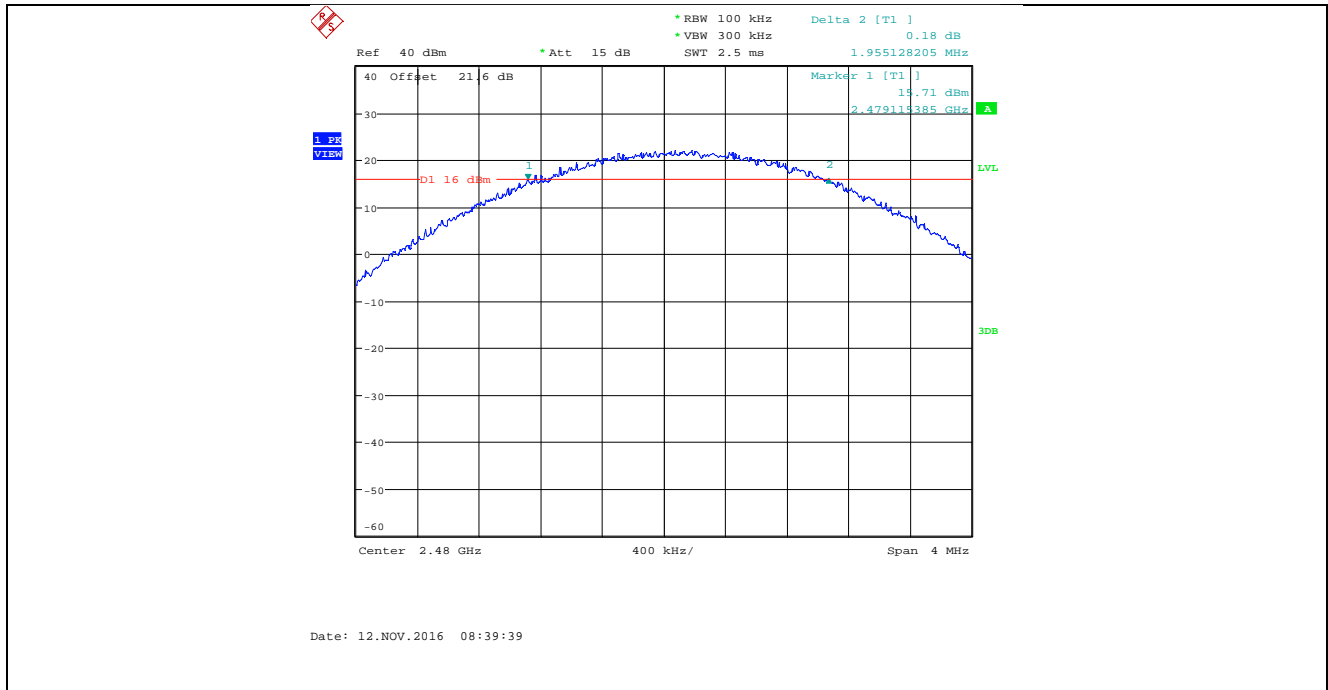

Plot 5.2.4.25. 6 dB Bandwidth, Bandwidth: 8 MHz, TX Gain: 50, Data Rate 1, 2407 MHz

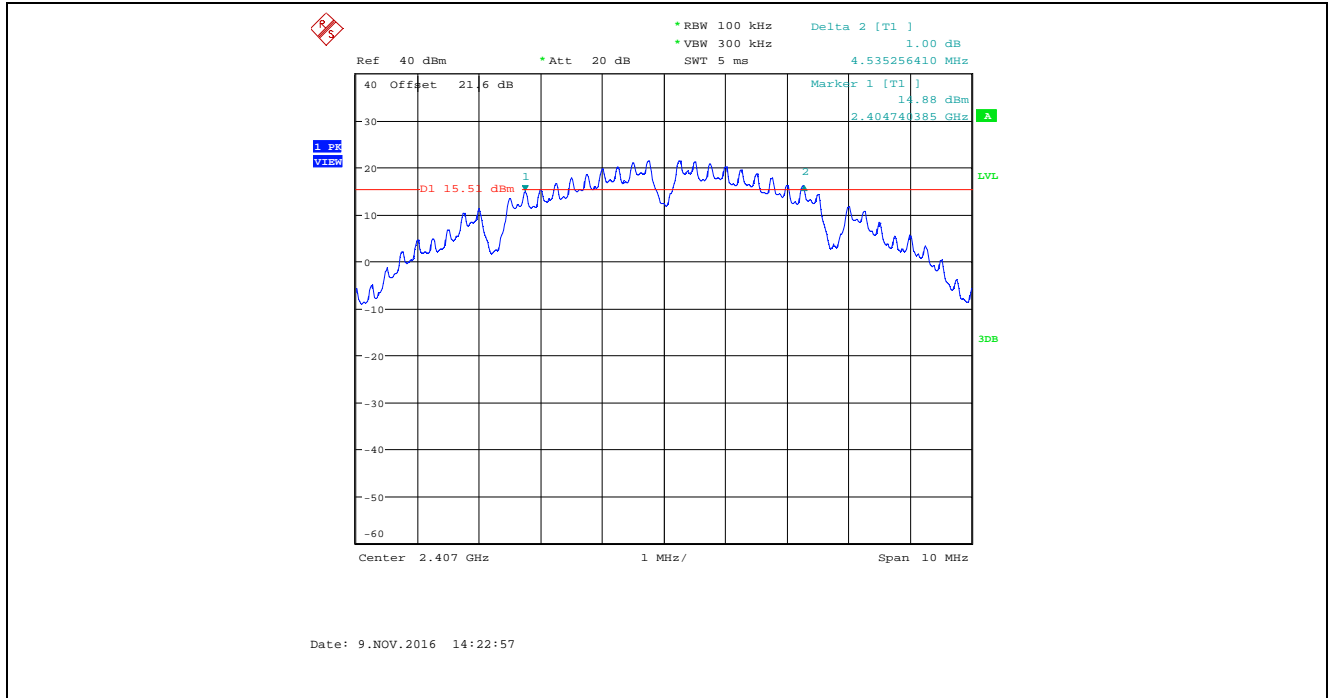

Plot 5.2.4.26. 6 dB Bandwidth, Bandwidth: 8 MHz, TX Gain: 50, Data Rate 1, 2442 MHz

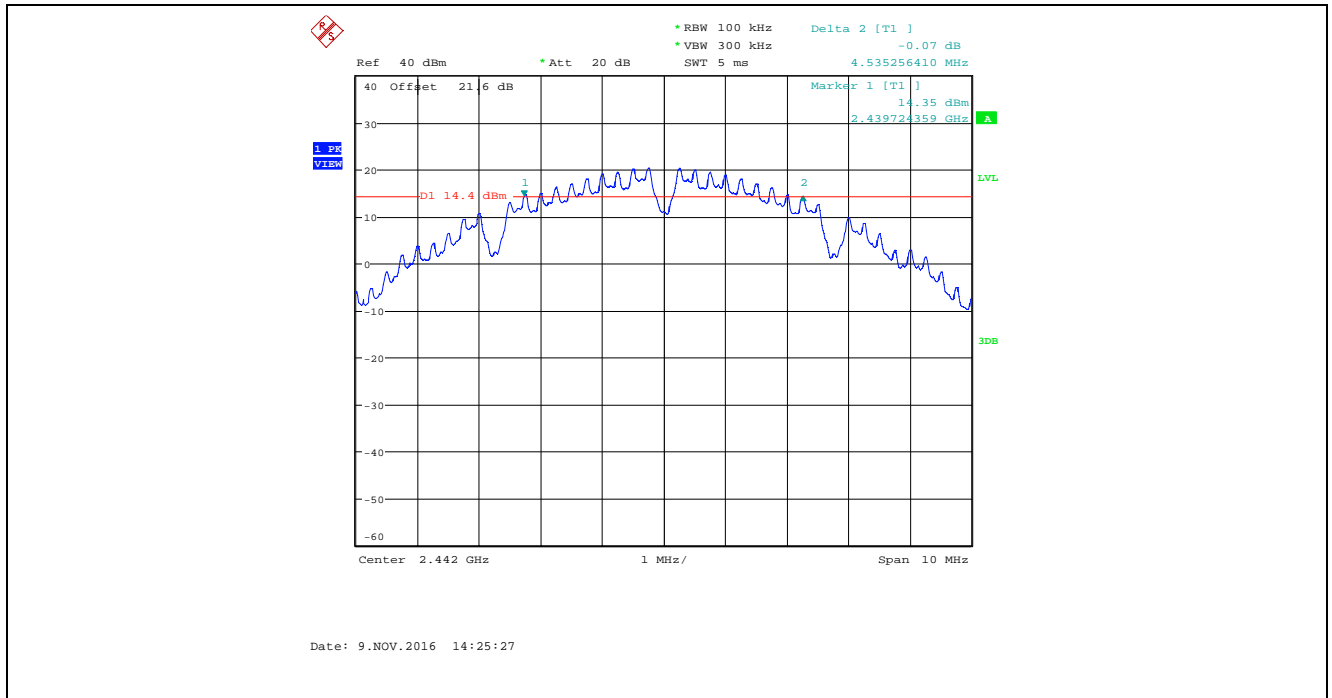



Plot 5.2.4.27. 6 dB Bandwidth, Bandwidth: 8 MHz, TX Gain: 50, Data Rate 1, 2477 MHz

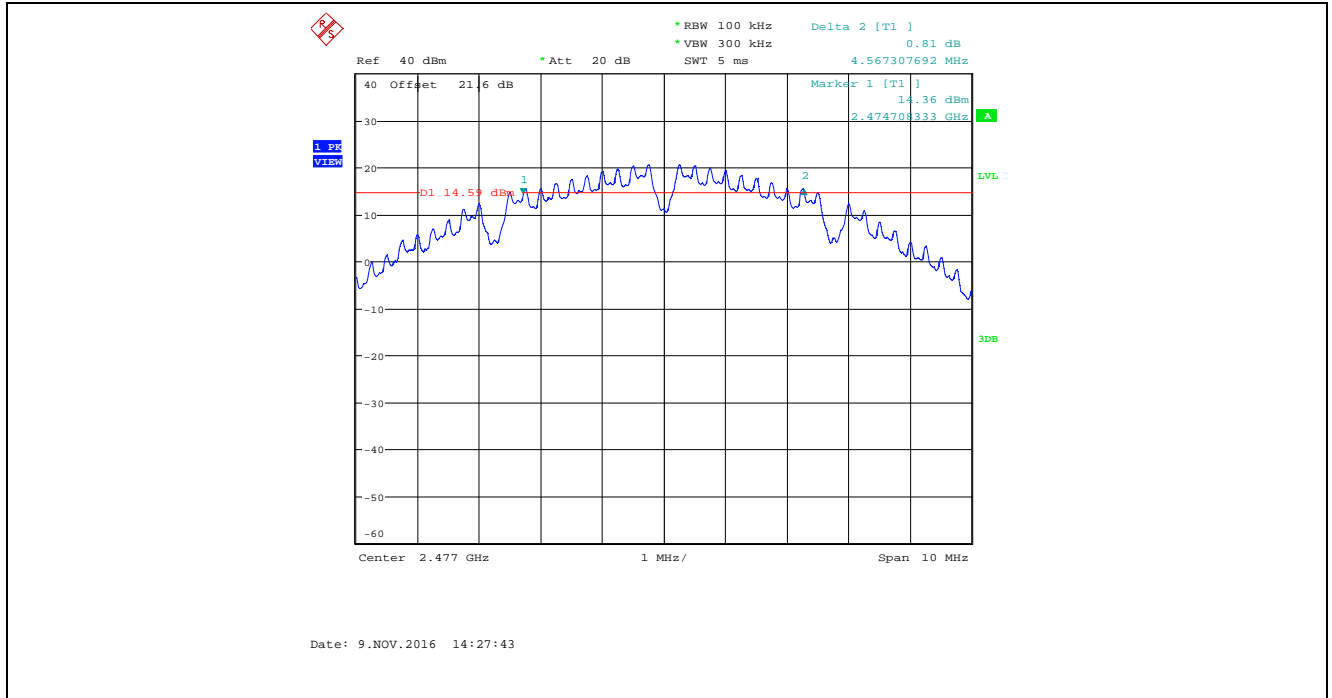

Plot 5.2.4.28. 6 dB Bandwidth, Bandwidth: 8 MHz, TX Gain: 50, Data Rate 2, 2407 MHz

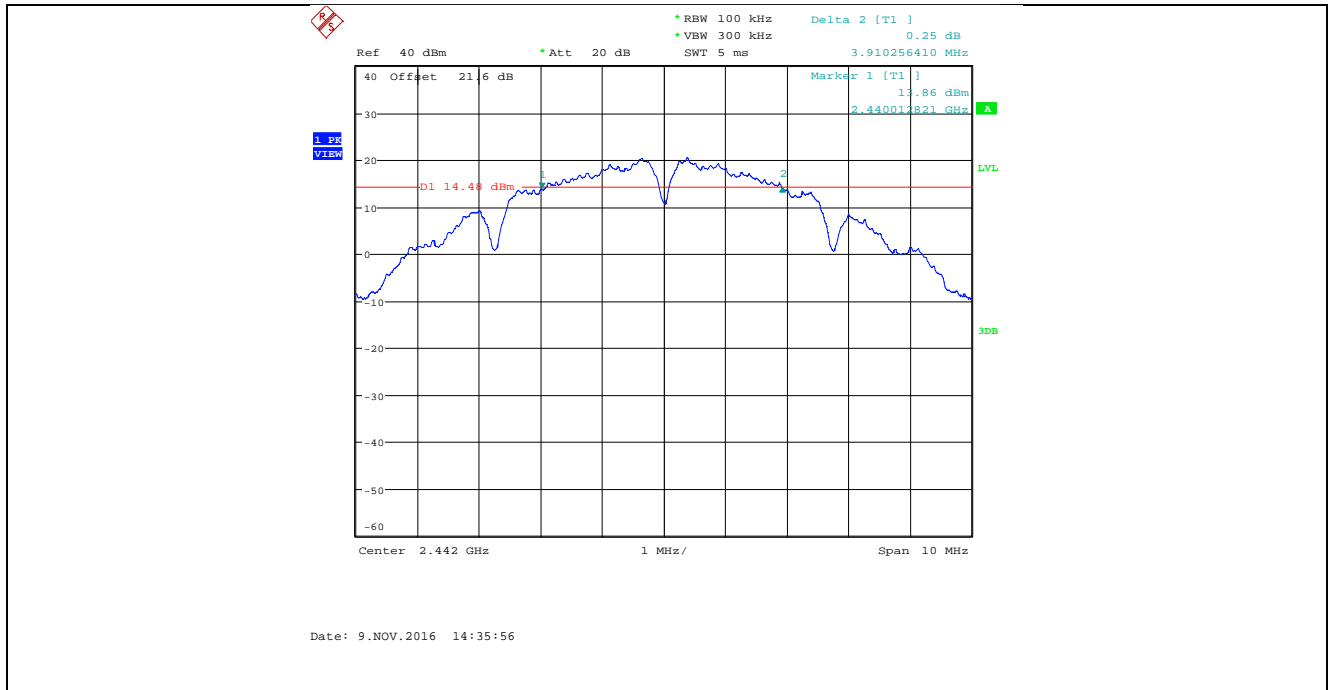

Plot 5.2.4.29. 6 dB Bandwidth, Bandwidth: 8 MHz, TX Gain: 50, Data Rate 2, 2442 MHz

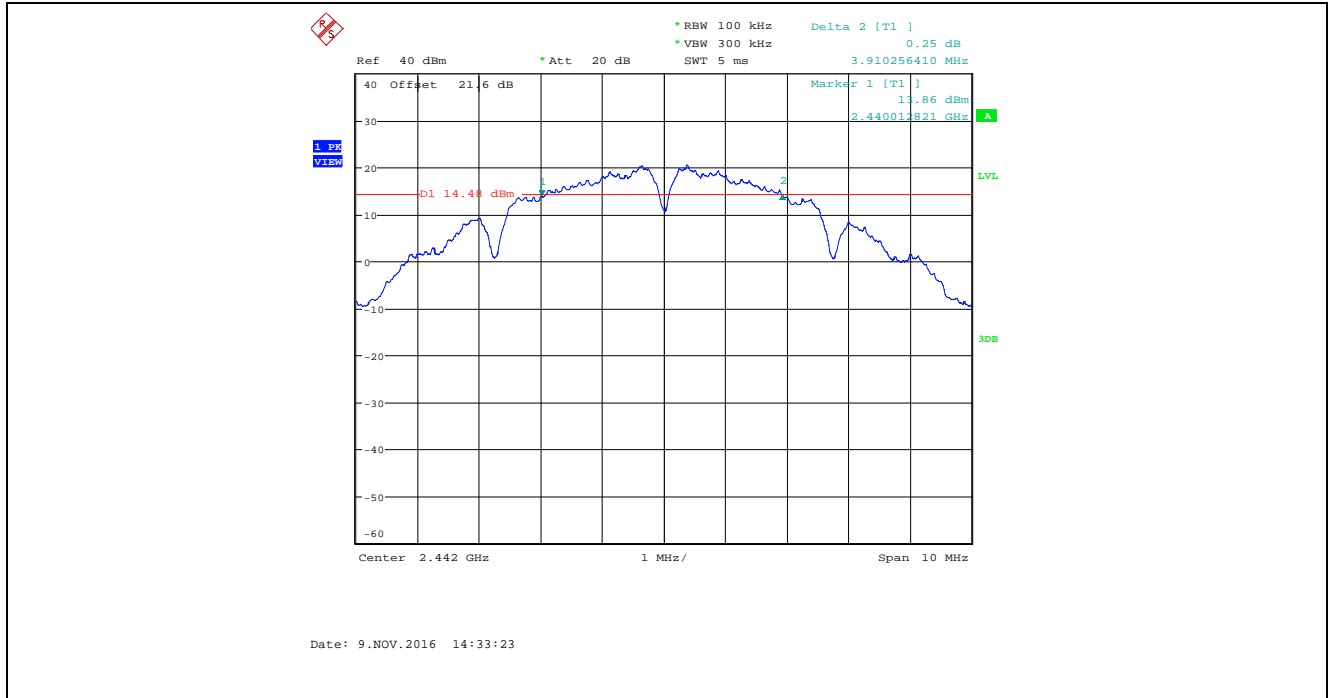

Plot 5.2.4.30. 6 dB Bandwidth, Bandwidth: 8 MHz, TX Gain: 50, Data Rate 2, 2477 MHz

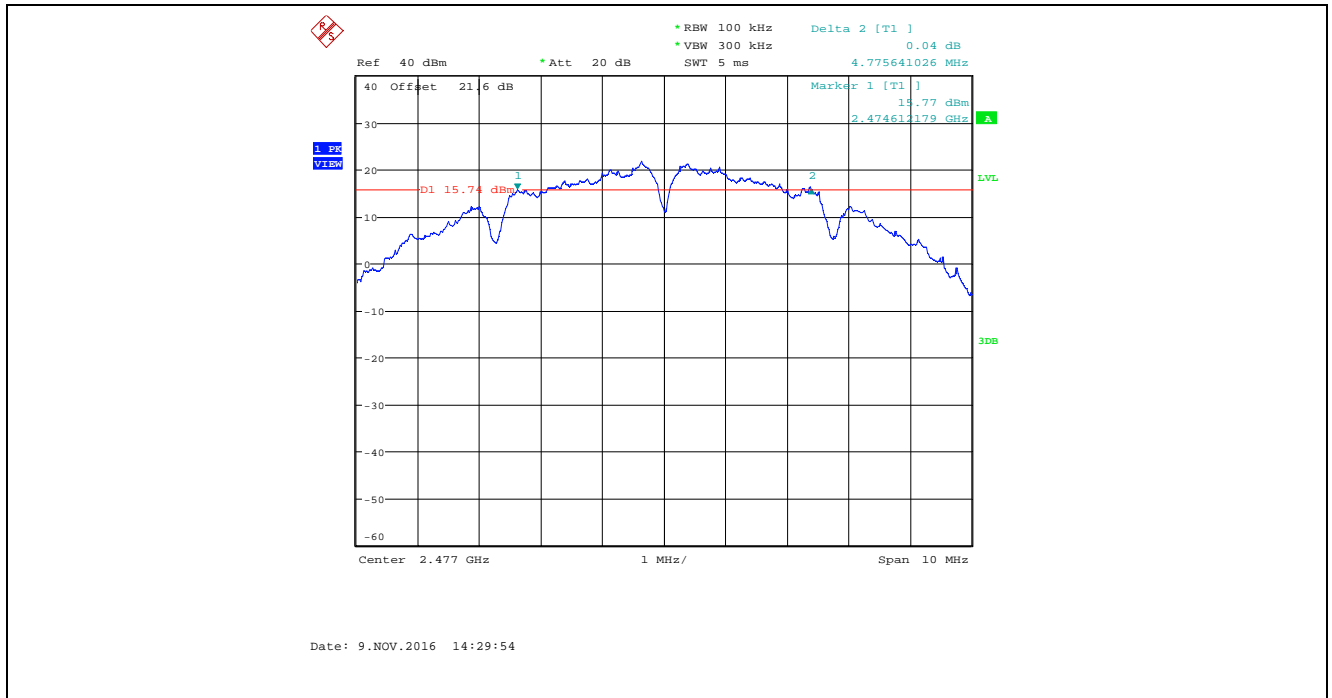

Plot 5.2.4.31. 6 dB Bandwidth, Bandwidth: 8 MHz, TX Gain: 50, Data Rate 3, 2407 MHz

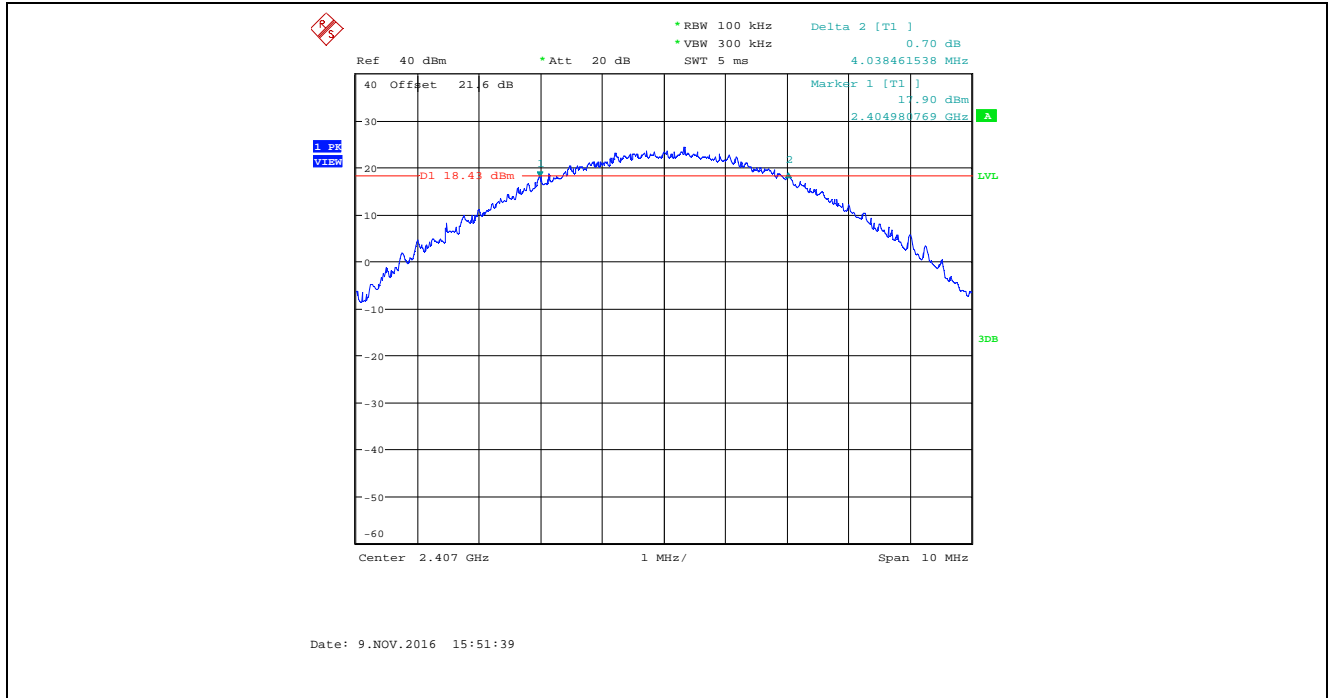

Plot 5.2.4.32. 6 dB Bandwidth, Bandwidth: 8 MHz, TX Gain: 50, Data Rate 3, 2442 MHz

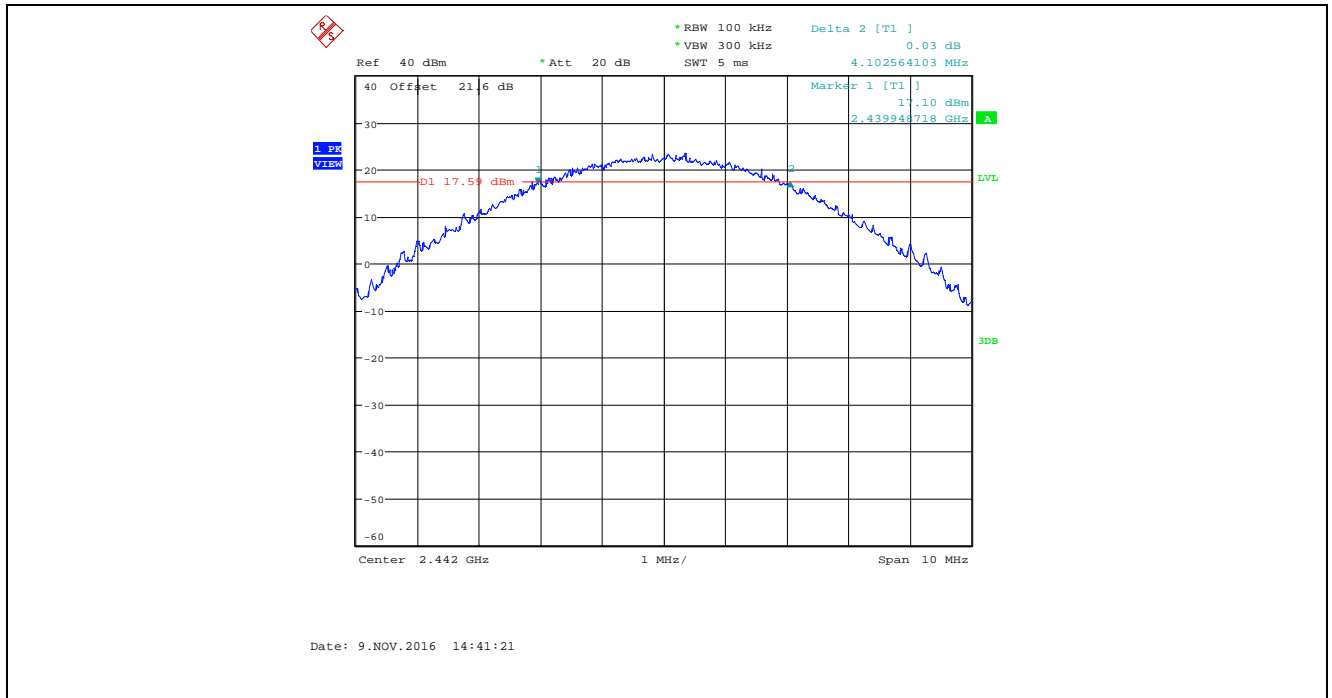

Plot 5.2.4.33. 6 dB Bandwidth, Bandwidth: 8 MHz, TX Gain: 50, Data Rate 3, 2477 MHz

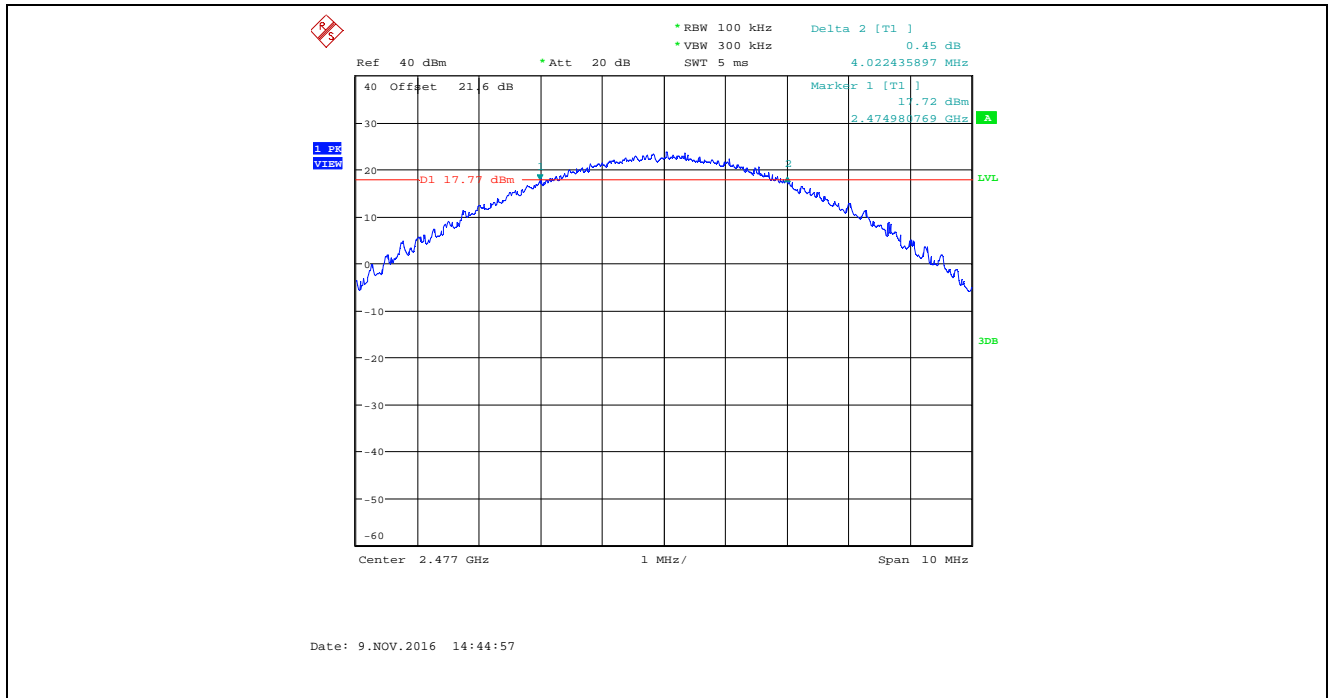

Plot 5.2.4.34. 6 dB Bandwidth, Bandwidth: 1 MHz, TX Gain: 43, Data Rate 4, 2402 MHz

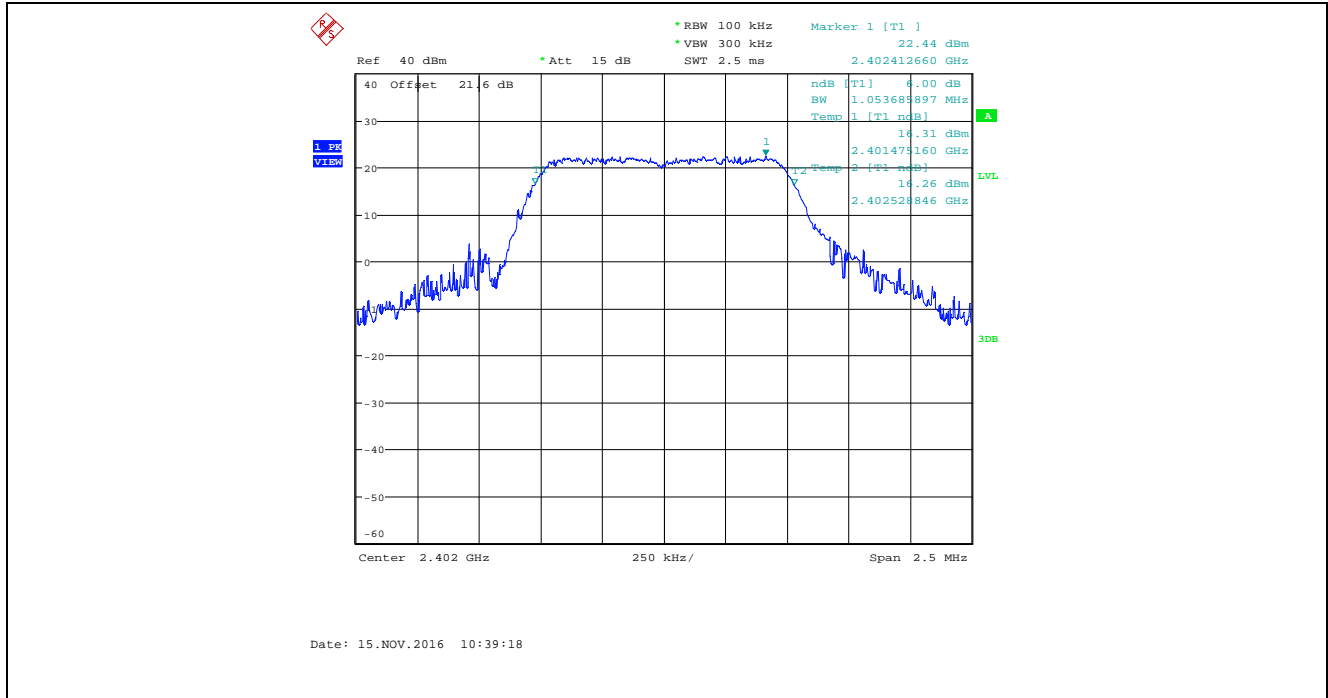

Plot 5.2.4.35. 6 dB Bandwidth, Bandwidth: 1 MHz, TX Gain: 43, Data Rate 4, 2442 MHz

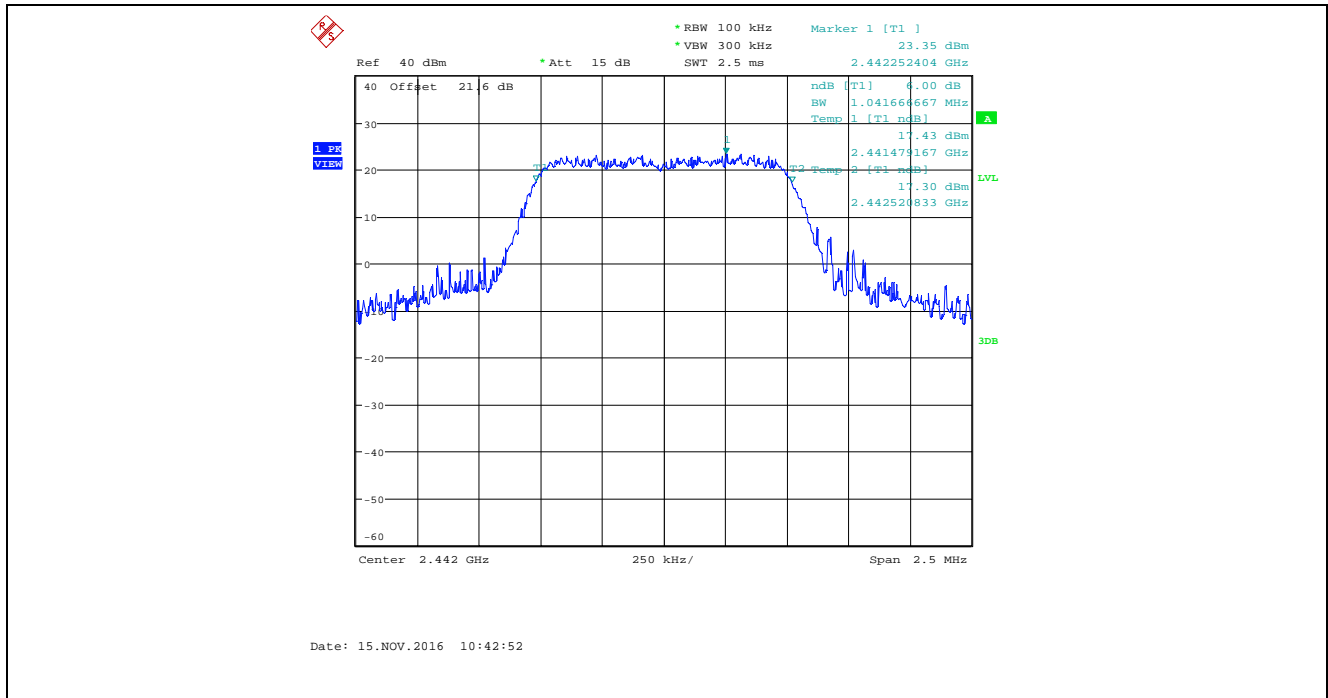

Plot 5.2.4.36. 6 dB Bandwidth, Bandwidth: 1 MHz, TX Gain: 43, Data Rate 4, 2482 MHz

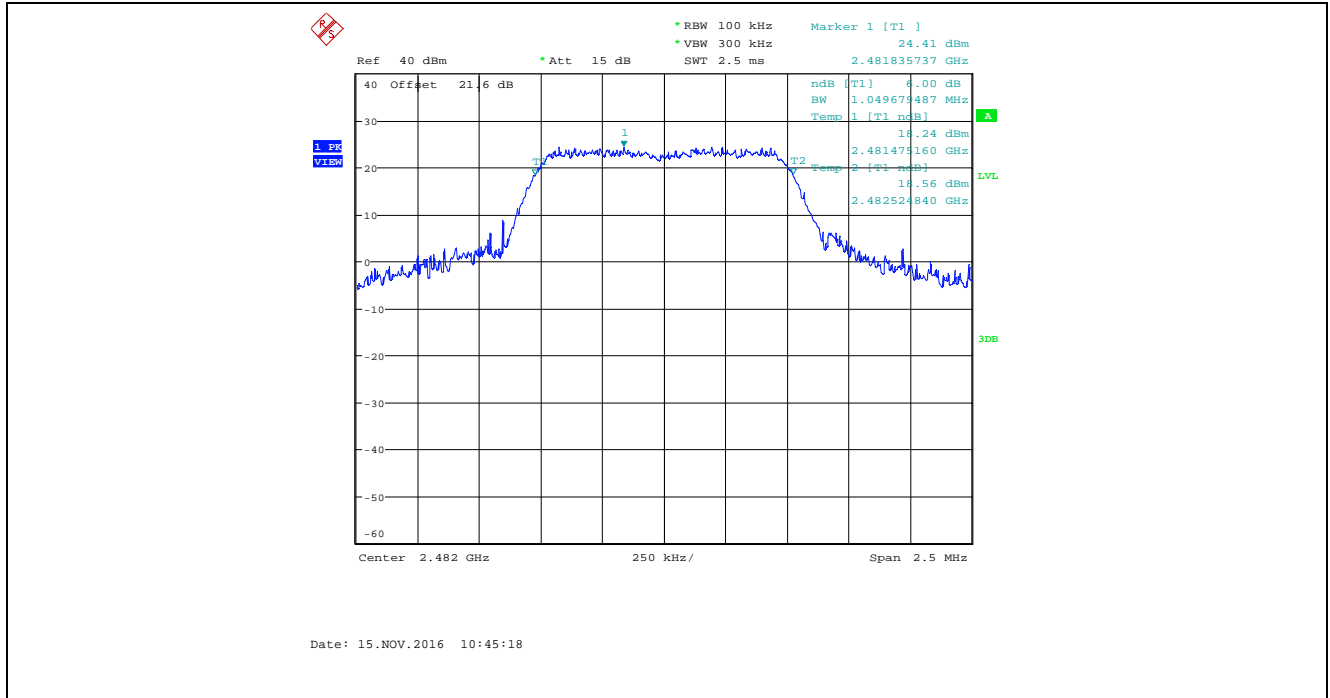

Plot 5.2.4.37. 6 dB Bandwidth, Bandwidth: 1 MHz, TX Gain: 43, Data Rate 5, 2402 MHz

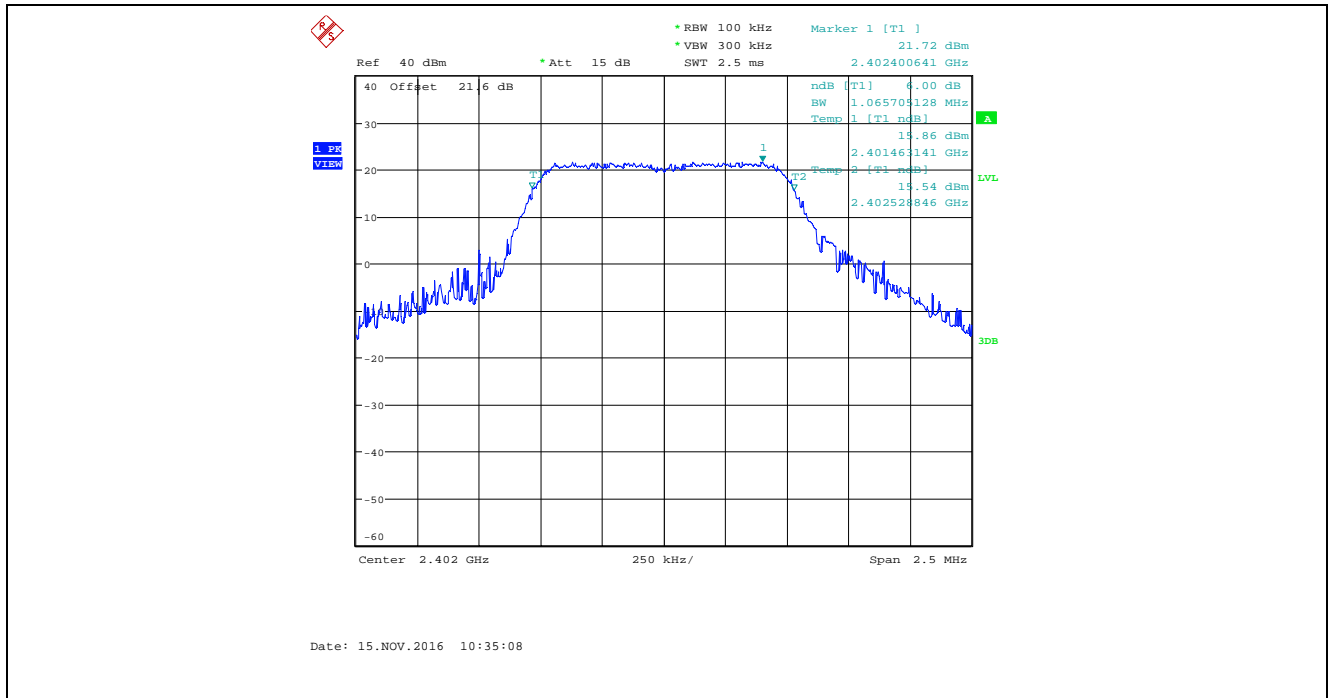

Plot 5.2.4.38. 6 dB Bandwidth, Bandwidth: 1 MHz, TX Gain: 43, Data Rate 5, 2442 MHz

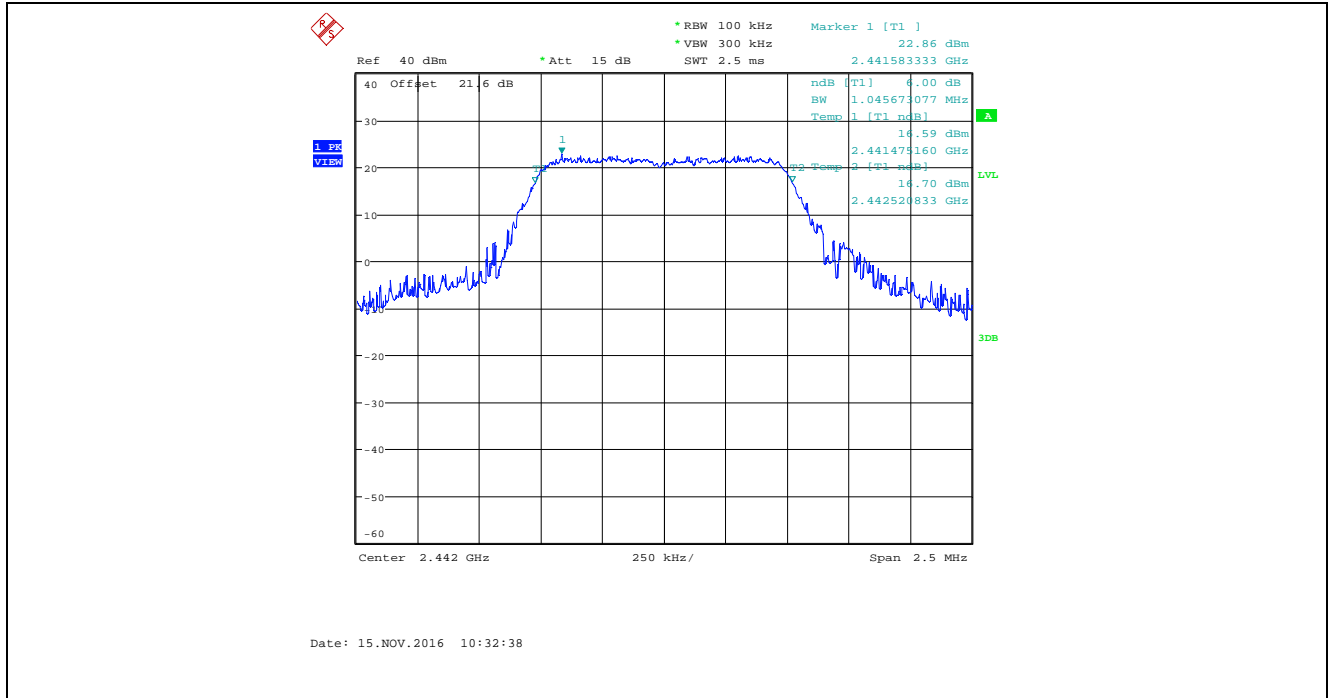

Plot 5.2.4.39. 6 dB Bandwidth, Bandwidth: 1 MHz, TX Gain: 43, Data Rate 5, 2482 MHz

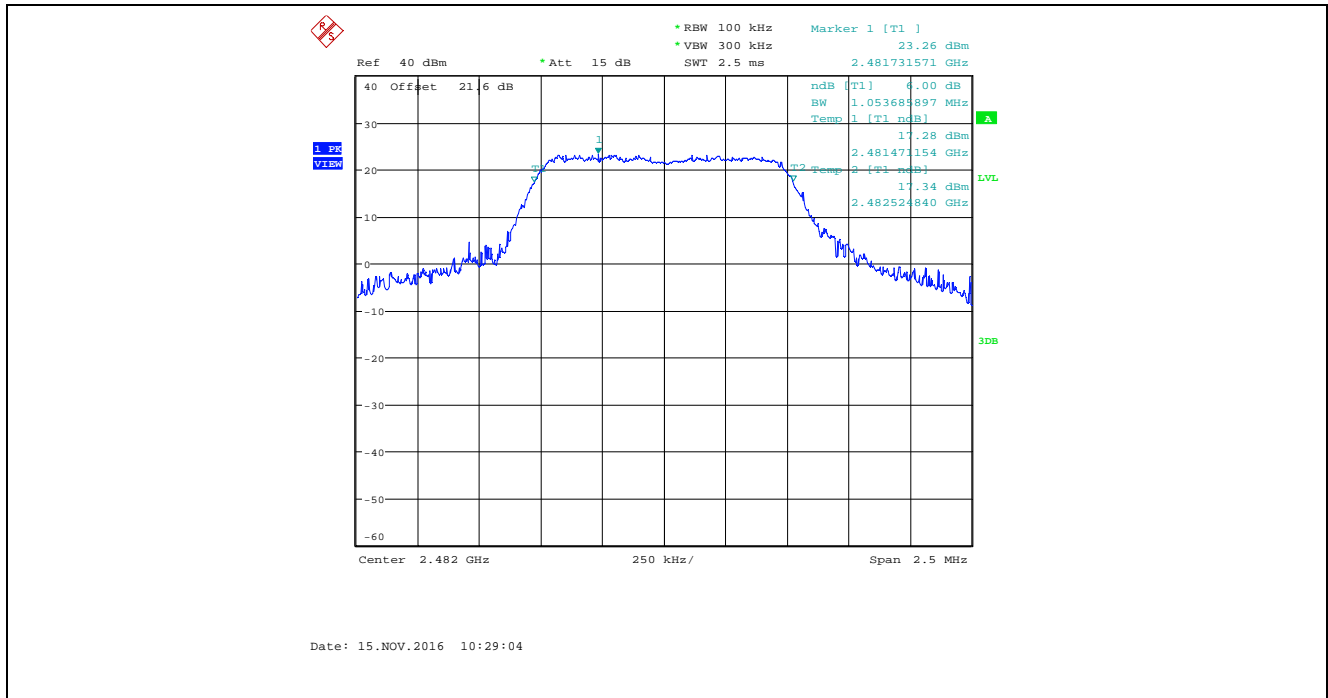

Plot 5.2.4.40. 6 dB Bandwidth, Bandwidth: 1 MHz, TX Gain: 43, Data Rate 6, 2402 MHz

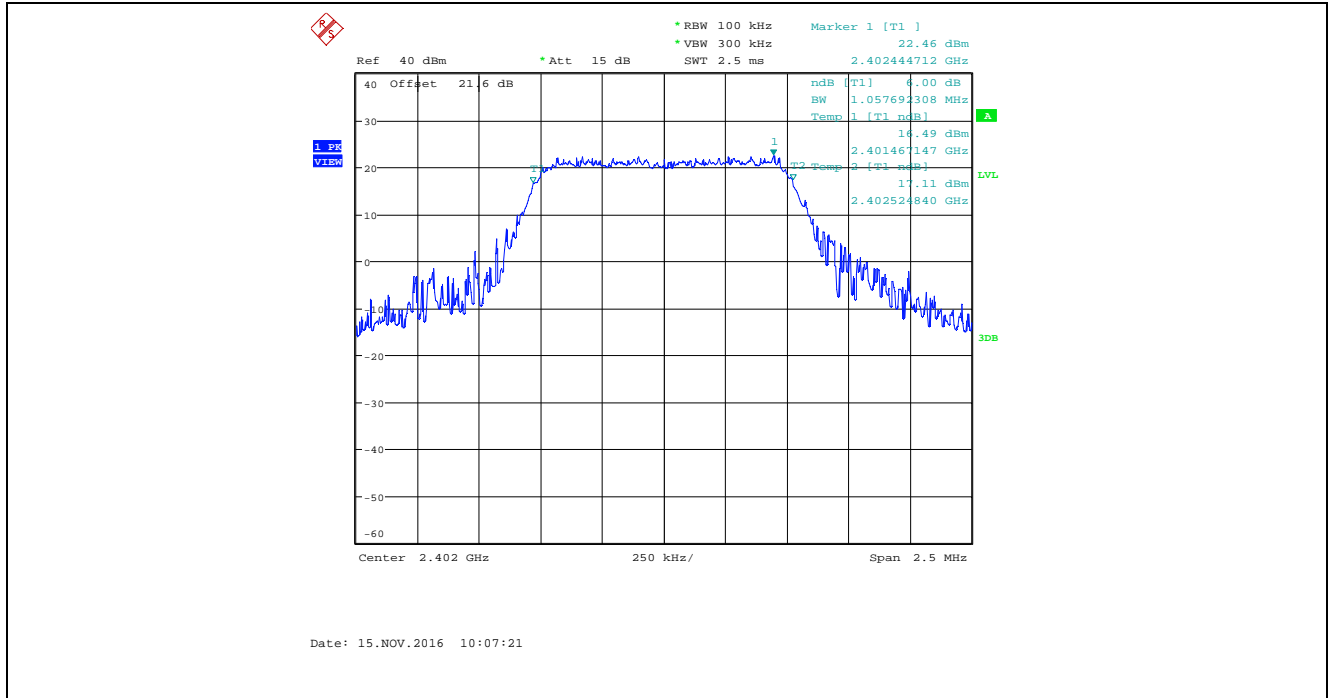

Plot 5.2.4.41. 6 dB Bandwidth, Bandwidth: 1 MHz, TX Gain: 43, Data Rate 6, 2442 MHz

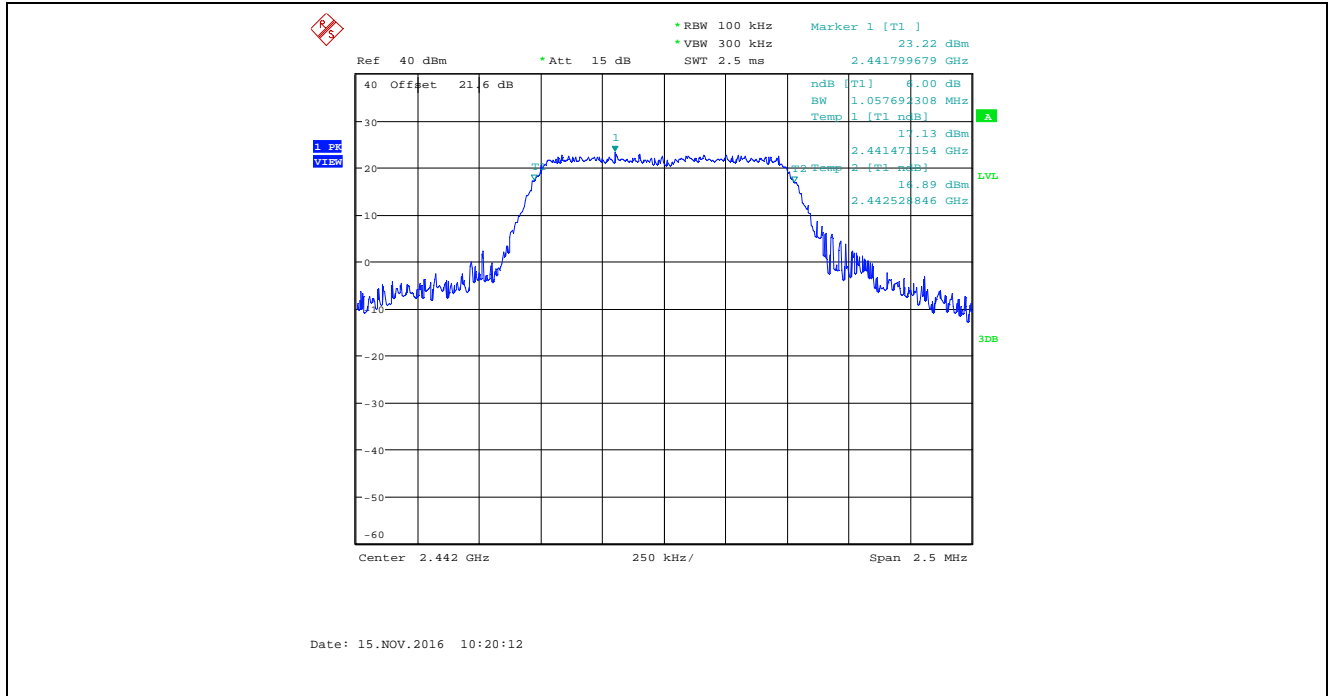



Plot 5.2.4.42. 6 dB Bandwidth, Bandwidth: 1 MHz, TX Gain: 43, Data Rate 6, 2482 MHz

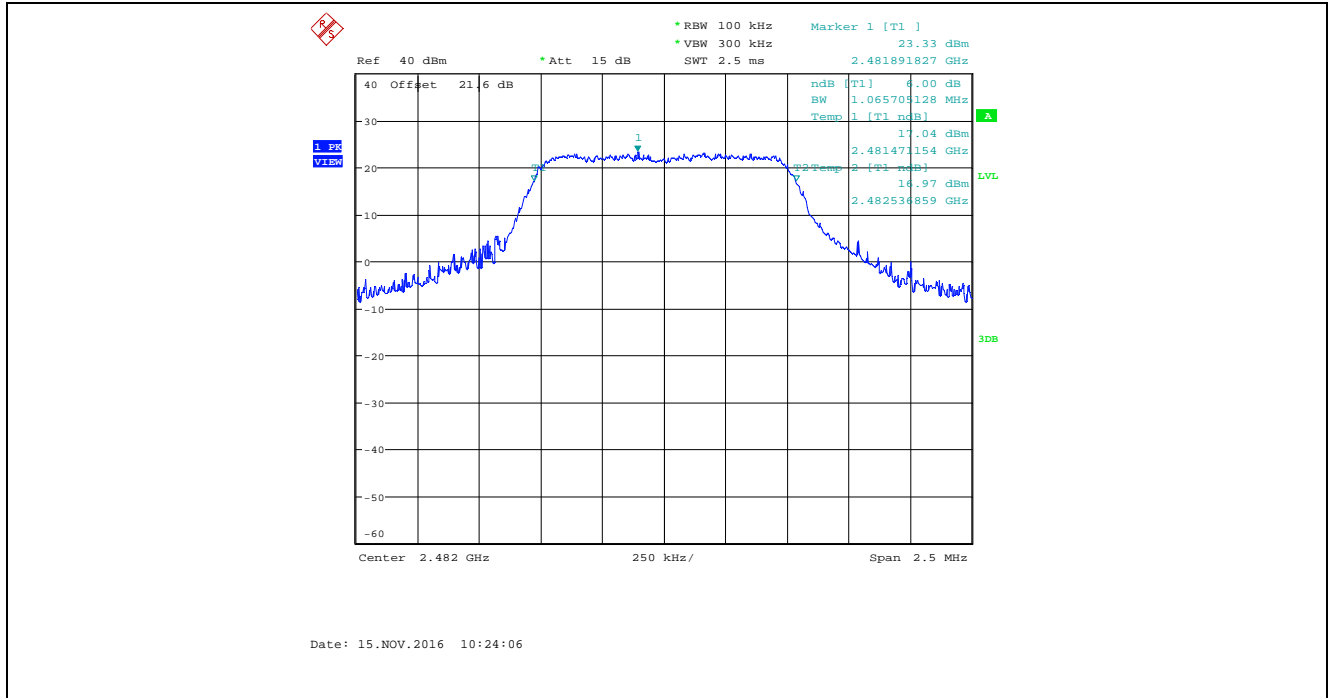

Plot 5.2.4.43. 6 dB Bandwidth, Bandwidth: 1 MHz, TX Gain: 43, Data Rate 7, 2402 MHz

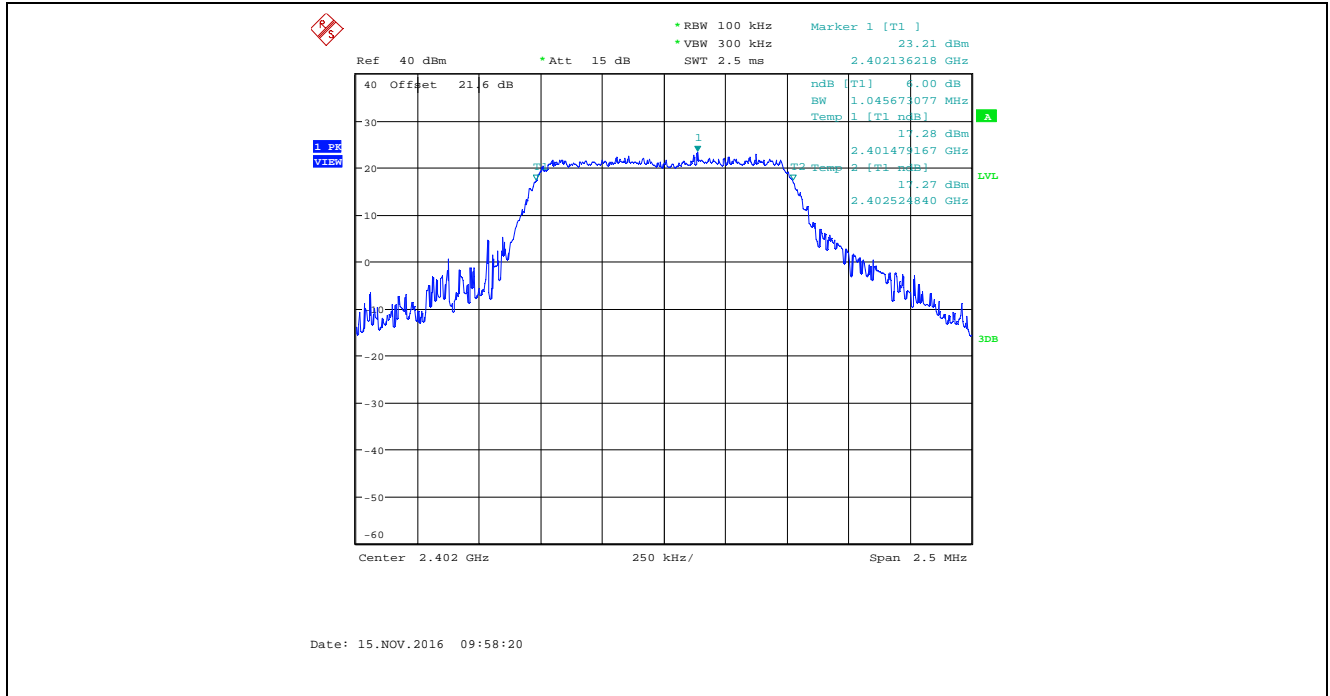

Plot 5.2.4.44. 6 dB Bandwidth, Bandwidth: 1 MHz, TX Gain: 43, Data Rate 7, 2442 MHz

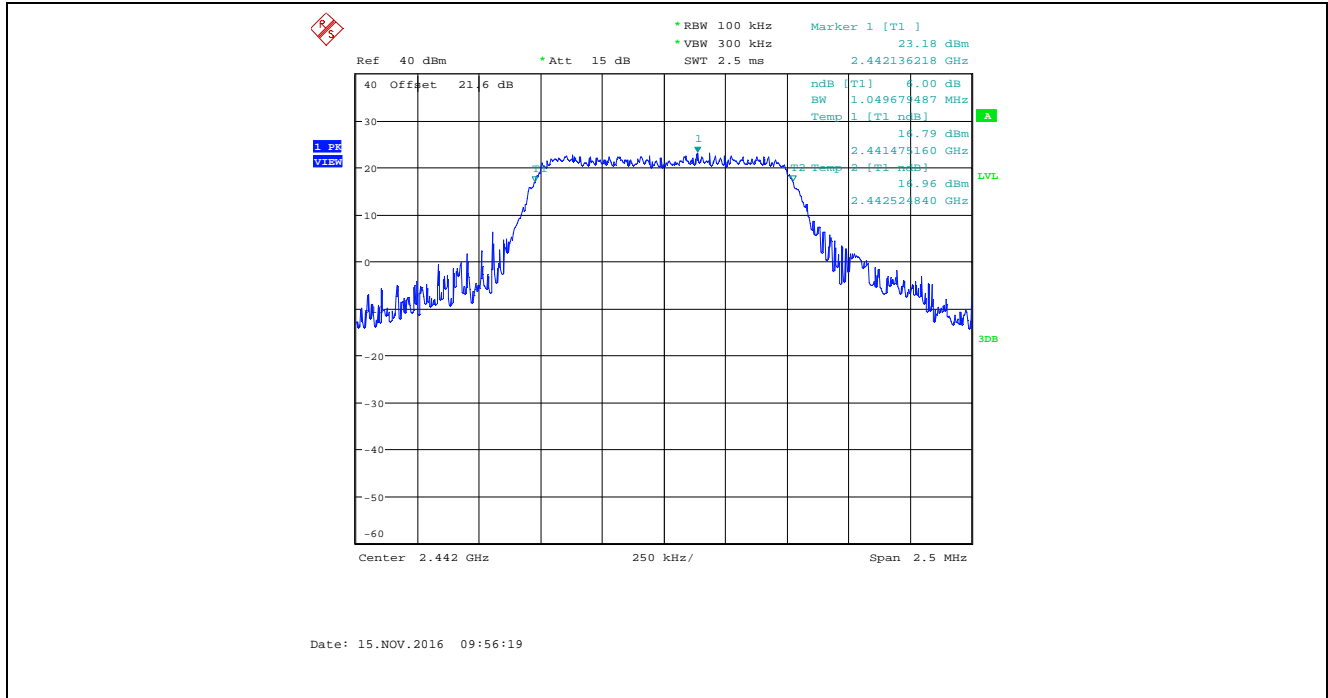

Plot 5.2.4.45. 6 dB Bandwidth, Bandwidth: 1 MHz, TX Gain: 43, Data Rate 7, 2482 MHz

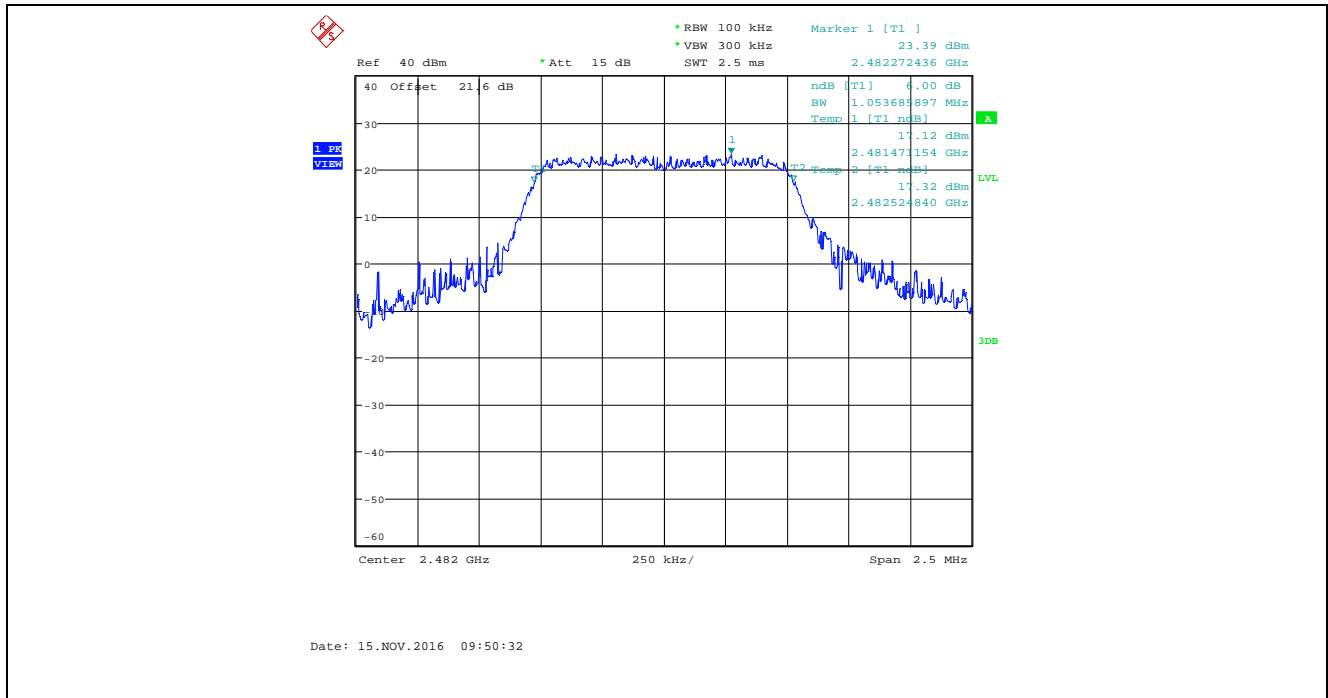

Plot 5.2.4.46. 6 dB Bandwidth, Bandwidth: 2 MHz, TX Gain: 45, Data Rate 4, 2402 MHz

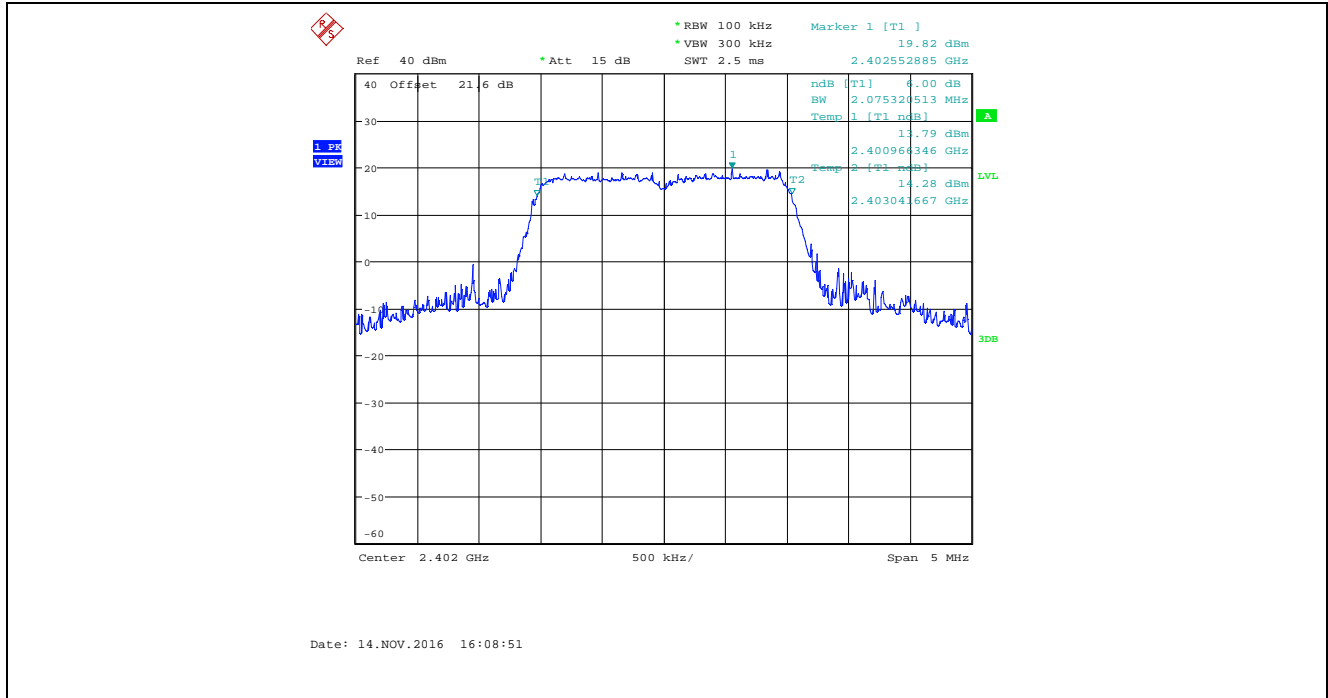

Plot 5.2.4.47. 6 dB Bandwidth, Bandwidth: 2 MHz, TX Gain: 45, Data Rate 4, 2442 MHz

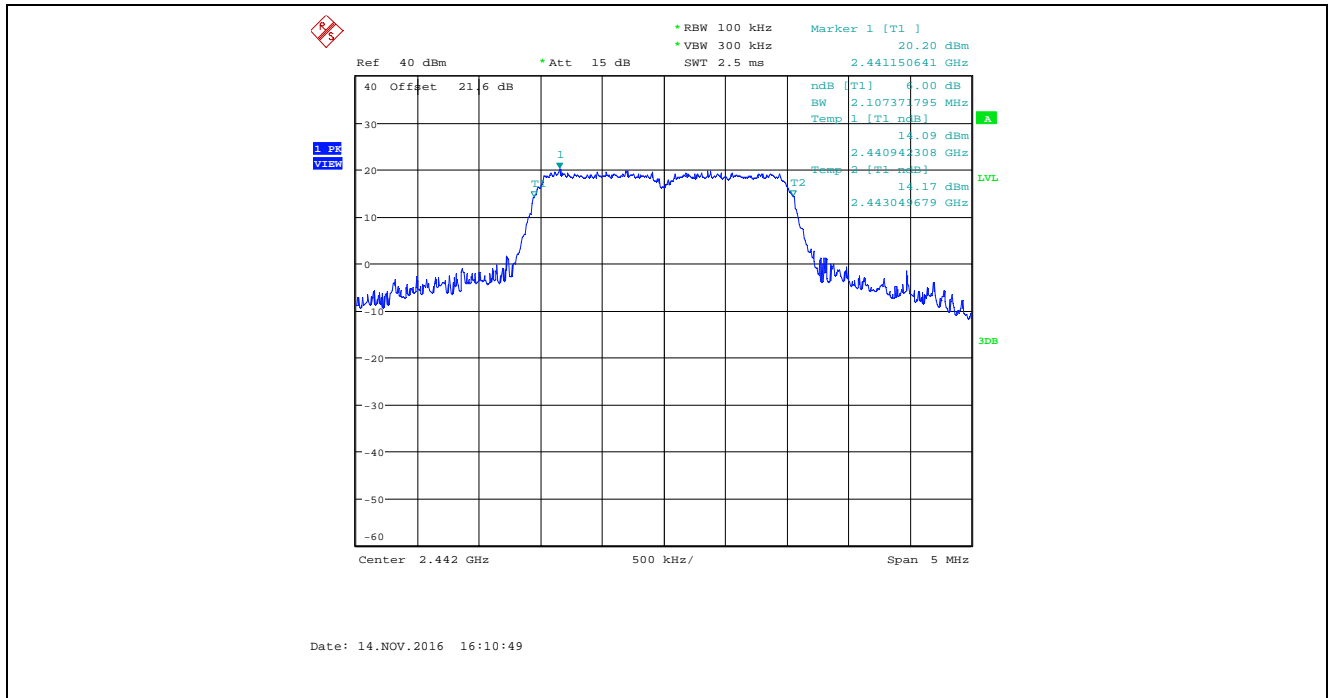

Plot 5.2.4.48. 6 dB Bandwidth, Bandwidth: 2 MHz, TX Gain: 45, Data Rate 4, 2482 MHz

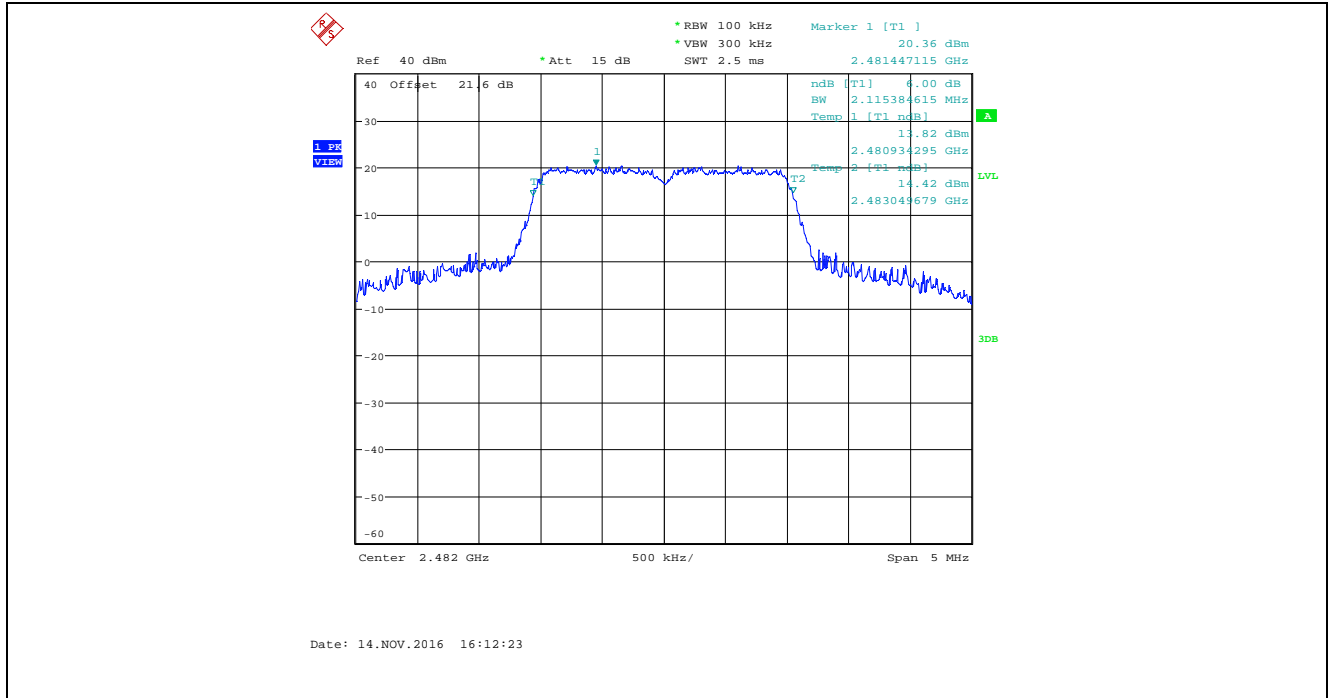

Plot 5.2.4.49. 6 dB Bandwidth, Bandwidth: 2 MHz, TX Gain: 45, Data Rate 5, 2402 MHz

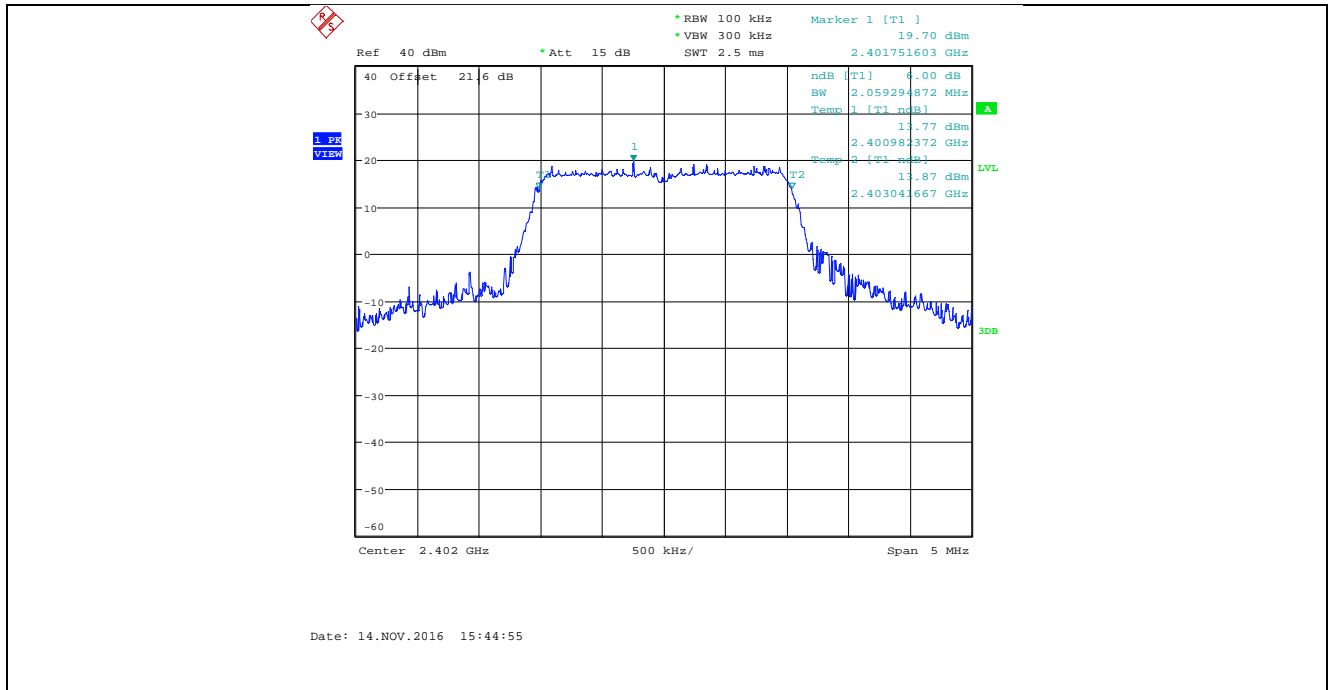

Plot 5.2.4.50. 6 dB Bandwidth, Bandwidth: 2 MHz, TX Gain: 45, Data Rate 5, 2442 MHz

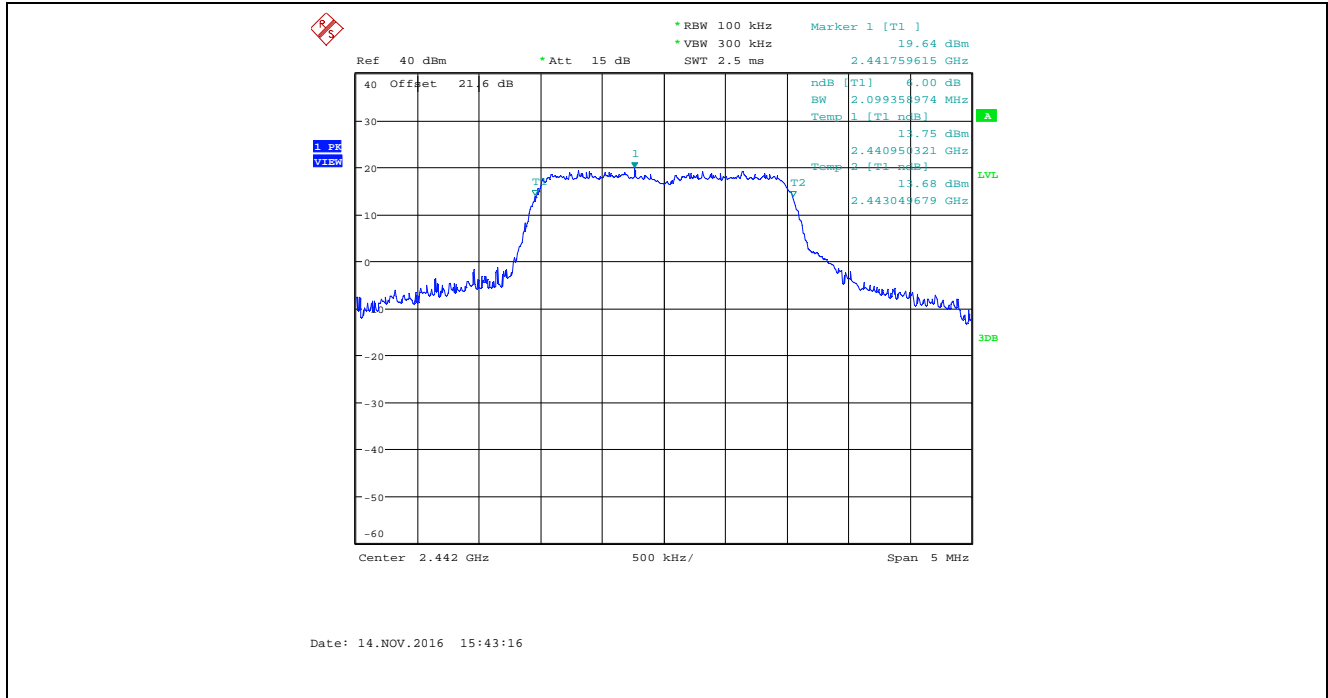

Plot 5.2.4.51. 6 dB Bandwidth, Bandwidth: 2 MHz, TX Gain: 45, Data Rate 5, 2482 MHz

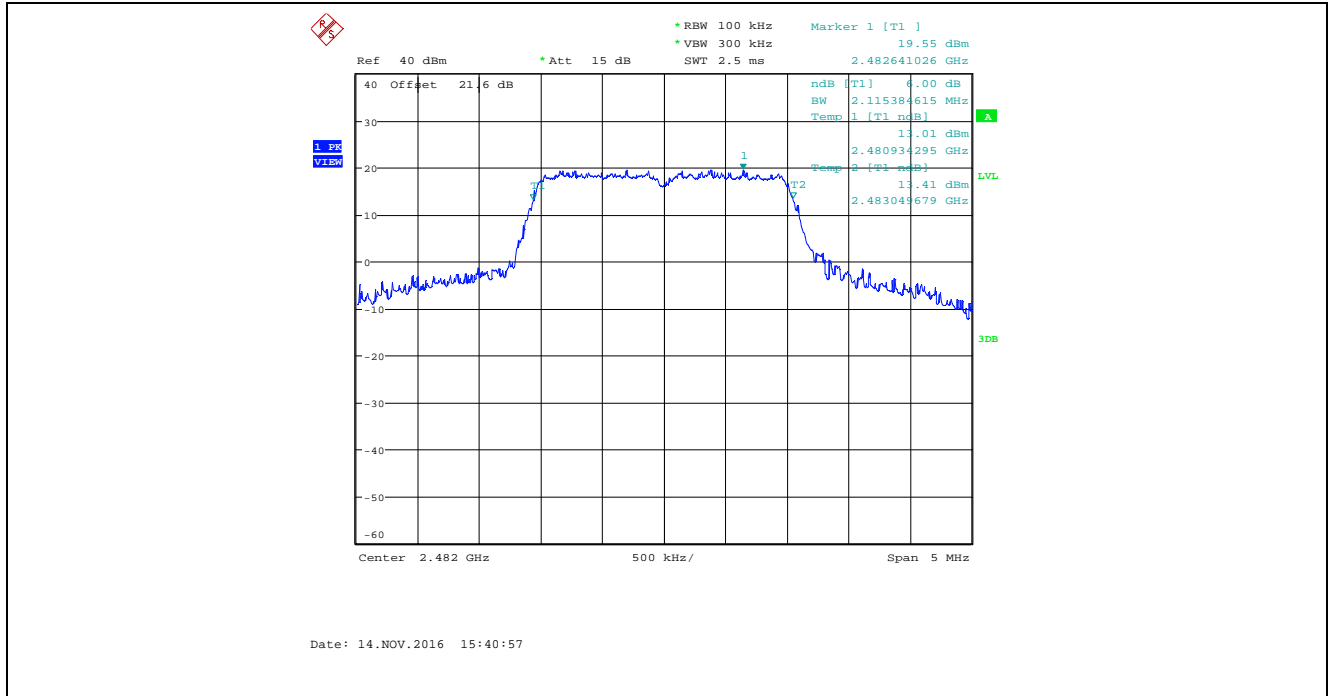

Plot 5.2.4.52. 6 dB Bandwidth, Bandwidth: 2 MHz, TX Gain: 45, Data Rate 6, 2402 MHz

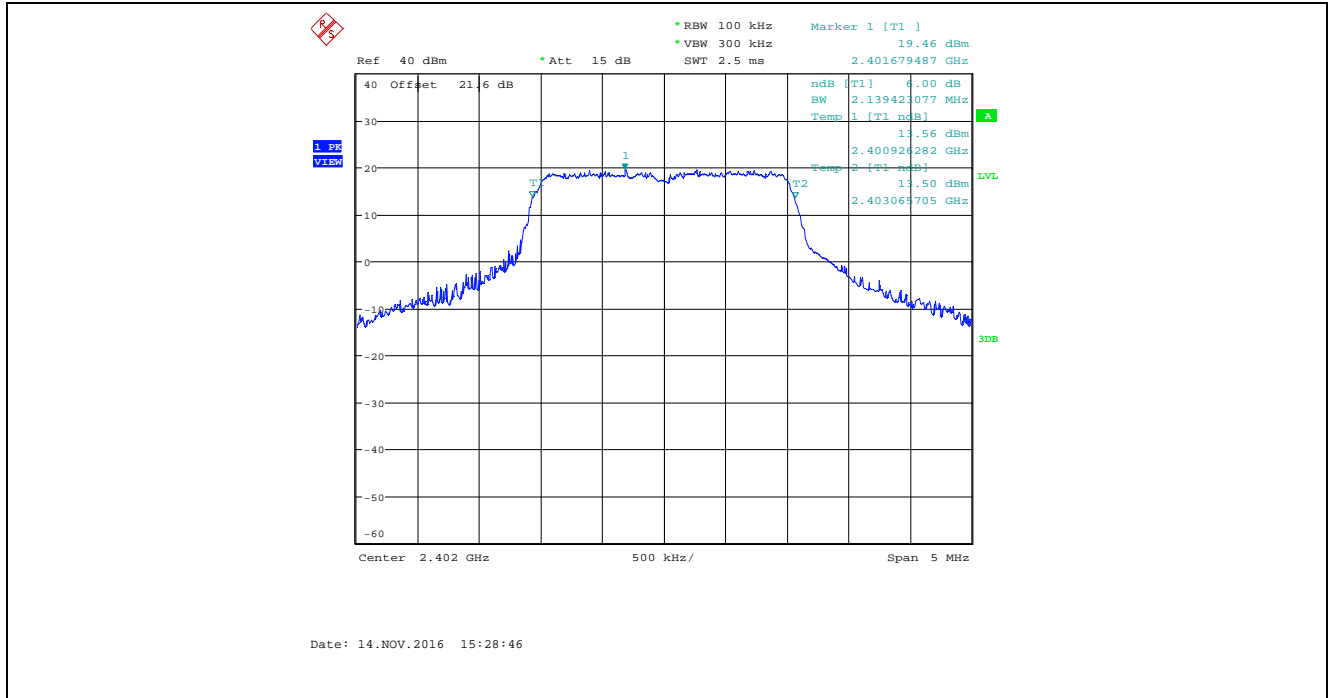

Plot 5.2.4.53. 6 dB Bandwidth, Bandwidth: 2 MHz, TX Gain: 45, Data Rate 6, 2442 MHz

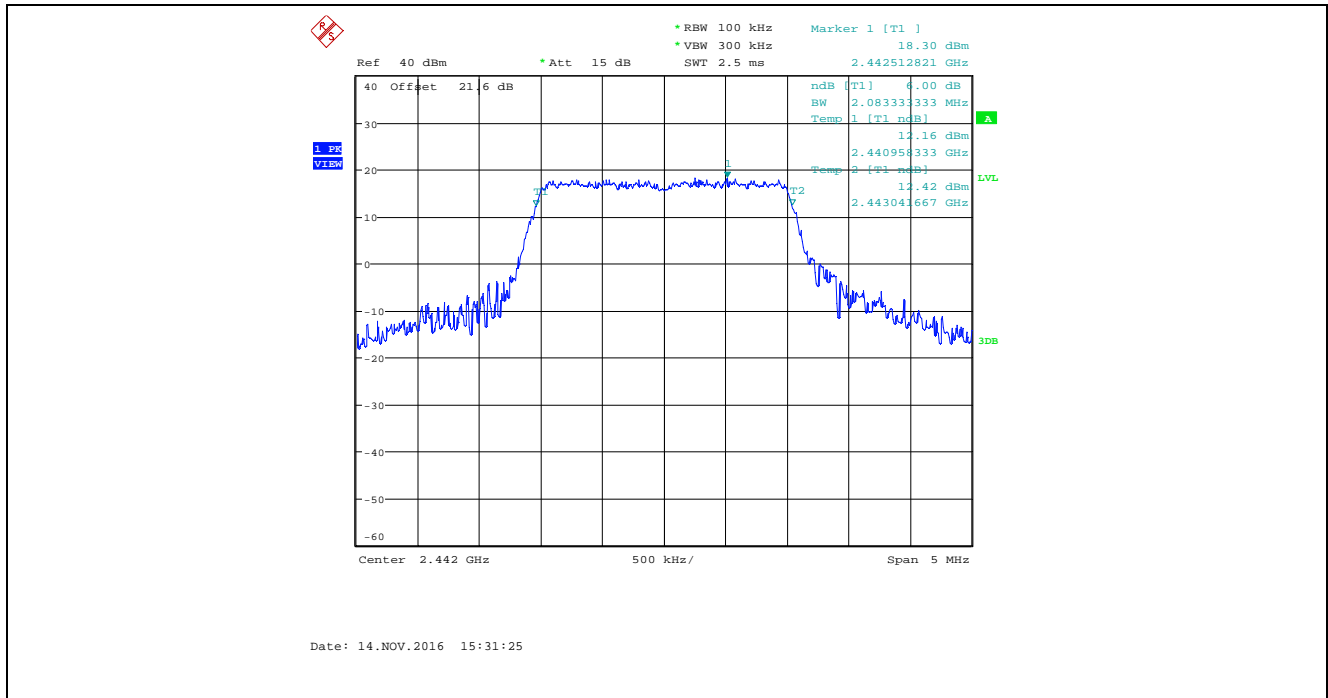

Plot 5.2.4.54. 6 dB Bandwidth, Bandwidth: 2 MHz, TX Gain: 45, Data Rate 6, 2482 MHz

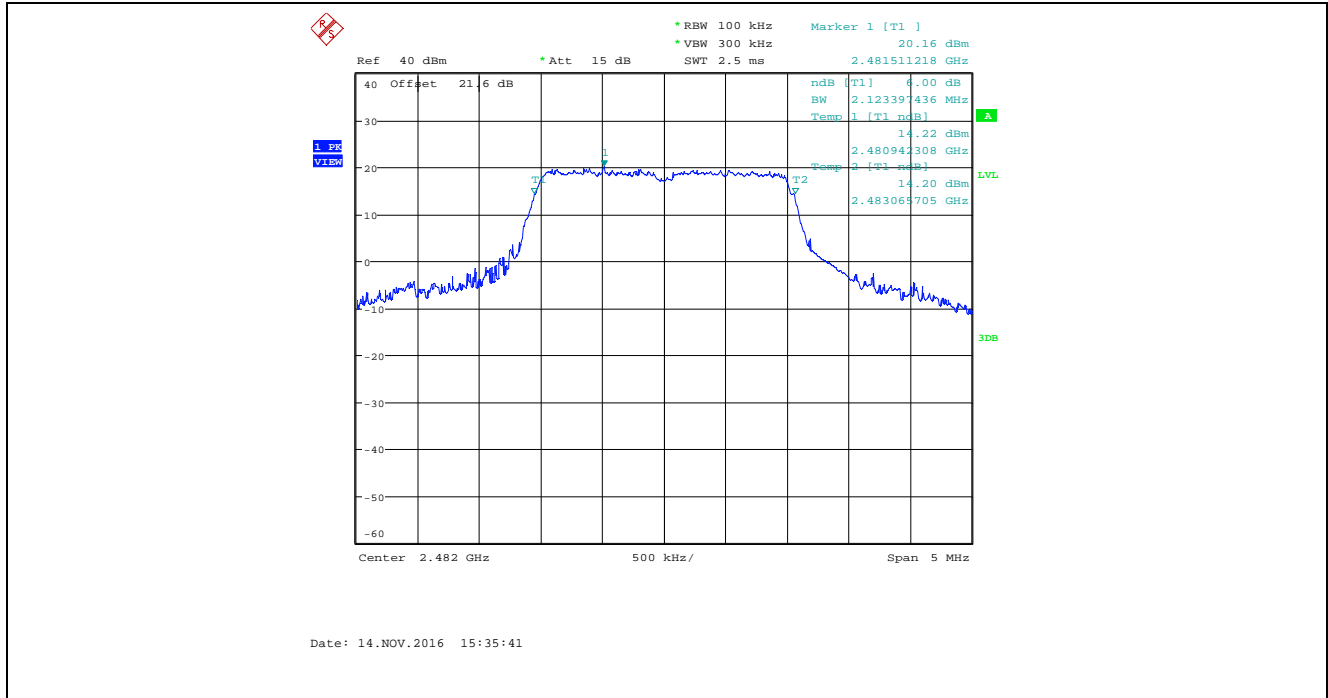

Plot 5.2.4.55. 6 dB Bandwidth, Bandwidth: 2 MHz, TX Gain: 45, Data Rate 7, 2402 MHz

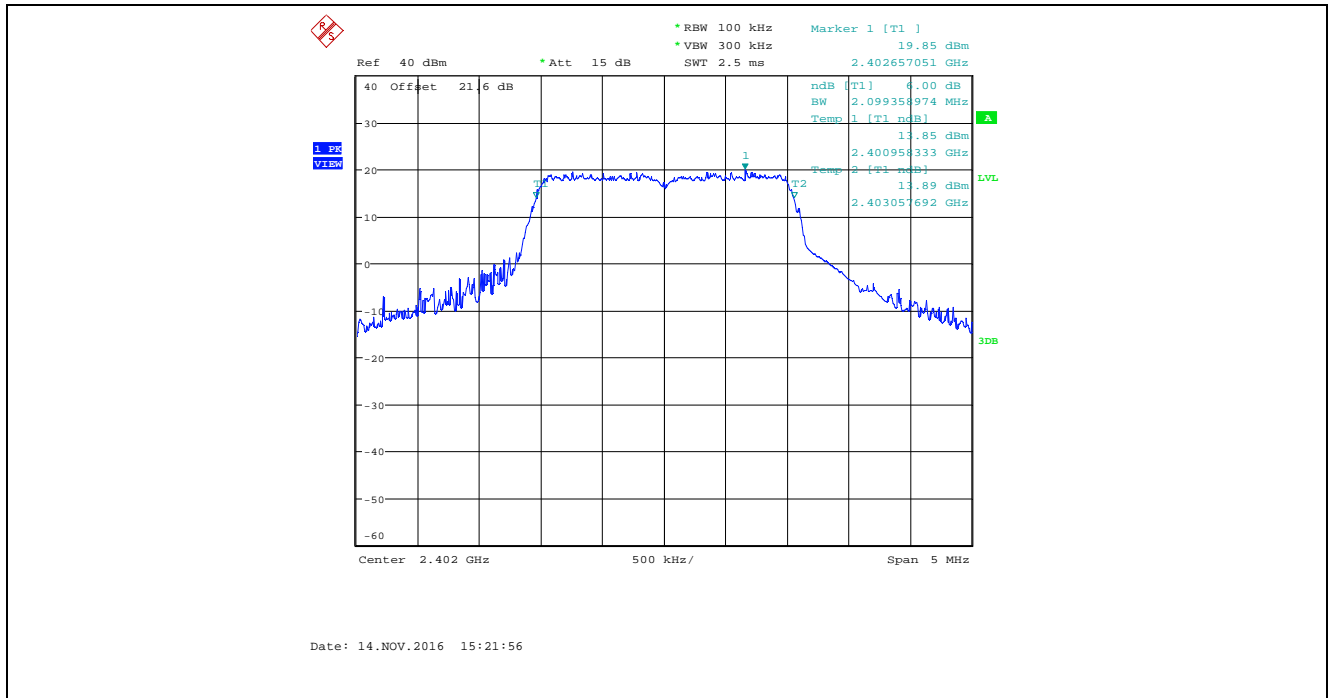

Plot 5.2.4.56. 6 dB Bandwidth, Bandwidth: 2 MHz, TX Gain: 45, Data Rate 7, 2442 MHz

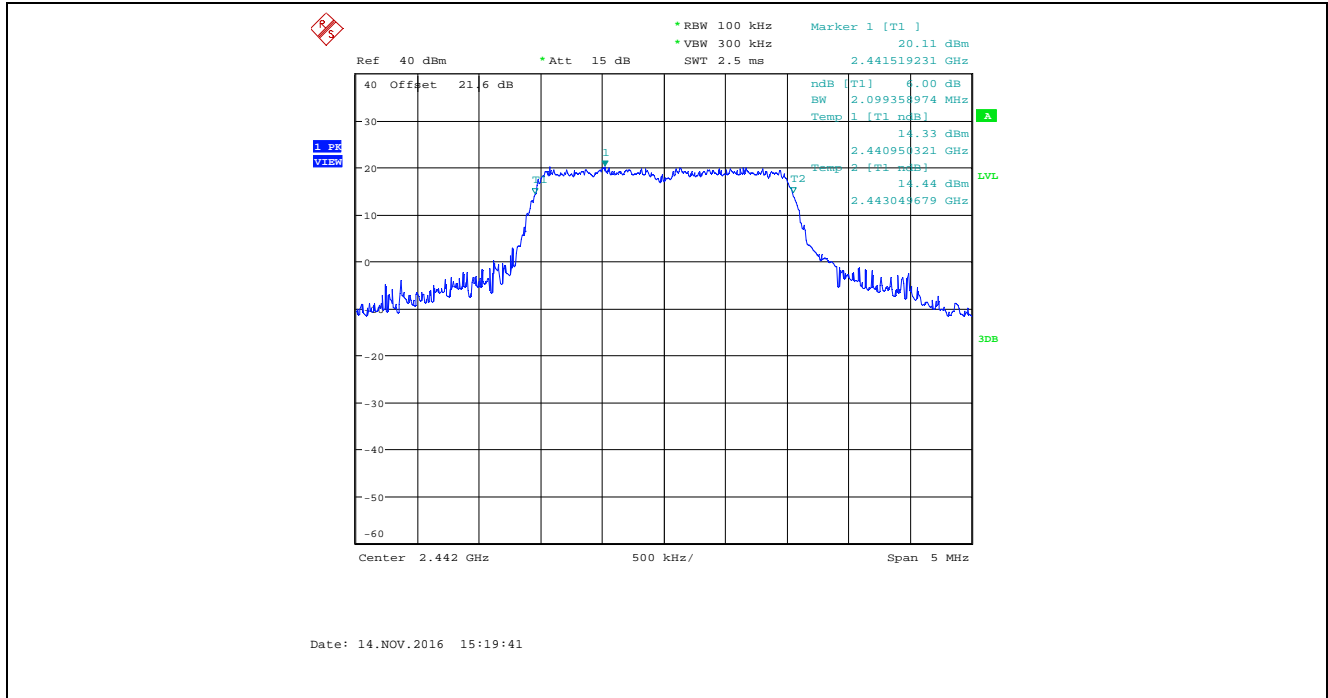

Plot 5.2.4.57. 6 dB Bandwidth, Bandwidth: 2 MHz, TX Gain: 45, Data Rate 7, 2482 MHz

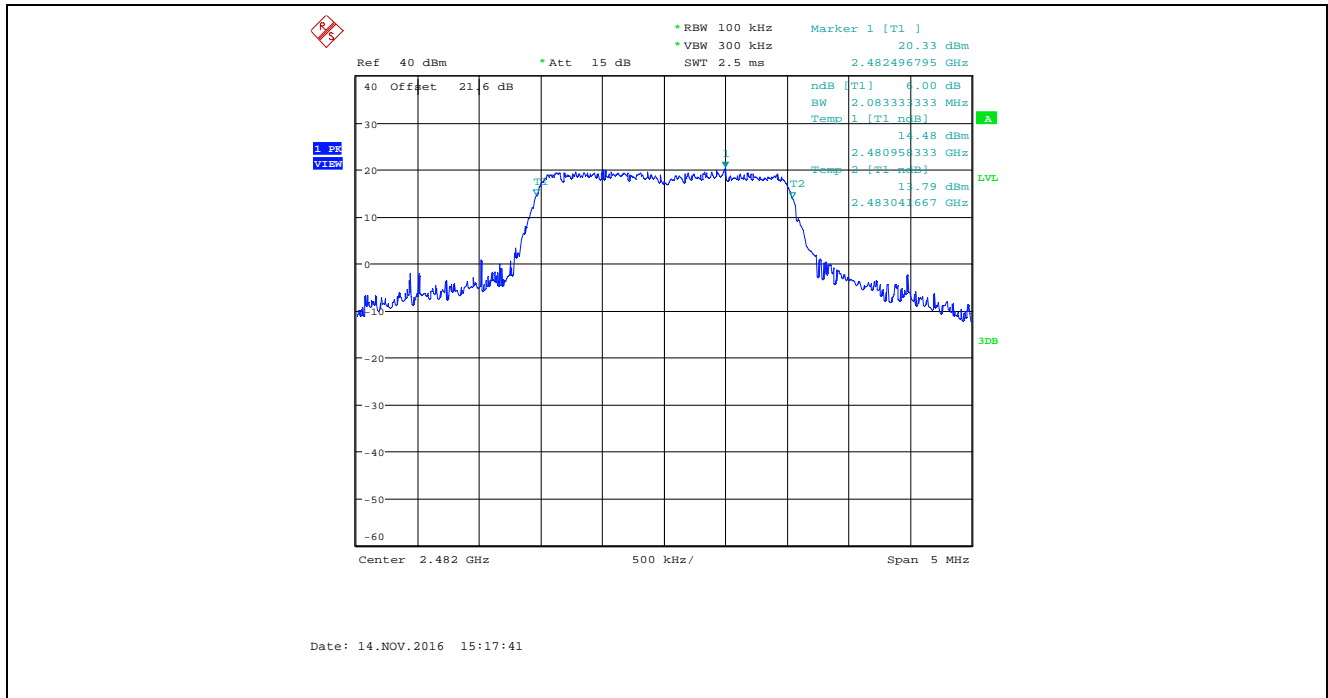



Plot 5.2.4.58. 6 dB Bandwidth, Bandwidth: 4 MHz, TX Gain: 50, Data Rate 4, 2403 MHz

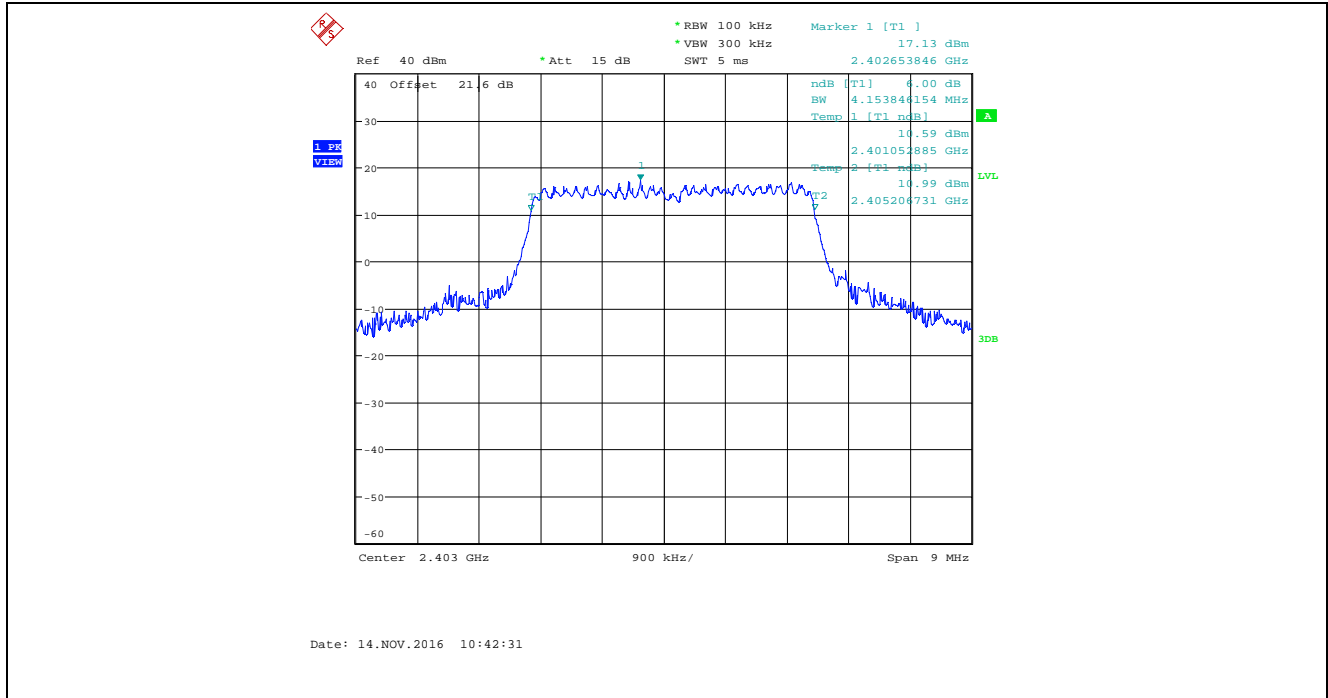

Plot 5.2.4.59. 6 dB Bandwidth, Bandwidth: 4 MHz, TX Gain: 50, Data Rate 4, 2442 MHz

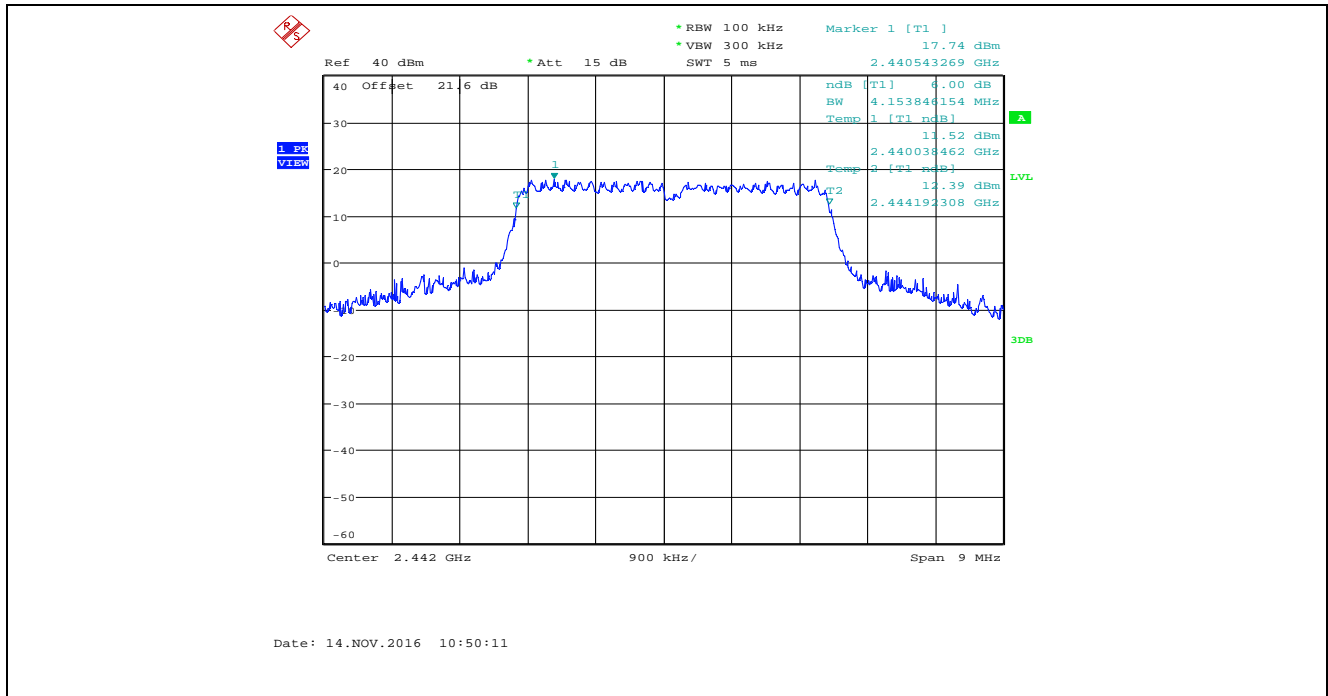

Plot 5.2.4.60. 6 dB Bandwidth, Bandwidth: 4 MHz, TX Gain: 50, Data Rate 4, 2480 MHz

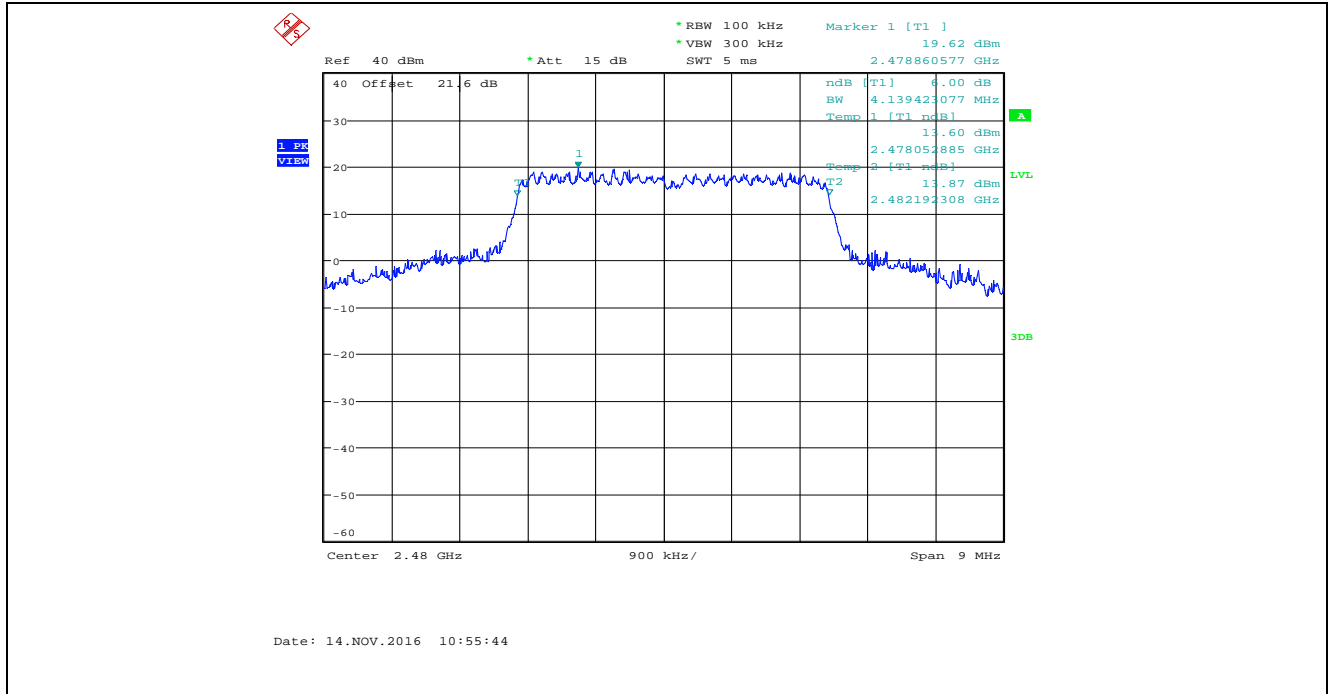

Plot 5.2.4.61. 6 dB Bandwidth, Bandwidth: 4 MHz, TX Gain: 50, Data Rate 5, 2403 MHz

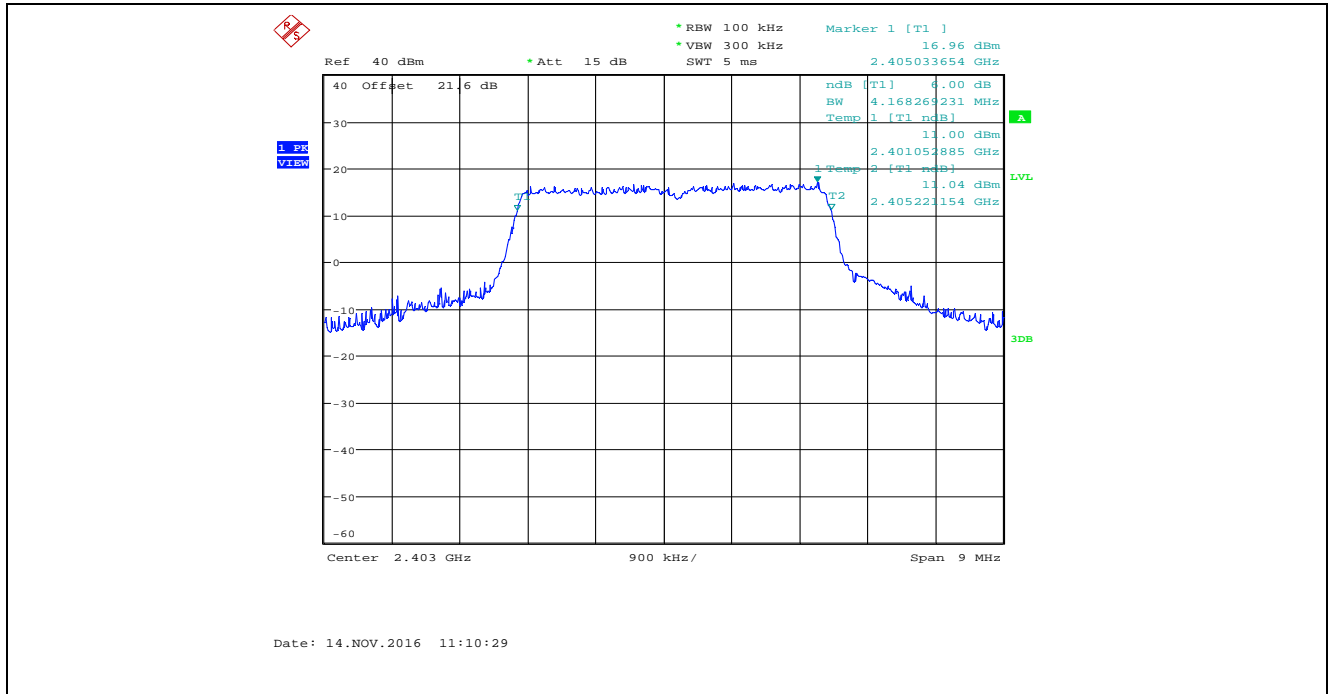

Plot 5.2.4.62. 6 dB Bandwidth, Bandwidth: 4 MHz, TX Gain: 50, Data Rate 5, 2442 MHz

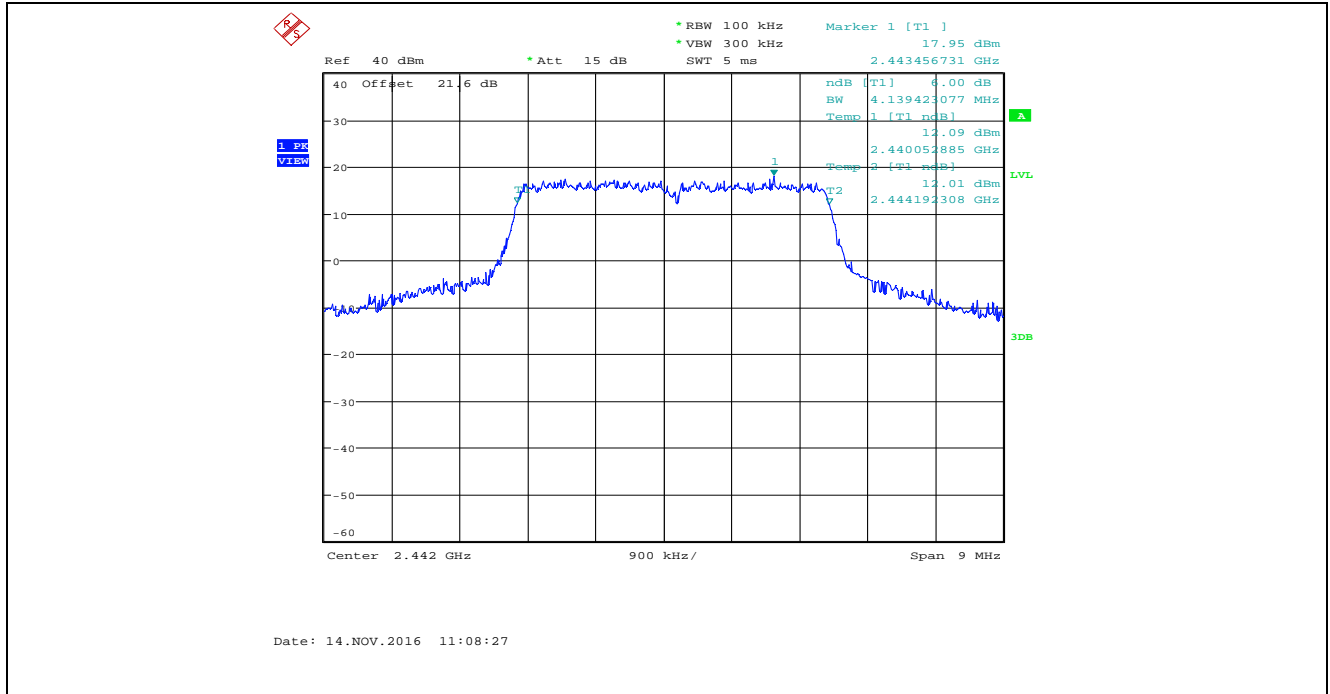

Plot 5.2.4.63. 6 dB Bandwidth, Bandwidth: 4 MHz, TX Gain: 50, Data Rate 5, 2480 MHz

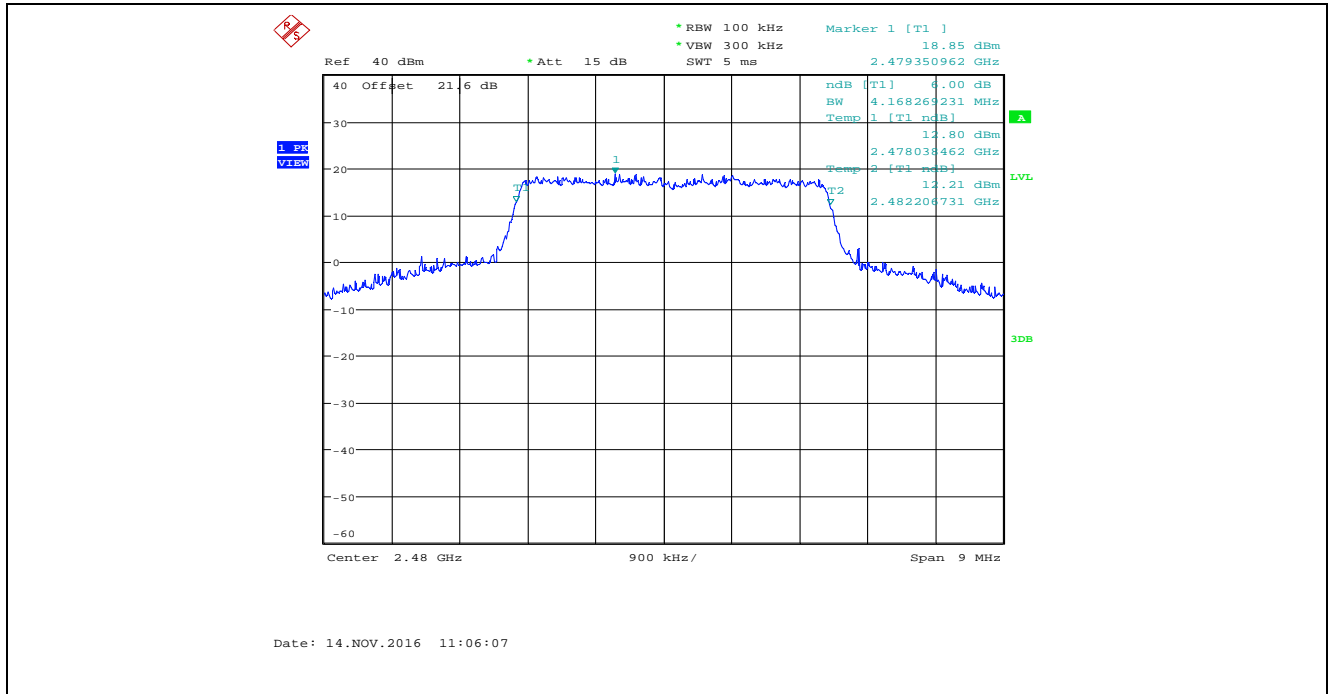

Plot 5.2.4.64. 6 dB Bandwidth, Bandwidth: 4 MHz, TX Gain: 50, Data Rate 6, 2403 MHz,

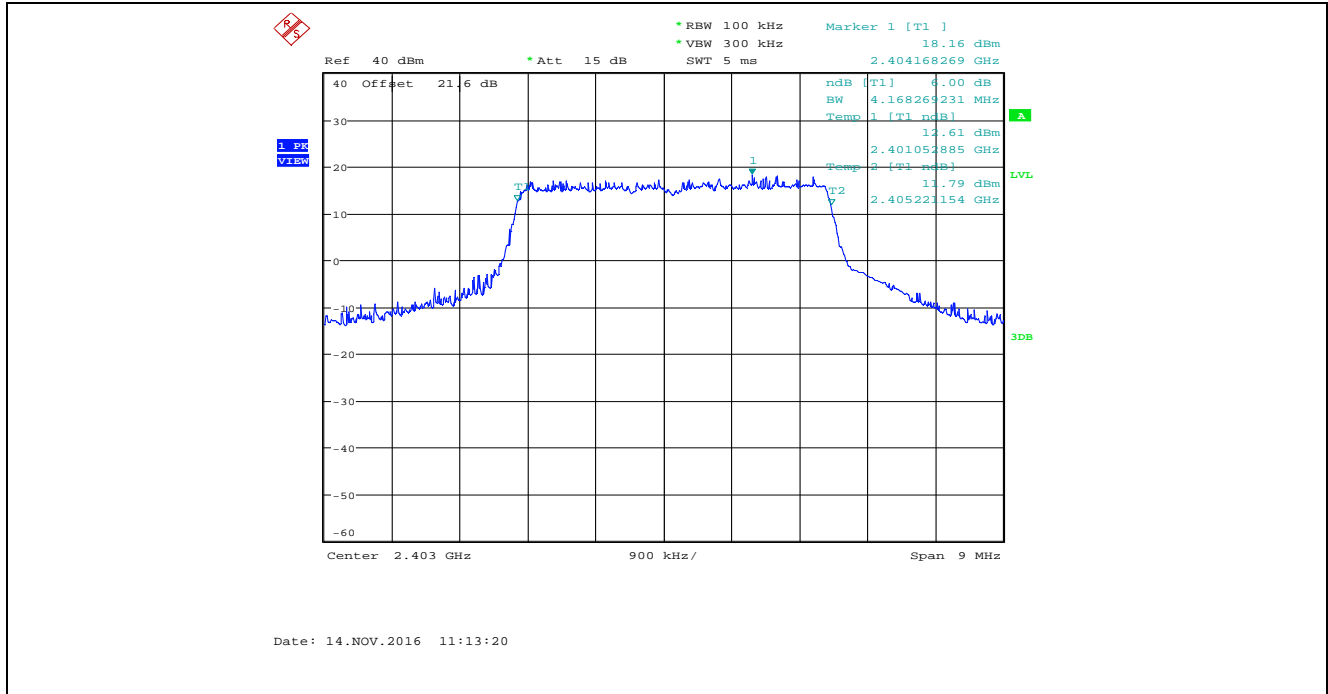

Plot 5.2.4.65. 6 dB Bandwidth, Bandwidth: 4 MHz, TX Gain: 50, Data Rate 6, 2442 MHz

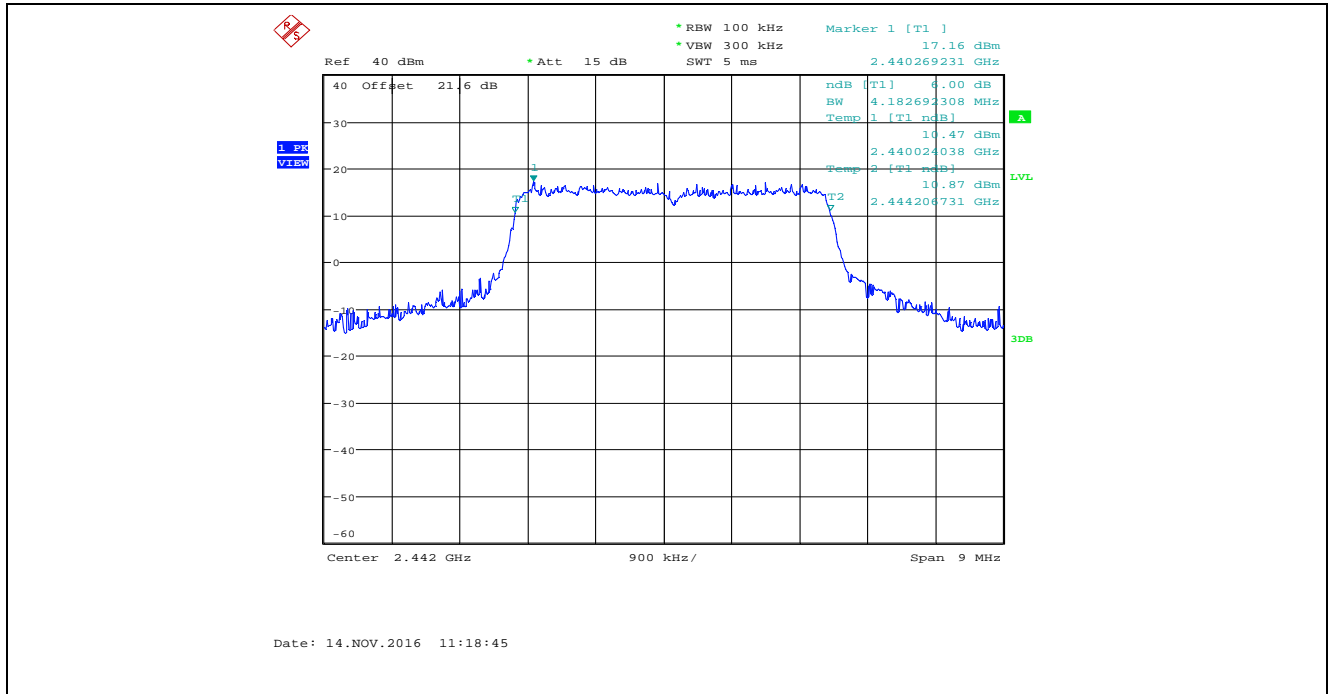

Plot 5.2.4.66. 6 dB Bandwidth, Bandwidth: 4 MHz, TX Gain: 50, Data Rate 6, 2480 MHz

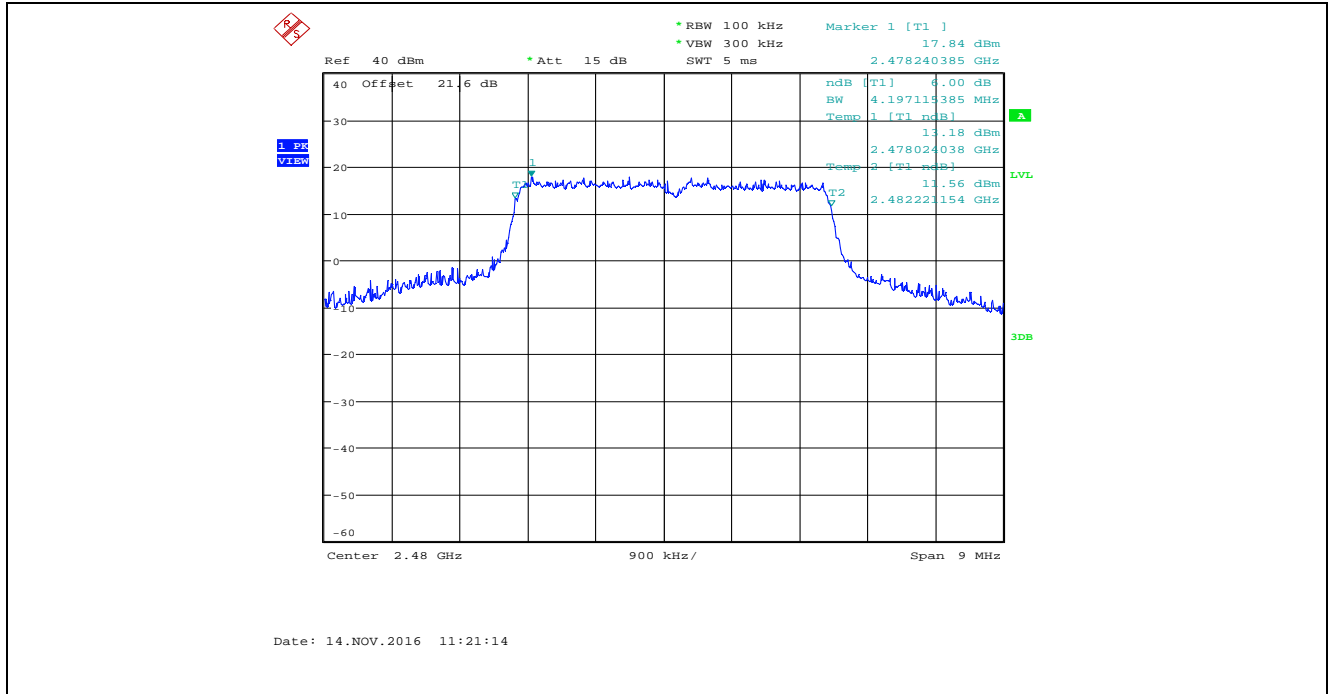

Plot 5.2.4.67. 6 dB Bandwidth, Bandwidth: 4 MHz, TX Gain: 50, Data Rate 7, 2403 MHz

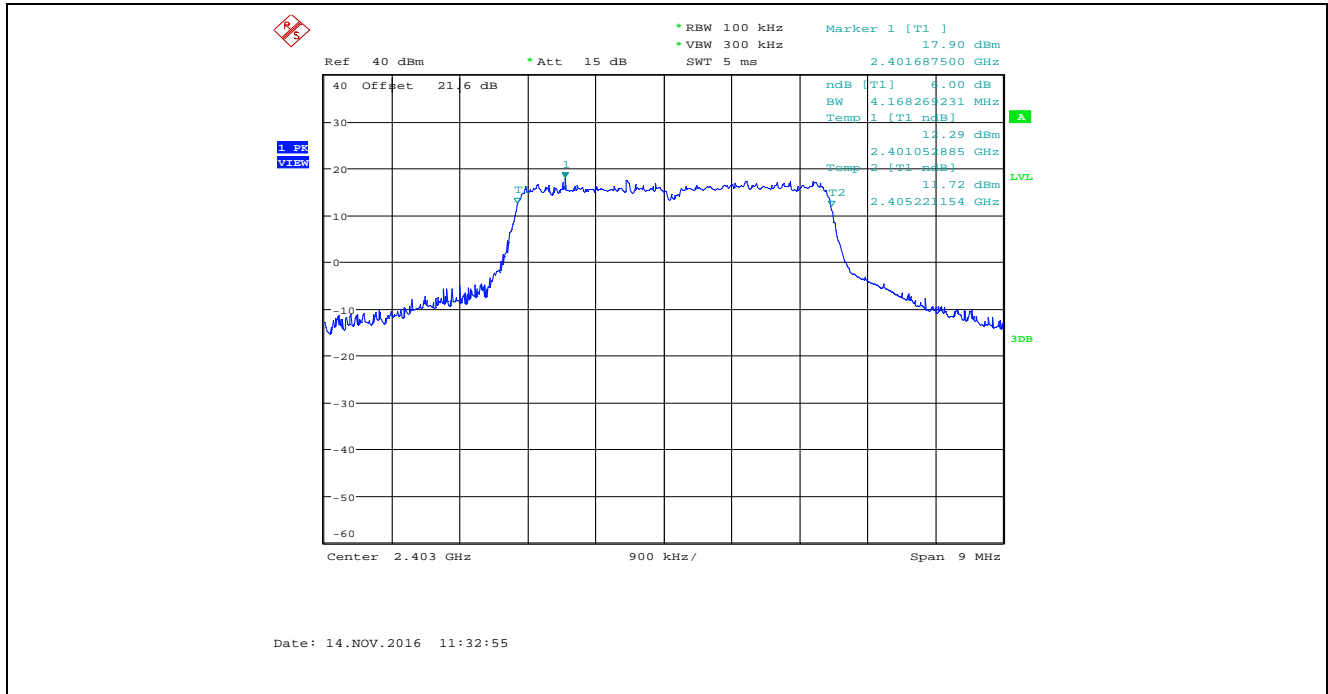

Plot 5.2.4.68. 6 dB Bandwidth, Bandwidth: 4 MHz, TX Gain: 50, Data Rate 7, 2442 MHz

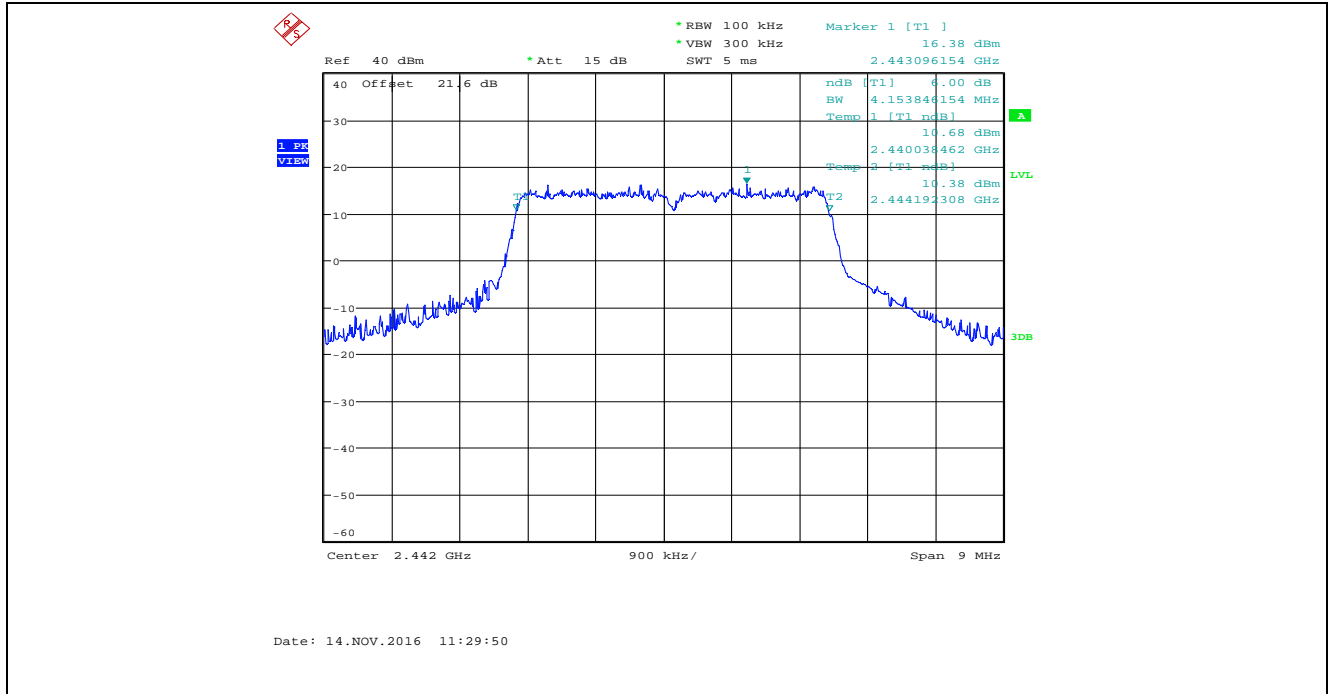

Plot 5.2.4.69. 6 dB Bandwidth, Bandwidth: 4 MHz, TX Gain: 50, Data Rate 7, 2480 MHz

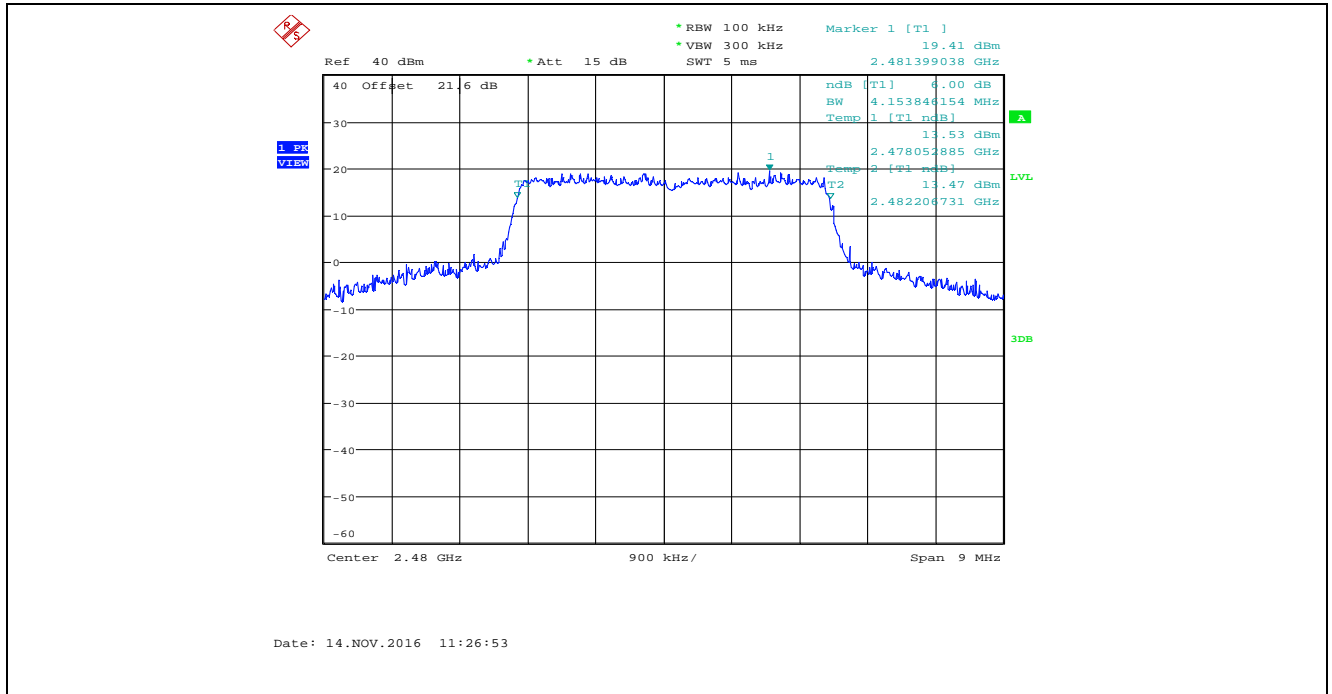

Plot 5.2.4.70. 6 dB Bandwidth, Bandwidth: 8 MHz, TX Gain: 55, Data Rate 4, 2407 MHz

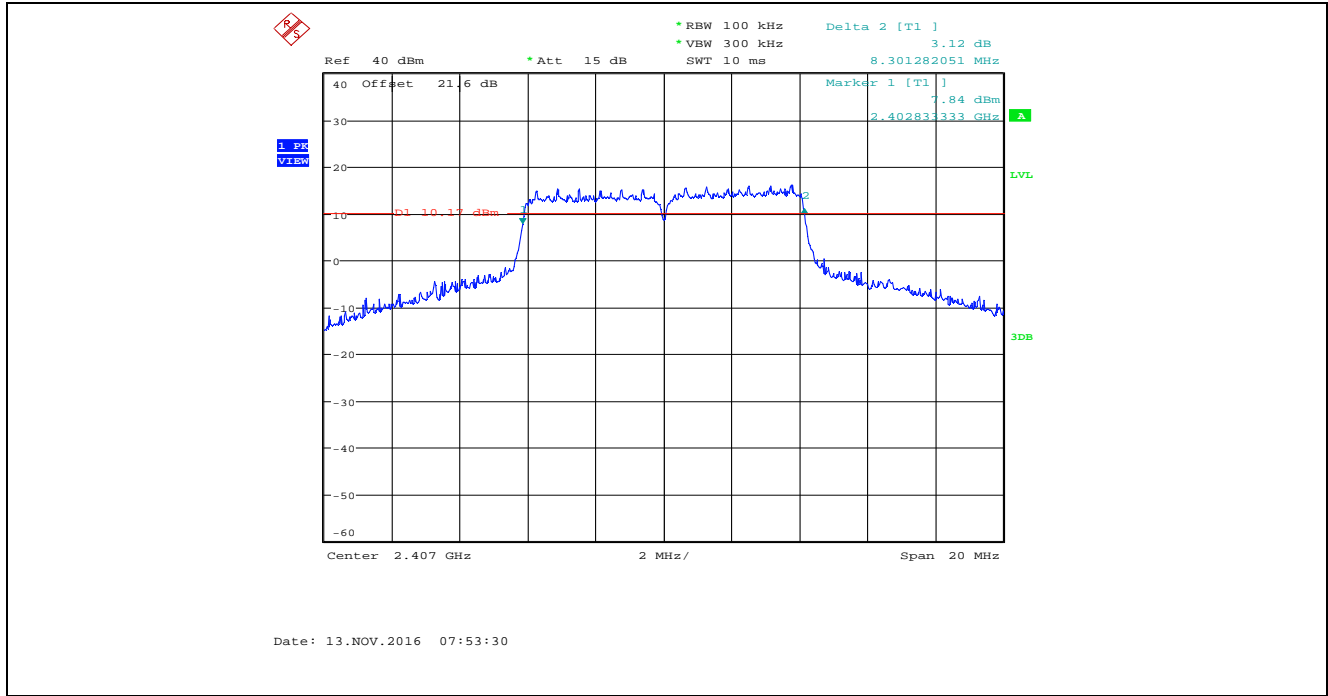

Plot 5.2.4.71. 6 dB Bandwidth, Bandwidth: 8 MHz, TX Gain: 55, Data Rate 4, 2442 MHz

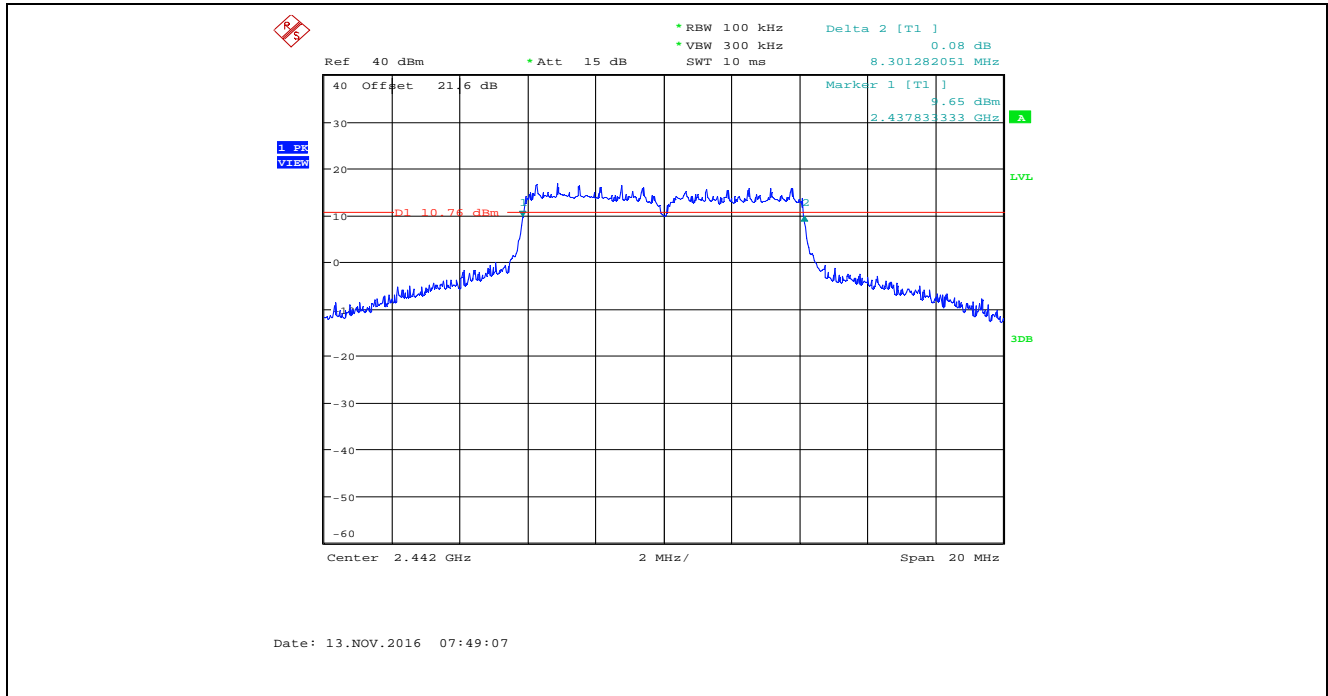

Plot 5.2.4.72. 6 dB Bandwidth, Bandwidth: 8 MHz, TX Gain: 55, Data Rate 4, 2477 MHz

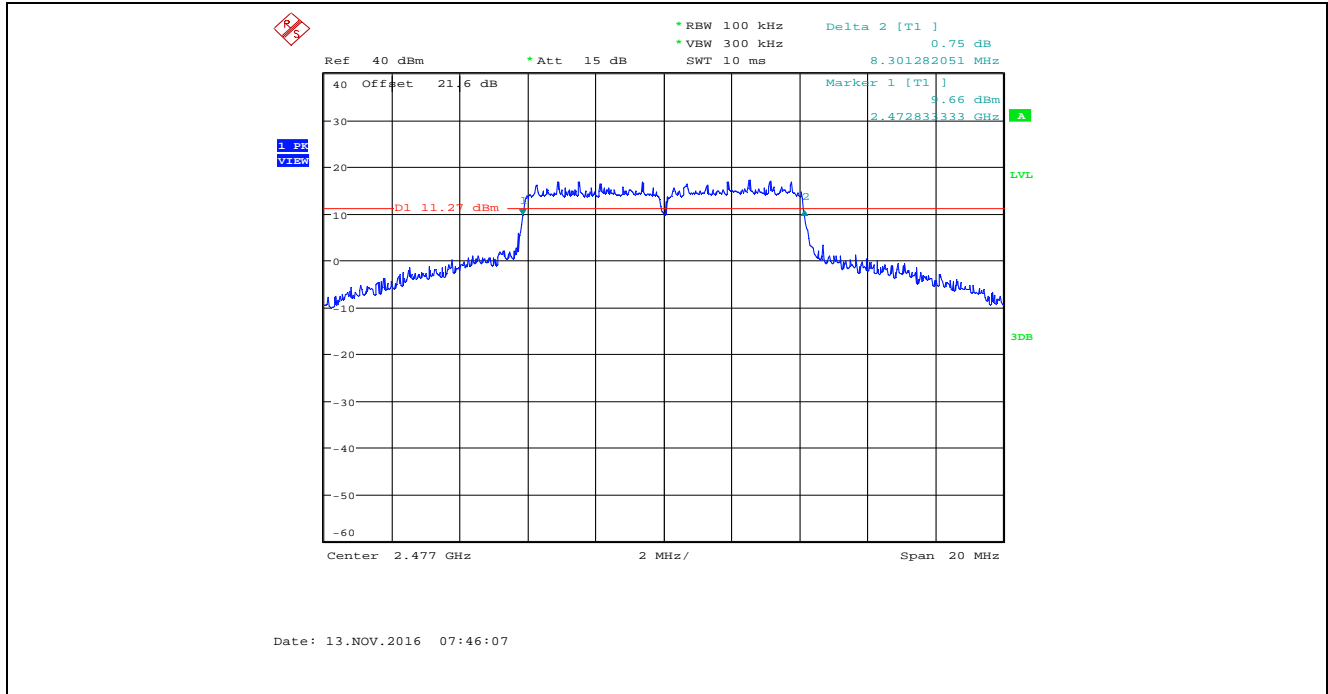

Plot 5.2.4.73. 6 dB Bandwidth, Bandwidth: 8 MHz, TX Gain: 55, Data Rate 5, 2407 MHz

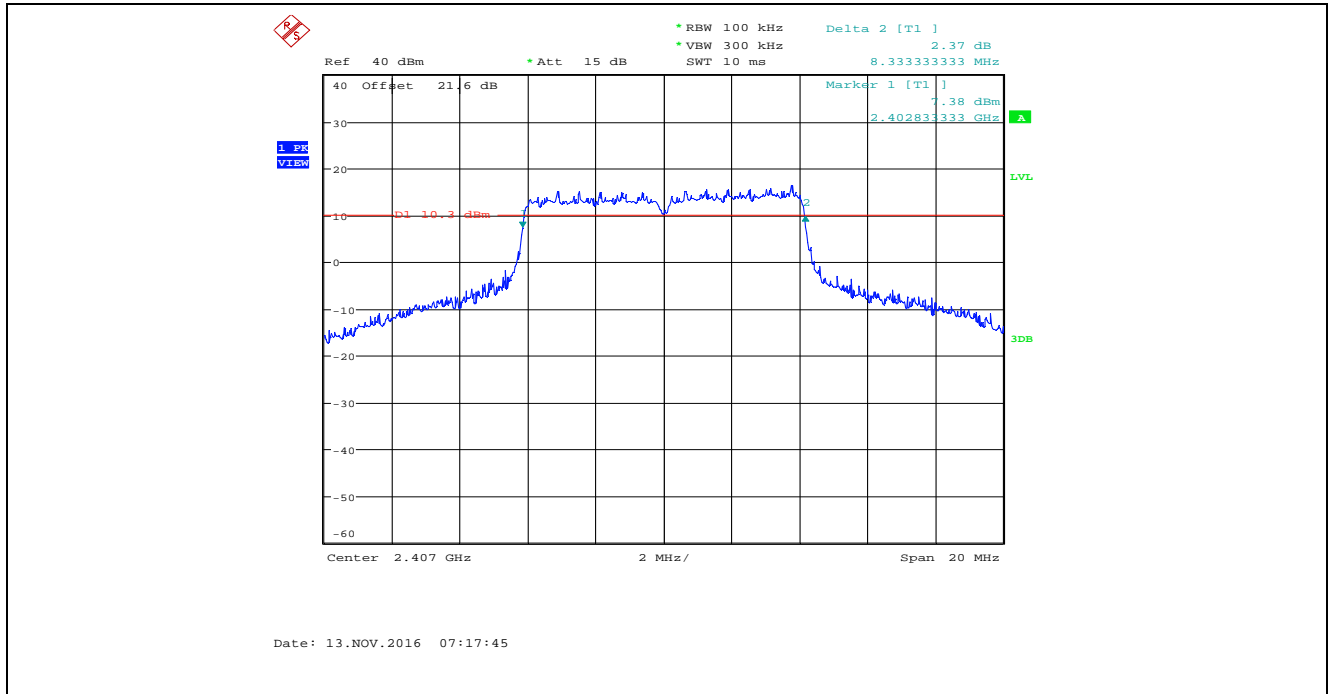



Plot 5.2.4.74. 6 dB Bandwidth, Bandwidth: 8 MHz, TX Gain: 55, Data Rate 5, 2442 MHz

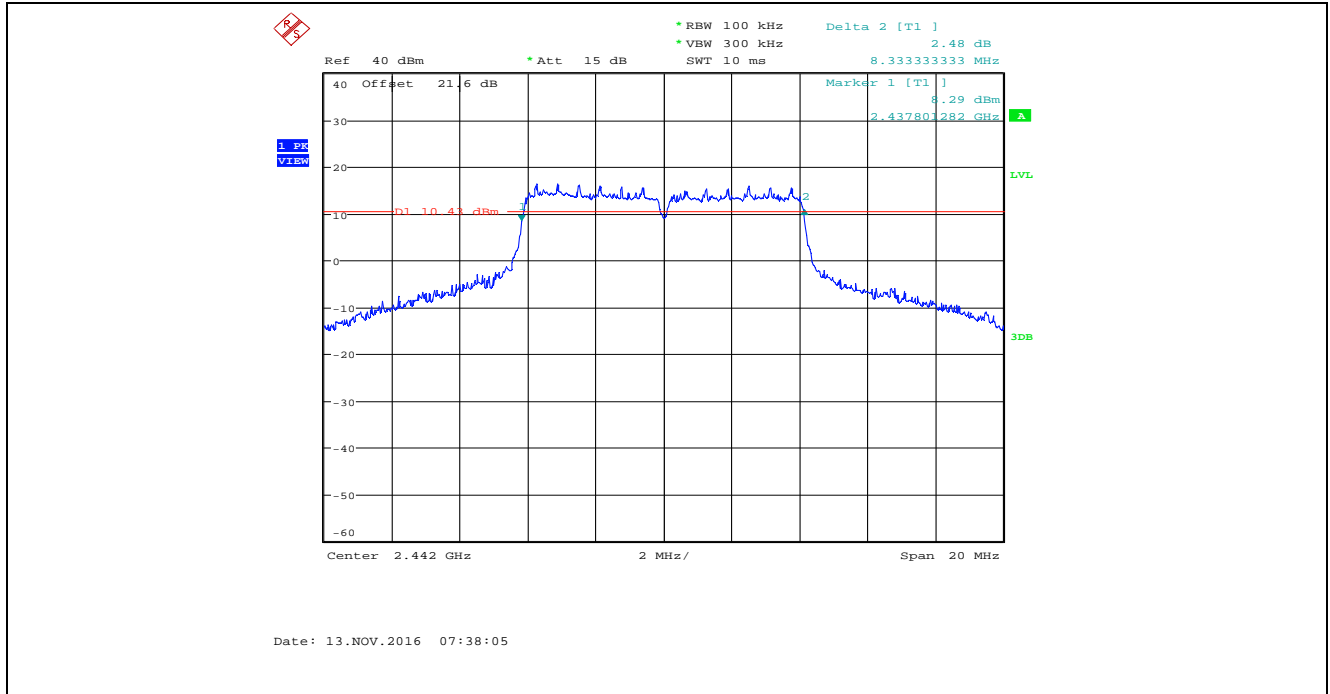

Plot 5.2.4.75. 6 dB Bandwidth, Bandwidth: 8 MHz, TX Gain: 55, Data Rate 5, 2477 MHz

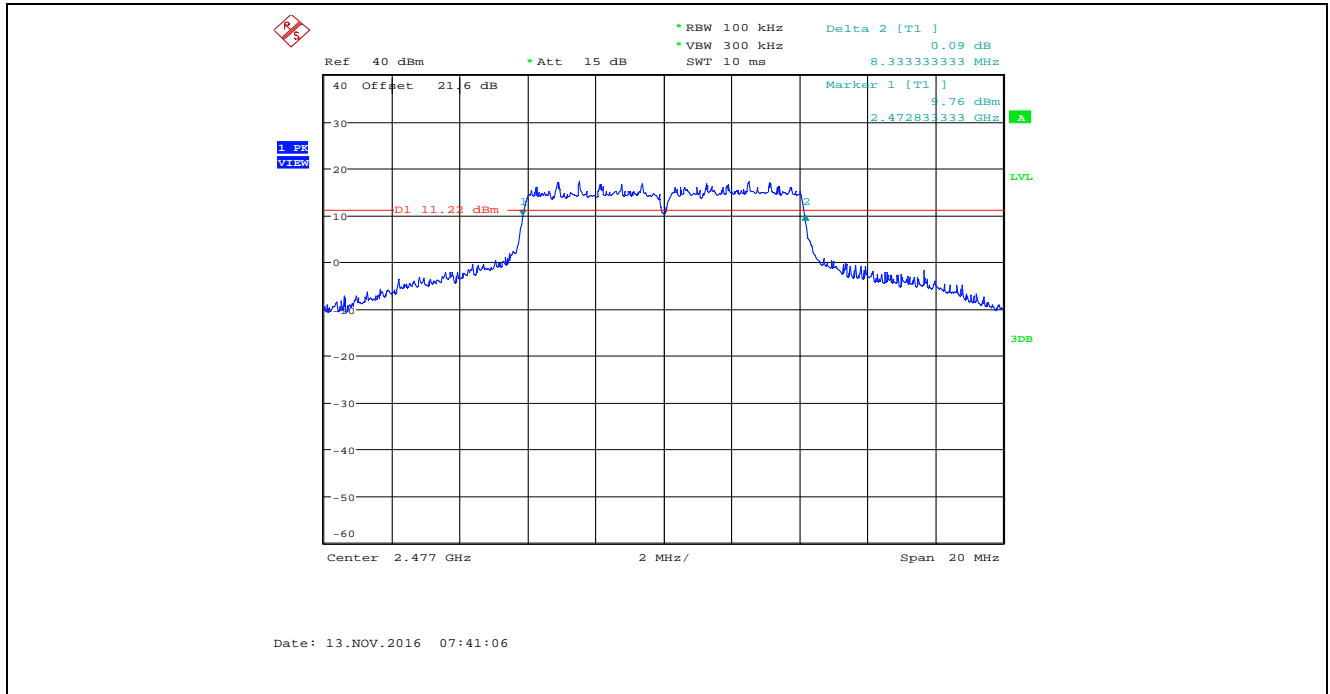

Plot 5.2.4.76. 6 dB Bandwidth, Bandwidth: 8 MHz, TX Gain: 55, Data Rate 6, 2407 MHz

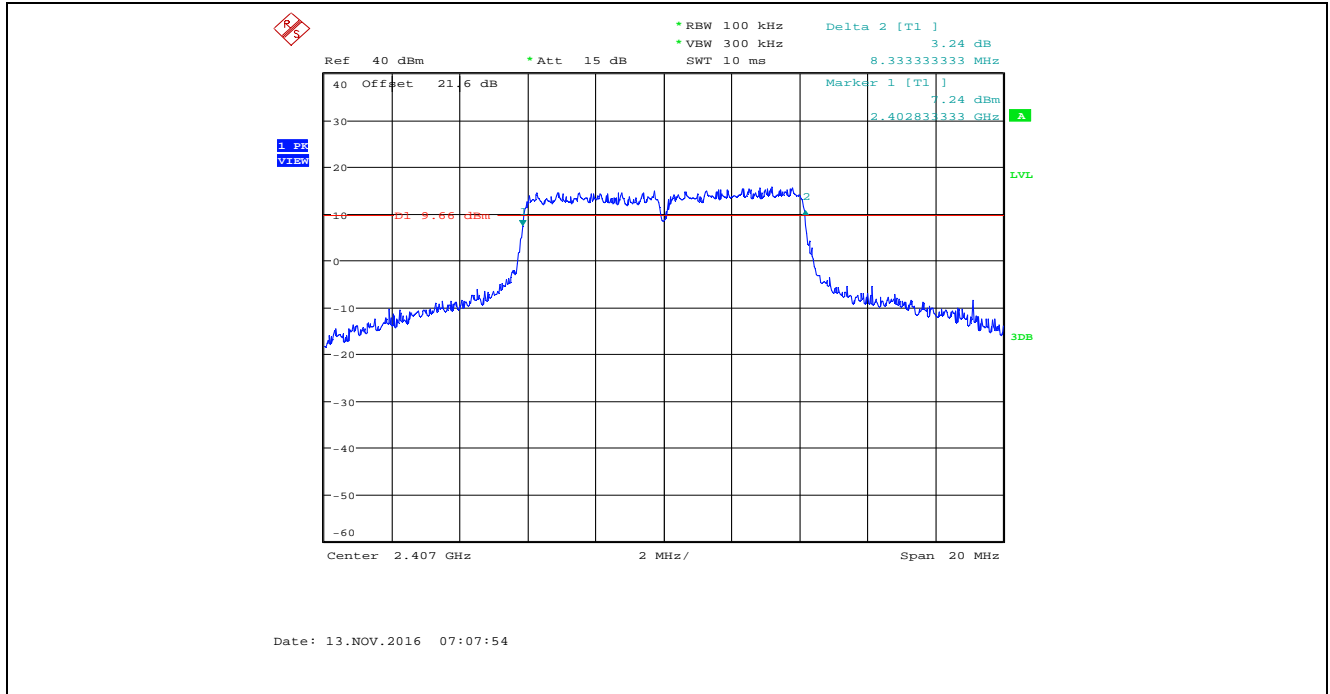

Plot 5.2.4.77. 6 dB Bandwidth, Bandwidth: 8 MHz, TX Gain: 55, Data Rate 6, 2442 MHz

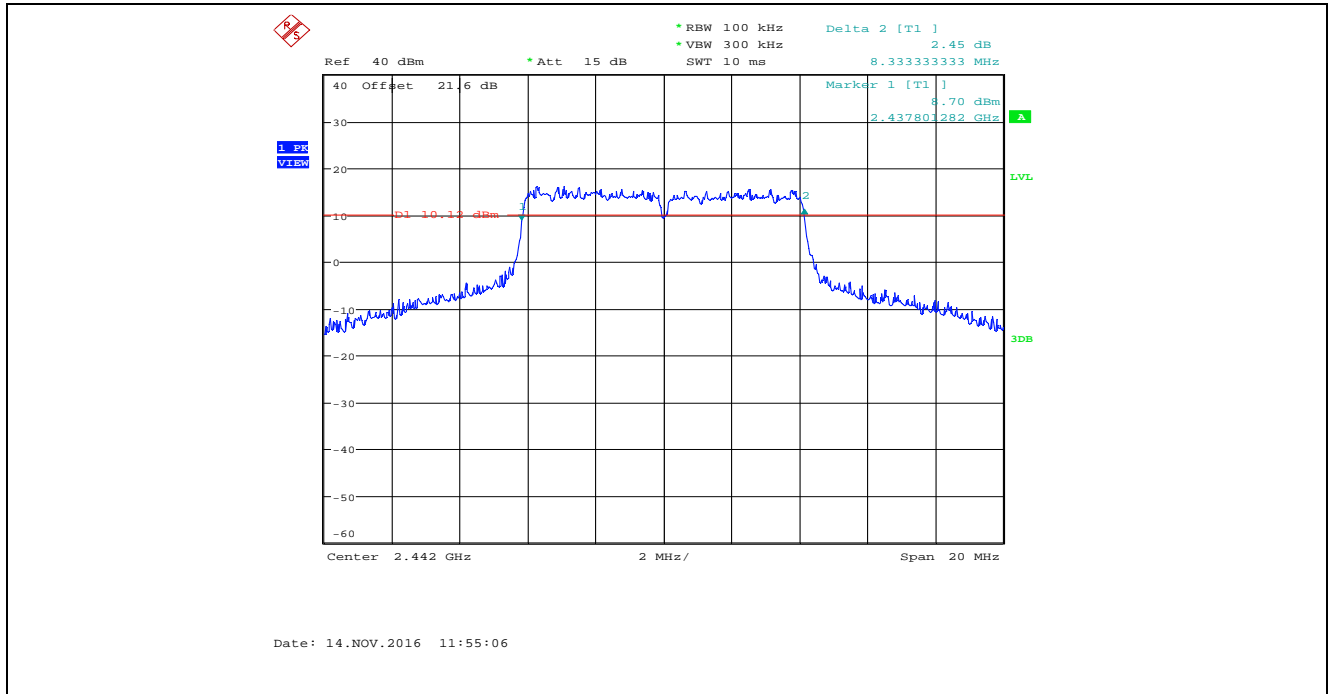

Plot 5.2.4.78. 6 dB Bandwidth, Bandwidth: 8 MHz, TX Gain: 55, Data Rate 6, 2477 MHz

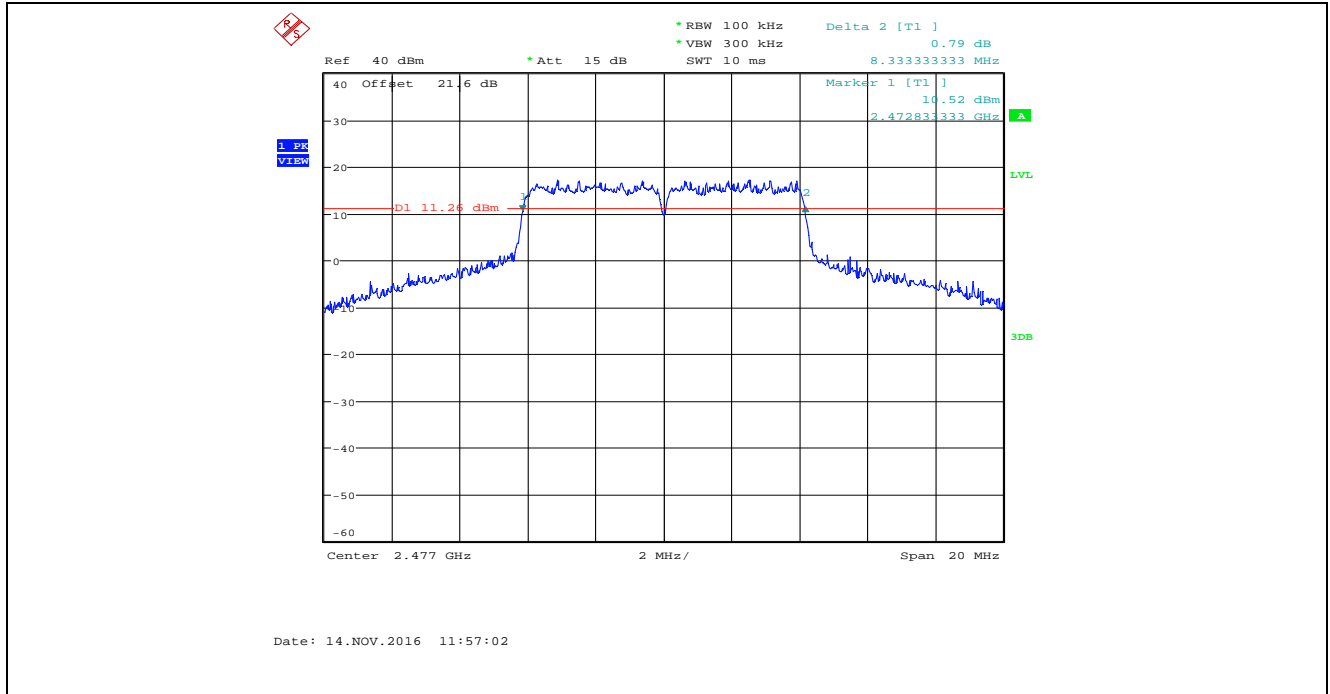

Plot 5.2.4.79. 6 dB Bandwidth, Bandwidth: 8 MHz, TX Gain: 55, Data Rate 7, 2407 MHz

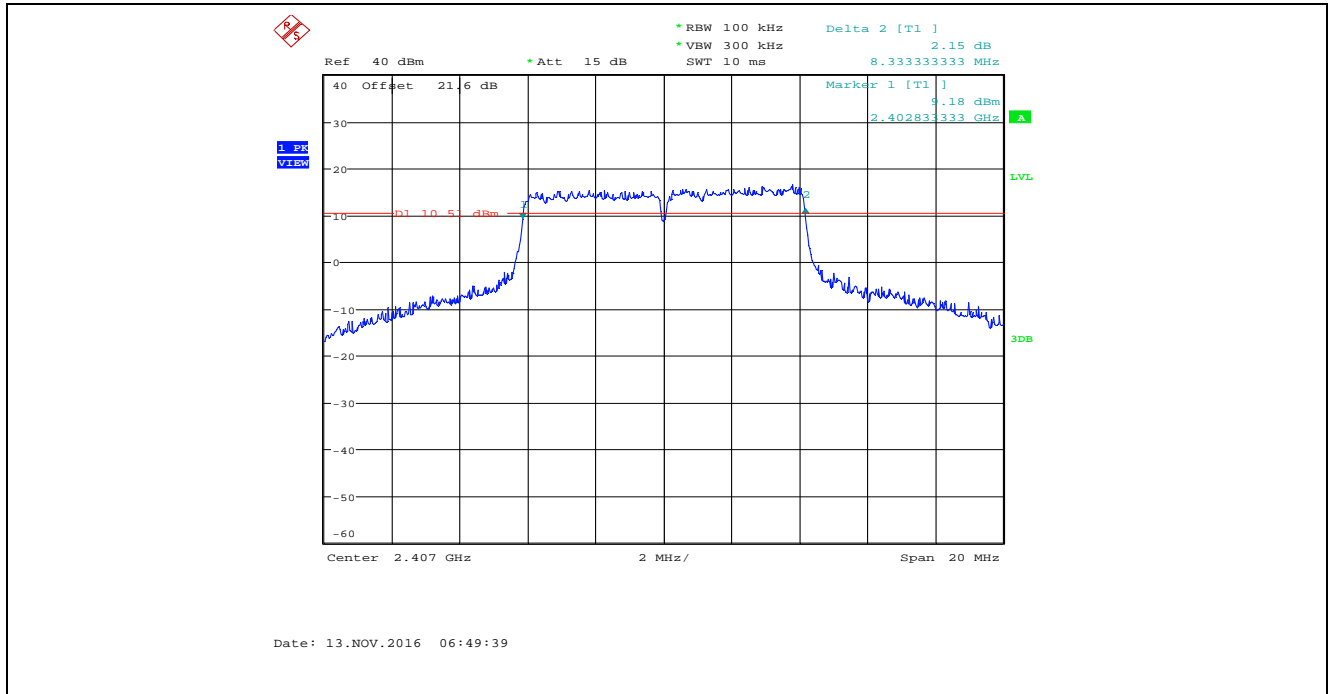

Plot 5.2.4.80. 6 dB Bandwidth, Bandwidth: 8 MHz, TX Gain: 55, Data Rate 7, 2442 MHz

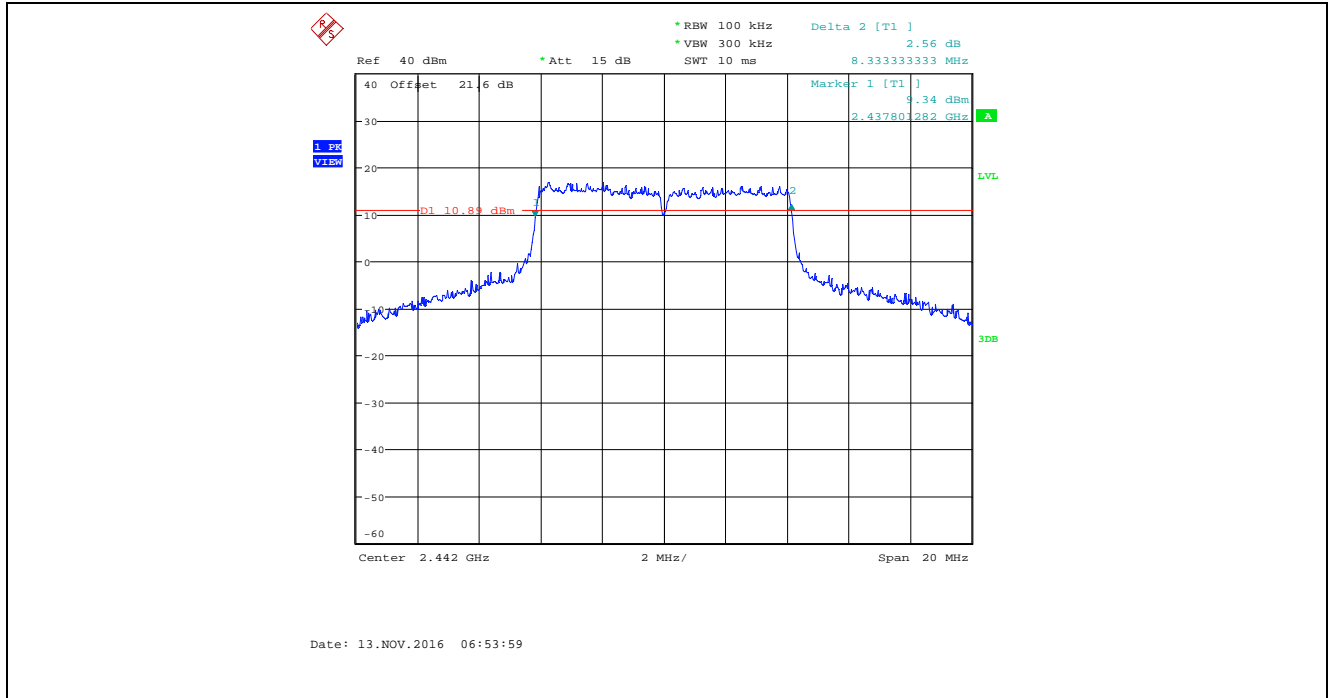

Plot 5.2.4.81. 6 dB Bandwidth, Bandwidth: 8 MHz, TX Gain: 55, Data Rate 7, 2477 MHz

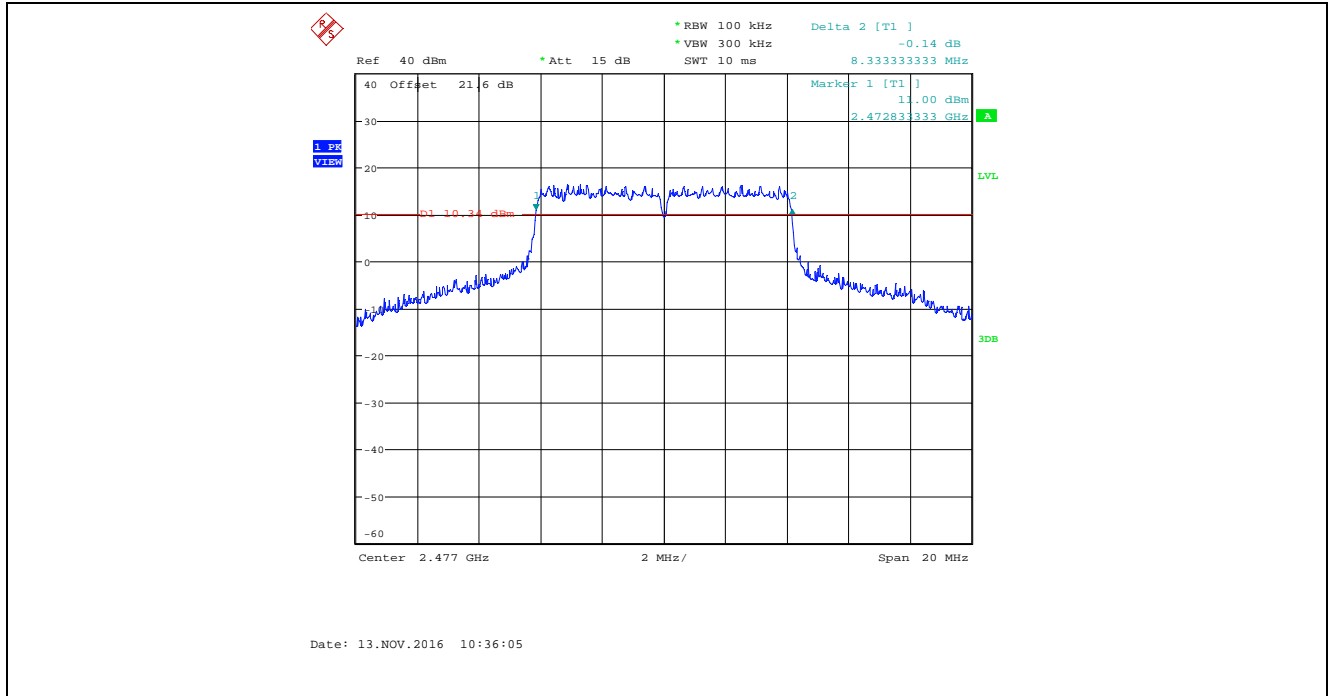

### 5.3. PEAK CONDUCTED OUTPUT POWER - DTS [§ 15.247(b)(3)]

#### 5.3.1. Limit(s)

**§ 15.247(b)(3):** For systems using digital modulation in the 902-928 MHz, 2400-2483.5 MHz, and 5725-5850 MHz bands: 1 Watt. As an alternative to a peak power measurement, compliance with the one Watt limit can be based on a measurement of the maximum conducted output power. Maximum Conducted Output Power is defined as the total transmit power delivered to all antennas and antenna elements averaged across all symbols in the signaling alphabet when the transmitter is operating at its maximum power control level. Power must be summed across all antennas and antenna elements. The average must not include any time intervals during which the transmitter is off or is transmitting at a reduced power level. If multiple modes of operation are possible (e.g., alternative modulation methods), the *maximum conducted output power* is the highest total transmit power occurring in any mode.

**§ 15.247(b)(4):** The conducted output power limit specified in paragraph (b) of this section is based on the use of antennas with directional gains that do not exceed 6 dBi. Except as shown in paragraph (c) of this section, if transmitting antennas of directional gain greater than 6 dBi are used, the conducted output power from the intentional radiator shall be reduced below the stated values in paragraphs (b)(1), (b)(2), and (b)(3) of this section, as appropriate, by the amount in dB that the directional gain of the antenna exceeds 6 dBi.

#### 5.3.2. Method of Measurements & Test Arrangement

KDB 558074 D01 DTS Meas Guidance v03r05, Section 9.1.2 PKPM1 Peak power meter method

#### 5.3.3. Test Arrangement

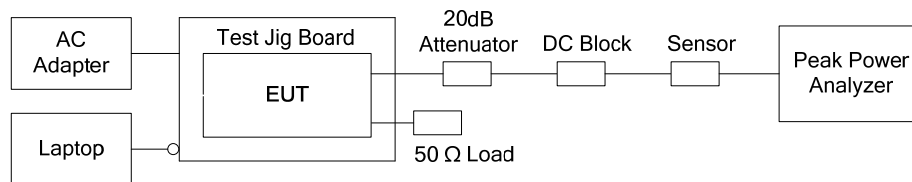

**5.3.4. Test Data**

Remarks:

1. The EIRP shall be calculated based on the transmitter antenna gain ( $G_{dBi}$ ), cable loss ( $CL_{dB}$ ) and peak output power at antenna terminal ( $P_{dBm}$ ). Calculated EIRP =  $P_{dBm} + G_{dBi} - CL_{dB}$
2. EIRP shall not exceed 36 dBm limit (Power Setting = 36 dBm -  $G_{dBi} + CL_{dB}$ ). See Operating Manual for instruction of power setting.

Operating Mode	Data Rate	Frequency (MHz)	Peak Power (dBm)	Peak Power Limit (dBm)	Margin (dBm)
High Power (TX Gain Setting 26) Bandwidth: 1 MHz	1	2402	20.72	30	-9.28
		2442	23.16	30	-6.84
		2482	23.03	30	-6.97
	2	2402	20.86	30	-9.14
		2442	23.01	30	-6.99
		2482	23.00	30	-7.00
High Power (TX Gain Setting 32) Bandwidth: 2 MHz	1	2402	23.64	30	-6.36
		2442	25.69	30	-4.31
		2482	24.79	30	-5.21
	2	2402	23.72	30	-6.28
		2442	25.93	30	-4.07
		2482	25.27	30	-4.73
	3	2402	23.88	30	-6.12
		2442	25.90	30	-4.10
		2482	25.22	30	-4.78
High Power (TX Gain Setting 43) Bandwidth: 4 MHz	1	2403	28.01	30	-1.99
		2442	29.34	30	-0.66
		2480	28.61	30	-1.39
	2	2403	27.78	30	-2.22
		2442	29.13	30	-0.87
		2480	28.65	30	-1.35
	3	2403	28.47	30	-1.53
		2442	29.47	30	-0.53
		2480	28.69	30	-1.31

Operating Mode	Data Rate	Frequency (MHz)	Peak Power (dBm)	Peak Power Limit (dBm)	Margin (dBm)
High Power (TX Gain Setting 50) Bandwidth: 8 MHz	1	2407	29.95	30	-0.05
		2442	29.99	30	-0.01
		2477	29.97	30	-0.03
	2	2407	29.98	30	-0.02
		2442	29.98	30	-0.02
		2477	29.96	30	-0.04
	3	2407	29.98	30	-0.02
		2442	29.98	30	-0.02
		2477	29.95	30	-0.05
High Power (TX Gain Setting 43) Bandwidth: 1 MHz	4	2402	29.95	30	-0.05
		2442	29.65	30	-0.35
		2482	29.94	30	-0.06
	5	2402	29.99	30	-0.01
		2442	29.98	30	-0.02
		2482	29.99	30	-0.01
	6	2402	29.97	30	-0.03
		2442	29.95	30	-0.05
		2482	29.99	30	-0.01
	7	2402	29.83	30	-0.17
		2442	29.84	30	-0.16
		2482	29.99	30	-0.01

**ULTRATECH GROUP OF LABS**

3000 Bristol Circle, Oakville, Ontario, Canada L6H 6G4  
 Tel. #: 905-829-1570, Fax. #: 905-829-8050, Email: [vic@ultratech-labs.com](mailto:vic@ultratech-labs.com), Website: <http://www.ultratech-labs.com>

File #: 17MCRS101\_FCC15C247D2G4

April 13, 2017

*All test results contained in this engineering test report are traceable to National Institute of Standards and Technology (NIST)*

Operating Mode	Data Rate	Frequency (MHz)	Peak Power (dBm)	Peak Power Limit (dBm)	Margin (dBm)
High Power (TX Gain Setting 45) Bandwidth: 2 MHz	4	2402	29.98	30	-0.02
		2442	29.97	30	-0.03
		2482	29.99	30	-0.01
	5	2402	29.99	30	-0.01
		2442	29.98	30	-0.02
		2482	29.99	30	-0.01
	6	2402	29.98	30	-0.02
		2442	29.99	30	-0.01
		2482	29.97	30	-0.03
	7	2402	29.97	30	-0.03
		2442	29.99	30	-0.01
		2482	29.99	30	-0.01
High Power (TX Gain Setting 50) Bandwidth: 4 MHz	4	2403	29.98	30	-0.02
		2442	29.99	30	-0.01
		2480	29.99	30	-0.01
	5	2403	29.99	30	-0.01
		2442	29.98	30	-0.02
		2480	29.97	30	-0.03
	6	2403	29.98	30	-0.02
		2442	29.99	30	-0.01
		2480	29.98	30	-0.02
	7	2403	29.99	30	-0.01
		2442	29.99	30	-0.01
		2480	29.97	30	-0.03

**ULTRATECH GROUP OF LABS**

3000 Bristol Circle, Oakville, Ontario, Canada L6H 6G4  
 Tel. #: 905-829-1570, Fax. #: 905-829-8050, Email: [vic@ultratech-labs.com](mailto:vic@ultratech-labs.com), Website: <http://www.ultratech-labs.com>

File #: 17MCRS101\_FCC15C247D2G4

April 13, 2017

*All test results contained in this engineering test report are traceable to National Institute of Standards and Technology (NIST)*



Operating Mode	Data Rate	Frequency (MHz)	Peak Power (dBm)	Peak Power Limit (dBm)	Margin (dBm)
High Power (TX Gain Setting 55) Bandwidth: 8 MHz	4	2407	29.99	30	-0.01
		2442	29.99	30	-0.01
		2477	29.97	30	-0.03
	5	2407	29.98	30	-0.02
		2442	29.99	30	-0.01
		2477	29.98	30	-0.02
	6	2407	29.99	30	-0.01
		2442	29.99	30	-0.01
		2477	29.98	30	-0.02
	7	2407	29.98	30	-0.02
		2442	29.99	30	-0.01
		2477	29.99	30	-0.01

Operating Mode	Data Rate	Frequency (MHz)	Peak Power (dBm)	Peak Power Limit (dBm)	Margin (dBm)
Low Power (TX Gain Setting 0) Bandwidth: 1 MHz	1	2402	8.04	30	-21.96
		2442	10.39	30	-19.61
		2482	11.31	30	-18.69
	2	2402	8.10	30	-21.90
		2442	9.86	30	-20.14
		2482	11.32	30	-18.68
Low Power (TX Gain Setting 0) Bandwidth: 2 MHz	1	2402	7.57	30	-22.43
		2442	8.39	30	-21.61
		2482	9.53	30	-20.47
	2	2402	7.55	30	-22.45
		2442	8.25	30	-21.75
		2482	9.22	30	-20.78
	3	2402	7.38	30	-22.62
		2442	8.05	30	-21.95
		2482	9.02	30	-20.98
Low Power (TX Gain Setting 0) Bandwidth: 4 MHz	1	2403	7.85	30	-22.15
		2442	8.63	30	-21.37
		2480	9.68	30	-20.32
	2	2403	8.36	30	-21.64
		2442	9.15	30	-20.85
		2480	9.82	30	-20.18
	3	2403	7.45	30	-22.55
		2442	8.19	30	-21.81
		2480	9.17	30	-20.83

**ULTRATECH GROUP OF LABS**

3000 Bristol Circle, Oakville, Ontario, Canada L6H 6G4  
 Tel. #: 905-829-1570, Fax. #: 905-829-8050, Email: [vic@ultratech-labs.com](mailto:vic@ultratech-labs.com), Website: <http://www.ultratech-labs.com>

File #: 17MCRS101\_FCC15C247D2G4

April 13, 2017

*All test results contained in this engineering test report are traceable to National Institute of Standards and Technology (NIST)*

Operating Mode	Data Rate	Frequency (MHz)	Peak Power (dBm)	Peak Power Limit (dBm)	Margin (dBm)
Low Power (TX Gain Setting 0) Bandwidth: 8 MHz	1	2407	7.79	30	-22.21
		2442	9.46	30	-20.54
		2477	10.44	30	-19.56
	2	2407	8.76	30	-21.24
		2442	9.65	30	-20.35
		2477	10.44	30	-19.56
	3	2407	7.96	30	-22.04
		2442	9.24	30	-20.76
		2477	10.14	30	-19.86
Low Power (TX Gain Setting 0) Bandwidth: 1 MHz	4	2402	9.19	30	-20.81
		2442	11.43	30	-18.57
		2482	12.32	30	-17.68
	5	2402	9.77	30	-20.23
		2442	10.67	30	-19.33
		2482	13.34	30	-16.66
	6	2402	10.63	30	-19.37
		2442	14.03	30	-15.97
		2482	13.79	30	-16.21
	7	2402	10.06	30	-19.94
		2442	15.54	30	-14.46
		2482	15.65	30	-14.35

**ULTRATECH GROUP OF LABS**

3000 Bristol Circle, Oakville, Ontario, Canada L6H 6G4  
 Tel. #: 905-829-1570, Fax. #: 905-829-8050, Email: [vic@ultratech-labs.com](mailto:vic@ultratech-labs.com), Website: <http://www.ultratech-labs.com>

File #: 17MCRS101\_FCC15C247D2G4

April 13, 2017

*All test results contained in this engineering test report are traceable to National Institute of Standards and Technology (NIST)*

Operating Mode	Data Rate	Frequency (MHz)	Peak Power (dBm)	Peak Power Limit (dBm)	Margin (dBm)
Low Power (TX Gain Setting 0) Bandwidth: 2 MHz	4	2402	10.38	30	-19.62
		2442	11.91	30	-18.09
		2482	12.64	30	-17.36
	5	2402	10.76	30	-19.24
		2442	11.83	30	-18.17
		2482	12.50	30	-17.50
	6	2402	10.76	30	-19.24
		2442	14.67	30	-15.33
		2482	16.55	30	-13.45
	7	2402	10.15	30	-19.85
		2442	14.22	30	-15.78
		2482	16.57	30	-13.43
Low Power (TX Gain Setting 0) Bandwidth: 4 MHz	4	2403	10.68	30	-19.32
		2442	11.18	30	-18.82
		2480	12.13	30	-17.87
	5	2403	10.05	30	-19.95
		2442	11.67	30	-18.33
		2480	12.51	30	-17.49
	6	2403	10.46	30	-19.54
		2442	11.34	30	-18.66
		2480	12.72	30	-17.28
	7	2403	10.40	30	-19.60
		2442	11.37	30	-18.63
		2480	12.51	30	-17.49

**ULTRATECH GROUP OF LABS**

3000 Bristol Circle, Oakville, Ontario, Canada L6H 6G4  
 Tel. #: 905-829-1570, Fax. #: 905-829-8050, Email: [vic@ultratech-labs.com](mailto:vic@ultratech-labs.com), Website: <http://www.ultratech-labs.com>

File #: 17MCRS101\_FCC15C247D2G4

April 13, 2017

*All test results contained in this engineering test report are traceable to National Institute of Standards and Technology (NIST)*

Operating Mode	Data Rate	Frequency (MHz)	Peak Power (dBm)	Peak Power Limit (dBm)	Margin (dBm)
Low Power (TX Gain Setting 0) Bandwidth: 8 MHz	4	2407	10.75	30	-19.25
		2442	11.39	30	-18.61
		2477	12.58	30	-17.42
	5	2407	10.87	30	-19.13
		2442	11.15	30	-18.85
		2477	12.26	30	-17.74
	6	2407	10.83	30	-19.17
		2442	12.09	30	-17.91
		2477	12.50	30	-17.50
	7	2407	10.33	30	-19.67
		2442	12.78	30	-17.22
		2477	12.93	30	-17.07

## 5.4. TRANSMITTER BAND-EDGE & SPURIOUS CONDUCTED EMISSIONS [§ 15.247(d)]

### 5.4.1. Limit(s)

**§ 15.247 (d):** In any 100 kHz bandwidth outside the frequency band in which the spread spectrum or digitally modulated intentional radiator is operating, the radio frequency power that is produced by the intentional radiator shall be at least 20 dB below that in the 100 kHz bandwidth within the band that contains the highest level of the desired power, based on either an RF conducted or a radiated measurement, provided the transmitter demonstrates compliance with the peak conducted power limits. If the transmitter complies with the conducted power limits based on the use of RMS averaging over a time interval, as permitted under paragraph (b)(3) of this section, the attenuation required under this paragraph shall be 30 dB instead of 20 dB. Attenuation below the general limits specified in §15.209(a) is not required. In addition, radiated emissions which fall in the restricted bands, as defined in §15.205(a), must also comply with the radiated emission limits specified in §15.209(a) (see §15.205(c)).

### 5.4.2. Method of Measurements

KDB 558074 D01 DTS Meas Guidance V03r05, Sections 11, 12 and 13.

### 5.4.3. Test Arrangement

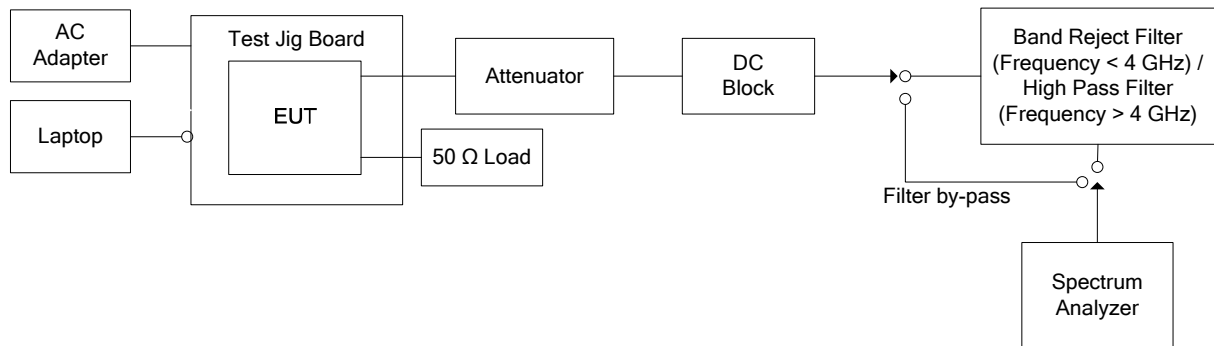

### 5.4.4. Test Data

Remark(s): Exploratory tests performed to determined worst-case test configurations, the following test results represent the worst-case.

#### 5.4.4.1. Band-Edge RF Conducted Emissions

**Plot 5.4.4.1.1. Band-Edge RF Conducted Emissions**  
Bandwidth: 1 MHz, TX Gain Setting: 26, Data Rate 2, 2402 MHz, Lower Band-edge

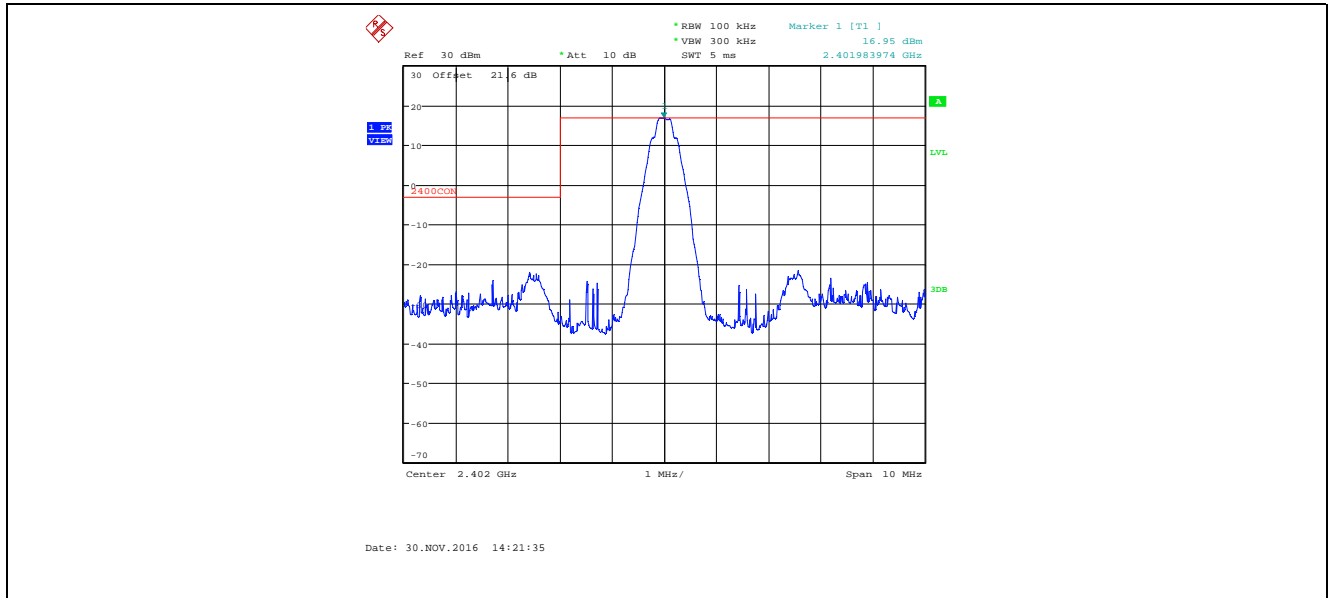

**Plot 5.4.4.1.2. Band-Edge RF Conducted Emissions**  
Bandwidth: 1 MHz, TX Gain Setting: 26, Data Rate 2, 2482 MHz, Higher Band-edge

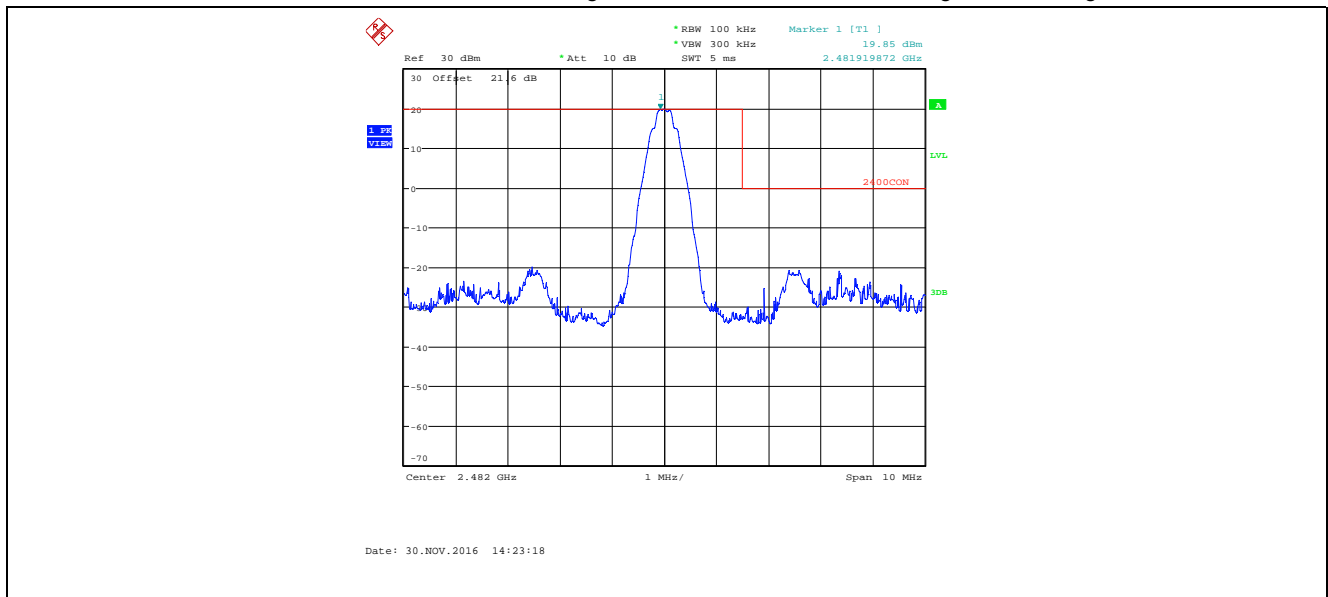

**Plot 5.4.4.1.3. Band-Edge RF Conducted Emissions**  
Bandwidth: 2 MHz, TX Gain Setting: 32 Data Rate 3, 2402 MHz, Lower Band-edge

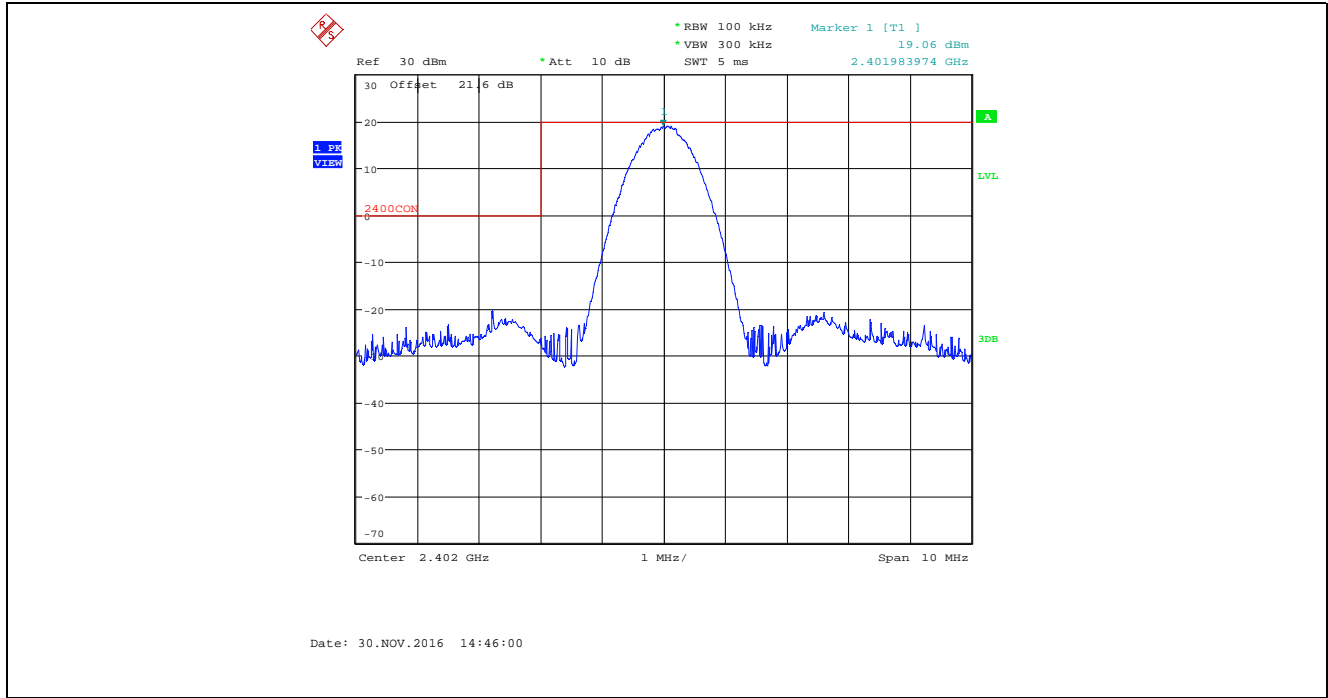

**Plot 5.4.4.1.4. Band-Edge RF Conducted Emissions**  
Bandwidth: 2 MHz, TX Gain Setting: 32, Data Rate 3, 2482 MHz, Higher Band-edge

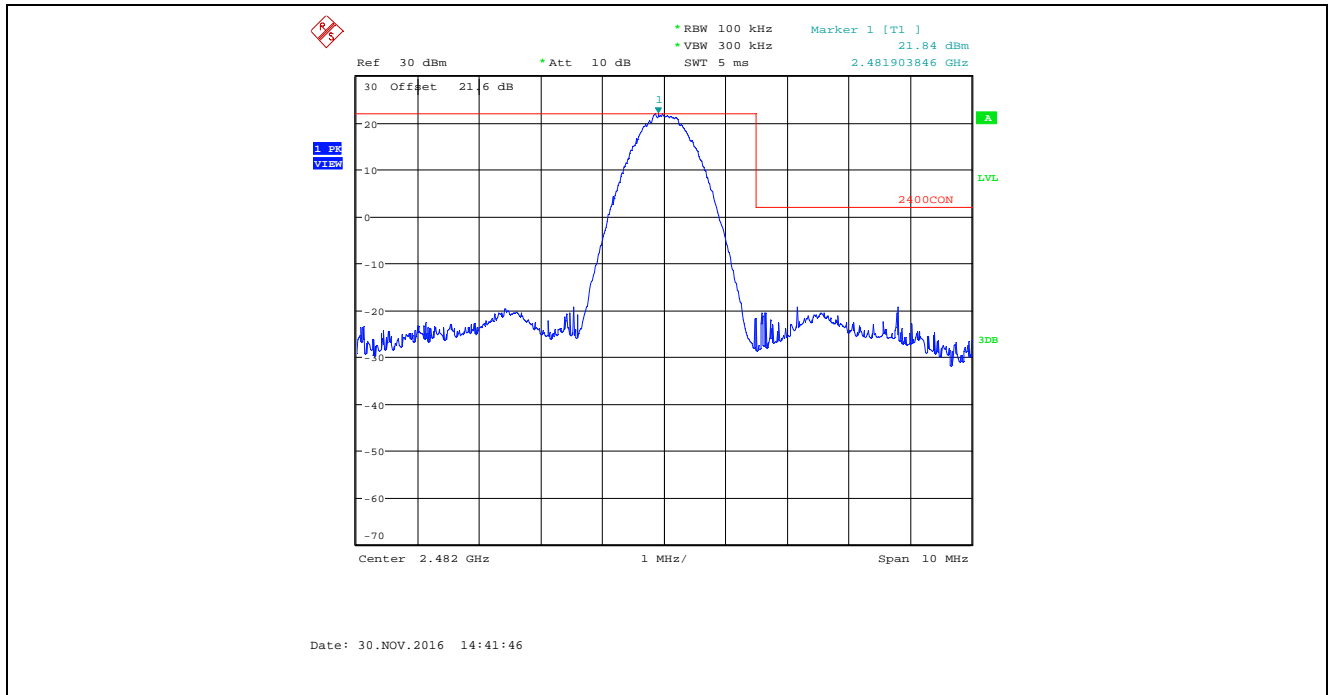



**Plot 5.4.4.1.5. Band-Edge RF Conducted Emissions**  
Bandwidth: 4 MHz, TX Gain Setting: 43, Data Rate 3, 2403 MHz, Lower Band-edge

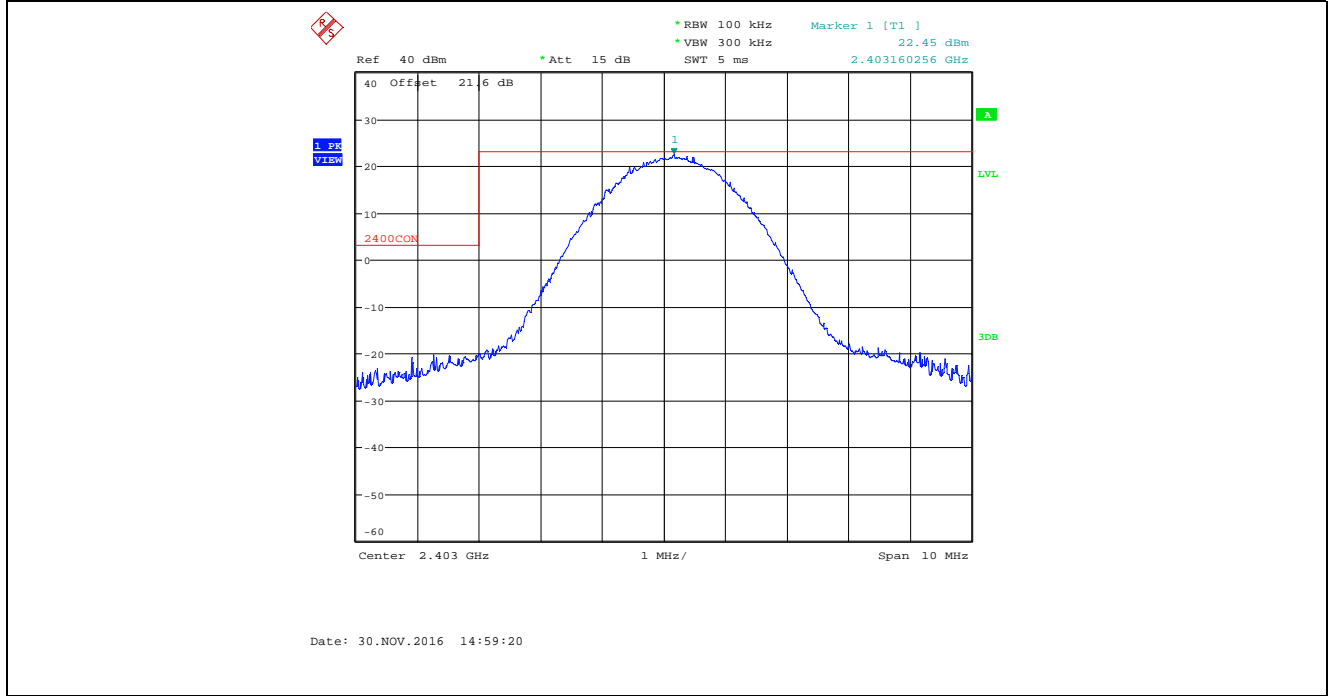

**Plot 5.4.4.1.6. Band-Edge RF Conducted Emissions**  
Bandwidth: 4 MHz, TX Gain Setting : 43, Data Rate 3, 2480 MHz, Higher Band-edge

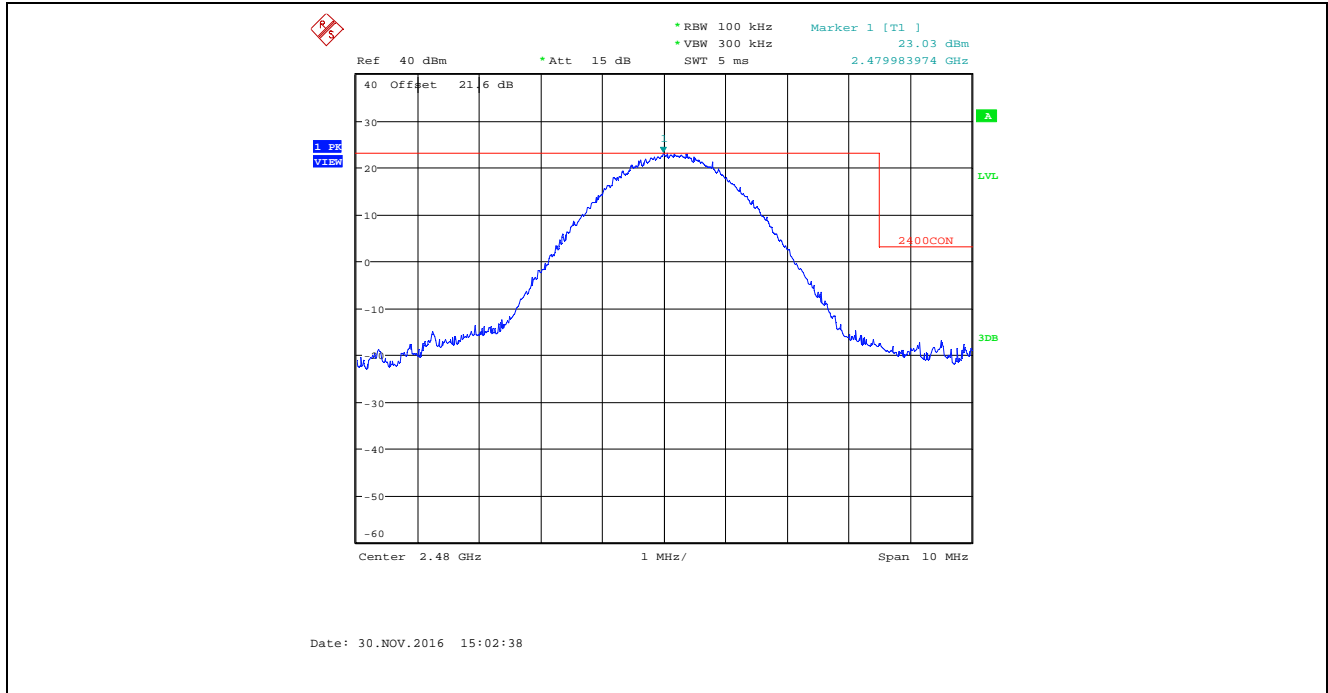

**Plot 5.4.4.1.7. Band-Edge RF Conducted Emissions**  
Bandwidth: 8 MHz, TX Gain Setting: 50, Data Rate 3, 2407 MHz, Lower Band-edge

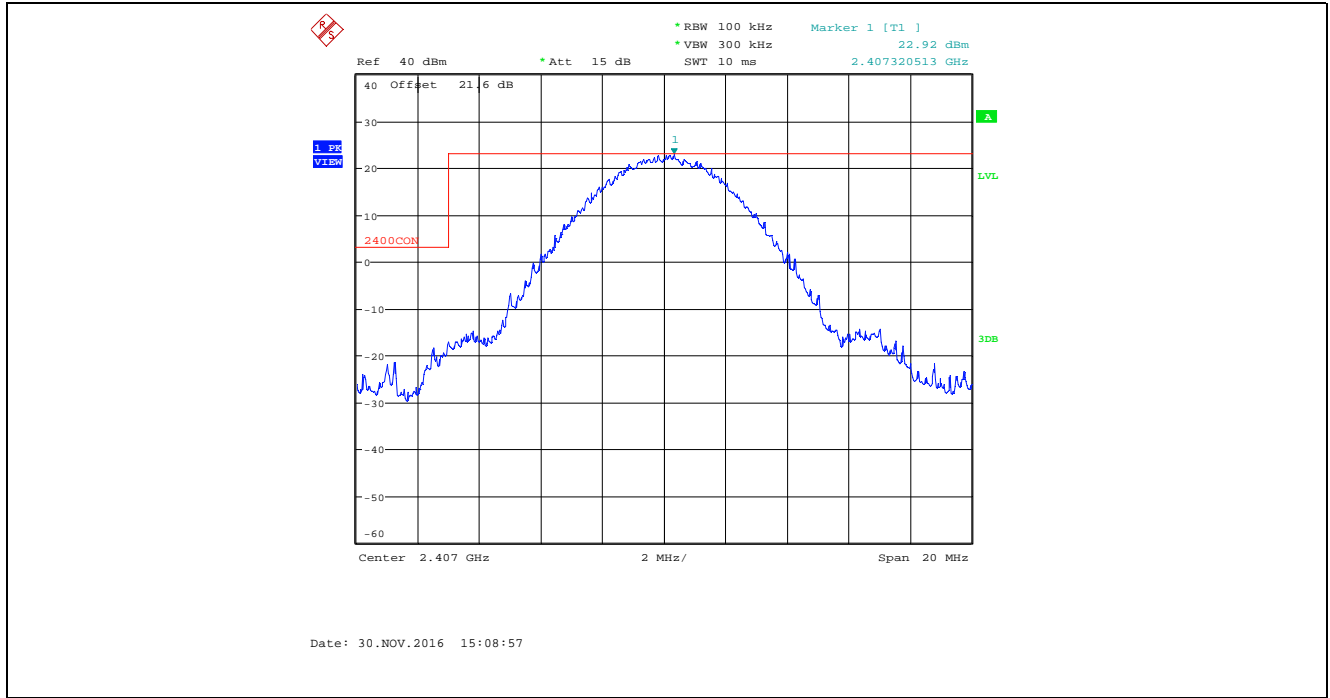

**Plot 5.4.4.1.8. Band-Edge RF Conducted Emissions**  
Bandwidth: 8 MHz, TX Gain Setting: 50, Data Rate 3, 2477 MHz, Higher Band-edge

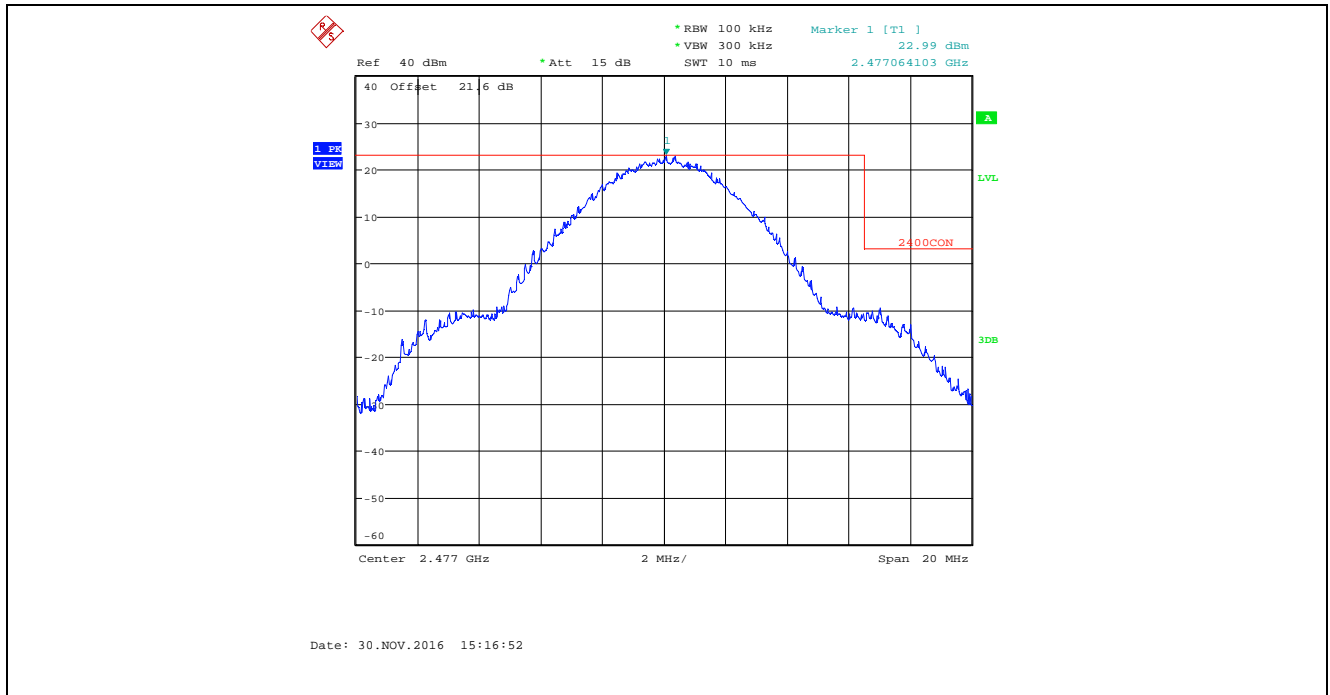

**Plot 5.4.4.1.9. Band-Edge RF Conducted Emissions**  
 Bandwidth: 1 MHz, TX Gain Setting: 43, Data Rate 7, 2402 MHz, Lower Band-edge

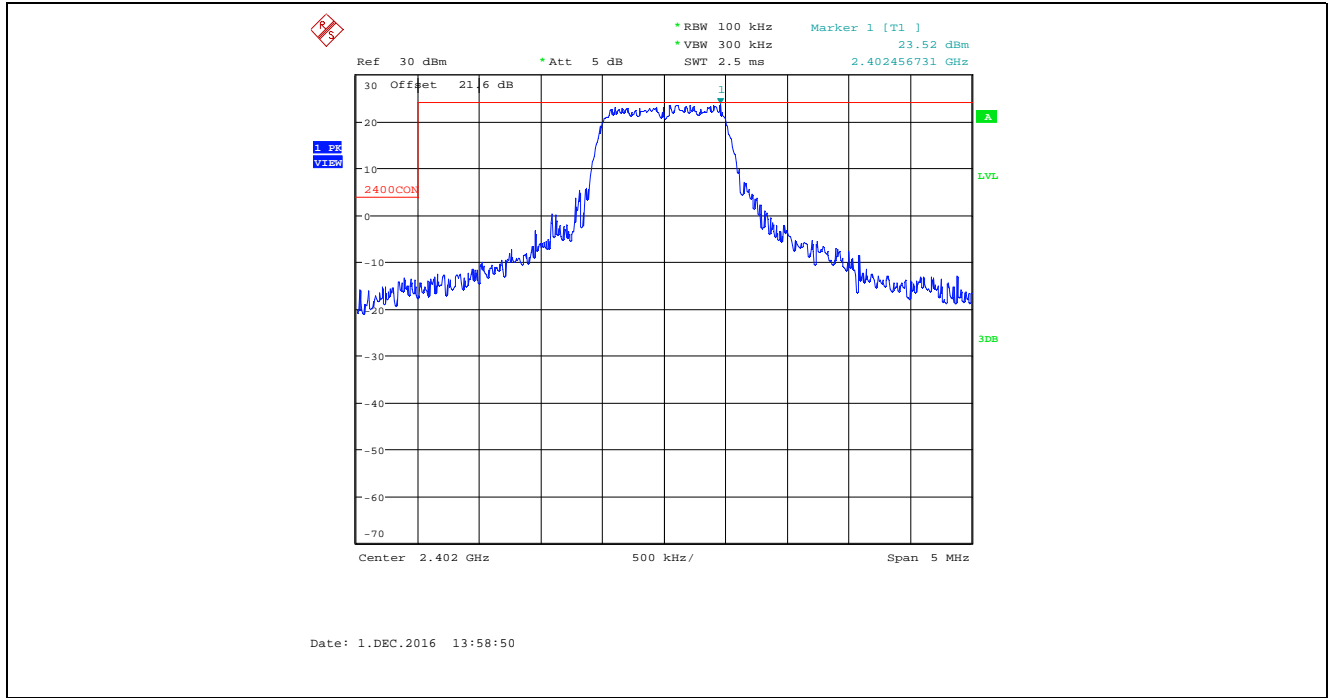

**Plot 5.4.4.1.10. Band-Edge RF Conducted Emissions**  
 Bandwidth: 1 MHz, TX Gain Setting: 43, Data Rate 7, 2482 MHz, Higher Band-edge

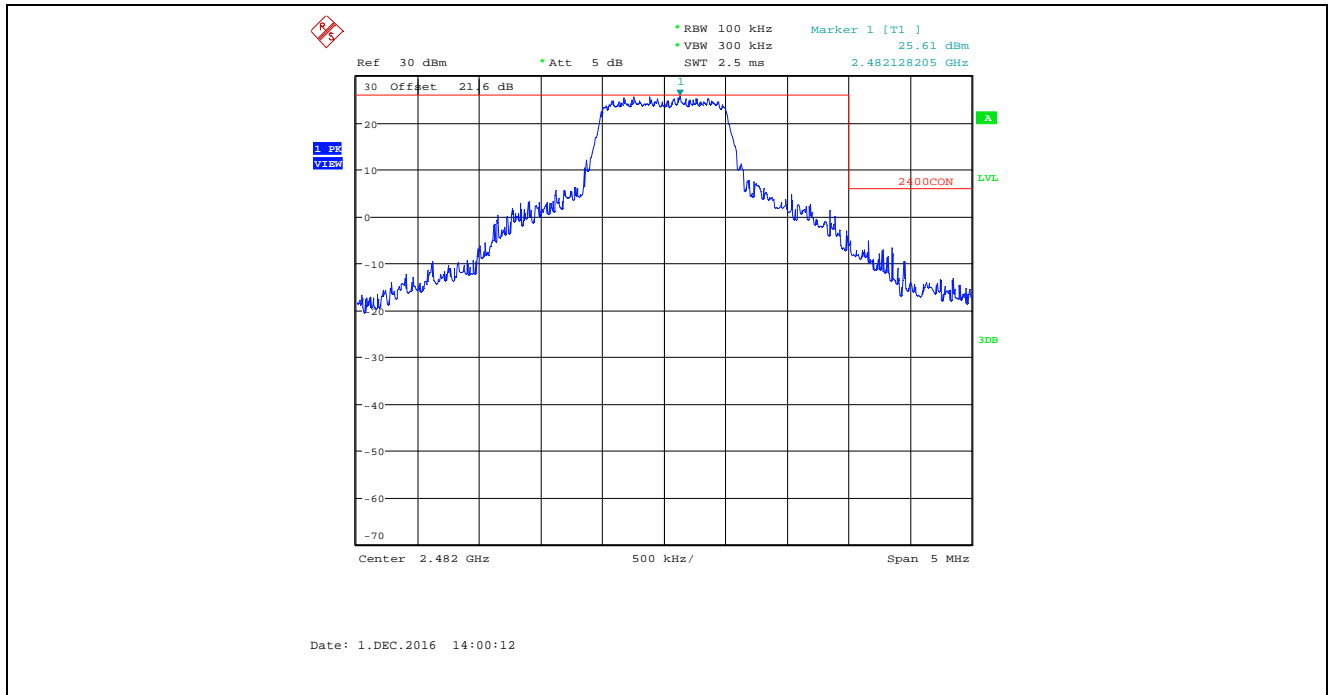

**Plot 5.4.4.1.11. Band-Edge RF Conducted Emissions**  
Bandwidth: 2 MHz, TX Gain Setting: 45, Data Rate 7, 2402 MHz, Lower Band-edge

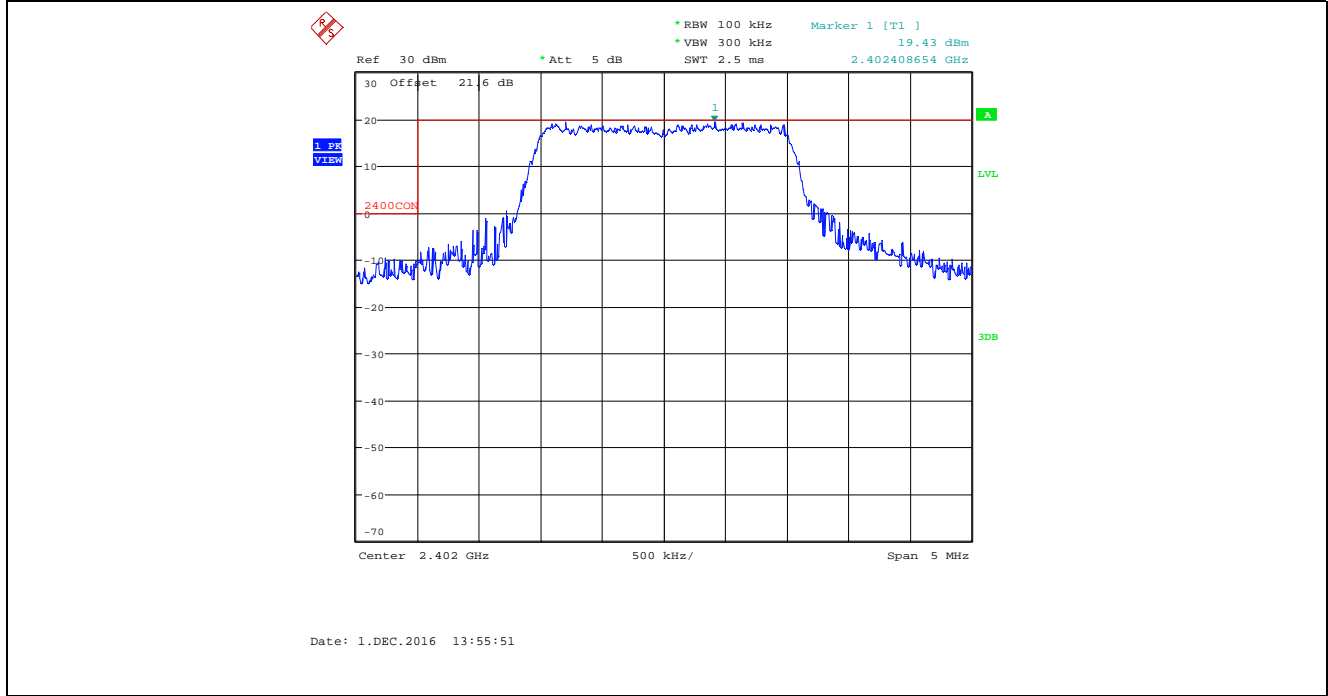

**Plot 5.4.4.1.12. Band-Edge RF Conducted Emissions**  
Bandwidth: 2 MHz, TX Gain Setting: 45, Data Rate 7, 2482 MHz, Higher Band-edge

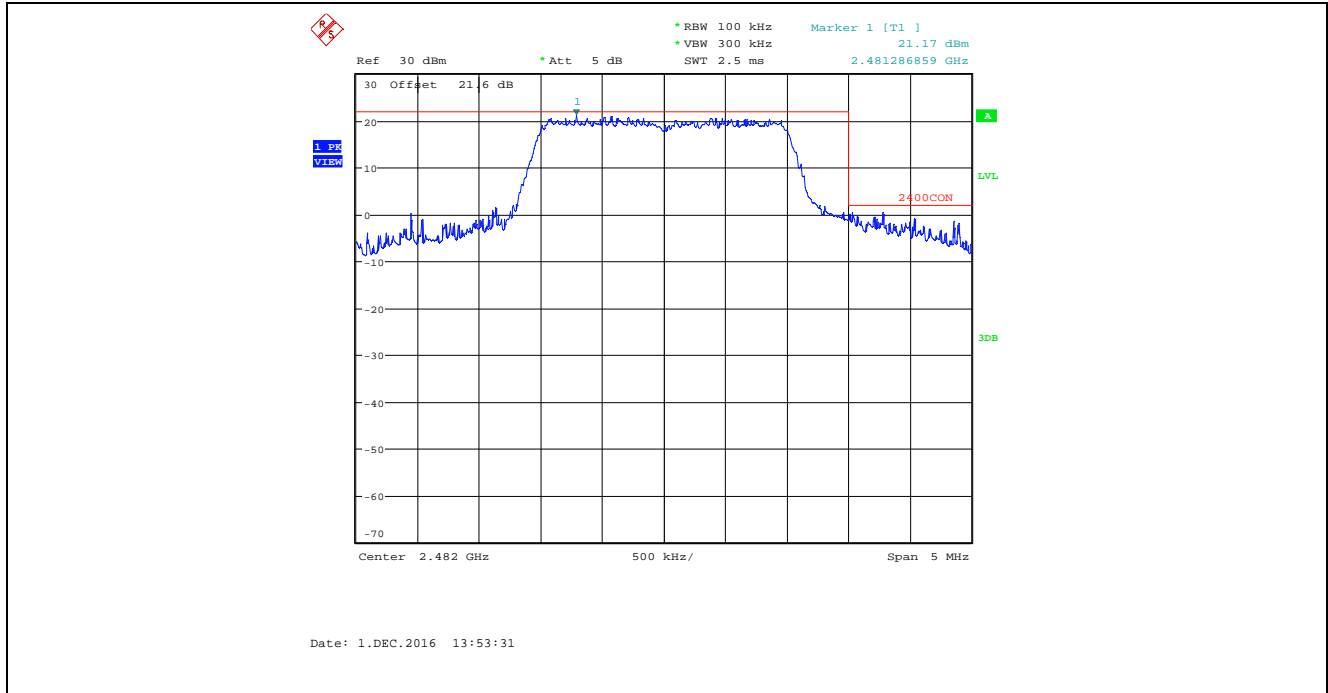

**Plot 5.4.4.1.13. Band-Edge RF Conducted Emissions**  
Bandwidth: 4 MHz, TX Gain Setting: 50, Data Rate 7, 2403 MHz, Lower Band-edge

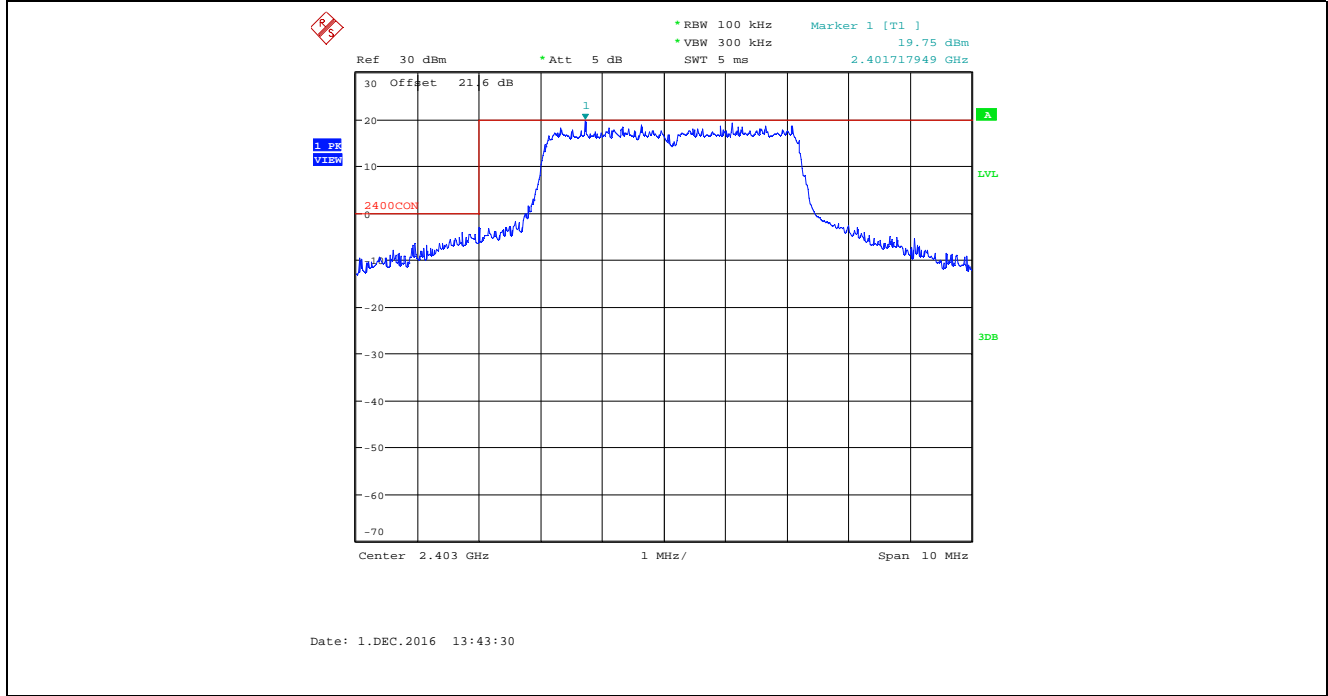

**Plot 5.4.4.1.14. Band-Edge RF Conducted Emissions**  
Bandwidth: 4 MHz, TX Gain Setting: 50, Data Rate 7, 2480 MHz, Higher Band-edge

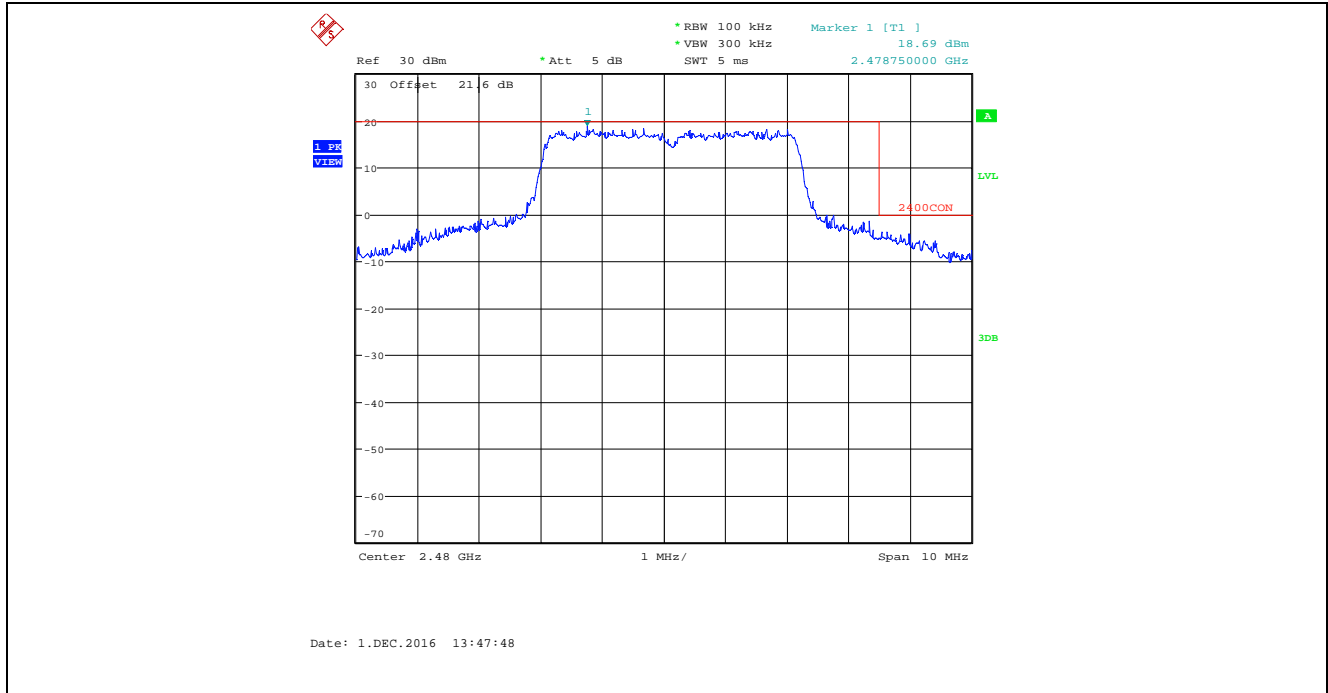

**Plot 5.4.4.1.15. Band-Edge RF Conducted Emissions**  
Bandwidth: 8 MHz, TX Gain Setting: 55, Data Rate 7, 2407 MHz, Lower Band-edge

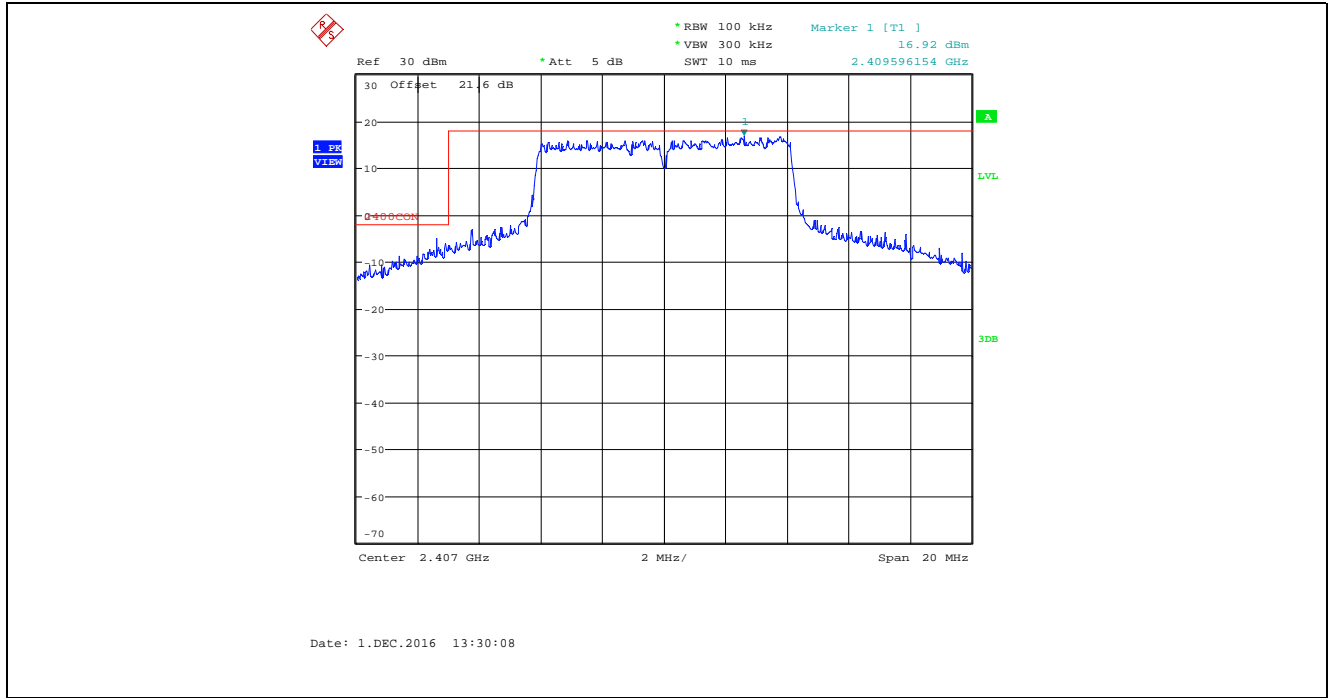

**Plot 5.4.4.1.16. Band-Edge RF Conducted Emissions**  
Bandwidth: 8 MHz, TX Gain Setting: 55, Data Rate 7, 2477 MHz, Higher Band-edge

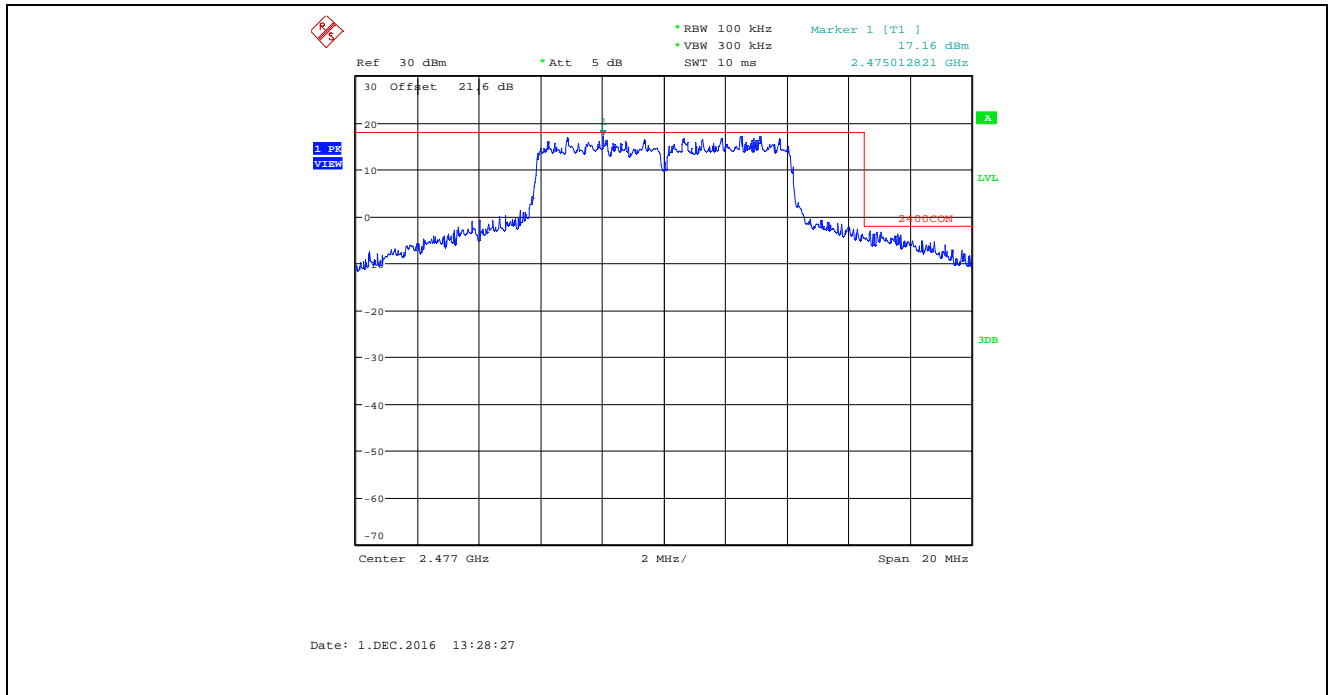

5.4.4.2. Spurious RF Conducted Emissions in Non-restricted Frequency Bands

Plot 5.4.4.2.1. Conducted Spurious Emissions in Non-restricted Frequency Bands  
 Bandwidth: 8, TX Gain: 50, Data Rate 1, 2407 MHz, 30 MHz – 2.6 GHz

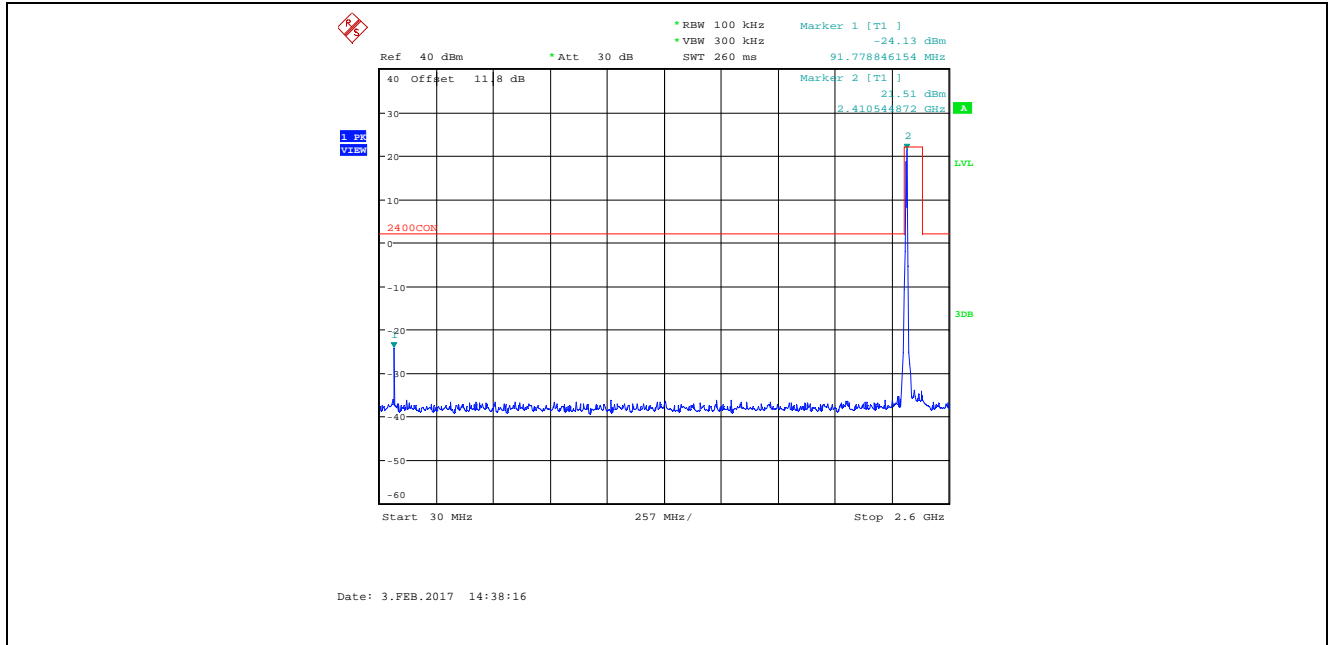

Plot 5.4.4.2.2. Conducted Spurious Emissions in Non-restricted Frequency Bands  
 Bandwidth: 8, TX Gain: 50, Data Rate 1, 2407 MHz, 2.6 GHz – 25 GHz

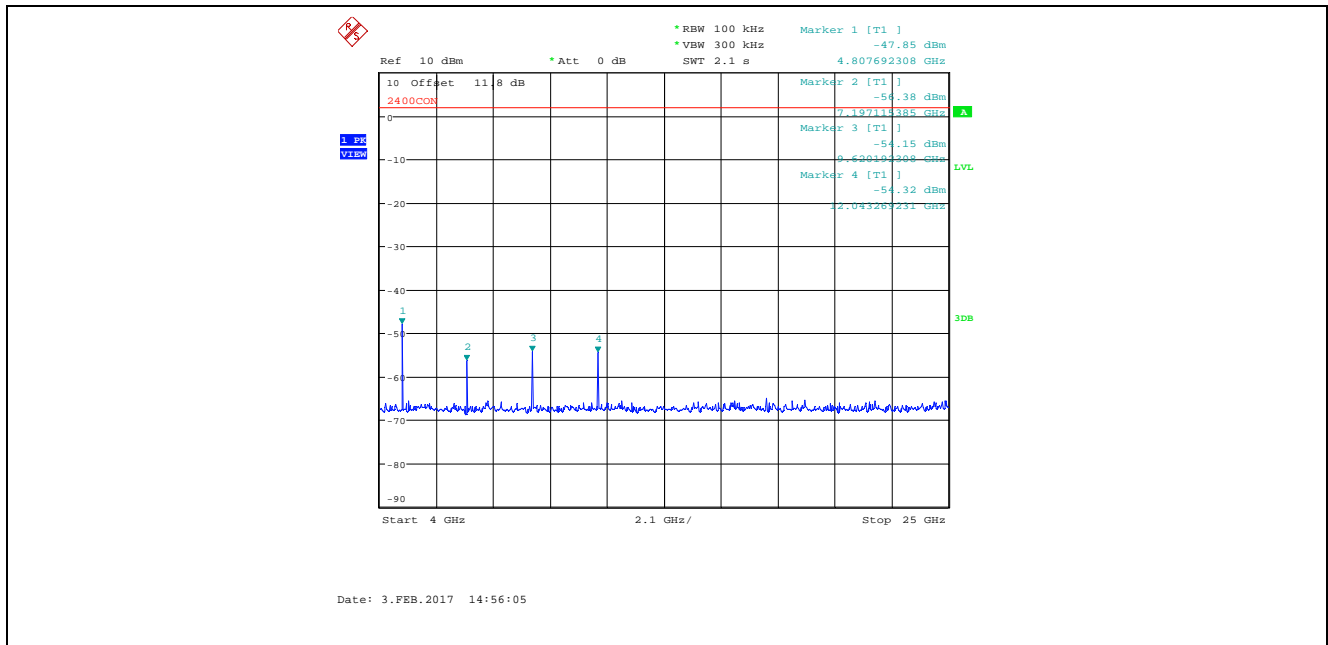

**Plot 5.4.4.2.3. Conducted Spurious Emissions in Non-restricted Frequency Bands**  
 Bandwidth: 8 MHz, TX Gain: 50, Data Rate 1, 2442 MHz, 30 MHz – 2.6 GHz

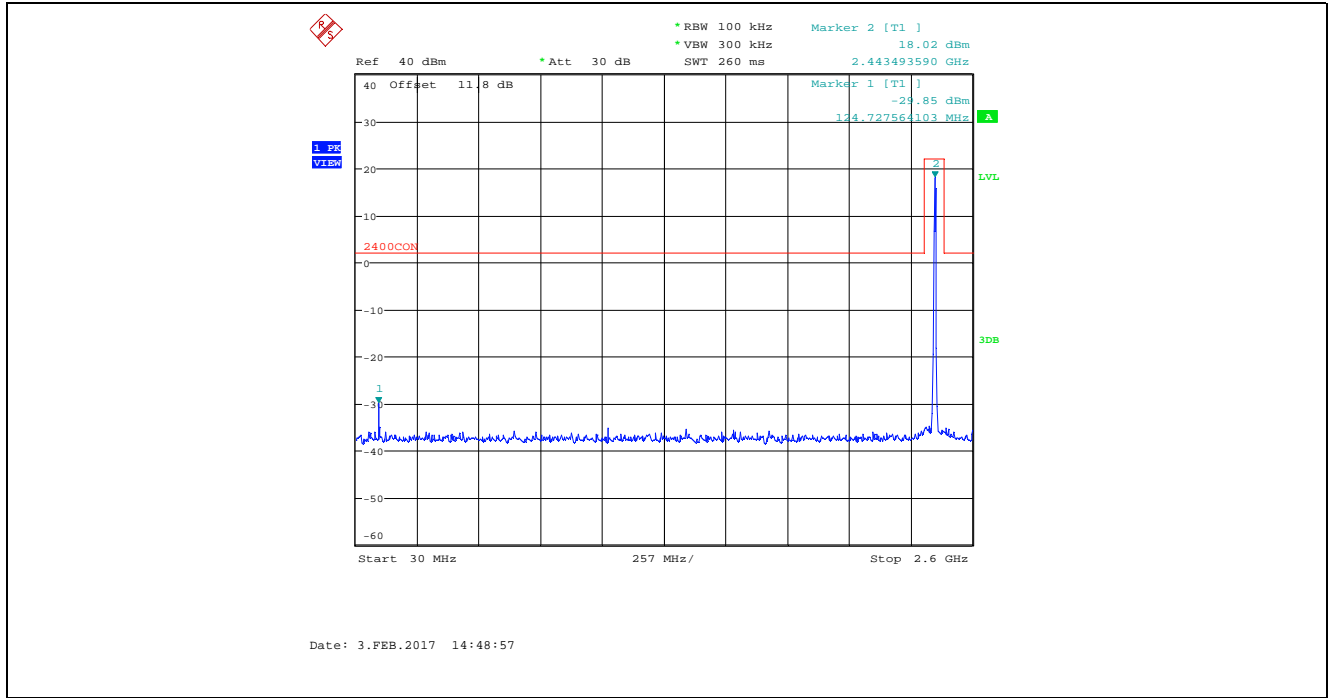

**Plot 5.4.4.2.4. Conducted Spurious Emissions in Non-restricted Frequency Bands**  
 Bandwidth: 8 MHz, TX Gain: 50, Data Rate 1, 2442 MHz, 2.6 GHz – 25 GHz

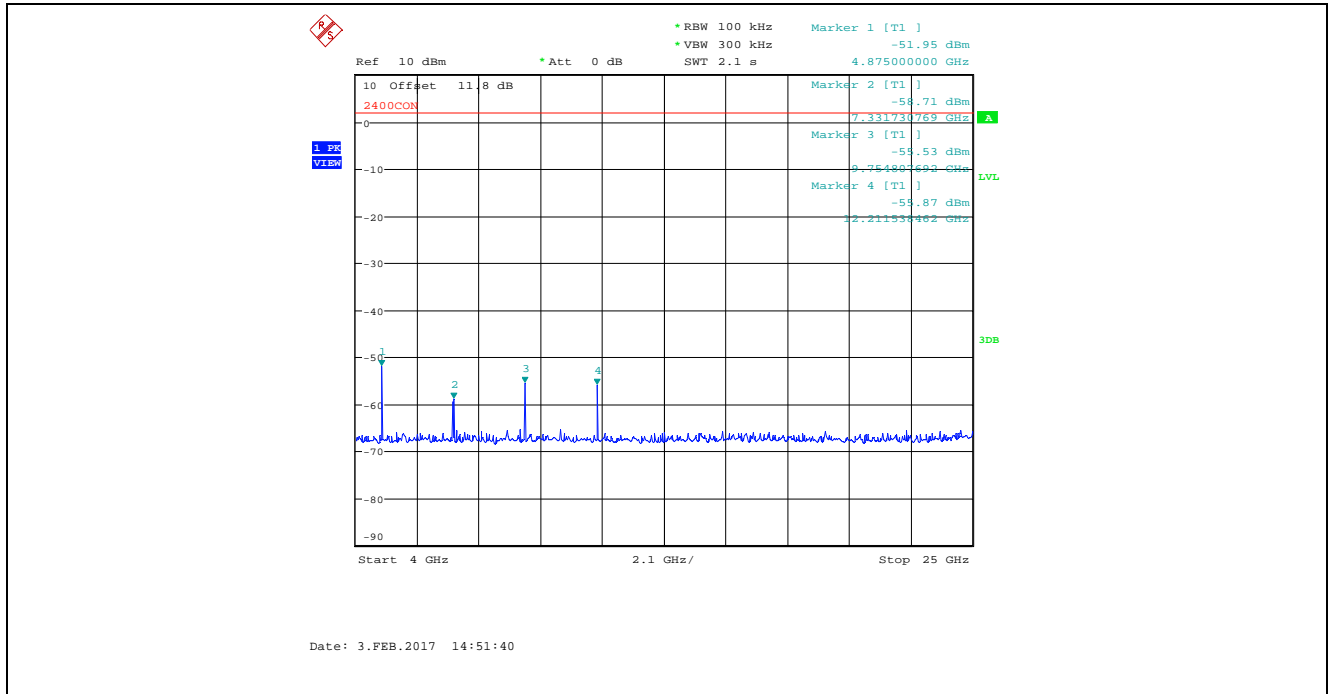



**Plot 5.4.4.2.5. Conducted Spurious Emissions in Non-restricted Frequency Bands**  
 Bandwidth: 8 MHz, TX Gain: 50, Data Rate 1, 2477 MHz, 30 MHz – 2.6 GHz

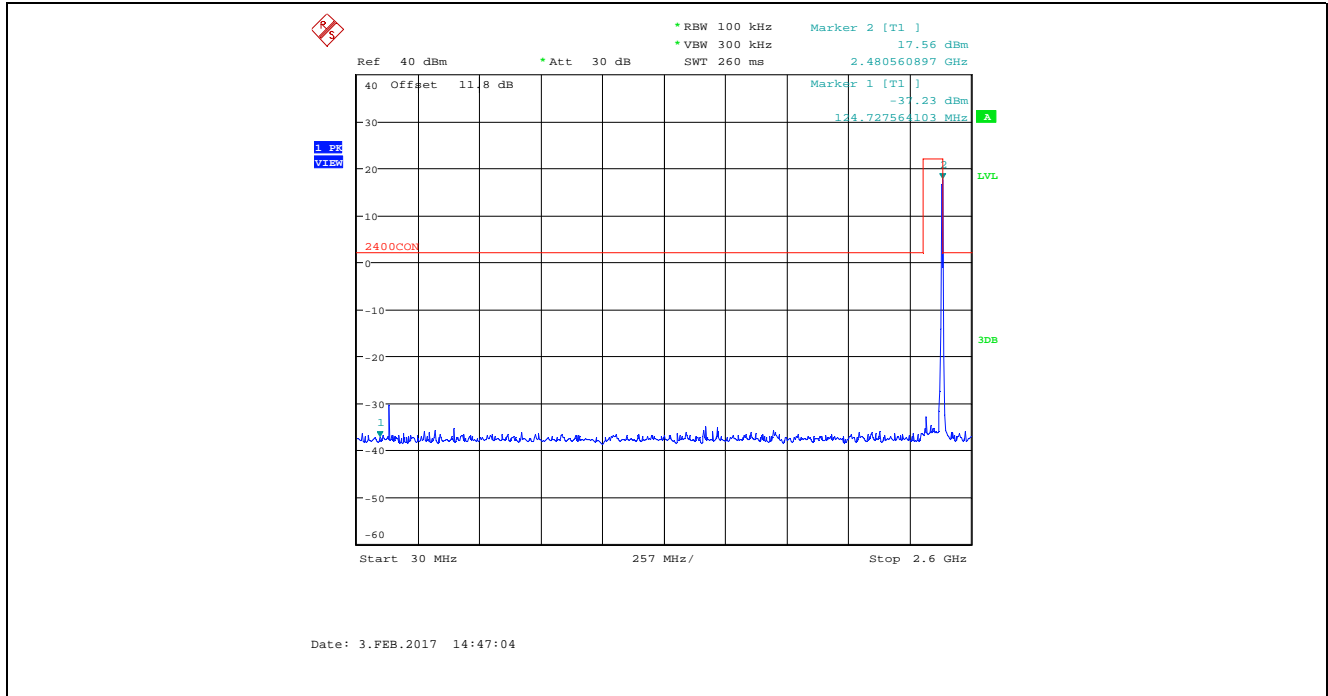

**Plot 5.4.4.2.6. Conducted Spurious Emissions in Non-restricted Frequency Bands**  
 Bandwidth: 8 MHz, TX Gain: 50, Data Rate 1, 2477 MHz, 2.6 GHz – 25 GHz

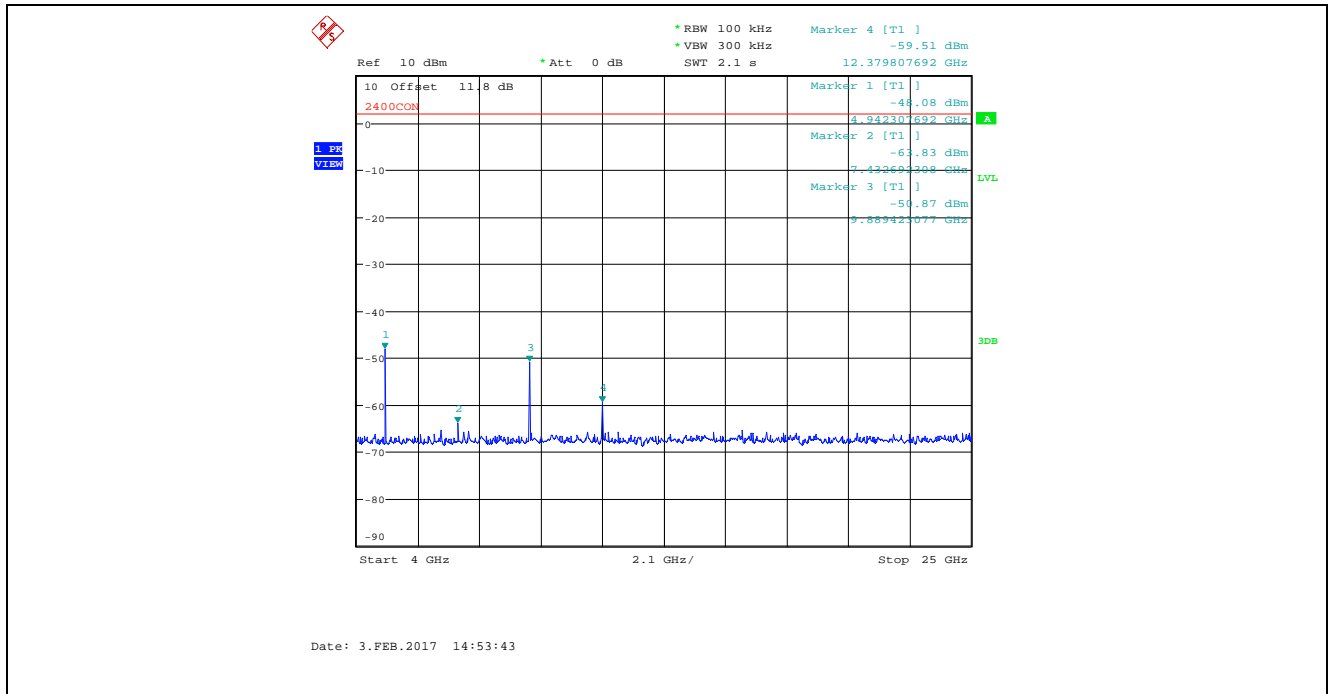

**Plot 5.4.4.2.7. Conducted Spurious Emissions in Non-restricted Frequency Bands**  
 Bandwidth: 8 MHz, TX Gain: 55, Data Rate 4, 2407 MHz, 30 MHz – 2.6 GHz

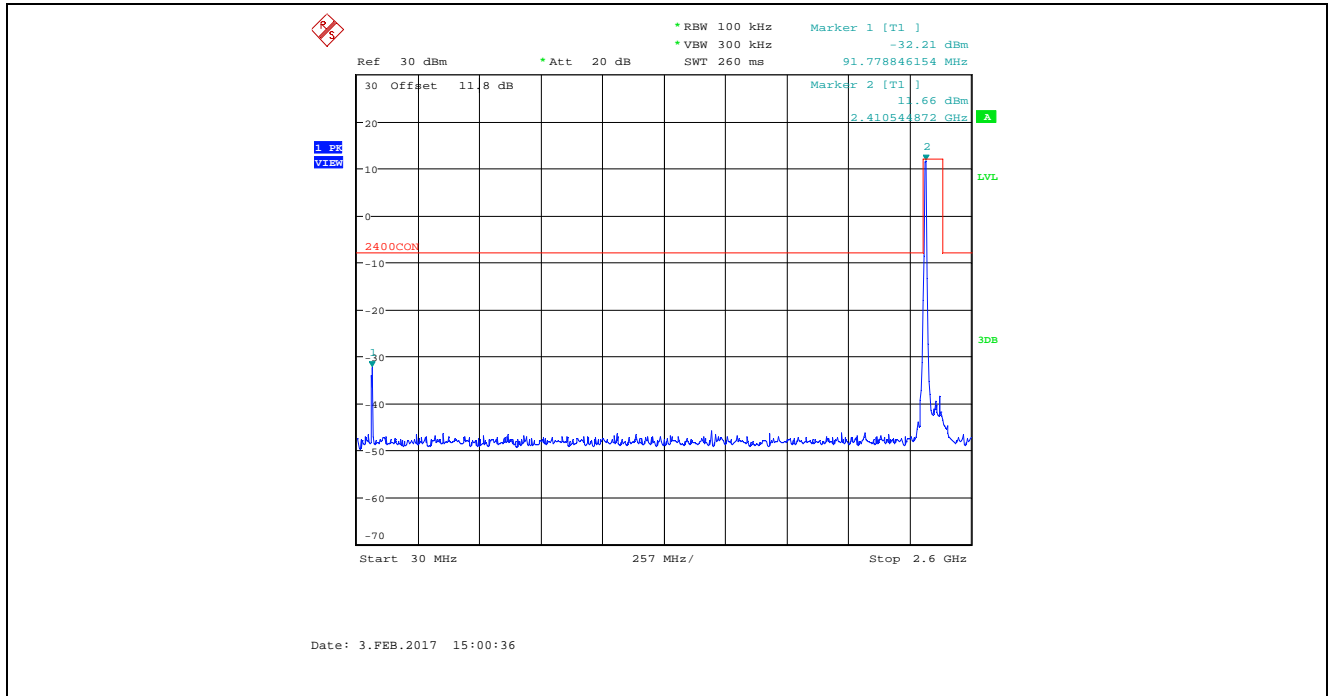

**Plot 5.4.4.2.8. Conducted Spurious Emissions in Non-restricted Frequency Bands**  
 Bandwidth: 8 MHz, TX Gain: 55, Data Rate 4, 2407 MHz, 2.6 GHz – 25 GHz

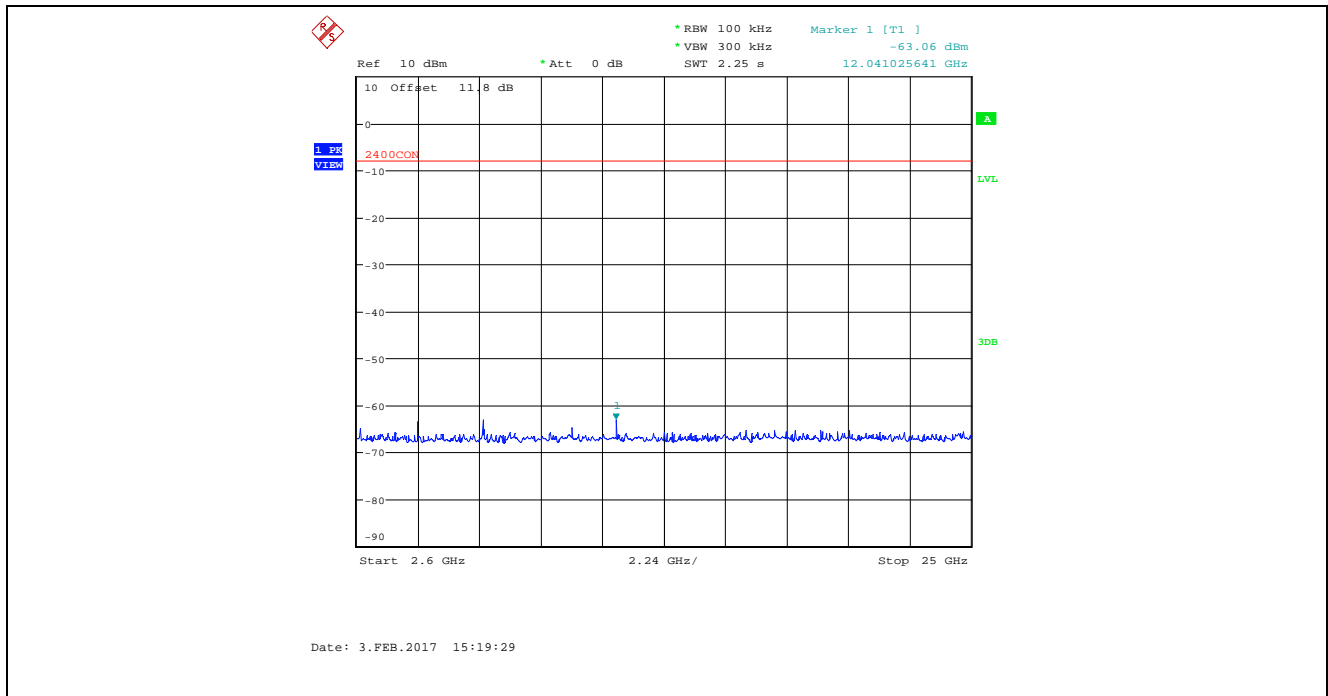

**Plot 5.4.4.2.9.** Conducted Spurious Emissions in Non-restricted Frequency Bands  
Bandwidth: 8 MHz, TX Gain: 55, Data Rate 4, 2442 MHz, 30 MHz – 2.6 GHz

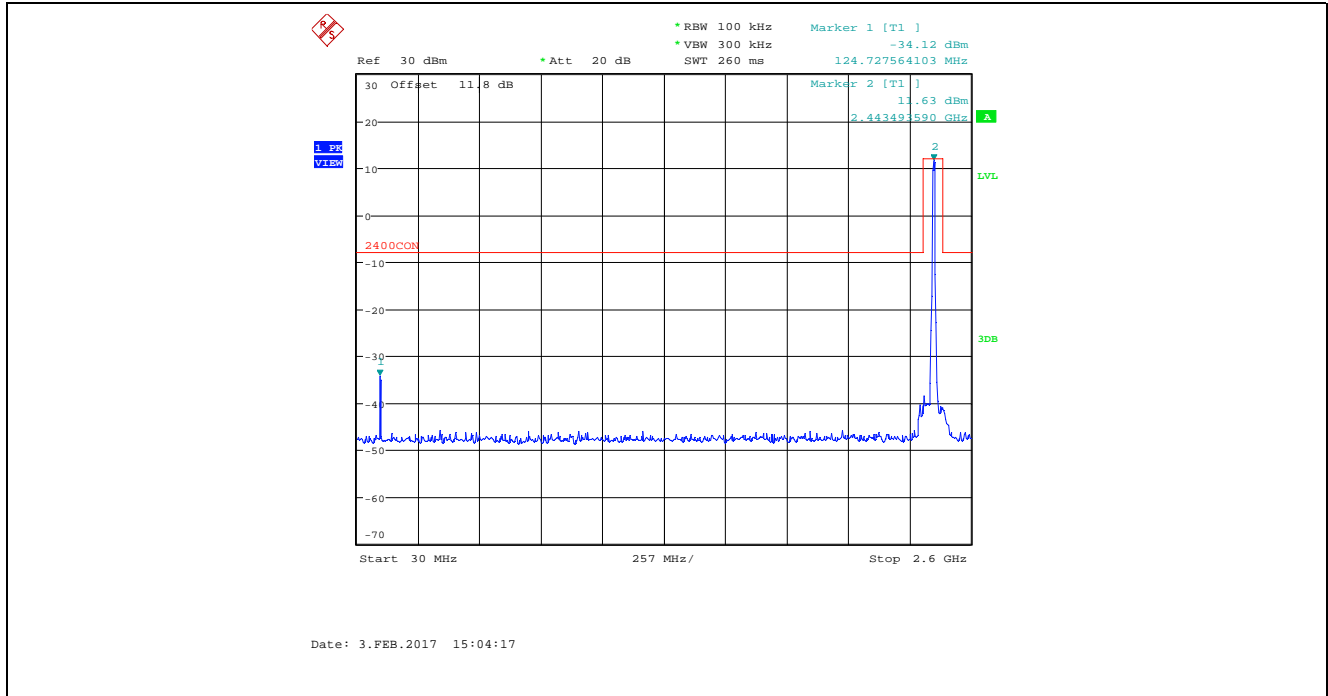

**Plot 5.4.4.2.10.** Conducted Spurious Emissions in Non-restricted Frequency Bands  
Bandwidth: 8 MHz, TX Gain: 55, Data Rate 4, 2442 MHz, 2.6 GHz – 25 GHz

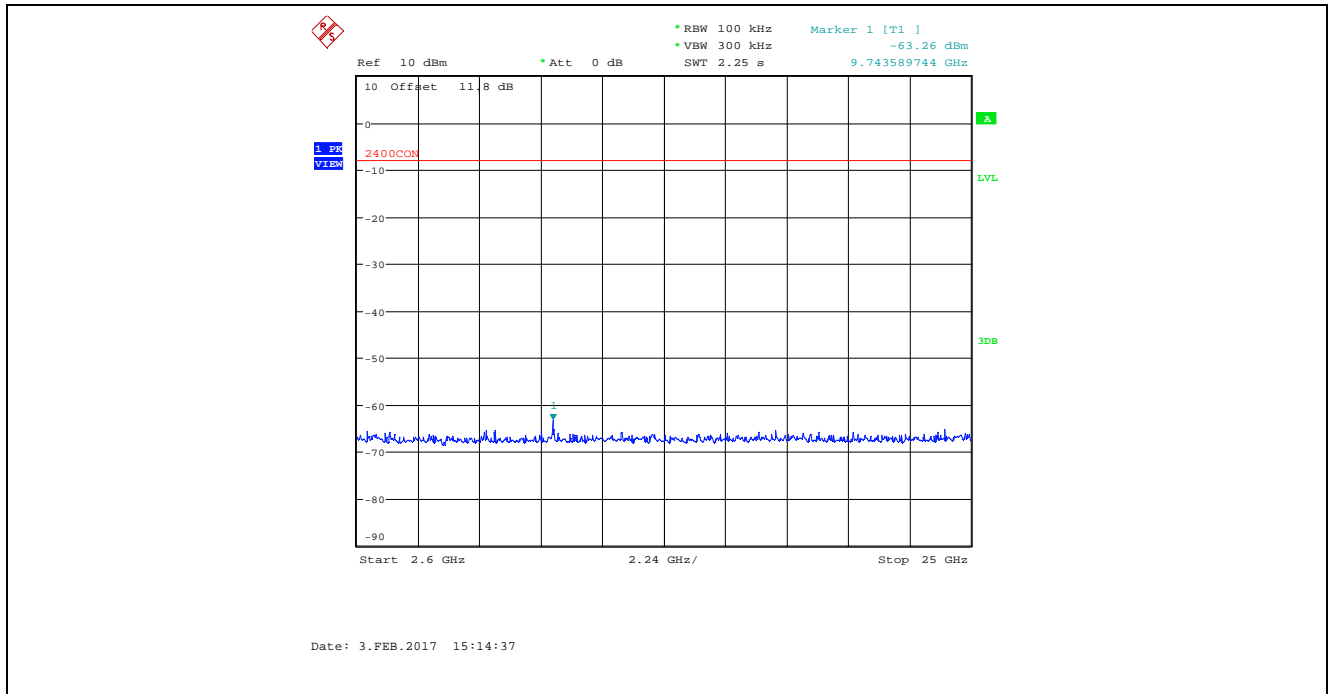

**Plot 5.4.4.2.11.** Conducted Spurious Emissions in Non-restricted Frequency Bands  
 Bandwidth: 8 MHz, TX Gain: 55, Data Rate 4, 2477 MHz, 30 MHz – 2.6 GHz

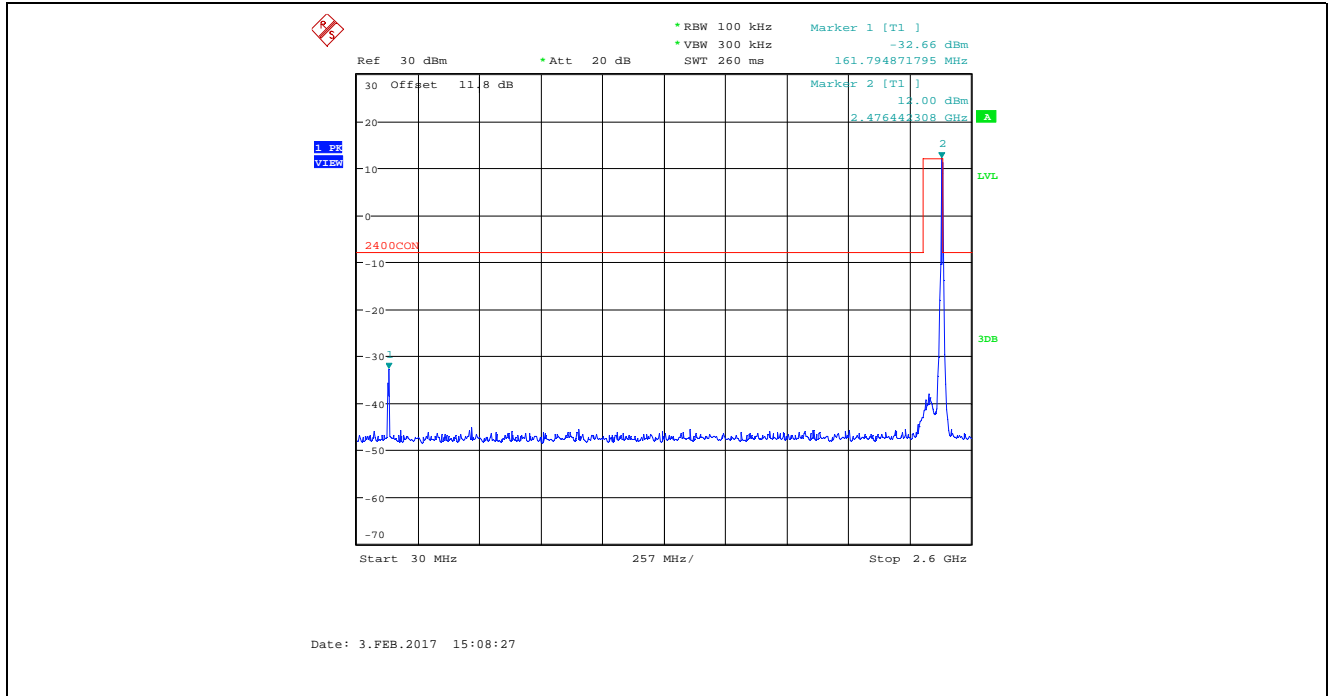

**Plot 5.4.4.2.12.** Conducted Spurious Emissions in Non-restricted Frequency Bands  
 Bandwidth: 8 MHz, TX Gain: 55, Data Rate 4, 2477 MHz, 2.6 GHz – 25 GHz

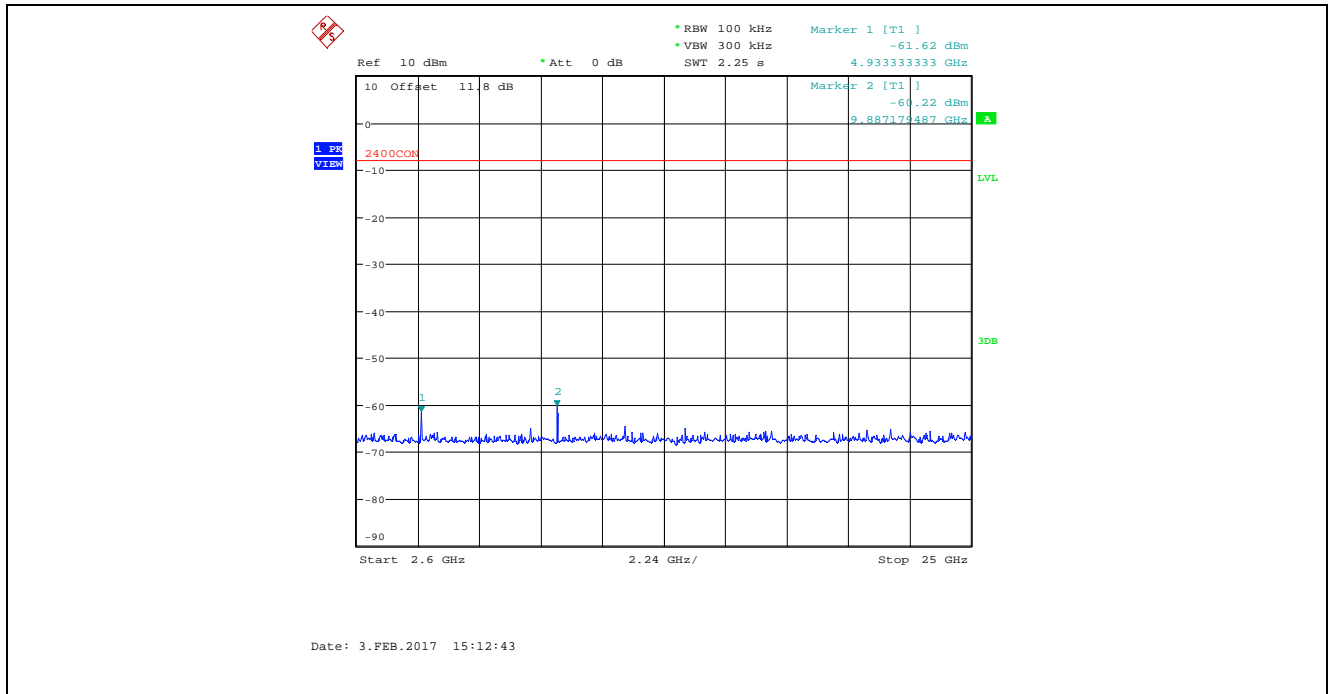

**Plot 5.4.4.2.13.** Conducted Spurious Emissions in Non-restricted Frequency Bands  
Bandwidth: 8 MHz, TX Gain: 0, Data Rate 1, 2407 MHz, 30 MHz – 2.6 GHz

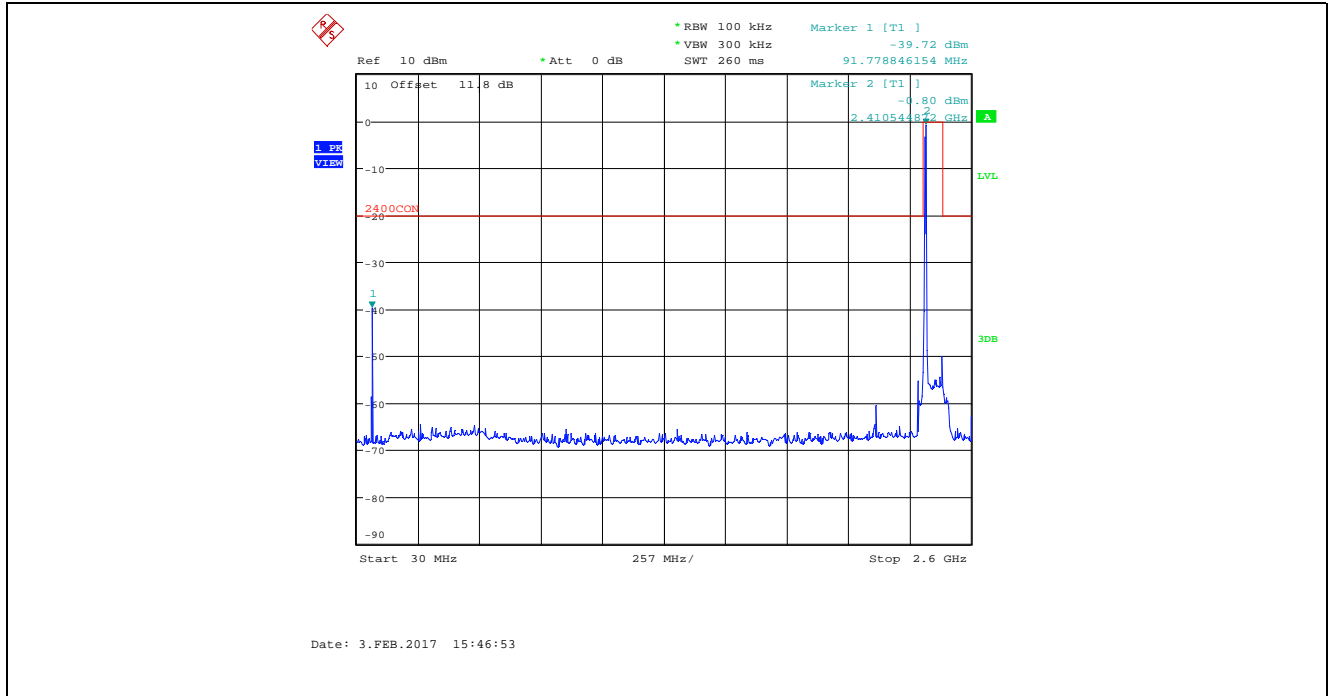

**Plot 5.4.4.2.14.** Conducted Spurious Emissions in Non-restricted Frequency Bands  
Bandwidth: 8 MHz, TX Gain: 0, Data Rate 1, 2407 MHz, 2.6 GHz – 25 GHz

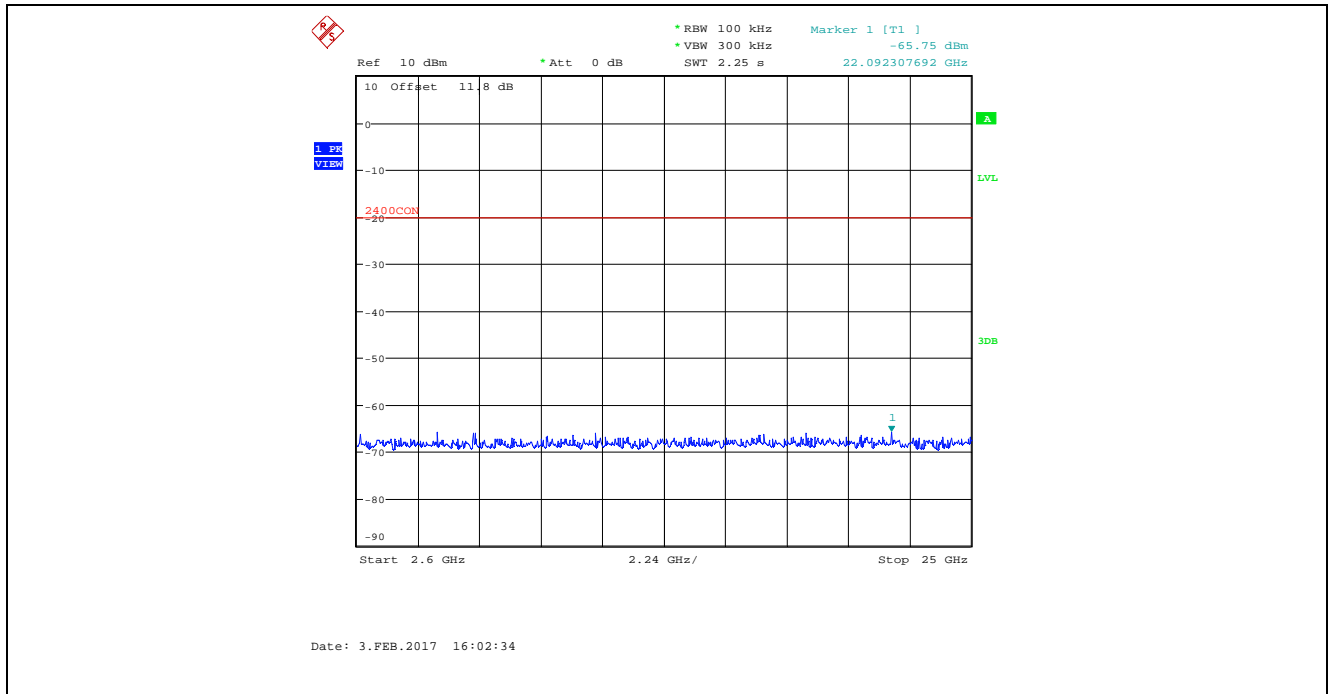

**Plot 5.4.4.2.15.** Conducted Spurious Emissions in Non-restricted Frequency Bands  
Bandwidth: 8 MHz, TX Gain: 0, Data Rate 1, 2442 MHz, 30 MHz – 2.6 GHz

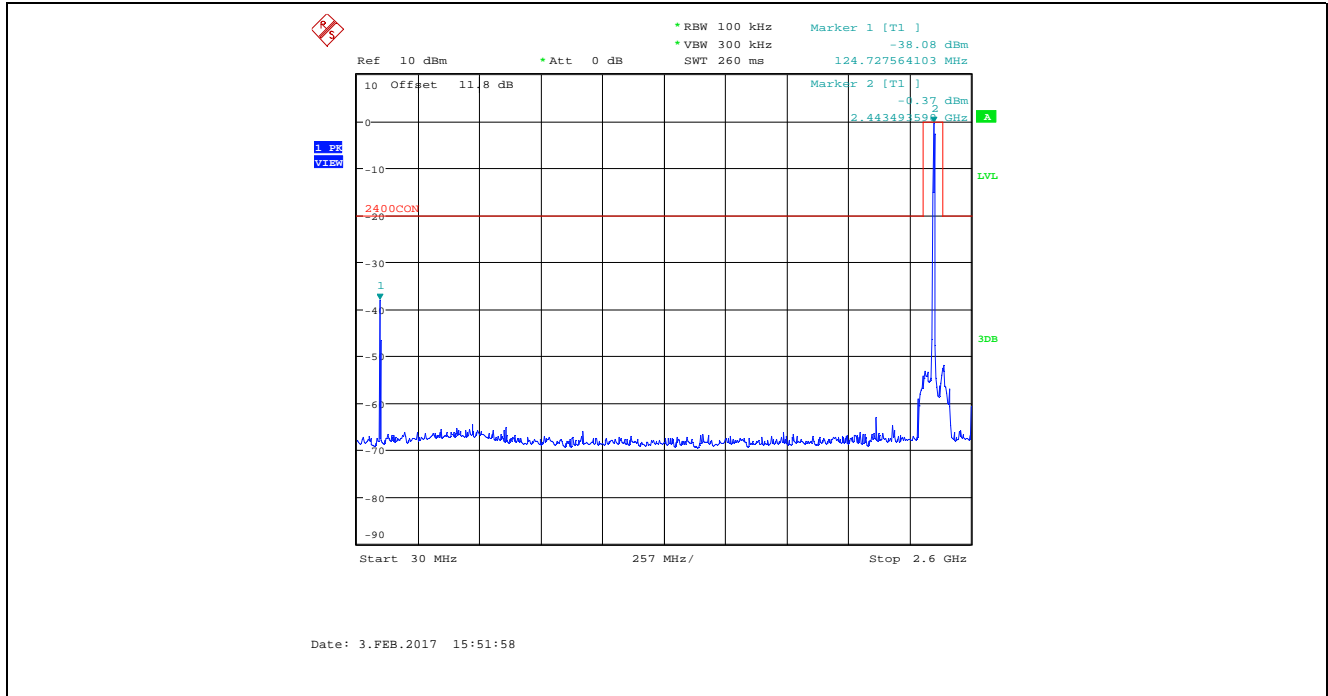

**Plot 5.4.4.2.16.** Conducted Spurious Emissions in Non-restricted Frequency Bands  
Bandwidth: 8 MHz, TX Gain: 0, Data Rate 1, 2442 MHz, 2.6 GHz – 25 GHz

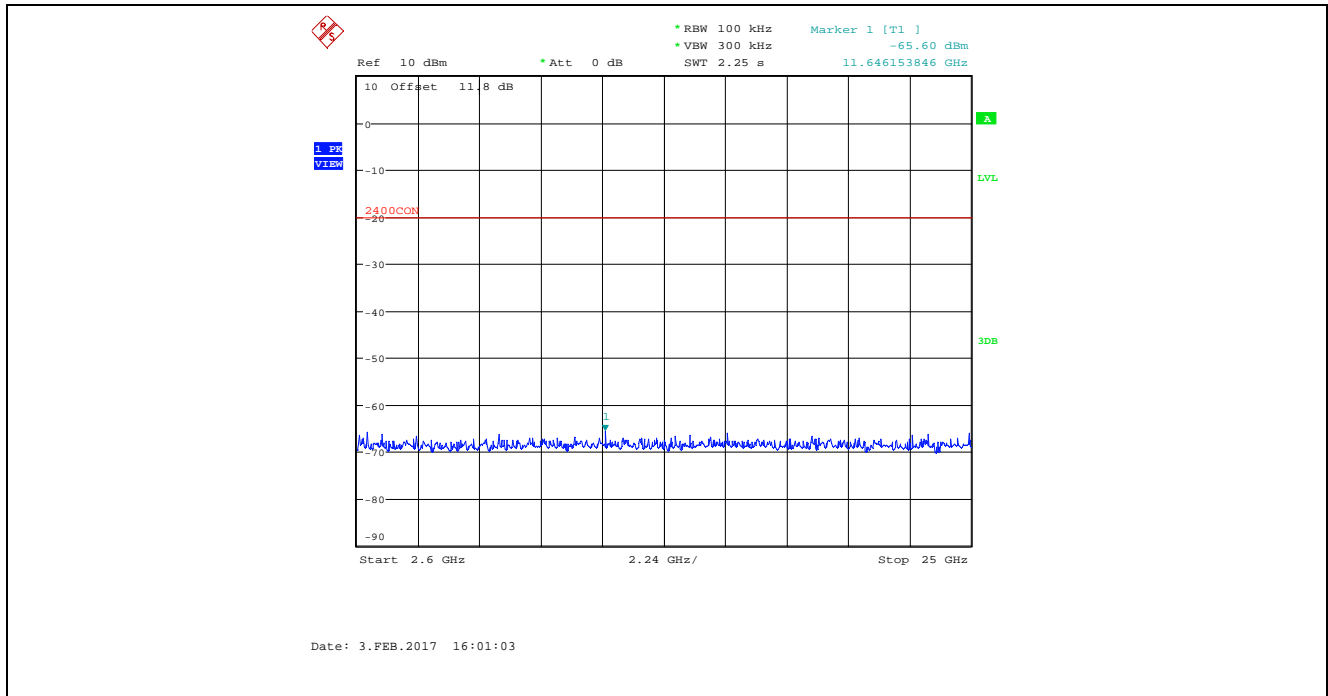

**Plot 5.4.4.2.17.** Conducted Spurious Emissions in Non-restricted Frequency Bands  
Bandwidth: 8 MHz, TX Gain: 0, Data Rate 1, 2477 MHz, 30 MHz – 2.6 GHz

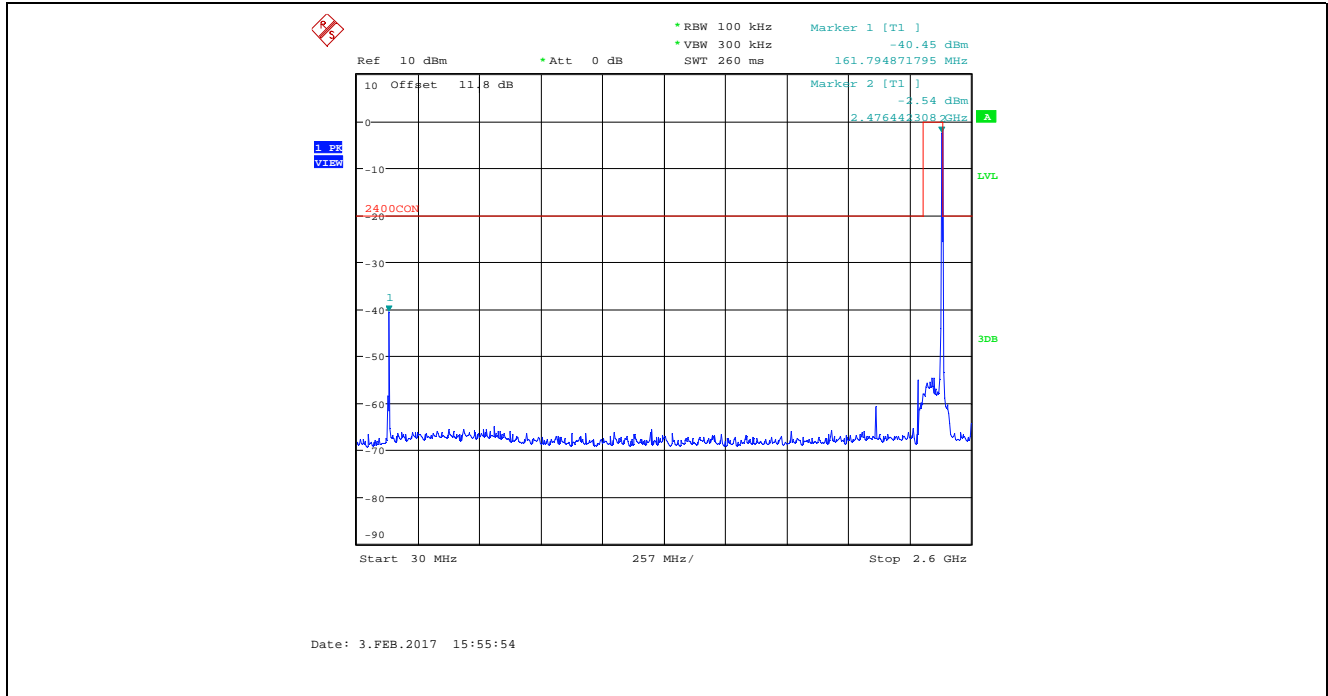

**Plot 5.4.4.2.18.** Conducted Spurious Emissions in Non-restricted Frequency Bands  
Bandwidth: 8 MHz, TX Gain: 0, Data Rate 1, 2477 MHz, 2.6 GHz – 25 GHz

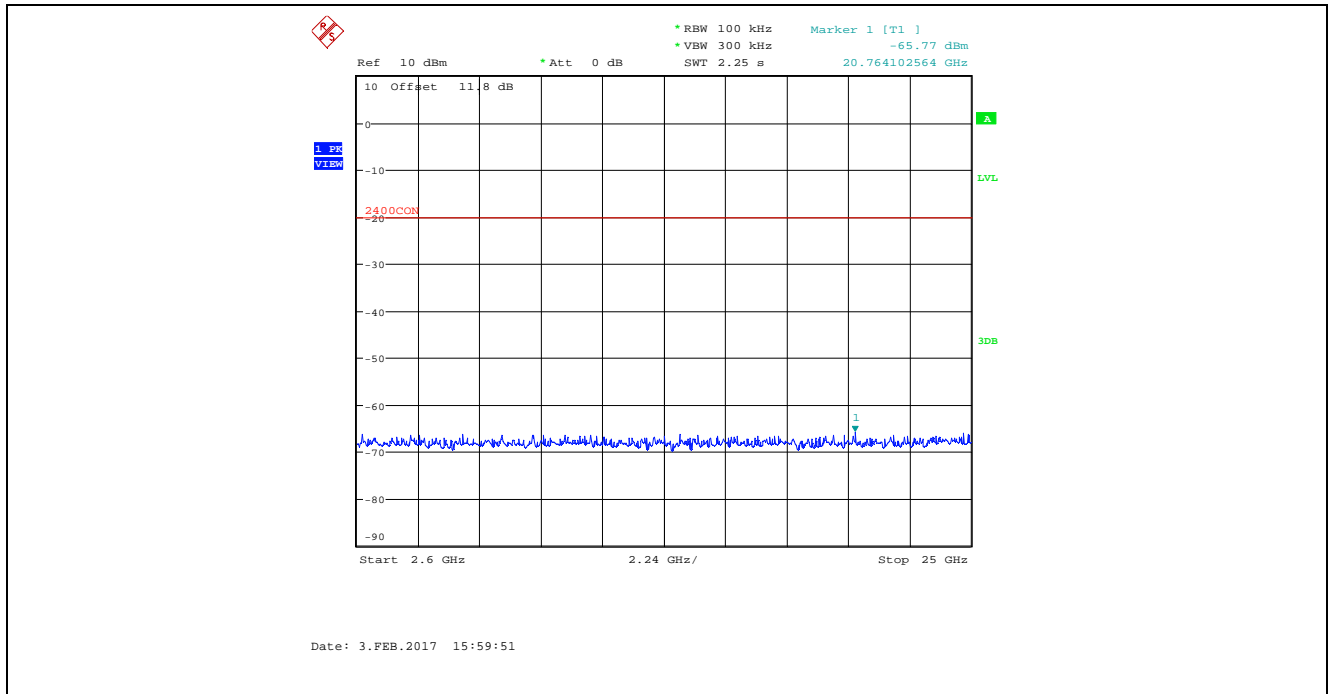

**Plot 5.4.4.2.19.** Conducted Spurious Emissions in Non-restricted Frequency Bands  
 Bandwidth: 8 MHz, TX Gain: 0, Data Rate 4, 2407 MHz, 30 MHz – 2.6 GHz

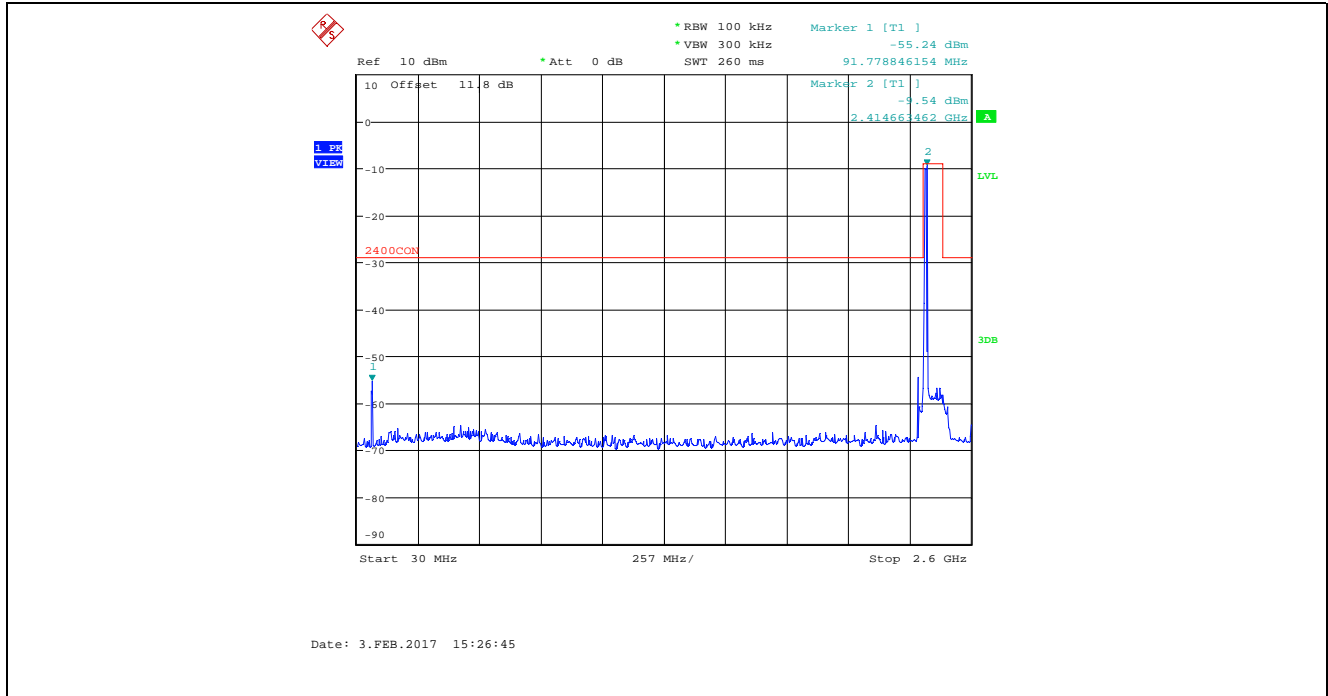

**Plot 5.4.4.2.20.** Conducted Spurious Emissions in Non-restricted Frequency Bands  
 Bandwidth: 8 MHz, TX Gain: 0, Data Rate 4, 2407 MHz, 2.6 GHz – 25 GHz

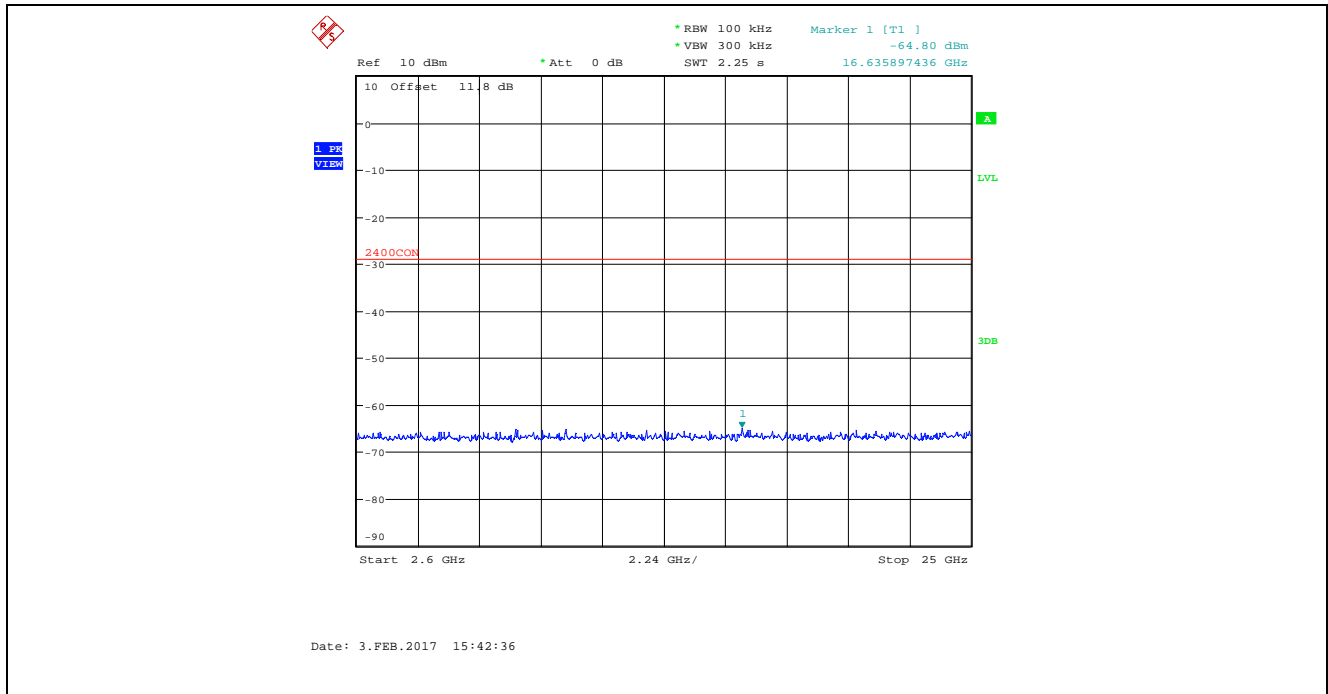



**Plot 5.4.4.2.21.** Conducted Spurious Emissions in Non-restricted Frequency Bands  
Bandwidth: 8 MHz, TX Gain: 0, Data Rate 4, 2442 MHz, 30 MHz – 2.6 GHz

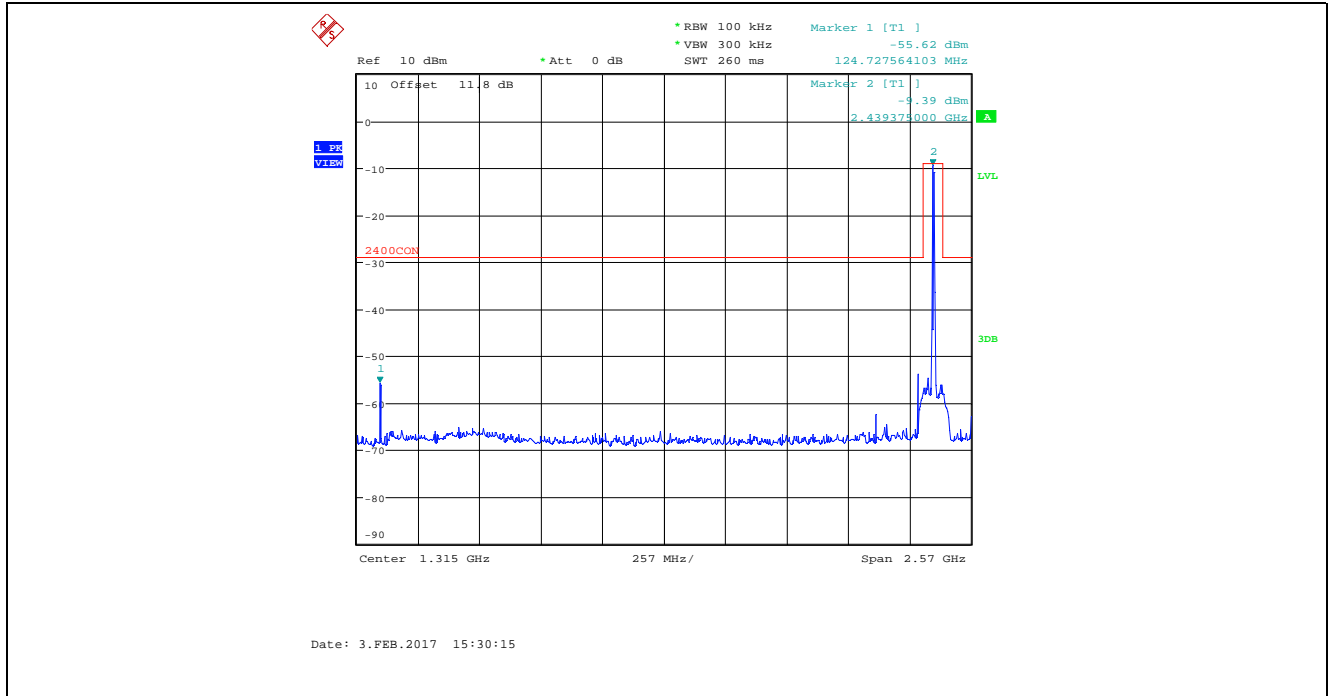

**Plot 5.4.4.2.22.** Conducted Spurious Emissions in Non-restricted Frequency Bands  
Bandwidth: 8 MHz, TX Gain: 0, Data Rate 4, 2442 MHz, 2.6 GHz – 25 GHz

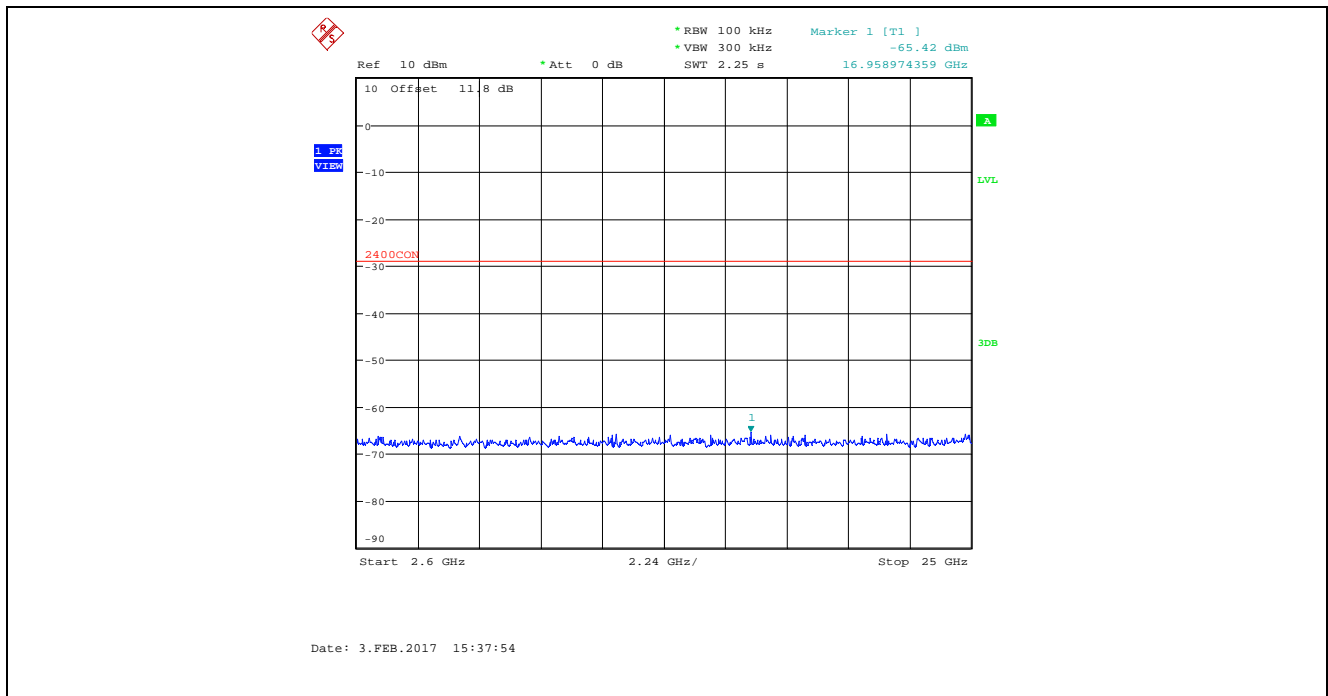

**Plot 5.4.4.2.23.** Conducted Spurious Emissions in Non-restricted Frequency Bands  
Bandwidth: 8 MHz, TX Gain: 0, Data Rate 4, 2477 MHz, 30 MHz – 2.6 GHz

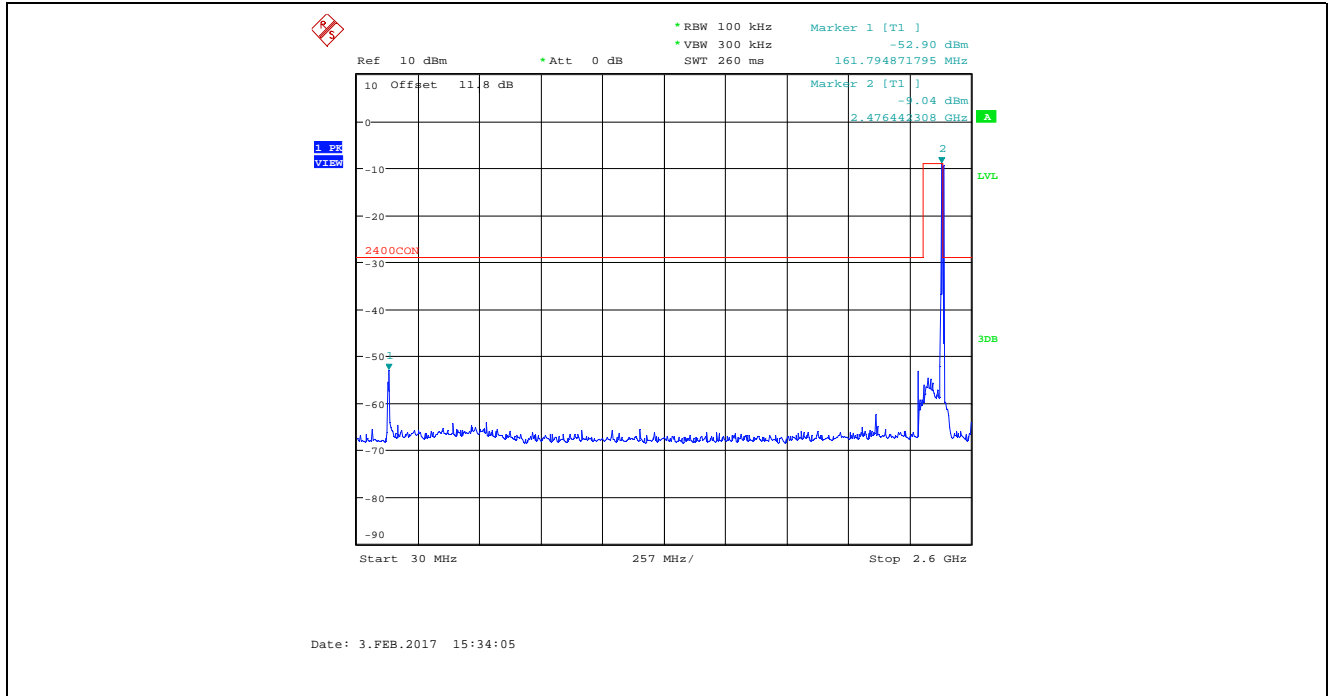

**Plot 5.4.4.2.24.** Conducted Spurious Emissions in Non-restricted Frequency Bands  
Bandwidth: 8 MHz, TX Gain: 0, Data Rate 4, 2477 MHz, 2.6 GHz – 25 GHz

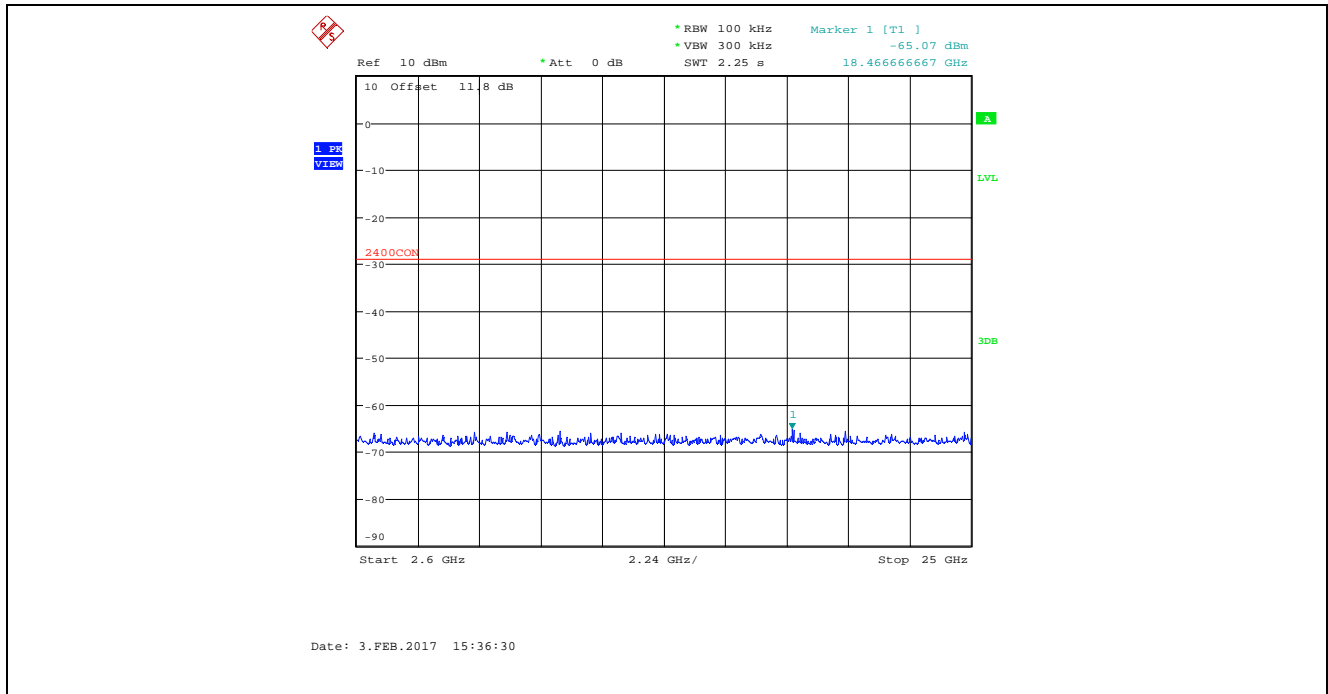

**5.4.4.3. Conducted Spurious Emissions in Restricted Frequency Bands, Highest Power Setting for Lowest Antenna Gain (2.5 dBi, with Antenna Assembly Gain 2.0 dBi)**

**Remark:** Offset = [Insertion Loss] + [Transmit Antenna Gain (in dBi)] + [Maximum Ground Reflection Factor]

**Plot 5.4.4.3.1.** Conducted Spurious Emissions in Restricted Frequency Bands  
Bandwidth: 8 MHz, TX Gain Setting 50, Data Rate 1, 2407 MHz, 9 kHz - 150 kHz, Peak Detector

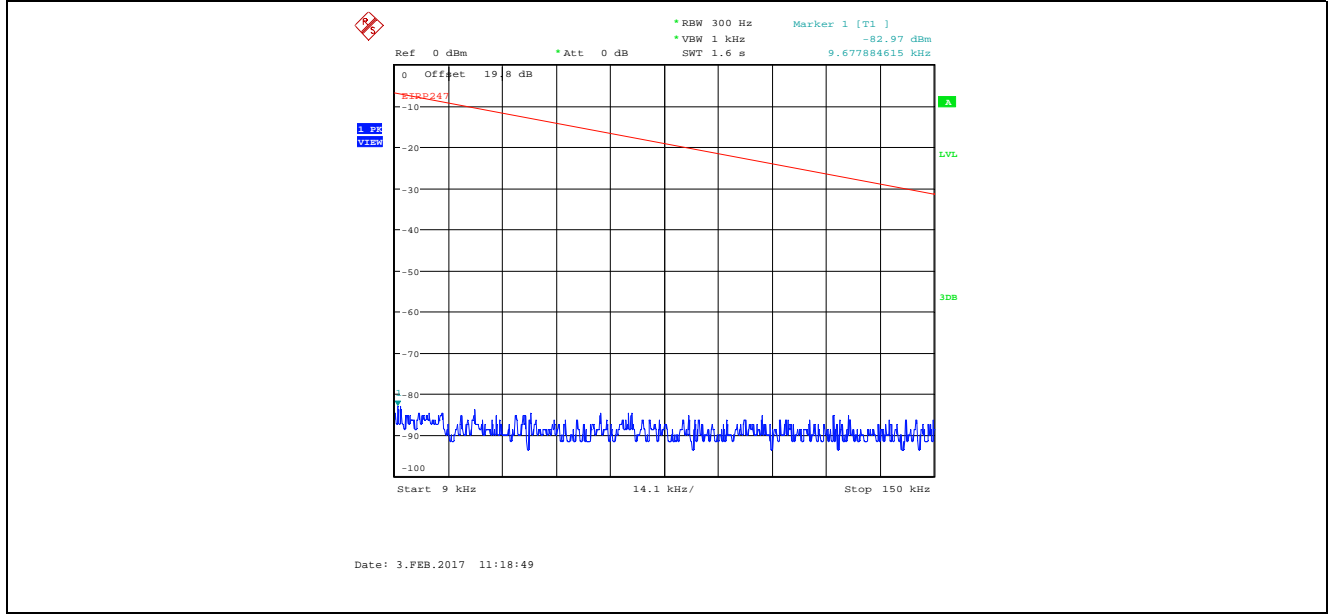

**Plot 5.4.4.3.2.** Conducted Spurious Emissions in Restricted Frequency Bands  
Bandwidth: 8 MHz, TX Gain Setting 50, Data Rate 1, 2407 MHz, 150 kHz - 30 MHz, Peak Detector

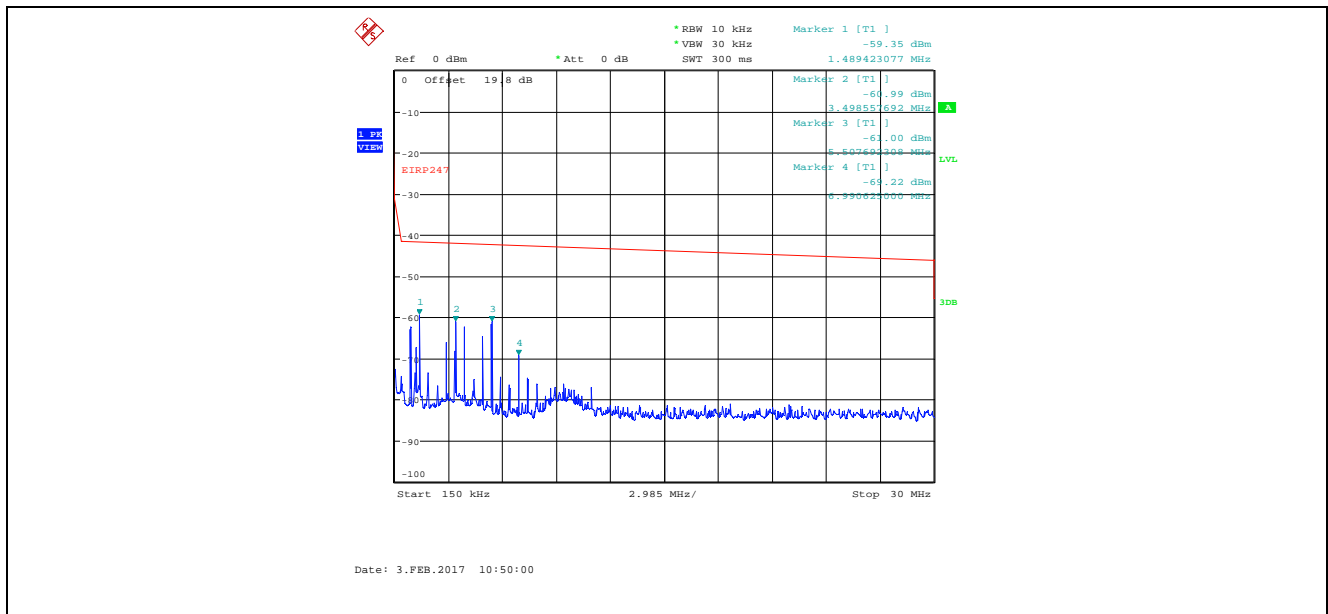

**Plot 5.4.4.3.3.** Conducted Spurious Emissions in Restricted Frequency Bands  
Bandwidth: 8 MHz, TX Gain Setting 50, Data Rate 1, 2407 MHz, 30 MHz - 1 GHz, Peak Detector

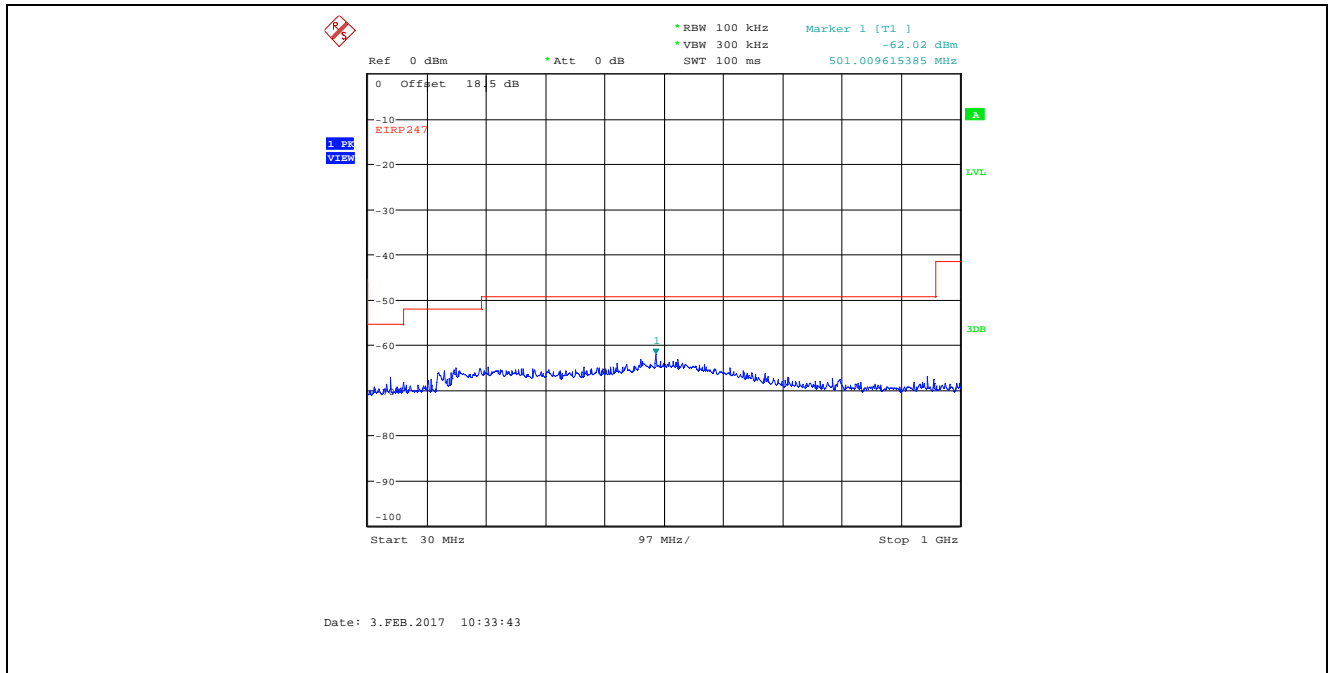

**Plot 5.4.4.3.4.** Conducted Spurious Emissions in Restricted Frequency Bands  
Bandwidth: 8 MHz, TX Gain Setting 50, Data Rate 1, 2407 MHz, 1 GHz - 4 GHz, Peak Detector

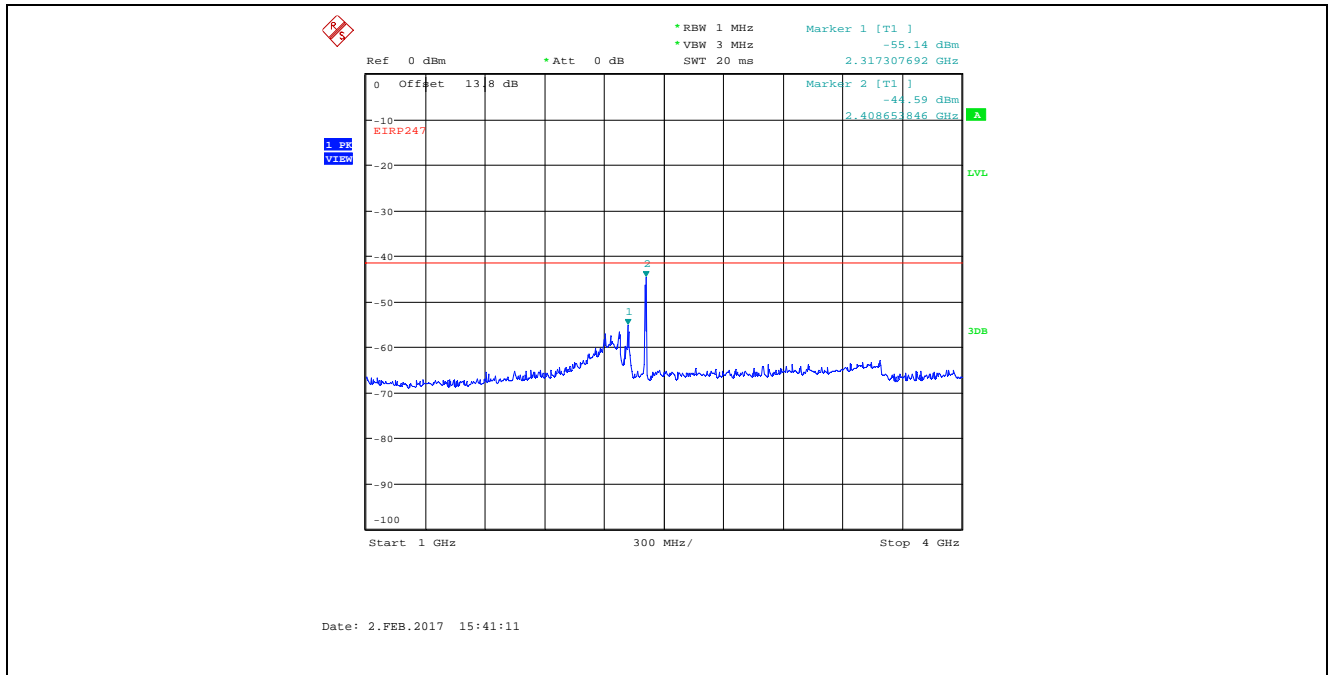

**Plot 5.4.4.3.5.** Conducted Spurious Emissions in Restricted Frequency Bands  
 Bandwidth: 8 MHz, TX Gain Setting 50, Data Rate 1, 2407 MHz, 4 GHz - 25 GHz, Peak Detector

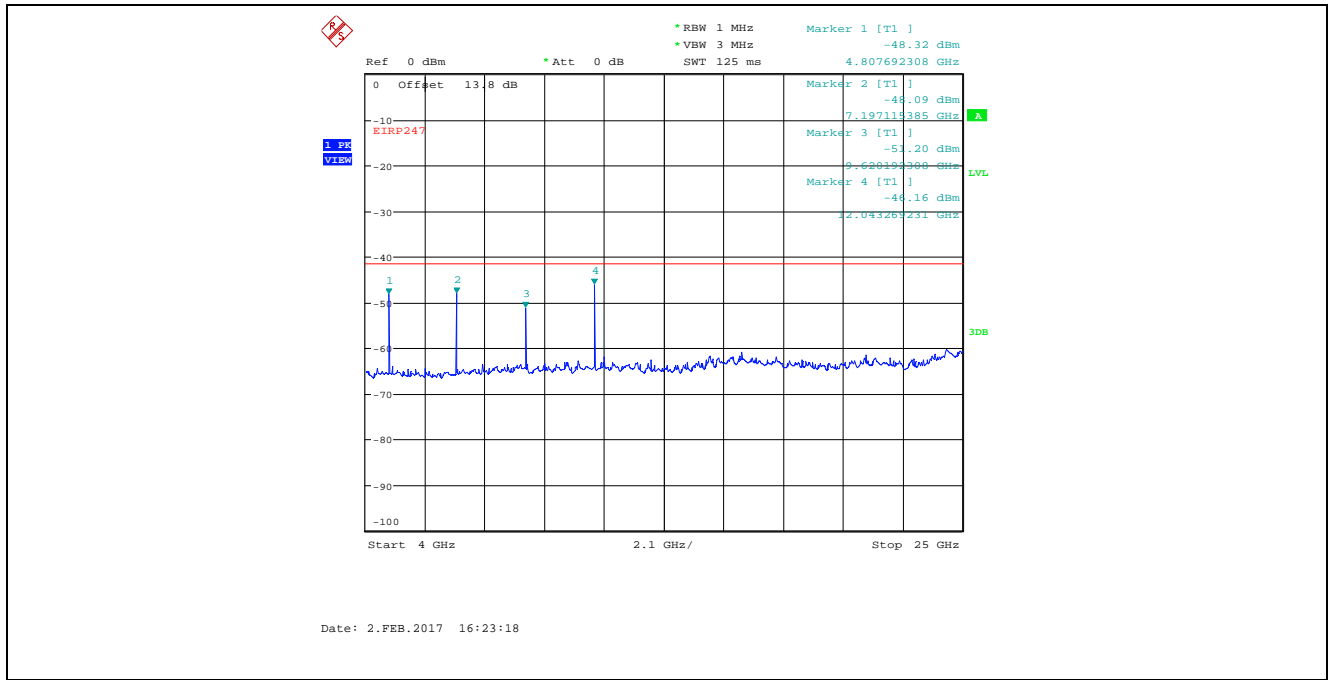

**Plot 5.4.4.3.6.** Conducted Spurious Emissions in Restricted Frequency Bands  
 Bandwidth: 8 MHz, TX Gain Setting 50, Data Rate 1, 2442 MHz, 9 kHz - 150 kHz, Peak Detector

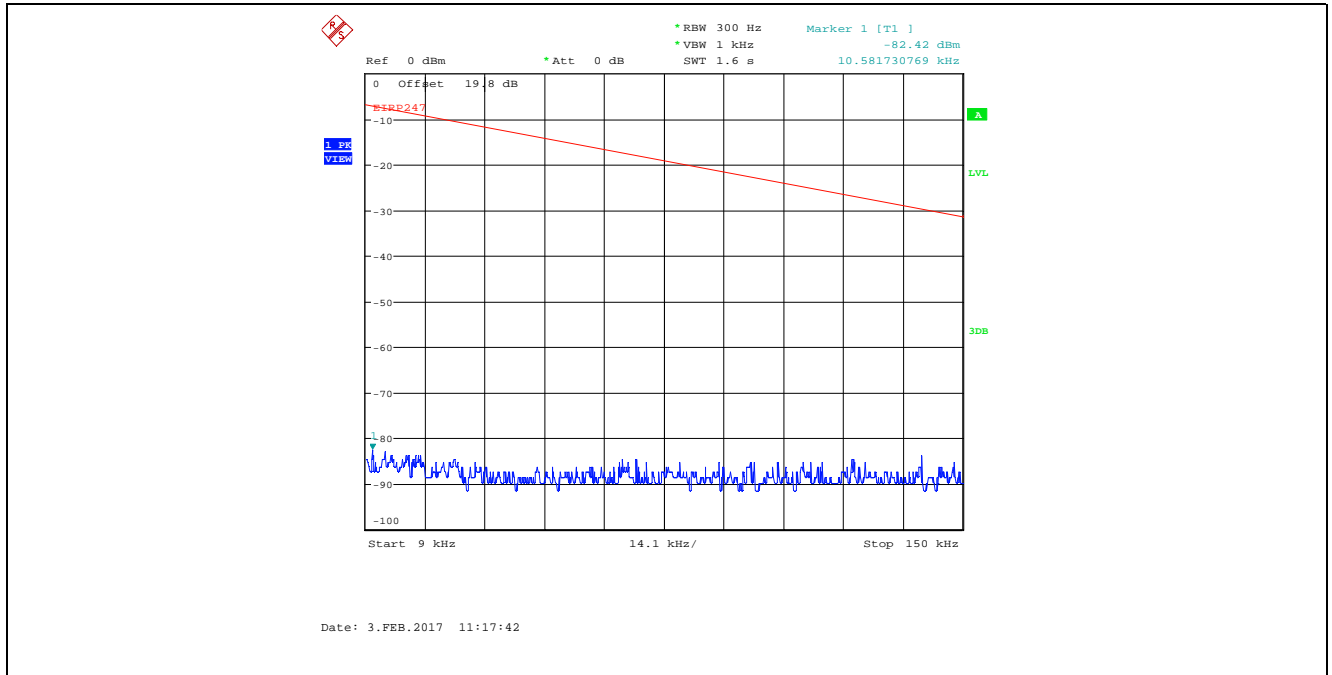

**Plot 5.4.4.3.7.** Conducted Spurious Emissions in Restricted Frequency Bands  
 Bandwidth: 8 MHz, TX Gain Setting 50, Data Rate 1, 2442 MHz, 150 kHz - 30 MHz, Peak Detector

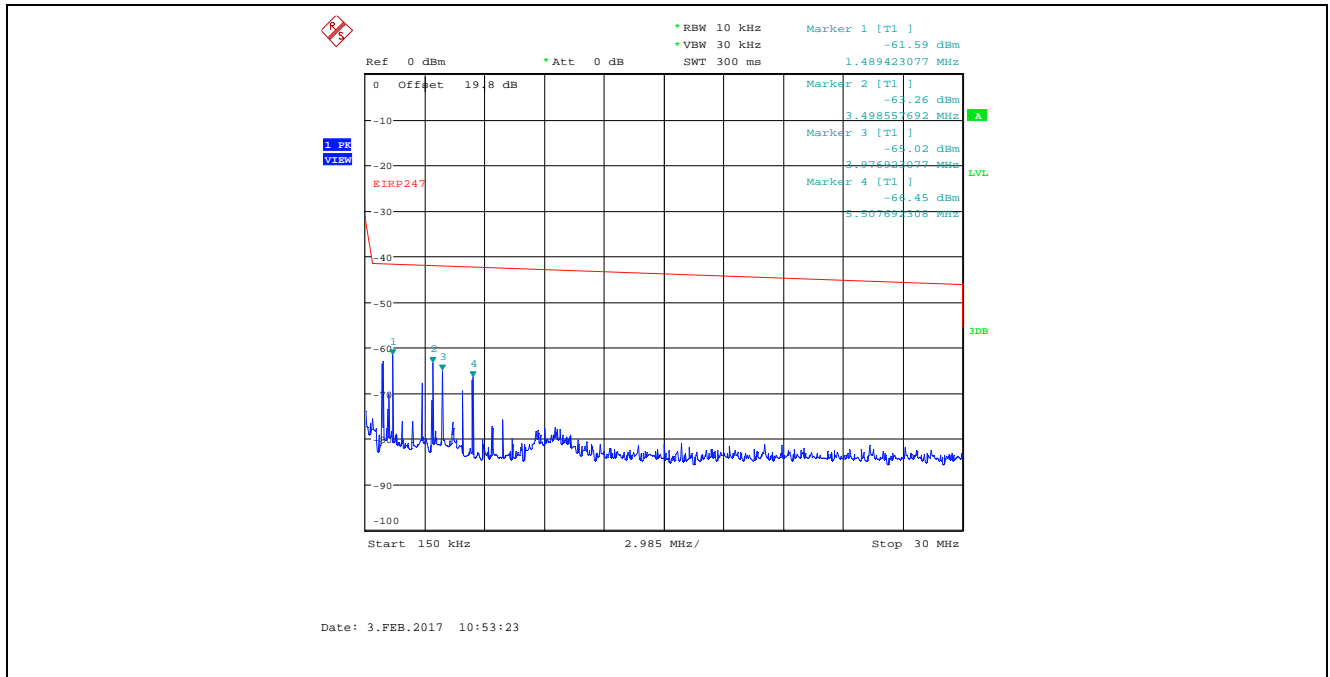

**Plot 5.4.4.3.8.** Conducted Spurious Emissions in Restricted Frequency Bands  
 Bandwidth: 8 MHz, TX Gain Setting 50, Data Rate 1, 2442 MHz, 30 MHz - 1 GHz, Peak Detector

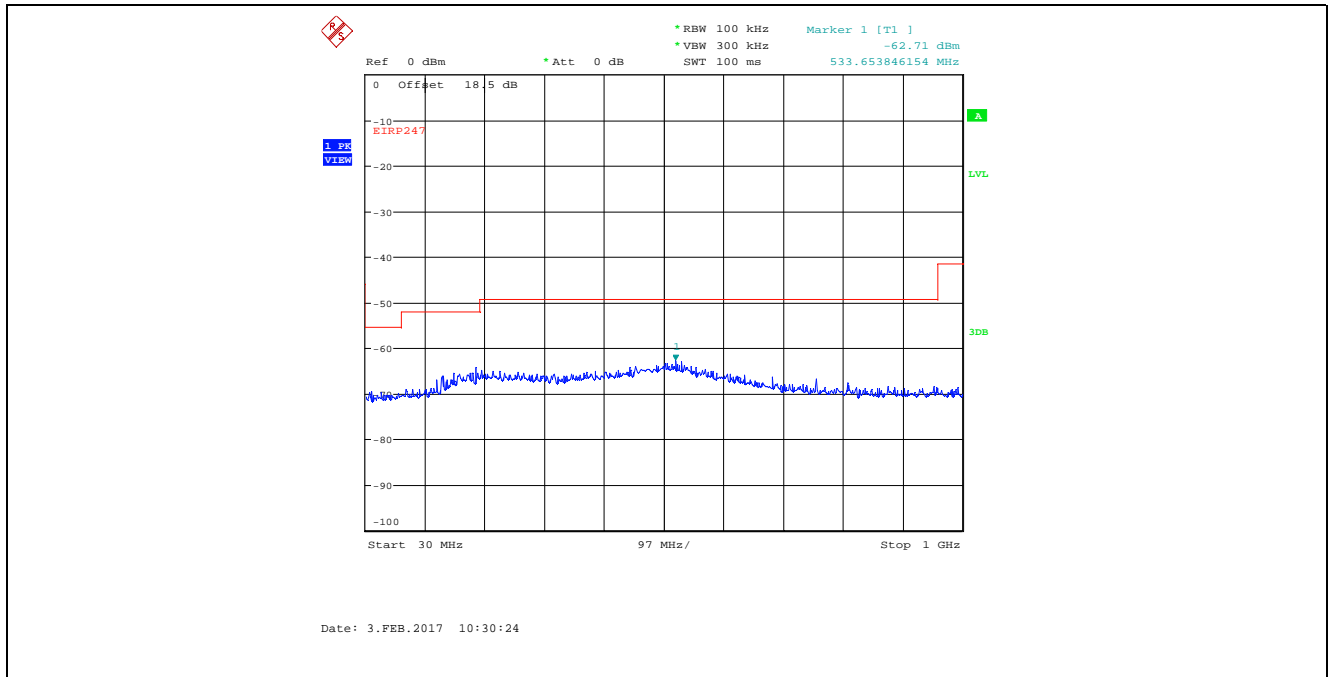

**Plot 5.4.4.3.9.** Conducted Spurious Emissions in Restricted Frequency Bands  
 Bandwidth: 8 MHz, TX Gain Setting 50, Data Rate 1, 2442 MHz, 1 GHz - 4 GHz, Peak Detector  
 Marker 2 is the Fundamental

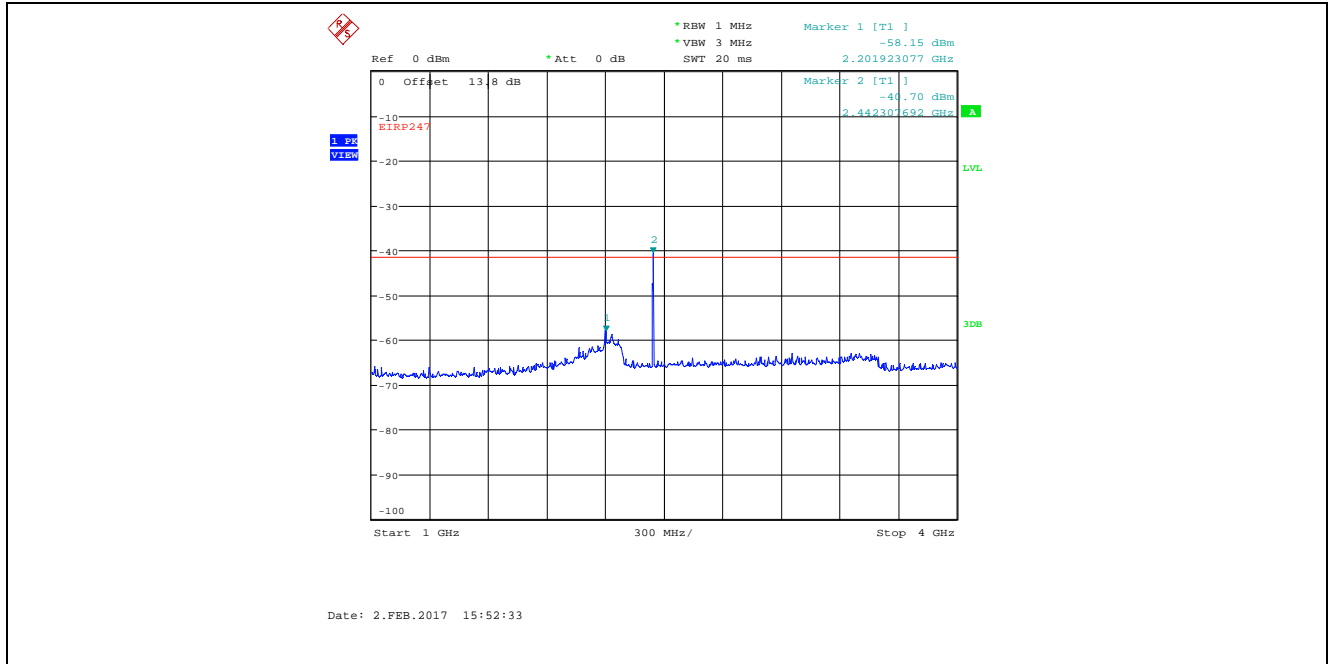

**Plot 5.4.4.3.10.** Conducted Spurious Emissions in Restricted Frequency Bands  
 Bandwidth: 8 MHz, TX Gain Setting 50, Data Rate 1, 2442 MHz, 4 GHz - 25 GHz, Peak Detector

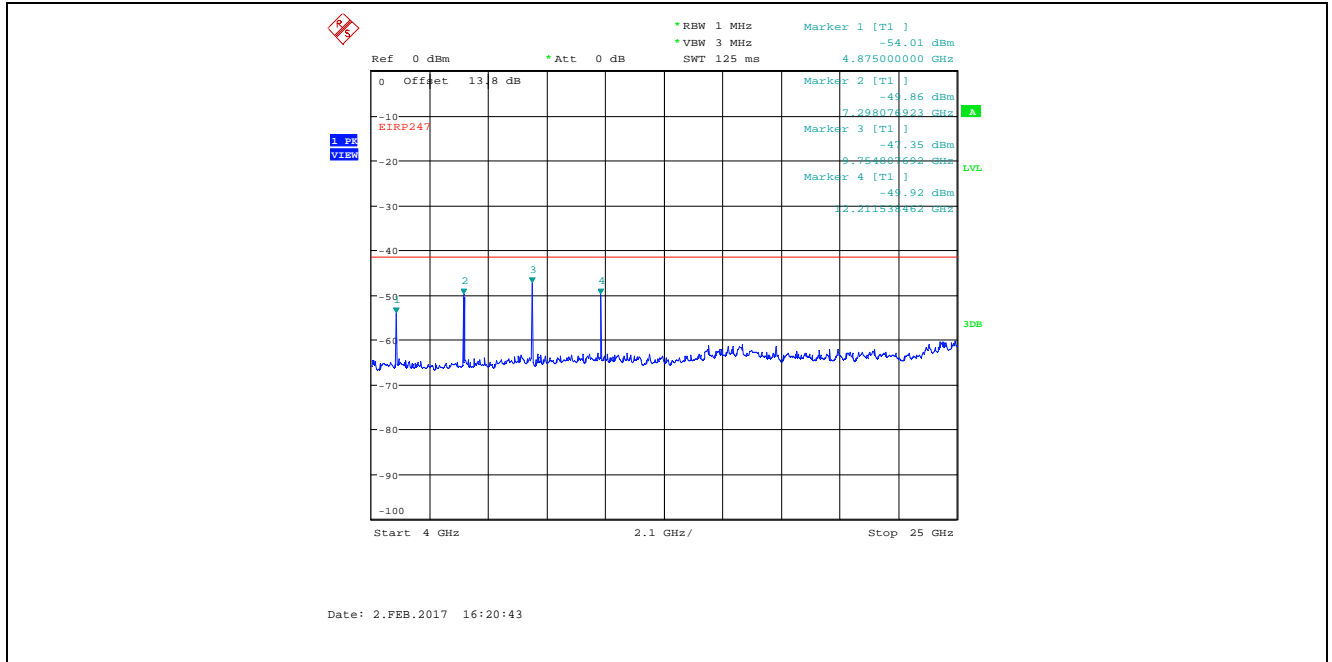

**Plot 5.4.4.3.11.** Conducted Spurious Emissions in Restricted Frequency Bands  
 Bandwidth: 8 MHz, TX Gain Setting 50, Data Rate 1, 2477 MHz, 9 kHz - 150 kHz, Peak Detector

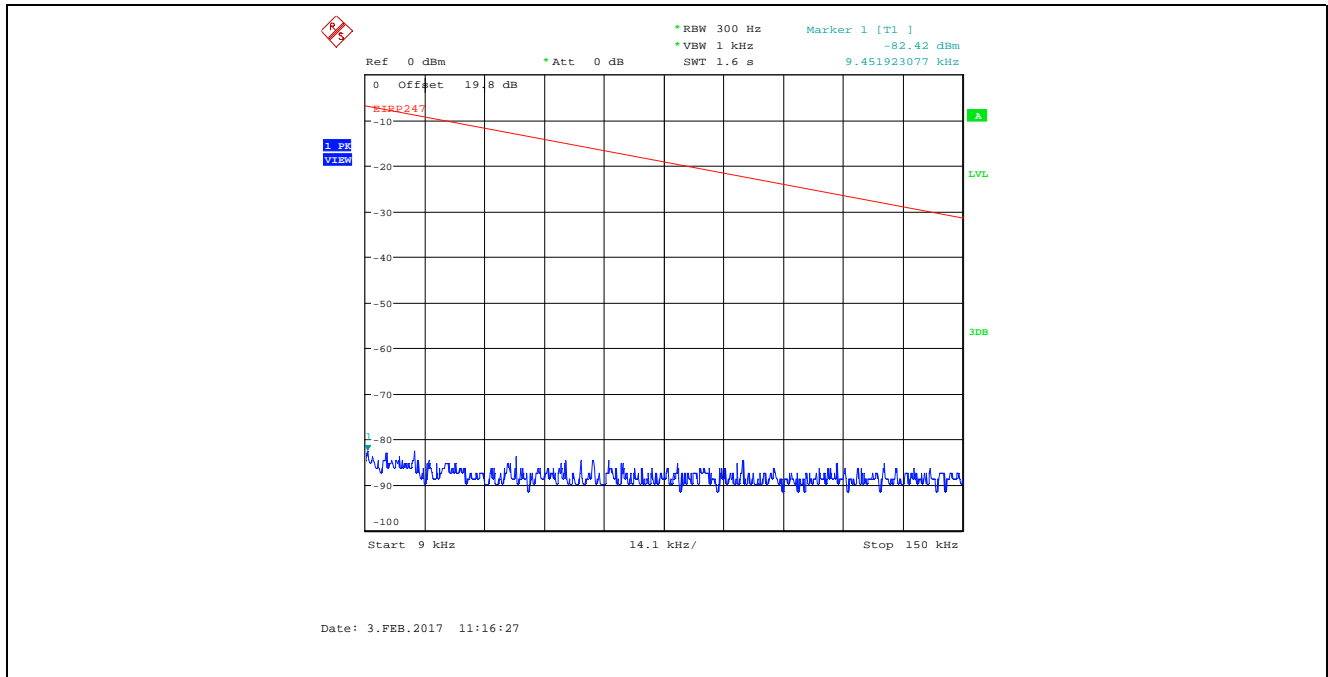

**Plot 5.4.4.3.12.** Conducted Spurious Emissions in Restricted Frequency Bands  
 Bandwidth: 8 MHz, TX Gain Setting 50, Data Rate 1, 2477 MHz, 150 kHz - 30 MHz, Peak Detector

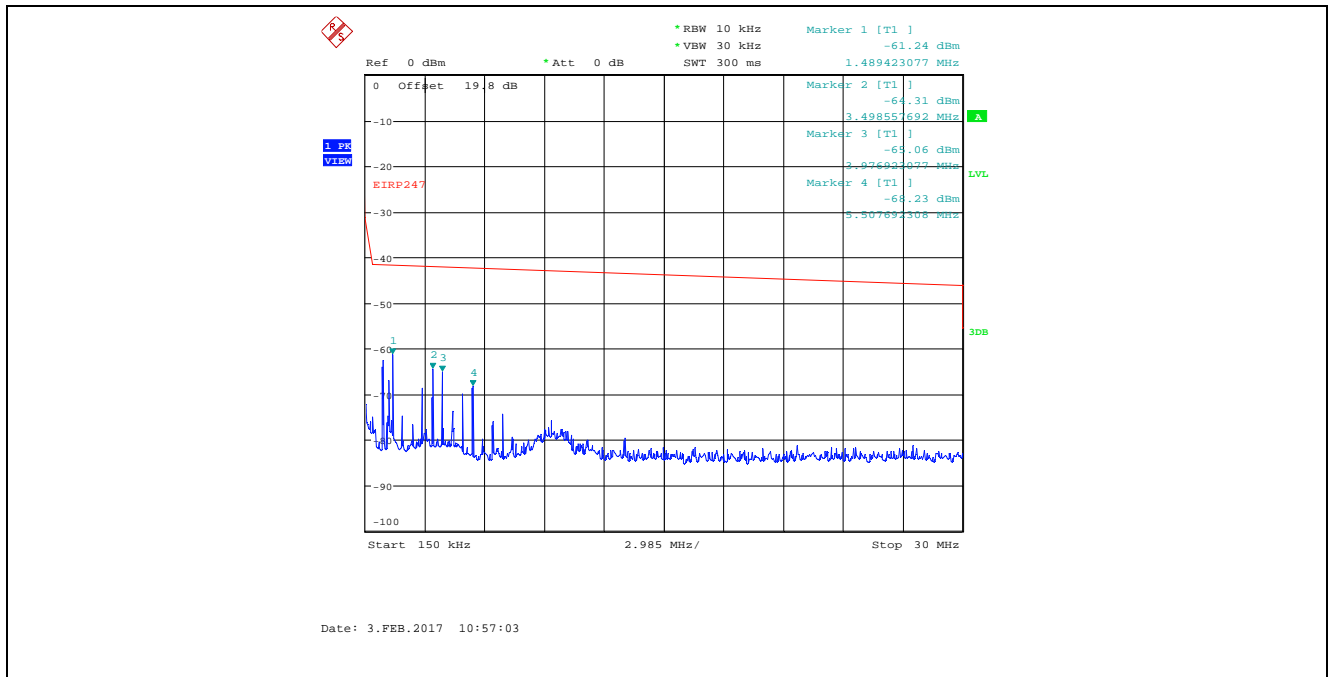



**Plot 5.4.4.3.13.** Conducted Spurious Emissions in Restricted Frequency Bands  
Bandwidth: 8 MHz, TX Gain Setting 50, Data Rate 1, 2477 MHz, 30 MHz - 1 GHz, Peak Detector

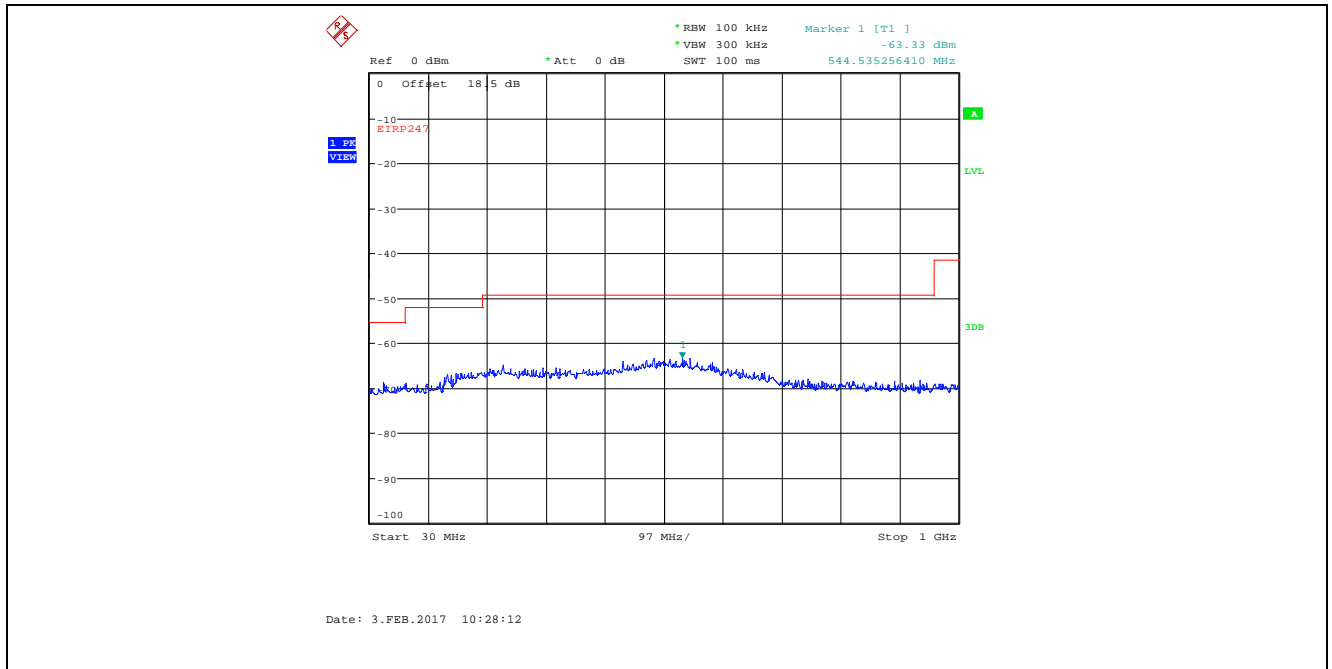

**Plot 5.4.4.3.14.** Conducted Spurious Emissions in Restricted Frequency Bands  
Bandwidth: 8 MHz, TX Gain Setting 50, Data Rate 1, 2477 MHz, 1 GHz - 4 GHz, Peak Detector  
Marker 2 is the Fundamental

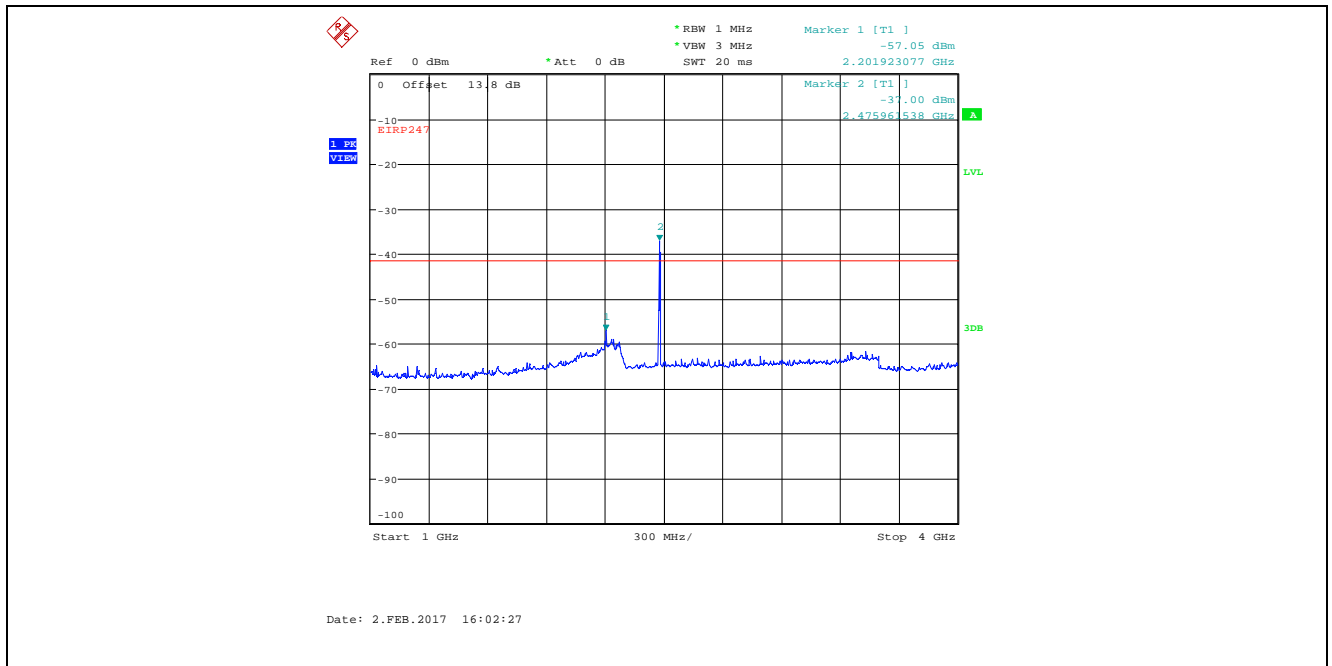

**Plot 5.4.4.3.15.** Conducted Spurious Emissions in Restricted Frequency Bands  
 Bandwidth: 8 MHz, TX Gain Setting 50, Data Rate 1, 2477 MHz, 4 GHz - 25 GHz, Peak Detector

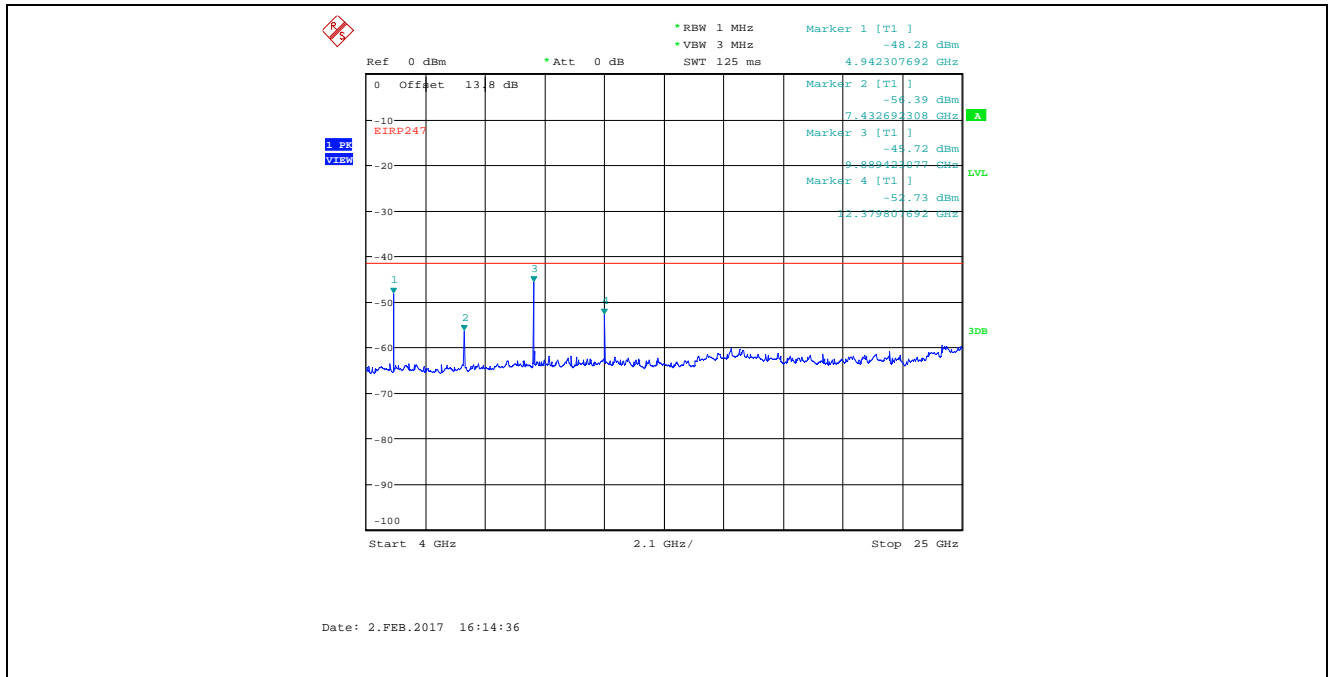

**Plot 5.4.4.3.16.** Conducted Spurious Emissions in Restricted Frequency Bands  
 Bandwidth: 8 MHz, TX Gain Setting 55, Data Rate 4, 2407 MHz, 9 kHz - 150 kHz, Peak Detector

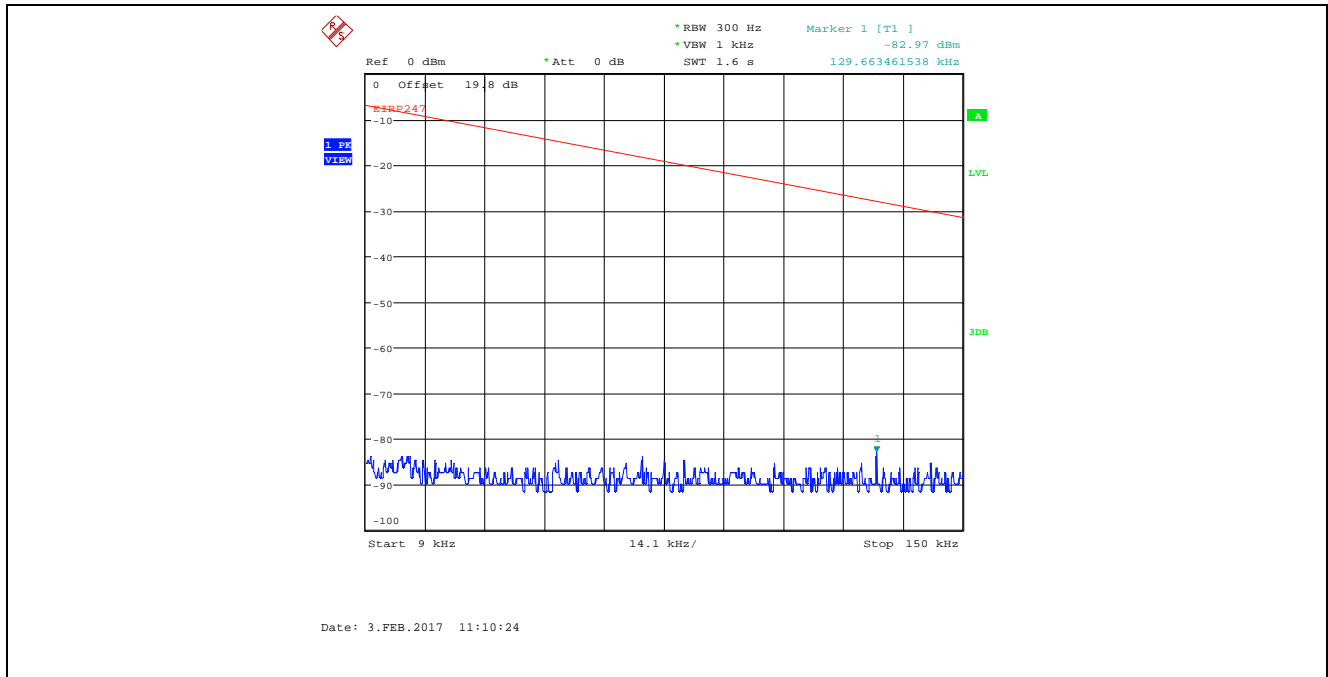

**Plot 5.4.4.3.17.** Conducted Spurious Emissions in Restricted Frequency Bands  
Bandwidth: 8 MHz, TX Gain Setting 55, Data Rate 4, 2407 MHz, 150 kHz - 30 MHz, Peak Detector

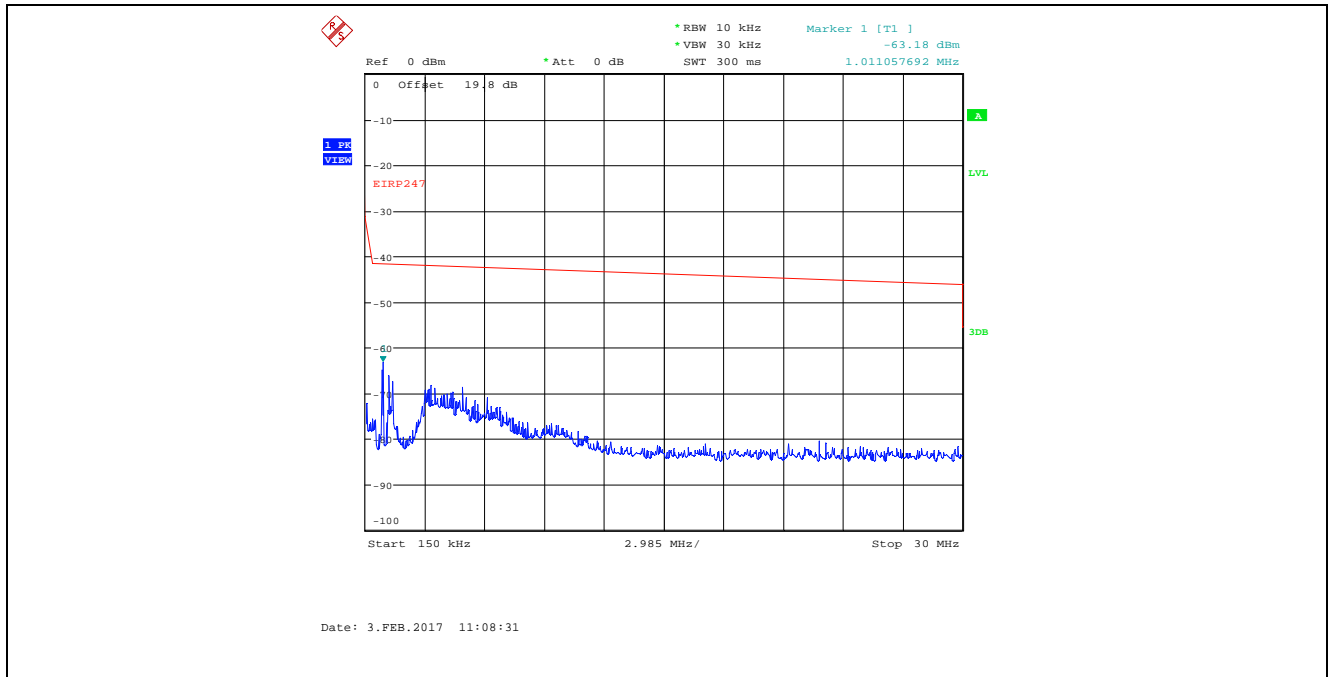

**Plot 5.4.4.3.18.** Conducted Spurious Emissions in Restricted Frequency Bands  
Bandwidth: 8 MHz, TX Gain Setting 55, Data Rate 4, 2407 MHz, 30 MHz - 1 GHz, Peak Detector

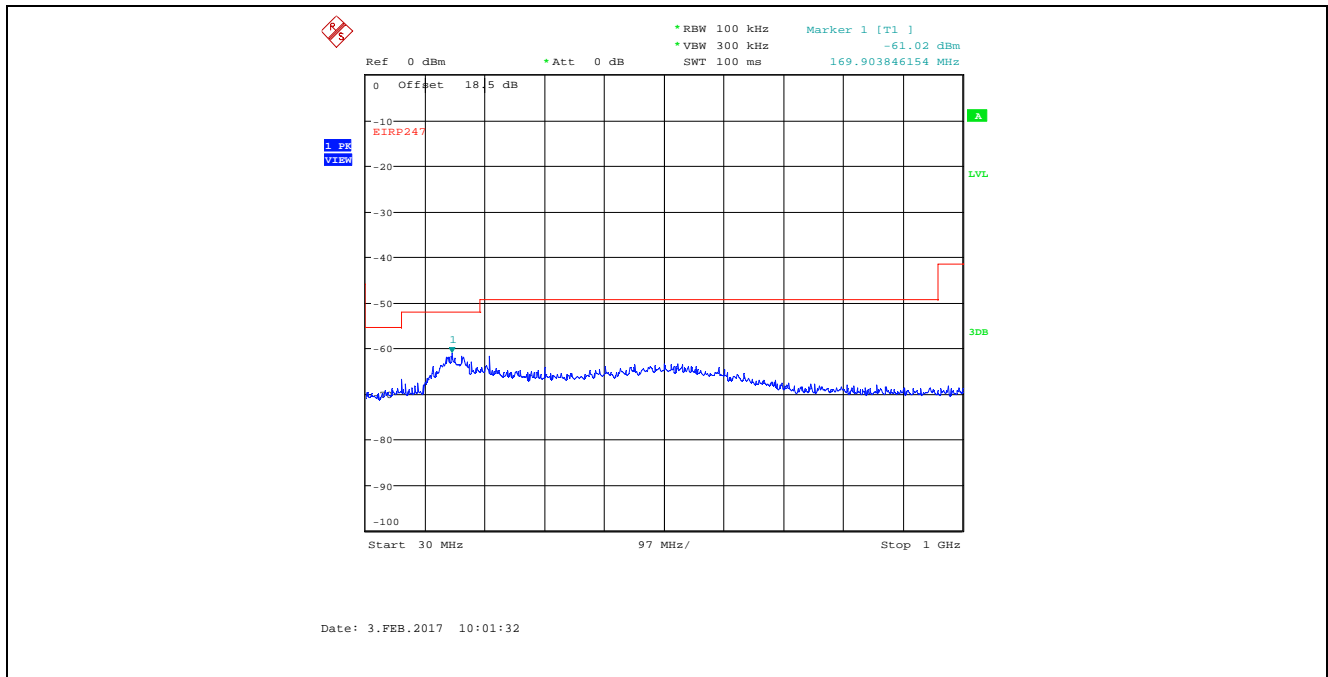

**Plot 5.4.4.3.19.** Conducted Spurious Emissions in Restricted Frequency Bands  
Bandwidth: 8 MHz, TX Gain Setting 55, Data Rate 4, 2407 MHz, 1 GHz - 4 GHz, Peak Detector

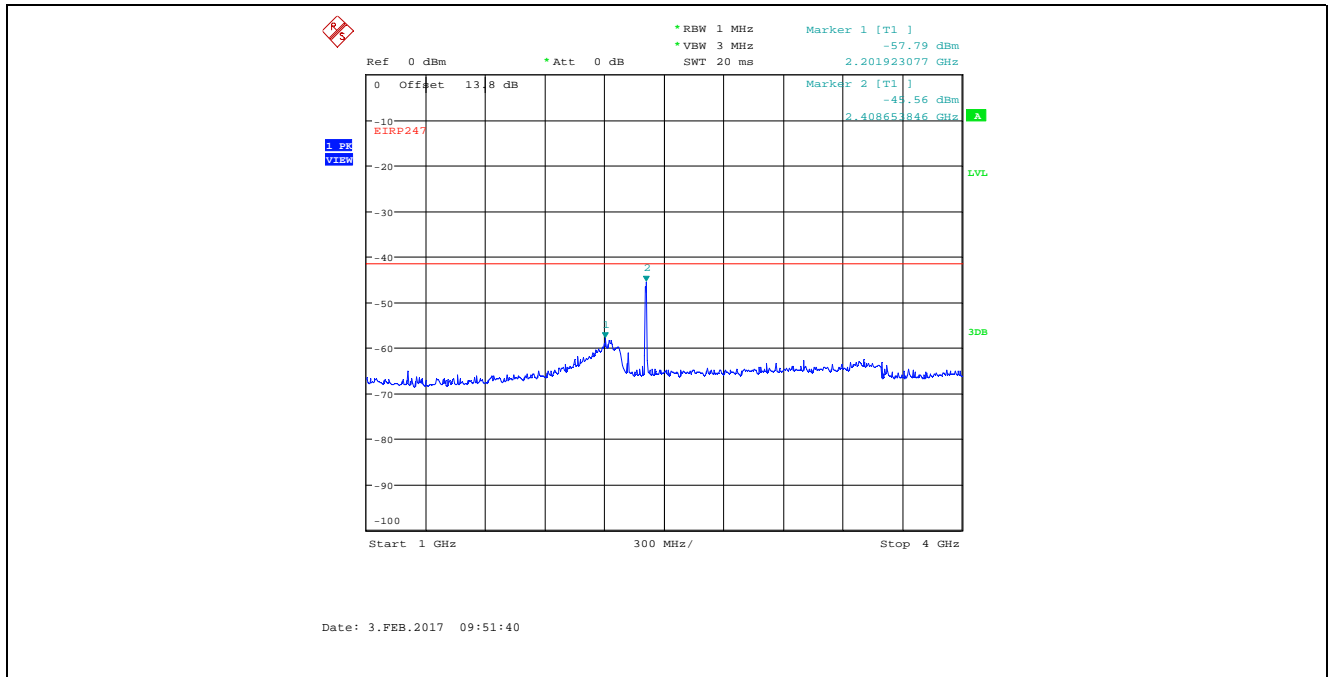

**Plot 5.4.4.3.20.** Conducted Spurious Emissions in Restricted Frequency Bands  
Bandwidth: 8 MHz, TX Gain Setting 55, Data Rate 4, 2407 MHz, 4 GHz - 25 GHz, Peak Detector

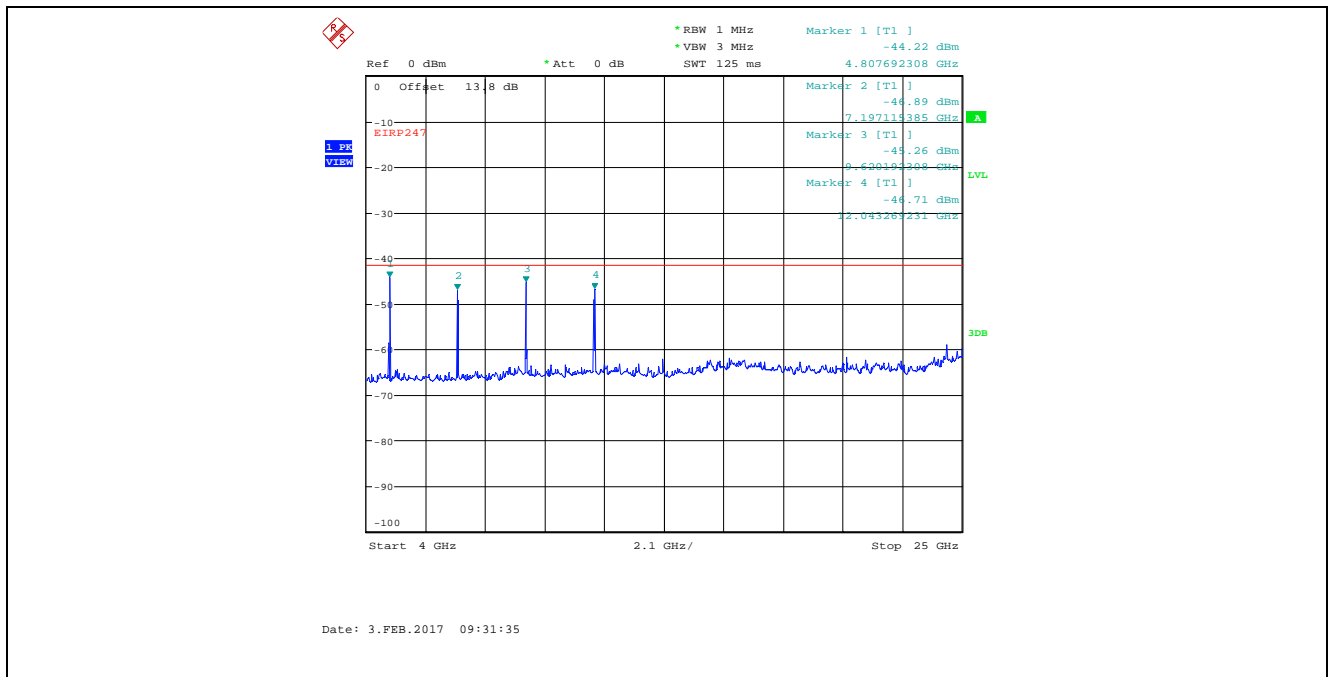

**Plot 5.4.4.3.21.** Conducted Spurious Emissions in Restricted Frequency Bands  
Bandwidth: 8 MHz, TX Gain Setting 55, Data Rate 4, 2442 MHz, 9 kHz - 150 kHz, Peak Detector

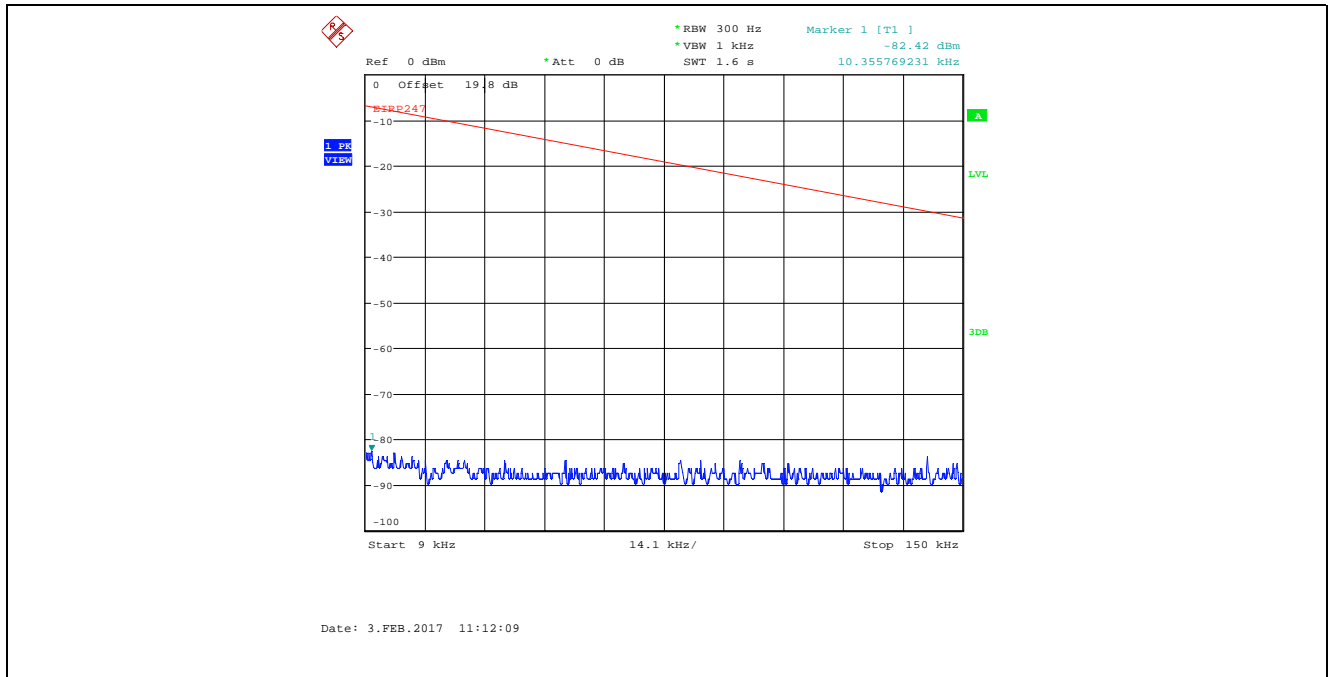

**Plot 5.4.4.3.22.** Conducted Spurious Emissions in Restricted Frequency Bands  
Bandwidth: 8 MHz, TX Gain Setting 55, Data Rate 4, 2442 MHz, 150 kHz - 30 MHz, Peak Detector

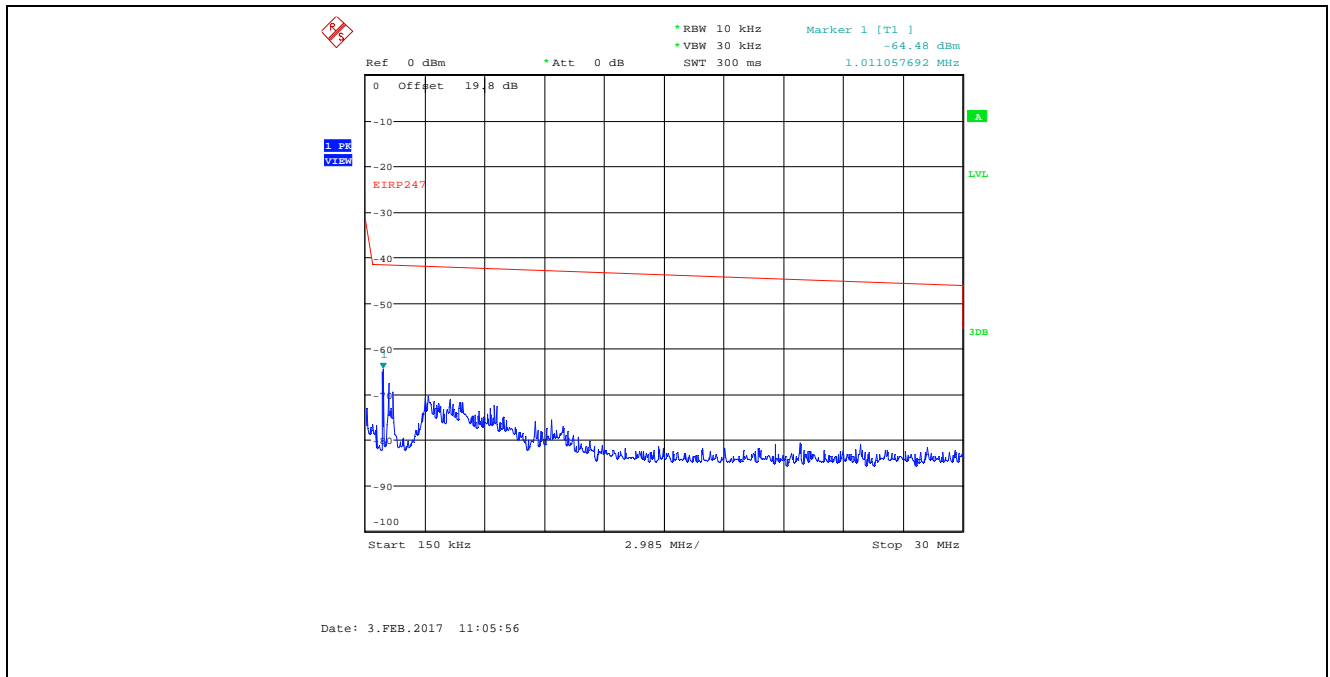

**Plot 5.4.4.3.23.** Conducted Spurious Emissions in Restricted Frequency Bands  
Bandwidth: 8 MHz, TX Gain Setting 55, Data Rate 4, 2442 MHz, 30 MHz - 1 GHz, Peak Detector

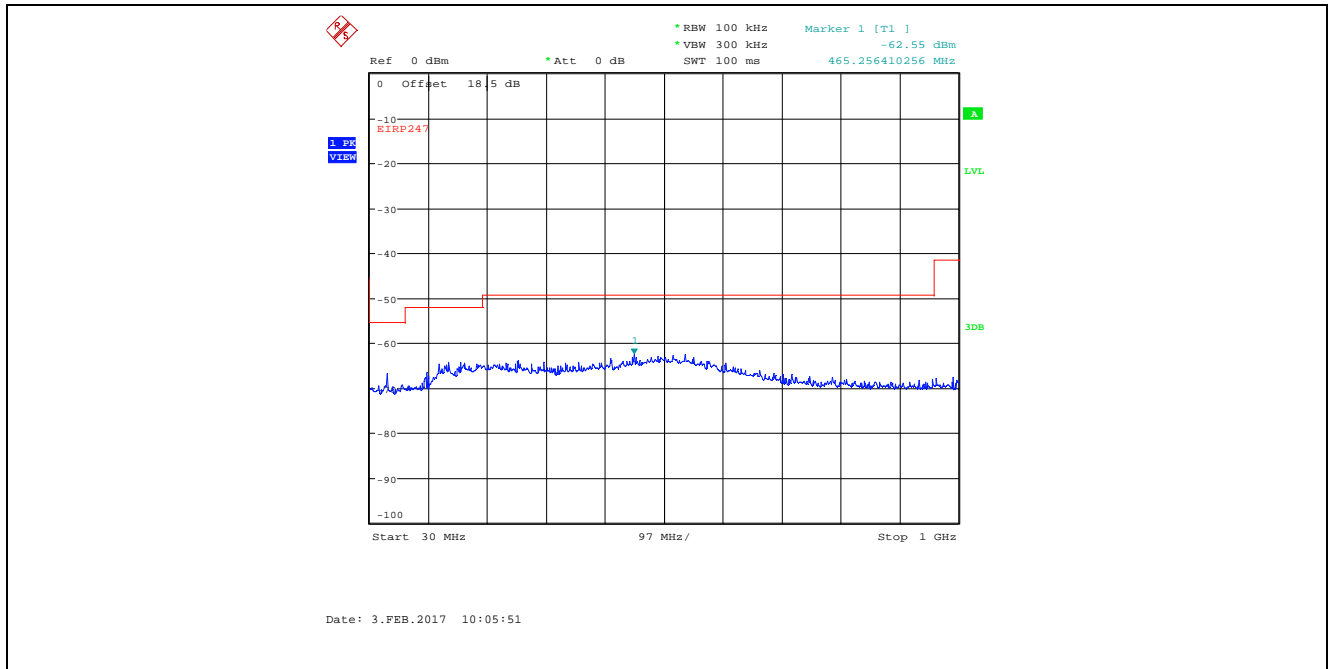

**Plot 5.4.4.3.24.** Conducted Spurious Emissions in Restricted Frequency Bands  
Bandwidth: 8 MHz, TX Gain Setting 55, Data Rate 4, 2442 MHz, 1 GHz - 4 GHz, Peak Detector  
Marker 2 is the Fundamental

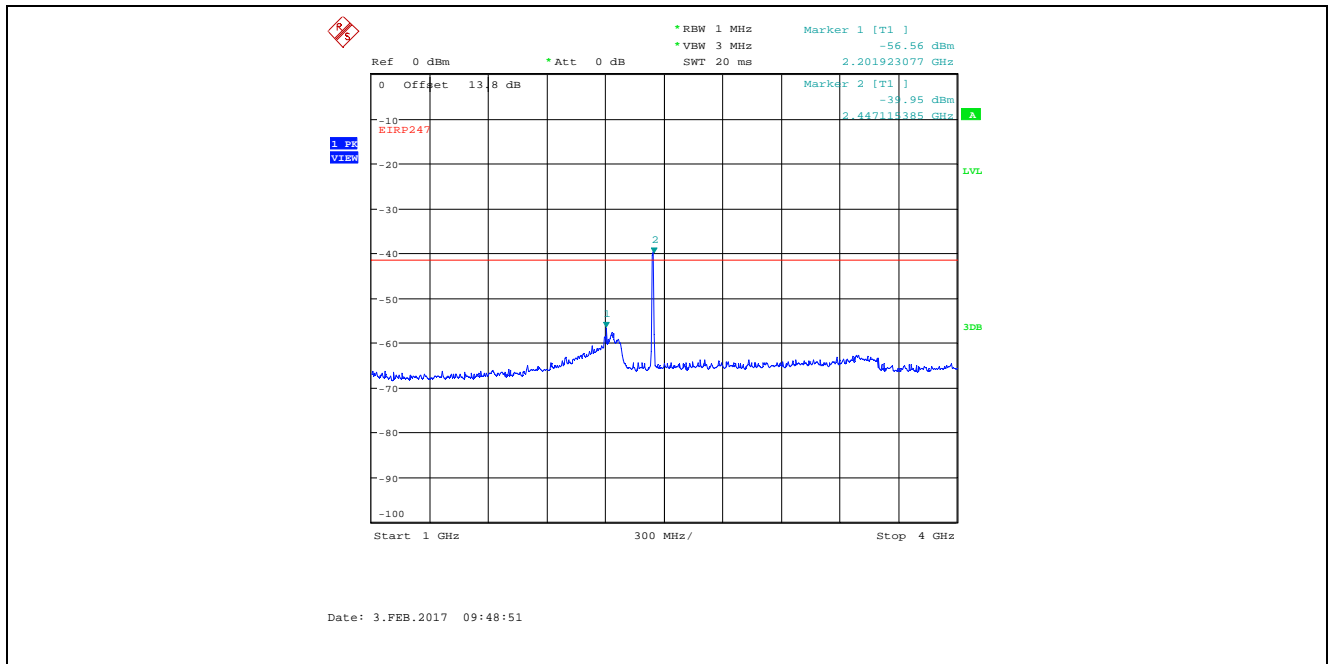

**Plot 5.4.4.3.25.** Conducted Spurious Emissions in Restricted Frequency Bands  
 Bandwidth: 8 MHz, TX Gain Setting 55, Data Rate 4, 2442 MHz, 4 GHz - 25 GHz, Peak Detector

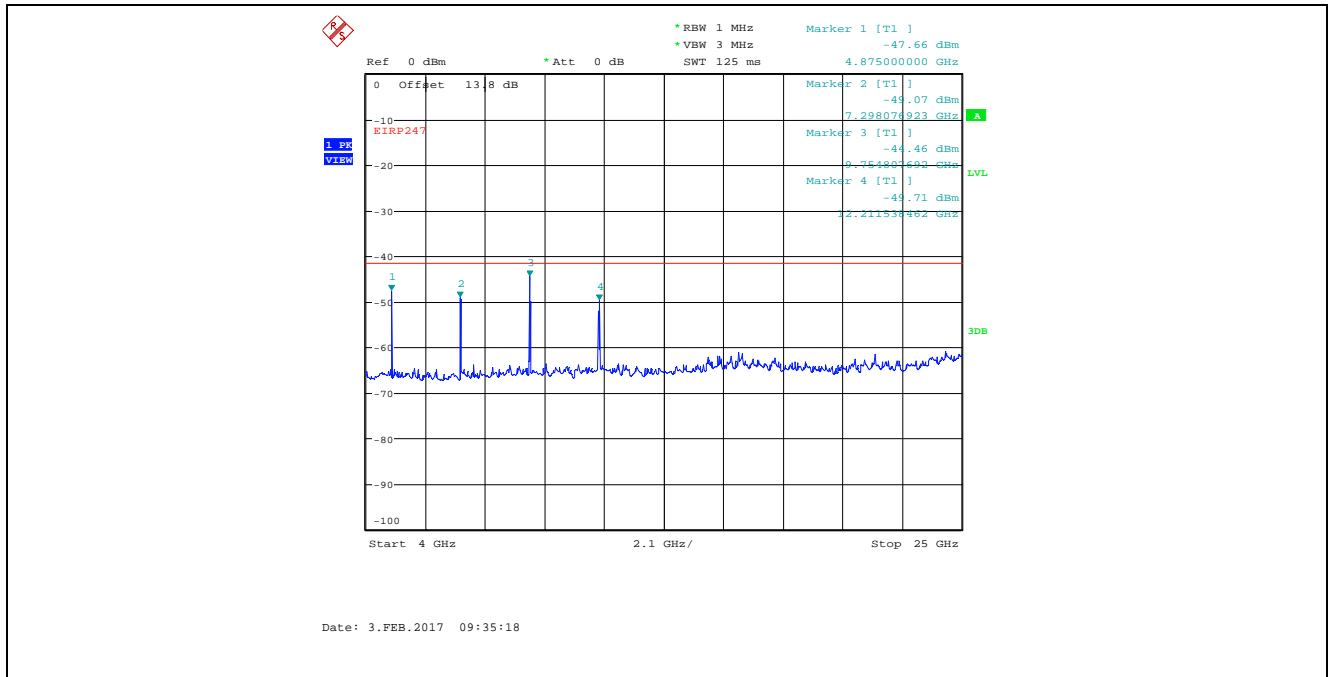

**Plot 5.4.4.3.26.** Conducted Spurious Emissions in Restricted Frequency Bands  
 Bandwidth: 8 MHz, TX Gain Setting 55, Data Rate 4, 2477 MHz, 9 kHz - 150 kHz, Peak Detector

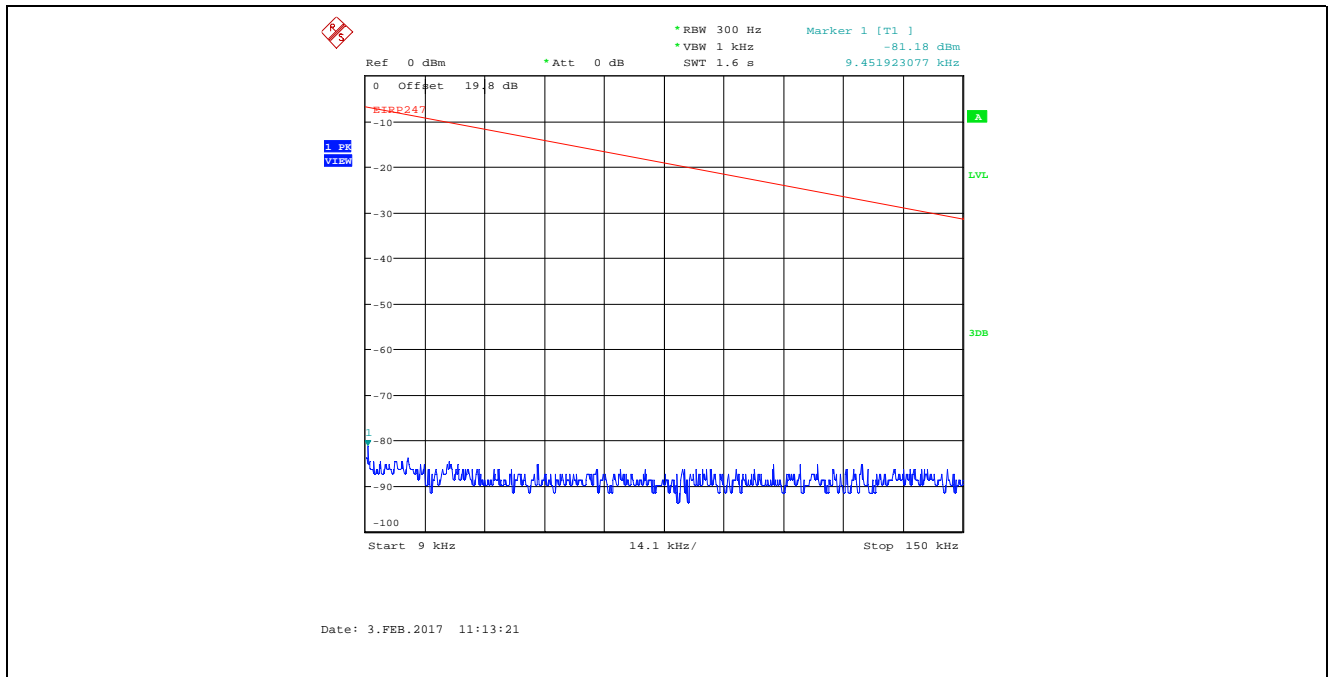

**Plot 5.4.4.3.27.** Conducted Spurious Emissions in Restricted Frequency Bands  
Bandwidth: 8 MHz, TX Gain Setting 55, Data Rate 4, 2477 MHz, 150 kHz - 30 MHz, Peak Detector

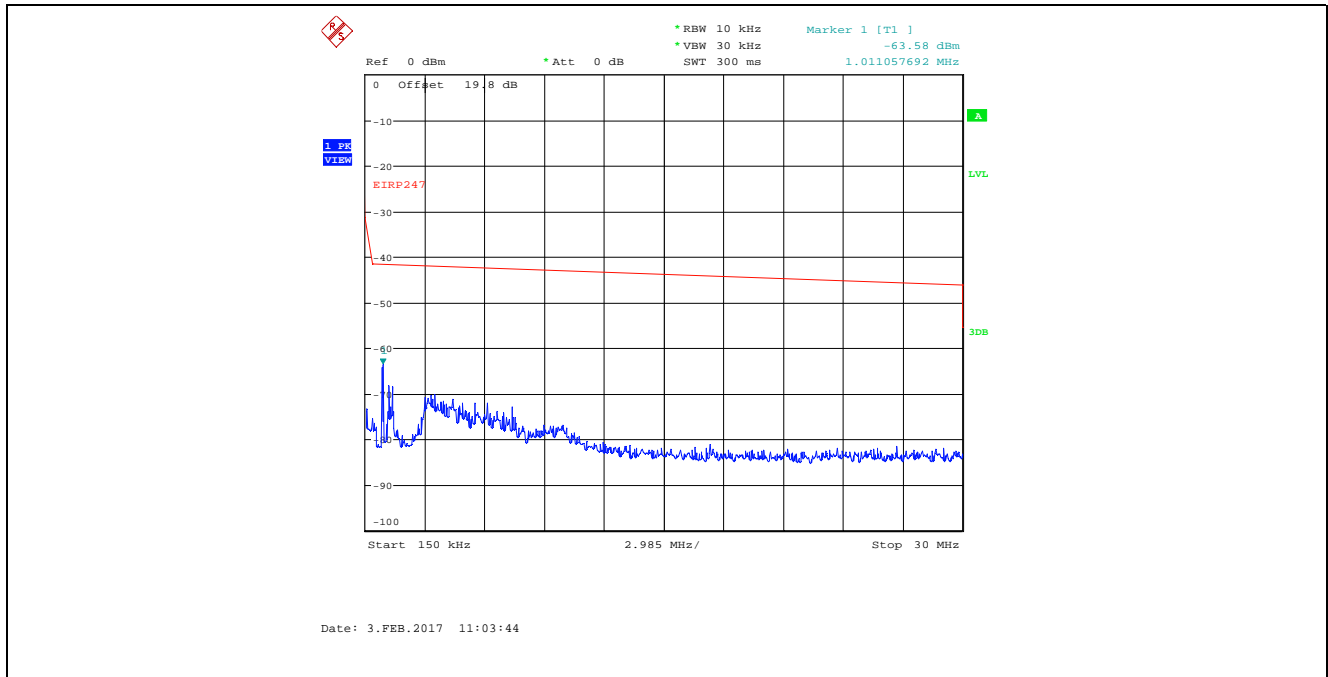

**Plot 5.4.4.3.28.** Conducted Spurious Emissions in Restricted Frequency Bands  
Bandwidth: 8 MHz, TX Gain Setting 55, Data Rate 4, 2477 MHz, 30 MHz - 1 GHz, Peak Detector

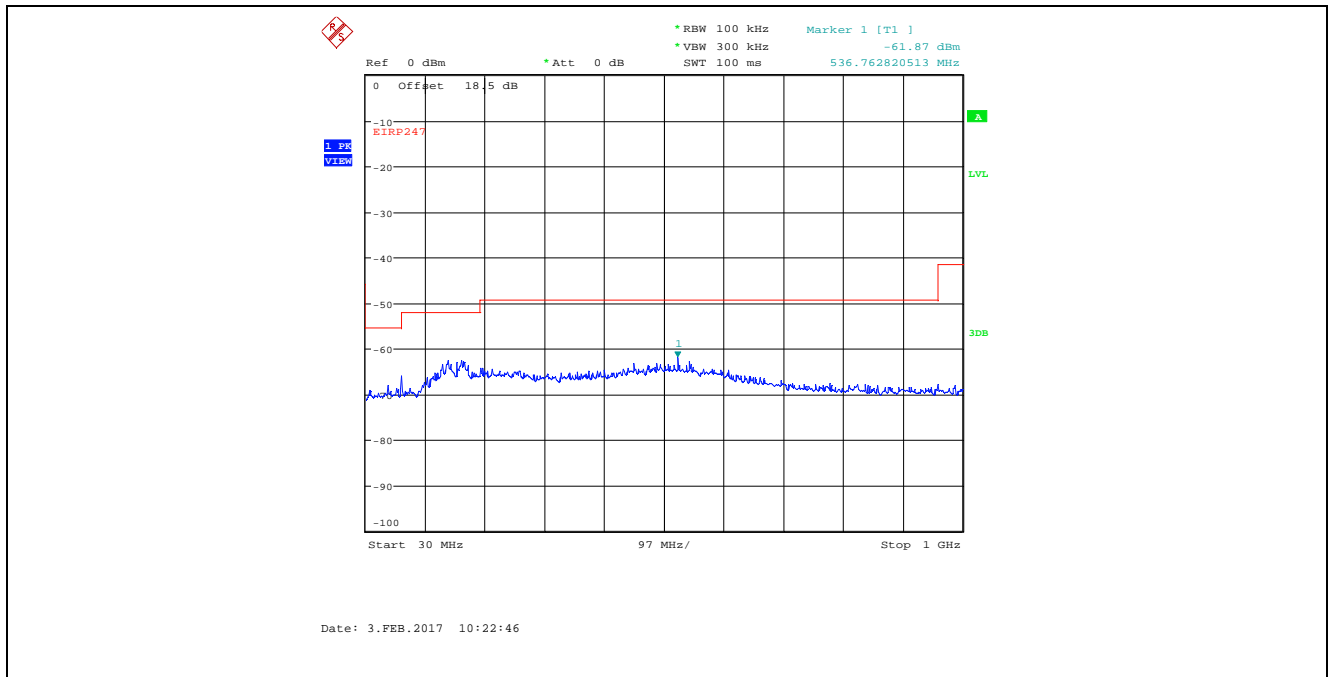



**Plot 5.4.4.3.29.** Conducted Spurious Emissions in Restricted Frequency Bands  
 Bandwidth: 8 MHz, TX Gain Setting 55, Data Rate 4, 2477 MHz, 1 GHz - 4 GHz, Peak Detector  
 Marker 2 is the Fundamental

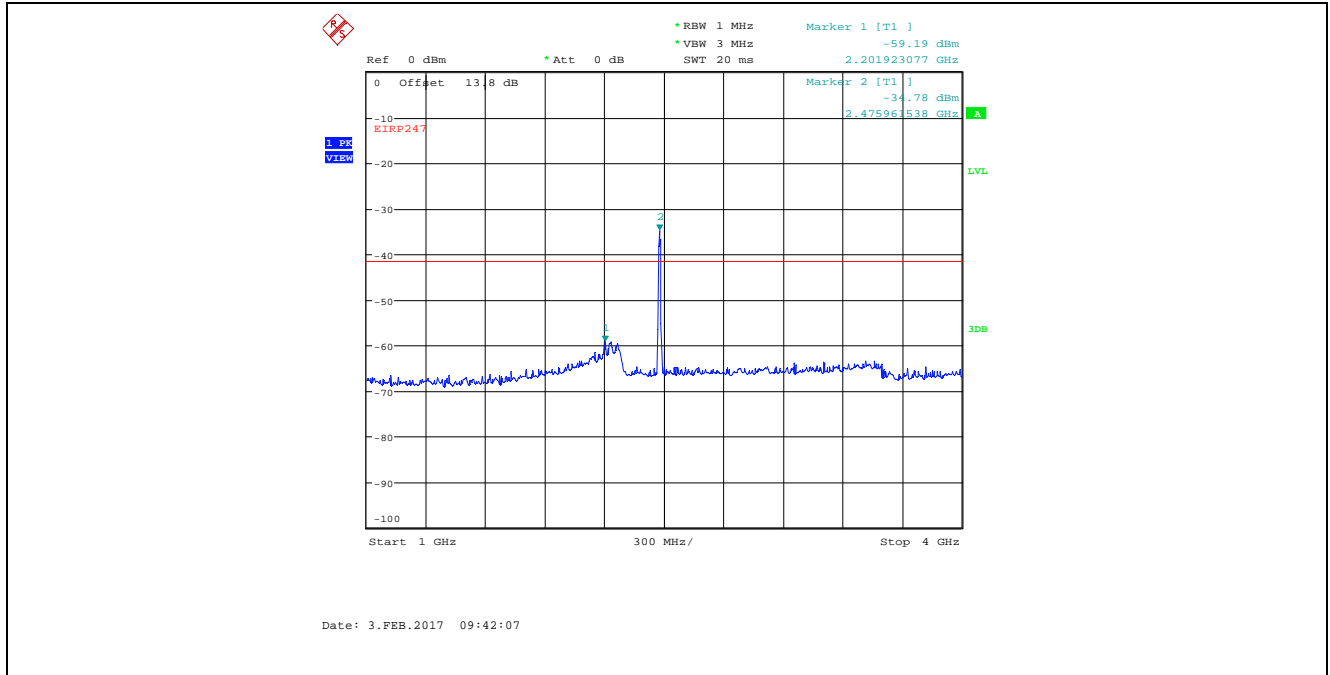

**Plot 5.4.4.3.30.** Conducted Spurious Emissions in Restricted Frequency Bands  
 Bandwidth: 8 MHz, TX Gain Setting 55, Data Rate 4, 2477 MHz, 4 GHz - 25 GHz, Peak Detector

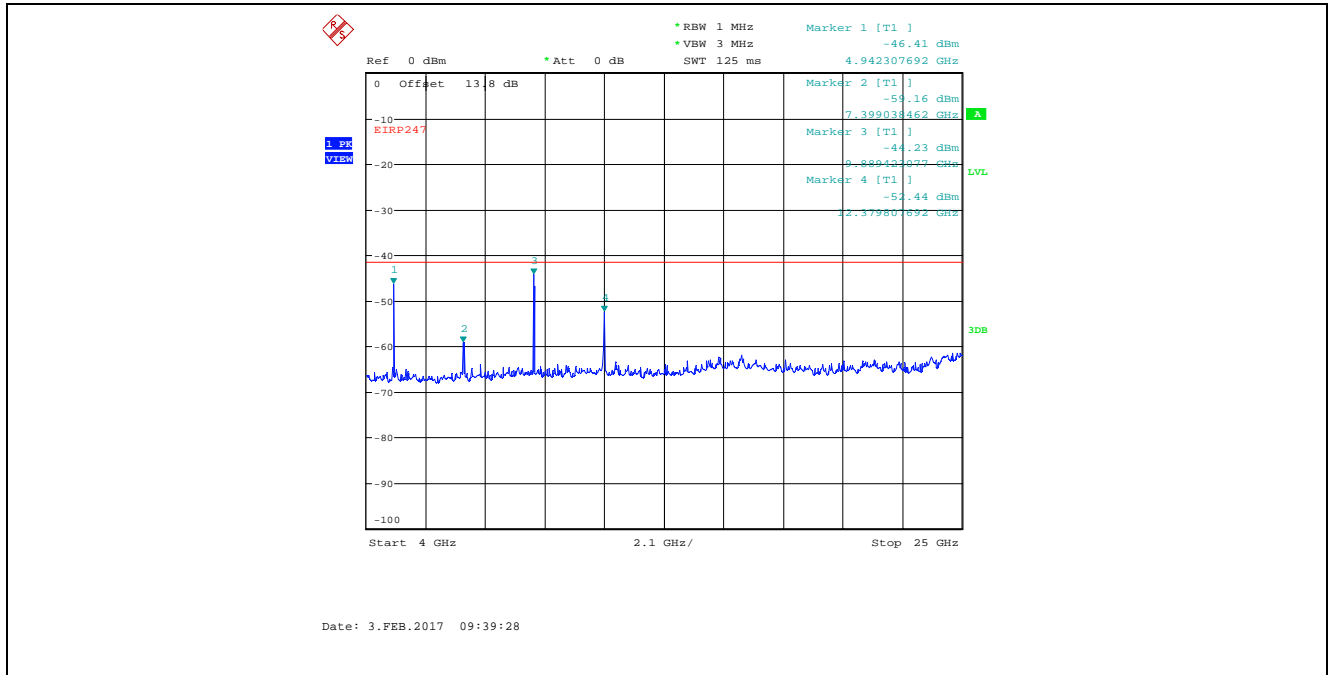

**5.4.4.4. Conducted Spurious Emissions in Restricted Frequency Bands, Lower Power Setting for Highest Gain Antenna (15 dBi, with Antenna Assembly Gain of 13.55 dBi)**

**Remark:** Offset = [Insertion Loss] + [Transmit Antenna Gain (in dBi)] + [Maximum Ground Reflection Factor]

**Plot 5.4.4.4.1.** Conducted Spurious Emissions in Restricted Frequency Bands  
 Bandwidth: 8 MHz, TX Gain Setting 25, Data Rate 1, 2407 MHz, 9 kHz - 150 kHz, Peak Detector

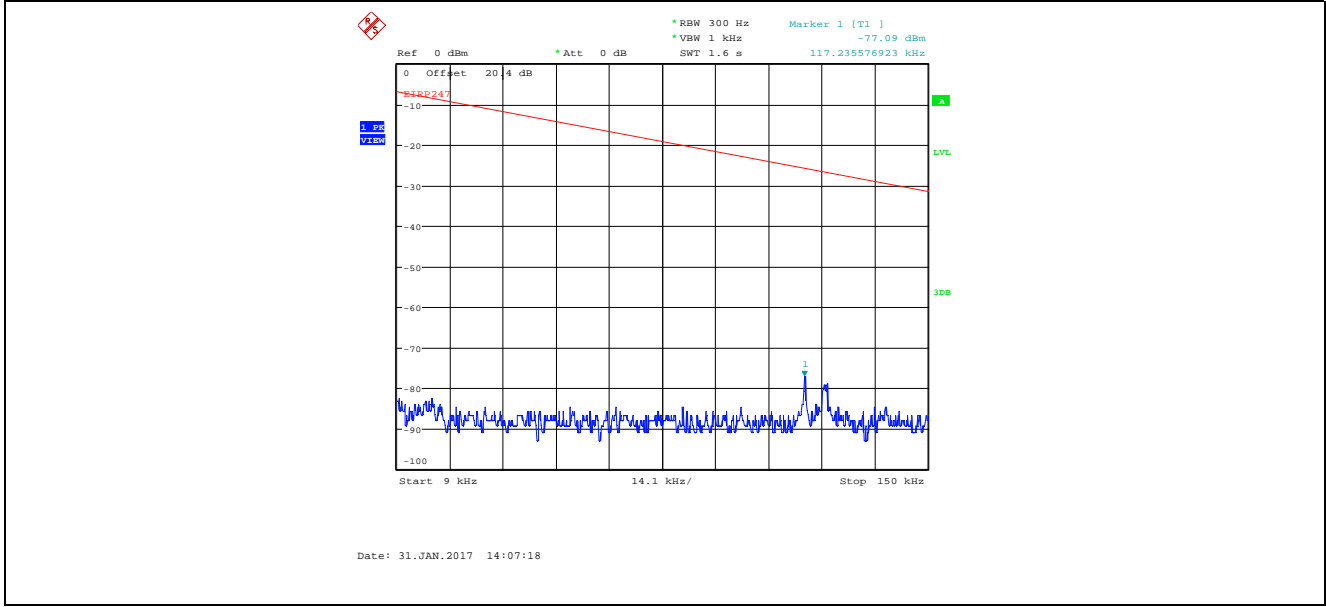

**Plot 5.4.4.4.2.** Conducted Spurious Emissions in Restricted Frequency Bands  
 Bandwidth: 8 MHz, TX Gain Setting 25, Data Rate 1, 2407 MHz, 150 kHz - 30 MHz, Peak Detector

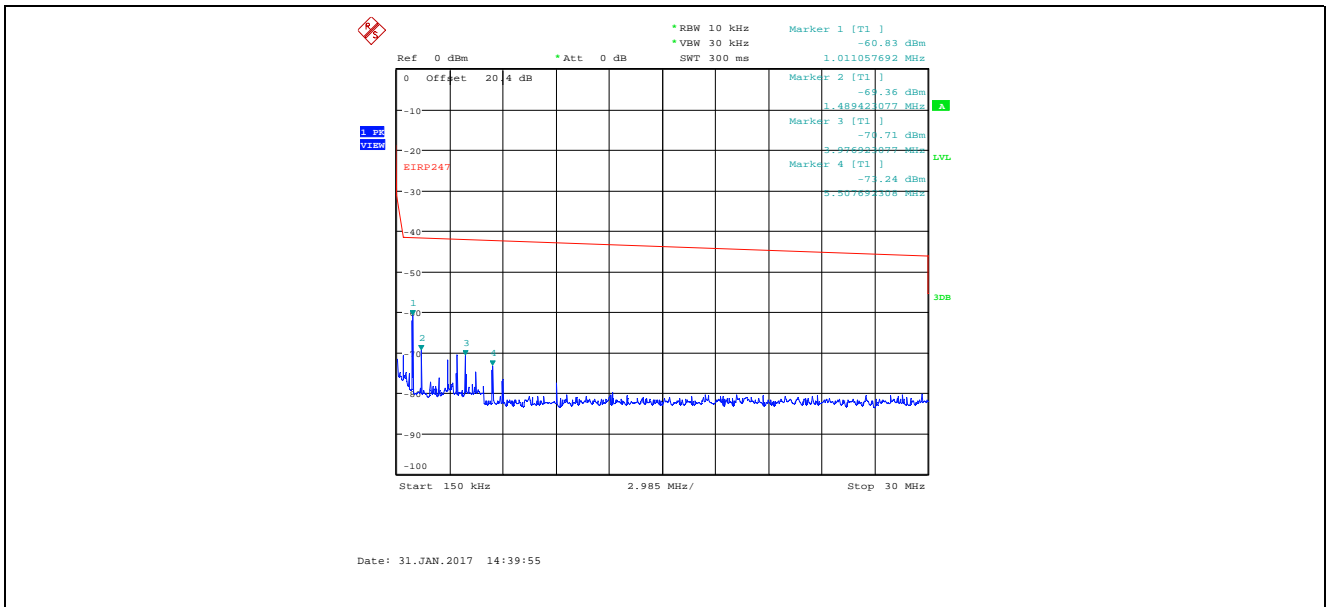

**Plot 5.4.4.3.** Conducted Spurious Emissions in Restricted Frequency Bands  
Bandwidth: 8 MHz, TX Gain Setting 25, Data Rate 1, 2407 MHz, 30 MHz - 1 GHz, Peak Detector

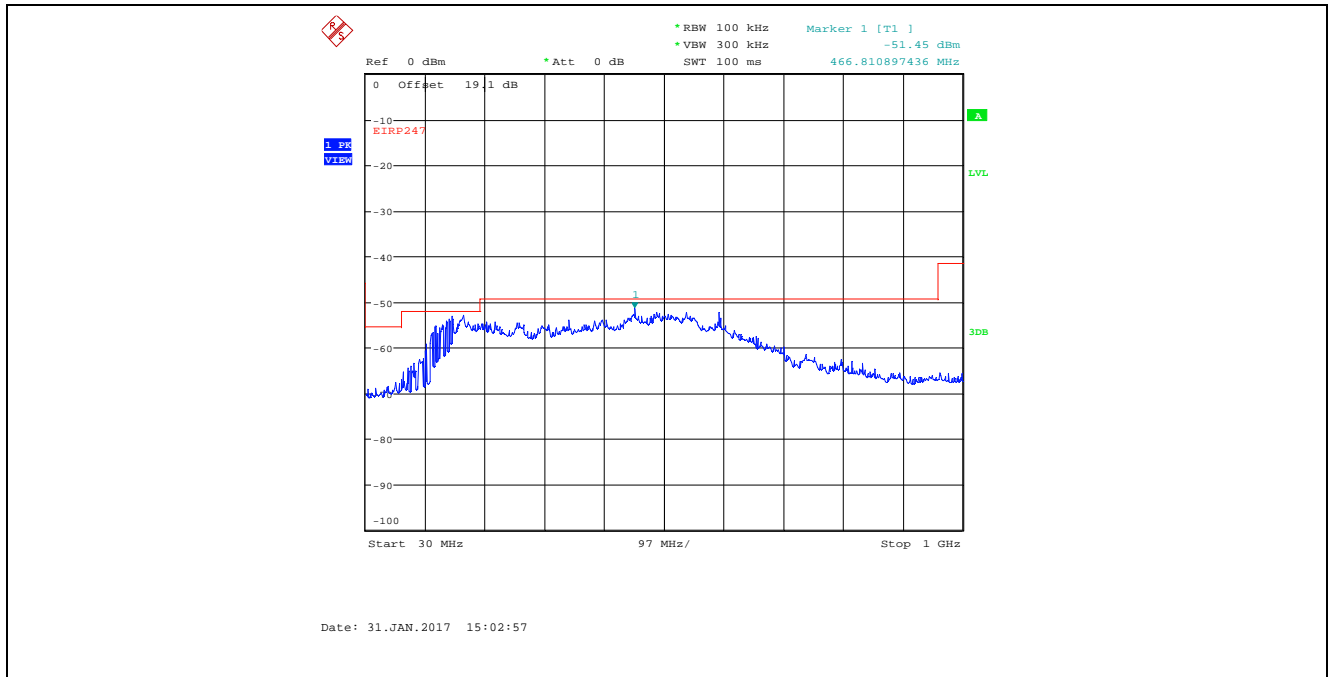

**Plot 5.4.4.4.** Conducted Spurious Emissions in Restricted Frequency Bands  
Bandwidth: 8 MHz, TX Gain Setting 25, Data Rate 1, 2407 MHz, 1 GHz - 4 GHz, Peak Detector

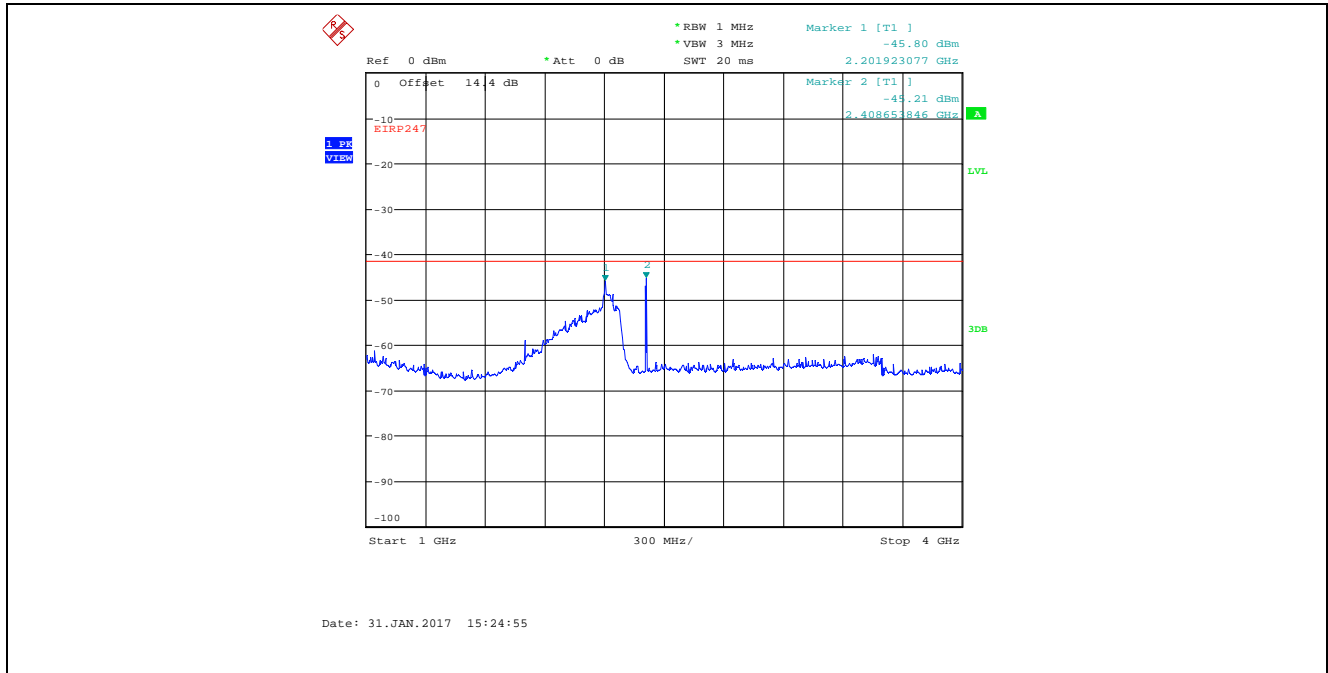

**Plot 5.4.4.4.5.** Conducted Spurious Emissions in Restricted Frequency Bands  
 Bandwidth: 8 MHz, TX Gain Setting 25, Data Rate 1, 2407 MHz, 4 GHz - 25 GHz, Peak Detector

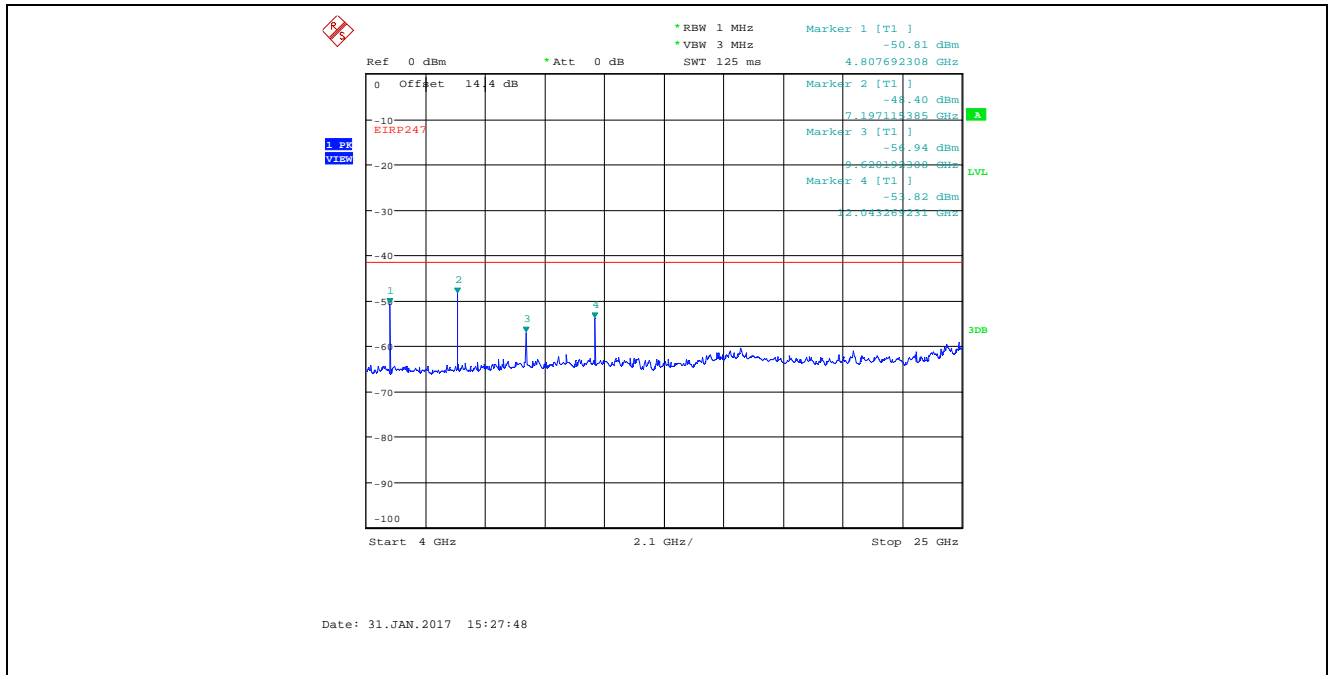

**Plot 5.4.4.4.6.** Conducted Spurious Emissions in Restricted Frequency Bands  
 Bandwidth: 8 MHz, TX Gain Setting 25, Data Rate 1, 2442 MHz, 9 kHz - 150 kHz, Peak Detector

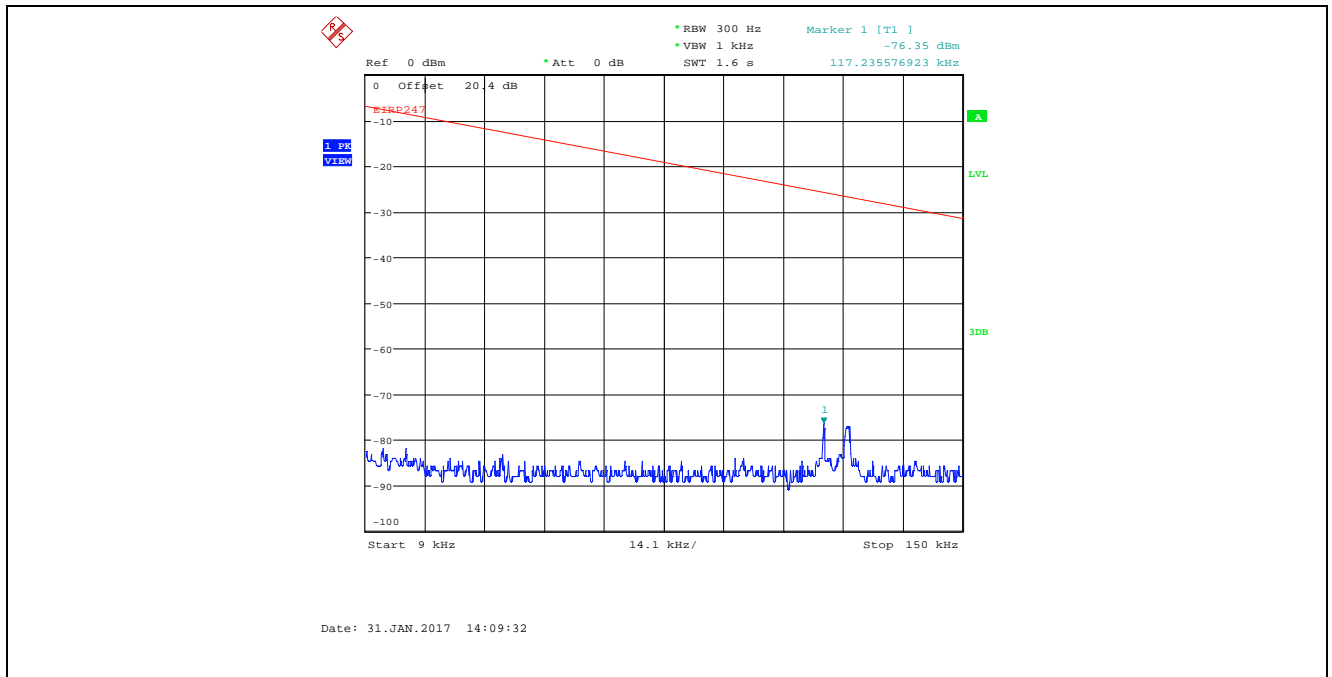

**Plot 5.4.4.7.** Conducted Spurious Emissions in Restricted Frequency Bands  
Bandwidth: 8 MHz, TX Gain Setting 25, Data Rate 1, 2442 MHz, 150 kHz - 30 MHz, Peak Detector

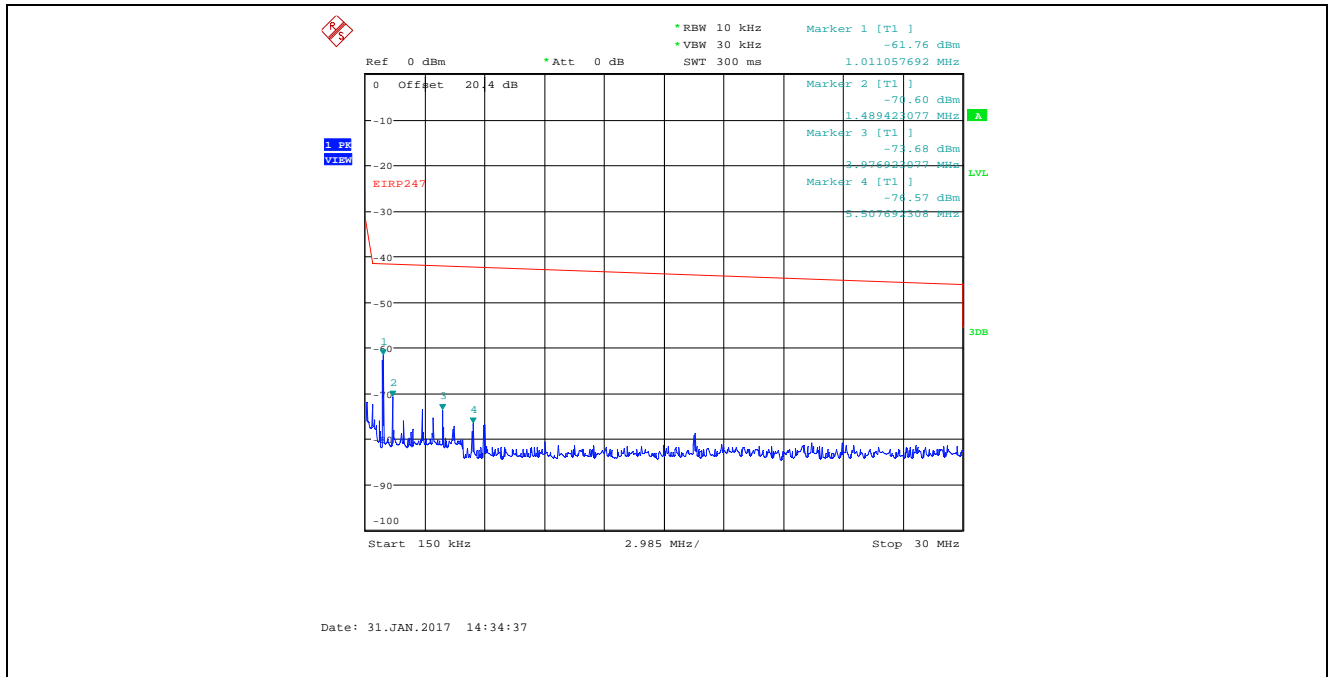

**Plot 5.4.4.8.** Conducted Spurious Emissions in Restricted Frequency Bands  
Bandwidth: 8 MHz, TX Gain Setting 25, Data Rate 1, 2442 MHz, 30 MHz - 1 GHz, Peak Detector

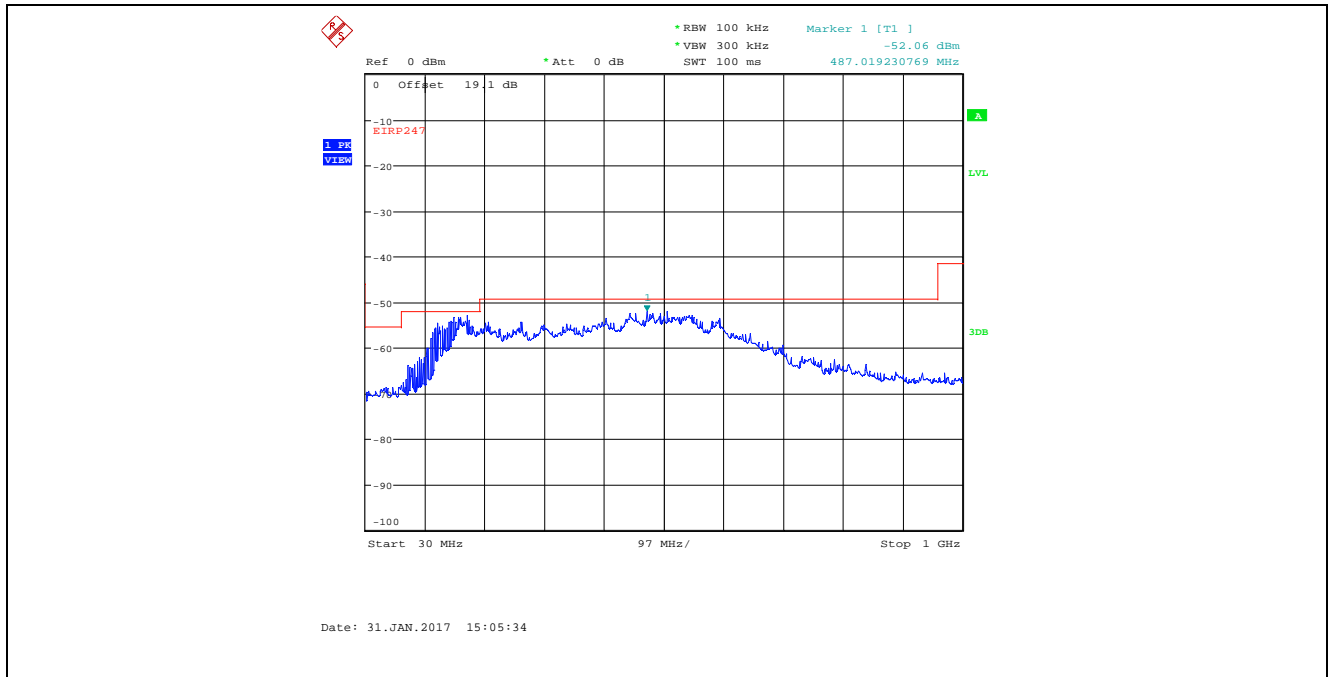

**Plot 5.4.4.9.** Conducted Spurious Emissions in Restricted Frequency Bands  
 Bandwidth: 8 MHz, TX Gain Setting 25, Data Rate 1, 2442 MHz, 1 GHz - 4 GHz, Peak Detector  
 Marker 2 is the Fundamental

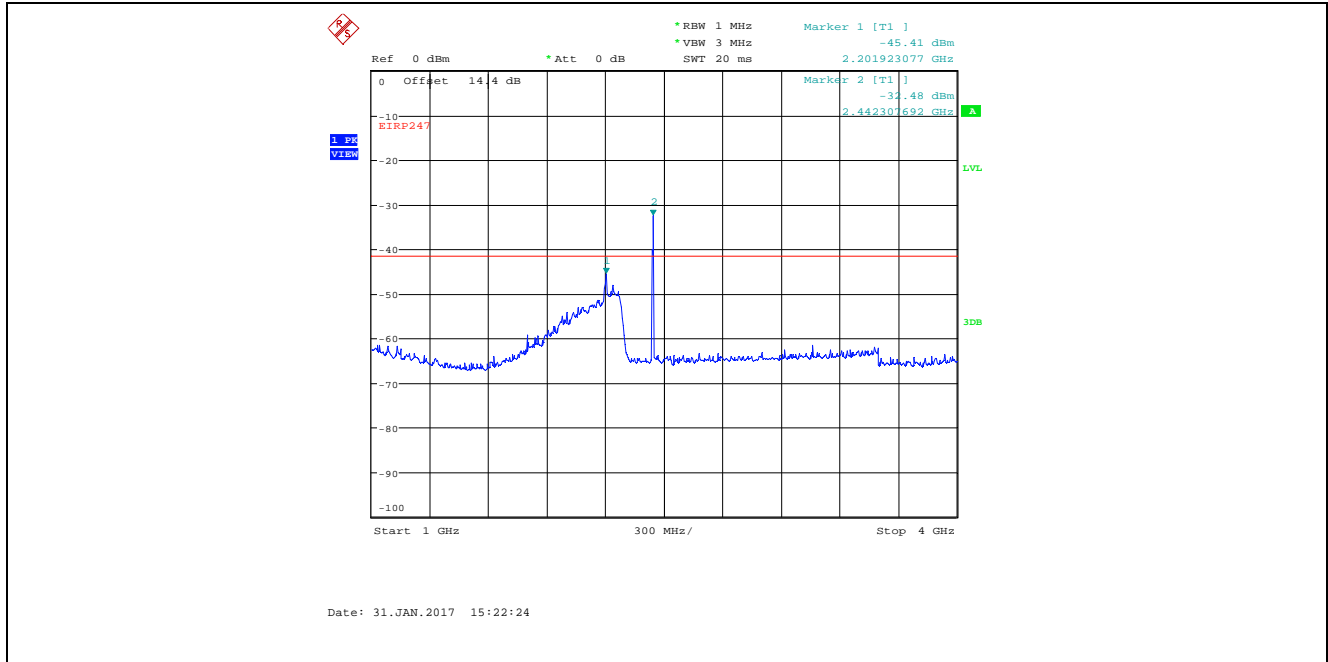

**Plot 5.4.4.10.** Conducted Spurious Emissions in Restricted Frequency Bands  
 Bandwidth: 8 MHz, TX Gain Setting 25, Data Rate 1, 2442 MHz, 4 GHz - 25 GHz, Peak Detector

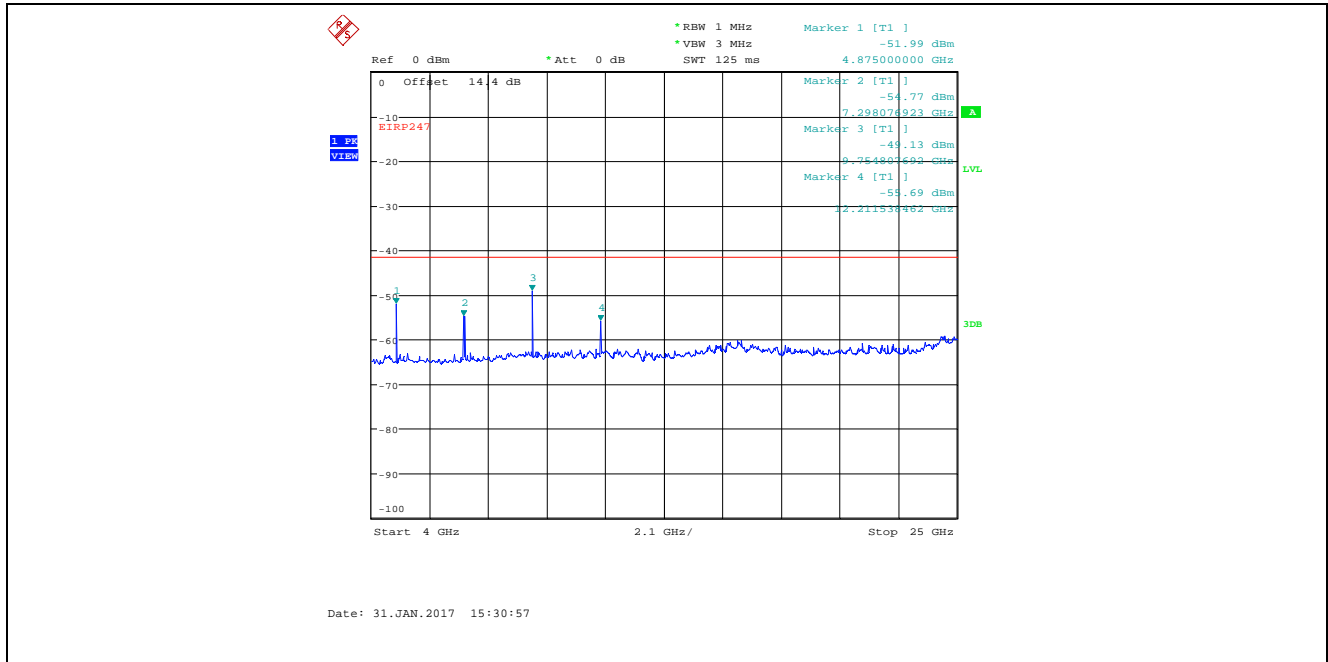

**Plot 5.4.4.11.** Conducted Spurious Emissions in Restricted Frequency Bands  
 Bandwidth: 8 MHz, TX Gain Setting 25, Data Rate 1, 2477 MHz, 9 kHz - 150 kHz, Peak Detector

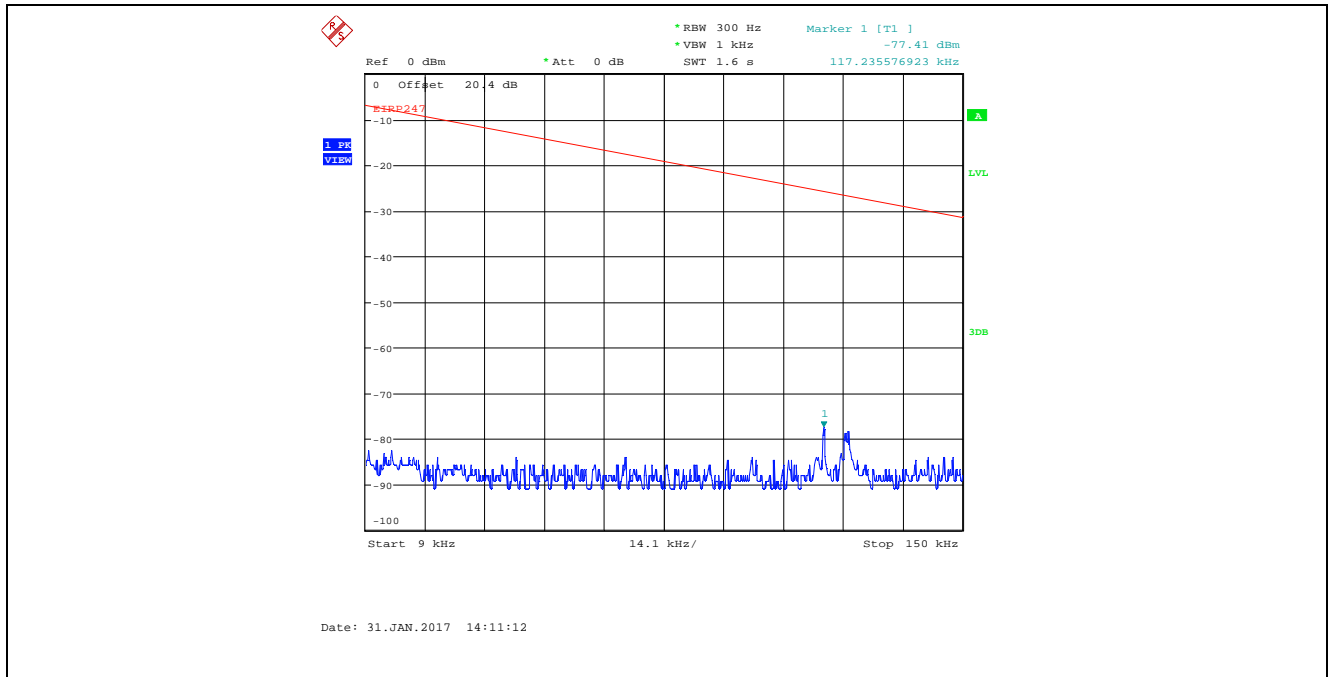

**Plot 5.4.4.12.** Conducted Spurious Emissions in Restricted Frequency Bands  
 Bandwidth: 8 MHz, TX Gain Setting 25, Data Rate 1, 2477 MHz, 150 kHz - 30 MHz, Peak Detector

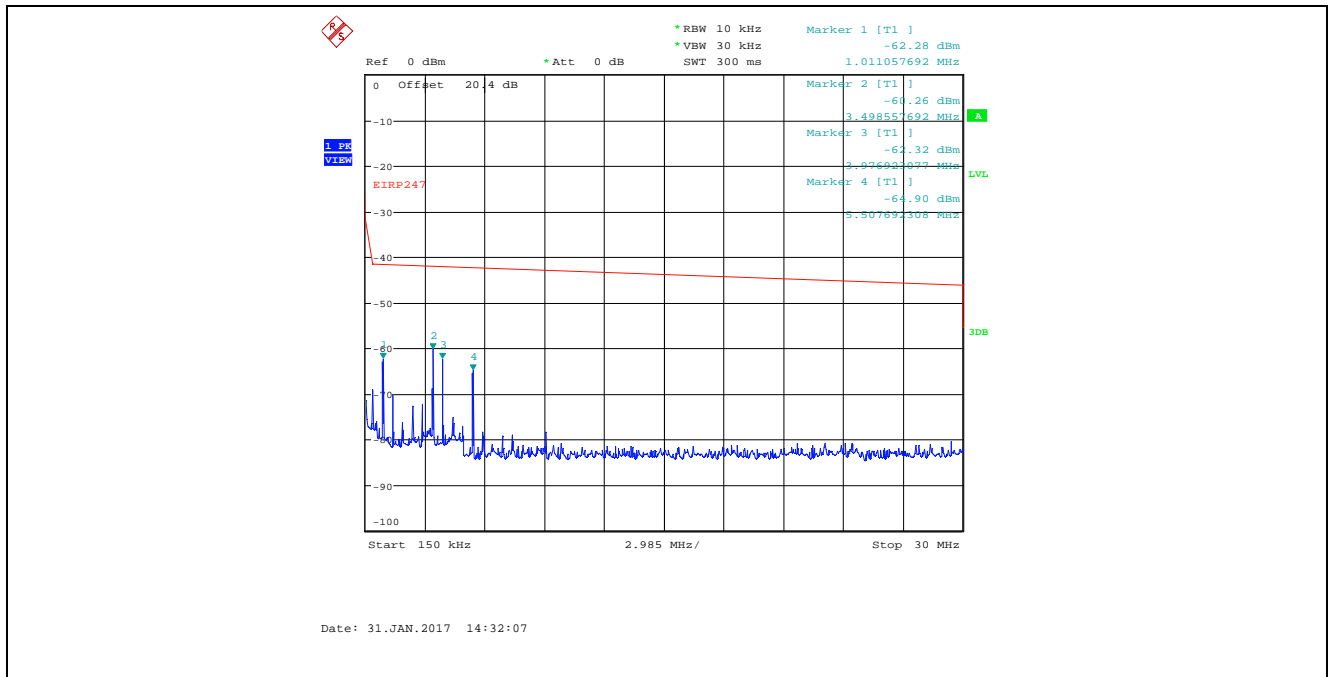

**Plot 5.4.4.13.** Conducted Spurious Emissions in Restricted Frequency Bands  
Bandwidth: 8 MHz, TX Gain Setting 25, Data Rate 1, 2477 MHz, 30 MHz - 1 GHz, Peak Detector

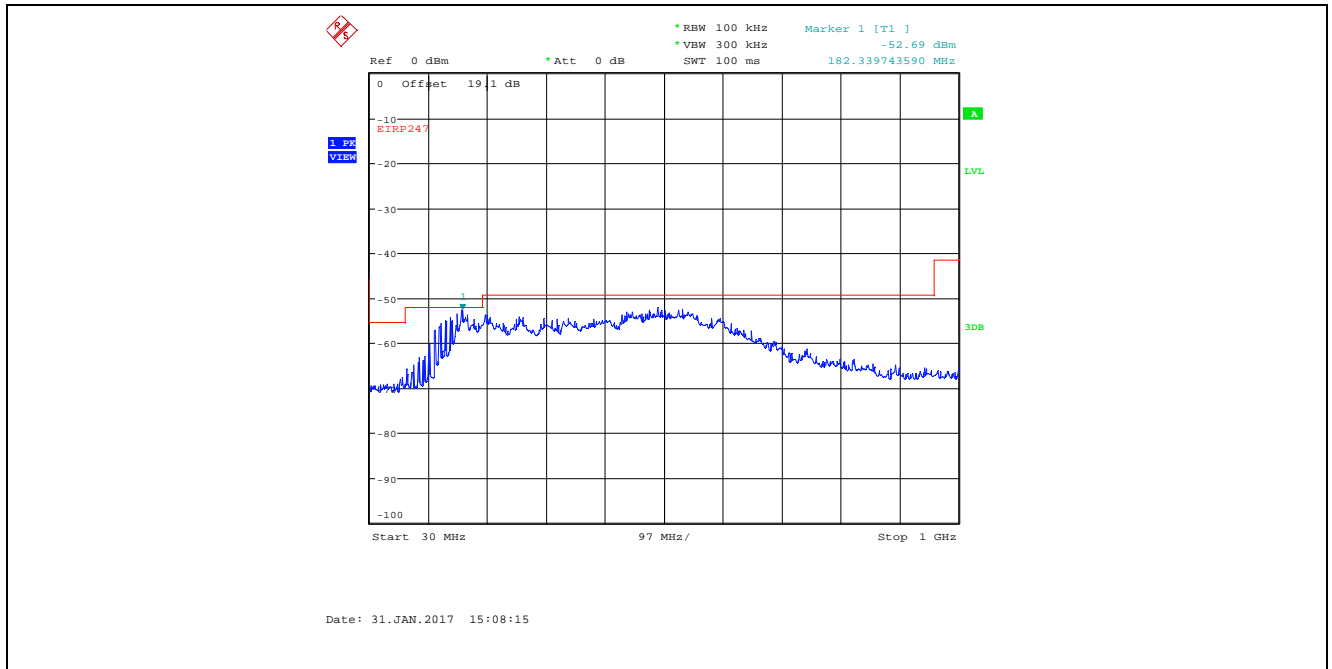

**Plot 5.4.4.14.** Conducted Spurious Emissions in Restricted Frequency Bands  
Bandwidth: 8 MHz, TX Gain Setting 25, Data Rate 1, 2477 MHz, 1 GHz - 4 GHz, Peak Detector  
Marker 2 is the Fundamental

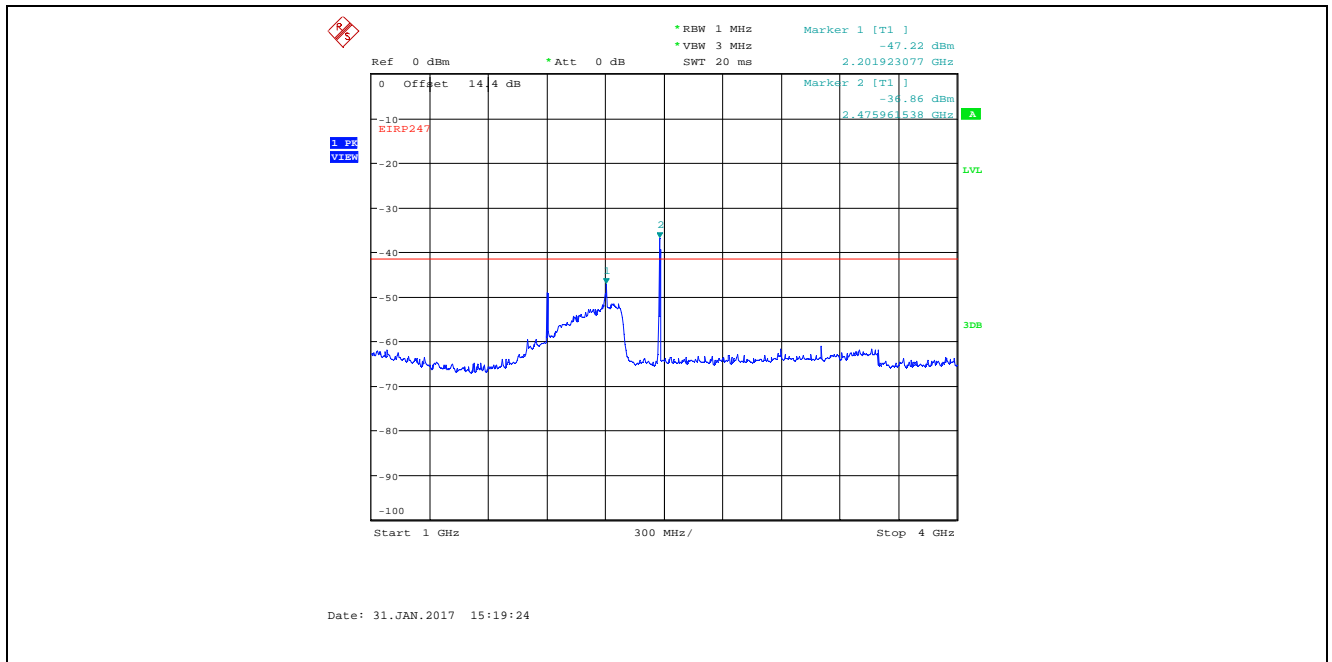



**Plot 5.4.4.15.** Conducted Spurious Emissions in Restricted Frequency Bands  
 Bandwidth: 8 MHz, TX Gain Setting 25, Data Rate 1, 2477 MHz, 4 GHz - 25 GHz, Peak Detector

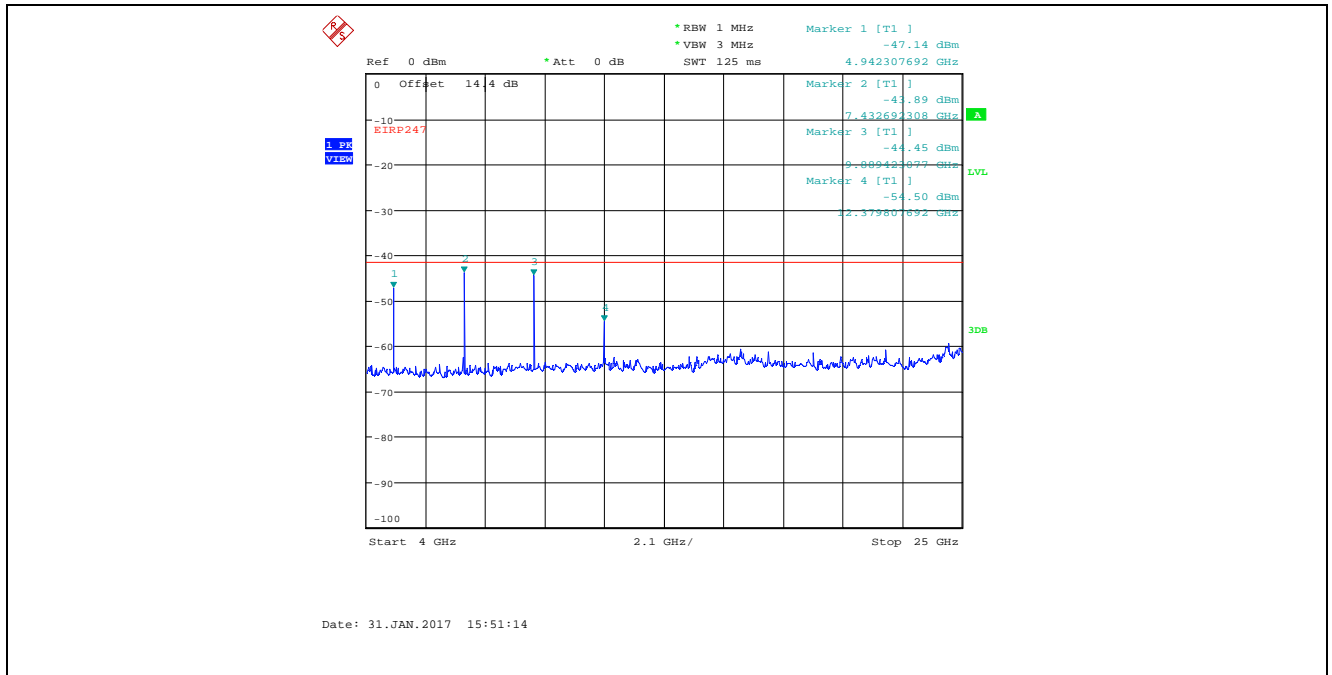

**Plot 5.4.4.16.** Conducted Spurious Emissions in Restricted Frequency Bands  
 Bandwidth: 8 MHz, TX Gain Setting 25, Data Rate 4, 2407 MHz, 9 kHz - 150 kHz, Peak Detector

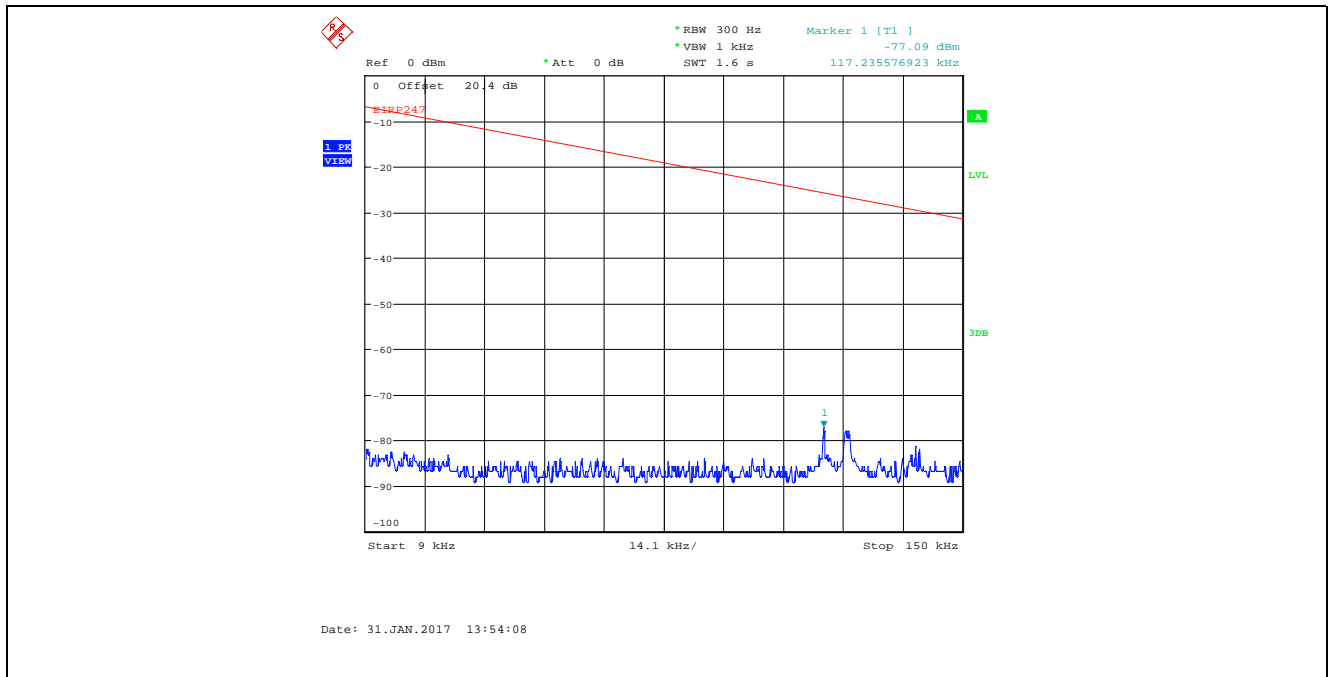

**Plot 5.4.4.17.** Conducted Spurious Emissions in Restricted Frequency Bands  
Bandwidth: 8 MHz, TX Gain Setting 25, Data Rate 4, 2407 MHz, 150 kHz - 30 MHz, Peak Detector

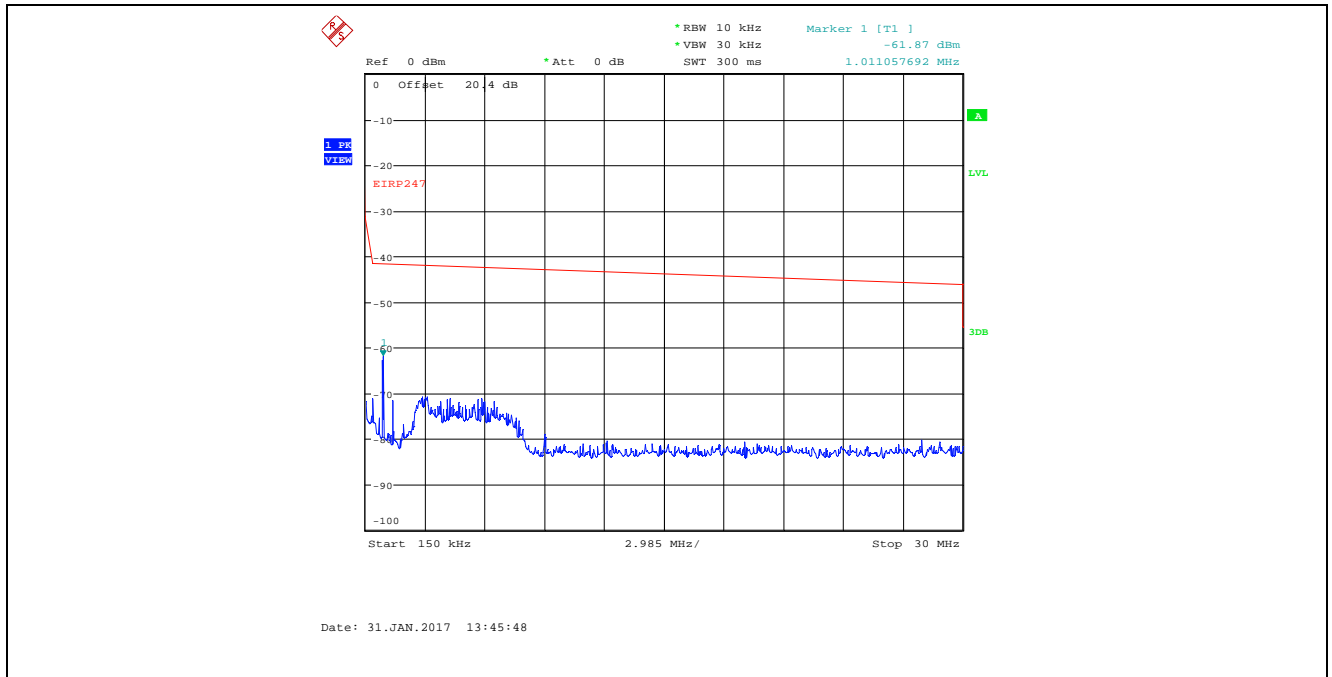

**Plot 5.4.4.18.** Conducted Spurious Emissions in Restricted Frequency Bands  
Bandwidth: 8 MHz, TX Gain Setting 25, Data Rate 4, 2407 MHz, 30 MHz - 1 GHz, Peak Detector

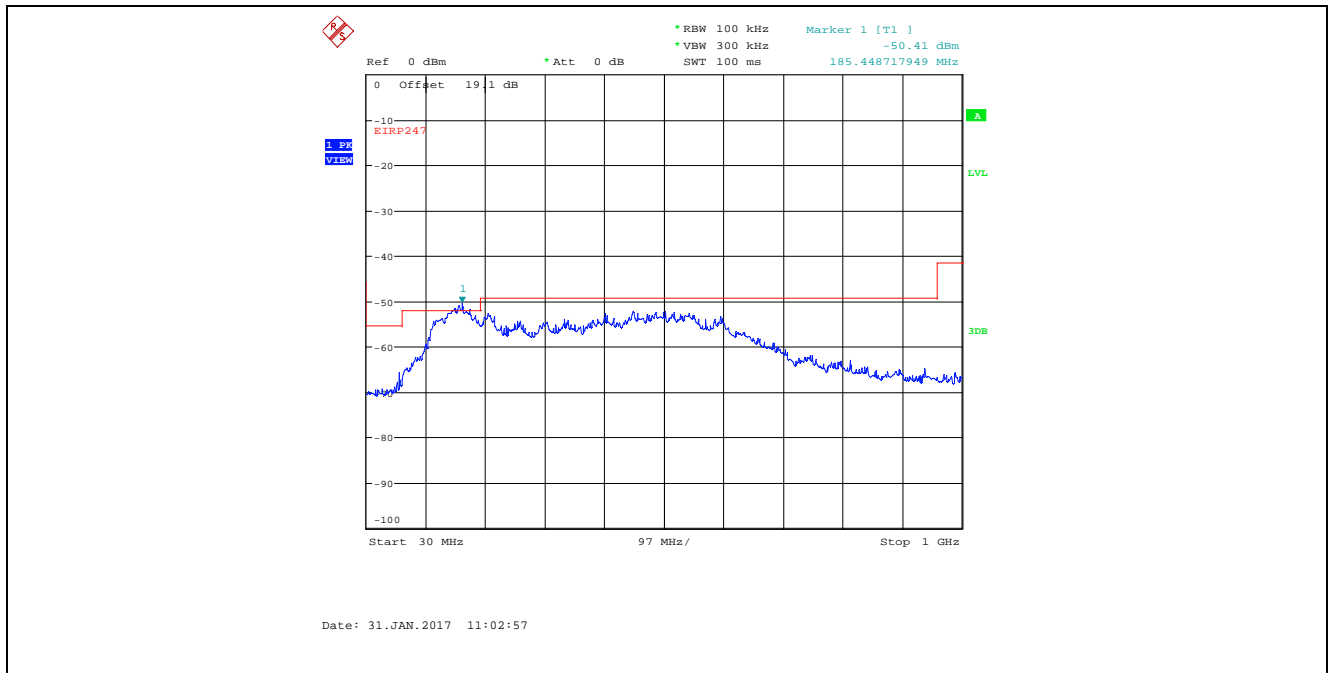

**Plot 5.4.4.19.** Conducted Spurious Emissions in Restricted Frequency Bands  
 Bandwidth: 8 MHz, TX Gain Setting 25, Data Rate 4, 2407 MHz, RB 167.72-173.2 MHz, QP Detector

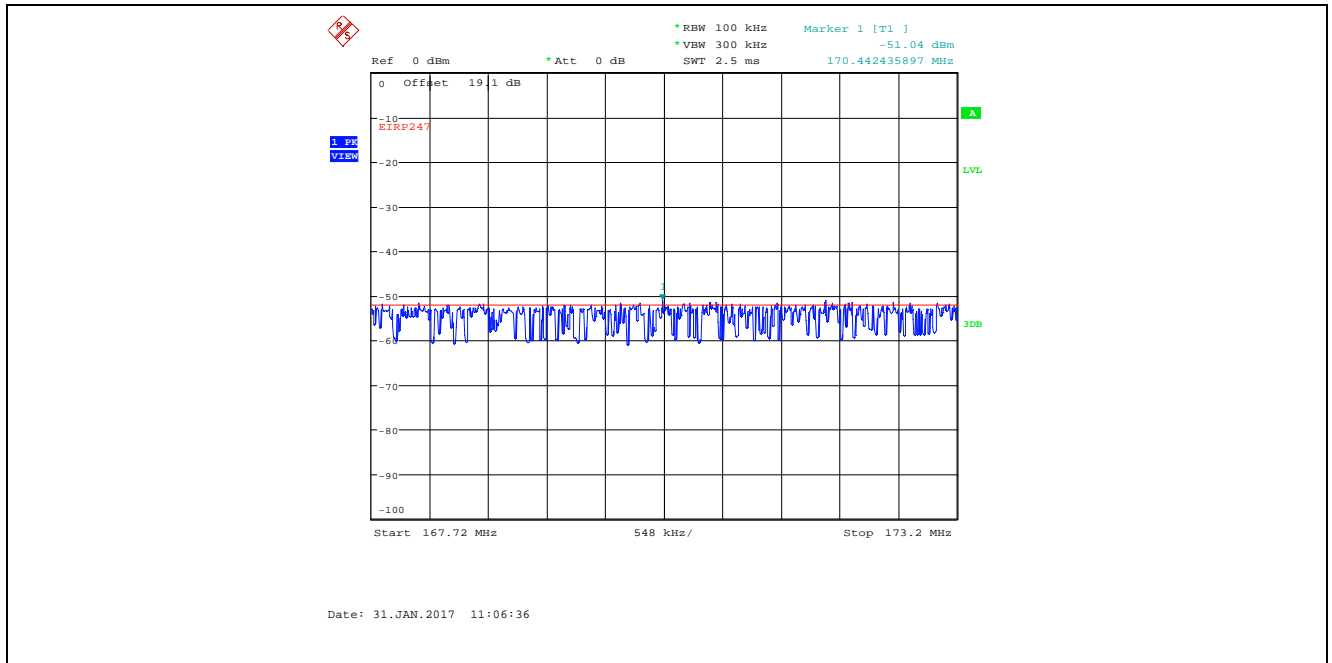

**Plot 5.4.4.20.** Conducted Spurious Emissions in Restricted Frequency Bands  
 Bandwidth: 8 MHz, TX Gain Setting 25, Data Rate 4, 2407 MHz, RB 167.72-173.2 MHz, QP Detector  
 QP at 170.44 MHz (RB 167.72-173.2 MHz) is -61.62dBm (limit is -51.76dBm)

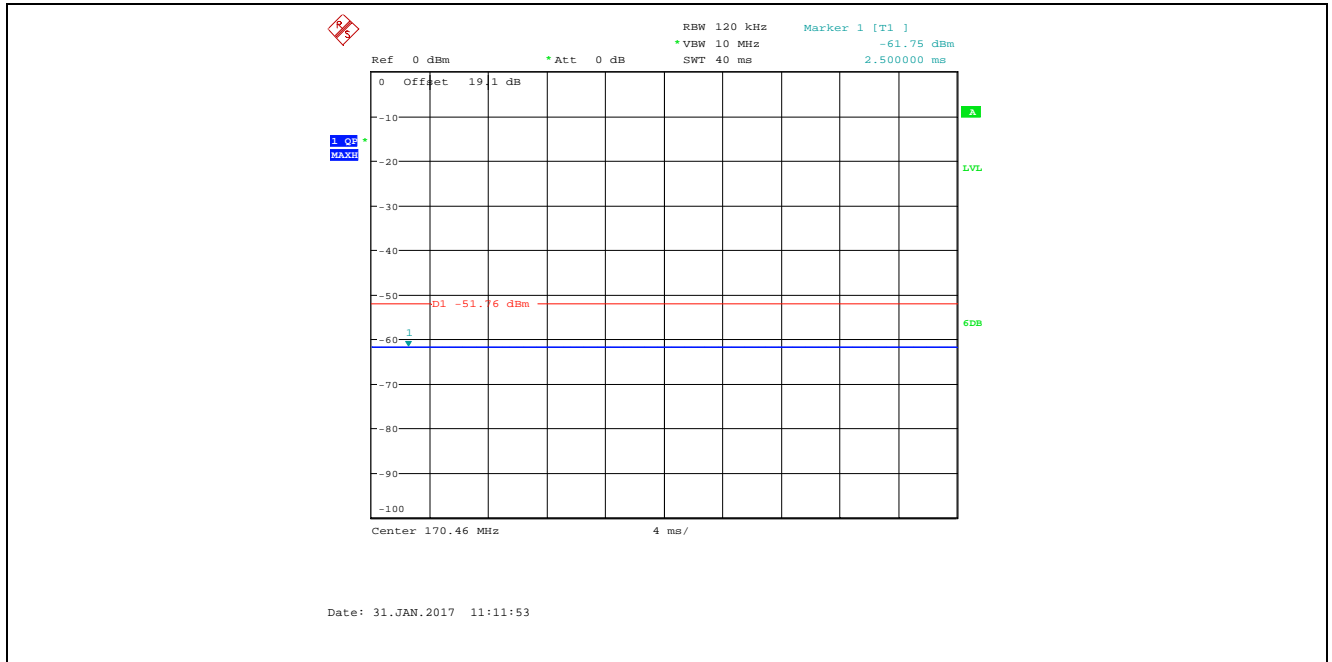

**Plot 5.4.4.21.** Conducted Spurious Emissions in Restricted Frequency Bands  
 Bandwidth: 8 MHz, TX Gain Setting 25, Data Rate 4, 2407 MHz, 1 GHz - 4 GHz, Peak Detector

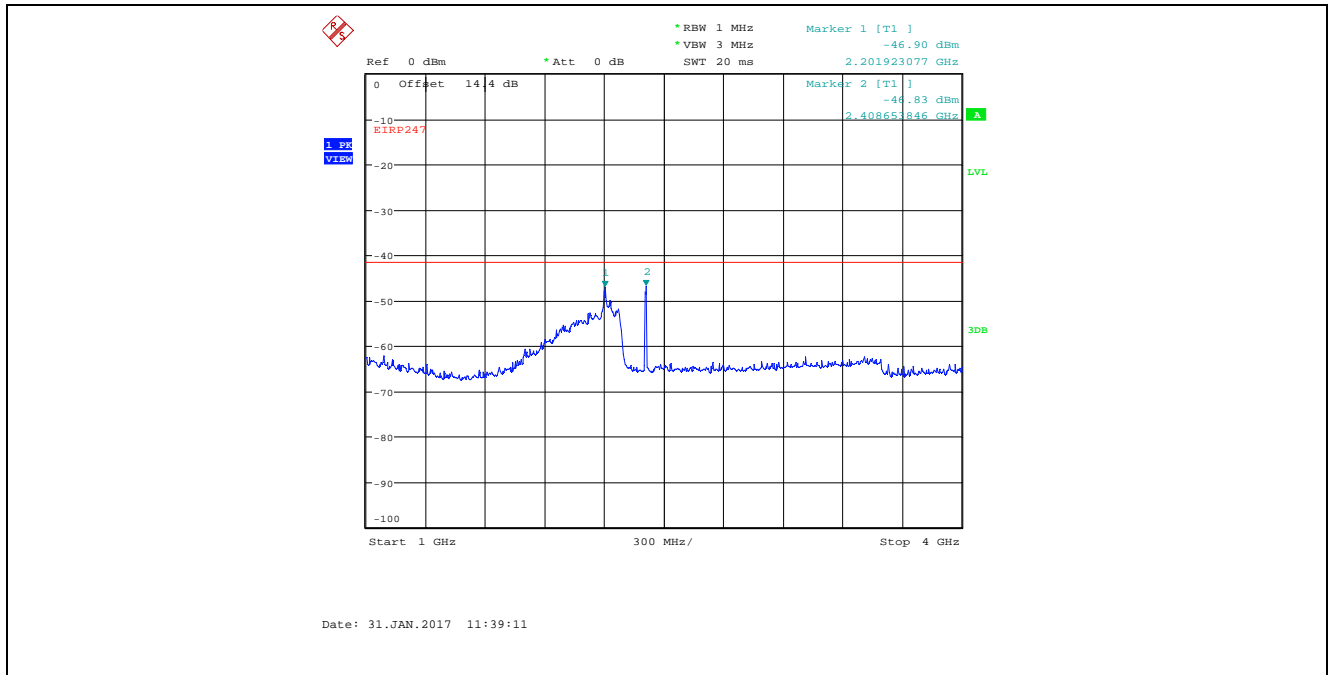

**Plot 5.4.4.22.** Conducted Spurious Emissions in Restricted Frequency Bands  
 Bandwidth: 8 MHz, TX Gain Setting 25, Data Rate 4, 2407 MHz, 4 GHz - 25 GHz, Peak Detector

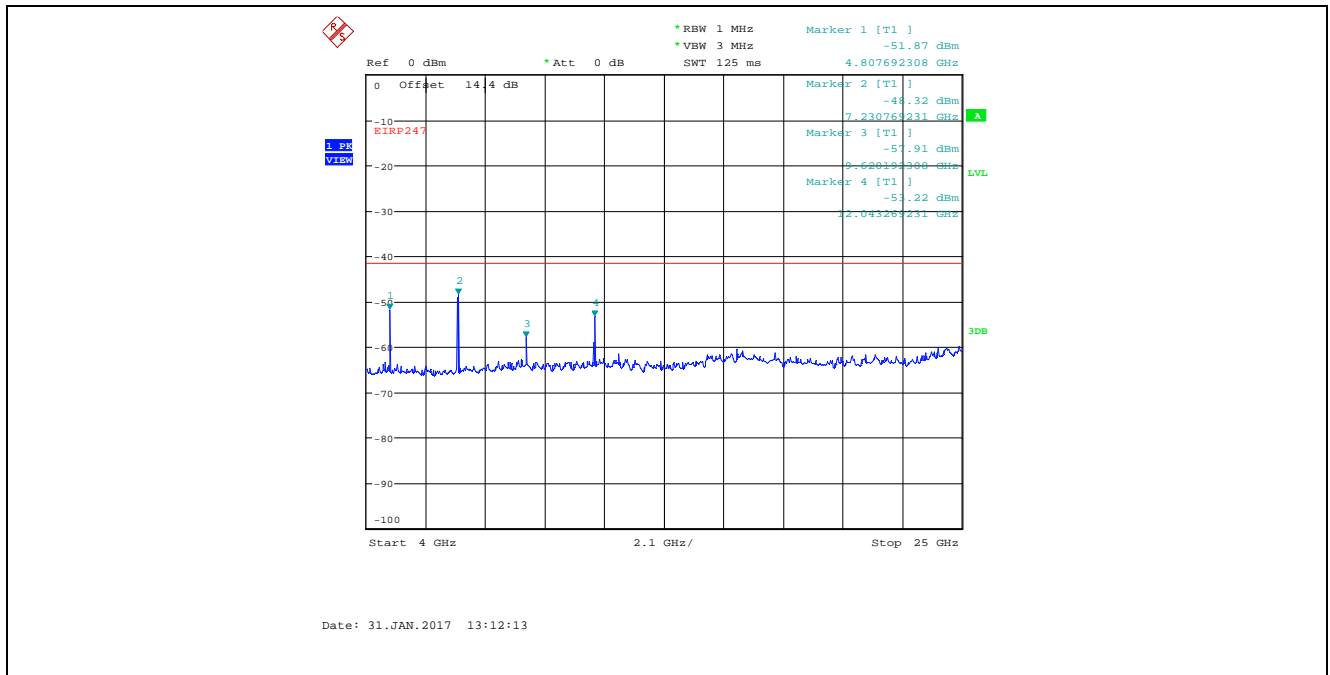

**Plot 5.4.4.23.** Conducted Spurious Emissions in Restricted Frequency Bands  
Bandwidth: 8 MHz, TX Gain Setting 25, Data Rate 4, 2442 MHz, 9 kHz - 150 kHz, Peak Detector

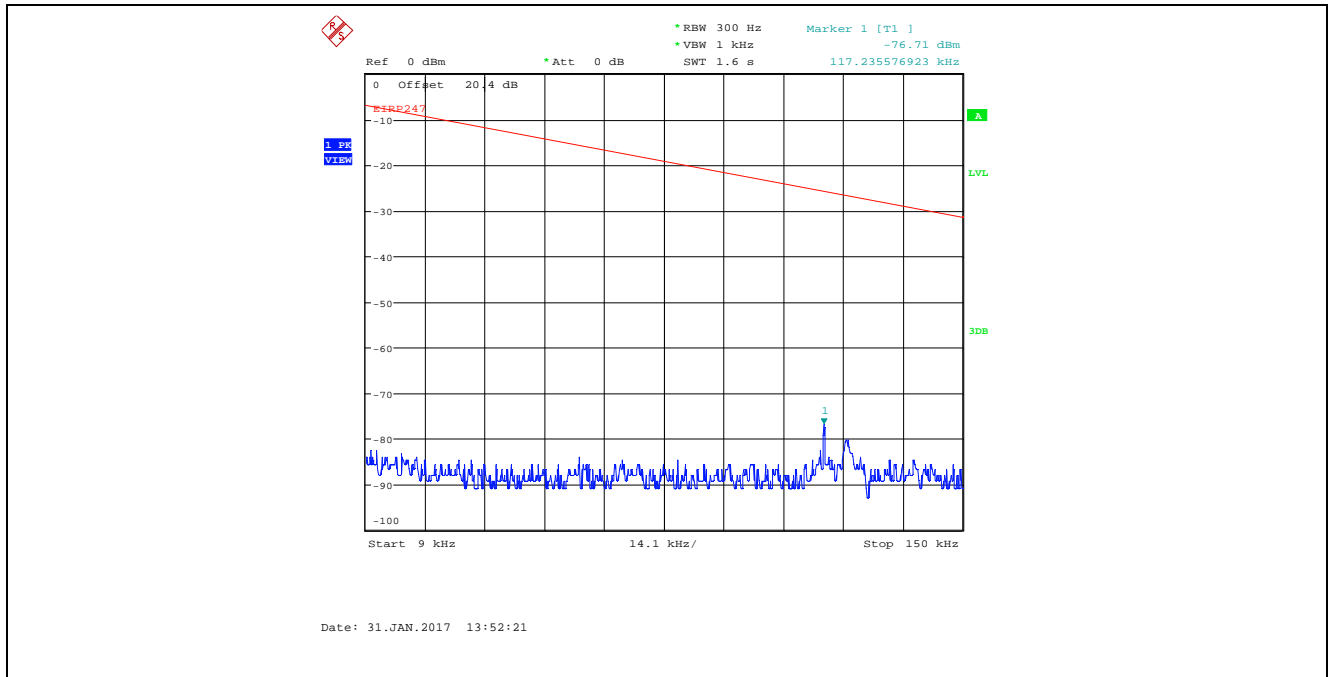

**Plot 5.4.4.24.** Conducted Spurious Emissions in Restricted Frequency Bands  
Bandwidth: 8 MHz, TX Gain Setting 25, Data Rate 4, 2442 MHz, 150 kHz - 30 MHz, Peak Detector

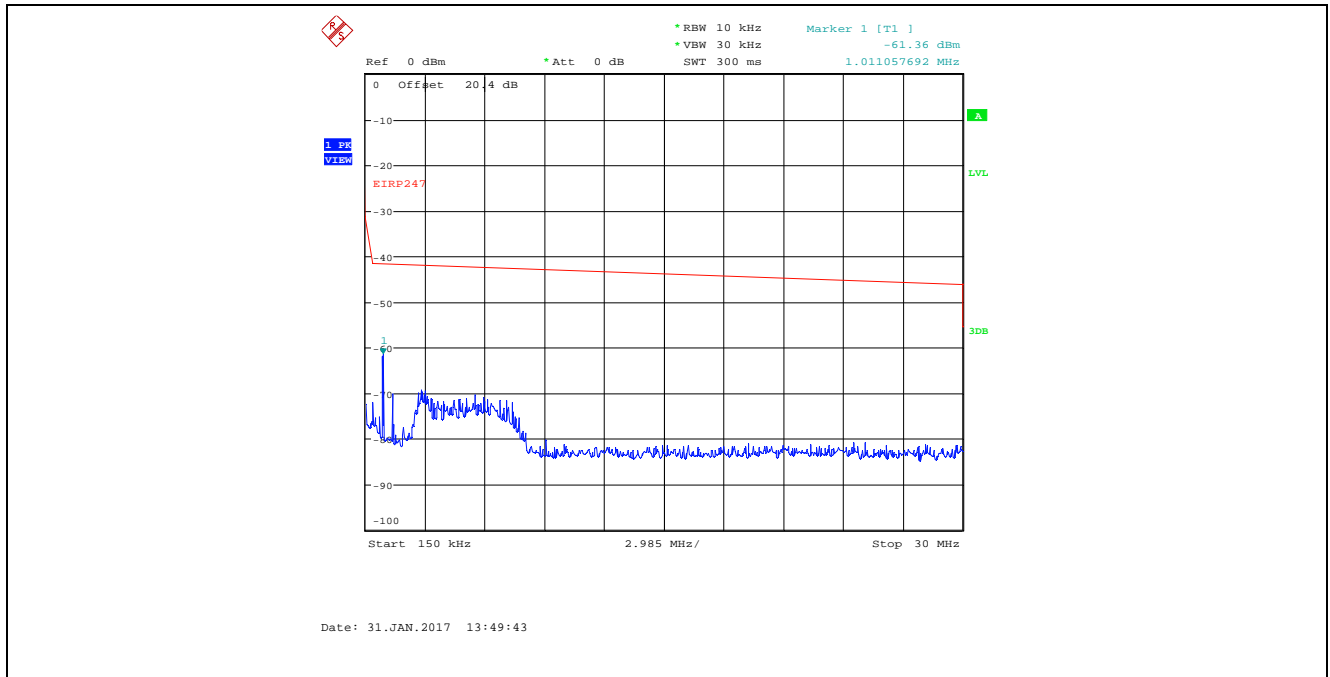

**Plot 5.4.4.25.** Conducted Spurious Emissions in Restricted Frequency Bands  
Bandwidth: 8 MHz, TX Gain Setting 25, Data Rate 4, 2442 MHz, 30 MHz - 1 GHz, Peak Detector

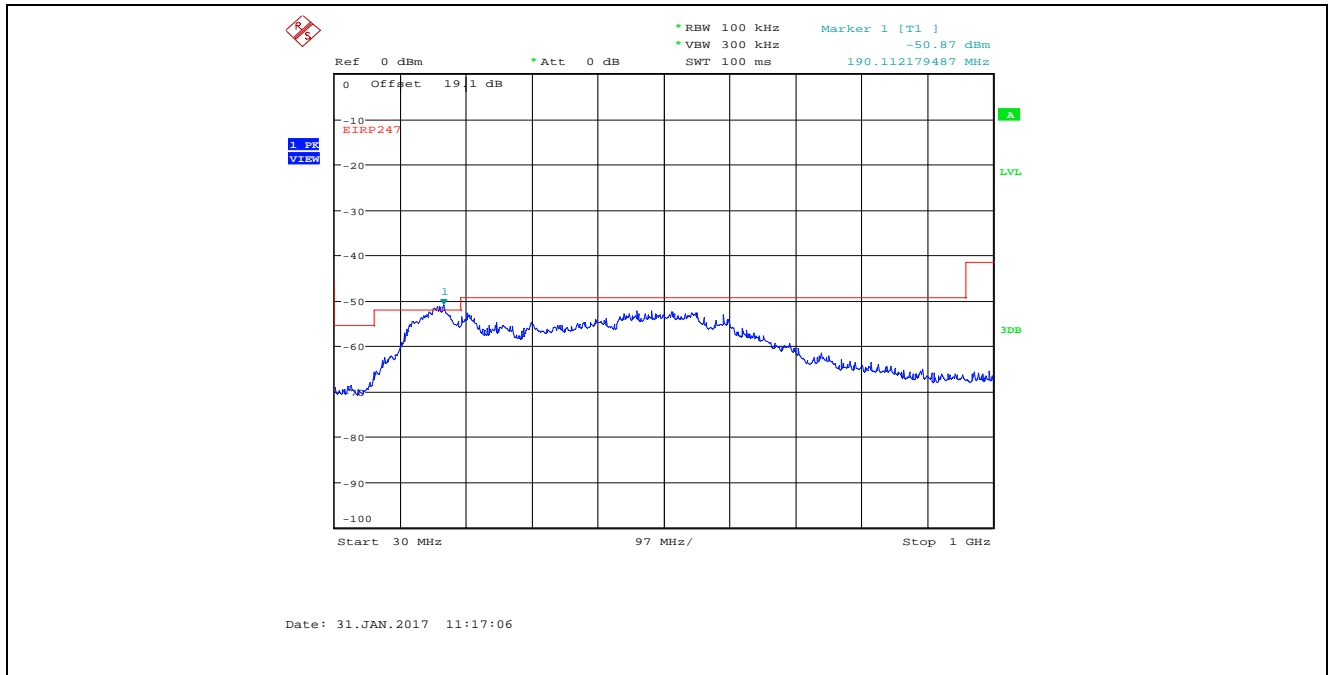

**Plot 5.4.4.26.** Conducted Spurious Emissions in Restricted Frequency Bands  
Bandwidth: 8 MHz, TX Gain Setting 25, Data Rate 4, 2442 MHz, RB 167.72-173.2 MHz, QP Detector

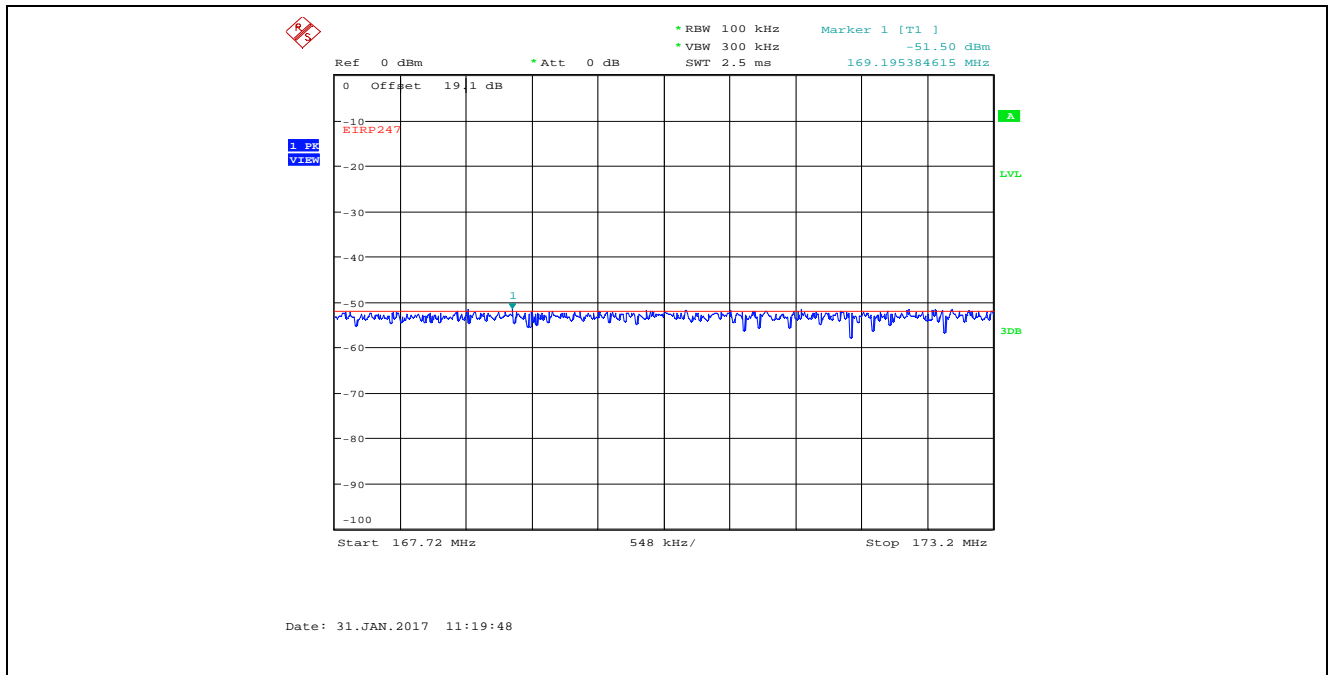

**Plot 5.4.4.27.** Conducted Spurious Emissions in Restricted Frequency Bands  
 Bandwidth: 8 MHz, TX Gain Setting 25, Data Rate 4, 2442 MHz, RB 167.72-173.2 MHz, QP Detector  
 QP at 169.19 MHz (RB 167.72-173.2 MHz) is -61.89dBm (limit -51.76dBm)

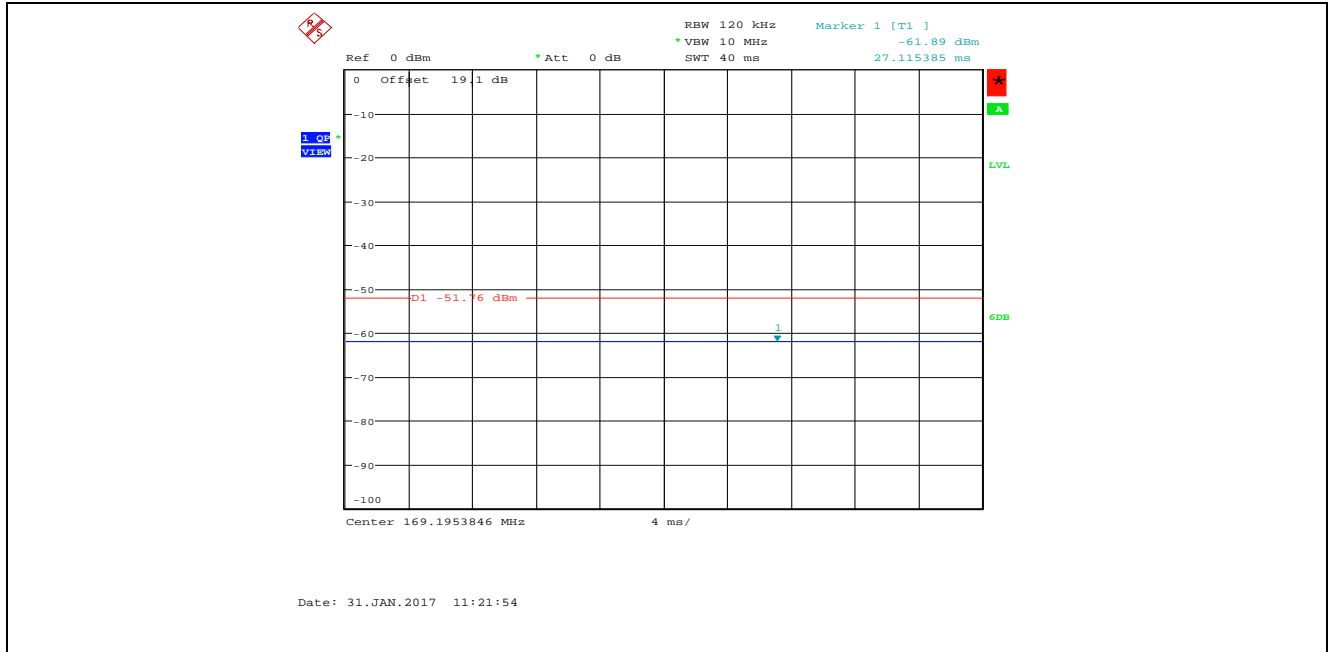

**Plot 5.4.4.28.** Conducted Spurious Emissions in Restricted Frequency Bands  
 Bandwidth: 8 MHz, TX Gain Setting 25, Data Rate 4, 2442 MHz, 1 GHz - 4 GHz, Peak Detector  
 Marker 2 is the Fundamental

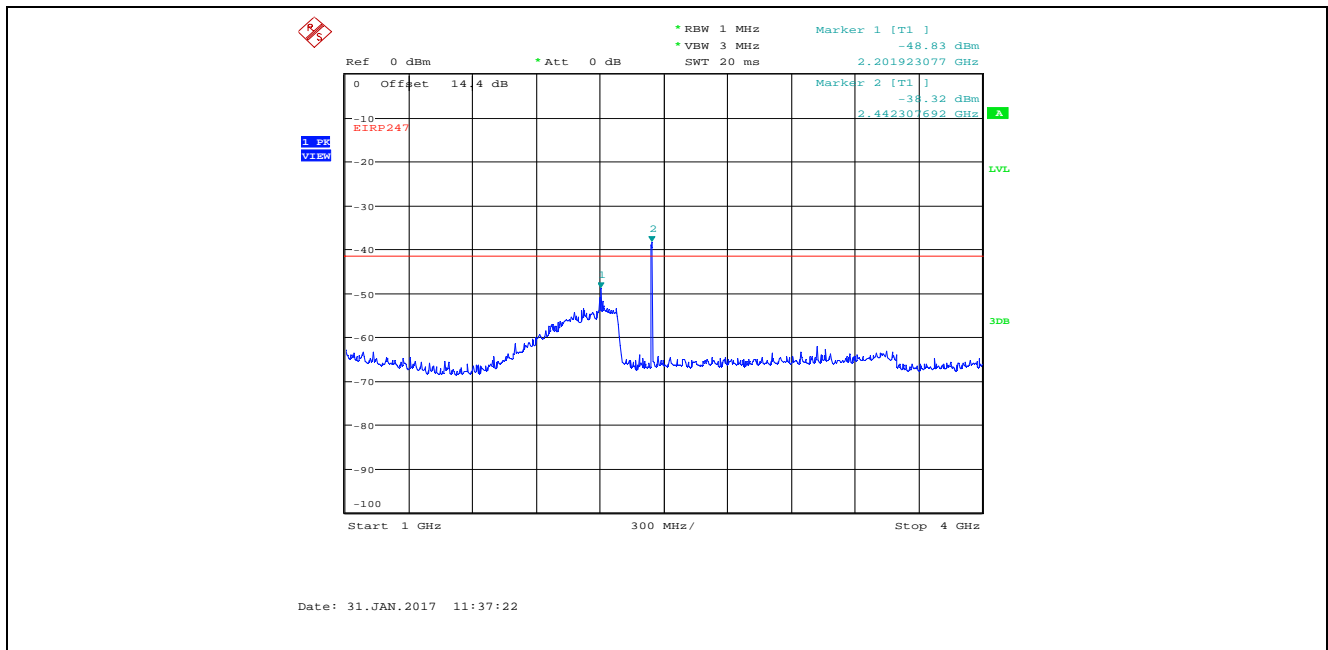

**Plot 5.4.4.29.** Conducted Spurious Emissions in Restricted Frequency Bands  
 Bandwidth: 8 MHz, TX Gain Setting 25, Data Rate 4, 2442 MHz, 4 GHz - 25 GHz, Peak Detector

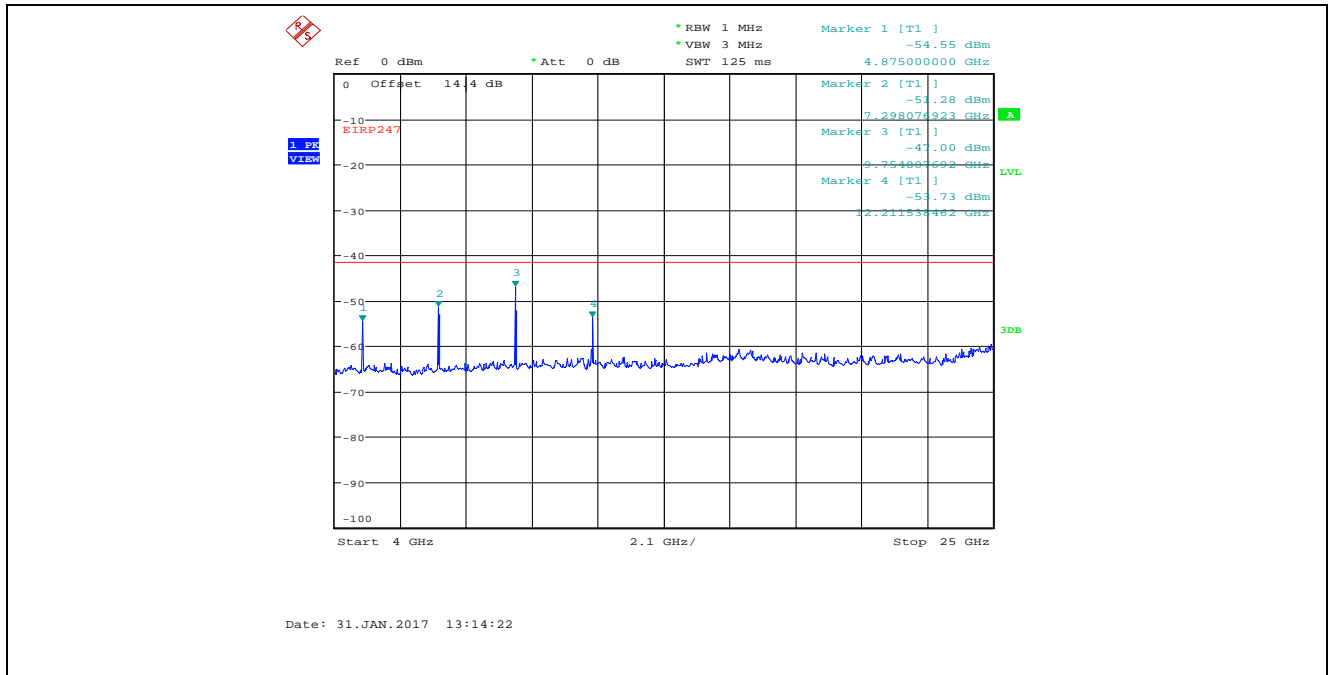

**Plot 5.4.4.30.** Conducted Spurious Emissions in Restricted Frequency Bands  
 Bandwidth: 8 MHz, TX Gain Setting 25, Data Rate 4, 2477 MHz, 9 kHz - 150 kHz, Peak Detector

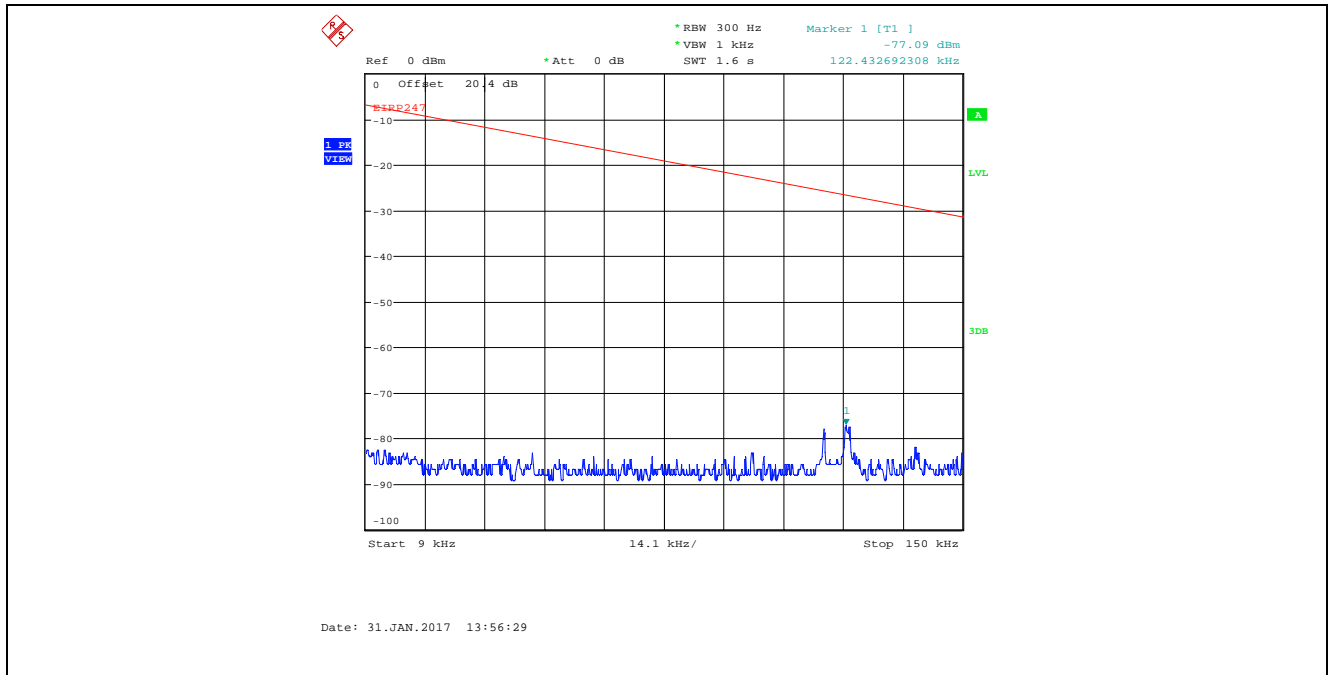



**Plot 5.4.4.31.** Conducted Spurious Emissions in Restricted Frequency Bands  
Bandwidth: 8 MHz, TX Gain Setting 25, Data Rate 4, 2477 MHz, 150 kHz - 30 MHz, Peak Detector

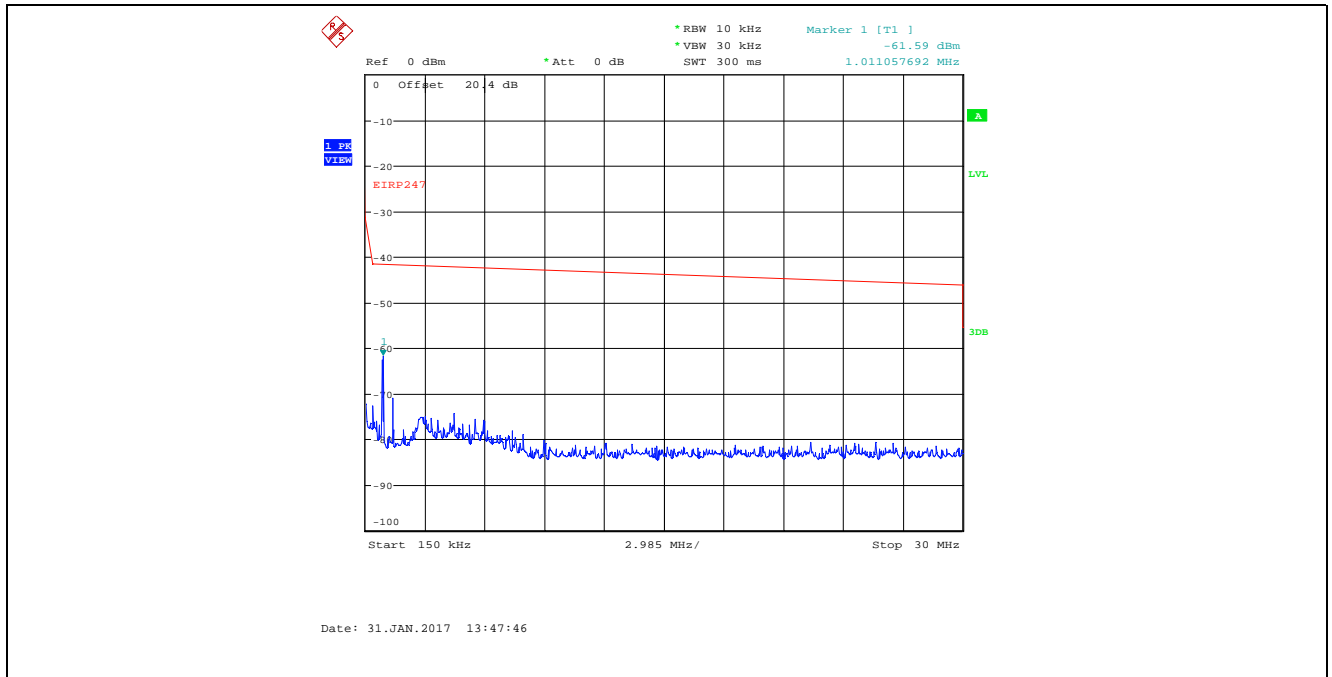

**Plot 5.4.4.32.** Conducted Spurious Emissions in Restricted Frequency Bands  
Bandwidth: 8 MHz, TX Gain Setting 25, Data Rate 4, 2477 MHz, 30 MHz - 1 GHz, Peak Detector

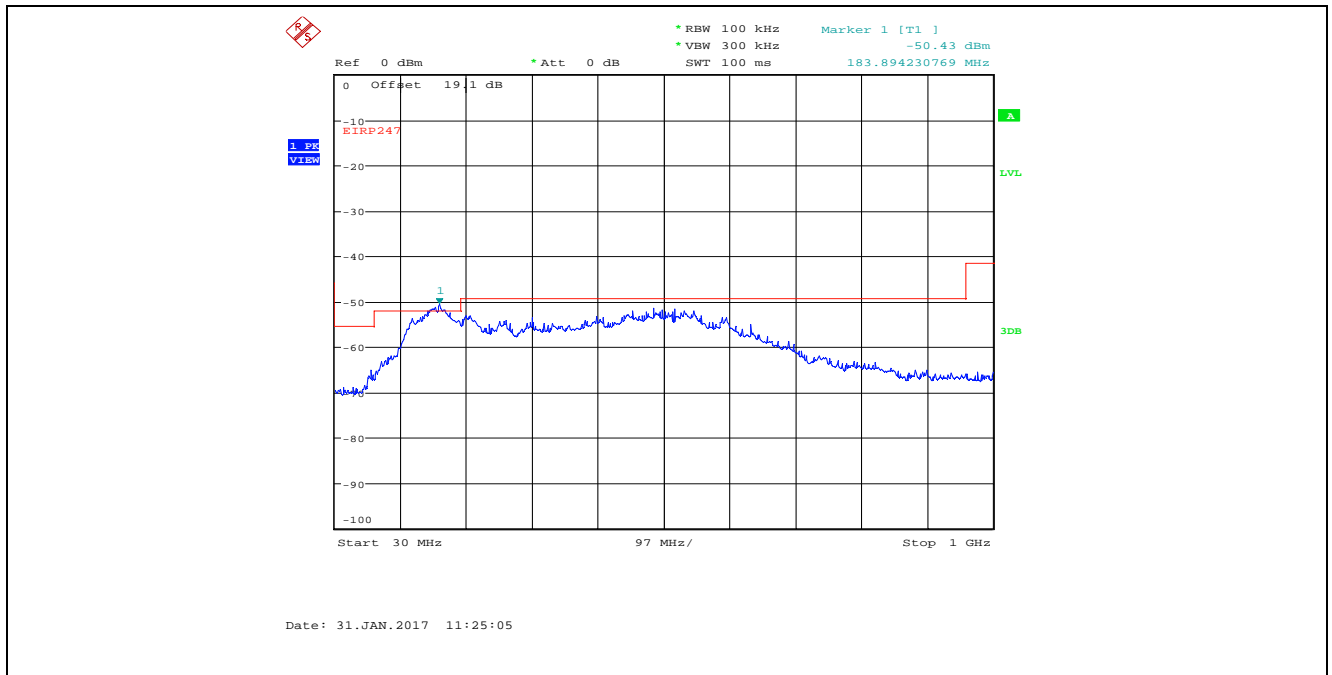

**Plot 5.4.4.33.** Conducted Spurious Emissions in Restricted Frequency Bands  
 Bandwidth: 8 MHz, TX Gain Setting 25, Data Rate 4, 2477 MHz, RB 167.72-173.2 MHz, QP Detector  
 QP at 172.68 MHz is -61.67dBm (limit -51.76 dBm)

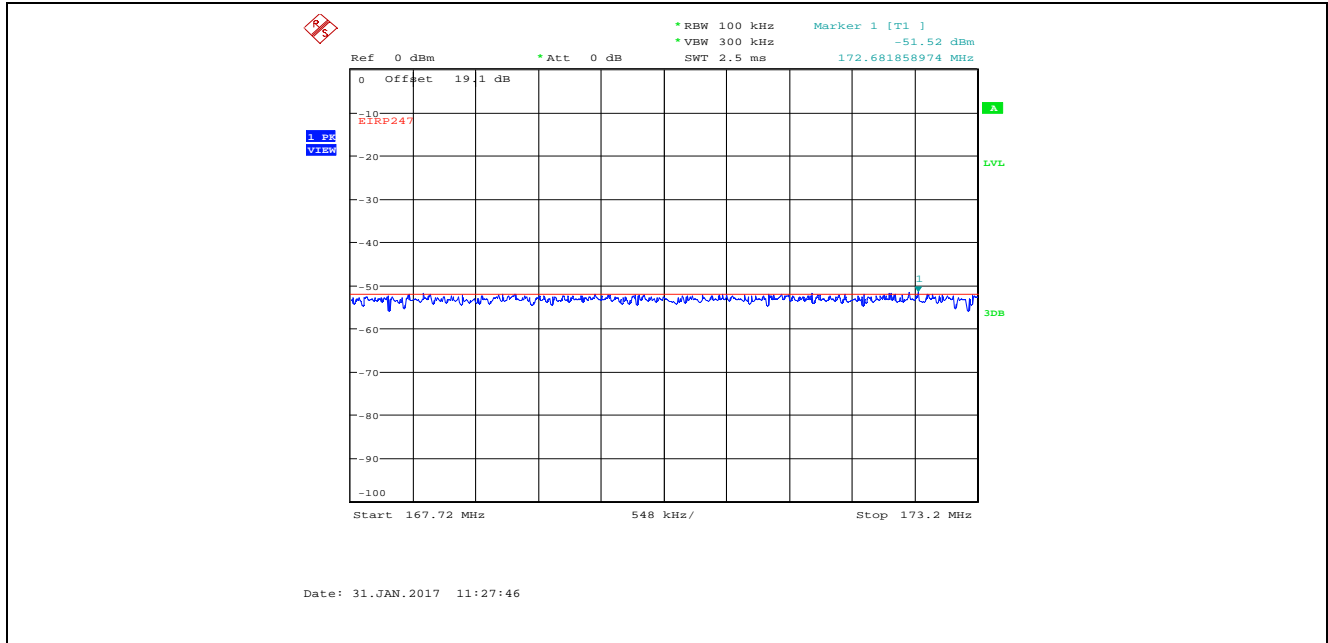

**Plot 5.4.4.34.** Conducted Spurious Emissions in Restricted Frequency Bands  
 Bandwidth: 8 MHz, TX Gain Setting 25, Data Rate 4, 2477 MHz, 1 GHz - 4 GHz, Peak Detector  
 Marker 2 is the Fundamental

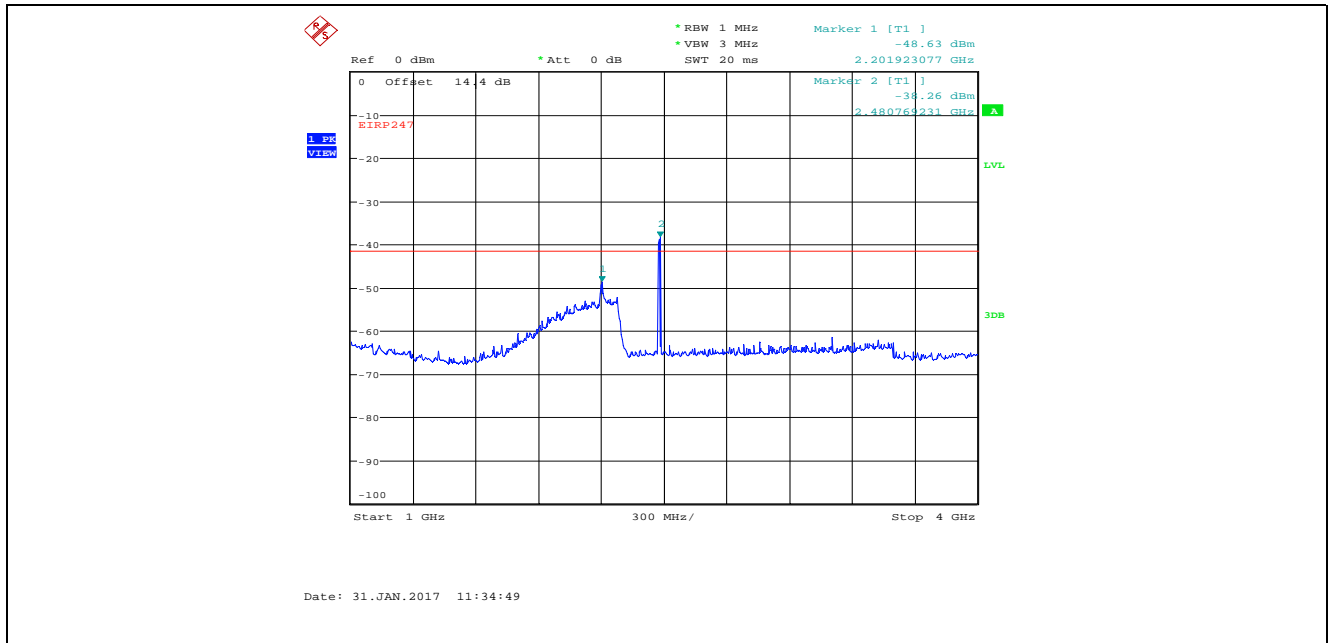

**Plot 5.4.4.35.** Conducted Spurious Emissions in Restricted Frequency Bands  
Bandwidth: 8 MHz, TX Gain Setting 25, Data Rate 4, 2477 MHz, 4 GHz - 25 GHz, Peak Detector

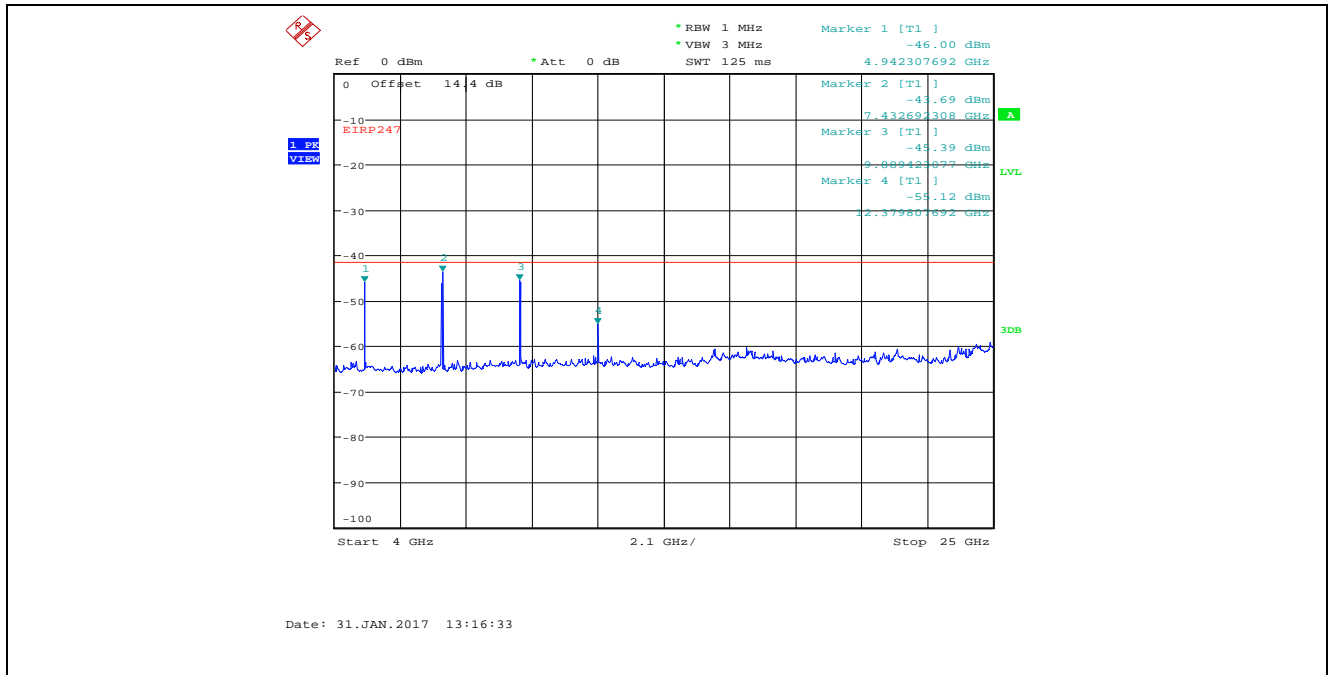

**5.5. TRANSMITTER SPURIOUS RADIATED EMISSIONS AT 3 METERS [§§ 15.247(d), 15.209 & 15.205]**

**5.5.1. Limit(s)**

§ 15.247 (d): In any 100 kHz bandwidth outside the frequency band in which the spread spectrum or digitally modulated intentional radiator is operating, the radio frequency power that is produced by the intentional radiator shall be at least 20 dB below that in the 100 kHz bandwidth within the band that contains the highest level of the desired power, based on either an RF conducted or a radiated measurement, provided the transmitter demonstrates compliance with the peak conducted power limits. If the transmitter complies with the conducted power limits based on the use of RMS averaging over a time interval, as permitted under paragraph (b)(3) of this section, the attenuation required under this paragraph shall be 30 dB instead of 20 dB. Attenuation below the general limits specified in Section 15.209(a) is not required. In addition, radiated emissions which fall in the restricted bands, as defined in Section 15.205(a), must also comply with the radiated emission limits specified in Section 15.209(a) (see Section 15.205(c)).

**Section 15.205(a) - Restricted Bands of Operation**

MHz	MHz	MHz	GHz
0.090–0.110 .....	16.42–16.423	399.9–410	4.5–5.15
<sup>1</sup> 0.495–0.505 .....	16.69475–16.69525	608–614	5.35–5.46
2.1735–2.1905 .....	16.80425–16.80475	960–1240	7.25–7.75
4.125–4.128 .....	25.5–25.67	1300–1427	8.025–8.5
4.17725–4.17775 .....	37.5–38.25	1435–1626.5	9.0–9.2
4.20725–4.20775 .....	73–74.6	1645.5–1646.5	9.3–9.5
6.215–6.218 .....	74.8–75.2	1660–1710	10.6–12.7
6.26775–6.26825 .....	108–121.94	1718.8–1722.2	13.25–13.4
6.31175–6.31225 .....	123–138	2200–2300	14.47–14.5
8.291–8.294 .....	149.9–150.05	2310–2390	15.35–16.2
8.362–8.366 .....	156.52475–156.52525	2483.5–2500	17.7–21.4
8.37625–8.38675 .....	156.7–156.9	2655–2900	22.01–23.12
8.41425–8.41475 .....	162.0125–167.17	3260–3267	23.6–24.0
12.29–12.293 .....	167.72–173.2	3332–3339	31.2–31.8
12.51975–12.52025 .....	240–285	3345.8–3358	36.43–36.5
12.57675–12.57725 .....	322–335.4	3600–4400	( <sup>2</sup> )
13.36–13.41.			

<sup>1</sup> Until February 1, 1999, this restricted band shall be 0.490–0.510 MHz.  
<sup>2</sup> Above 38.6

**Section 15.209(a) - Field Strength Limits within Restricted Frequency Bands**

Frequency (MHz)	Field Strength (microvolts/meter)	Measurement Distance (meters)
0.009 - 0.490	2,400 / F (kHz)	300
0.490 - 1.705	24,000 / F (kHz)	30
1.705 - 30.0	30	30
30 – 88	100	3
88 – 216	150	3
216 – 960	200	3
Above 960	500	3

### 5.5.2. Method of Measurements

KDB 558074 D01 DTS Meas Guidance v03r05, Section Section 12.2.7 and ANSI C63.10.

### 5.5.3. Test Arrangement

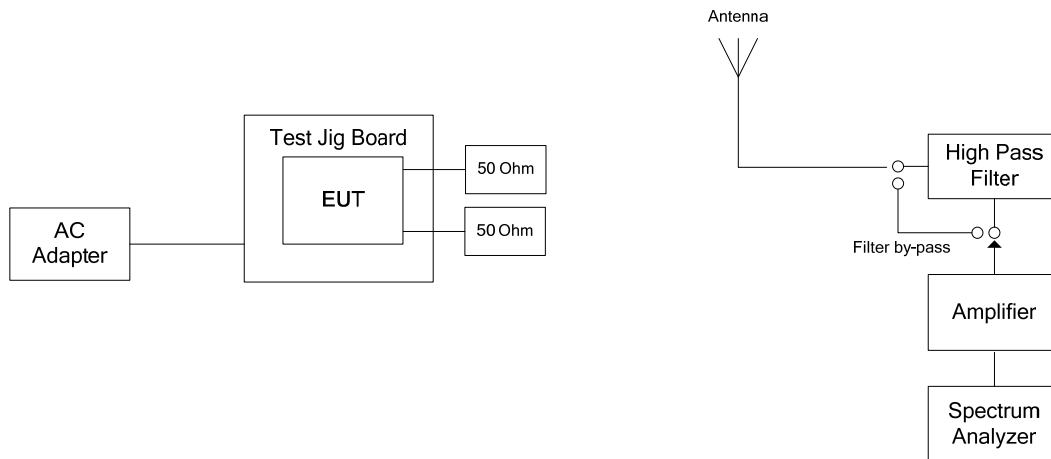

**5.5.4. Test Data**

**Remark(s):**

- All spurious emissions that are in excess of 20 dB below the specified limit shall be recorded.
- EUT shall be tested in three orthogonal positions.
- § 15.247 (d) spurious emission limit:  
 $E = (EIRP - 20\log(d) + 104.8) - 20 = (36 \text{ dBm} - 20\log(3) + 104.8) - 20 = 111.3 \text{ dB}\mu\text{V/m}$
- Exploratory tests performed to determined worst-case test configurations, the following test results at high power setting represent the worst-case.

**5.5.4.1. Bandwidth: 8 MHz, Data Rate 1, High Power, TX Gain Setting 50**

Fundamental Frequency:		2407 MHz					
Frequency Test Range:		30 MHz – 25 GHz					
Frequency (MHz)	RF Peak Level (dBμV/m)	RF Avg Level (dBμV/m)	Antenna Plane (H/V)	Limit 15.209 (dBμV/m)	Limit 15.247 (dBμV/m)	Margin (dB)	Pass/Fail
399.97	29.97	--	V	46.0	111.3	-16.0	Pass*
399.97	35.66	--	H	46.0	111.3	-10.3	Pass*
4814	48.66	35.74	H	54.0	111.3	-18.3	Pass*
12035	60.43	49.54	V	54.0	111.3	-4.5	Pass*
12035	58.59	46.16	H	54.0	111.3	-7.8	Pass*
All other spurious emissions and harmonics are more than 20 dB below the applicable limit.							

\*Field strength of emissions appearing within restricted frequency bands shall not exceed the limits in § 15.209.

Fundamental Frequency:		2442 MHz					
Frequency Test Range:		30 MHz – 25 GHz					
Frequency (MHz)	RF Peak Level (dBμV/m)	RF Avg Level (dBμV/m)	Antenna Plane (H/V)	Limit 15.209 (dBμV/m)	Limit 15.247 (dBμV/m)	Margin (dB)	Pass/Fail
399.97	29.97	--	V	46.0	111.3	-16.0	Pass*
399.97	35.66	--	H	46.0	111.3	-10.3	Pass*
4884	50.19	39.17	V	54.0	111.3	-14.8	Pass*
4884	51.79	42.74	H	54.0	111.3	-11.3	Pass*
7326	55.86	44.68	V	54.0	111.3	-9.3	Pass*
7326	53.70	41.87	H	54.0	111.3	-12.1	Pass*
12210	58.03	45.19	V	54.0	111.3	-8.8	Pass*
12210	57.22	44.54	H	54.0	111.3	-9.5	Pass*
All other spurious emissions and harmonics are more than 20 dB below the applicable limit.							

\*Field strength of emissions appearing within restricted frequency bands shall not exceed the limits in § 15.209.

Fundamental Frequency:		2477 MHz					
Frequency Test Range:		30 MHz – 25 GHz					
Frequency (MHz)	RF Peak Level (dBµV/m)	RF Avg Level (dBµV/m)	Antenna Plane (H/V)	Limit 15.209 (dBµV/m)	Limit 15.247 (dBµV/m)	Margin (dB)	Pass/Fail
399.97	29.97	--	V	46.0	111.3	-16.0	Pass*
399.97	35.66	--	H	46.0	111.3	-10.3	Pass*
4954	49.42	38.09	V	54.0	111.3	-15.9	Pass*
4954	49.18	37.61	H	54.0	111.3	-16.4	Pass*
7431	55.25	43.10	V	54.0	111.3	-10.9	Pass*
7431	54.62	42.91	H	54.0	111.3	-11.1	Pass*
12385	57.34	43.42	V	54.0	111.3	-10.6	Pass*
12385	57.14	44.25	H	54.0	111.3	-9.8	Pass*
All other spurious emissions and harmonics are more than 20 dB below the applicable limit.							

\*Field strength of emissions appearing within restricted frequency bands shall not exceed the limits in § 15.209.

**5.5.4.2. Bandwidth: 8 MHz, Data Rate 4, High Power, TX Gain Setting 55**

Fundamental Frequency:		2412 MHz					
Frequency Test Range:		30 MHz – 25 GHz					
Frequency (MHz)	RF Peak Level (dBµV/m)	RF Avg Level (dBµV/m)	Antenna Plane (H/V)	Limit 15.209 (dBµV/m)	Limit 15.247 (dBµV/m)	Margin (dB)	Pass/Fail
4814	47.08	34.75	V	54.0	111.3	-19.3	Pass*
4814	47.19	34.45	H	54.0	111.3	-19.6	Pass*
*All spurious emissions and harmonics are more than 20 dB below the applicable limit.							

\*Field strength of emissions appearing within restricted frequency bands shall not exceed the limits in § 15.209.

Fundamental Frequency:		2442 MHz					
Frequency Test Range:		30 MHz – 25 GHz					
Frequency (MHz)	RF Peak Level (dBµV/m)	RF Avg Level (dBµV/m)	Antenna Plane (H/V)	Limit 15.209 (dBµV/m)	Limit 15.247 (dBµV/m)	Margin (dB)	Pass/Fail
4884	48.77	35.99	V	54.0	111.3	-18.0	Pass*
4884	48.11	35.11	H	54.0	111.3	-18.9	Pass*
7326	52.97	39.85	V	54.0	111.3	-14.2	Pass*
7326	51.15	38.35	H	54.0	111.3	-15.7	Pass*
*All spurious emissions and harmonics are more than 20 dB below the applicable limit.							

\*Field strength of emissions appearing within restricted frequency bands shall not exceed the limits in § 15.209.

Fundamental Frequency:		2477 MHz					
Frequency Test Range:		30 MHz – 25 GHz					
Frequency (MHz)	RF Peak Level (dBµV/m)	RF Avg Level (dBµV/m)	Antenna Plane (H/V)	Limit 15.209 (dBµV/m)	Limit 15.247 (dBµV/m)	Margin (dB)	Pass/Fail
4954	51.11	36.65	V	54.0	111.3	-17.4	Pass*
4954	48.08	34.87	H	54.0	111.3	-19.1	Pass*
7431	53.18	40.20	V	54.0	111.3	-13.8	Pass*
7431	52.34	39.73	H	54.0	111.3	-14.3	Pass*
*All spurious emissions and harmonics are more than 20 dB below the applicable limit.							

\*Field strength of emissions appearing within restricted frequency bands shall not exceed the limits in § 15.209.



**5.6. POWER SPECTRAL DENSITY [§ 15.247(e)]**

**5.6.1. Limit(s)**

For digitally modulated systems, the power spectral density conducted from the intentional radiator to the antenna shall not be greater than 8 dBm in any 3 kHz band during any time interval of continuous transmission.

**5.6.2. Method of Measurements**

KDB 558074D01 DTS Meas Guidance v03r05, Section 10.2 Method PKPSD (peak PSD)

**5.6.3. Test Arrangement**

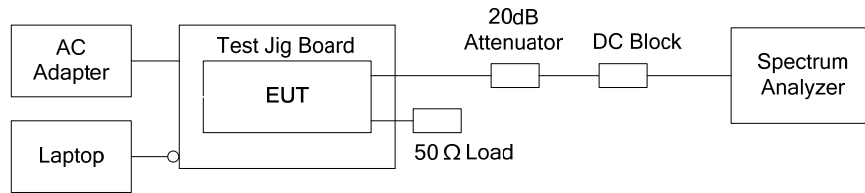

**5.6.4. Test Data**

Operating Mode	Data Rate	Frequency (MHz)	PSD (dBm)	Max. Limit (dBm)
Bandwidth: 1 MHz TX Gain: 26	1	2402	7.74	8
		2442	7.98	8
		2482	7.64	8
	2	2402	7.51	8
		2442	7.74	8
		2482	7.60	8
Bandwidth: 2 MHz TX Gain: 32	1	2402	6.40	8
		2442	7.90	8
		2482	7.69	8
	2	2402	6.99	8
		2442	7.72	8
		2482	7.03	8
	3	2402	6.57	8
		2442	7.59	8
		2482	7.89	8

Operating Mode	Data Rate	Frequency (MHz)	PSD (dBm)	Max. Limit (dBm)
Bandwidth: 4 MHz TX Gain: 43	1	2403	7.74	8
		2442	7.79	8
		2480	7.68	8
	2	2403	7.88	8
		2442	7.91	8
		2480	7.62	8
	3	2403	7.68	8
		2442	7.76	8
		2480	7.80	8
Bandwidth: 8 MHz TX Gain: 50	1	2407	7.38	8
		2442	7.90	8
		2477	7.27	8
	2	2407	7.26	8
		2442	7.56	8
		2477	7.89	8
	3	2407	6.96	8
		2442	7.89	8
		2477	7.99	8
Bandwidth: 1 MHz TX Gain: 43	4	2402	7.74	8
		2442	7.89	8
		2482	7.79	8
	5	2402	6.42	8
		2442	7.64	8
		2482	7.92	8
	6	2402	6.42	8
		2442	7.93	8
		2482	7.50	8
	7	2402	7.02	8
		2442	7.77	8
		2482	7.96	8

**ULTRATECH GROUP OF LABS**

3000 Bristol Circle, Oakville, Ontario, Canada L6H 6G4  
 Tel. #: 905-829-1570, Fax. #: 905-829-8050, Email: [yic@ultratech-labs.com](mailto:yic@ultratech-labs.com), Website: <http://www.ultratech-labs.com>

File #: 17MCRS101\_FCC15C247D2G4

April 13, 2017

*All test results contained in this engineering test report are traceable to National Institute of Standards and Technology (NIST)*

Operating Mode	Data Rate	Frequency (MHz)	PSD (dBm)	Max. Limit (dBm)
Bandwidth: 2 MHz TX Gain: 45	4	2402	5.63	8
		2442	6.27	8
		2482	6.92	8
	5	2402	4.70	8
		2442	5.35	8
		2482	7.23	8
	6	2402	5.36	8
		2442	6.50	8
		2482	7.42	8
	7	2402	6.05	8
		2442	7.04	8
		2482	7.23	8
Bandwidth: 4 MHz TX Gain: 50	4	2403	4.80	8
		2442	6.21	8
		2480	5.69	8
	5	2403	4.64	8
		2442	4.50	8
		2480	5.93	8
	6	2403	4.23	8
		2442	5.93	8
		2480	5.08	8
	7	2403	5.72	8
		2442	5.60	8
		2480	6.57	8

**ULTRATECH GROUP OF LABS**

3000 Bristol Circle, Oakville, Ontario, Canada L6H 6G4  
 Tel. #: 905-829-1570, Fax. #: 905-829-8050, Email: [vic@ultratech-labs.com](mailto:vic@ultratech-labs.com), Website: <http://www.ultratech-labs.com>

File #: 17MCRS101\_FCC15C247D2G4

April 13, 2017

*All test results contained in this engineering test report are traceable to National Institute of Standards and Technology (NIST)*

Operating Mode	Data Rate	Frequency (MHz)	PSD (dBm)	Max. Limit (dBm)
Bandwidth: 8 MHz TX Gain: 55	4	2407	4.09	8
		2442	3.48	8
		2477	4.13	8
	5	2407	4.04	8
		2442	4.02	8
		2477	5.68	8
	6	2407	4.34	8
		2442	3.84	8
		2477	4.57	8
	7	2407	4.01	8
		2442	4.20	8
		2477	6.35	8

Plot 5.6.4.1. Power Spectral Density, Bandwidth: 1 MHz, TX Gain Setting: 26, Data Rate 1, 2402 MHz

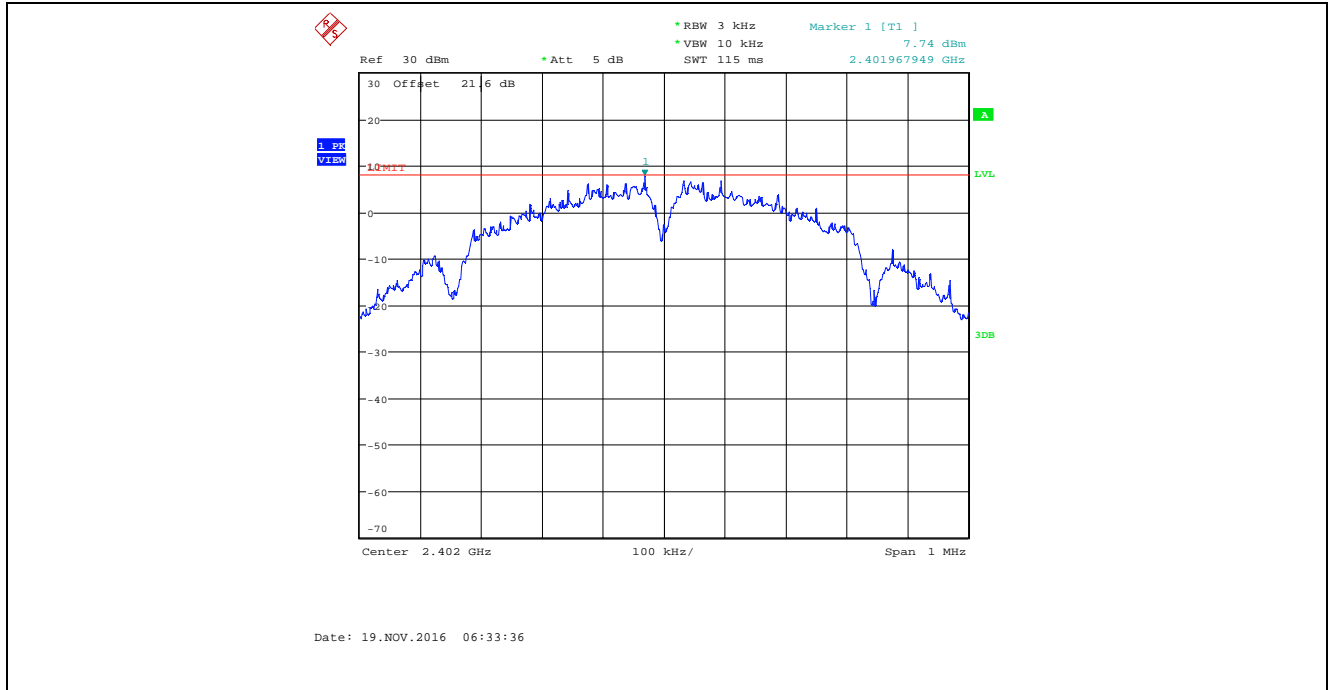

Plot 5.6.4.2. Power Spectral Density, Bandwidth: 1 MHz, TX Gain Setting: 26, Data Rate 1, 2442 MHz

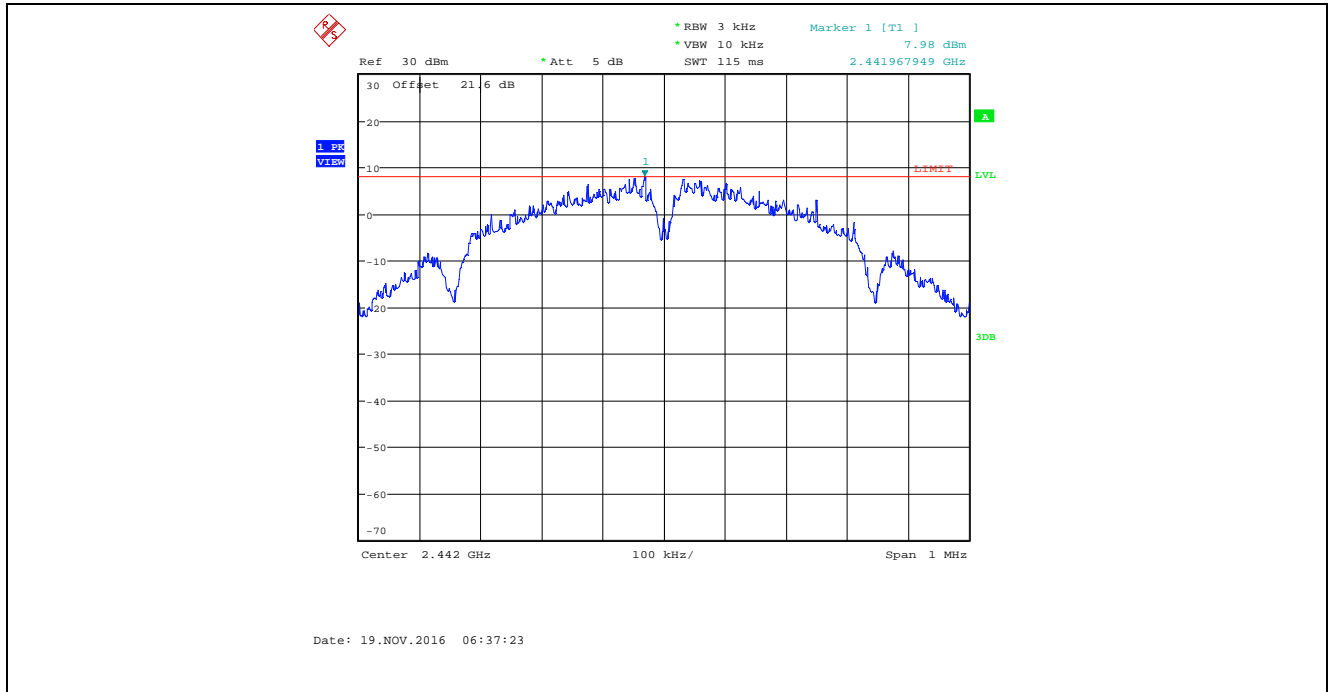

Plot 5.6.4.3. Power Spectral Density, Bandwidth: 1 MHz, TX Gain Setting: 26, Data Rate 1, 2482 MHz

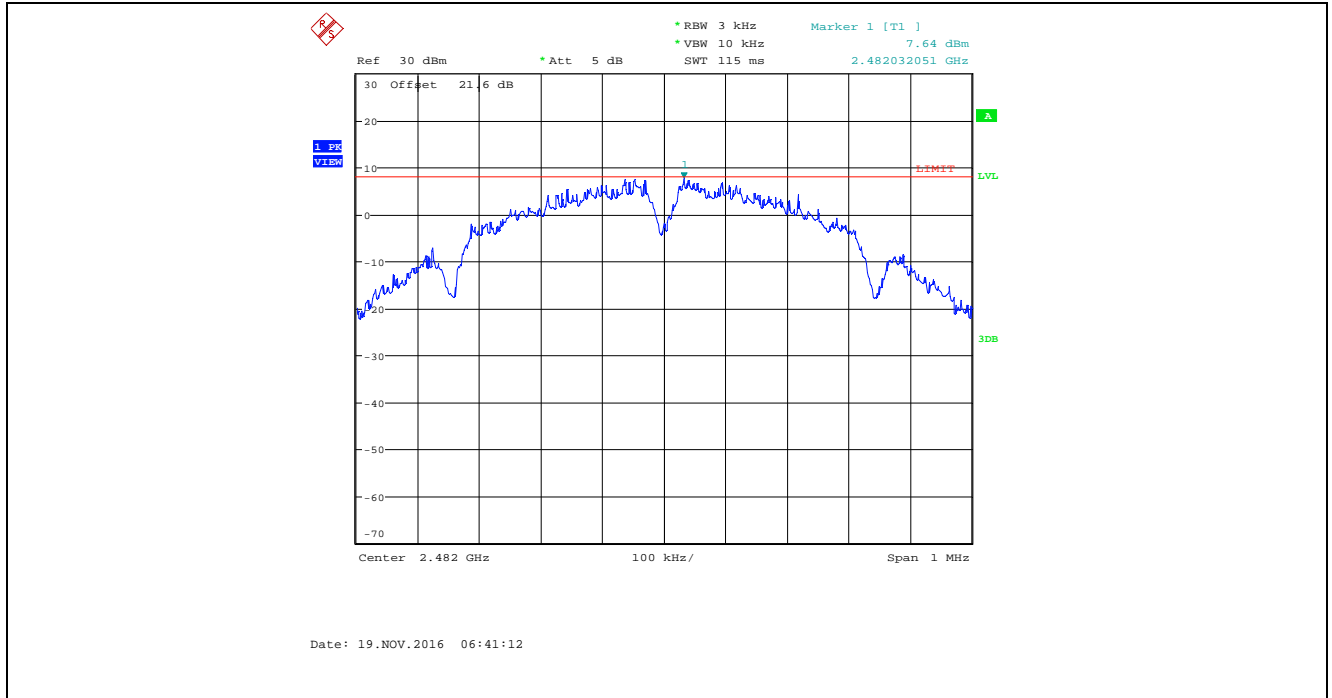

Plot 5.6.4.4. Power Spectral Density, Bandwidth: 1 MHz, TX Gain Setting: 26, Data Rate 2, 2402 MHz

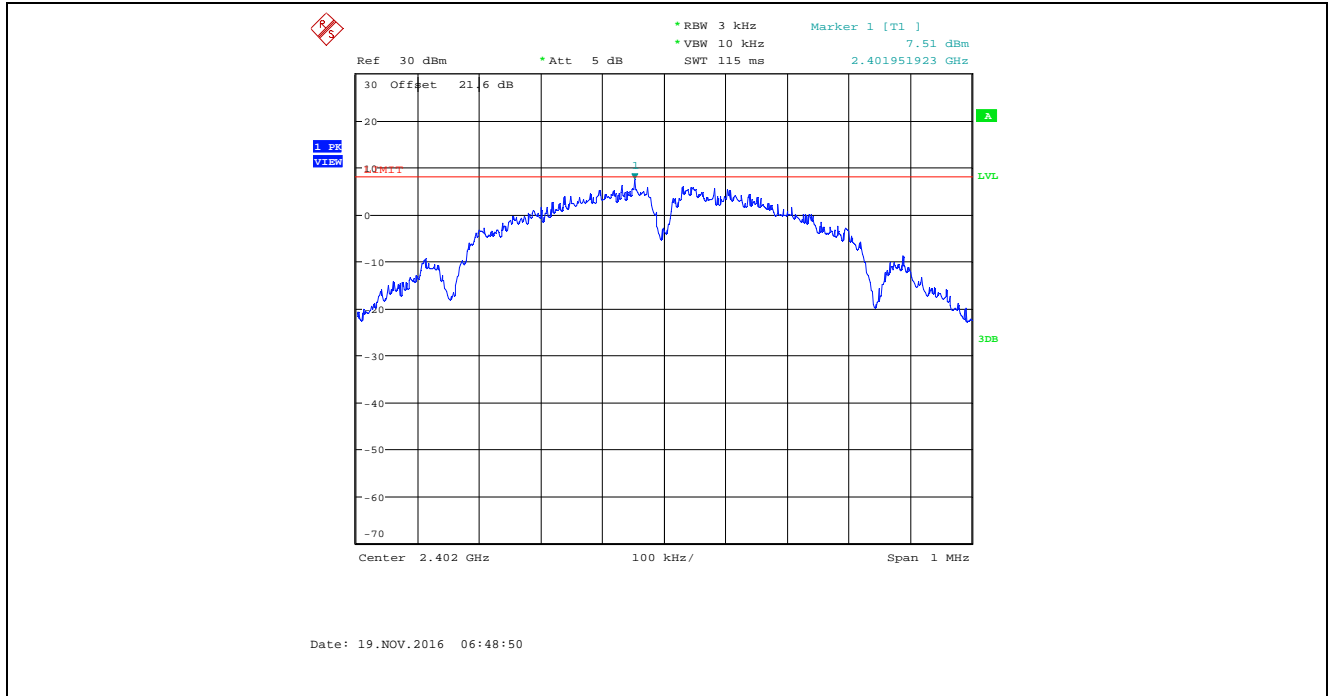

Plot 5.6.4.5. Power Spectral Density, Bandwidth: 1 MHz, TX Gain Setting: 26, Data Rate 2, 2442 MHz

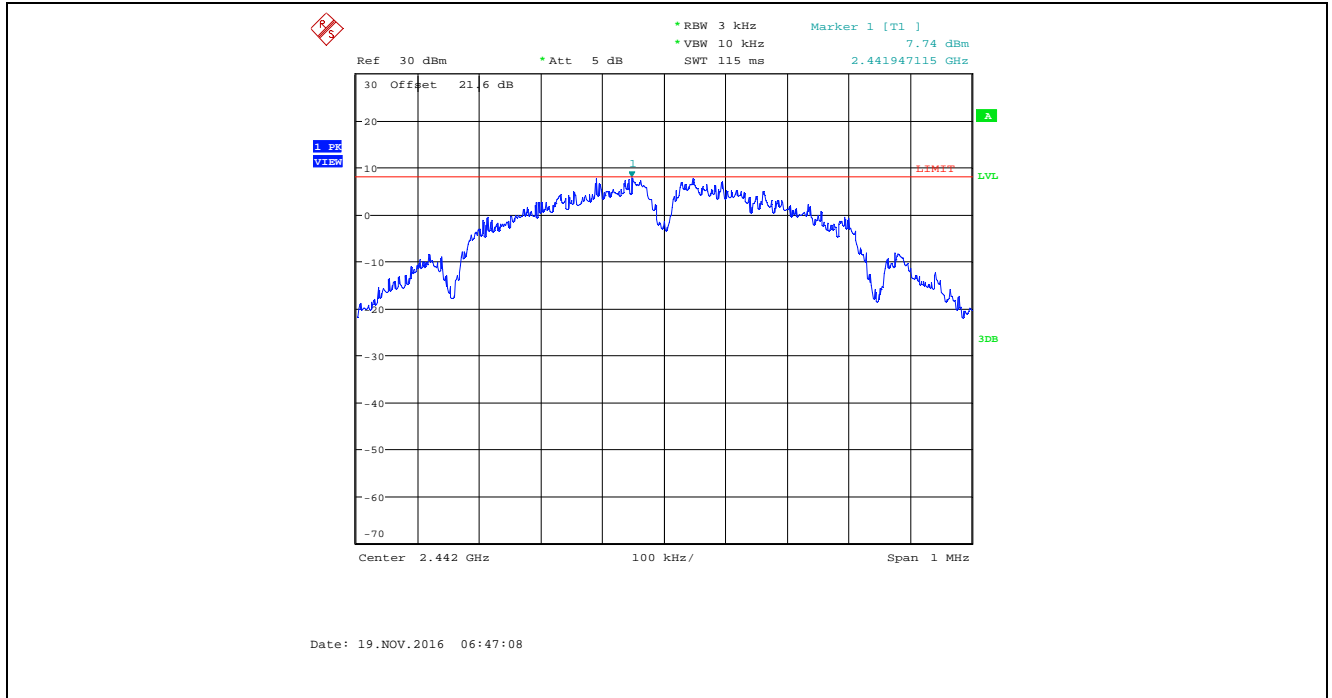

Plot 5.6.4.6. Power Spectral Density, Bandwidth: 1 MHz, TX Gain Setting: 26, Data Rate 2, 2482 MHz

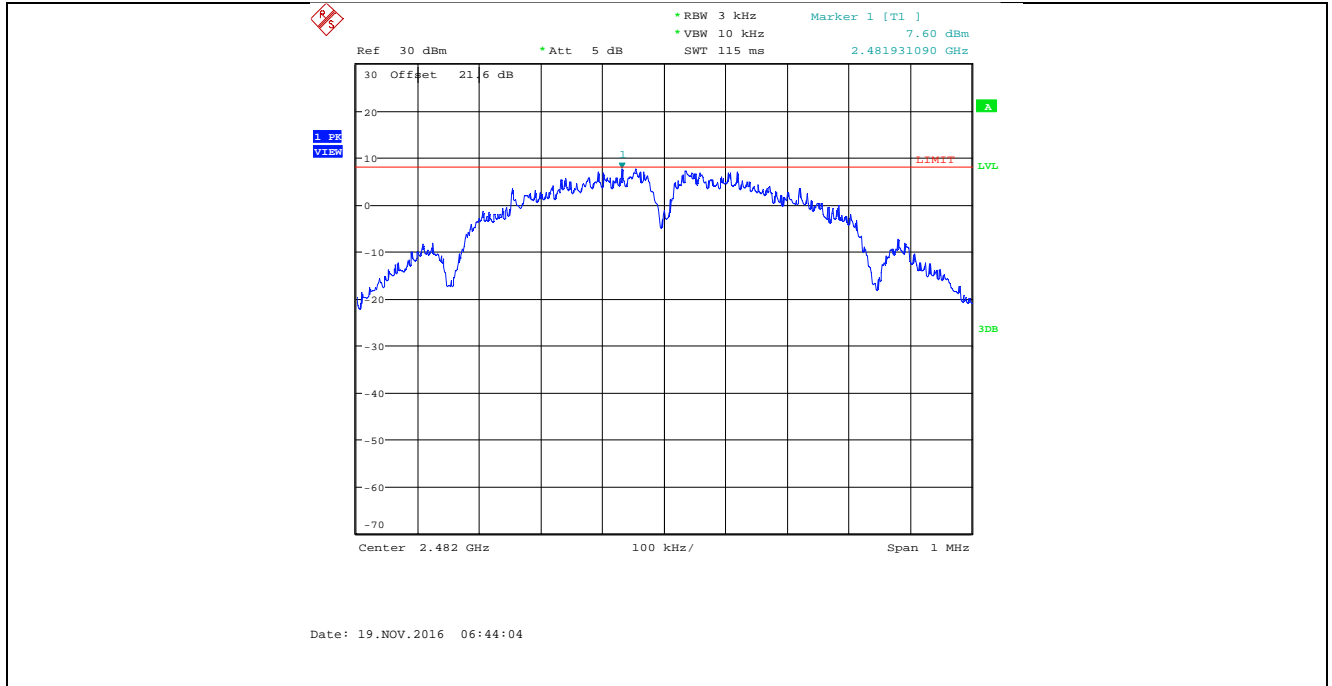

Plot 5.6.4.7. Power Spectral Density, Bandwidth: 2 MHz, TX Gain Setting: 32, Data Rate 1, 2402 MHz

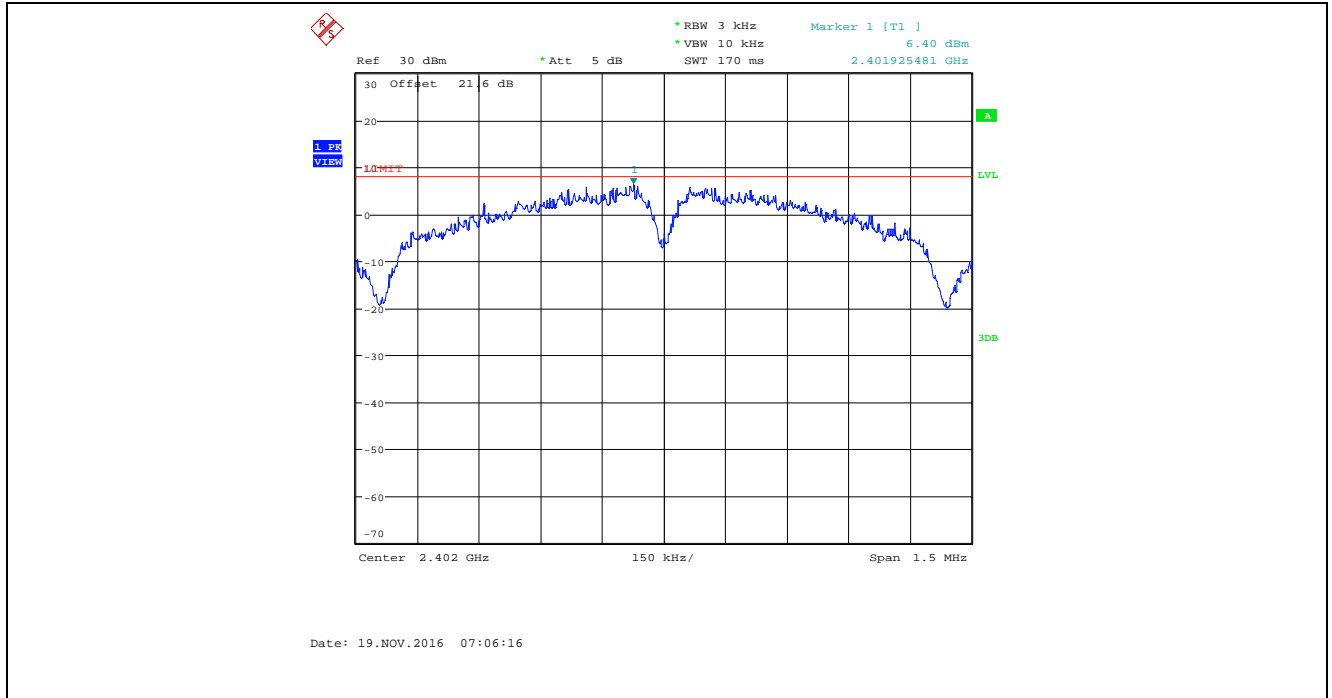

Plot 5.6.4.8. Power Spectral Density, Bandwidth: 2 MHz, TX Gain Setting: 32, Data Rate 1, 2442 MHz

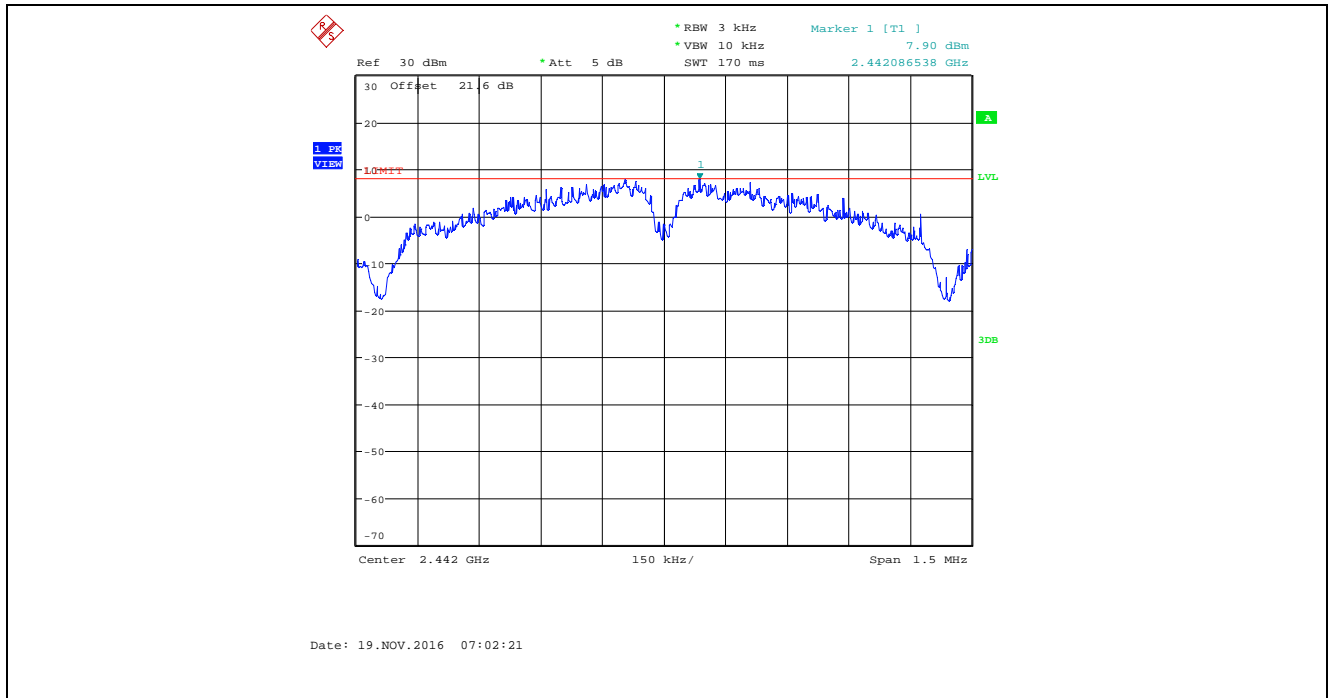



Plot 5.6.4.9. Power Spectral Density, Bandwidth: 2 MHz, TX Gain Setting: 32, Data Rate 1, 2482 MHz

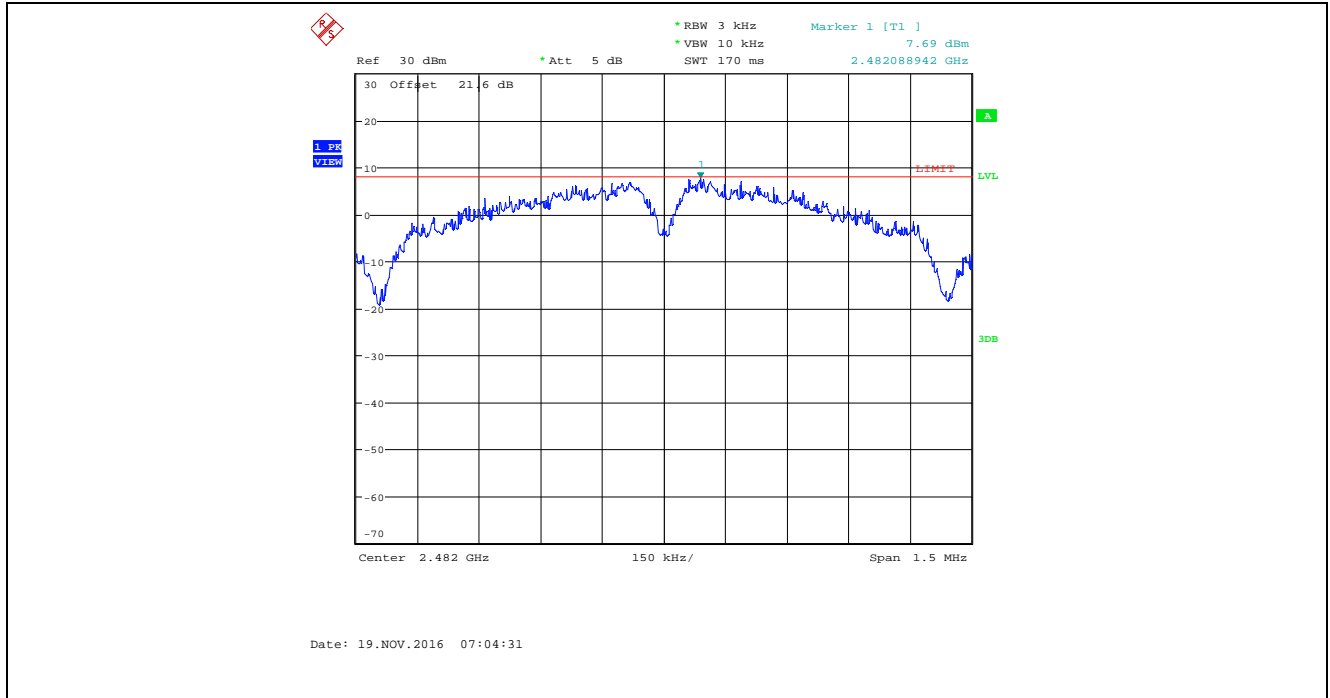

Plot 5.6.4.10. Power Spectral Density, Bandwidth: 2 MHz, TX Gain Setting: 32, Data Rate 2, 2402 MHz

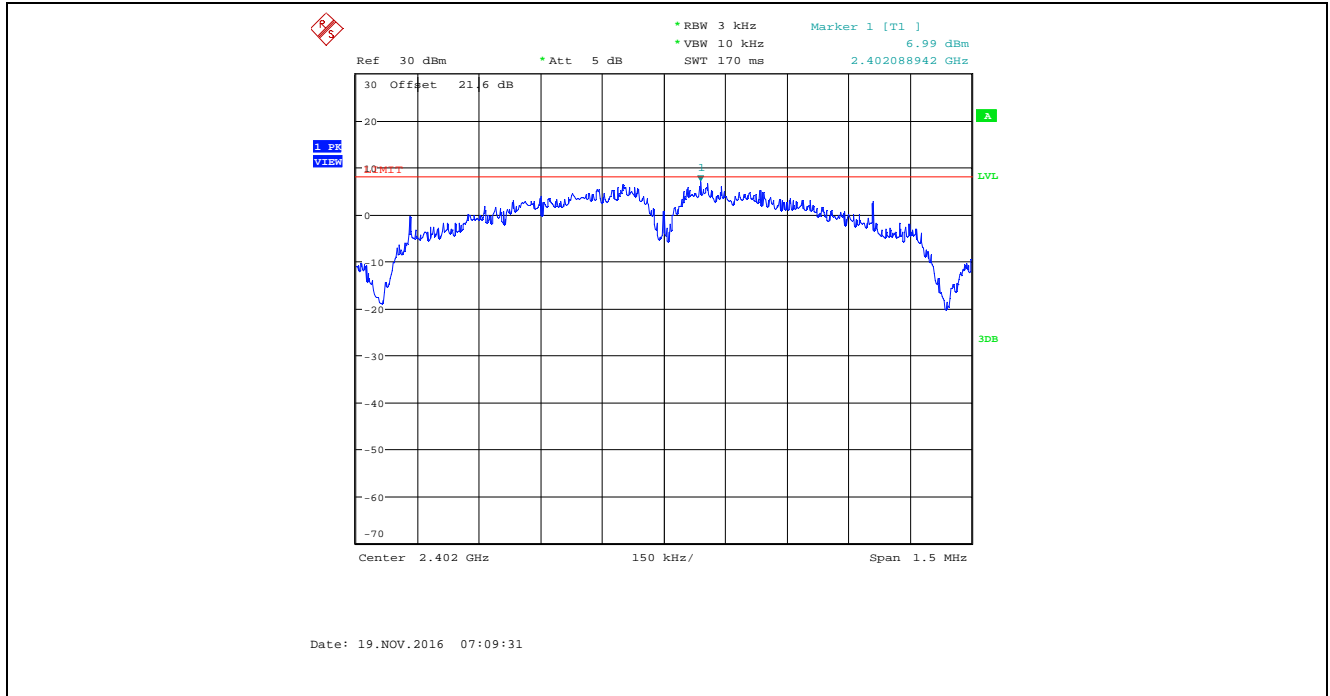

Plot 5.6.4.11. Power Spectral Density, Bandwidth: 2 MHz, TX Gain Setting: 32, Data Rate 2, 2442 MHz

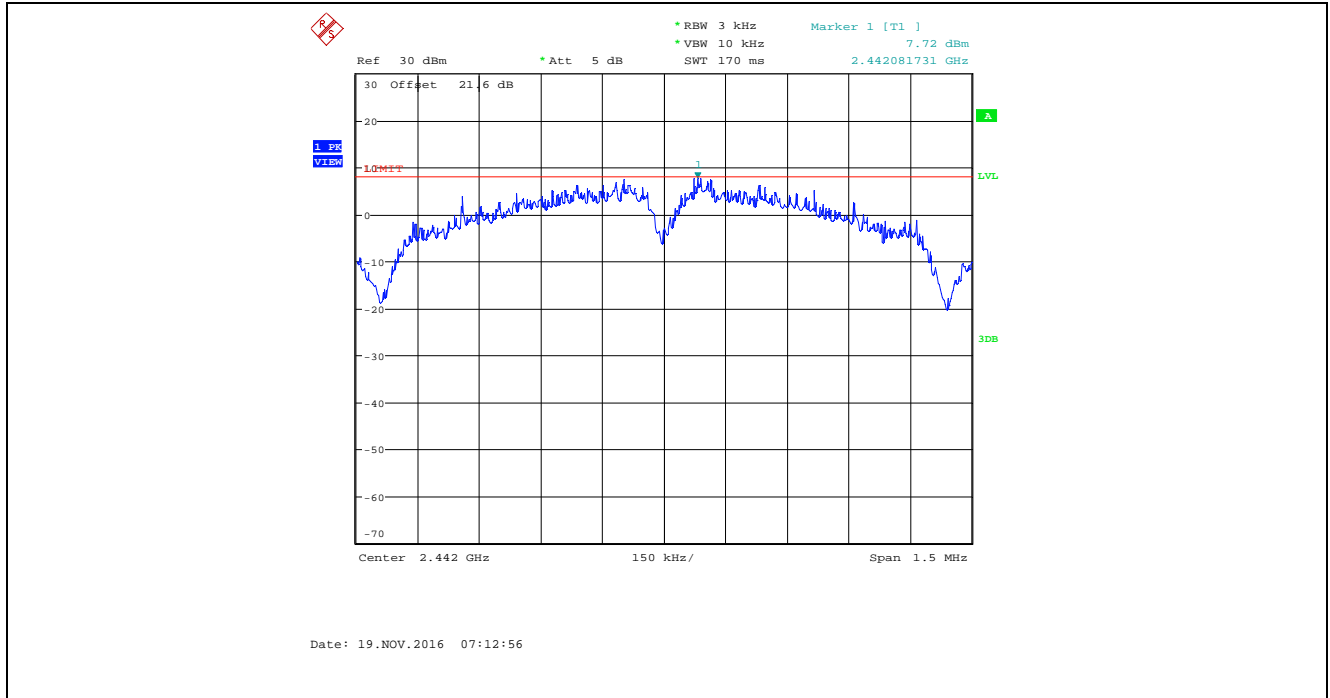

Plot 5.6.4.12. Power Spectral Density, Bandwidth: 2 MHz, TX Gain Setting: 32, Data Rate 2, 2482 MHz

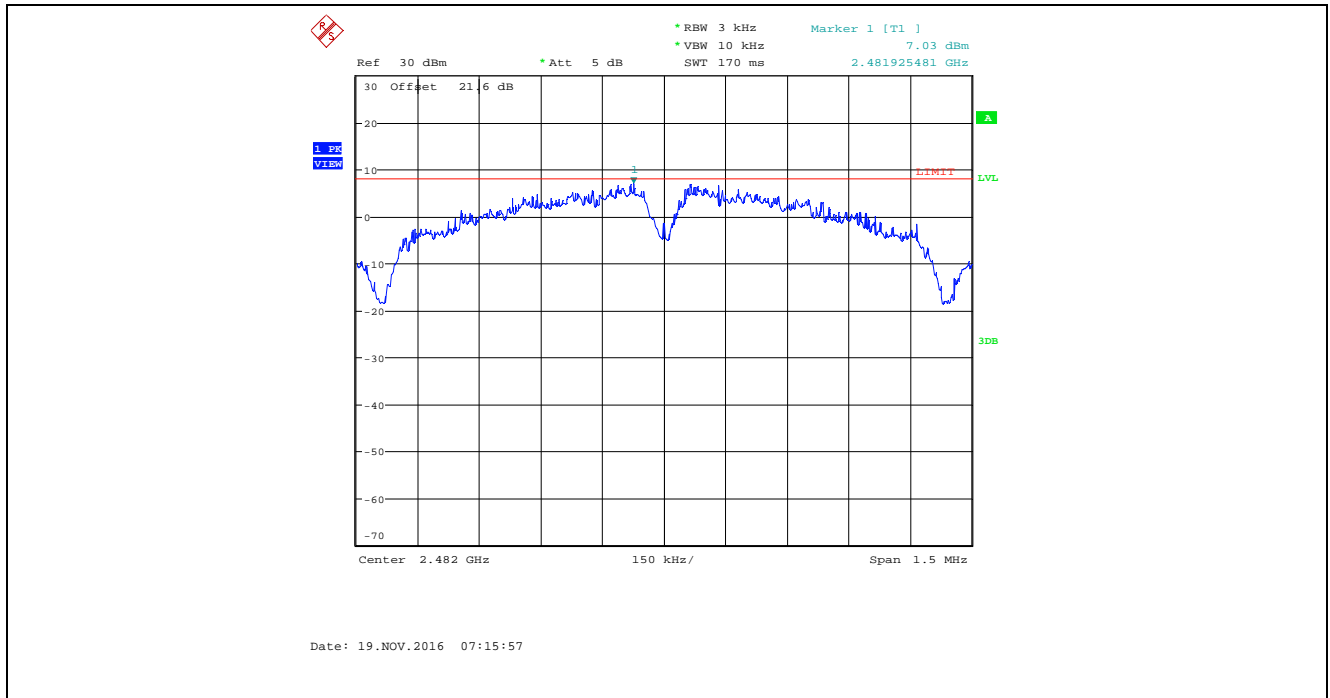

Plot 5.6.4.13. Power Spectral Density, Bandwidth: 2 MHz, TX Gain Setting: 32, Data Rate 3, 2402 MHz

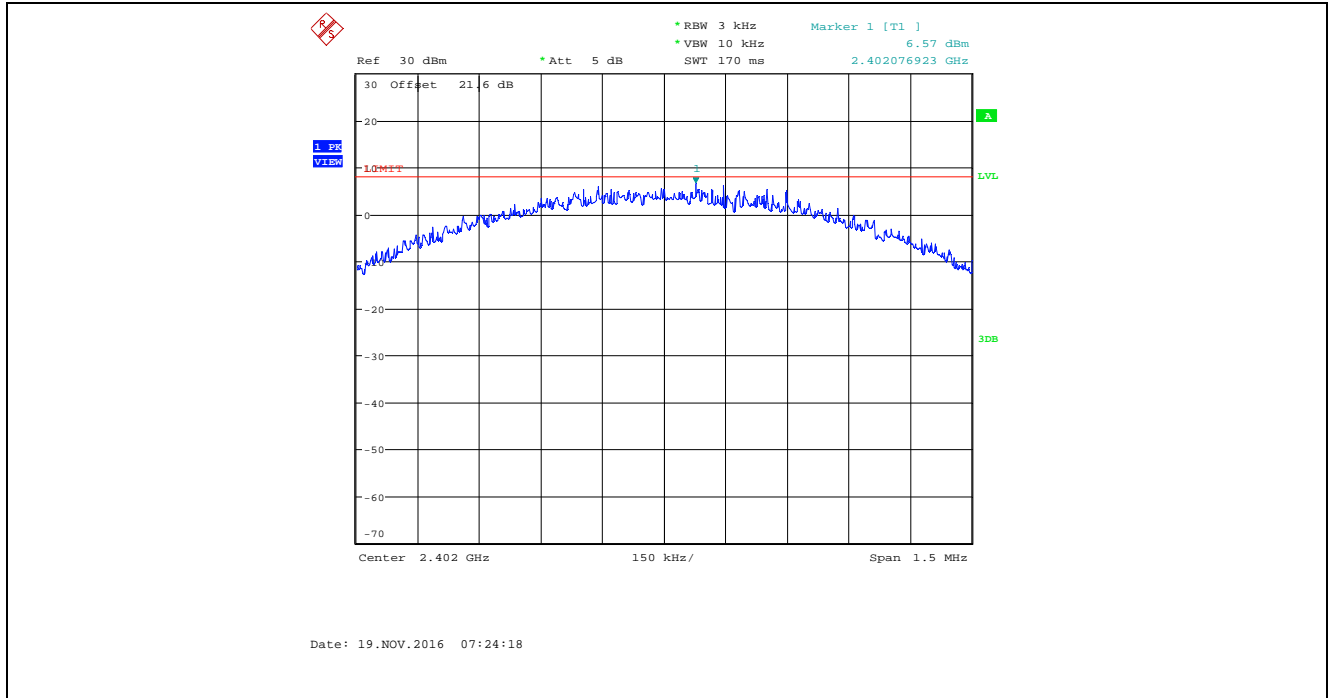

Plot 5.6.4.14. Power Spectral Density, Bandwidth: 2 MHz, TX Gain Setting: 32, Data Rate 3, 2442 MHz

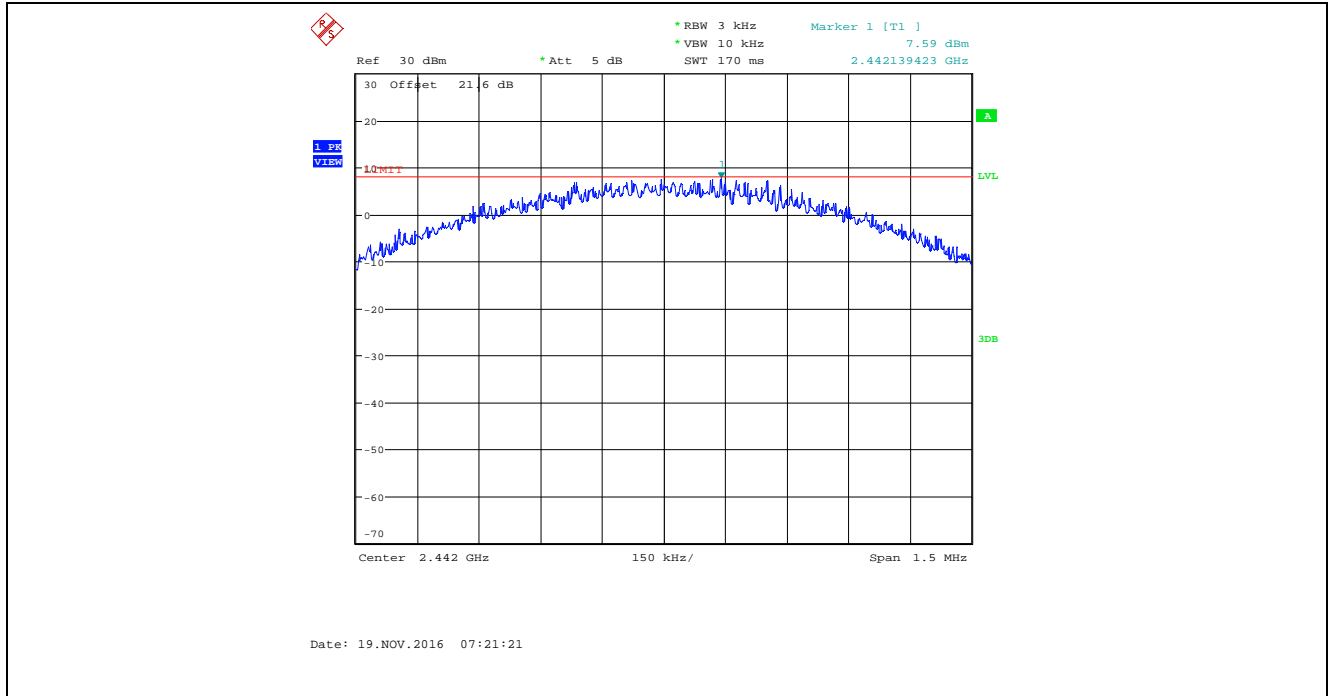

Plot 5.6.4.15. Power Spectral Density, Bandwidth: 2 MHz, TX Gain Setting: 32, Data Rate 3, 2482 MHz

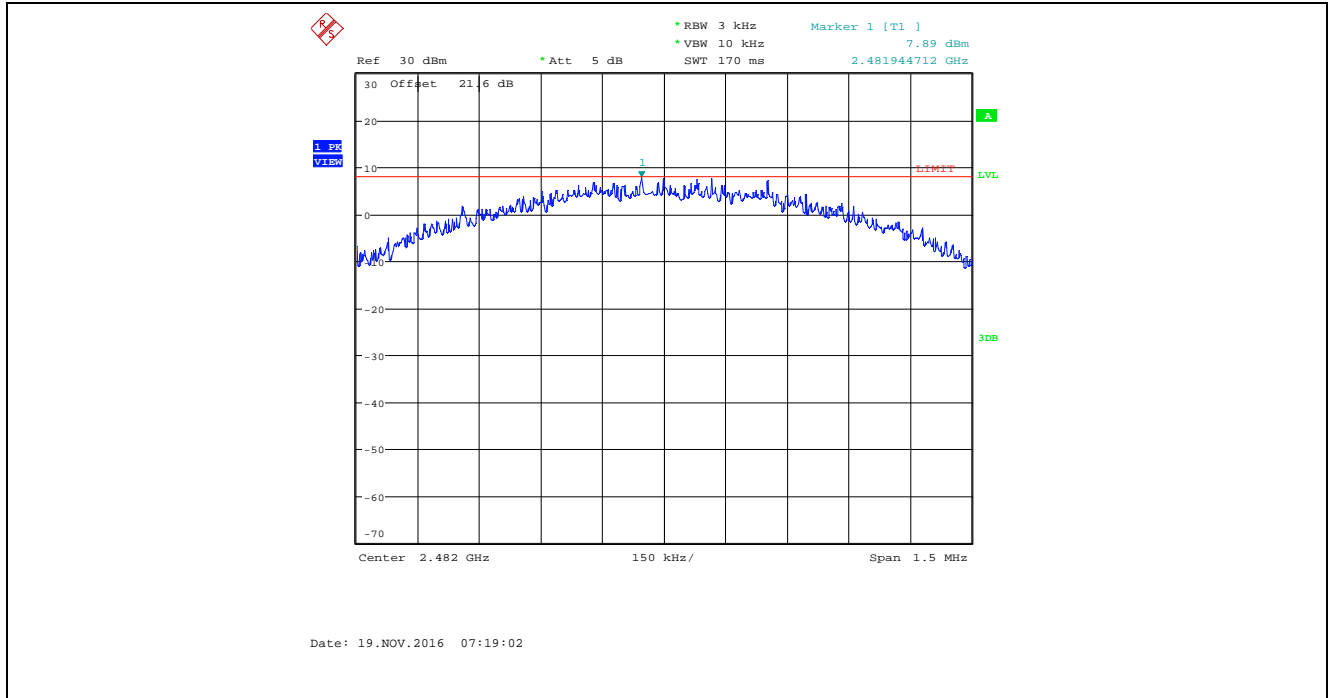

Plot 5.6.4.16. Power Spectral Density, Bandwidth: 4 MHz, TX Gain Setting: 43, Data Rate 1, 2403 MHz

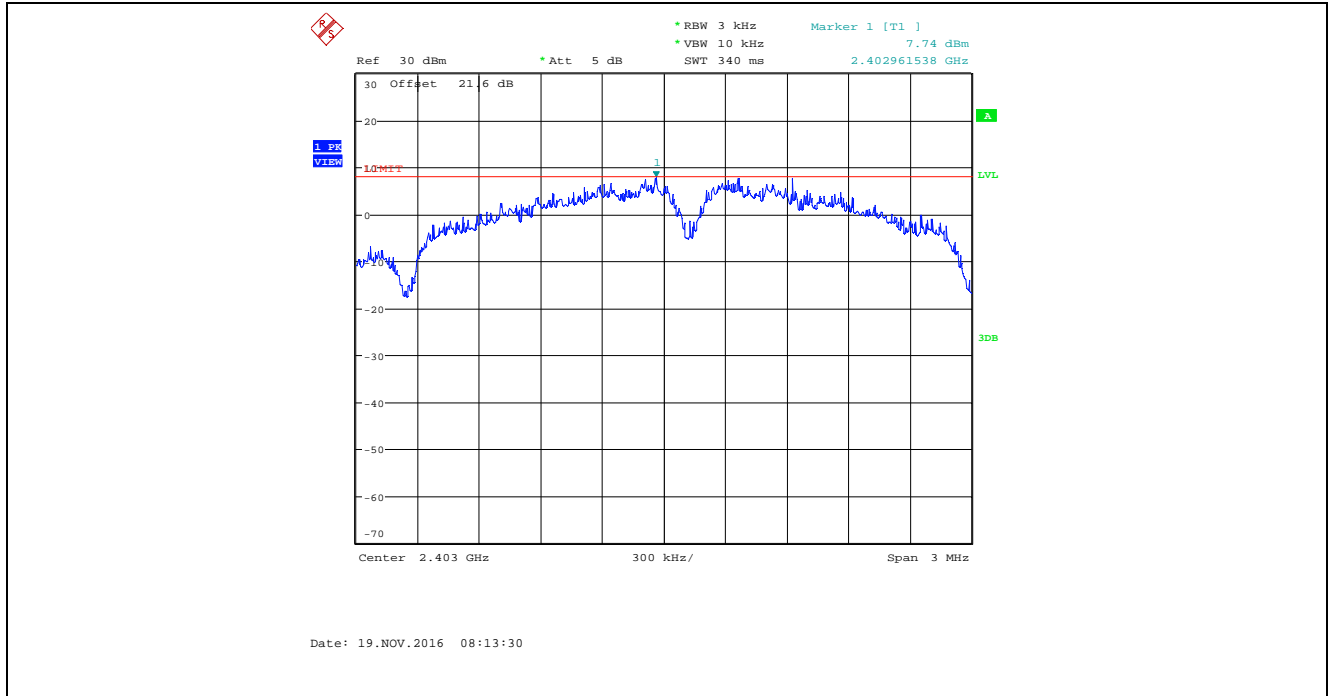

Plot 5.6.4.17. Power Spectral Density, Bandwidth: 4 MHz, TX Gain Setting: 43, Data Rate 1, 2442 MHz

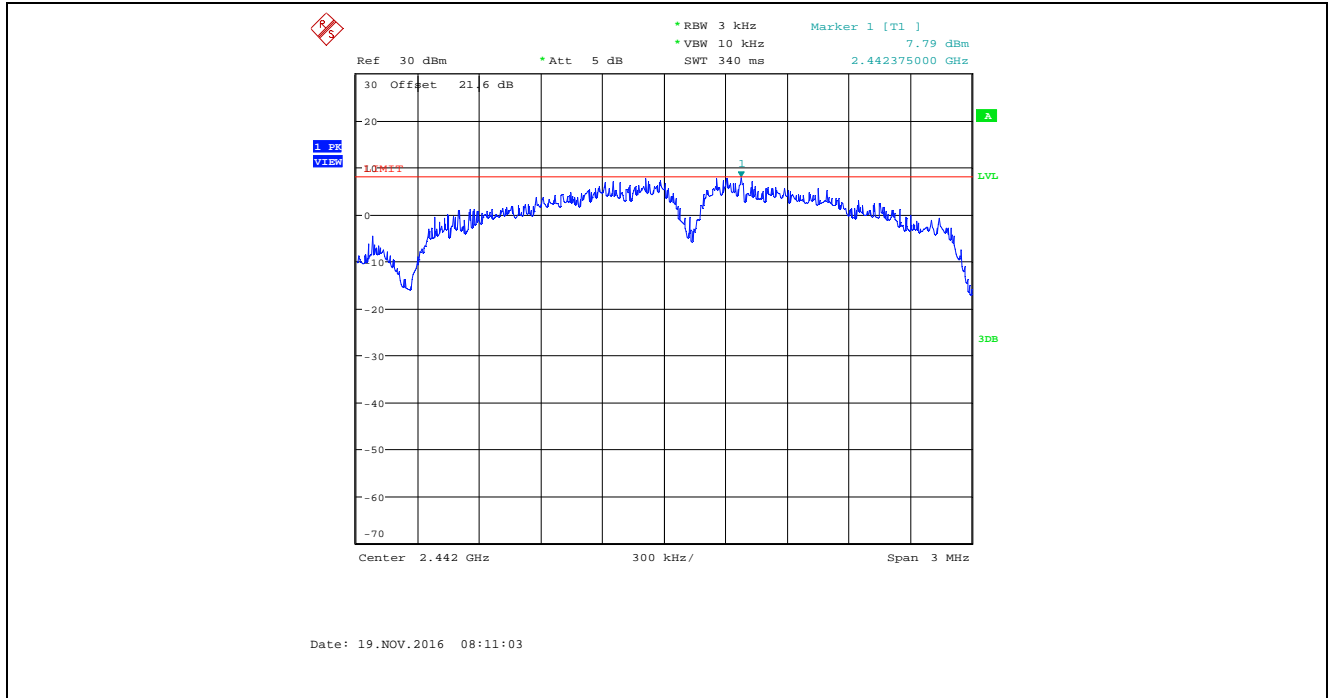

Plot 5.6.4.18. Power Spectral Density, Bandwidth: 4 MHz, TX Gain Setting: 43, Data Rate 1, 2480 MHz

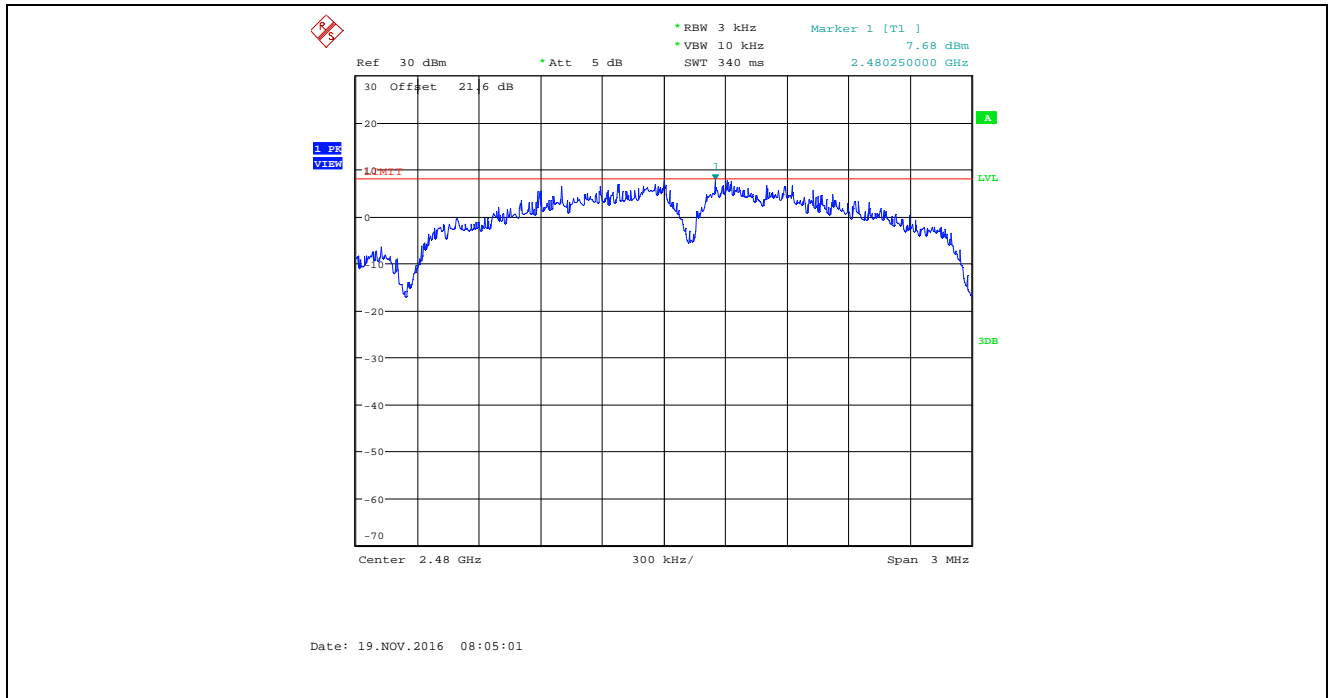

Plot 5.6.4.19. Power Spectral Density, Bandwidth: 4 MHz, TX Gain Setting: 43, Data Rate 2, 2403 MHz

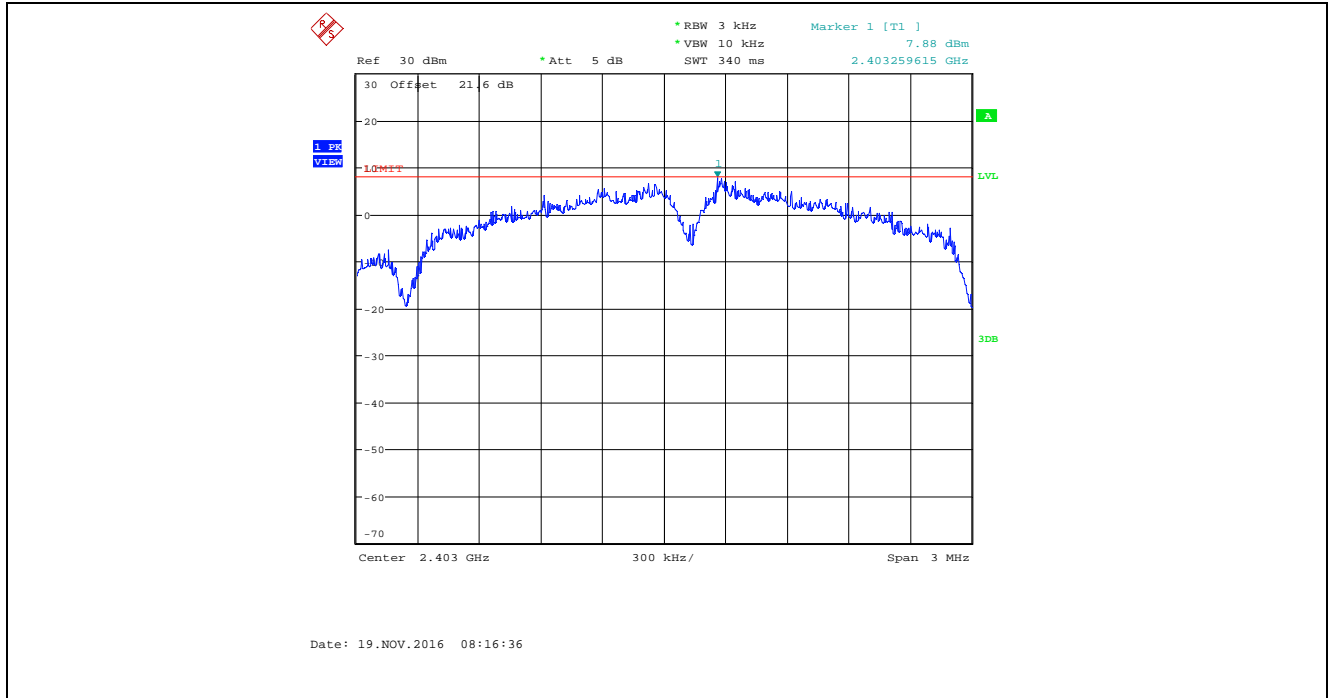

Plot 5.6.4.20. Power Spectral Density, Bandwidth: 4 MHz, TX Gain Setting: 43, Data Rate 2, 2442 MHz

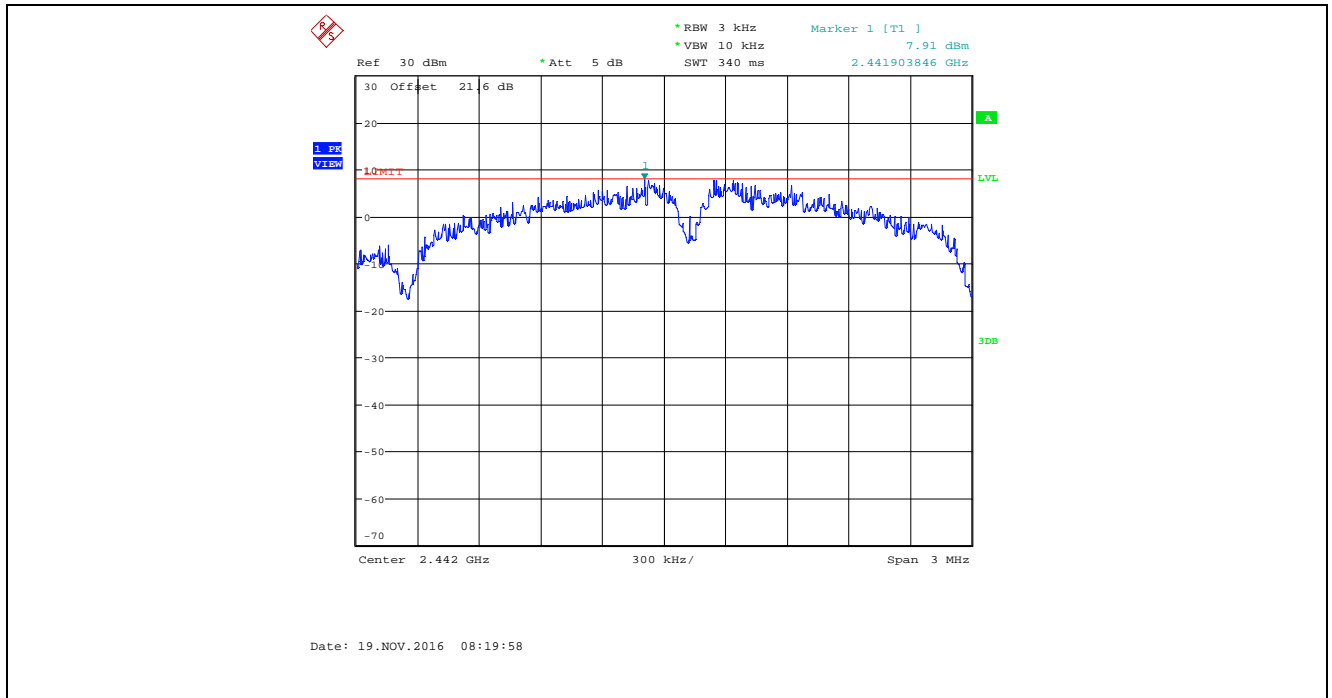

Plot 5.6.4.21. Power Spectral Density, Bandwidth: 4 MHz, TX Gain Setting: 43, Data Rate 2, 2480 MHz

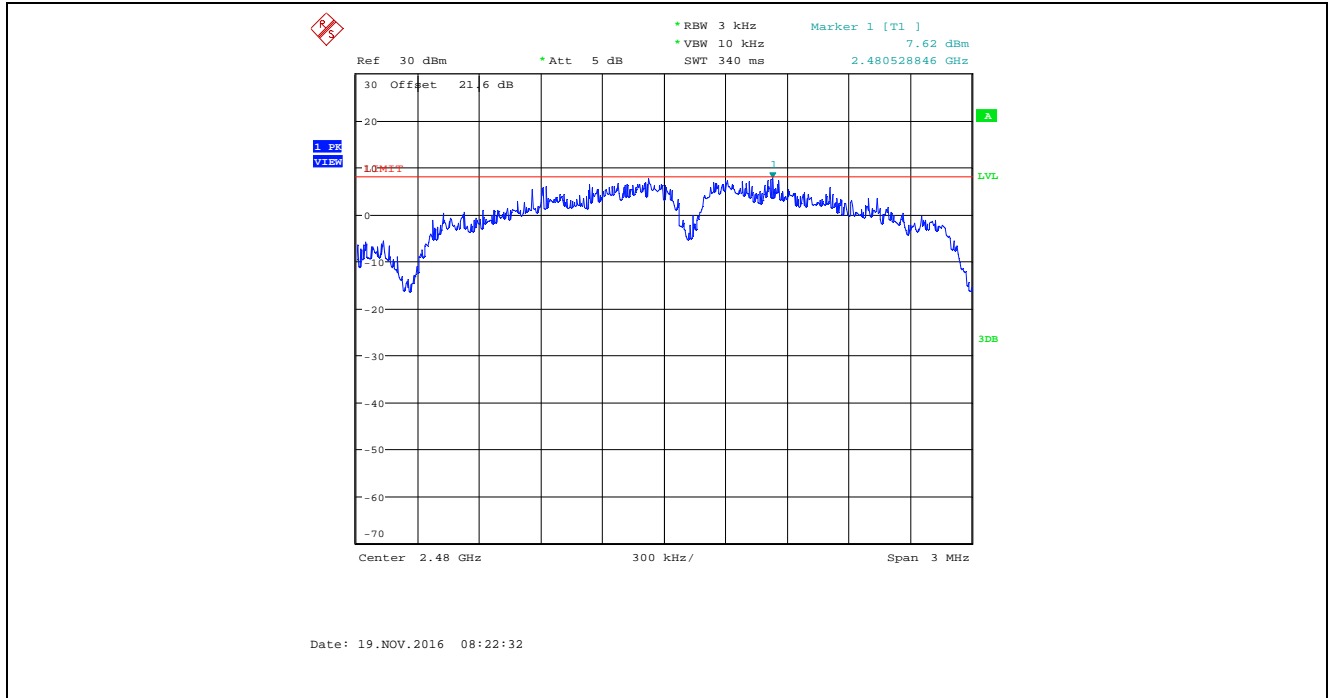

Plot 5.6.4.22. Power Spectral Density, Bandwidth: 4 MHz, TX Gain Setting: 43, Data Rate 3, 2403 MHz

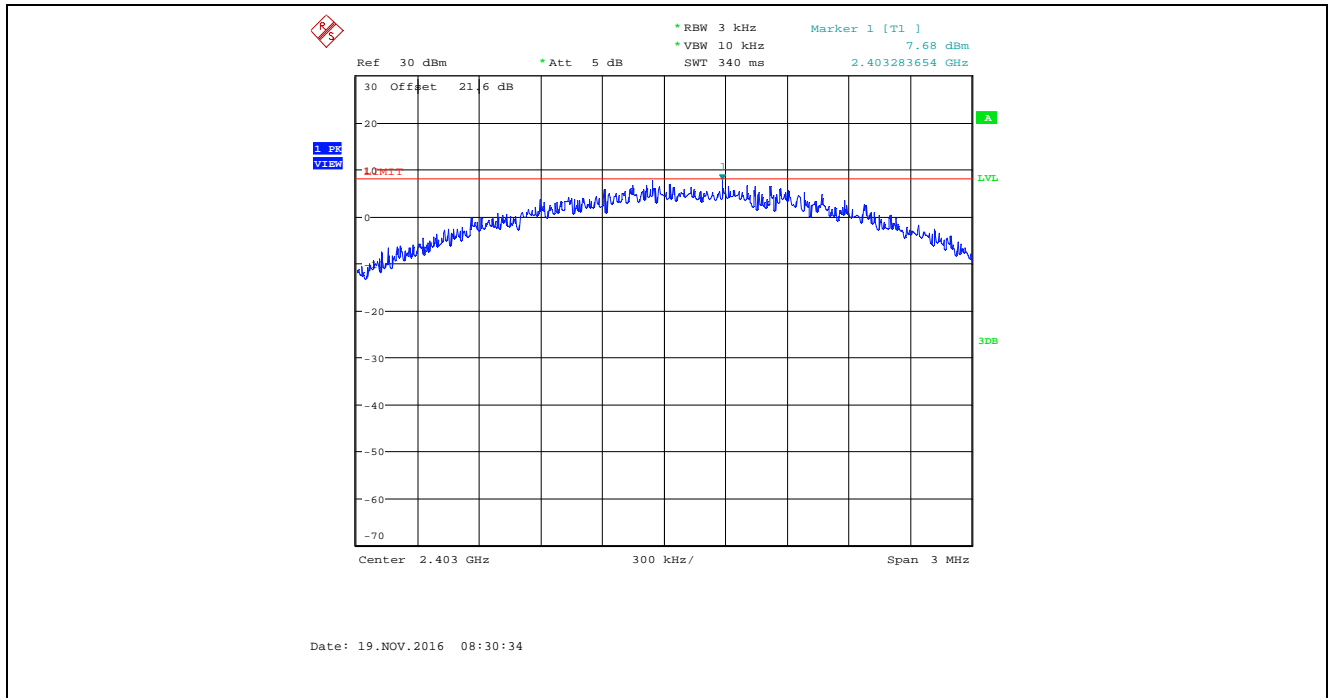

Plot 5.6.4.23. Power Spectral Density, Bandwidth: 4 MHz, TX Gain Setting: 43, Data Rate 3, 2442 MHz

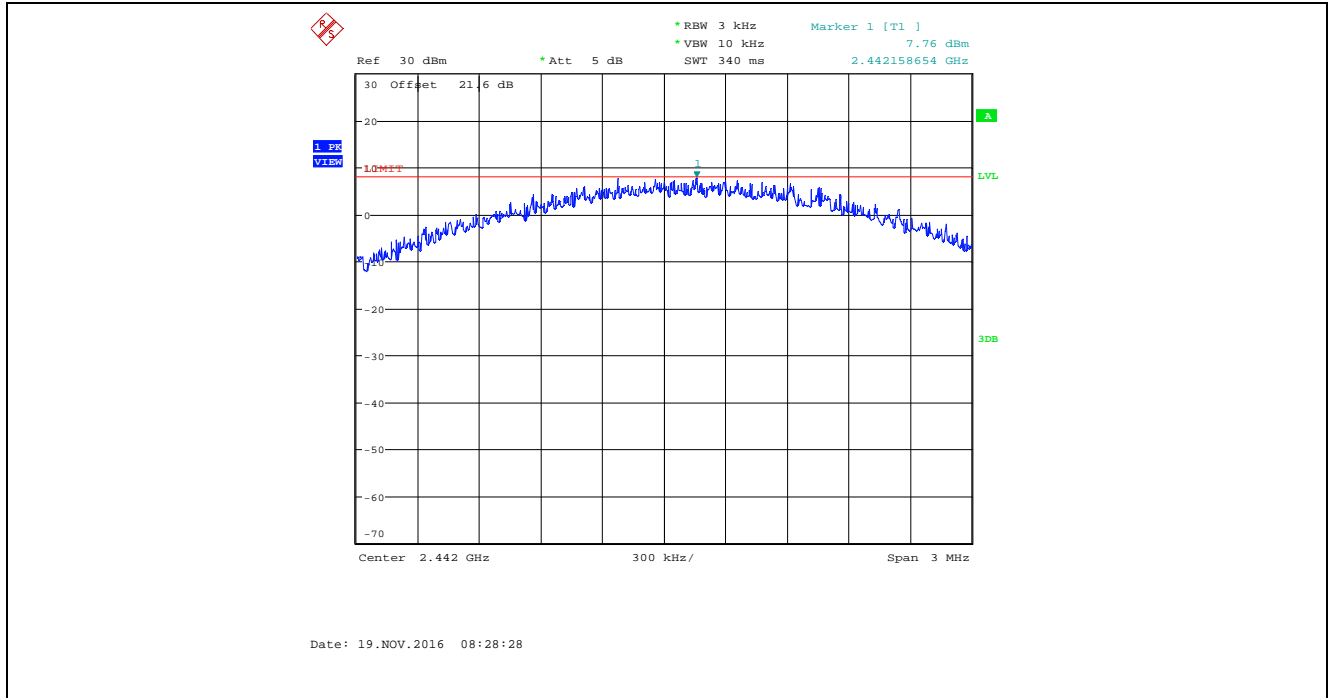

Plot 5.6.4.24. Power Spectral Density, Bandwidth: 4 MHz, TX Gain Setting: 43, Data Rate 3, 2480 MHz

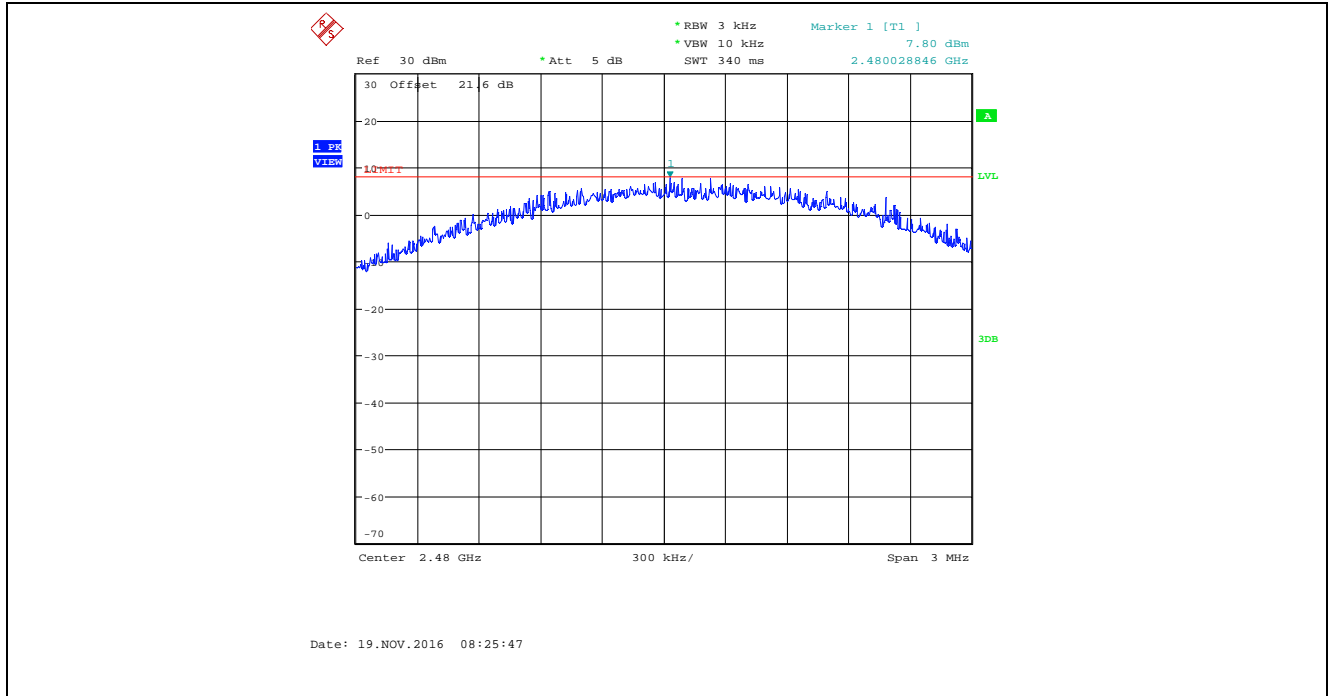



Plot 5.6.4.25. Power Spectral Density, Bandwidth: 8 MHz, TX Gain Setting: 50, Data Rate 1, 2407 MHz

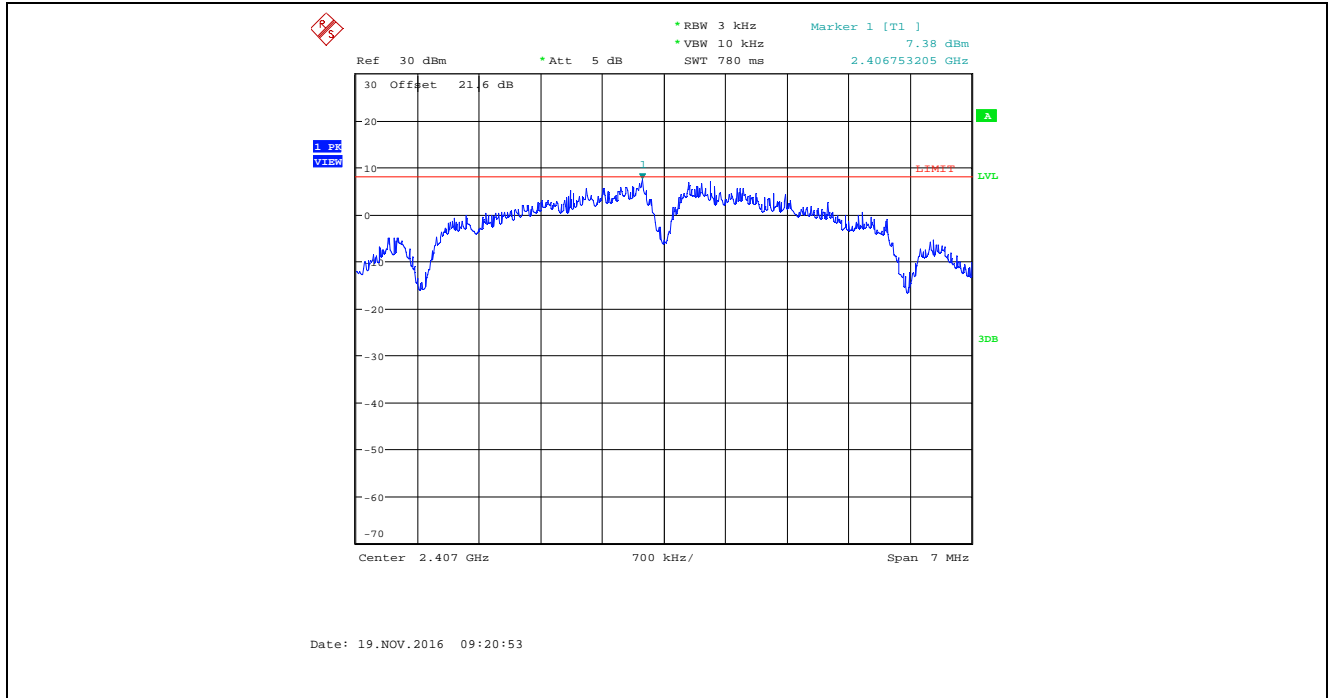

Plot 5.6.4.26. Power Spectral Density, Bandwidth: 8 MHz, TX Gain Setting: 50, Data Rate 1, 2442 MHz

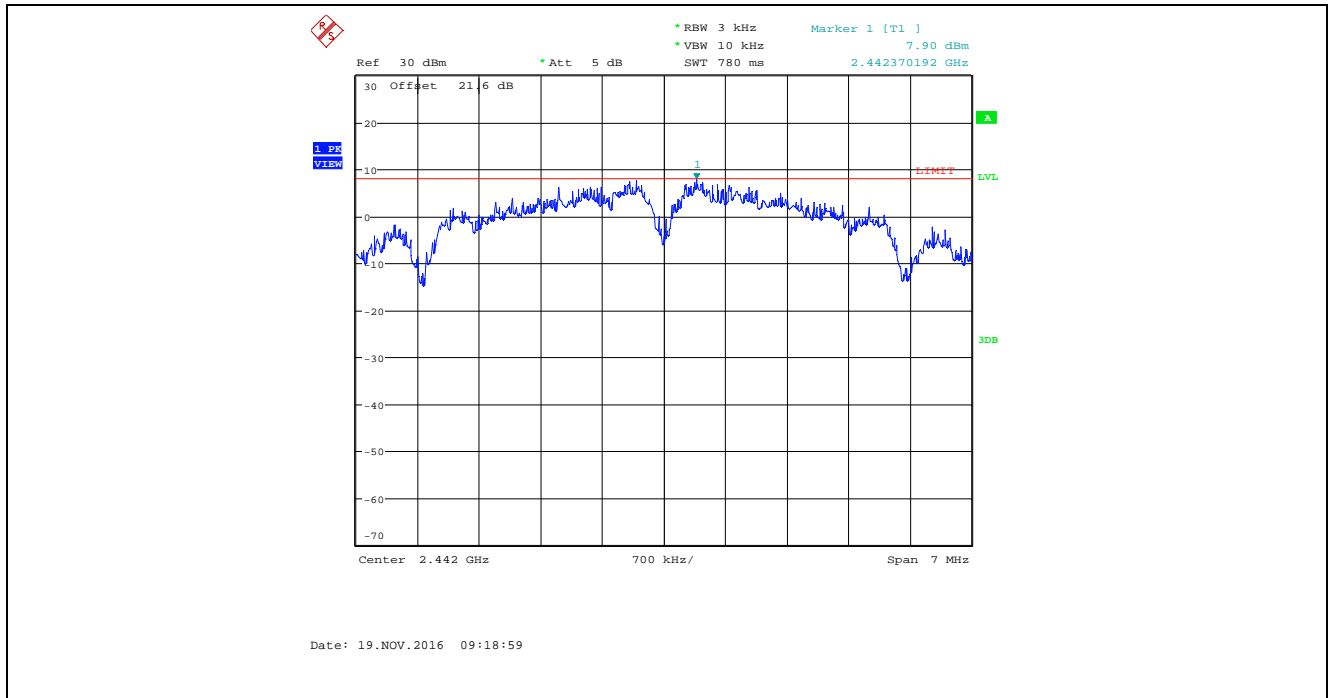

Plot 5.6.4.27. Power Spectral Density, Bandwidth: 8 MHz, TX Gain Setting: 50, Data Rate 1, 2477 MHz

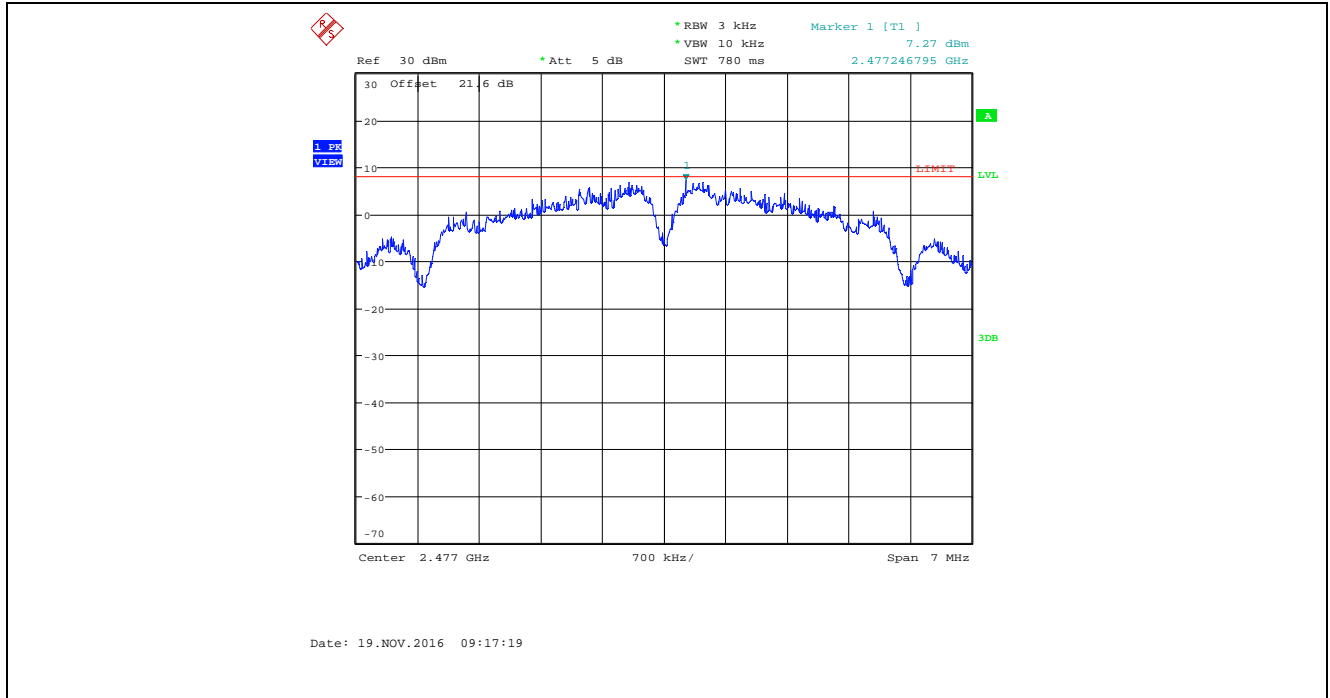

Plot 5.6.4.28. Power Spectral Density, Bandwidth: 8 MHz, TX Gain Setting: 50, Data Rate 2, 2407 MHz

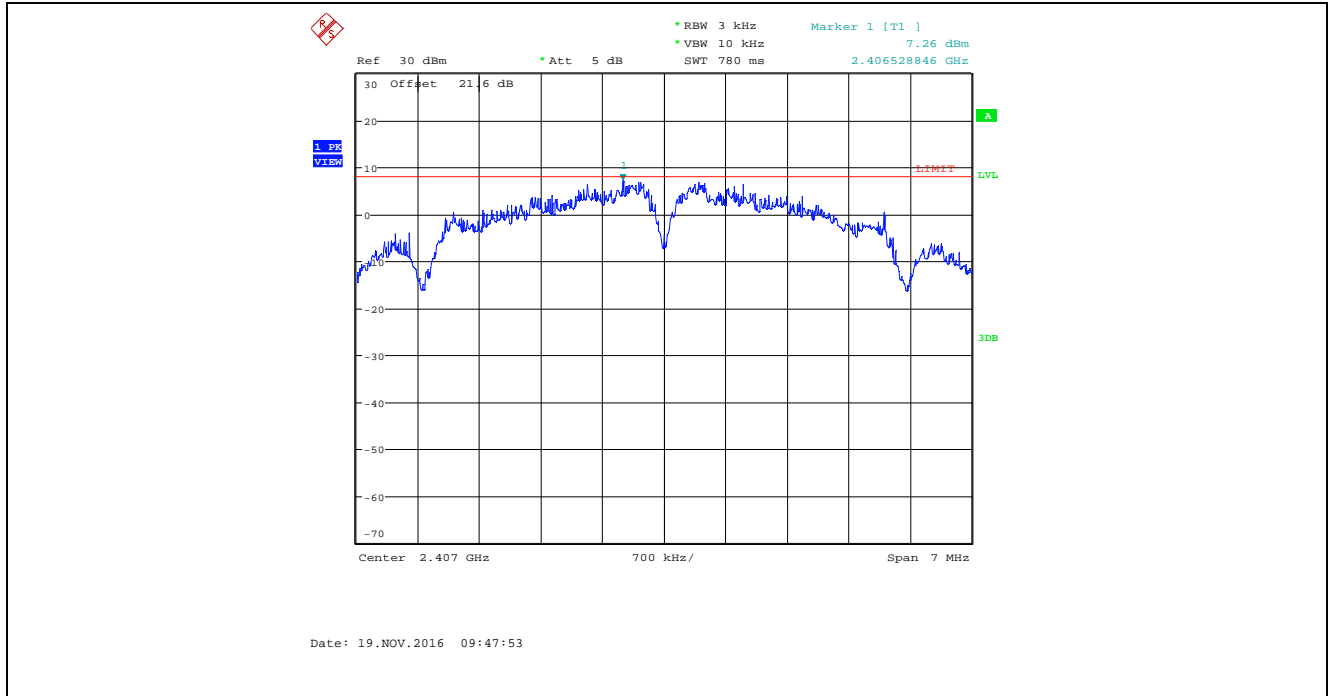

Plot 5.6.4.29. Power Spectral Density, Bandwidth: 8 MHz, TX Gain Setting: 50, Data Rate 2, 2442 MHz

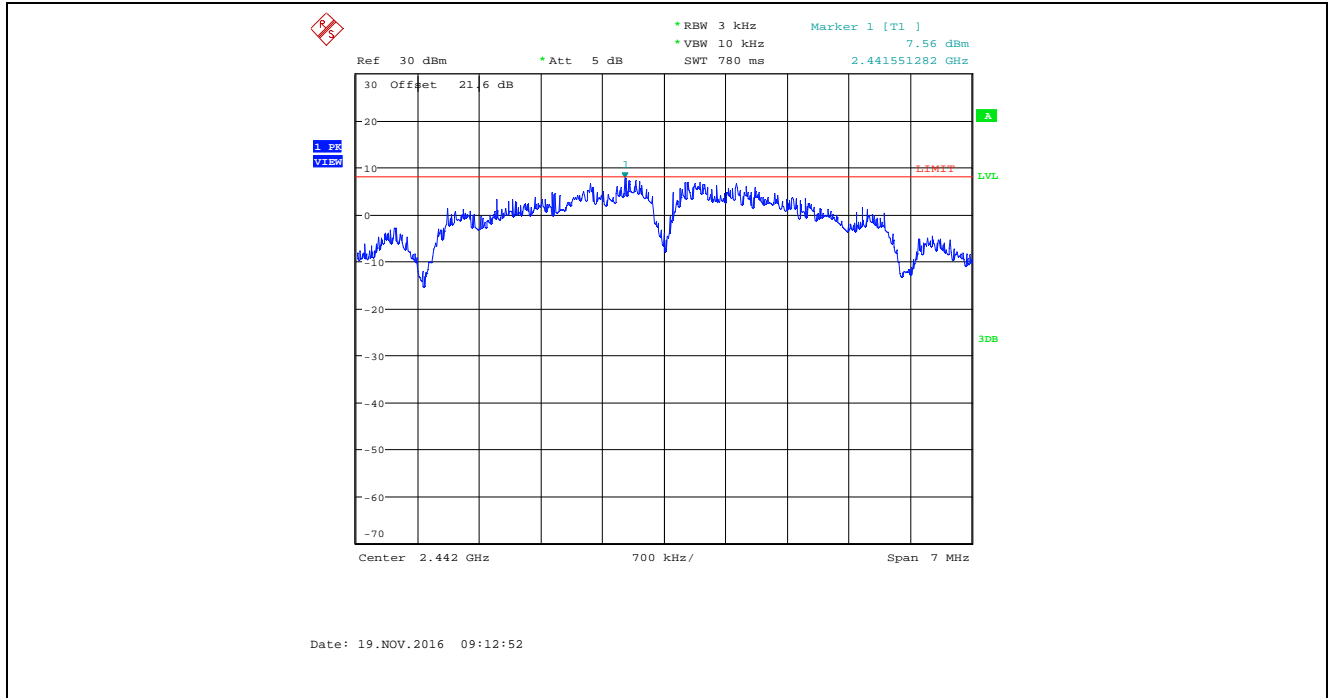

Plot 5.6.4.30. Power Spectral Density, Bandwidth: 8 MHz, TX Gain Setting: 50, Data Rate 2, 2477 MHz

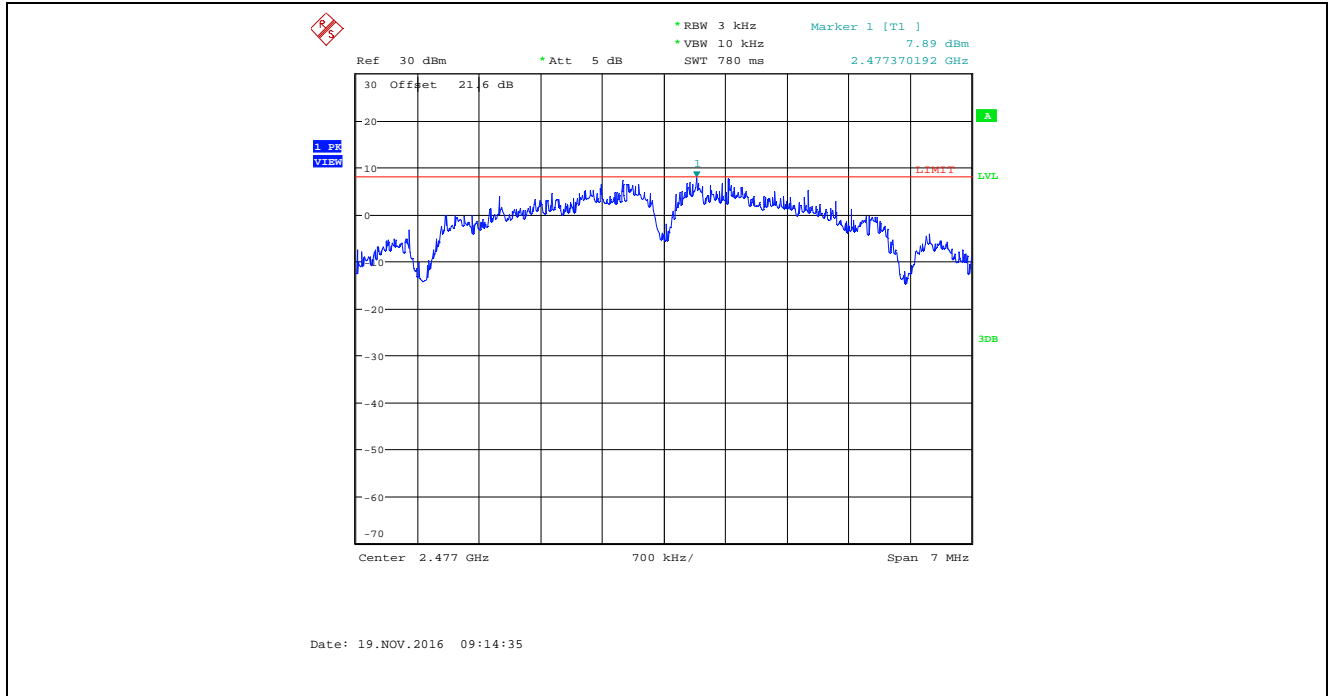

Plot 5.6.4.31. Power Spectral Density, Bandwidth: 8 MHz, TX Gain Setting: 50, Data Rate 3, 2407 MHz

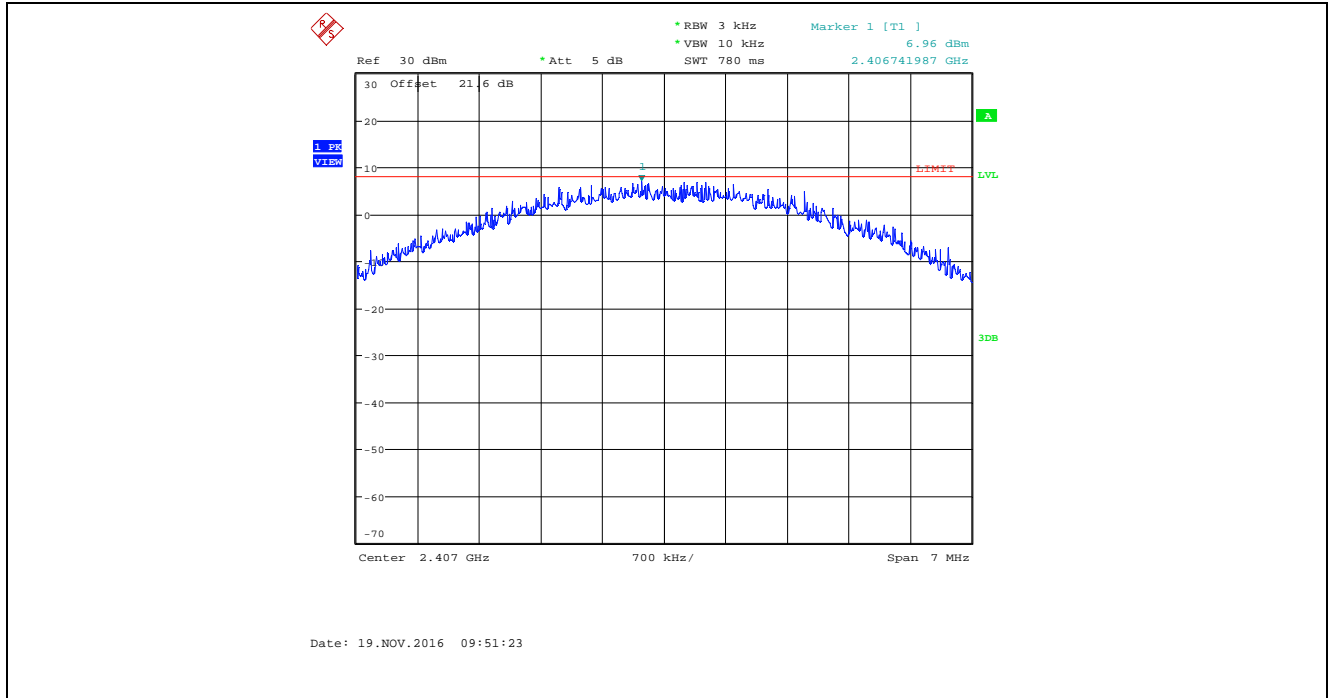

Plot 5.6.4.32. Power Spectral Density, Bandwidth: 8 MHz, TX Gain Setting: 50, Data Rate 3, 2442 MHz

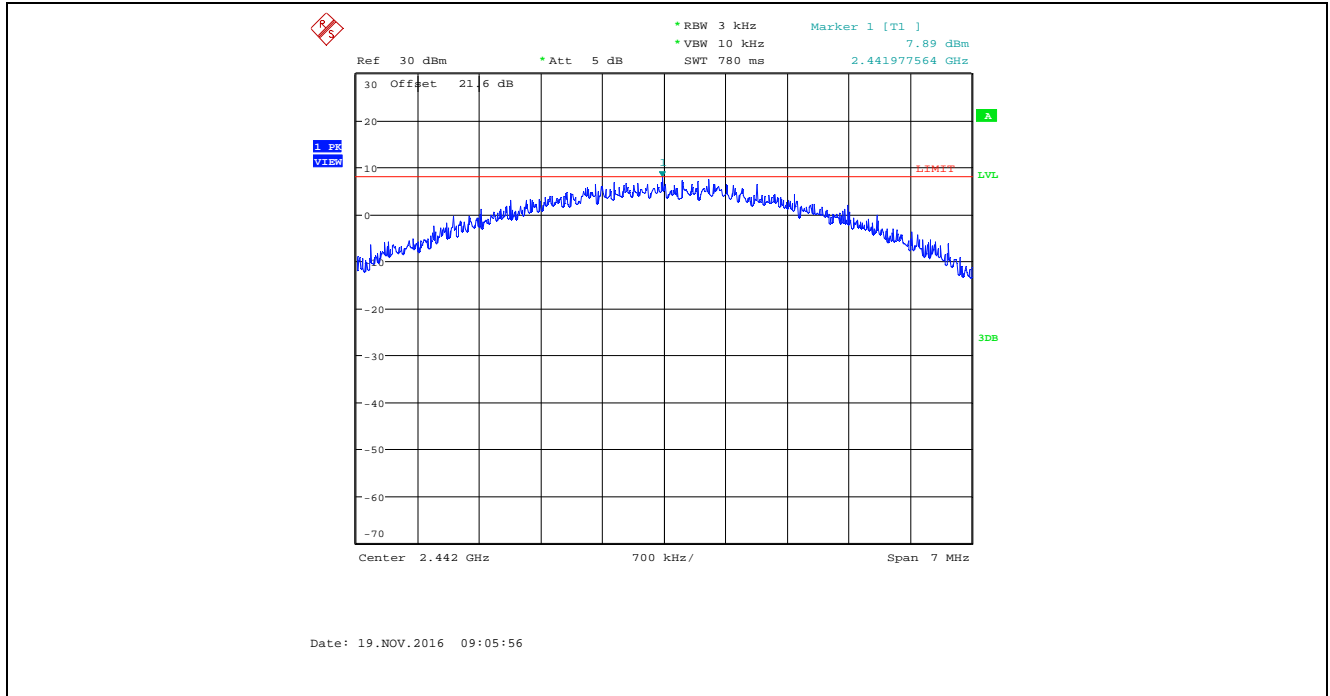

Plot 5.6.4.33. Power Spectral Density, Bandwidth: 8 MHz, TX Gain Setting: 50, Data Rate 3, 2477 MHz

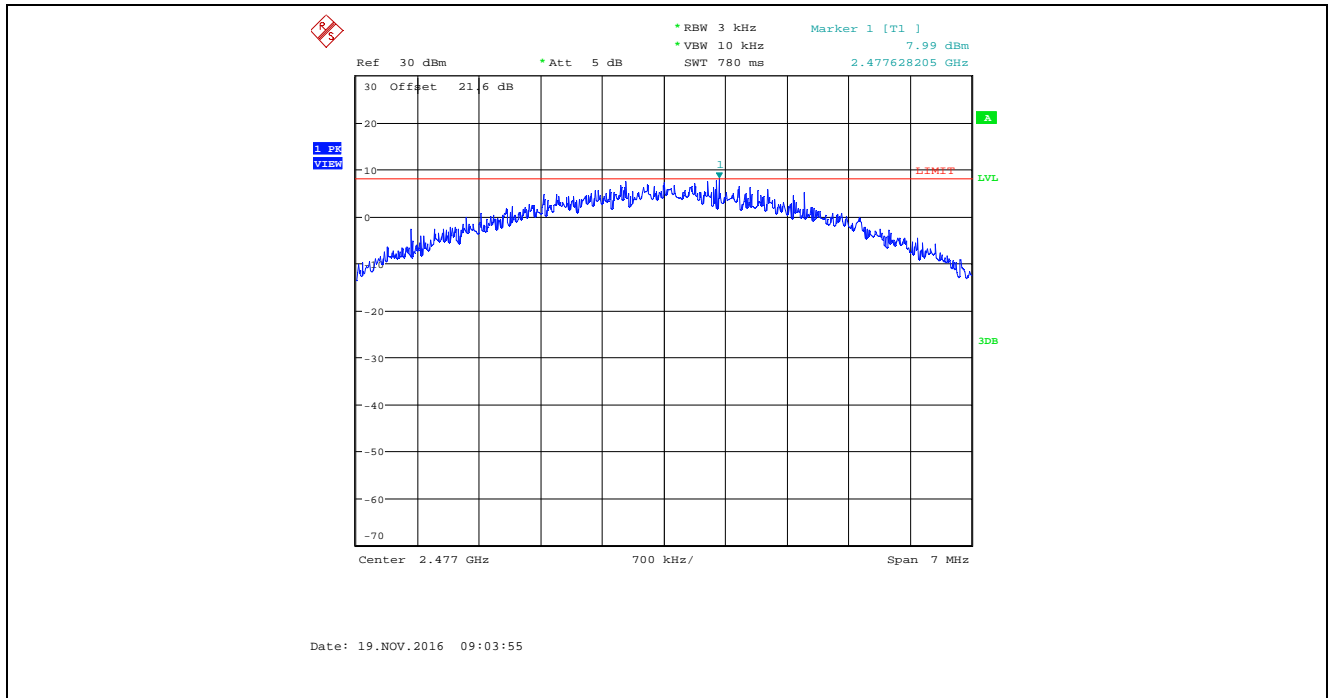

Plot 5.6.4.34. Power Spectral Density, Bandwidth: 1 MHz, TX Gain Setting: 43, Data Rate 4, 2402 MHz

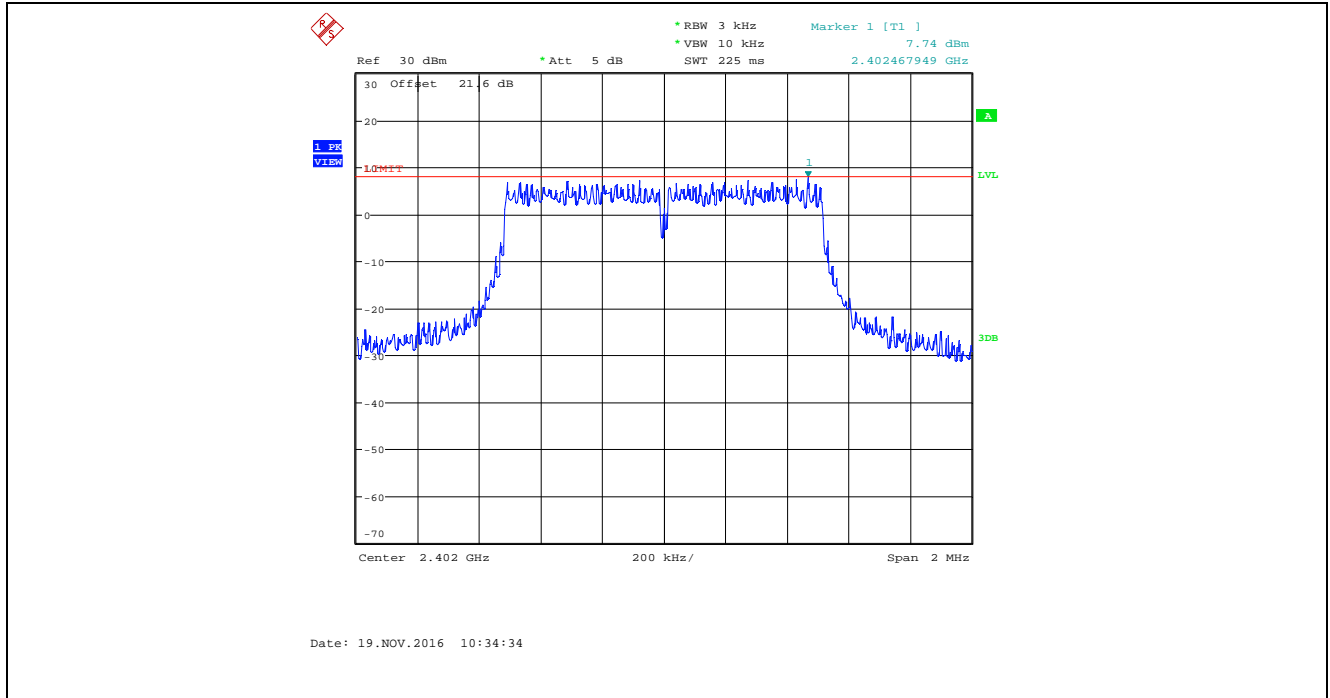

Plot 5.6.4.35. Power Spectral Density, Bandwidth: 1 MHz, TX Gain Setting: 43, Data Rate 4, 2442 MHz

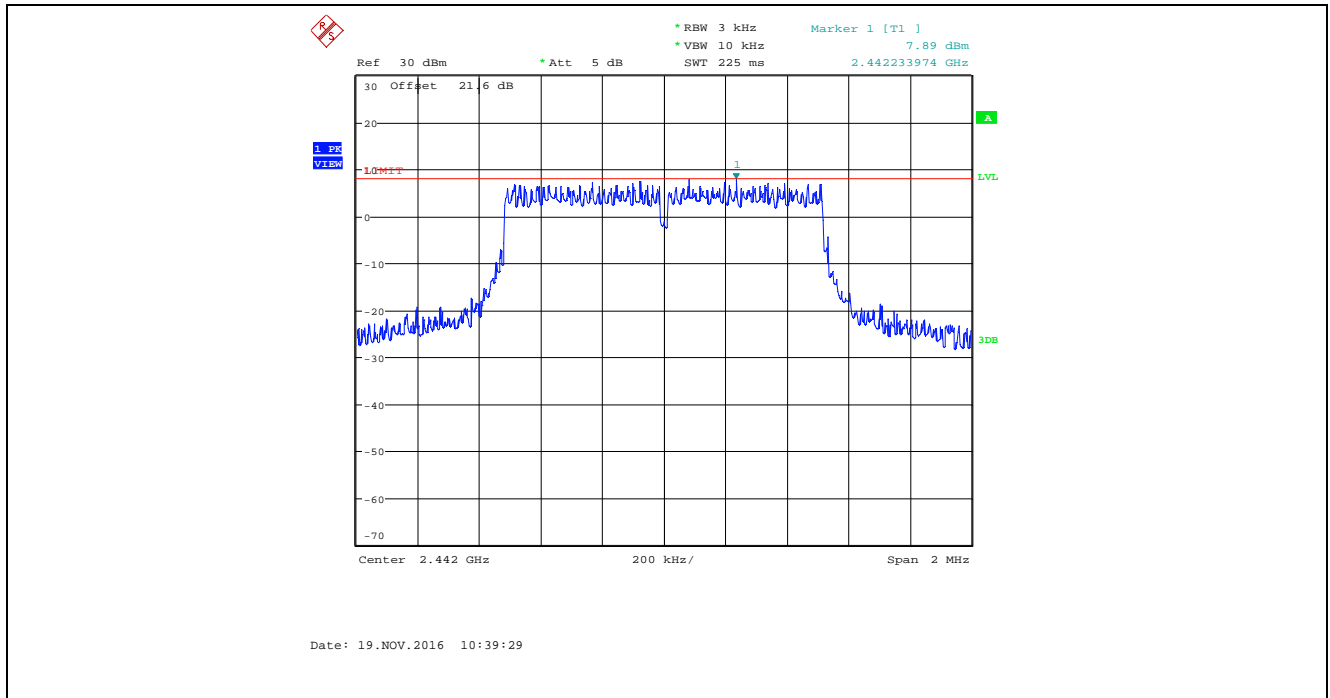

Plot 5.6.4.36. Power Spectral Density, Bandwidth: 1 MHz, TX Gain Setting: 43, Data Rate 4, 2482 MHz

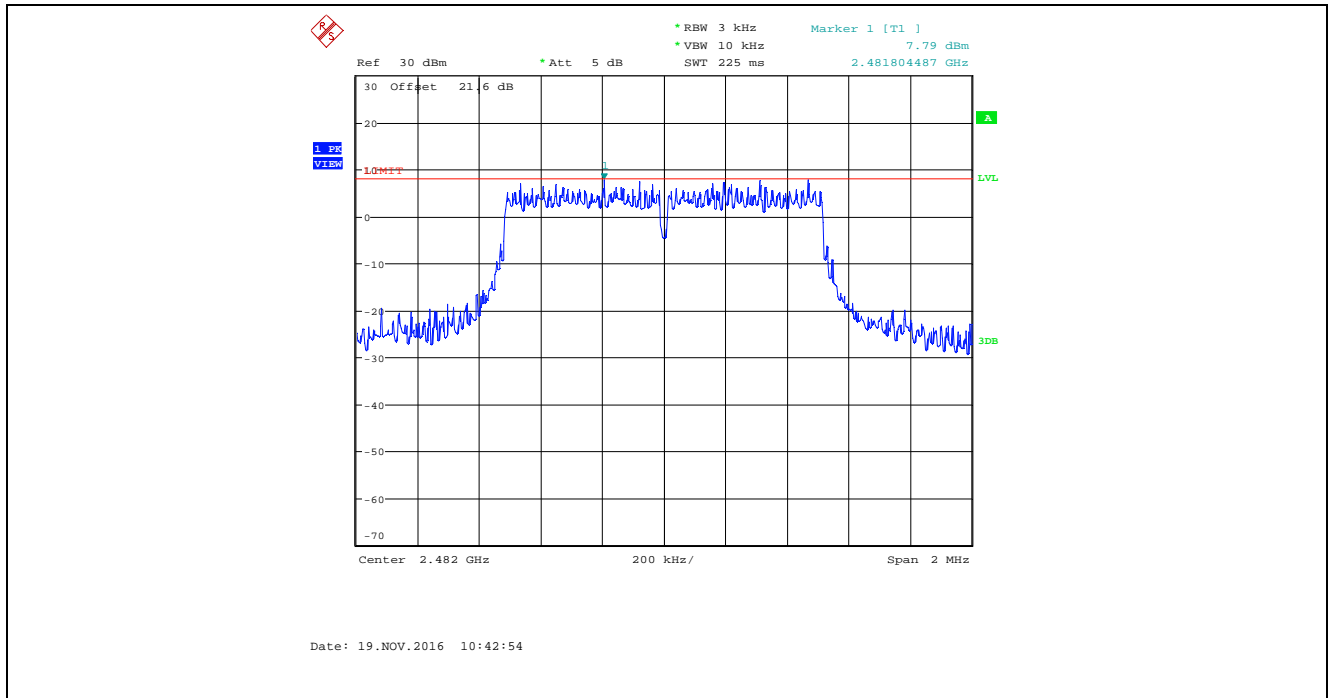

Plot 5.6.4.37. Power Spectral Density, Bandwidth: 1 MHz, TX Gain Setting: 43, Data Rate 5, 2402 MHz

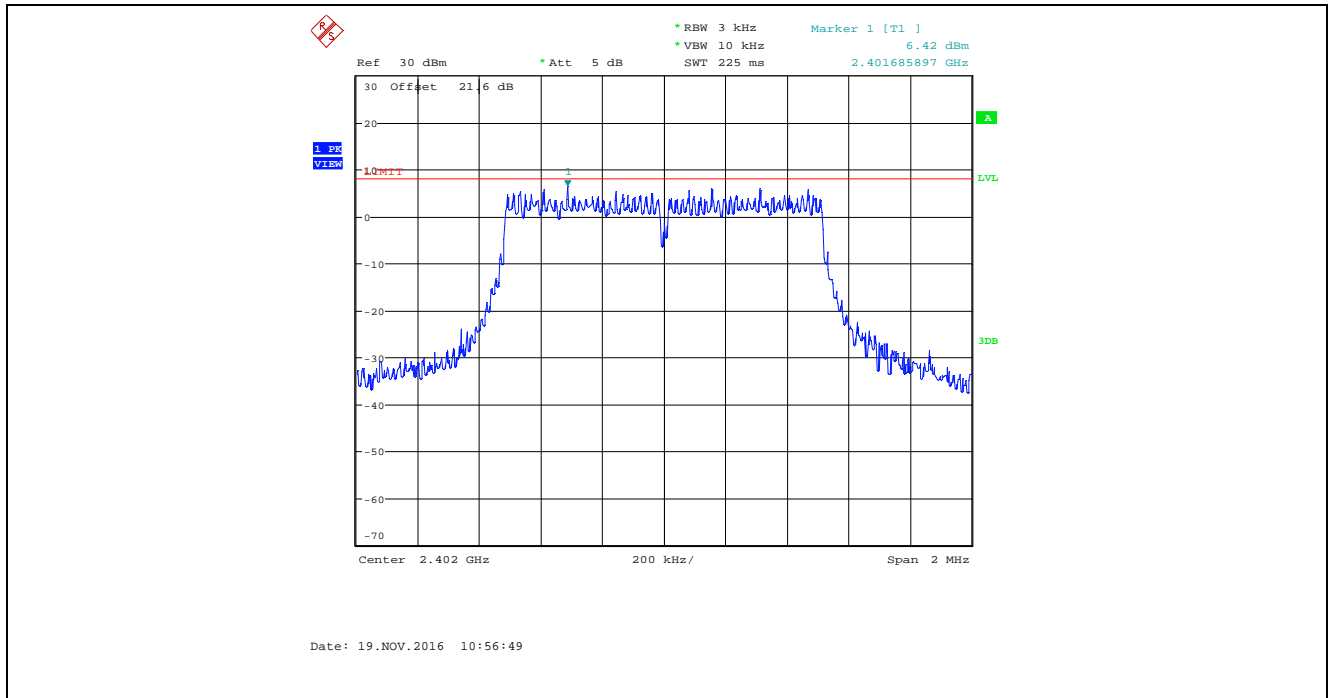

Plot 5.6.4.38. Power Spectral Density, Bandwidth: 1 MHz, TX Gain Setting: 43, Data Rate 5, 2442 MHz

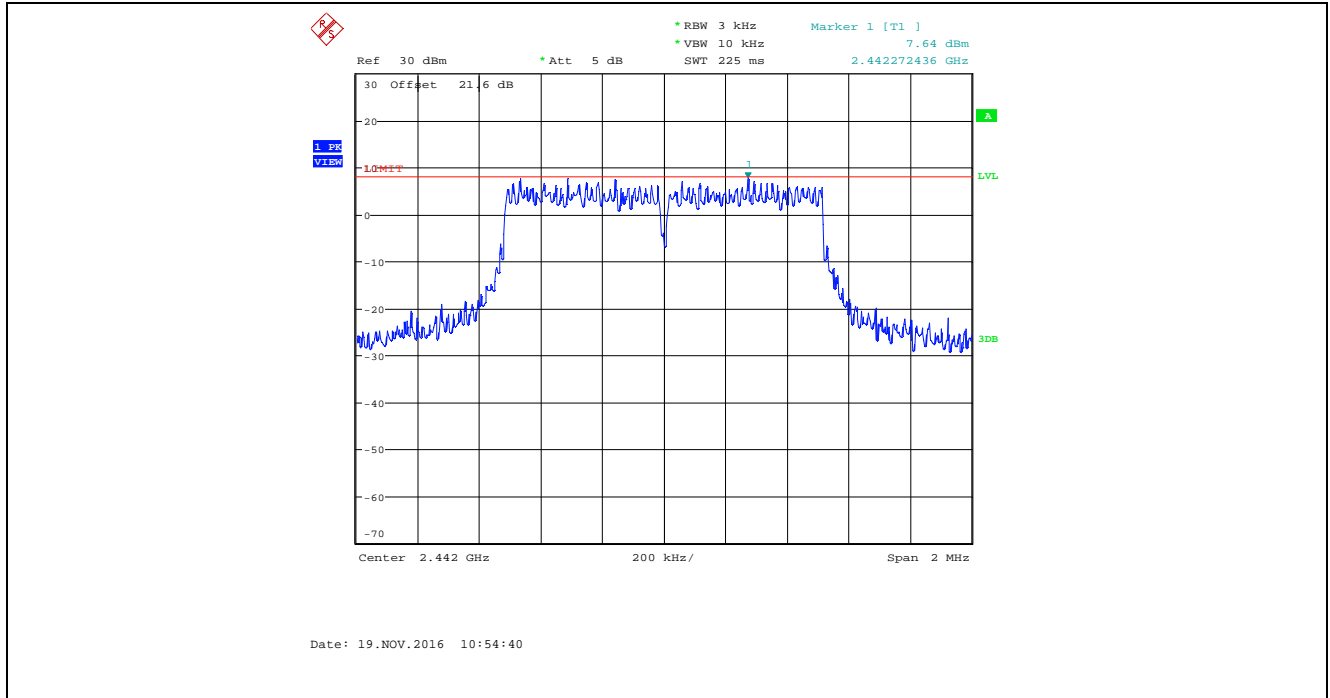

Plot 5.6.4.39. Power Spectral Density, Bandwidth: 1 MHz, TX Gain Setting: 43, Data Rate 5, 2482 MHz

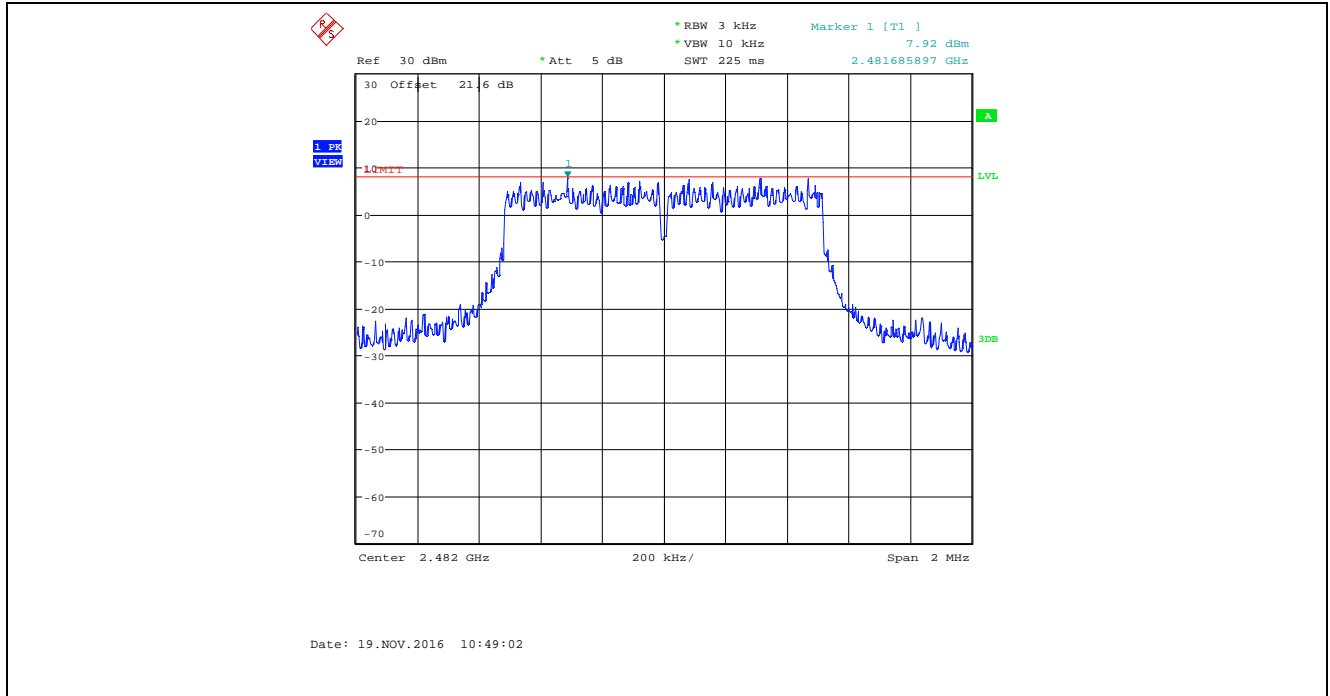



Plot 5.6.4.40. Power Spectral Density, Bandwidth: 1 MHz, TX Gain Setting: 43, Data Rate 6, 2402 MHz

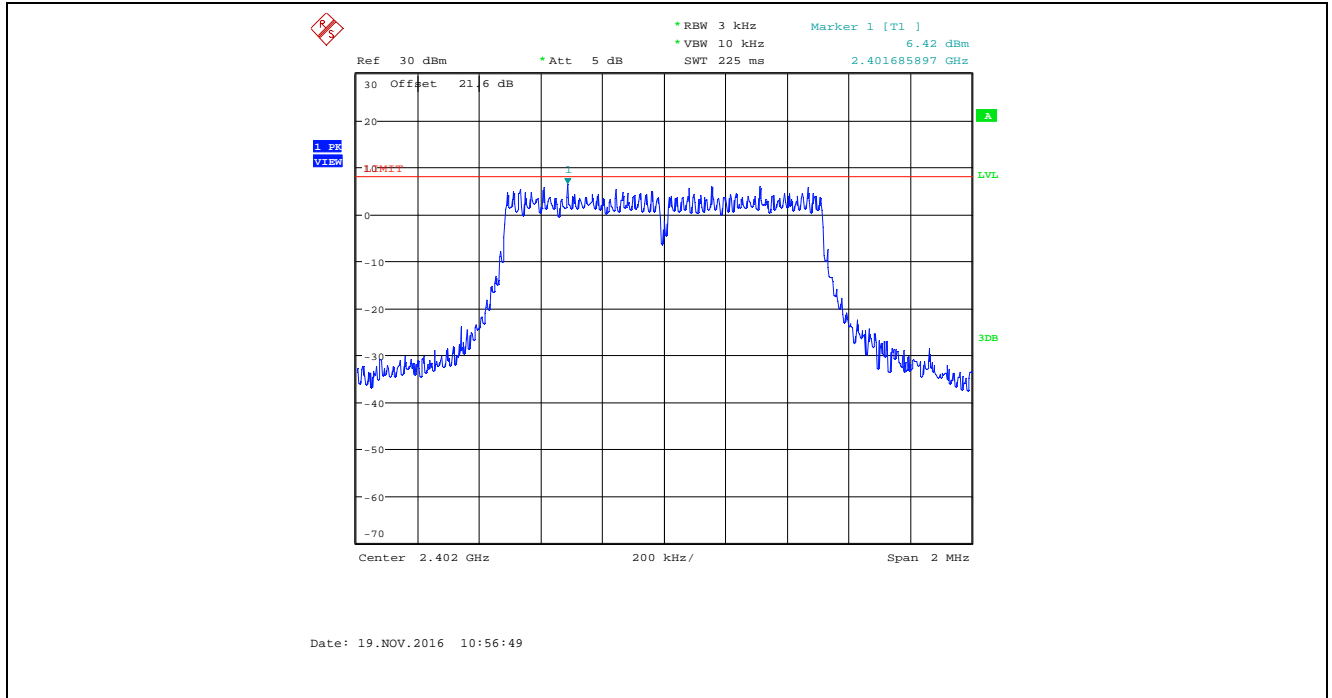

Plot 5.6.4.41. Power Spectral Density, Bandwidth: 1 MHz, TX Gain Setting: 43, Data Rate 6, 2442 MHz

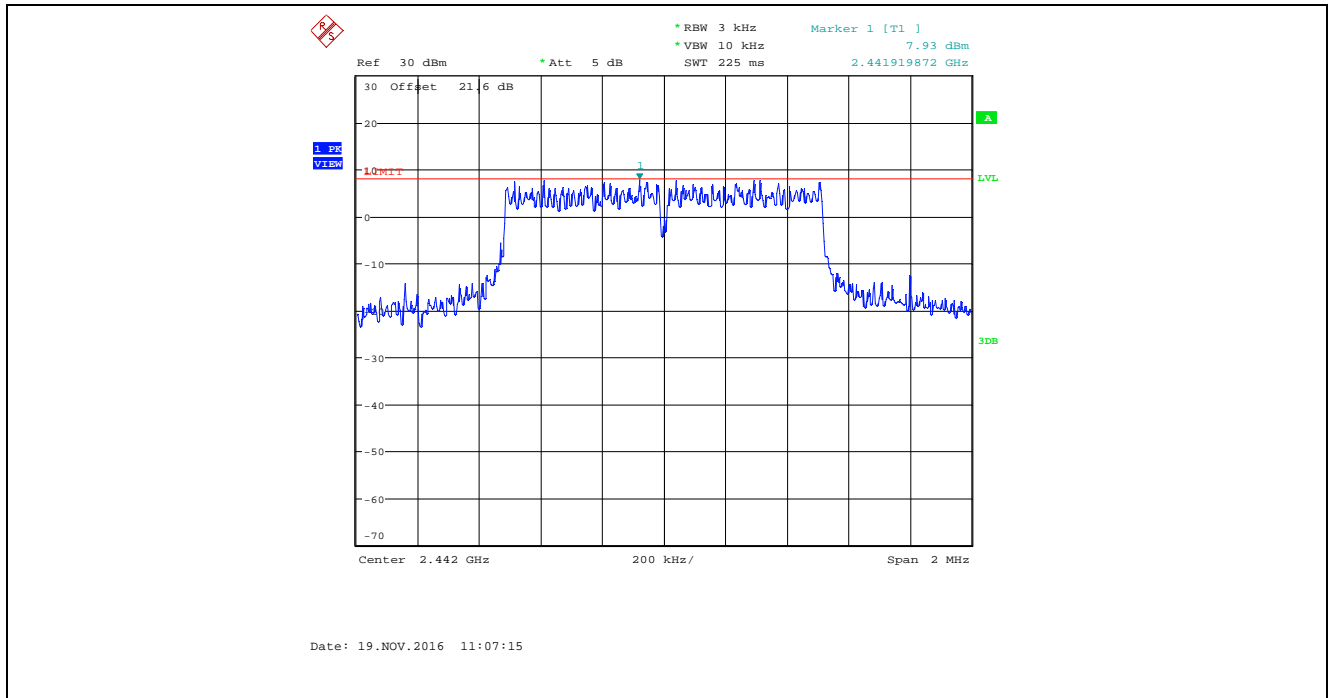

Plot 5.6.4.42. Power Spectral Density, Bandwidth: 1 MHz, TX Gain Setting: 43, Data Rate 6, 2482 MHz

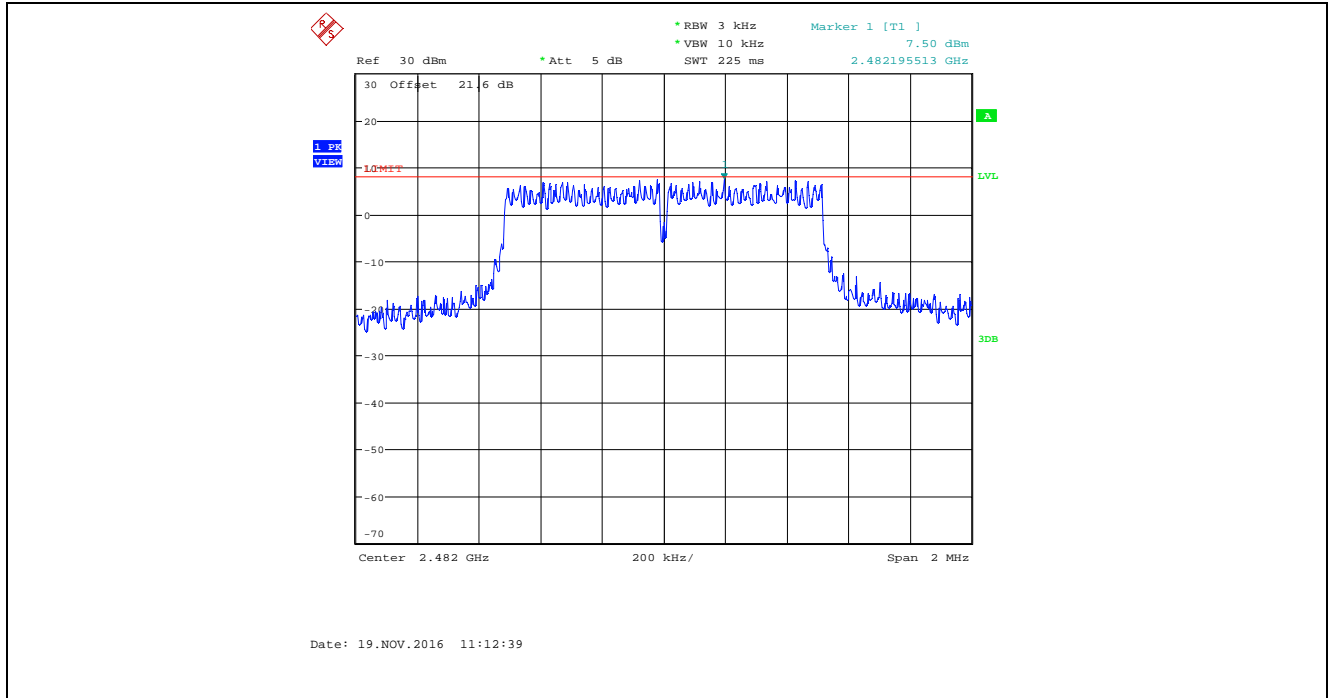

Plot 5.6.4.43. Power Spectral Density, Bandwidth: 1 MHz, TX Gain Setting: 43, Data Rate 7, 2402 MHz

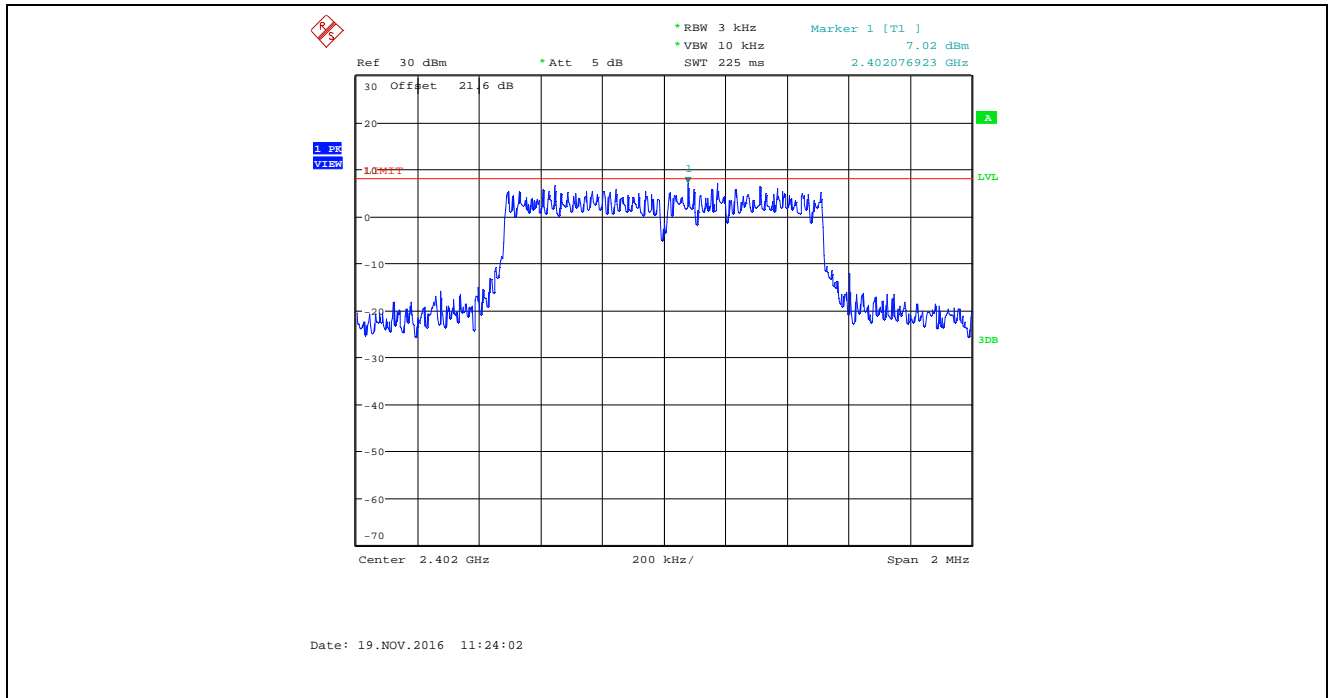

Plot 5.6.4.44. Power Spectral Density, Bandwidth: 1 MHz, TX Gain Setting: 43, Data Rate 7, 2442 MHz

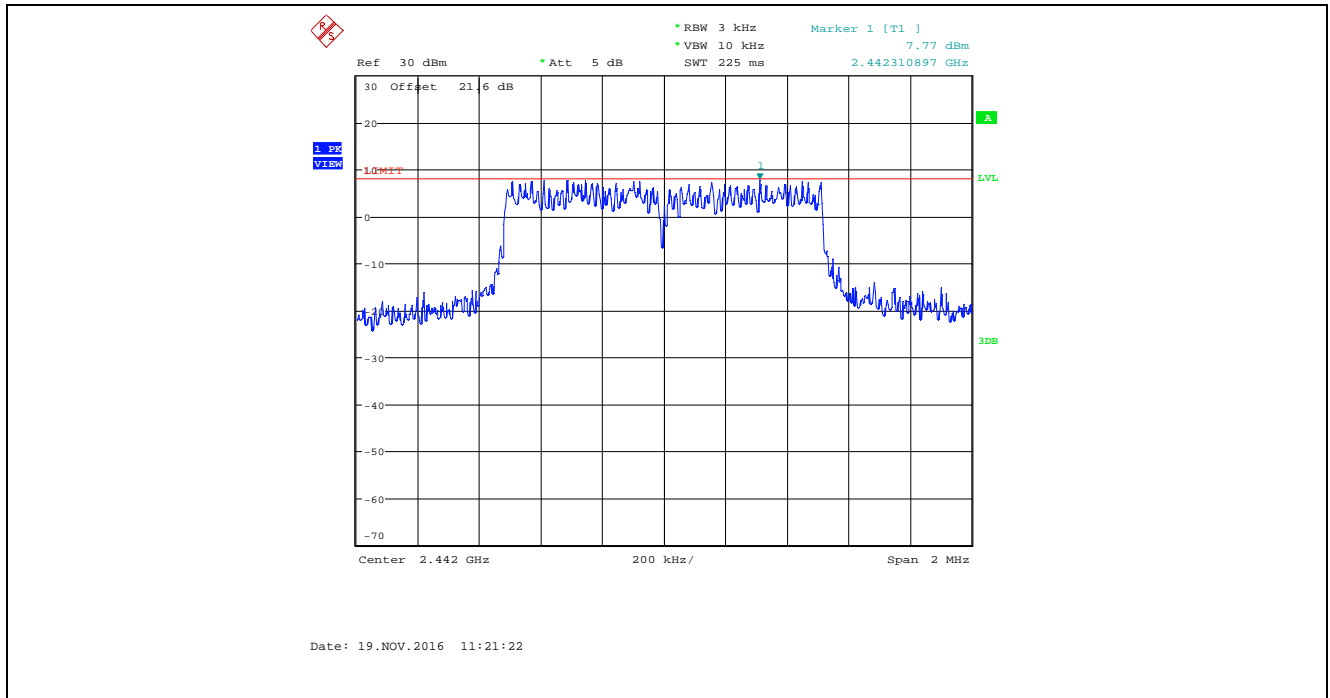

Plot 5.6.4.45. Power Spectral Density, Bandwidth: 1 MHz, TX Gain Setting: 43, Data Rate 7, 2482 MHz

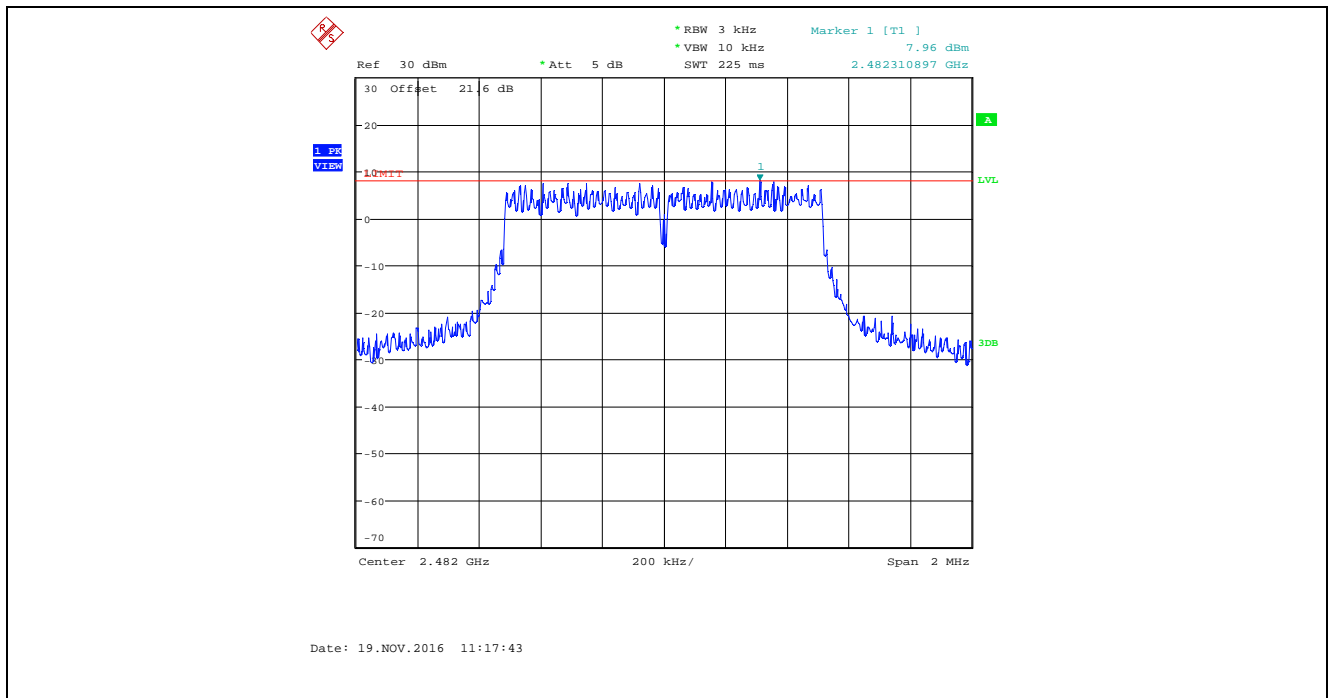

Plot 5.6.4.46. Power Spectral Density, Bandwidth: 2 MHz, TX Gain Setting: 45, Data Rate 4, 2402 MHz

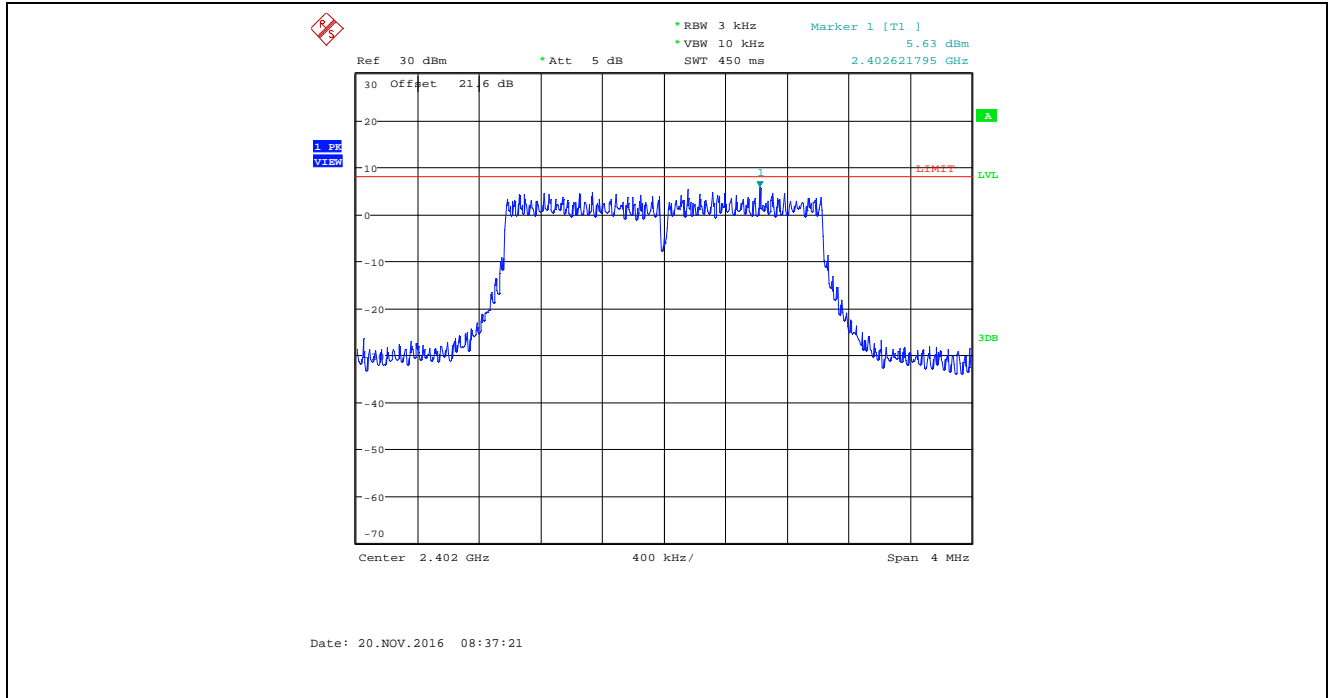

Plot 5.6.4.47. Power Spectral Density, Bandwidth: 2 MHz, TX Gain Setting: 45, Data Rate 4, 2442 MHz

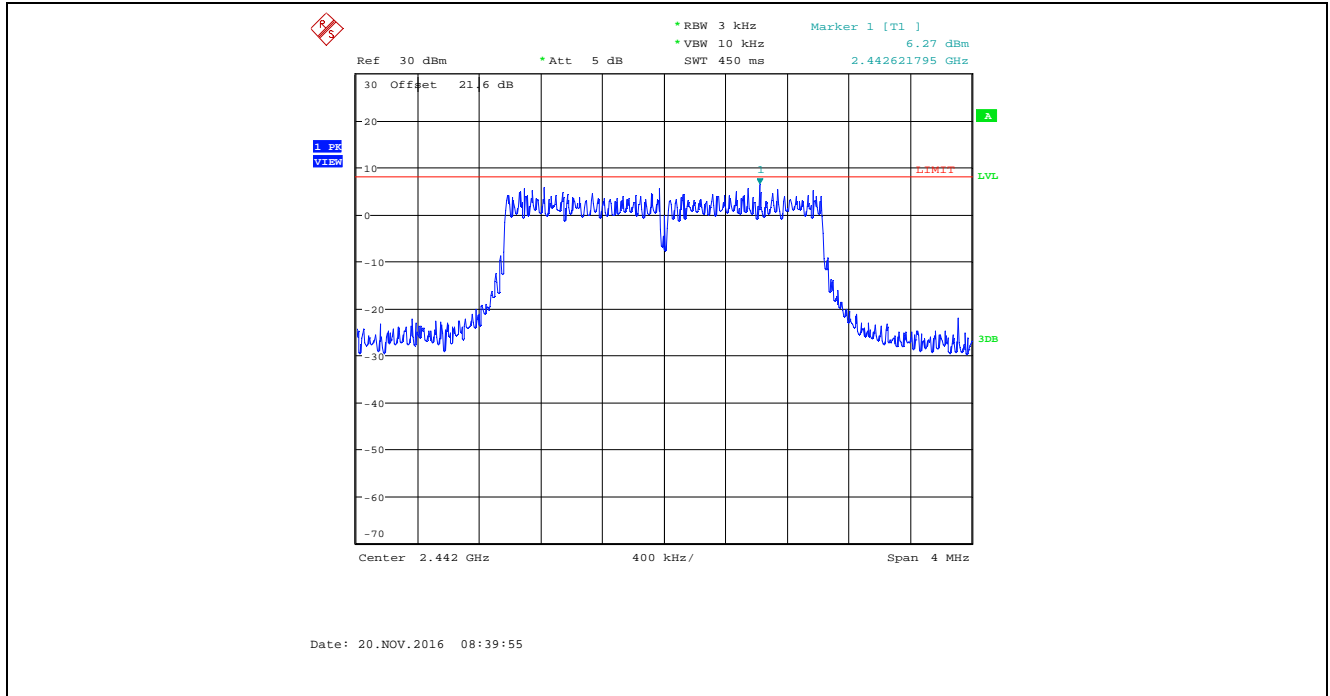

Plot 5.6.4.48. Power Spectral Density, Bandwidth: 2 MHz, TX Gain Setting: 45, Data Rate 4, 2482 MHz

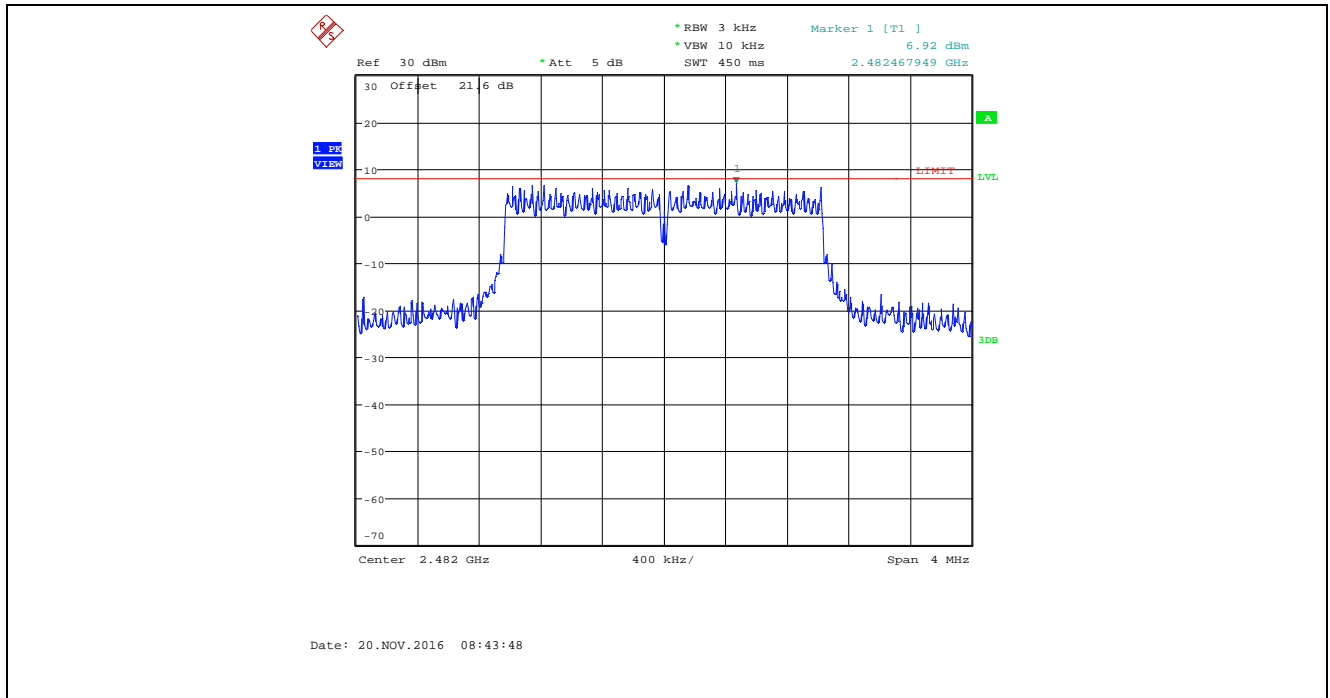

Plot 5.6.4.49. Power Spectral Density, Bandwidth: 2 MHz, TX Gain Setting: 45, Data Rate 5, 2402 MHz

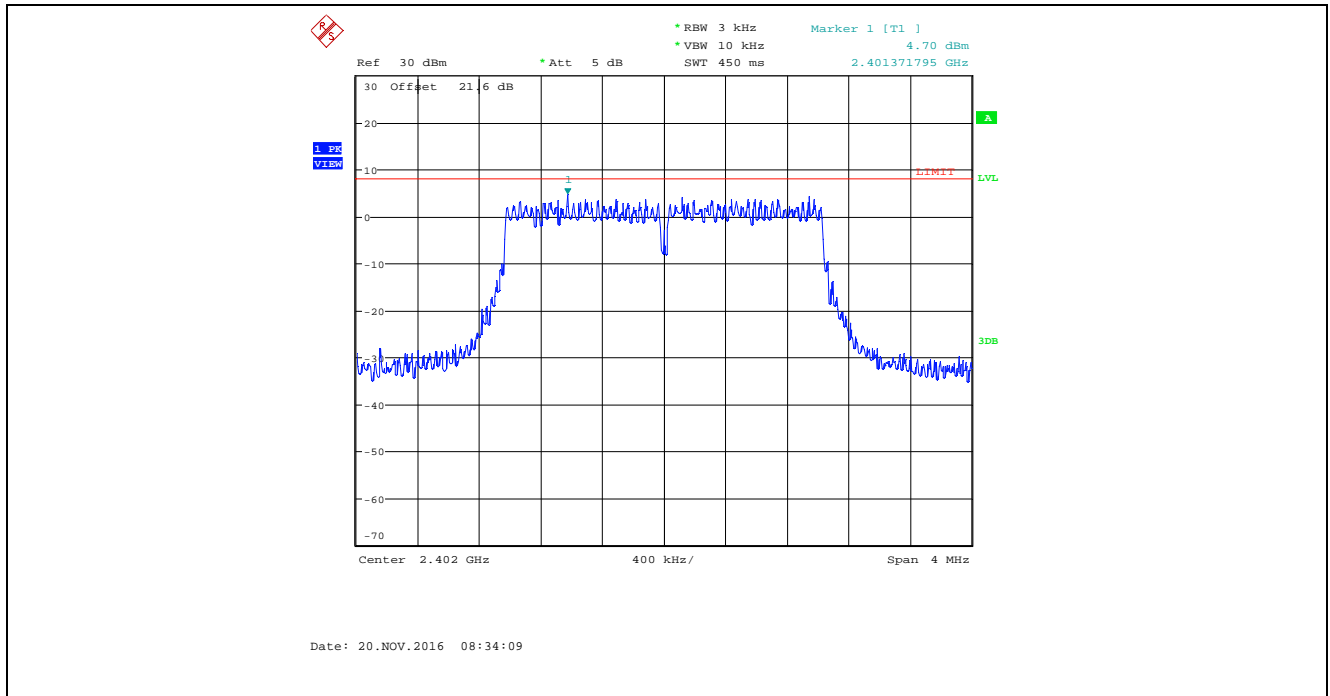

Plot 5.6.4.50. Power Spectral Density, Bandwidth: 2 MHz, TX Gain Setting: 45, Data Rate 5, 2442 MHz

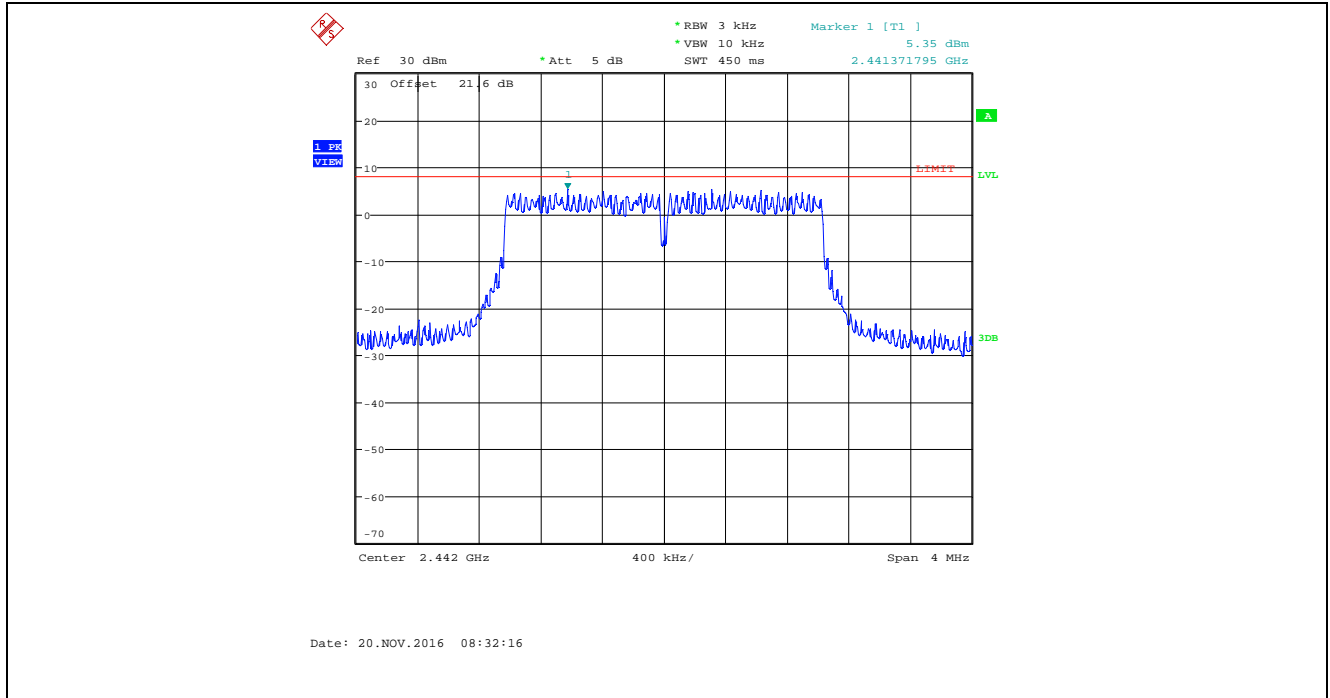

Plot 5.6.4.51. Power Spectral Density, Bandwidth: 2 MHz, TX Gain Setting: 45, Data Rate 5, 2482 MHz

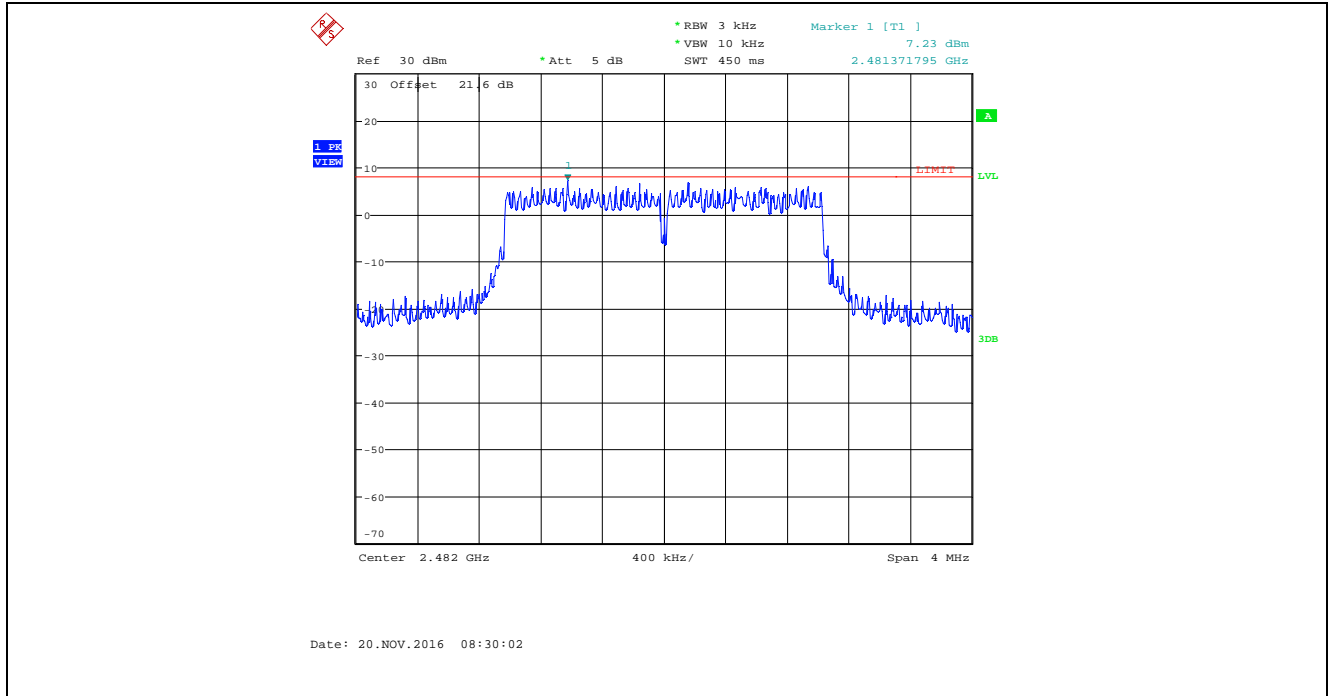

Plot 5.6.4.52. Power Spectral Density, Bandwidth: 2 MHz, TX Gain Setting: 45, Data Rate 6, 2402 MHz

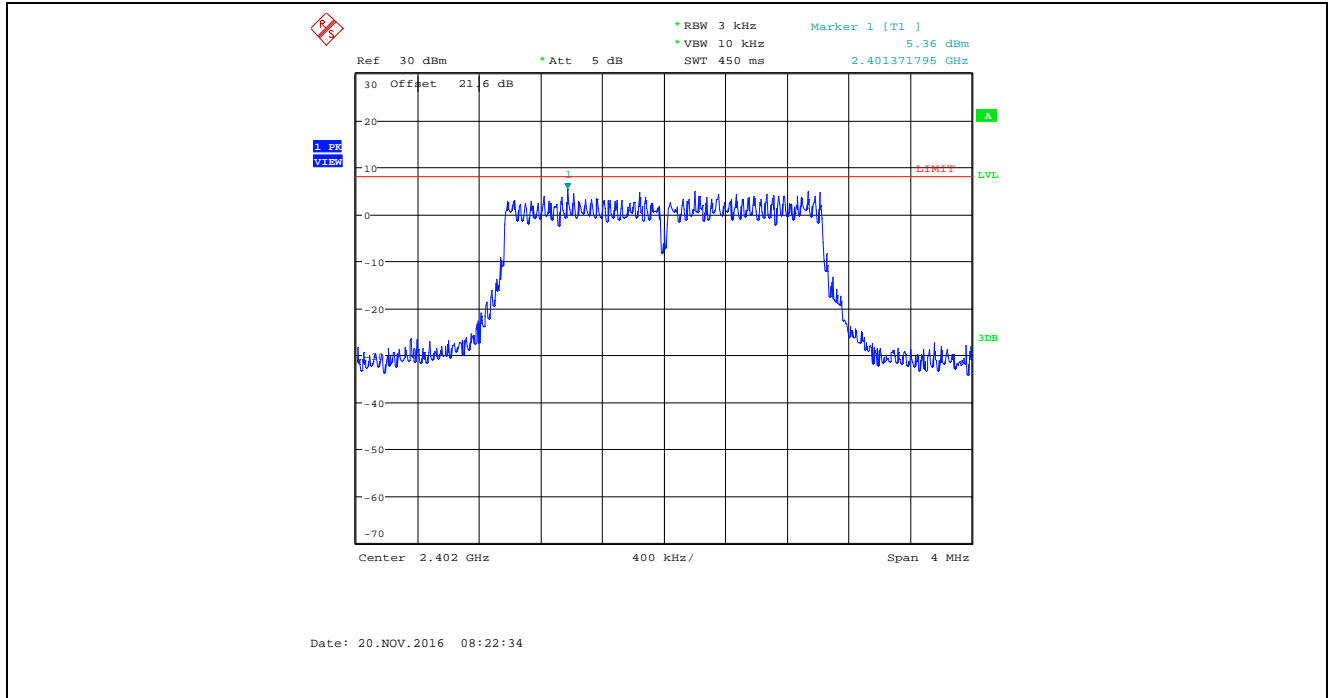

Plot 5.6.4.53. Power Spectral Density, Bandwidth: 2 MHz, TX Gain Setting: 45, Data Rate 6, 2442 MHz

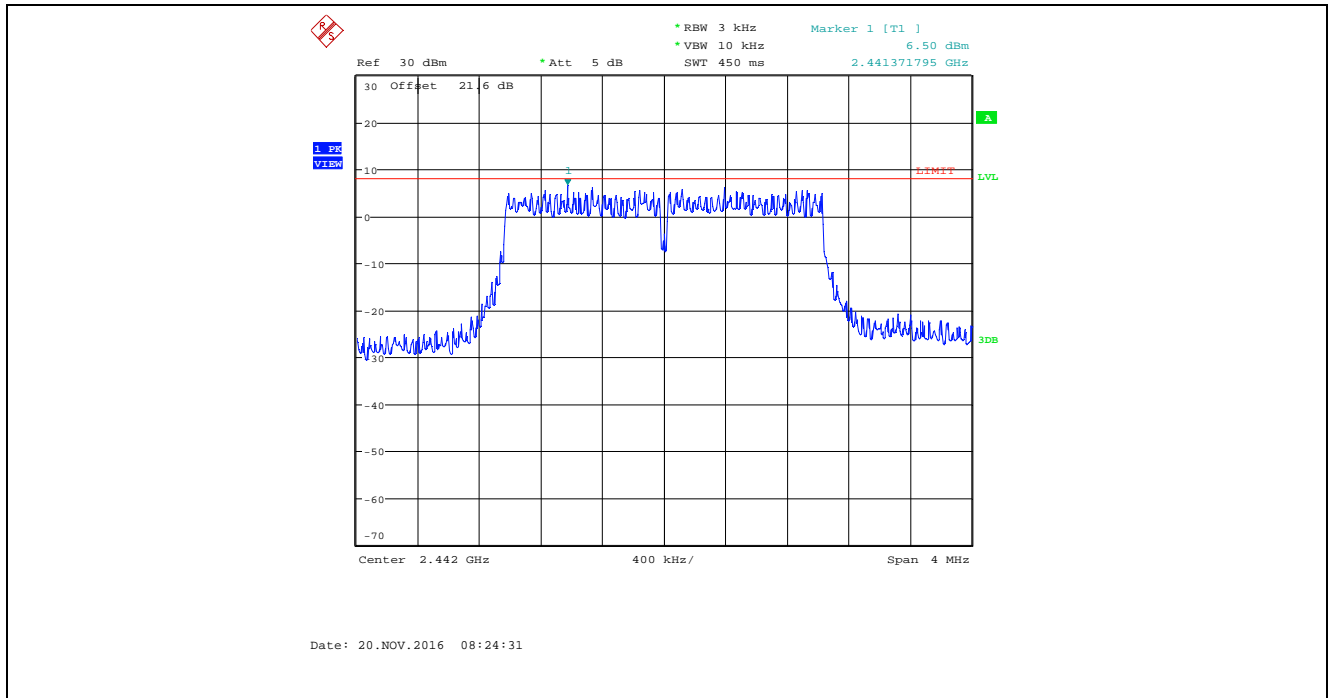

Plot 5.6.4.54. Power Spectral Density, Bandwidth: 2 MHz, TX Gain Setting: 45, Data Rate 6, 2482 MHz

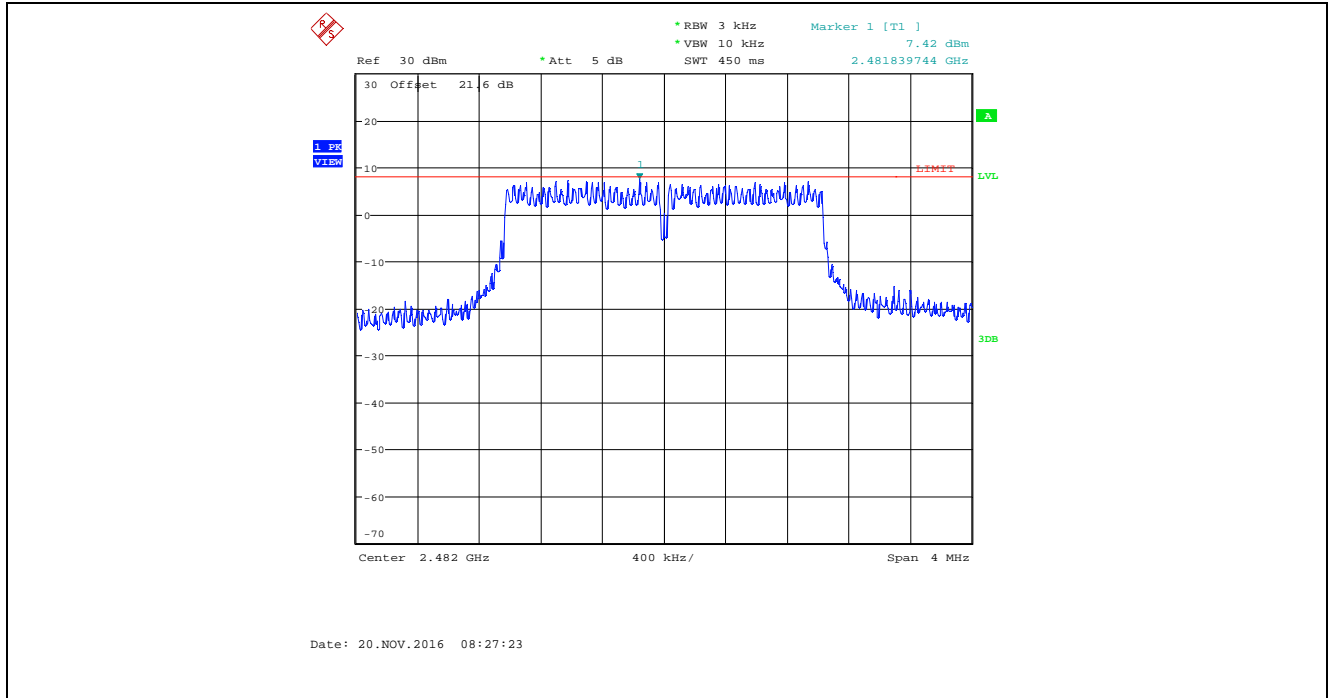

Plot 5.6.4.55. Power Spectral Density, Bandwidth: 2 MHz, TX Gain Setting: 45, Data Rate 7, 2402 MHz

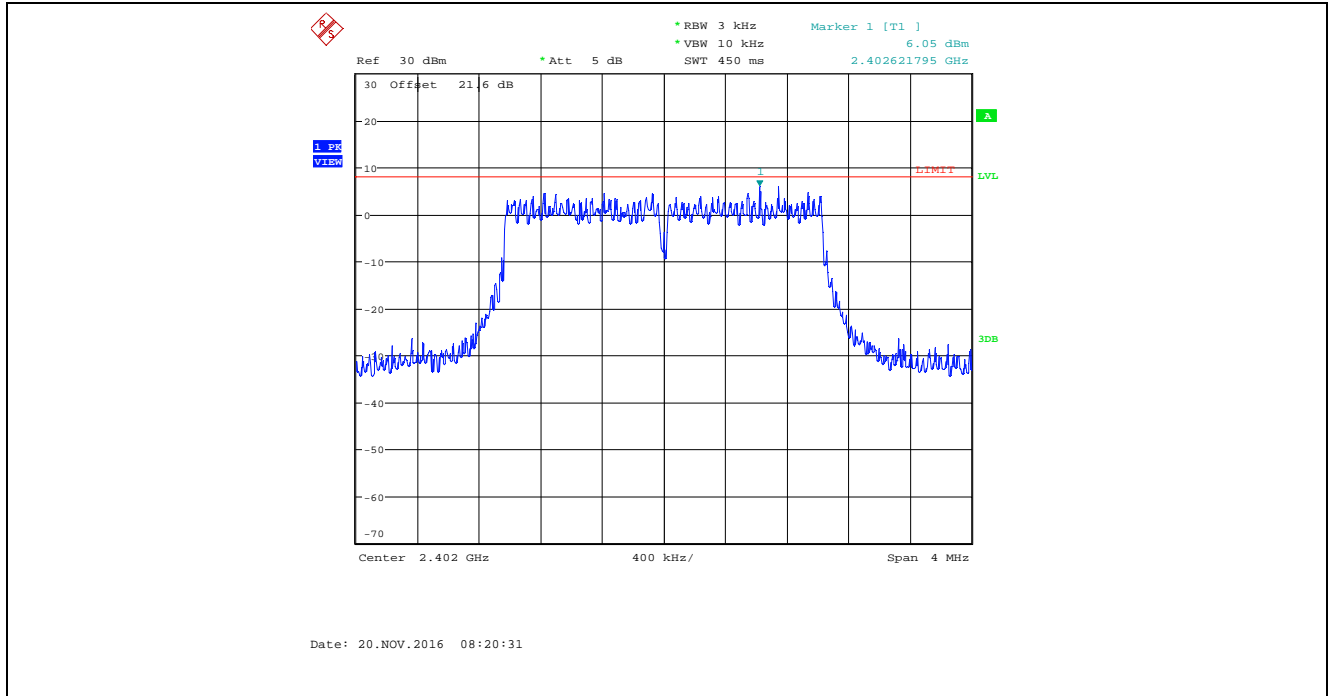



Plot 5.6.4.56. Power Spectral Density, Bandwidth: 2 MHz, TX Gain Setting: 45, Data Rate 7, 2442 MHz

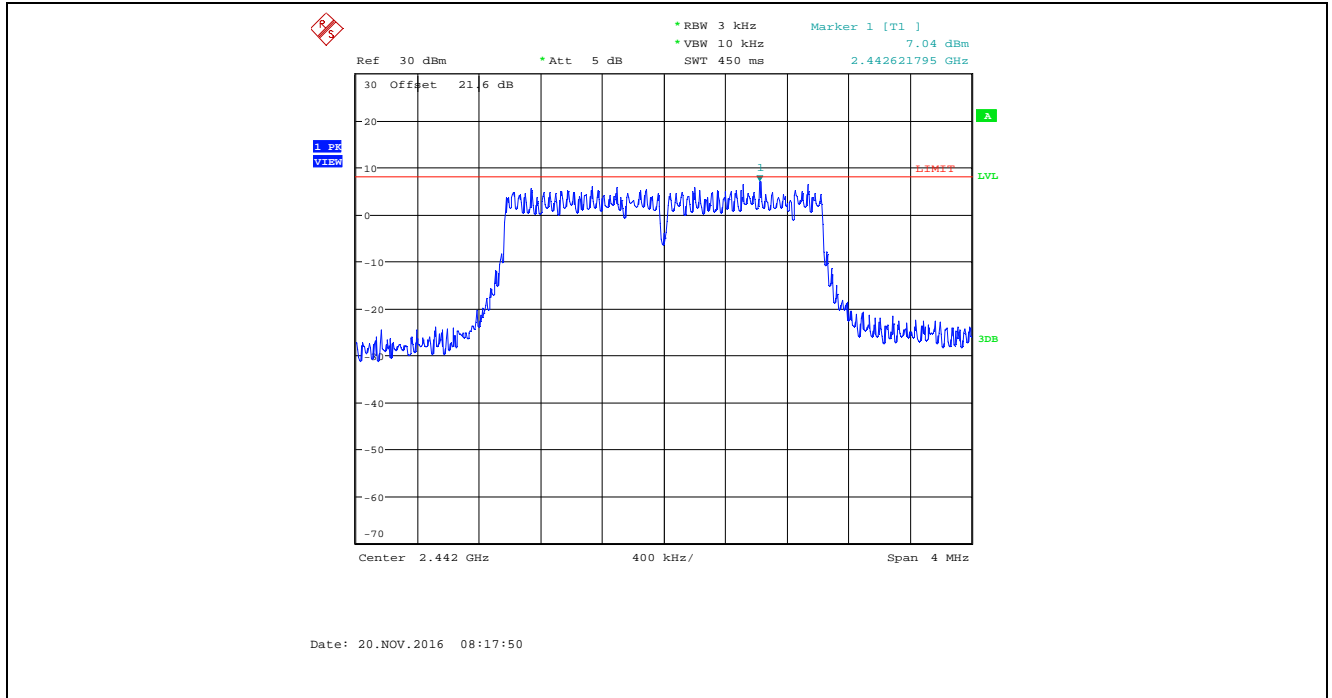

Plot 5.6.4.57. Power Spectral Density, Bandwidth: 2 MHz, TX Gain Setting: 45, Data Rate 7, 2482 MHz

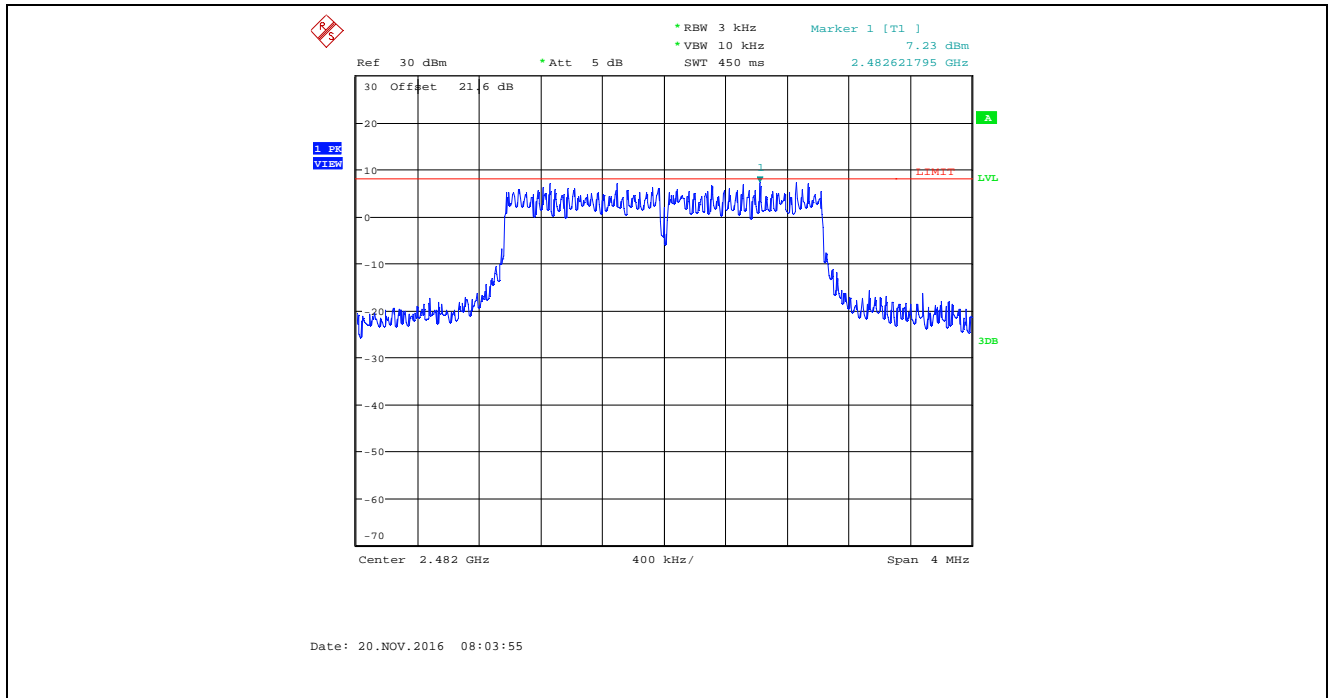

Plot 5.6.4.58. Power Spectral Density, Bandwidth: 4 MHz, TX Gain Setting: 50, Data Rate 4, 2403 MHz

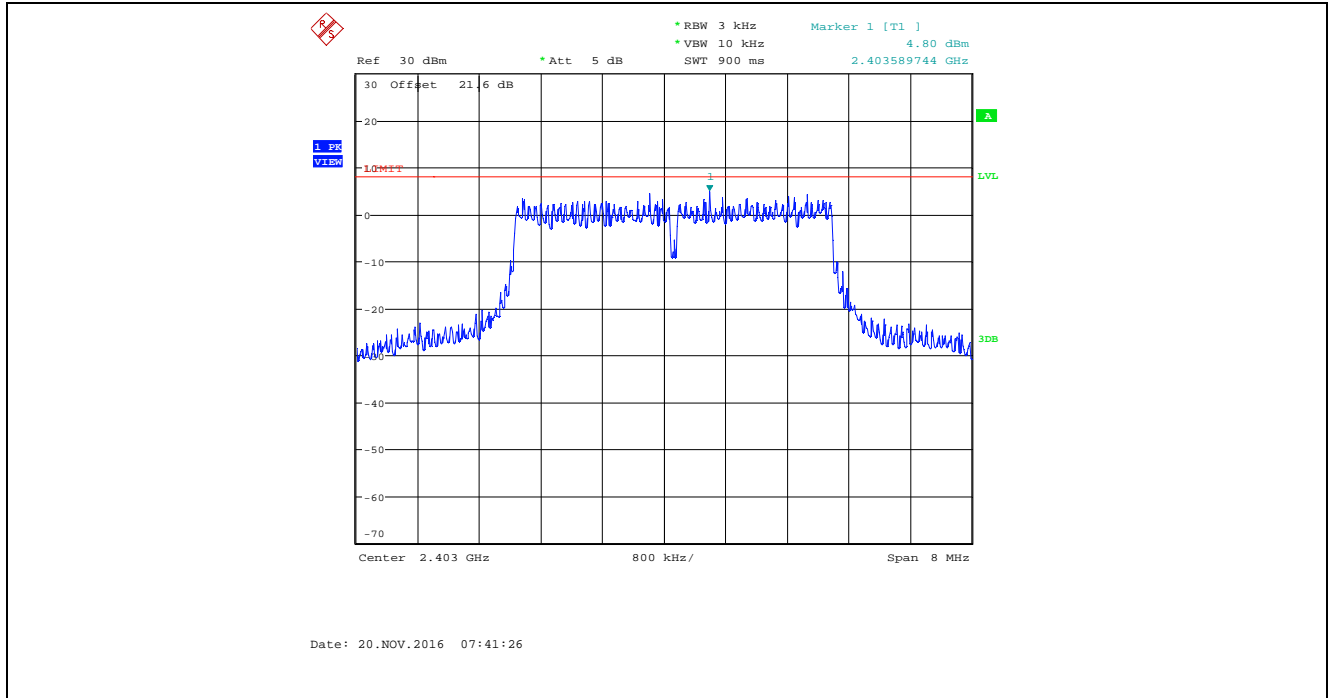

Plot 5.6.4.59. Power Spectral Density, Bandwidth: 4 MHz, TX Gain Setting: 50, Data Rate 4, 2442 MHz

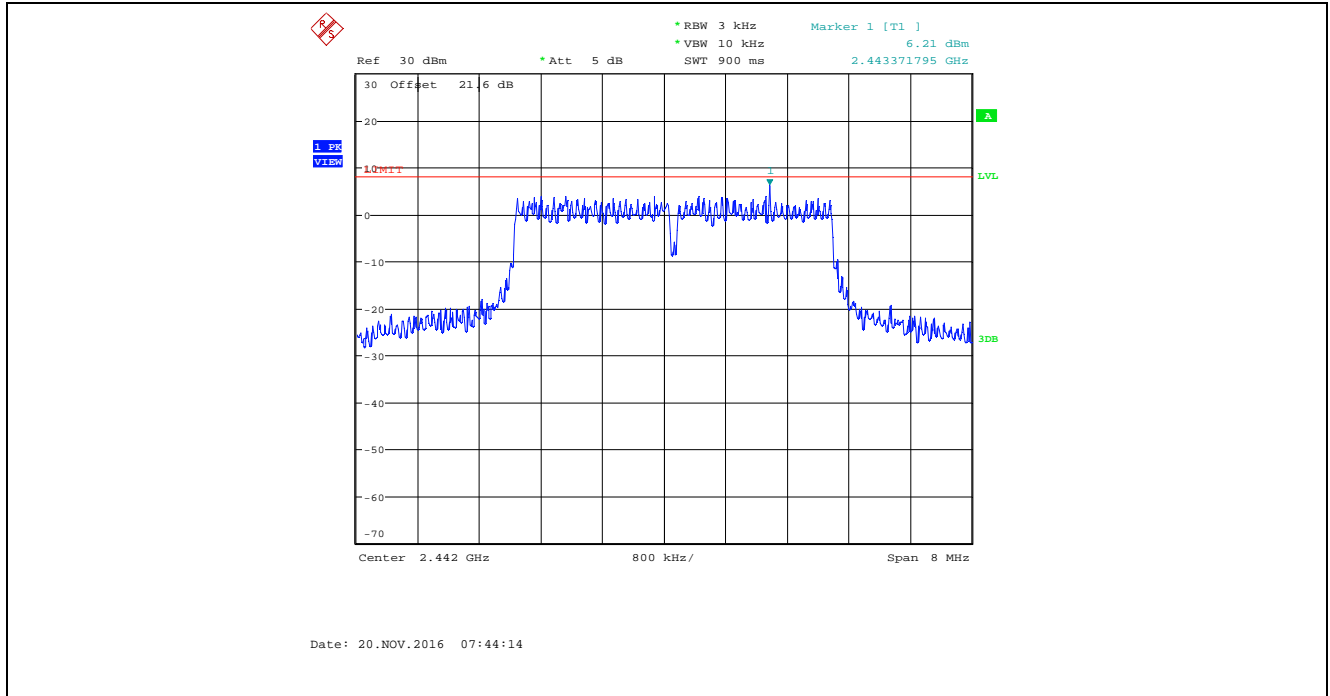

Plot 5.6.4.60. Power Spectral Density, Bandwidth: 4 MHz, TX Gain Setting: 50, Data Rate 4, 2480 MHz

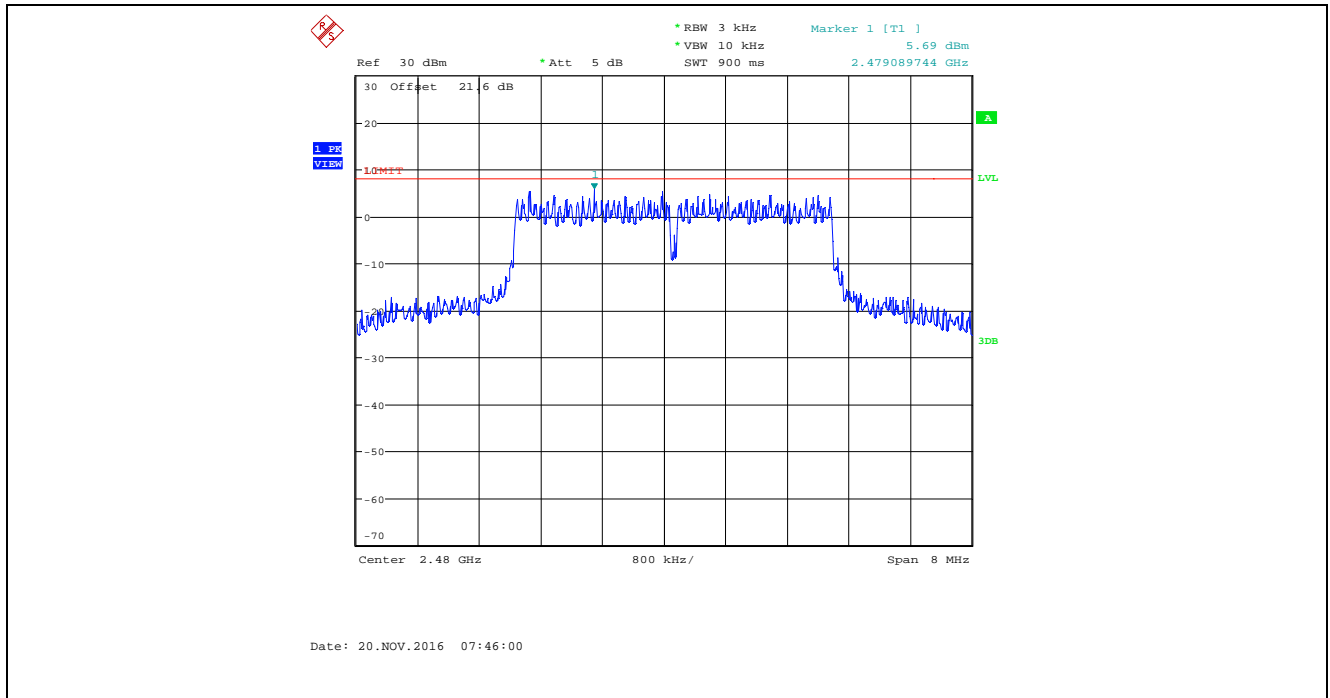

Plot 5.6.4.61. Power Spectral Density, Bandwidth: 4 MHz, TX Gain Setting: 50, Data Rate 5, 2403 MHz

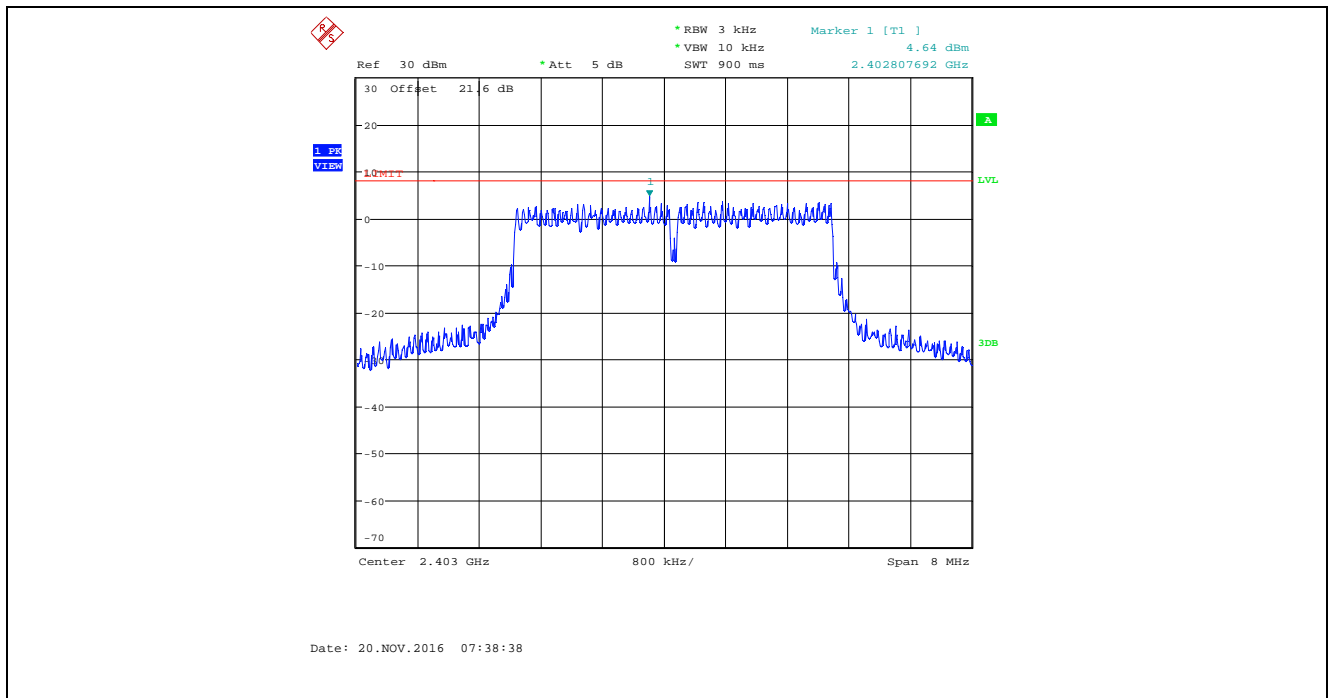

Plot 5.6.4.62. Power Spectral Density, Bandwidth: 4 MHz, TX Gain Setting: 50, Data Rate 5, 2442 MHz

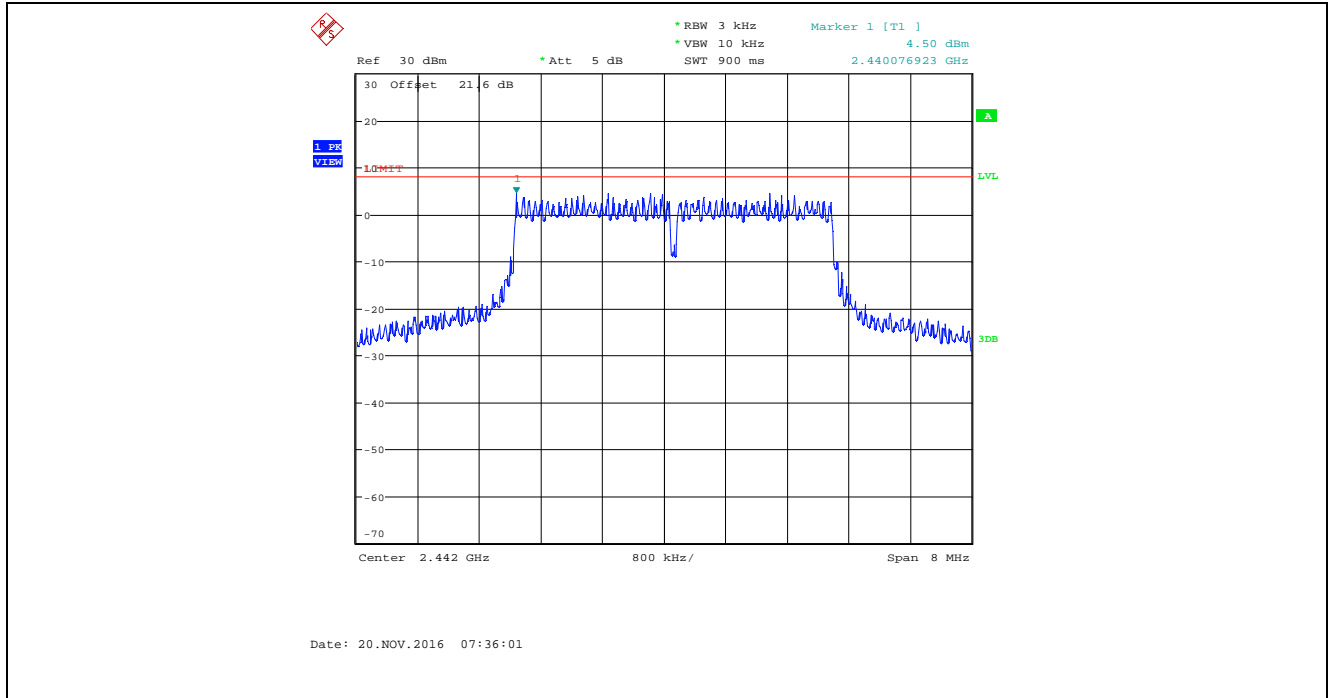

Plot 5.6.4.63. Power Spectral Density, Bandwidth: 4 MHz, TX Gain Setting: 50, Data Rate 5, 2480 MHz

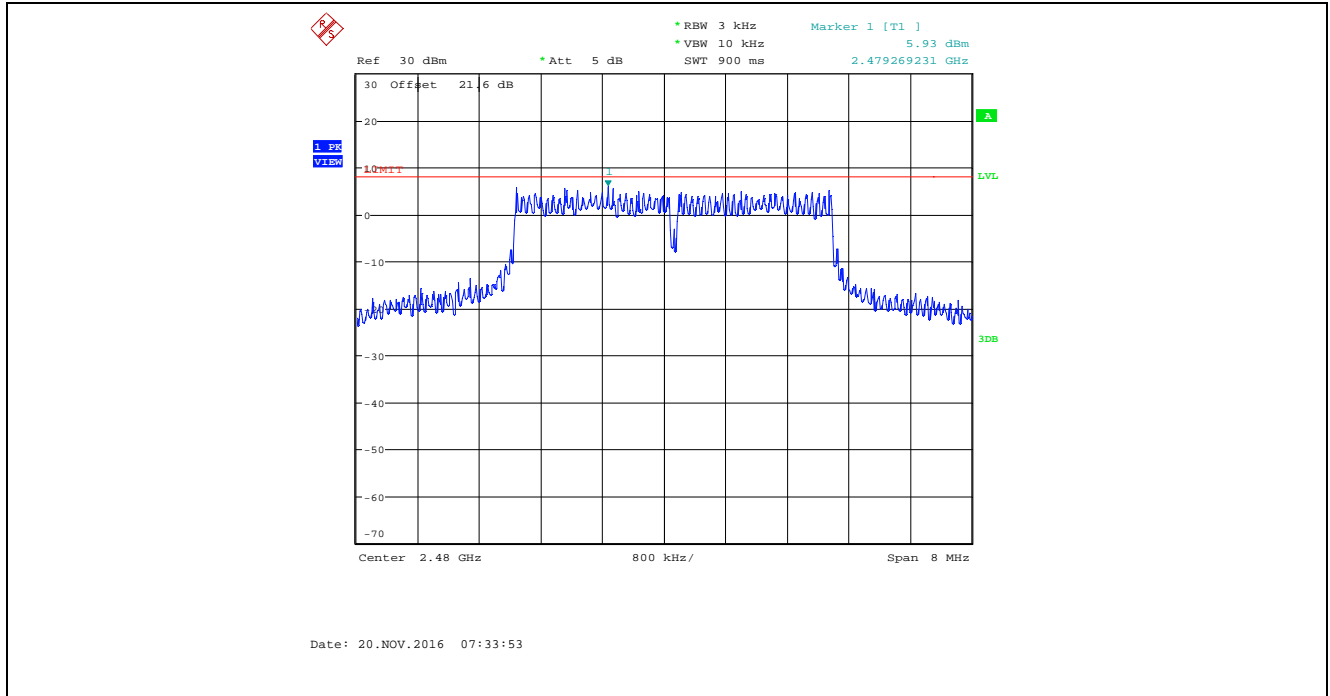

Plot 5.6.4.64. Power Spectral Density, Bandwidth: 4 MHz, TX Gain Setting: 50, Data Rate 6, 2403 MHz

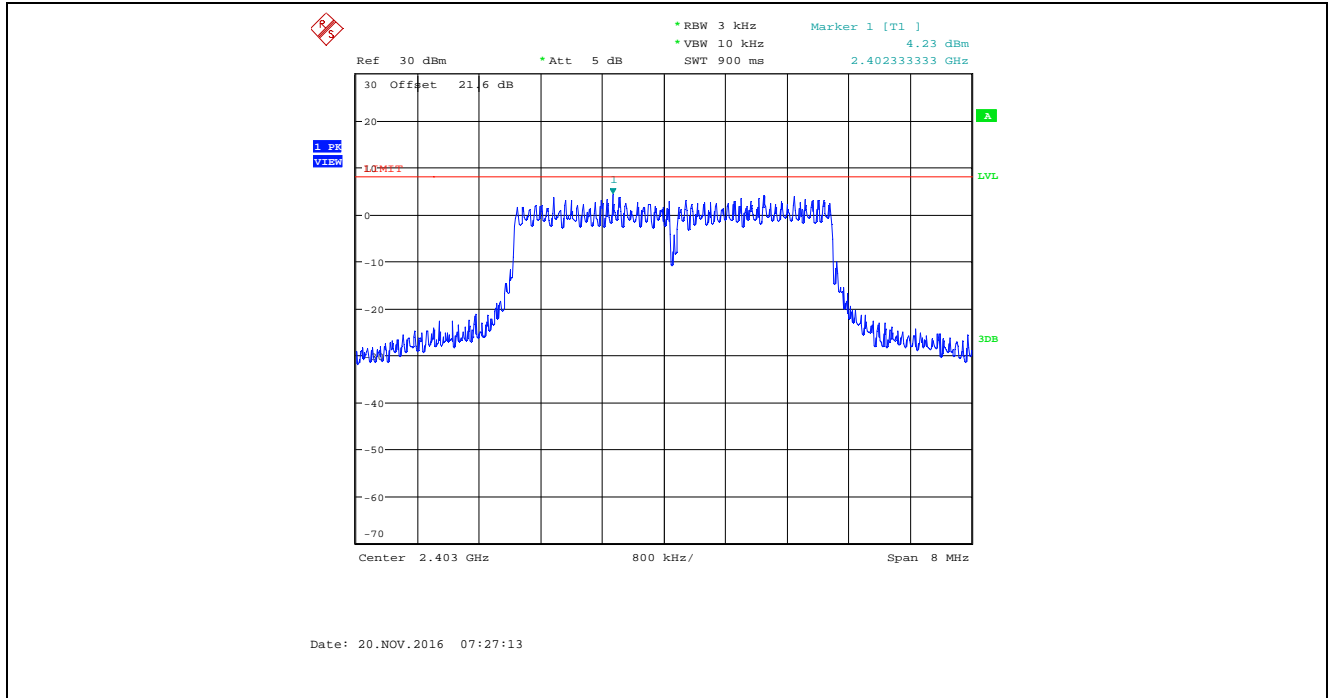

Plot 5.6.4.65. Power Spectral Density, Bandwidth: 4 MHz, TX Gain Setting: 50, Data Rate 6, 2442 MHz

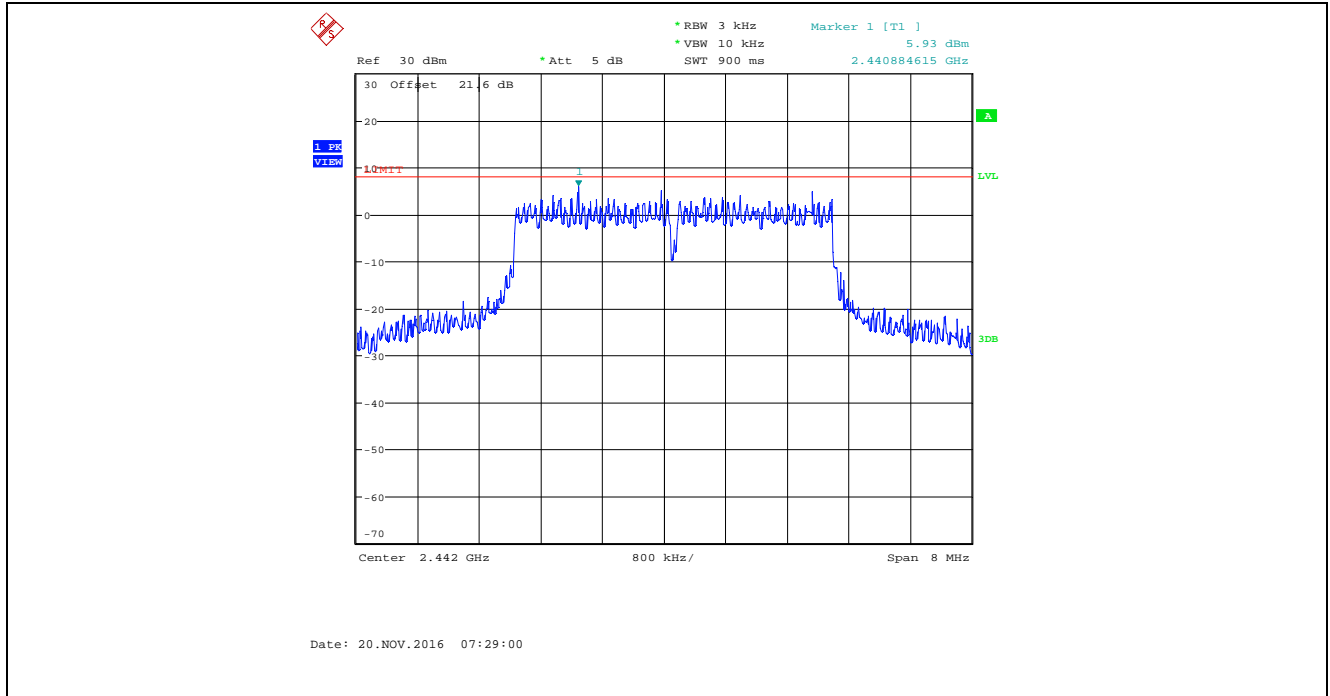

Plot 5.6.4.66. Power Spectral Density, Bandwidth: 4 MHz, TX Gain Setting: 50, Data Rate 6, 2480 MHz

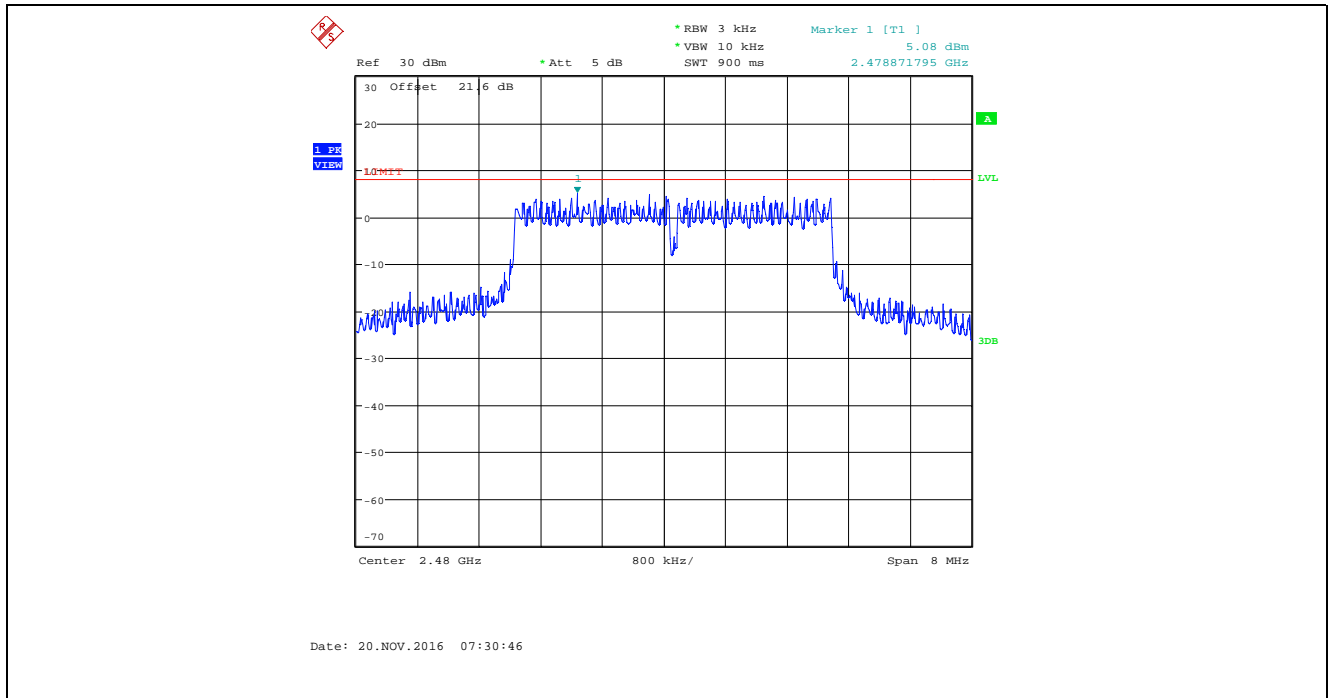

Plot 5.6.4.67. Power Spectral Density, Bandwidth: 4 MHz, TX Gain Setting: 50, Data Rate 7, 2403 MHz

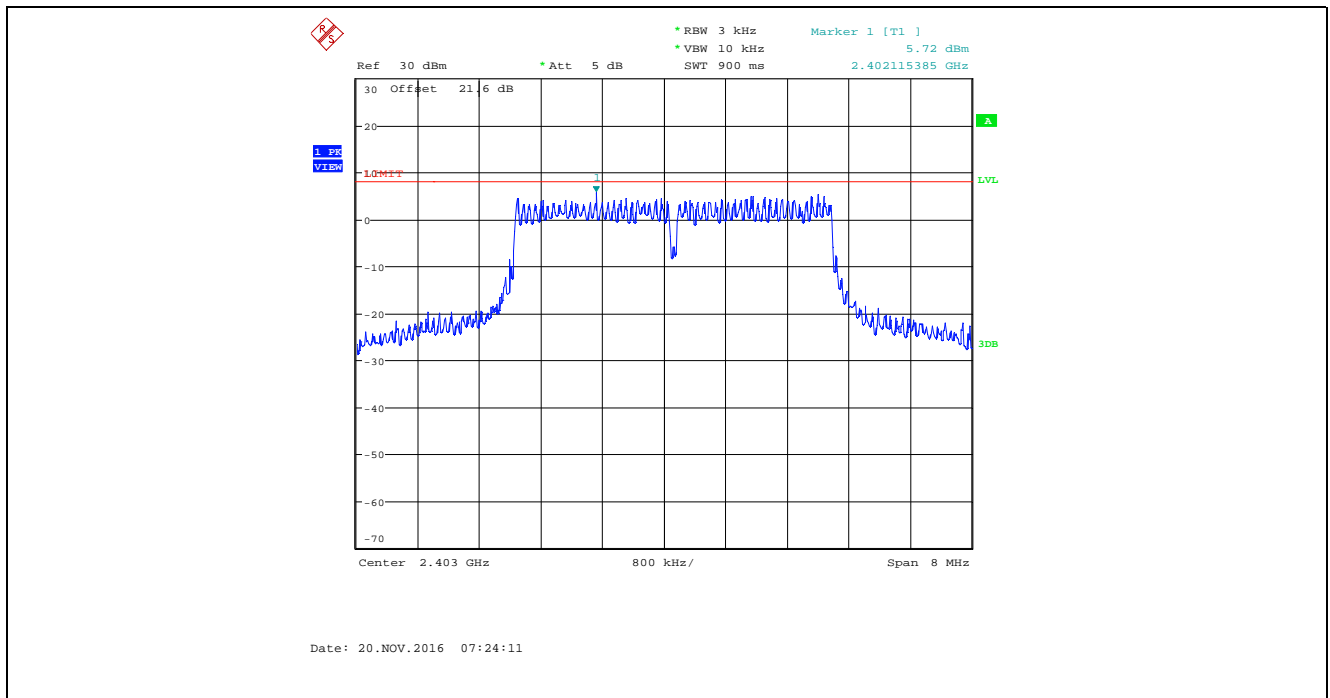

Plot 5.6.4.68. Power Spectral Density, Bandwidth: 4 MHz, TX Gain Setting: 50, Data Rate 7, 2442 MHz

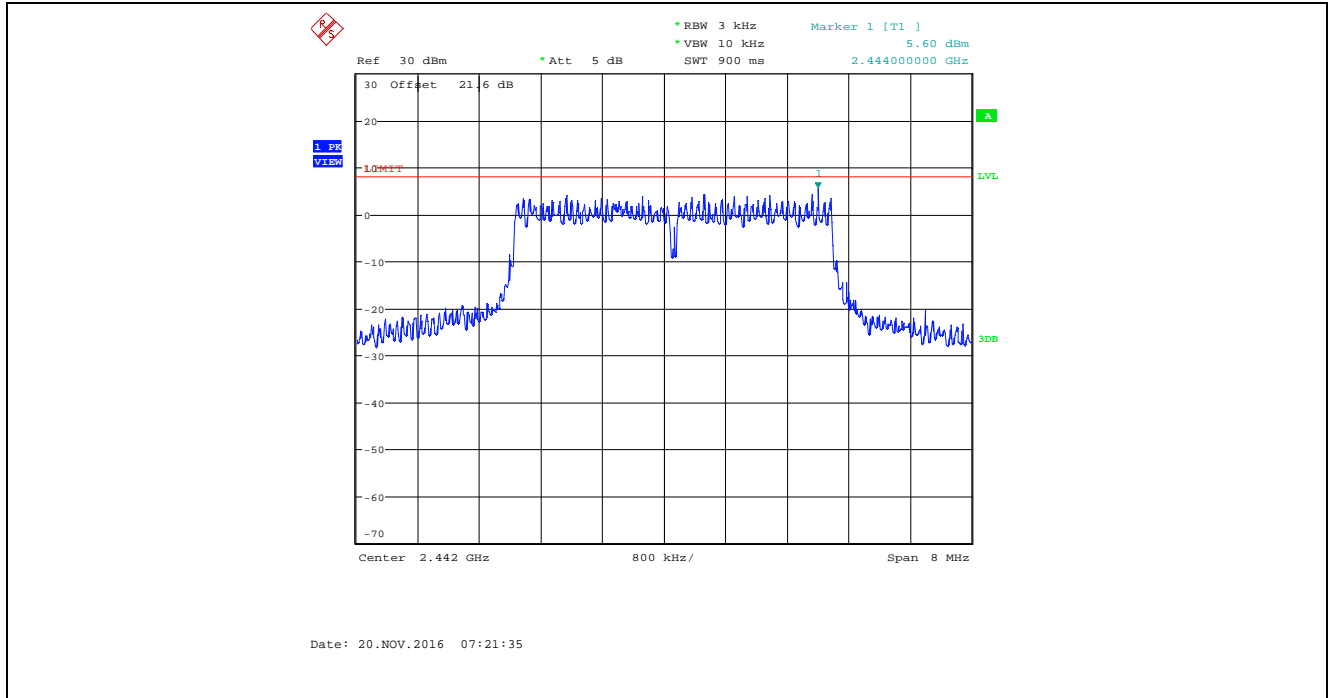

Plot 5.6.4.69. Power Spectral Density, Bandwidth: 4 MHz, TX Gain Setting: 50, Data Rate 7, 2480 MHz

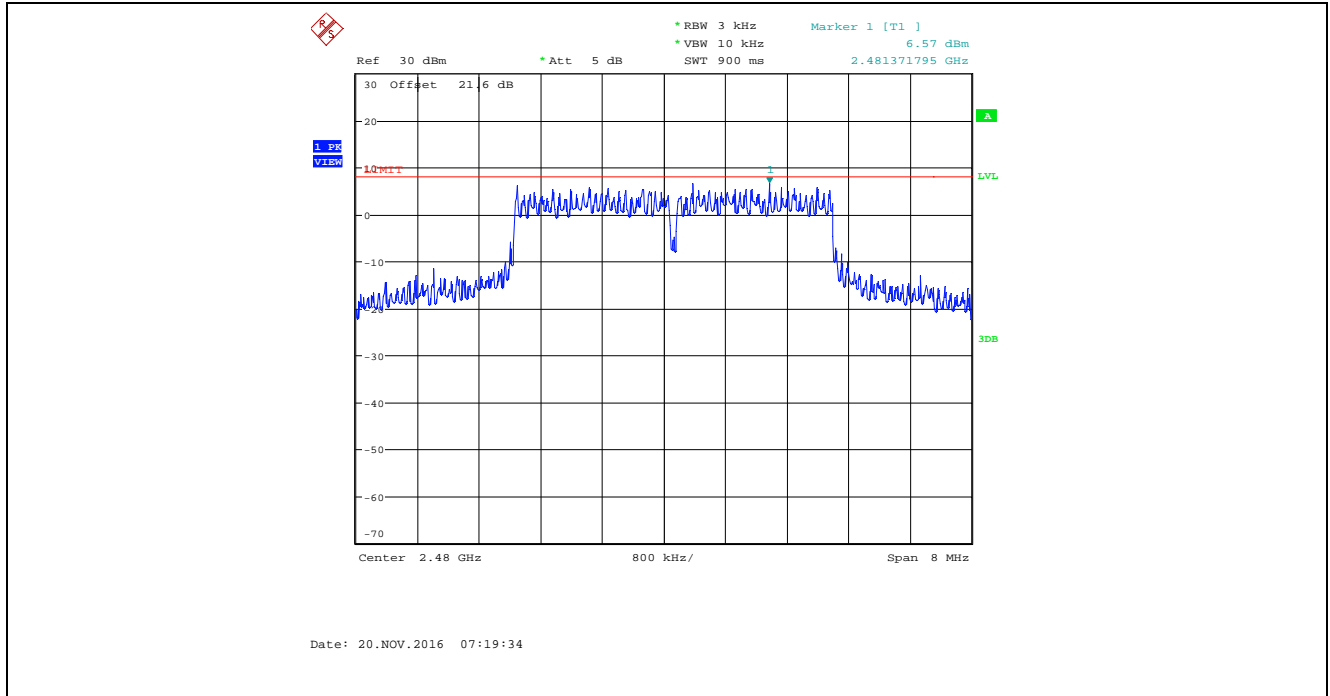

Plot 5.6.4.70. Power Spectral Density, Bandwidth: 8 MHz, TX Gain Setting: 55, Data Rate 4, 2407 MHz

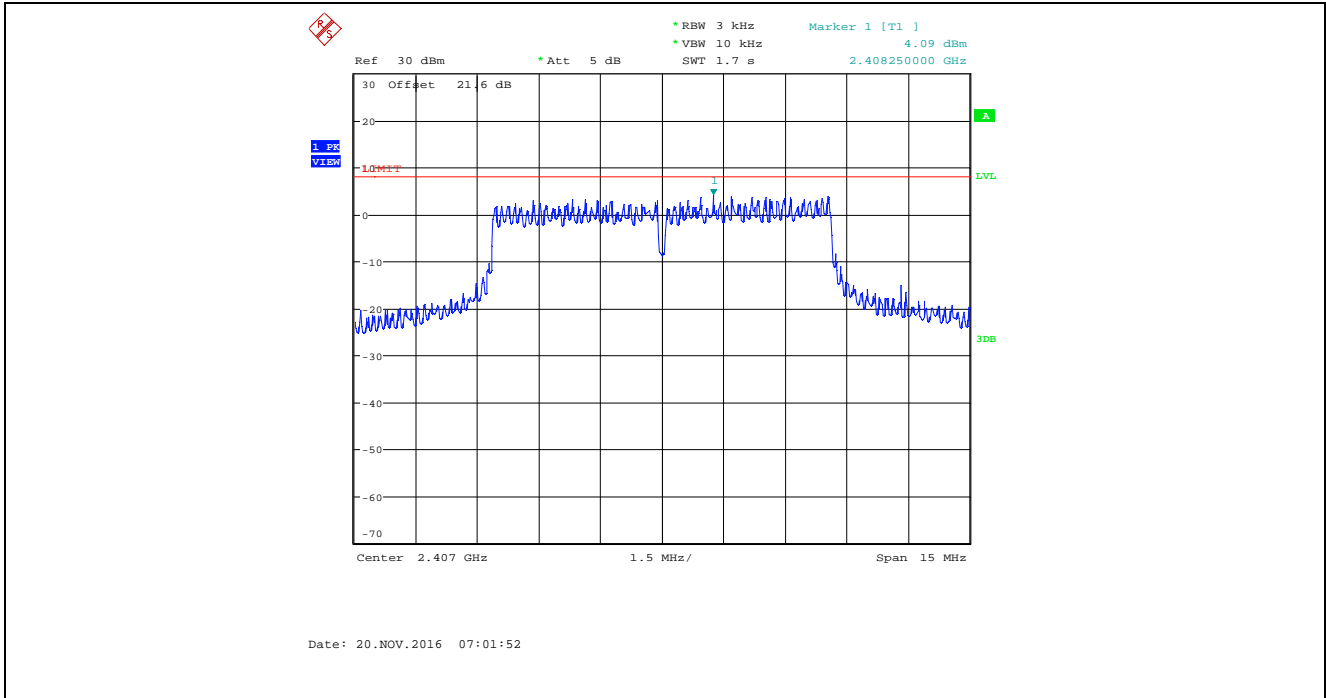

Plot 5.6.4.71. Power Spectral Density, Bandwidth: 8 MHz, TX Gain Setting: 55, Data Rate 4, 2442 MHz

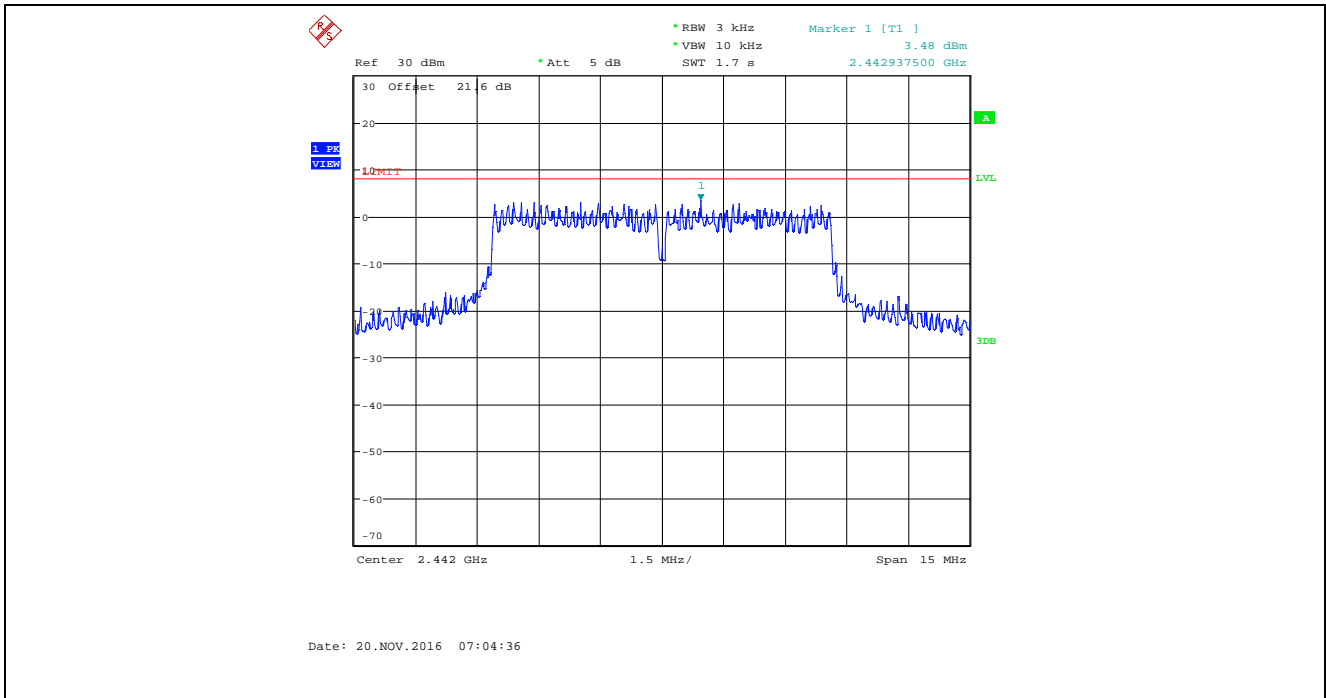



Plot 5.6.4.72. Power Spectral Density, Bandwidth: 8 MHz, TX Gain Setting: 55, Data Rate 4, 2477 MHz

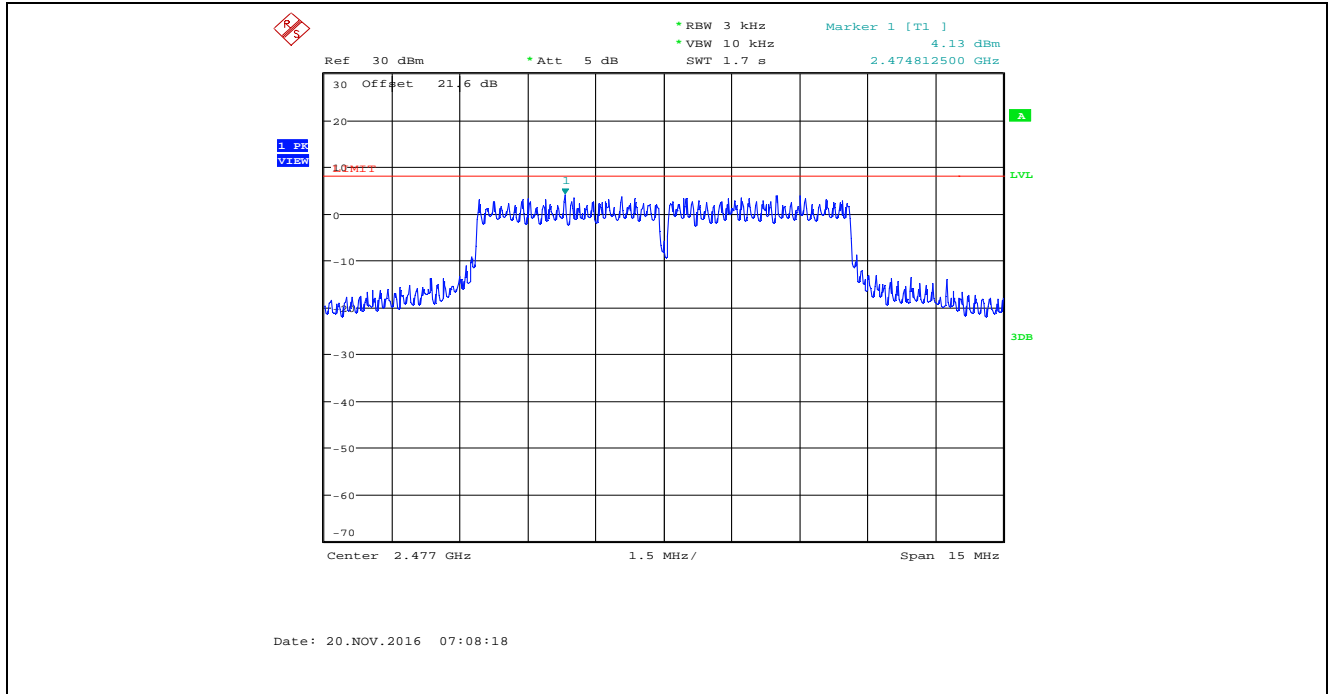

Plot 5.6.4.73. Power Spectral Density, Bandwidth: 8 MHz, TX Gain Setting: 55, Data Rate 5, 2407 MHz

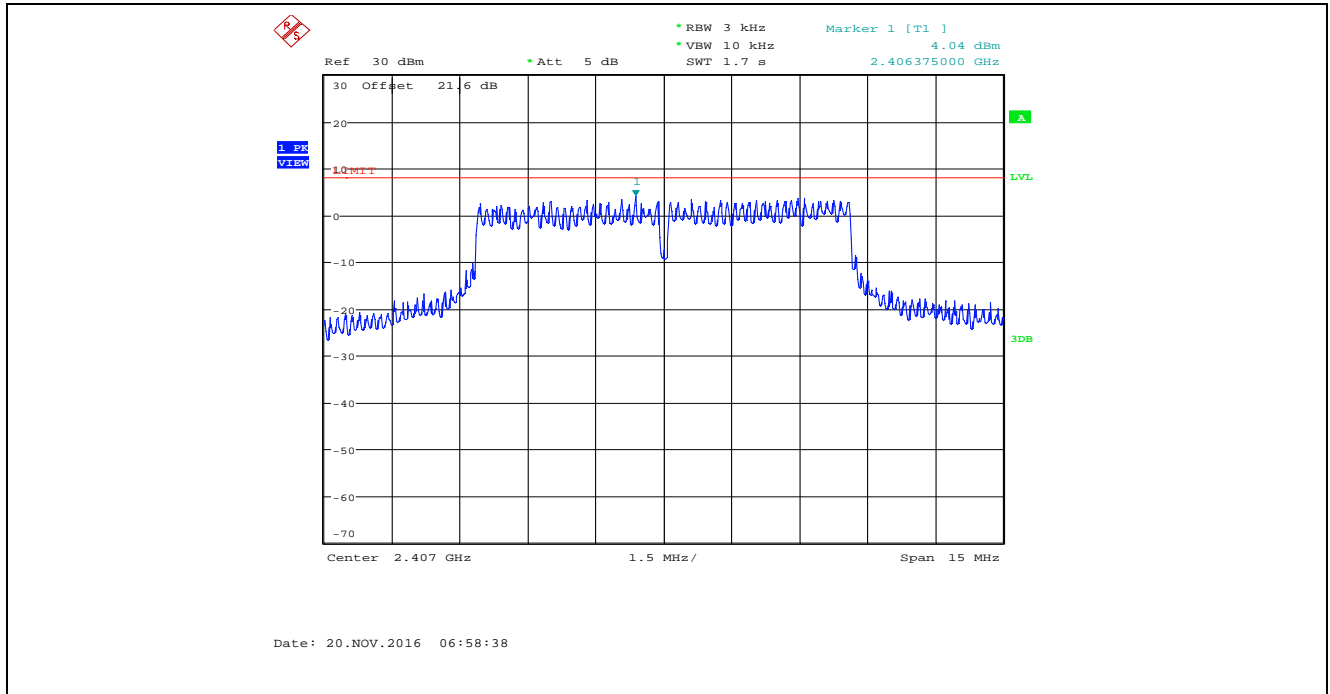

Plot 5.6.4.74. Power Spectral Density, Bandwidth: 8 MHz, TX Gain Setting: 55, Data Rate 5, 2442 MHz

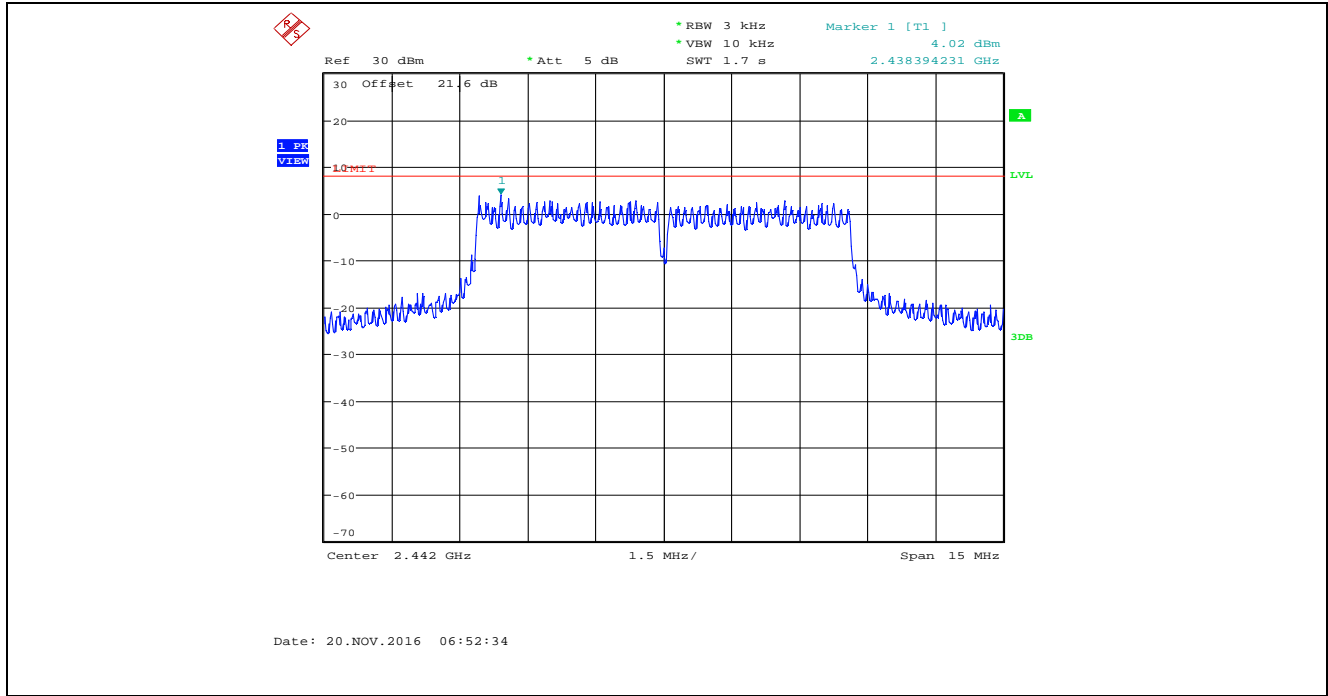

Plot 5.6.4.75. Power Spectral Density, Bandwidth: 8 MHz, TX Gain Setting: 55, Data Rate 5, 2477 MHz

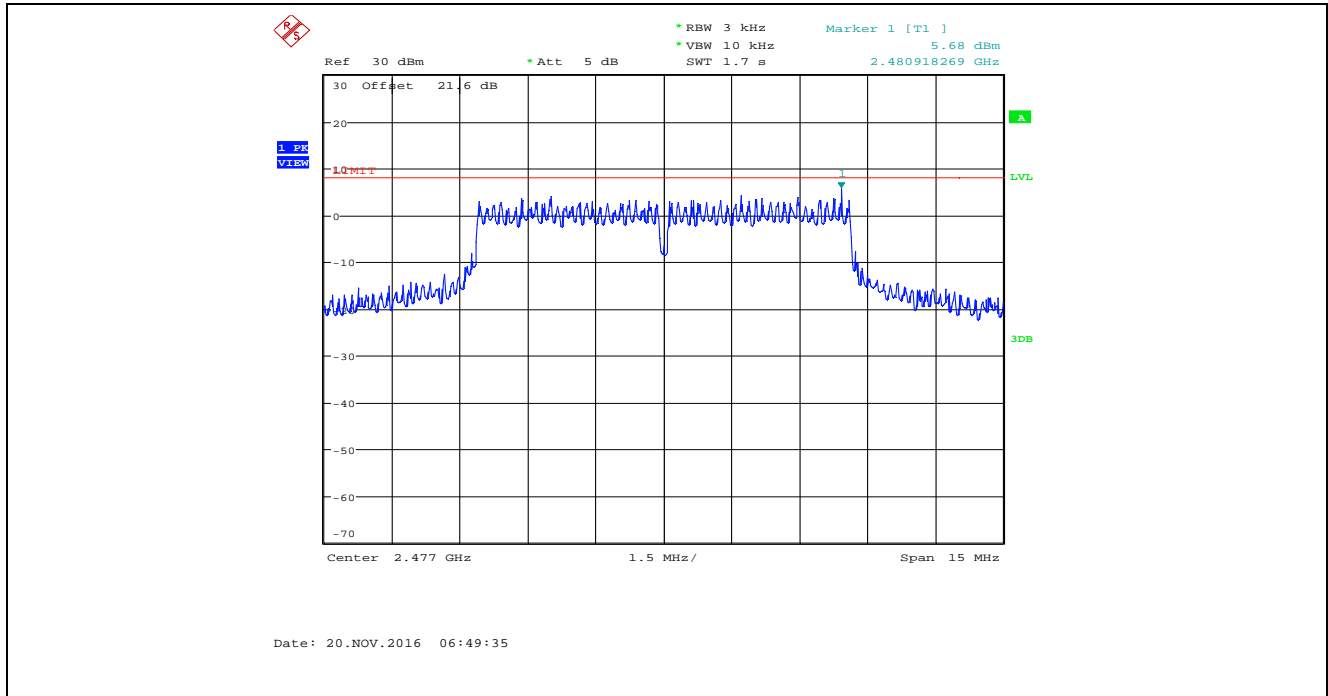

Plot 5.6.4.76. Power Spectral Density, Bandwidth: 8 MHz, TX Gain Setting: 55, Data Rate 6, 2407 MHz

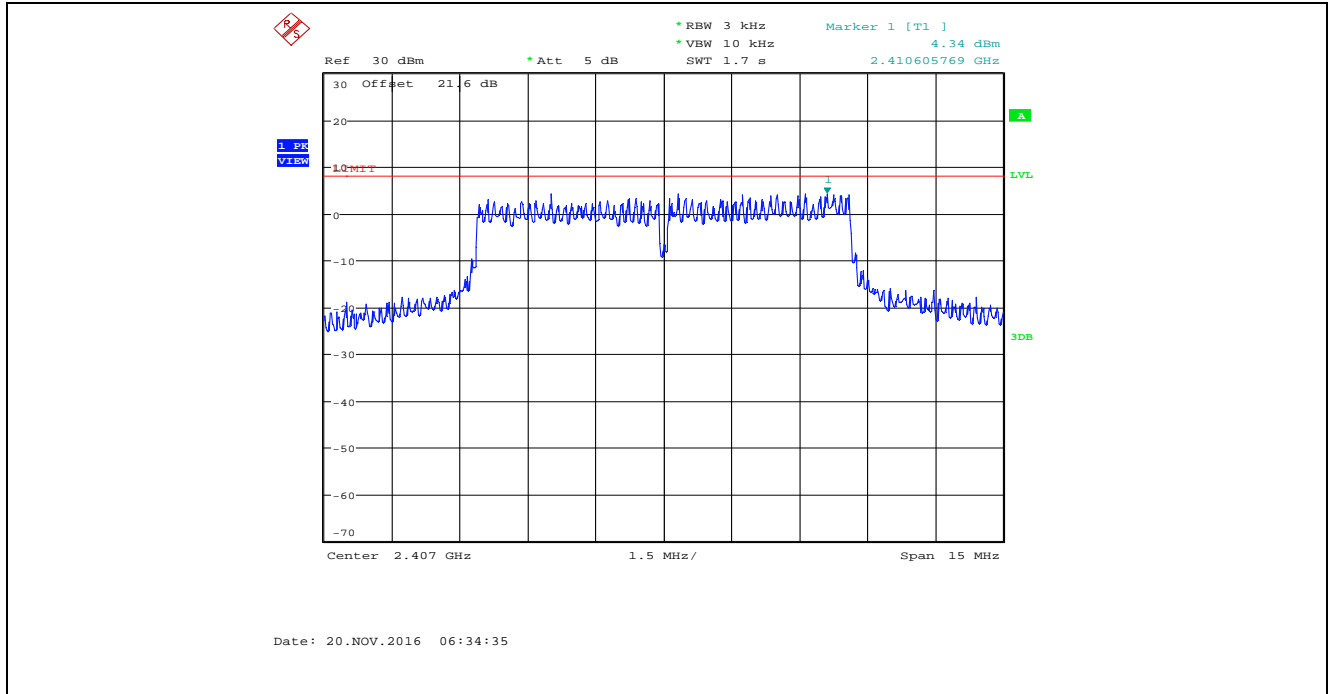

Plot 5.6.4.77. Power Spectral Density, Bandwidth: 8 MHz, TX Gain Setting: 55, Data Rate 6, 2442 MHz

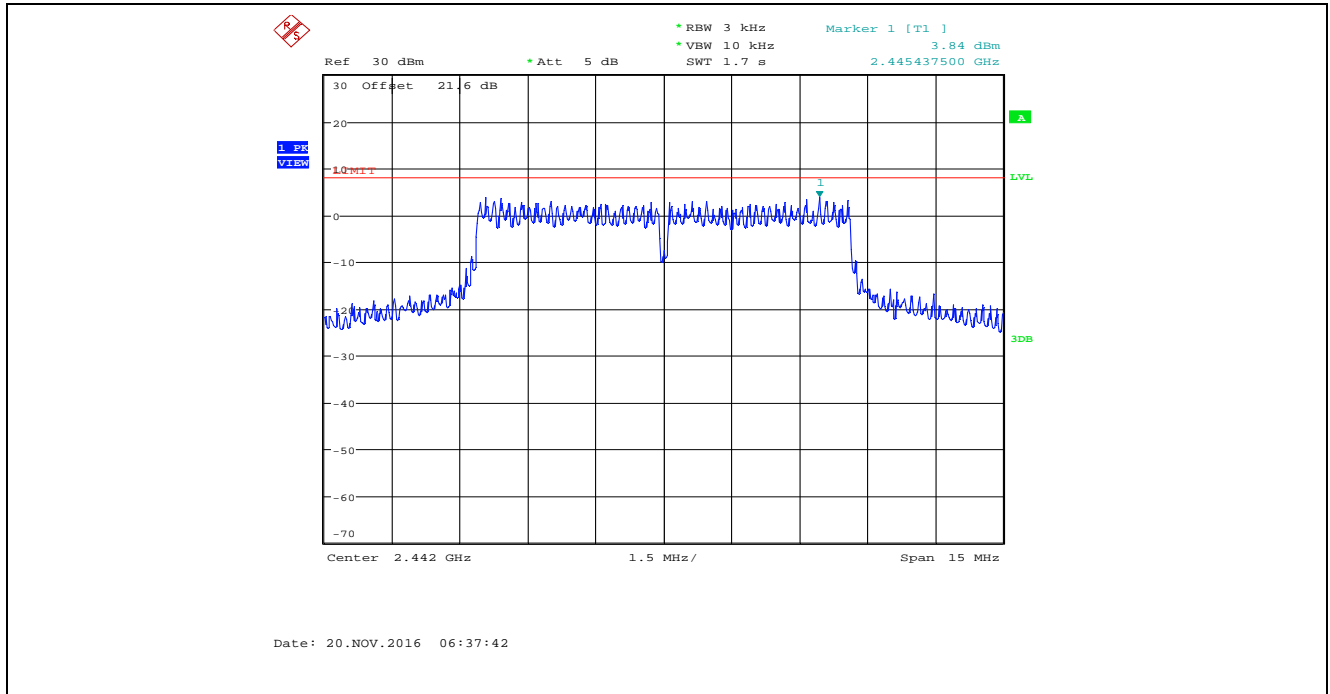

Plot 5.6.4.78. Power Spectral Density, Bandwidth: 8 MHz, TX Gain Setting: 55, Data Rate 6, 2477 MHz

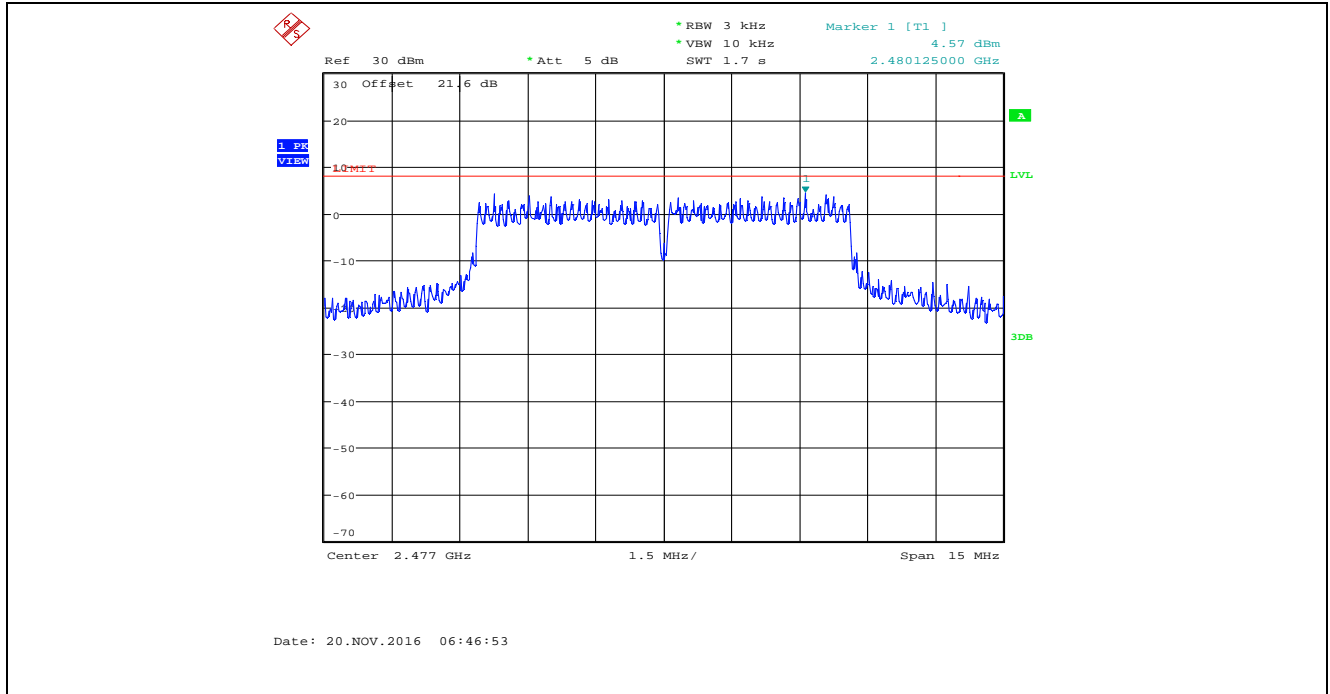

Plot 5.6.4.79. Power Spectral Density, Bandwidth: 8 MHz, TX Gain Setting: 55, Data Rate 7, 2407 MHz

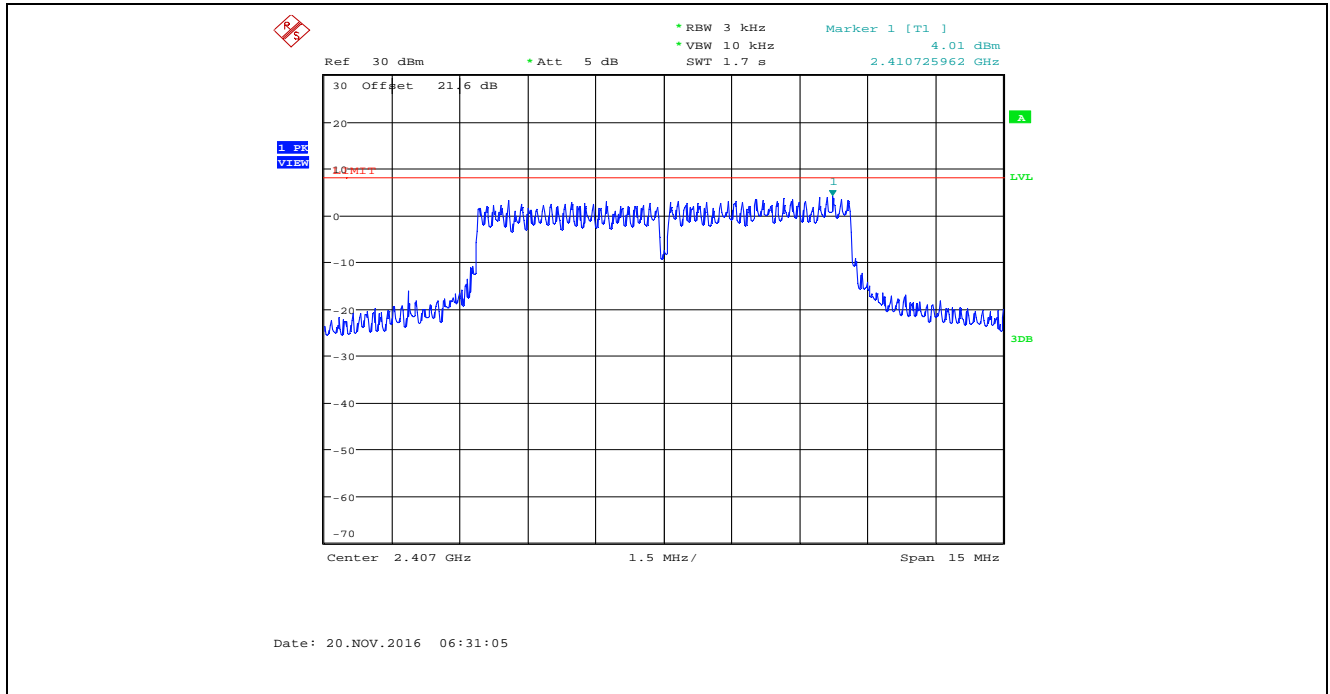

Plot 5.6.4.80. Power Spectral Density, Bandwidth: 8 MHz, TX Gain Setting: 55, Data Rate 7, 2442 MHz

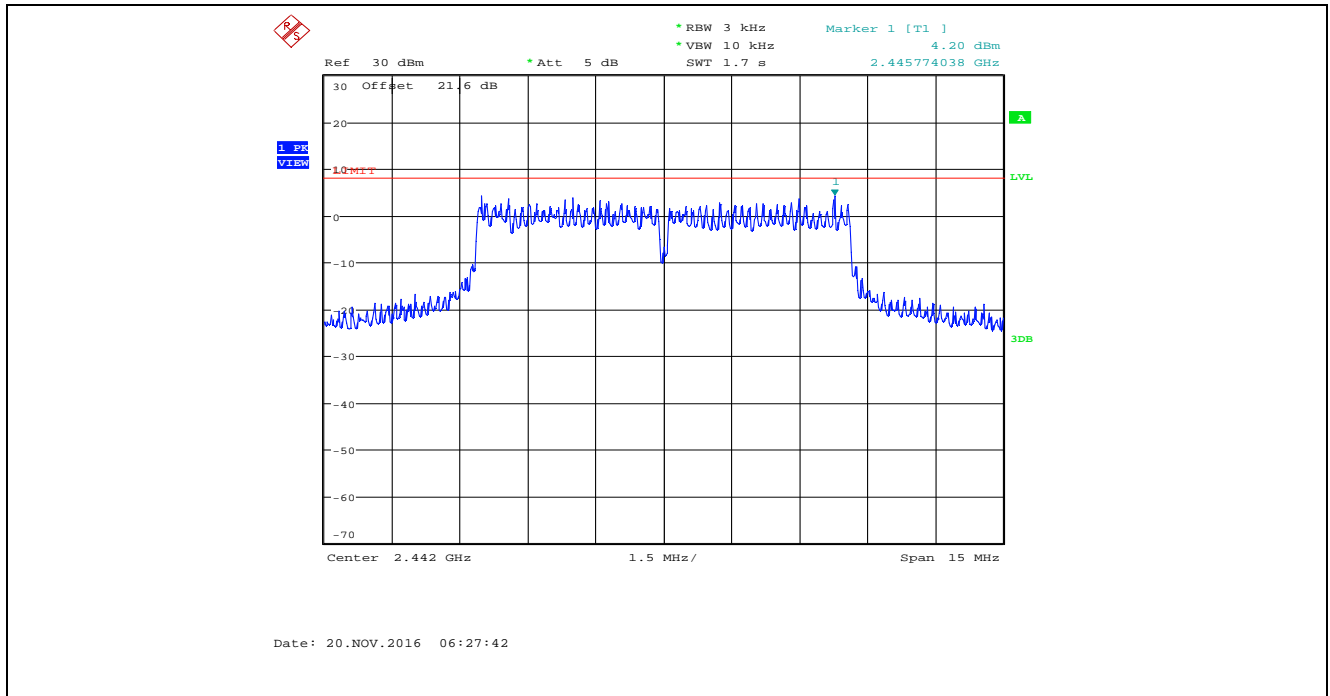

Plot 5.6.4.81. Power Spectral Density, Bandwidth: 8 MHz, TX Gain Setting: 55, Data Rate 7, 2477 MHz

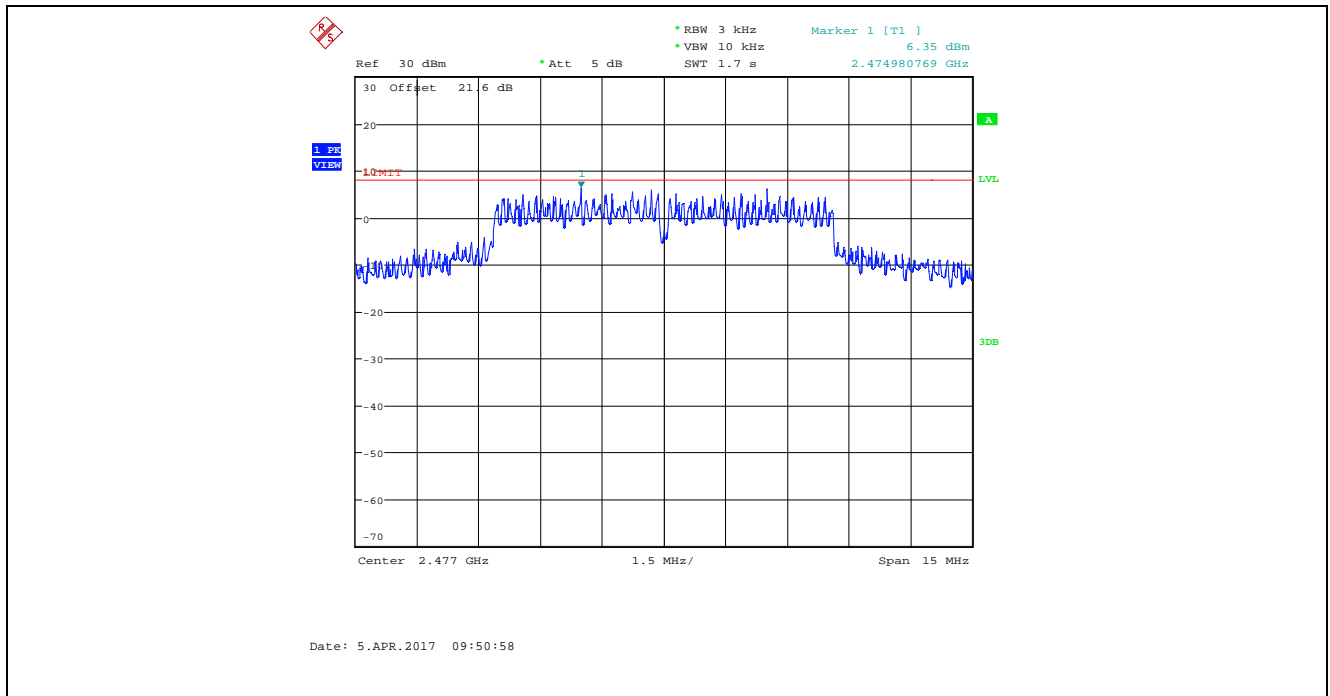

**5.7. RF EXPOSURE REQUIRMENTS [§§ 15.247(i), 1.1310 & 2.1091]**

**5.7.1. Limits**

§ 1.1310: The criteria listed in the following table shall be used to evaluate the environmental impact of human exposure to radio-frequency (RF) radiation as specified in 1.1307(b).

**Limits for Maximum Permissible Exposure (MPE)**

Frequency range (MHz)	Electric field strength (V/m)	Magnetic field strength (A/m)	Power density (mW/cm <sup>2</sup> )	Averaging time (minutes)
<b>(A) Limits for Occupational/Controlled Exposures</b>				
0.3-3.0	614	1.63	*(100)	6
3.0-30	1842/f	4.89/f	*(900/f <sup>2</sup> )	6
30-300	61.4	0.163	1.0	6
300-1500			f/300	6
1500-100,000			5	6
<b>(B) Limits for General Population/Uncontrolled Exposure</b>				
0.3-1.34	614	1.63	*(100)	30
1.34-30	824/f	2.19/f	*(180/f <sup>2</sup> )	30
30-300	27.5	0.073	0.2	30
300-1500			f/1500	30
1500-100,000			1.0	30

f = frequency in MHz

\* = Plane-wave equivalent power density

Note 1: Occupational/controlled limits apply in situations in which persons are exposed as a consequence of their employment provided those persons are fully aware of the potential for exposure and can exercise control over their exposure. Limits for occupational/controlled exposure also apply in situations when an individual is transient through a location where occupational/controlled limits apply provided he or she is made aware of the potential for exposure.

Note 2: General population/uncontrolled exposures apply in situations in which the general public may be exposed, or in which persons that are exposed as a consequence of their employment may not be fully aware of the potential for exposure or can not exercise control over their exposure.

### 5.7.2. Method of Measurements

#### Calculation Method of Power Density/RF Safety Distance:

$$S = \frac{PG}{4\pi \cdot r^2} = \frac{EIRP}{4\pi \cdot r^2}$$

Where,  
P: power input to the antenna in mW  
EIRP: Equivalent (effective) isotropic radiated power.  
S: power density mW/cm<sup>2</sup>  
G: numeric gain of antenna relative to isotropic radiator  
r: distance to centre of radiation in cm

### 5.7.3. RF Evaluation

#### 5.7.3.1. Standalone

Frequency (MHz)	EIRP (dBm)	EIRP (mW)	Evaluation Distance, r (cm)	Power Density, S (mW/cm <sup>2</sup> )	MPE Limit (mW/cm <sup>2</sup> )	Margin (mW/cm <sup>2</sup> )
2402	36	4000	36	0.246	1.0	-0.754

**5.7.3.2. Co-location**

Pursuant to KDB 447498 D01 General RF Exposure Guidance v06, Section 7.2:

*Simultaneous transmission MPE test exclusion applies when the sum of the MPE ratios for all simultaneously transmitting antennas incorporated in a host device is  $\leq 1.0$ , according to calculated/estimated, numerically modeled, or measured field strengths or power density.*

Co-location will only applies to EUT with 2.5 dBi dipole antenna, worst case EIRP of 32.5 dBm will be used in co-location at the minimum 36 cm evaluation separation distance required by the operating configurations and exposure conditions of the host device.

**The maximum calculated MPE ratio of the EUT with 2.5 dBi dipole antenna**

Frequency (MHz)	EUT EIRP (dBm)	EUT EIRP (mW)	Evaluation Distance (cm)	Power Density (mW/cm <sup>2</sup> )	FCC MPE Limit (mW/cm <sup>2</sup> )	MPE Ratio
2402	32.5	1778.279	36	0.109	1.000	0.109

The maximum calculated MPE ratio for the EUT with 2.5 dBi dipole antenna is 0.109, this configuration can be co-located with other antennas provided the sum of the MPE ratios for all the other simultaneous transmitting antennas incorporated in a host device is  $\leq 1.0 - 0.109 \leq 0.891$ . The following table addresses the co-location of the EUT with 2.5 dBi antenna with the specified radio modules.

**EUT with 2.5 dBi dipole antenna co-location with radio module identified in this table**

*Radio Module	Frequency (MHz)	EIRP (mW)	Evaluation Distance (cm)	Power Density (mW/cm <sup>2</sup> )	FCC MPE Limit (mW/cm <sup>2</sup> )	MPE Ratio	MPE Ratio of EUT with 2.5 dBi antenna	Sum of MPE Ratio	Verdict
Data Card Module (FCC ID: RI7LN930, IC: 5131A-LN930)	824.2	2511.890	36	0.154	0.549	0.281	0.109	0.390	Compliant
UMTS/LTE Data Module (FCC ID: XPYTOBYL201, IC: 8595A-TOBYL201)	710.0	2398.833	36	0.147	0.473	0.311	0.109	0.420	Compliant
LE910NA V2 LTE/3G Module (FCC ID: RI7LE910NAV2, IC: 5131A-LE910NAV2)	699	1156.112	36	0.071	0.466	0.152	0.109	0.261	Compliant
ME3630 LTE Module (FCC ID: SRQ-ME3630)	1852.4	582.103	36	0.036	1.000	0.036	0.109	0.145	Compliant

\* The test data of the radio modules represented in this table is the worst-case configuration (maximum MPE ratio) derived from the original radio modules MPE reports. Refer to these reports for details.



**EXHIBIT 6. TEST EQUIPMENT LIST**

Test Instruments	Manufacturer	Model No.	Serial No.	Frequency Range	Cal. Due Date
Spectrum Analyzer	Hewlett Packard	HP 8593EM	3412A00103	9 kHz - 26.5 GHz	9 Apr 2017
Attenuator	Pasternack	PE7010-20	07	DC - 2 GHz	26 Mar 2017
L.I.S.N	EMCO	3825/2	1531	0.10 -100 MHz	11 Nov 2017
Signal Generator	Agilent	E8241A	US42110625	250 kHz - 20 GHz	15 Sep 2018
Spectrum Analyzer	Rohde & Schwarz	FSU26	200946	20 Hz–26.5 GHz	21 Jul 2018
Attenuator	Pasternack	7024-20	6	DC–26.5 GHz	Cal on use
DC Block	Hewlett Packard	11742A	12460	0.045 – 26.5 GHz	Cal on use
Peak Power Analyzer	Hewlett Packard	8991A	3342A00657	0.5 - 40 GHz	9 Aug 2017
Peak Power Sensor	Hewlett Packard	84814A	3205A00175	0.5 - 40 GHz	15 Aug 2017
Attenuator	Pasternack	7024-10	4	DC–26.5 GHz	Cal on use
High Pass Filter	K & L	11SH10-4000/T12000	4	Cut off 2400 MHz	Cal on use
Band Reject Filter	Micro-Tronics	BRM50701	105	Cut off 2.4-2.483 GHz	Cal on use
EMI Receiver	Rohde & Schwarz	ESU40	100037	20Hz–40 GHz	8 May 2017
Spectrum Analyzer	Rohde & Schwarz	FSEK30	100077	20Hz–40 GHz	5 Dec 2018
RF Amplifier	Com-Power	PAM-0118A	551016	0.5 – 18 GHz	14 Jul 2017
RF Amplifier	Hewlett Packard	84498	3008A00769	1 – 26.5 GHz	5 May 2017
Biconilog	EMCO	3142	9601-1005	26-1000 MHz	12 May 2018
Horn Antenna	EMCO	3155	6570	1 – 18 GHz	13 Oct 2018
Horn Antenna	ETS-Lindgren	3160-09	00118385	18 – 26.5 GHz	11 Oct 2018

**ULTRATECH GROUP OF LABS**

3000 Bristol Circle, Oakville, Ontario, Canada L6H 6G4  
 Tel. #: 905-829-1570, Fax. #: 905-829-8050, Email: [vic@ultratech-labs.com](mailto:vic@ultratech-labs.com), Website: <http://www.ultratech-labs.com>

File #: 17MCRS101\_FCC15C247D2G4  
 April 13, 2017

*All test results contained in this engineering test report are traceable to National Institute of Standards and Technology (NIST)*

**EXHIBIT 7. MEASUREMENT UNCERTAINTY**

The measurement uncertainties stated were calculated in accordance with the requirements of CISPR 16-4-2 @ IEC:2003 and JCGM 100:2008 (GUM 1995) – Guide to the Expression of Uncertainty in Measurement.

**7.1. LINE CONDUCTED EMISSION MEASUREMENT UNCERTAINTY**

	Line Conducted Emission Measurement Uncertainty (9 kHz – 30 MHz):	Measured	Limit
$u_c$	Combined standard uncertainty: $u_c(y) = \sqrt{\sum_{i=1}^m u_i^2(y)}$	$\pm 1.44$	$\pm 1.8$
<b>U</b>	Expanded uncertainty U: $U = 2u_c(y)$	$\pm 2.89$	$\pm 3.6$

**7.2. RADIATED EMISSION MEASUREMENT UNCERTAINTY**

	Radiated Emission Measurement Uncertainty @ 3m, Horizontal (30-1000 MHz):	Measured (dB)	Limit (dB)
$u_c$	Combined standard uncertainty: $u_c(y) = \sqrt{\sum_{i=1}^m u_i^2(y)}$	$\pm 2.39$	$\pm 2.6$
<b>U</b>	Expanded uncertainty U: $U = 2u_c(y)$	$\pm 4.79$	$\pm 5.2$

	Radiated Emission Measurement Uncertainty @ 3m, Vertical (30-1000 MHz):	Measured (dB)	Limit (dB)
$u_c$	Combined standard uncertainty: $u_c(y) = \sqrt{\sum_{i=1}^m u_i^2(y)}$	$\pm 2.39$	$\pm 2.6$
<b>U</b>	Expanded uncertainty U: $U = 2u_c(y)$	$\pm 4.78$	$\pm 5.2$

	Radiated Emission Measurement Uncertainty @ 3 m, Horizontal & Vertical (1 – 18 GHz):	Measured (dB)	Limit (dB)
$u_c$	Combined standard uncertainty: $u_c(y) = \sqrt{\sum_{i=1}^m u_i^2(y)}$	$\pm 1.87$	Under consideration
<b>U</b>	Expanded uncertainty U: $U = 2u_c(y)$	$\pm 3.75$	Under consideration