

# **National Certification Laboratory**

**8370 Court Avenue, Suite B-1  
Ellicott City, Maryland 21043  
(410) 461-5548**

## **FCC REPORT OF RADIO INTERFERENCE**

**FOR**

**Microhard Systems, Inc.  
#110, 1144 – 29<sup>th</sup> Ave., N.E.  
Calgary  
Alberta, Canada T2E 7P1**

**FCC ID: NS900P4**

**June 10, 2002**



## TABLE OF CONTENTS

- 1.0 Introduction
- 1.1 Summary
- 2.0 Description of Equipment Under Test (EUT)
- 2.1 EMI Countermeasure
- 3.0 Test Program
- 4.0 Test Configuration
- 5.0 Conducted Emissions Scheme
- 6.0 Radiated Emissions Scheme

### **TABLES**

- Table 1. Support Equipment
- Table 2. Interface Cables
- Table 3. Measurement Equipment

### **EXHIBITS**

- Exhibit 1. EUT Photographs
- Exhibit 2. Schematic Diagram
- Exhibit 3. User Manual

***NCL PROJ.# Microhard-561-Class II***



## **1.0 Introduction:**

This report has been prepared on behalf of **Microhard Systems, Inc.**, to support the attached Application for a Class II Permissive Change of a Part 15 Spread Spectrum Transmitter module. The Equipment Under Test (EUT) was the Model: **MHX-2400 Wireless Modem Transceiver /OEM Module**.

Radio-Noise Emissions tests were performed according to *FCC Public Notice 54797, titled "Guidance on Measurement for Direct Sequence SST"*. The measuring equipment conforms to ANSI C63.2 Specifications for Electromagnetic Noise and Field Strength Instrumentation.

Testing was performed at National Certification Laboratory in Ellicott City, MD. Site description and site attenuation data have been placed on file with the FCC's sampling and Measurements Branch. FCC acceptance was granted on May 26, 1993.

## **1.1 Summary:**

The Microhard Systems, Inc., Model: **MHX-2400 Wireless Modem Transceiver /OEM Module** complies with the FCC limits (15.247) for a Frequency Hopping SST.

MHX-2400 List of Changes:

- Use MCX or Reverse SMA connector
- Digital Temperature compensation option
- Reset circuit for microprocessor
- Inner shield for VCO circuit
- VCO buffer circuit changed with compatible part.
- Output Match Optimized
- PA dac changed vendors
- Added Antennas to test set



## **2.0 Description of Equipment Under Test (EUT):**

The EUT features:

Reverse Polarity SMA Antenna Connector per 15.203

+30 dBm RF Output Max.

2401.31 - 2481.24 MHz Frequency Range

350 kHz 20 dB Emission Bandwidth

200 Hopping Channels

400 kHz Channel Separation

172.8 kbps Data Rate (Radio Link)

115.2 kbps Max Data Rate (DCE)

## **3.0 Test Program:**

This report contains measurement charts and data as evidence for the following tests performed:

1. (15.247b) Peak RF output power.
2. (15.247c) Field Strength of harmonics and spurious out-of-band emissions.
3. (15.247c) RF Antenna Conducted of harmonics and spurious out-of-band emissions.
4. (15.247a) 20 dB Emission Bandwidth.
5. (15.207) Power Line Conducted Emissions.
6. (15.247c) Band Edge emissions.



#### **4.0 Test Configuration:**

RF antenna output tests such as Bandwidth, Spurious/Harmonics, Power output, were taken with the transmitter antenna connector feeding directly into the spectrum analyzer via external 30 db attenuator. The analyzer's internal attenuator was adjusted to prevent overloading of the front end. The transmitter is modulated at 172.8 kbps which is the highest available data rate.

Field strength measurements were taken with the transmitter feeding a yagi, or omni antenna aimed at the receiving antenna. Testing was performed using the highest gain antenna from each design family (yagi, omni) with the power setting at 1 Watt for the omni antenna, and 100 mW for the higher gain yagi.

A list of all antennas that will be sold with the **MHX-2400** Wireless Module follows:

Rubber Ducky

3 dBi 1.25 ft Omni

6 dBi 2 ft Omni

3.5 dBi Transit w/o ground plane

3.5 dBi Transit with ground plane

12 dBi Yagi



## **PEAK POWER TEST RESULTS**

Limit: 1 watt (30 dBm)

Condition: Transmitter is set to a single modulated channel

Reading from spectrum analyzer with 1 MHz Resolution Bandwidth setting:

**Low Channel : 2401.31 MHz - (+28.6 dBm)**

**Mid Channel : 2441.22 MHz - (+30.0 dBm)**

**High Channel : 2481.26 MHz - (+29.6 dBm)**

**SEE FOLLOWING THREE (3) PLOTS OF MODULATED CARRIER**



# PEAK RF POWER – MODULATED CARRIER (1 MHz RES. BW)

Low Channel

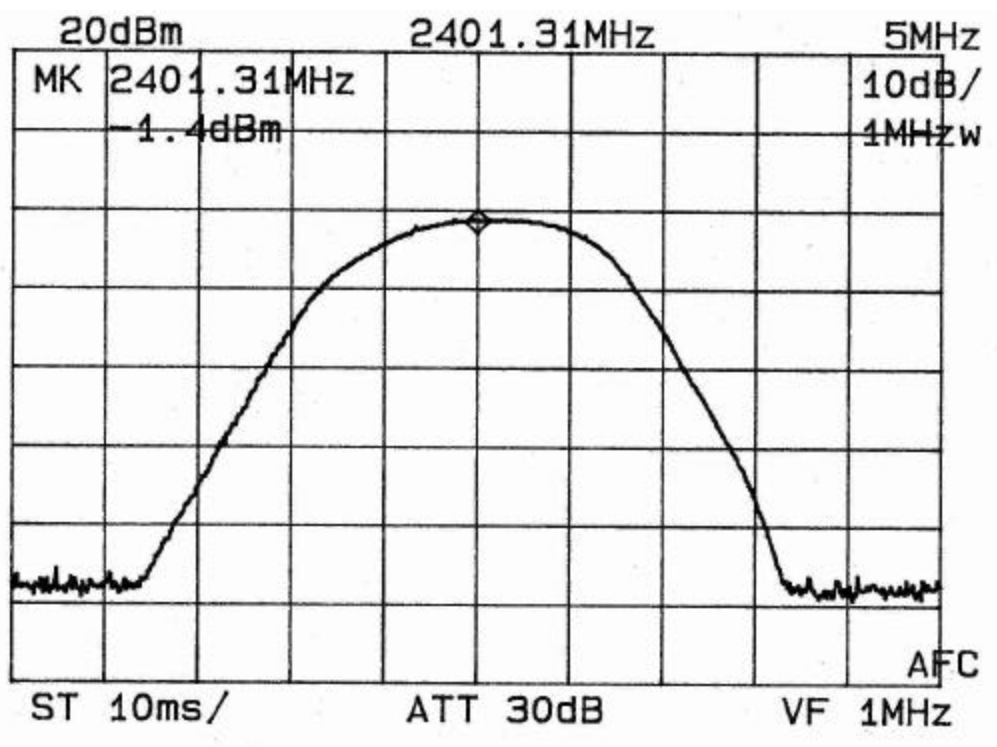



# PEAK RF POWER – MODULATED CARRIER (1 MHz RES. BW)

Mid Channel

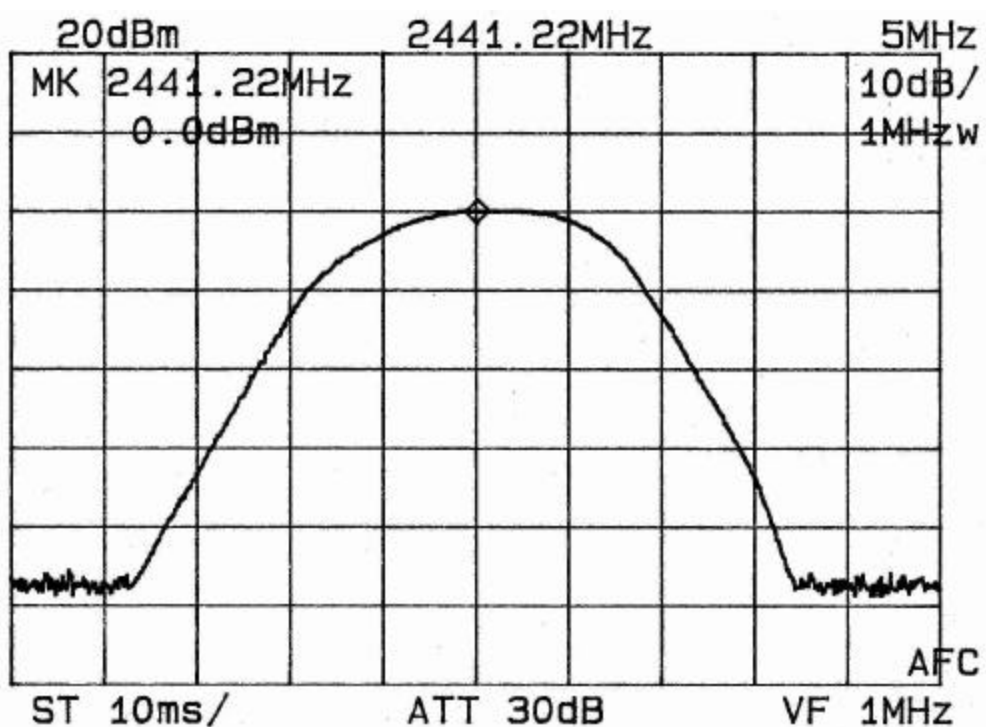





# PEAK RF POWER – MODULATED CARRIER (1 MHz RES. BW)

High Channel

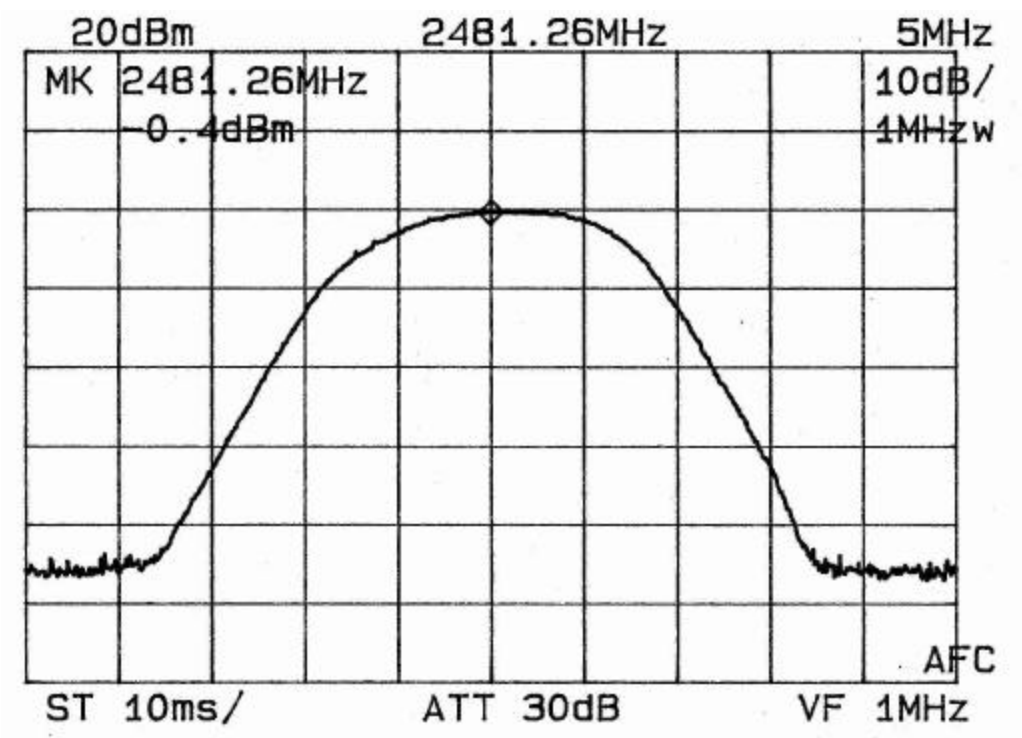



## **20 dB EMISSION BANDWIDTH**

Maximum 20 dB BW: 1.0 MHz  
RBW Setting on S.A.: 10 kHz

Condition: Transmitter is set to a single channel modulated at 172.8 kbps

Reading from Spectrum Analyzer:

**Low Channel : 2401.31 MHz - (356 kHz)**

**Mid Channel : 2441.22 MHz - (348 kHz)**

**High Channel : 2481.26 MHz - (351 kHz)**

**SEE FOLLOWING THREE (3) PLOTS OF MODULATED CARRIER**



## 20 dB EMISSION BANDWIDTH – MODULATED CARRIER (10 kHz RES. BW)

Low Channel

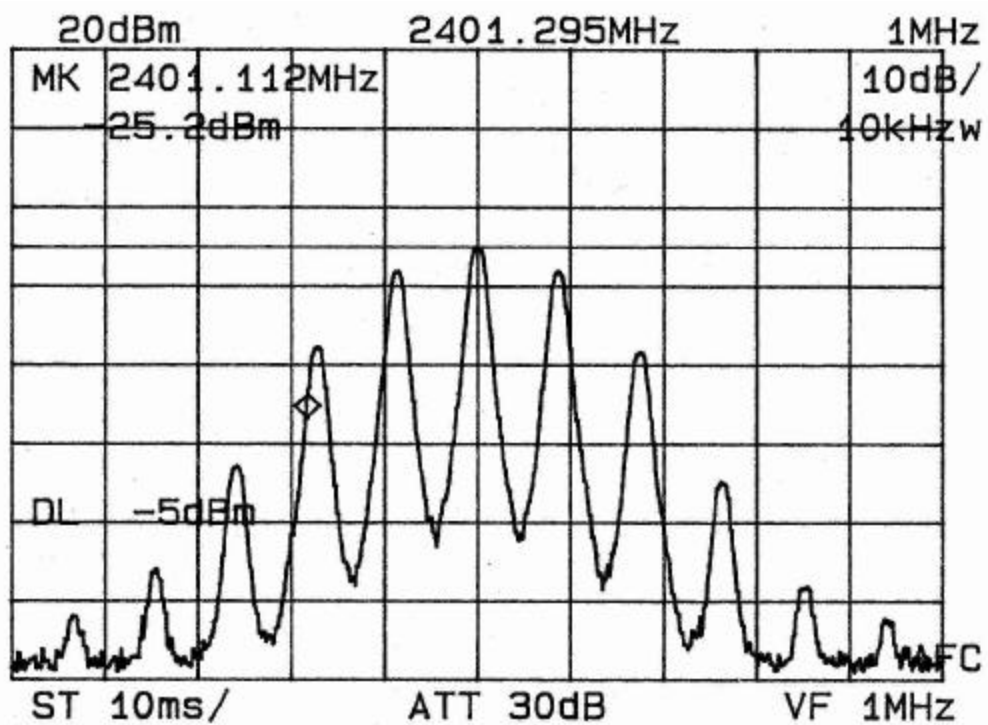



## 20 dB EMISSION BANDWIDTH – MODULATED CARRIER (10 kHz RES. BW)

Mid Channel

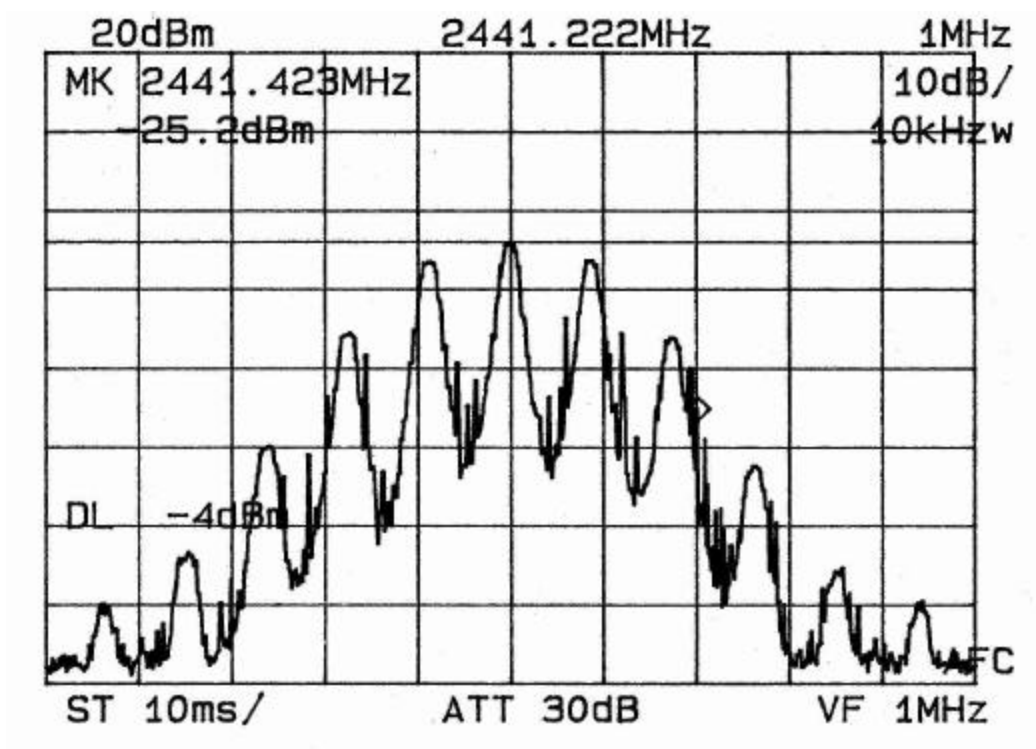



## 20 dB EMISSION BANDWIDTH – MODULATED CARRIER (10 kHz RES. BW)

High Channel

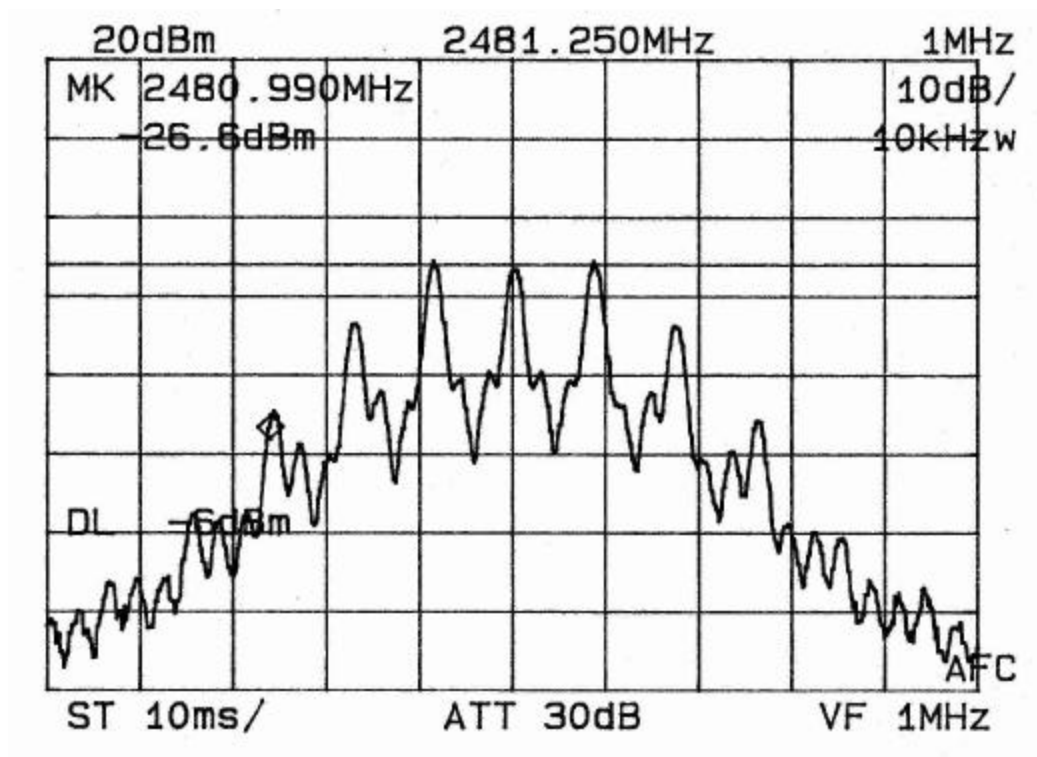



## **RF ANTENNA CONDUCTED SPURIOUS/HARMONICS EMISSIONS**

Limit: 20 dB below Carrier Level Measured with 100 kHz RBW

RBW Setting on S.A.: 100 kHz

Condition: Transmitter is set to a single modulated channel.  
RF Power = 30 dBm

Three separate measurements are performed to show harmonic and spurious emissions generated with the transmitter tuned to low, middle, and high parts of the spectral range.

SEE FOLLOWING THREE (3) DATA TABLES



## FCC Part 15.247(c) – Conducted Spurious Emissions

Frequency of Carrier = 2401.31 MHz

Limit = 20 dBc

Condition: Transmitter is set to a single modulated channel.

### TEST RESULTS

LIMIT: -20 dB FROM PEAK CARRIER

<u>Component</u>	<u>Frequency (MHz)</u>	<u>Result (dB From Peak)</u>
Harmonic	4802.62	-43.0
Harmonic	7203.93	-55.0
Harmonic	9605.24	-67.0
Harmonic	12006.55	-69.0
Harmonic	14407.86	-71.0
Harmonic	16809.17	-74.0
Harmonic	19210.48	-75.0
Harmonic	21611.79	-75.0
Harmonic	24013.10	-75.0



## FCC Part 15.247(c) – Conducted Spurious Emissions

Frequency of Carrier = 2441.22 MHz

Limit = 20 dBc

Condition: Transmitter is set to a single modulated channel.

### TEST RESULTS

LIMIT: -20 dB FROM PEAK CARRIER

<u>Component</u>	<u>Frequency (MHz)</u>	<u>Result (dB From Peak)</u>
Harmonic	4882.44	-45.0
Harmonic	7323.66	-54.0
Harmonic	9764.88	-66.0
Harmonic	12206.10	-72.0
Harmonic	14647.32	-71.0
Harmonic	17088.54	-74.0
Harmonic	19529.76	-75.0
Harmonic	21970.98	-75.0
Harmonic	24412.20	-75.0





## FCC Part 15.247(c) – Conducted Spurious Emissions

Frequency of Carrier = 2481.26 MHz

Limit = 20 dBc

Condition: Transmitter is set to a single modulated channel.

### TEST RESULTS

LIMIT: -20 dB FROM PEAK CARRIER

<u>Component</u>	<u>Frequency (MHz)</u>	<u>Result (dB From Peak)</u>
Harmonic	4962.52	-44.0
Harmonic	7443.78	-52.0
Harmonic	9925.04	-63.0
Harmonic	1206.30	-70.0
Harmonic	14887.56	-71.0
Harmonic	17368.82	-73.0
Harmonic	19850.08	-74.0
Harmonic	22331.34	-75.0
Harmonic	24812.60	-75.0



CONDUCTED BAND EDGE EMISSIONS – MODULATED CARRIER (100 kHz RES. BW)

LOW CHANNEL

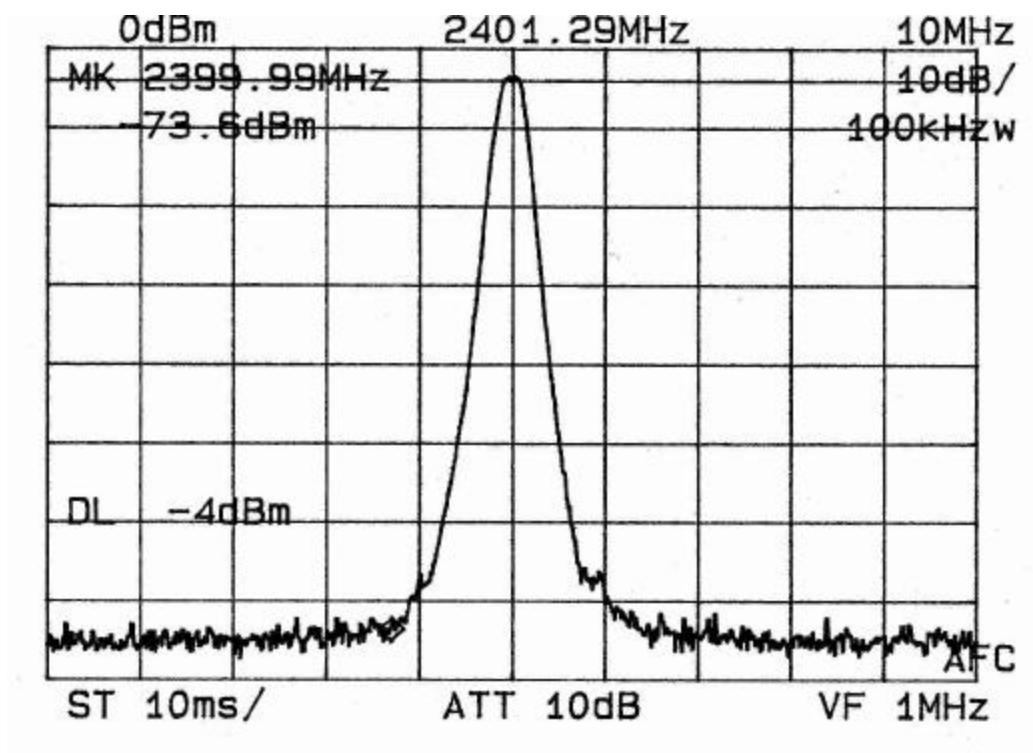



CONDUCTED BAND EDGE EMISSIONS – MODULATED CARRIER (100 kHz RES. BW)

HIGH CHANNEL

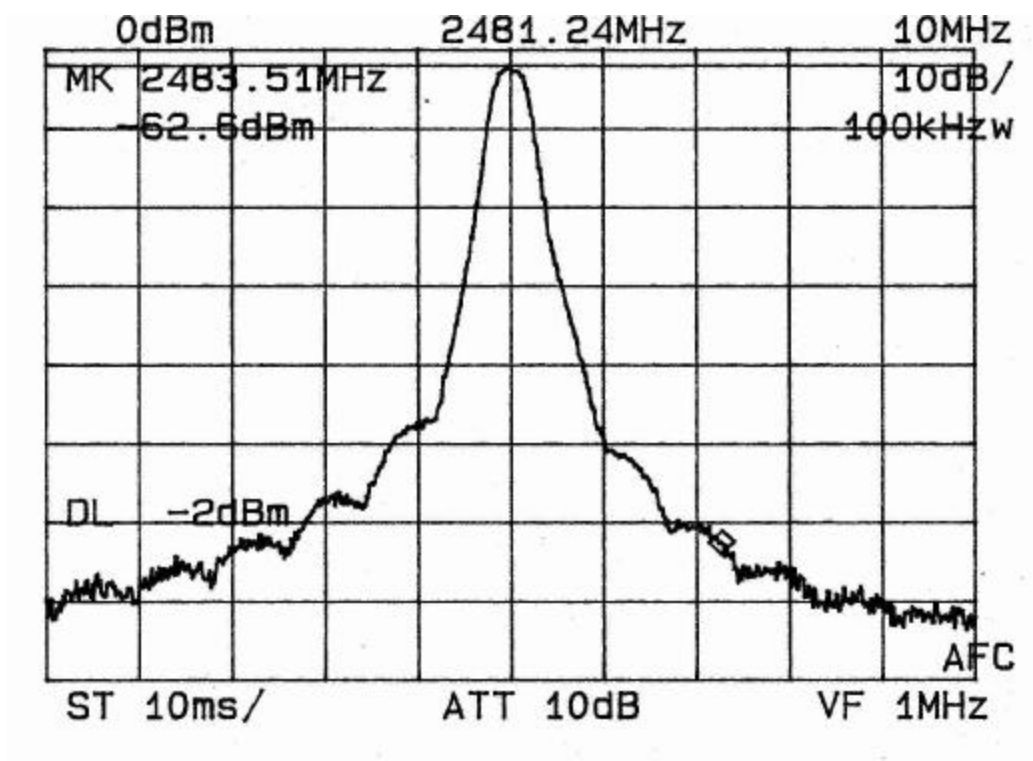

## 5.0 Test Configuration for Conducted and Radiated Emissions:

The EUT was set up on the center of the test table, in a manner which follows the general guidelines of ANSI C63.4, Section 6 “General Operating Conditions and Configurations”.

This is described below:

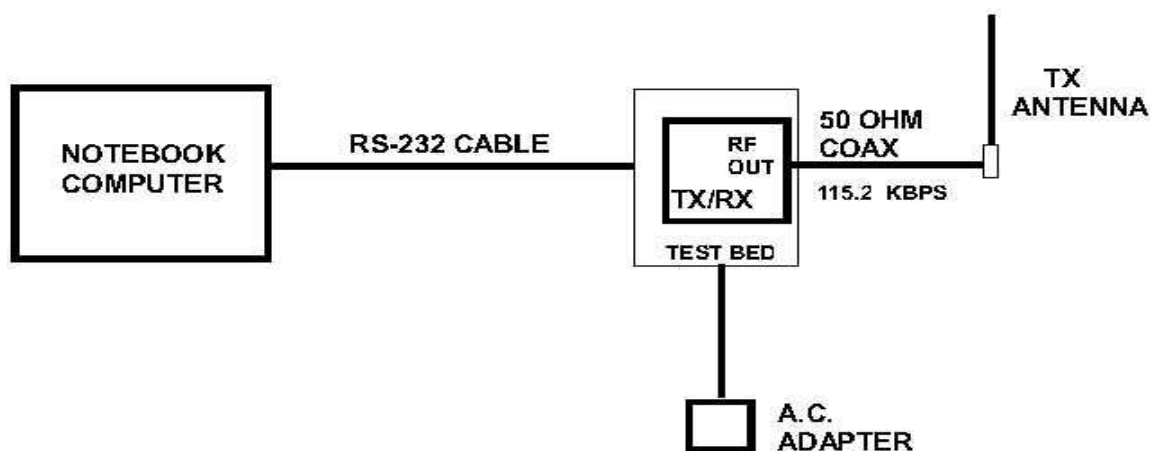

## 6.0 Conducted Emissions Scheme:

The EUT is placed on an 80 cm high X 1.5 m non-conductive table. Power to the RF modem is provided through a Solar Corporation 50 ohm/50 uH Line Impedance Stabilization Network bonded to a 2.2 X 2 meter horizontal ground plane, and a 2.2 X 2 meter vertical ground plane. The LISN has its AC input supplied from a filtered AC power source. A separate LISN provides AC power to the peripheral equipment. I/O cables are moved about to obtain maximum emissions.

The 50 ohm output of the LISN is connected to the input of the spectrum analyzer and emissions in the frequency range of 450 kHz to 30 MHz are searched. The detector function is set to Quasi-Peak and the resolution bandwidth is set at 9 kHz, with all post detector filtering no less than 10 times the resolution bandwidth for final measurements. All emissions within 20 dB of the limit are recorded in the data tables.



## **7.0 Radiated Emissions Scheme:**

The EUT is placed on an 80 cm high X 1.5 meter non-conductive motorized turntable for radiated testing on the 3 meter open area test site. The emissions from the EUT are measured continuously at every azimuth by rotating the turntable. Guided horn and log periodic broadband antennas are mounted on an antenna mast to determine the height of the maximum emissions. The heights of the antennas are varied between 1 and 4 meters. Both the horizontal and vertical field components are measured.

The RF spectrum is searched from 30 MHz to 24 GHz.

The output from the antenna is connected to the input of the preamplifier. The pre-amp out is connected to the spectrum analyzer. The detector function is set to PEAK. The resolution bandwidth of the spectrum analyzer is set at 120kHz for the frequency range of 30-1000 MHz, and 1 MHz for the frequency range of 1-24 GHz. A 10Hz video BW setting is used to average readings above 1 GHz. All emissions within 20 dB of the limit are recorded in the data tables.

To convert the spectrum analyzer reading into a quantified E-field level to allow comparison with the FCC limits, it is necessary to account for various calibration factors. These factors include cable loss (CL) and antenna factors (AF). The AF/CL in dB/m is algebraically added to the Spectrum Analyzer Voltage in dBμV/m. This level is then compared to the FCC limit.

### **EXAMPLE:**

**Spectrum Analyzer Voltage:**                      **VdBmV**

**Composite Factor:**                                      **AF/CL dB/m**

**Electric Field:**                      **E dBmV/m = V dBmV + AF/CL dB/m**

**Linear Conversion:**                      **E mV/m = Antilog (E dBmV/m , 20)**



## FCC CLASS "B" CONDUCTED EMISSIONS DATA

CLIENT: MICROHARD SYSTEMS

EUT: MHX-2400

MODE: TRANSMIT

LINE 1-Neutral: Quasi-Peak Level Date: 06/09/2002

FREQUENCY MHz	SPEC. Ana dBuV	Calc. Volt. uV	FCC LIMIT uV	MARGIN dB	CONDITION
0.47	36.00	63.10	250.00	11.96	PASS
6.20	35.00	56.23	250.00	12.96	PASS
7.20	38.20	81.28	250.00	9.76	PASS
27.50	30.80	34.67	250.00	17.16	PASS

LINE 2-Phase: Quasi-Peak Level

FREQUENCY MHz	SPEC. Ana dBuV	Calc. Volt. uV	FCC LIMIT uV	MARGIN dB	CONDITION
0.52	35.60	60.26	250.00	12.36	PASS
4.80	34.60	53.70	250.00	13.36	PASS
6.20	34.80	54.95	250.00	13.16	PASS
23.90	33.40	46.77	250.00	14.56	PASS
28.40	32.00	39.81	250.00	15.96	PASS

TEST ENGINEER:

Brian Haghtalab



### FCC RADIATED EMISSIONS DATA

**CLIENT:** MICROHARD SYSTEMS  
**EUT:** MHX-2400  
**ANTENNA:** YAGI  
**FREQ.:** 2401.31 MHZ  
**POWER:** 100 mW

**3 METER TEST DETECTOR - PEAK DATE: 06/09/2002**

FREQUENCY MHz	POLARITY		SPEC A dBuV	AF/C dB/m	AMP Gain dB	Average Factor dB	PEAK E-Field dbuV/m	Average Limit dBuV/m	MARGIN dB	CONDITION
	H	V								
4,802.62		V	40.00	35.00	25.00	0.00	50.00	54.00	4.00	PASS
12,006.55	H		32.00	40.00	25.00	0.00	47.00	54.00	7.00	PASS
14,407.86		V	30.00	43.00	25.00	0.00	48.00	54.00	6.00	PASS
19,210.48	H		25.00	36.00	25.00	0.00	36.00	54.00	18.00	PASS

**TEST ENGINEER:**

**Brian Haghtalab**



### FCC RADIATED EMISSIONS DATA

CLIENT: MICROHARD SYSTEMS  
EUT: MHX-2400  
ANTENNA: YAGI  
FREQ.: 2441.22 MHZ  
POWER: 100 mW

3 METER TEST DETECTOR - PEAK DATE: 06/09/2002

FREQUENCY MHz	POLARITY		SPEC A dBuV	AF/C dB/m	AMP Gain dB	Average Factor dB	PEAK E-Field dbuV/m	Average Limit dBuV/m	MARGIN dB	CONDITION
	H	V								
4,882.44	H		39.00	35.00	25.00	0.00	49.00	54.00	5.00	PASS
7,323.66	H		32.00	37.00	25.00	0.00	44.00	54.00	10.00	PASS
12,206.10		V	34.00	40.00	25.00	0.00	49.00	54.00	5.00	PASS
19,529.76	H		26.00	36.00	25.00	0.00	37.00	54.00	17.00	PASS

TEST ENGINEER:

Brian Haghtalab





### FCC RADIATED EMISSIONS DATA

CLIENT: MICROHARD SYSTEMS  
EUT: MHX-2400  
ANTENNA: YAGI  
FREQ.: 2481.26 MHZ  
POWER: 100 mW

3 METER TEST DETECTOR - PEAK DATE: 06/09/2002

FREQUENCY MHz	POLARITY		SPEC A dBuV	AF/C dB/m	AMP Gain dB	Average Factor dB	PEAK E-Field dbuV/m	Average Limit dBuV/m	MARGIN dB	CONDITION
	H	V								
4,962.52	H		39.00	35.00	25.00	0.00	49.00	54.00	5.00	PASS
7,443.78		V	35.00	37.00	25.00	0.00	47.00	54.00	7.00	PASS
12,406.30	H		32.00	40.00	25.00	0.00	47.00	54.00	7.00	PASS
19,850.08		V	25.00	36.00	25.00	0.00	36.00	54.00	18.00	PASS

TEST ENGINEER:

Brian Haghtalab



### FCC RADIATED EMISSIONS DATA

**CLIENT:** MICROHARD SYSTEMS  
**EUT:** MHX-2400  
**ANTENNA:** DUCK  
**FREQ.:** 2401.31 MHZ  
**POWER:** 1.0 Watt

**3 METER TEST DETECTOR - PEAK DATE: 06/09/2002**

FREQUENCY MHz	POLARITY		SPEC A dBuV	AF/C dB/m	AMP Gain dB	Average Factor dB	PEAK E-Field dbuV/m	Average Limit dBuV/m	MARGIN dB	CONDITION
	H	V								
4,802.62		V	40.00	35.00	25.00	0.00	50.00	54.00	4.00	PASS
12,006.55	H		32.00	40.00	25.00	0.00	47.00	54.00	7.00	PASS
14,407.86		V	30.00	43.00	25.00	0.00	48.00	54.00	6.00	PASS
19,210.48	H		25.00	36.00	25.00	0.00	36.00	54.00	18.00	PASS

**TEST ENGINEER:**

**Brian Haghtalab**



### FCC RADIATED EMISSIONS DATA

CLIENT: MICROHARD SYSTEMS  
EUT: MHX-2400  
ANTENNA: DUCK  
FREQ.: 2441.22 MHZ  
POWER: 1.0 Watt

3 METER TEST DETECTOR - PEAK DATE: 06/09/2002

FREQUENCY MHz	POLARITY		SPEC A dBuV	AF/C dB/m	AMP Gain dB	Average Factor dB	PEAK E-Field dbuV/m	Average Limit dBuV/m	MARGIN dB	CONDITION
	H	V								
4,882.44	H		39.00	35.00	25.00	0.00	49.00	54.00	5.00	PASS
7,323.66	H		32.00	37.00	25.00	0.00	44.00	54.00	10.00	PASS
12,206.10		V	34.00	40.00	25.00	0.00	49.00	54.00	5.00	PASS
19,529.76	H		26.00	36.00	25.00	0.00	37.00	54.00	17.00	PASS

TEST ENGINEER:

Brian Haghtalab



### FCC RADIATED EMISSIONS DATA

**CLIENT:** MICROHARD SYSTEMS  
**EUT:** MHX-2400  
**ANTENNA:** DUCK  
**FREQ.:** 2481.26 MHZ  
**POWER:** 1.0 Watt

**3 METER TEST DETECTOR - PEAK DATE: 06/09/2002**

FREQUENCY MHz	POLARITY		SPEC A dBuV	AF/C dB/m	AMP Gain dB	Average Factor dB	PEAK E-Field dbuV/m	Average Limit dBuV/m	MARGIN dB	CONDITION
	H	V								
4,962.52	H		39.00	35.00	25.00	0.00	49.00	54.00	5.00	PASS
7,443.78		V	35.00	37.00	25.00	0.00	47.00	54.00	7.00	PASS
12,406.30	H		32.00	40.00	25.00	0.00	47.00	54.00	7.00	PASS
19,850.08		V	25.00	36.00	25.00	0.00	36.00	54.00	18.00	PASS

**TEST ENGINEER:**

**Brian Haghtalab**



### FCC RADIATED EMISSIONS DATA

CLIENT: MICROHARD SYSTEMS  
EUT: MHX-2400  
ANTENNA: OMNI  
FREQ.: 2401.31 MHZ  
POWER: 1.0 Watt

3 METER TEST DETECTOR - PEAK DATE: 06/09/2002

FREQUENCY MHz	POLARITY		SPEC A dBuV	AF/C dB/m	AMP Gain dB	Average Factor dB	PEAK E-Field dbuV/m	Average Limit dBuV/m	MARGIN dB	CONDITION
	H	V								
4,802.62		V	40.00	35.00	25.00	0.00	50.00	54.00	4.00	PASS
12,006.55	H		32.00	40.00	25.00	0.00	47.00	54.00	7.00	PASS
14,407.86		V	30.00	43.00	25.00	0.00	48.00	54.00	6.00	PASS
19,210.48	H		25.00	36.00	25.00	0.00	36.00	54.00	18.00	PASS

TEST ENGINEER:

Brian Haghtalab



### FCC RADIATED EMISSIONS DATA

**CLIENT:** MICROHARD SYSTEMS  
**EUT:** MHX-2400  
**ANTENNA:** OMNI  
**FREQ.:** 2441.22 MHZ  
**POWER:** 1.0 Watt

**3 METER TEST DETECTOR - PEAK DATE: 06/09/2002**

FREQUENCY MHz	POLARITY		SPEC A dBuV	AF/C dB/m	AMP Gain dB	Average Factor dB	PEAK E-Field dbuV/m	Average Limit dBuV/m	MARGIN dB	CONDITION
	H	V								
4,882.44	H		39.00	35.00	25.00	0.00	49.00	54.00	5.00	PASS
7,323.66	H		32.00	37.00	25.00	0.00	44.00	54.00	10.00	PASS
12,206.10		V	34.00	40.00	25.00	0.00	49.00	54.00	5.00	PASS
19,529.76	H		26.00	36.00	25.00	0.00	37.00	54.00	17.00	PASS

**TEST ENGINEER:**

**Brian Haghtalab**



### FCC RADIATED EMISSIONS DATA

**CLIENT:** MICROHARD SYSTEMS  
**EUT:** MHX-2400  
**ANTENNA:** OMNI  
**FREQ.:** 2481.26 MHZ  
**POWER:** 1.0 Watt

**3 METER TEST DETECTOR - PEAK DATE: 06/09/2002**

FREQUENCY MHz	POLARITY		SPEC A dBuV	AF/C dB/m	AMP Gain dB	Average Factor dB	PEAK E-Field dbuV/m	Average Limit dBuV/m	MARGIN dB	CONDITION
	H	V								
4,962.52	H		39.00	35.00	25.00	0.00	49.00	54.00	5.00	PASS
7,443.78		V	35.00	37.00	25.00	0.00	47.00	54.00	7.00	PASS
12,406.30	H		32.00	40.00	25.00	0.00	47.00	54.00	7.00	PASS
19,850.08		V	25.00	36.00	25.00	0.00	36.00	54.00	18.00	PASS

**TEST ENGINEER:**

**Brian Haqhtalab**



### FCC RADIATED EMISSIONS DATA

CLIENT: MICROHARD SYSTEMS  
EUT: MHX-2400  
ANTENNA: TRANSIT  
FREQ.: 2401.31 MHZ  
POWER: 1.0 Watt

3 METER TEST DETECTOR - PEAK DATE: 06/09/2002

FREQUENCY MHz	POLARITY		SPEC A dBuV	AF/C dB/m	AMP Gain dB	Average Factor dB	PEAK E-Field dbuV/m	Average Limit dBuV/m	MARGIN dB	CONDITION
	H	V								
4,802.62		V	40.00	35.00	25.00	0.00	50.00	54.00	4.00	PASS
12,006.55	H		32.00	40.00	25.00	0.00	47.00	54.00	7.00	PASS
14,407.86		V	30.00	43.00	25.00	0.00	48.00	54.00	6.00	PASS
19,210.48	H		25.00	36.00	25.00	0.00	36.00	54.00	18.00	PASS

TEST ENGINEER:

Brian Haghtalab





### FCC RADIATED EMISSIONS DATA

CLIENT: MICROHARD SYSTEMS  
EUT: MHX-2400  
ANTENNA: TRANSIT  
FREQ.: 2441.22 MHZ  
POWER: 1.0 Watt

3 METER TEST DETECTOR - PEAK DATE: 06/09/2002

FREQUENCY MHz	POLARITY		SPEC A dBuV	AF/C dB/m	AMP Gain dB	Average Factor dB	PEAK E-Field dbuV/m	Average Limit dBuV/m	MARGIN dB	CONDITION
	H	V								
4,882.44	H		39.00	35.00	25.00	0.00	49.00	54.00	5.00	PASS
7,323.66	H		32.00	37.00	25.00	0.00	44.00	54.00	10.00	PASS
12,206.10		V	34.00	40.00	25.00	0.00	49.00	54.00	5.00	PASS
19,529.76	H		26.00	36.00	25.00	0.00	37.00	54.00	17.00	PASS

TEST ENGINEER:

Brian Haghtalab



### FCC RADIATED EMISSIONS DATA

CLIENT: MICROHARD SYSTEMS  
EUT: MHX-2400  
ANTENNA: TRAN  
FREQ.: 2481.26 MHz  
POWER: 1.0 Watt

3 METER TEST DETECTOR - PEAK DATE: 06/09/2002

FREQUENCY MHz	POLARITY		SPEC A dBuV	AF/C dB/m	AMP Gain dB	Average Factor dB	PEAK E-Field dbuV/m	Average Limit dBuV/m	MARGIN dB	CONDITION
	H	V								
4,962.52	H		39.00	35.00	25.00	0.00	49.00	54.00	5.00	PASS
7,443.78		V	35.00	37.00	25.00	0.00	47.00	54.00	7.00	PASS
12,406.30	H		32.00	40.00	25.00	0.00	47.00	54.00	7.00	PASS
19,850.08		V	25.00	36.00	25.00	0.00	36.00	54.00	18.00	PASS

TEST ENGINEER:

Brian Haghtalab



**Table 1**  
**Support Equipment**

1. Host PC - Toshiba 740C Pentium Notebook
2. Microhard MHX-2400 Development Board (testing platform)



## Table 2

### Interface Cables Used

1. A 1.2 meter RS-232 serial shielded cable is used to connect the EUT to the Host computer.
2. Two feet of low-loss coaxial cable used to connect the EUT to the TX antenna (Reverse Polarity SMA to N connectors).



**Table 3**

**Measurement Equipment Used**

The following equipment is used to perform measurements:

HP 435A RF Peak Power Meter	- Serial No. 1362016
EMCO Model 3110 Biconical Antenna	- Serial No. 1619
Antenna Research MWH-1825B Horn Antenna	- Serial No. 1005
EMCO Model 3115 Ridged Horn Antenna	- Serial No. 3007
HP 8348A Preamplifier	- Serial No. 197-2564A
Solar 8012-50-R-24-BNC LISN	- Serial No. 924867
Bird 8306-300-N 30dB Attenuator	- S/N: 29198391515
HP 14IT w/8555A Spectrum Analyzer	- Serial No. 6-95-1124
4 Meter Antenna Mast	
Motorized Turntable	
Heliac FSJ1-50A 1/4" Superflex Coax Cable (12 Ft.)	