

National Certification Laboratory

**8370 Court Avenue, Suite B-1
Ellicott City, Maryland 21043
(410) 461-5548**

FCC REPORT OF RADIO INTERFERENCE

FOR

**Microhard Systems, Inc.
#110, 1144 – 29th Ave., N.E.
Calgary
Alberta, Canada T2E 7P1**

FCC ID: NS900P3

May 20, 2002



TABLE OF CONTENTS

- 1.0 Introduction
- 1.1 Summary
- 2.0 Description of Equipment Under Test (EUT)
 - 2.1 EMI Countermeasure
- 3.0 Test Program
- 4.0 Test Configuration
- 5.0 Conducted Emissions Scheme
- 6.0 Radiated Emissions Scheme

TABLES

- Table 1. Support Equipment
- Table 2. Interface Cables
- Table 3. Measurement Equipment

EXHIBITS

- Exhibit 1. EUT Photographs
- Exhibit 2. Schematic Diagram
- Exhibit 3. User Manual

NCL PROJ.# Microhard-557



1.0 Introduction:

This report has been prepared on behalf of **Microhard Systems, Inc.**, to support the attached Application for a Class II Change of a Part 15 Spread Spectrum Transmitter module. The Equipment Under Test (EUT) was the Model: **COMPACTRF-900 Wireless Modem Transceiver OEM Module**.

Radio-Noise Emissions tests were performed according to *FCC Public Notice 54797, titled "Guidance on Measurement for Direct Sequence SST"*. The measuring equipment conforms to ANSI C63.2 Specifications for Electromagnetic Noise and Field Strength Instrumentation.

Testing was performed at National Certification Laboratory in Ellicott City, MD. Site description and site attenuation data have been placed on file with the FCC's sampling and Measurements Branch. FCC acceptance was granted on May 26, 1993.

1.1 Summary:

The Microhard Systems, Inc., Model: **COMPACTRF-900 Wireless Modem Transceiver OEM Module** complies with the FCC limits (15.247) for a Frequency Hopping SST.

1.2 Changes made to the system are as follows:

- Now Using a MCX connector
- Reset circuit for microprocesor
- Compatabile Microprocessors
the ATMEG 103 and ATMEG 128
- Added antennas to test set
- Added Temperature compensation Circuit
- Added transistor buffering



2.0 Description of Equipment Under Test (EUT):

The EUT features:

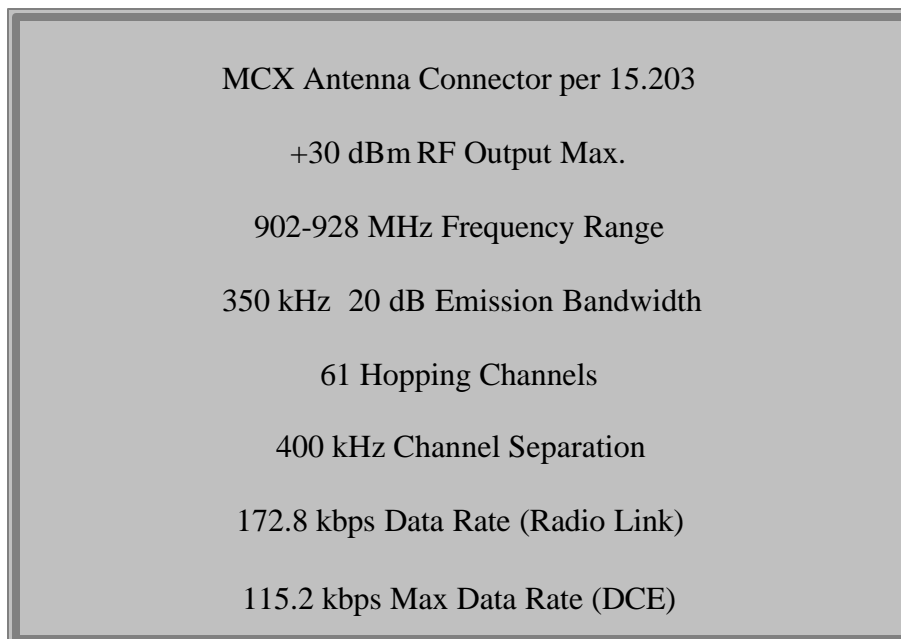

3.0 Test Program:

This report contains measurement charts and data as evidence for the following tests performed:

1. (15.247b) Peak RF output power.
2. (15.247c) Field Strength of harmonics and spurious out-of-band emissions.
3. (15.247c) RF Antenna Conducted of harmonics and spurious out-of-band emissions.
4. (15.247a) 20 dB Emission Bandwidth.
5. (15.207) Power Line Conducted Emissions.
6. (15.247c) Band Edge emissions.



4.0 Test Configuration:

RF antenna output tests such as Bandwidth, Spurious/Harmonics, Power output, were taken with the transmitter antenna connector feeding directly into the spectrum analyzer via external 30 db attenuator. The analyzer's internal attenuator was adjusted to prevent overloading of the front end. The transmitter is modulated at 115.2 kbps which is the highest available data rate.

Field strength measurements were taken with the transmitter feeding a yagi, or omni antenna aimed at the receiving antenna. Testing was performed using the highest gain antenna from each design family (yagi, omni) with the power setting at 1 Watt for the omni antenna, and 100 mW for the higher gain yagi.

A list of newly added antennas that will be sold with the **COMPACTRF900** Wireless Module follows:

<u>Microhard PN</u>	<u>Description</u>
83121	3.5 dB, Transit Antenna 900 MHz Use with a Ground Plane
83122	3.5 dB, 900 MHz Transit Antenna Use with No Ground Plane
83225	3/4" Brass Transit Mounting Kit, c/w 6ft LMR-195 cable and conn
83220	Transit antenna magnetic mount
83132	6 dB, 5 ft. length, 900 MHz Omni-directional Antenna
83140	11 dB, 900 MHz Yagi Directional Antenna
83130	6 dB, 900 MHz Yagi Directional Antenna
83100	Rubber Ducky 900 MHz
83125	3dB Omni Antenna 900 MHz



PEAK POWER TEST RESULTS

Limit: 1 watt (30 dBm)

Condition: Transmitter is set to a single FM modulated channel

Reading from spectrum analyzer with 1 MHz Resolution Bandwidth setting:

Channel 1: 902.8 MHz - (+29.8 dBm)

Channel 62: 914.7 MHz - (+30.0 dBm)

Channel 123: 927.1 MHz - (+29.8 dBm)

SEE FOLLOWING THREE (3) PLOTS OF MODULATED CARRIER



PEAK RF POWER – MODULATED CARRIER (1 MHz RES. BW)

Channel 1

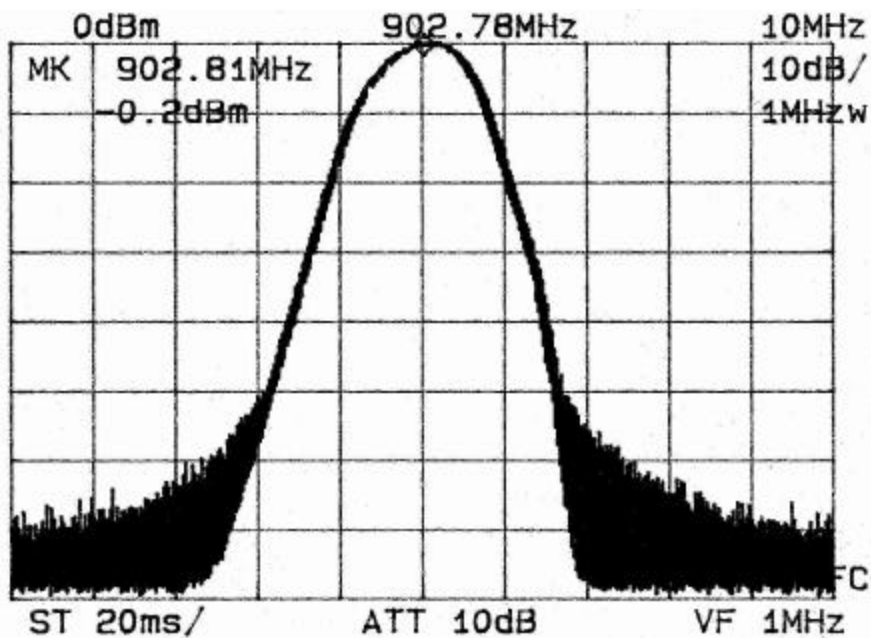



PEAK RF POWER – MODULATED CARRIER (1 MHz RES. BW)

Channel 62

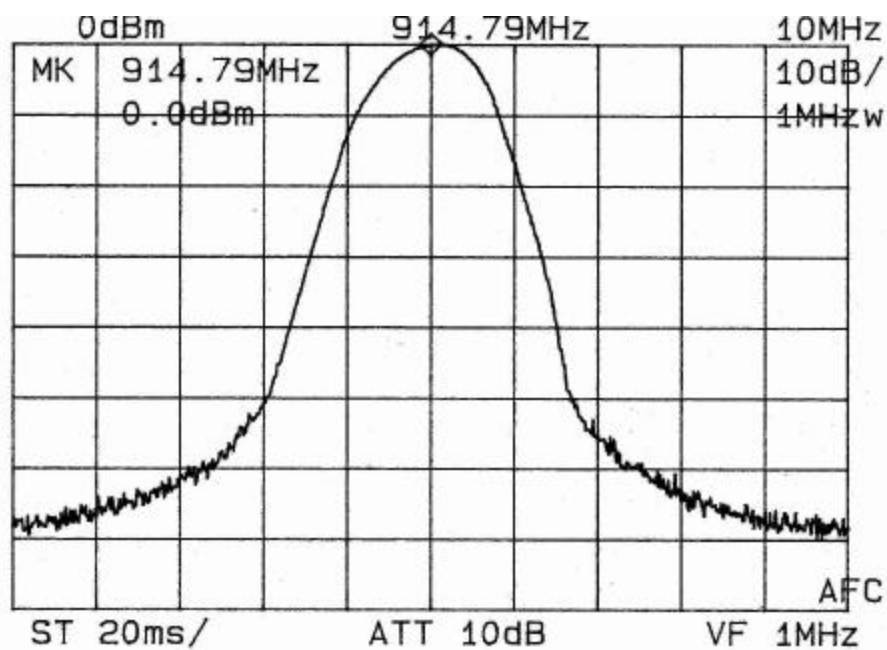



PEAK RF POWER – MODULATED CARRIER (1 MHz RES. BW)

Channel 123

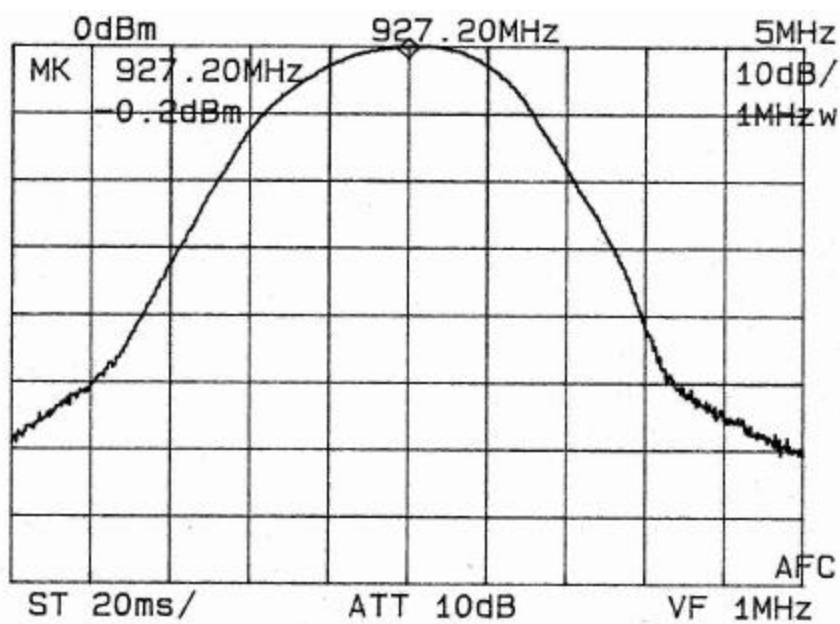



20 dB EMISSION BANDWIDTH

Maximum 20 dB BW: 0.500 MHz
RBW Setting on S.A.: 10 kHz

Condition: Transmitter is set to a single channel FM modulated at 115.2 kbps

Reading from Spectrum Analyzer:

Channel 1:	902.8 MHz	-	342 kHz
Channel 32:	914.7 MHz	-	346 kHz
Channel 64:	927.1 MHz	-	350 kHz

SEE FOLLOWING THREE (3) PLOTS OF MODULATED CARRIER



20 dB EMISSION BANDWIDTH – MODULATED CARRIER (10 kHz RES. BW)

Channel 1

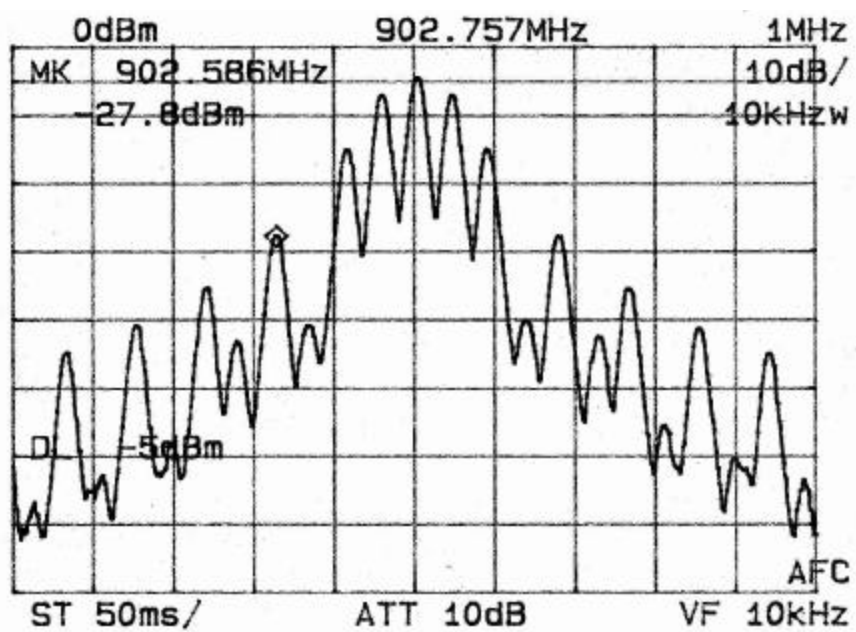



20 dB EMISSION BANDWIDTH – MODULATED CARRIER (10 kHz RES. BW)

Channel 62

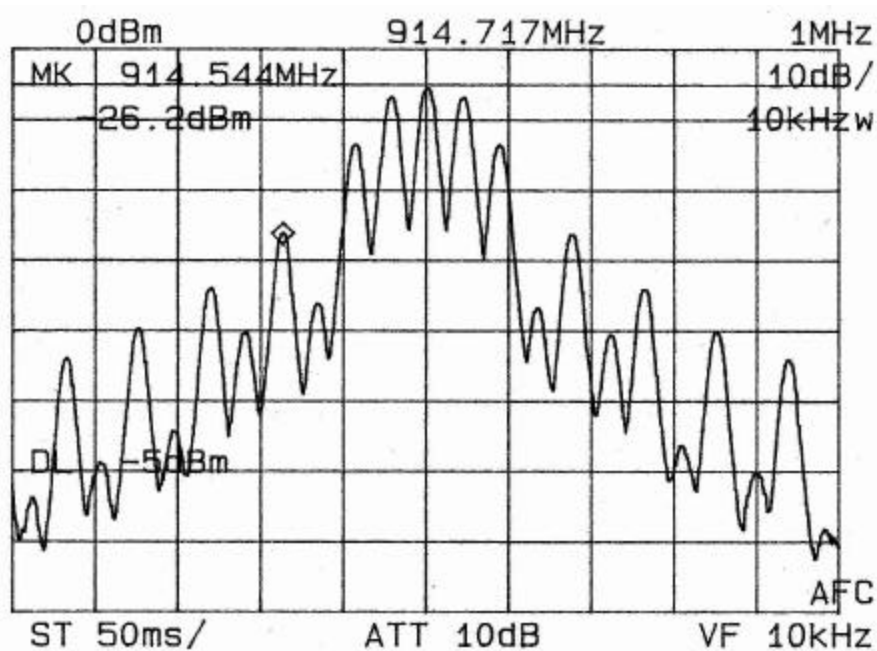



20 dB EMISSION BANDWIDTH – MODULATED CARRIER (10 kHz RES. BW)

Channel 123

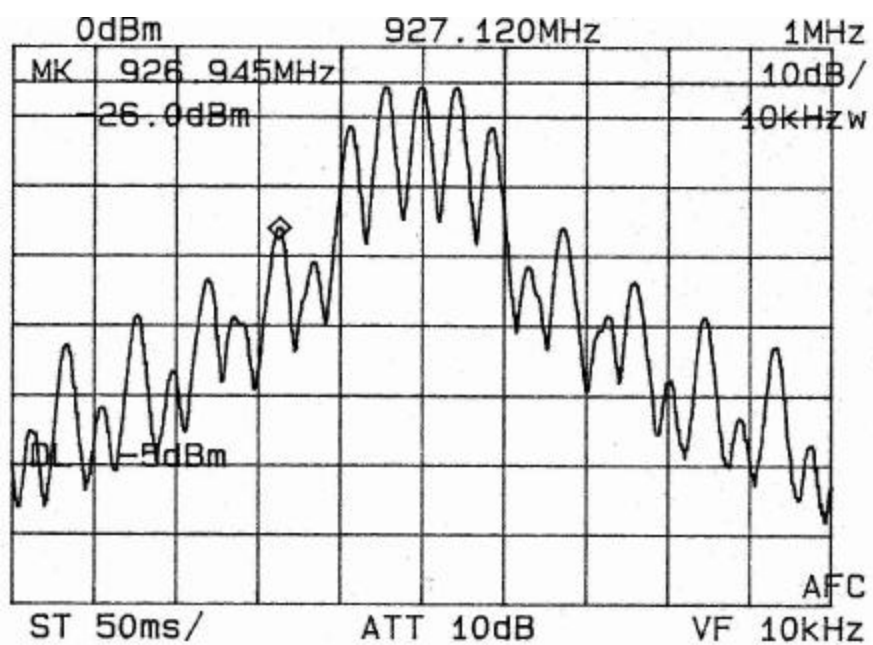



RF ANTENNA CONDUCTED SPURIOUS/HARMONICS EMISSIONS

Limit: 20 dB below Carrier Level Measured with 100 kHz RBW

RBW Setting on S.A.: 100 kHz

Condition: Transmitter is set to a single FM modulated channel.
RF Power = 30 dBm

Three separate measurements are performed to show harmonic and spurious emissions generated with the transmitter tuned to low, middle, and high parts of the spectral range.

SEE FOLLOWING THREE (3) PLOTS & DATA TABLES



FCC Part 15.247(c) – Conducted Spurious Emissions

Frequency of Carrier = 902.8 MHz

Limit = 20 dBc

Condition: Transmitter is set to a single FM modulated channel.

TEST RESULTS

LIMIT: -20 dB FROM PEAK CARRIER

<u>Component</u>	<u>Frequency (MHz)</u>	<u>Result (dB From Peak)</u>
Harmonic	1805.60	-50.0
Harmonic	2708.40	-73.0
Harmonic	3611.20	-73.0
Harmonic	4514.00	-74.0
Harmonic	5416.80	-74.0
Harmonic	6319.60	-75.0
Harmonic	7222.40	-75.0
Harmonic	8125.20	-75.0
Harmonic	9028.00	-75.0



FCC Part 15.247(c) – Conducted Spurious Emissions

Frequency of Carrier = 914.70 MHz

Limit = 20 dBc

Condition: Transmitter is set to a single FM modulated channel.

TEST RESULTS

LIMIT: -20 dB FROM PEAK CARRIER

<u>Component</u>	<u>Frequency (MHz)</u>	<u>Result (dB From Peak)</u>
Harmonic	1829.40	-50.4
Harmonic	2744.10	-73.0
Harmonic	3658.80	-73.0
Harmonic	4573.50	-73.0
Harmonic	5488.20	-74.0
Harmonic	6402.90	-74.0
Harmonic	7317.60	-75.0
Harmonic	8232.30	-75.0
Harmonic	9147.00	-75.0



FCC Part 15.247(c) – Conducted Spurious Emissions

Frequency of Carrier = 927.1 MHz

Limit = 20 dBc

Condition: Transmitter is set to a single FM modulated channel.

TEST RESULTS

LIMIT: -20 dB FROM PEAK CARRIER

<u>Component</u>	<u>Frequency (MHz)</u>	<u>Result (dB From Peak)</u>
Harmonic	1854.20	-49.4
Harmonic	2781.30	-73.0
Harmonic	3708.40	-73.0
Harmonic	4635.50	-73.0
Harmonic	5562.60	-74.0
Harmonic	6489.70	-74.0
Harmonic	7416.80	-74.0
Harmonic	8343.90	-75.0
Harmonic	9271.00	-75.0



CONDUCTED HARMONICS EMISSIONS – MODULATED CARRIER (100 kHz RES. BW)

LOW CHANNEL

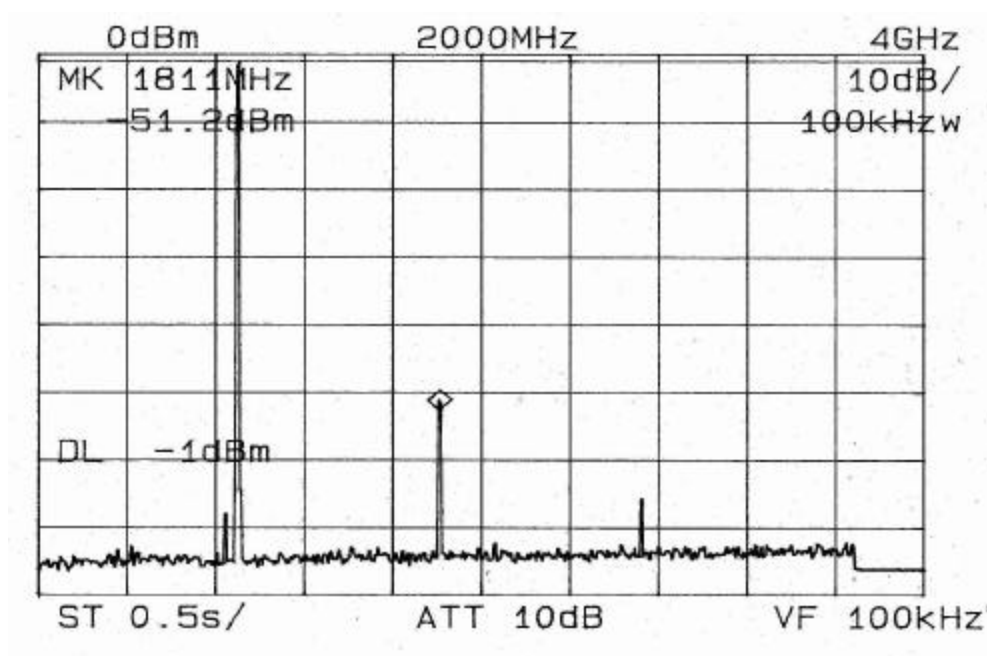

0 Fc 2Fc 3Fc 4Fc



CONDUCTED HARMONICS EMISSIONS- MODULATED CARRIER (100 kHz RES. BW)

MID CHANNEL

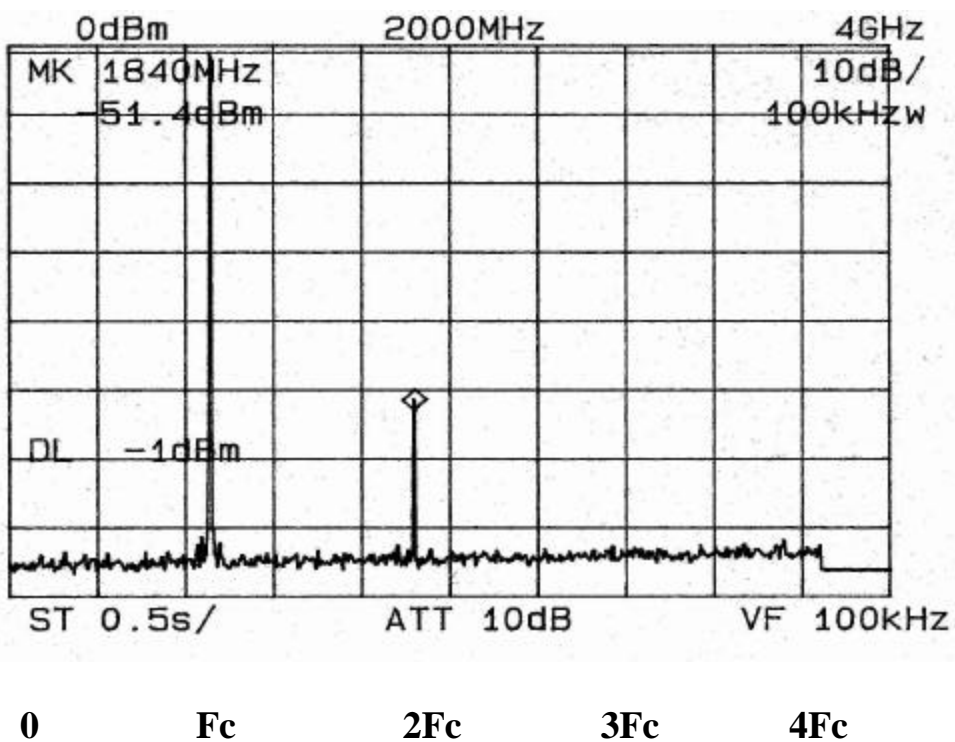



CONDUCTED HARMONICS EMISSIONS – MODULATED CARRIER (100 kHz RES. BW)

HIGH CHANNEL

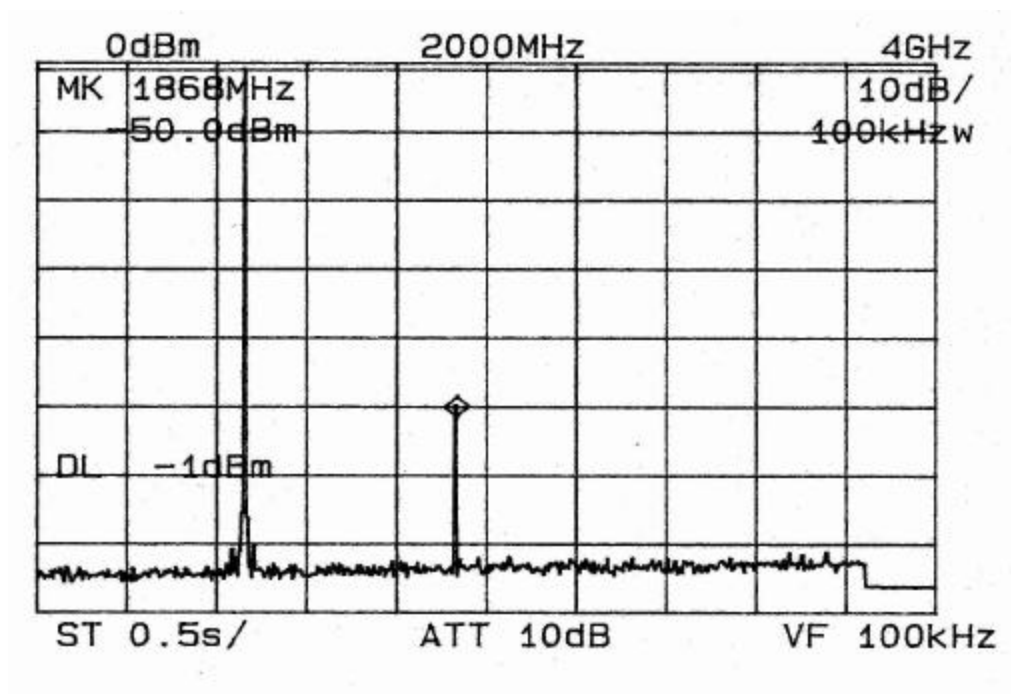

0 Fc 2Fc 3Fc 4Fc



CONDUCTED BAND EDGE EMISSIONS – MODULATED CARRIER (100 kHz RES. BW)

LOW CHANNEL

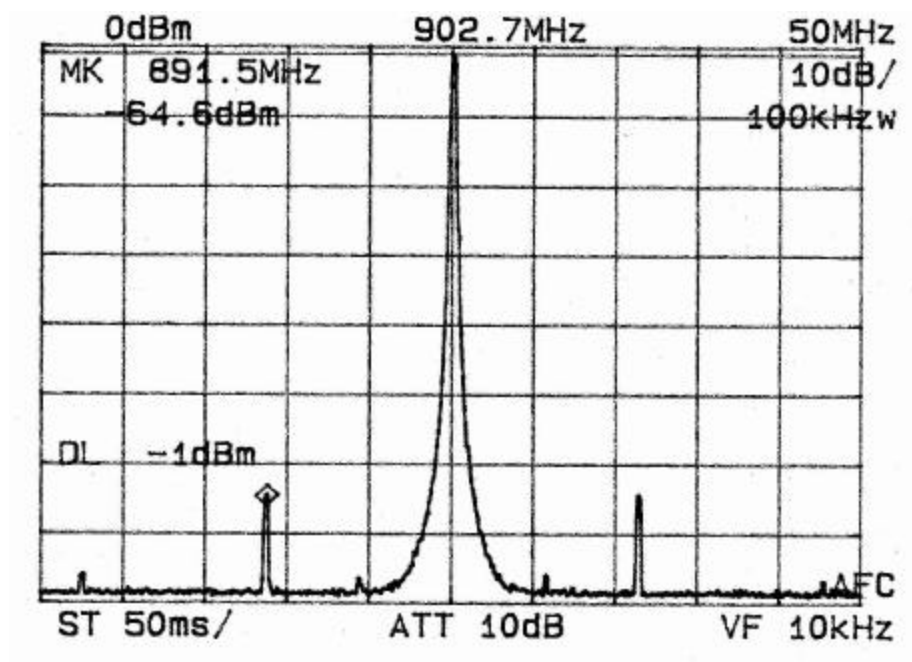



CHANNEL UTILIZATION – HOPPING SEQUENCE (10 kHz RES. BW)

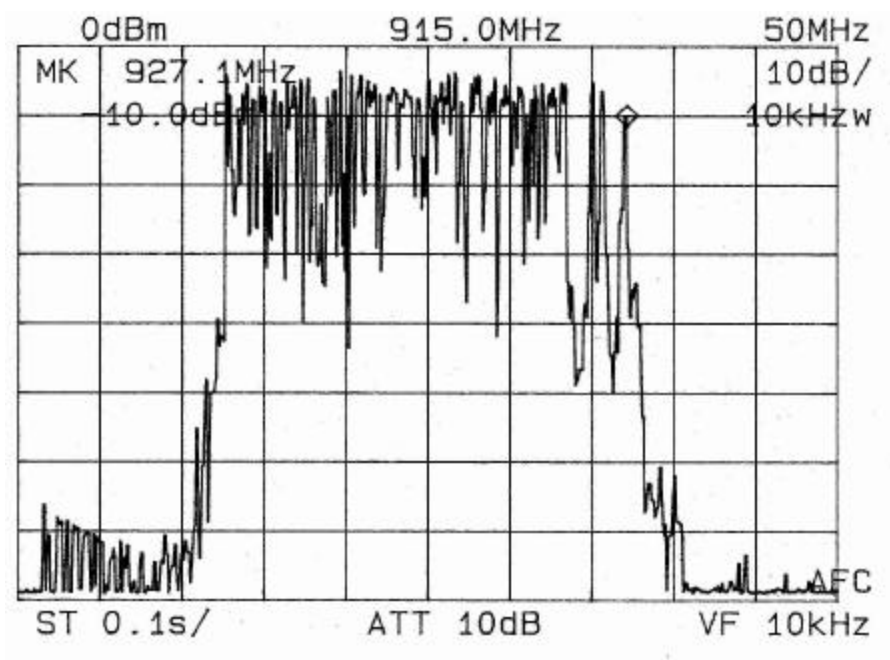

5.0 Test Configuration for Conducted and Radiated Emissions:

The EUT was set up on the center of the test table, in a manner which follows the general guidelines of ANSI C63.4, Section 6 “General Operating Conditions and Configurations”.

This is described below:

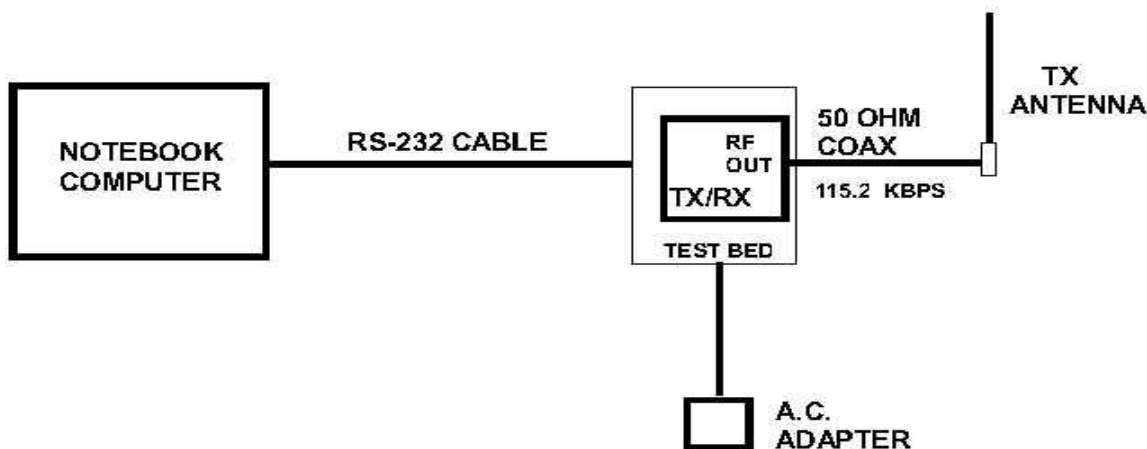

6.0 Conducted Emissions Scheme:

The EUT is placed on an 80 cm high X 1.5 m non-conductive table. Power to the RF modem is provided through a Solar Corporation 50 ohm/50 uH Line Impedance Stabilization Network bonded to a 2.2 X 2 meter horizontal ground plane, and a 2.2 X 2 meter vertical ground plane. The LISN has its AC input supplied from a filtered AC power source. A separate LISN provides AC power to the peripheral equipment. I/O cables are moved about to obtain maximum emissions.

The 50 ohm output of the LISN is connected to the input of the spectrum analyzer and emissions in the frequency range of 450 kHz to 30 MHz are searched. The detector function is set to Quasi-Peak and the resolution bandwidth is set at 9 kHz, with all post detector filtering no less than 10 times the resolution bandwidth for final measurements. All emissions within 20 dB of the limit are recorded in the data tables.



7.0 Radiated Emissions Scheme:

The EUT is placed on an 80 cm high X 1.5 meter non-conductive motorized turntable for radiated testing on the 3 meter open area test site. The emissions from the EUT are measured continuously at every azimuth by rotating the turntable. Guided horn and log periodic broadband antennas are mounted on an antenna mast to determine the height of the maximum emissions. The heights of the antennas are varied between 1 and 4 meters. Both the horizontal and vertical field components are measured.

The RF spectrum is searched from 30 MHz to 9.28 GHz.

The output from the antenna is connected to the input of the preamplifier. The pre-amp out is connected to the spectrum analyzer. The detector function is set to PEAK. The resolution bandwidth of the spectrum analyzer is set at 120kHz for the frequency range of 30-1000 MHz, and 1 MHz for the frequency range of 1-9 GHz. A 10Hz video BW setting is used to average readings above 1 GHz. All emissions within 20 dB of the limit are recorded in the data tables.

To convert the spectrum analyzer reading into a quantified E-field level to allow comparison with the FCC limits, it is necessary to account for various calibration factors. These factors include cable loss (CL) and antenna factors (AF). The AF/CL in dB/m is algebraically added to the Spectrum Analyzer Voltage in dB μ V/m. This level is then compared to the FCC limit.

EXAMPLE:

Spectrum Analyzer Voltage: **VdBmV**

Composite Factor: **AF/CL dB/m**

Electric Field: **E dBmV/m = V dBmV + AF/CL dB/m**

Linear Conversion: **E mV/m = Antilog (E dBmV/m , 20)**



FCC CLASS "B" CONDUCTED EMISSIONS DATA

CLIENT: MICROHARD SYSTEMS
EUT: COMPACTRF900

MODE: TRANSMIT

LINE 1-Neutral: Quasi-Peak Level **Date:** 05/18/2002

FREQUENCY MHz	SPEC. Ana dBuV	Calc. Volt. uV	FCC LIMIT uV	MARGIN dB	CONDITION
0.47	36.00	63.10	250.00	11.96	PASS
6.20	35.00	56.23	250.00	12.96	PASS
7.20	38.20	81.28	250.00	9.76	PASS
27.50	30.80	34.67	250.00	17.16	PASS

LINE 2-Phase: Quasi-Peak Level

FREQUENCY MHz	SPEC. Ana dBuV	Calc. Volt. uV	FCC LIMIT uV	MARGIN dB	CONDITION
0.52	35.60	60.26	250.00	12.36	PASS
4.80	34.60	53.70	250.00	13.36	PASS
6.20	34.80	54.95	250.00	13.16	PASS
23.90	33.40	46.77	250.00	14.56	PASS
28.40	32.00	39.81	250.00	15.96	PASS

TEST ENGINEER:

Brian Haghtalab



FCC RADIATED EMISSIONS DATA

CLIENT: MICROHARD SYSTEMS
EUT: COMPACTRF900
ANTENNA: 11 dBi YAGI
FREQ.: 902.8 MHZ
POWER: 100 mW

3 METER TEST

PEAK DETECT

DATE: 05/18/2002

FREQUENCY MHz	POLARITY		SPEC A dBuV	AF/C dB/m	AMP Gain dB	Average Factor dB	Peak E-Field dbuV/m	Average Limit dBuV/m	MARGIN dB	CONDITION
	H	V								
2,708.40	H		37.00	35.00	25.00	0.00	47.00	54.00	7.00	PASS
3,611.20		V	35.00	36.00	25.00	0.00	46.00	54.00	8.00	PASS
4,514.00	H		35.00	39.00	25.00	0.00	49.00	54.00	5.00	PASS
5,416.80	H		33.00	37.00	25.00	0.00	45.00	54.00	9.00	PASS
8,125.20	H		31.00	38.00	25.00	0.00	44.00	54.00	10.00	PASS
9,028.00	H		27.00	39.00	25.00	0.00	41.00	54.00	13.00	PASS



FCC RADIATED EMISSIONS DATA

CLIENT: MICROHARD SYSTEMS
EUT: COMPACT RF 900
ANTENNA: 11 dBi YAGI
FREQ.: 914.7 MHZ
POWER: 100 mW

3 METER TEST PEAK DETECT DATE: 05/18/2002

FREQUENCY MHz	POLARITY		SPEC A dBuV	AF/C dB/m	AMP Gain dB	Average Factor dB	Peak E-Field dbuV/m	Average Limit dBuV/m	MARGIN dB	CONDITION
	H	V								
2,744.10	H		37.00	35.00	25.00	0.00	47.00	54.00	7.00	PASS
3,658.80	H		33.00	36.00	25.00	0.00	44.00	54.00	10.00	PASS
4,573.50	H		32.00	39.00	25.00	0.00	46.00	54.00	8.00	PASS
7,317.60		V	30.00	37.00	25.00	0.00	42.00	54.00	12.00	PASS
8,232.30		V	28.00	38.00	25.00	0.00	41.00	54.00	13.00	PASS
9,147.00	H		27.00	39.00	25.00	0.00	41.00	54.00	13.00	PASS



FCC RADIATED EMISSIONS DATA

CLIENT: MICROHARD SYSTEMS
EUT: COMPACTRF900
ANTENNA: 11 dBi YAGI
FREQ.: 927.1 MHZ
POWER: 100 mW

3 METER TEST

DATE: 05/18/2002

FREQUENCY MHz	POLARITY		SPEC A dBuV	AF/C dB/m	AMP Gain dB	Average Factor dB	Peak E-Field dbuV/m	Average Limit dBuV/m	MARGIN dB	CONDITION
	H	V								
2,781.30	H		37.00	35.00	25.00	0.00	47.00	54.00	7.00	PASS
3,708.40	H		34.00	36.00	25.00	0.00	45.00	54.00	9.00	PASS
4,635.50		V	30.00	39.00	25.00	0.00	44.00	54.00	10.00	PASS
7,416.80		V	30.00	37.00	25.00	0.00	42.00	54.00	12.00	PASS
8,343.90	H		26.00	38.00	25.00	0.00	39.00	54.00	15.00	PASS



FCC RADIATED EMISSIONS DATA

CLIENT: MICROHARD SYSTEMS
EUT: COMPACT RF900
ANTENNA: RUBBER DUCK
FREQ.: 902.8 MHZ
POWER: 1000 mW

3 METER TEST PEAK DETECT DATE: 05/18/2002

FREQUENCY MHz	POLARITY		SPEC A dBuV	AF/C dB/m	AMP Gain dB	Average Factor dB	Peak E-Field dbuV/m	Average Limit dBuV/m	MARGIN dB	CONDITION
	H	V								
2,708.40	H	V	35.00	35.00	25.00	0.00	45.00	54.00	9.00	PASS
3,611.20			34.00	36.00	25.00	0.00	45.00	54.00	9.00	PASS
4,514.00	H		31.00	39.00	25.00	0.00	45.00	54.00	9.00	PASS
5,416.80	H		29.00	37.00	25.00	0.00	41.00	54.00	13.00	PASS
8,125.20	H		28.00	38.00	25.00	0.00	41.00	54.00	13.00	PASS
9,028.00	H		26.00	39.00	25.00	0.00	40.00	54.00	14.00	PASS



FCC RADIATED EMISSIONS DATA

CLIENT: MICROHARD SYSTEMS
EUT: COMPACTRF900
ANTENNA: Rubber Ducky
FREQ.: 914.7 MHZ
POWER: 1000 mW

3 METER TEST

DATE: 05/18/2002

FREQUENCY MHz	POLARITY		SPEC A dBuV	AF/C dB/m	AMP Gain dB	Average Factor dB	Peak E-Field dbuV/m	Average Limit dBuV/m	MARGIN dB	CONDITION
	H	V								
2,744.10	H		36.00	35.00	25.00	0.00	46.00	54.00	8.00	PASS
3,658.80	H		33.00	36.00	25.00	0.00	44.00	54.00	10.00	PASS
4,573.50	H		32.00	39.00	25.00	0.00	46.00	54.00	8.00	PASS
7,317.60		V	32.00	37.00	25.00	0.00	44.00	54.00	10.00	PASS
8,232.30		V	30.00	38.00	25.00	0.00	43.00	54.00	11.00	PASS
9,147.00	H		26.00	39.00	25.00	0.00	40.00	54.00	14.00	PASS

TEST ENGINEER:

Brian Haghtalab



FCC RADIATED EMISSIONS DATA

CLIENT: MICROHARD SYSTEMS
EUT: COMPACTRF900
ANTENNA: RUBER DUCK
FREQ.: 927.1 MHZ
POWER: 1000 mW

3 METER TEST

DATE: 05/18/2002

FREQUENCY MHz	POLARITY		SPEC A dBuV	AF/C dB/m	AMP Gain dB	Average Factor dB	Peak E-Field dbuV/m	Average Limit dBuV/m	MARGIN dB	CONDITION
	H	V								
2,781.30	H		36.00	35.00	25.00	0.00	46.00	54.00	8.00	PASS
3,708.40	H		36.00	36.00	25.00	0.00	47.00	54.00	7.00	PASS
4,635.50	H		31.00	39.00	25.00	0.00	45.00	54.00	9.00	PASS
7,416.80	H		30.00	37.00	25.00	0.00	42.00	54.00	12.00	PASS
8,343.90	H		26.00	38.00	25.00	0.00	39.00	54.00	15.00	PASS



FCC RADIATED EMISSIONS DATA

CLIENT: MICROHARD SYSTEMS
EUT: COMPACT RF900
ANTENNA: 6 dBi OMNI
FREQ.: 902.8 MHZ
POWER: 1000 mW

3 METER TEST PEAK DETECT DATE: 05/18/2002

FREQUENCY MHz	POLARITY		SPEC A dBuV	AF/C dB/m	AMP Gain dB	Average Factor dB	Peak E-Field dbuV/m	Average Limit dBuV/m	MARGIN dB	CONDITION
	H	V								
2,708.40	H		37.00	35.00	25.00	0.00	47.00	54.00	7.00	PASS
3,611.20	H		35.00	36.00	25.00	0.00	46.00	54.00	8.00	PASS
4,514.00	H		29.00	39.00	25.00	0.00	43.00	54.00	11.00	PASS
5,416.80	H		30.00	37.00	25.00	0.00	42.00	54.00	12.00	PASS
8,125.20	H		30.00	38.00	25.00	0.00	43.00	54.00	11.00	PASS
9,028.00		V	25.00	39.00	25.00	0.00	39.00	54.00	15.00	PASS



FCC RADIATED EMISSIONS DATA

CLIENT: MICROHARD SYSTEMS
EUT: COMPACT RF900
ANTENNA: 6dBi OMNI
FREQ.: 914.7 MHZ
POWER: 1000 mW

3 METER TEST

PEAK DETECT

DATE: 05/18/2002

FREQUENCY MHz	POLARITY		SPEC A dBuV	AF/C dB/m	AMP Gain dB	Average Factor dB	Peak E-Field dbuV/m	Average Limit dBuV/m	MARGIN dB	CONDITION
	H	V								
2,744.10	H		37.00	35.00	25.00	0.00	47.00	54.00	7.00	PASS
3,658.80		V	33.00	36.00	25.00	0.00	44.00	54.00	10.00	PASS
4,573.50	H		34.00	39.00	25.00	0.00	48.00	54.00	6.00	PASS
7,317.60	H		32.00	37.00	25.00	0.00	44.00	54.00	10.00	PASS
8,232.30	H		30.00	38.00	25.00	0.00	43.00	54.00	11.00	PASS
9,147.00	H		24.00	39.00	25.00	0.00	38.00	54.00	16.00	PASS



FCC RADIATED EMISSIONS DATA

CLIENT: MICROHARD SYSTEMS
EUT: COMPACTRF900
ANTENNA: 6 dBi Omni
FREQ.: 927.1 MHZ
POWER: 1000 mW

3 METER TEST

DATE: 05/18/2002

FREQUENCY MHz	POLARITY		SPEC A dBuV	AF/C dB/m	AMP Gain dB	Average Factor dB	Peak E-Field dbuV/m	Average Limit dBuV/m	MARGIN dB	CONDITION
	H	V								
2,781.30	H		40.00	35.00	25.00	0.00	50.00	54.00	4.00	PASS
3,708.40	H		37.00	36.00	25.00	0.00	48.00	54.00	6.00	PASS
4,635.50	H		35.00	39.00	25.00	0.00	49.00	54.00	5.00	PASS
7,416.80	H		31.00	37.00	25.00	0.00	43.00	54.00	11.00	PASS
8,343.90	H		28.00	38.00	25.00	0.00	41.00	54.00	13.00	PASS

TEST ENGINEER:

Brian Haghtalab



FCC RADIATED EMISSIONS DATA

CLIENT: MICROHARD SYSTEMS
EUT: COMPACT RF900
ANTENNA: 3.5 dBi TRANSIT
FREQ.: 902.8 MHZ
POWER: 1000 mW

3 METER TEST PEAK DETECT DATE: 05/18/2002

FREQUENCY MHz	POLARITY		SPEC A dBuV	AF/C dB/m	AMP Gain dB	Average Factor dB	Peak E-Field dbuV/m	Average Limit dBuV/m	MARGIN dB	CONDITION
	H	V								
2,708.40	H		35.00	35.00	25.00	0.00	45.00	54.00	9.00	PASS
3,611.20	H		36.00	36.00	25.00	0.00	47.00	54.00	7.00	PASS
4,514.00	H		32.00	39.00	25.00	0.00	46.00	54.00	8.00	PASS
5,416.80		V	31.00	37.00	25.00	0.00	43.00	54.00	11.00	PASS
8,125.20		V	29.00	38.00	25.00	0.00	42.00	54.00	12.00	PASS
9,028.00	H		24.00	39.00	25.00	0.00	38.00	54.00	16.00	PASS

TEST ENGINEER:

Brian Haghtalab



FCC RADIATED EMISSIONS DATA

CLIENT: MICROHARD SYSTEMS
EUT: COMPACT RF900
ANTENNA: 3.5dBi TRANSIT
FREQ.: 914.7 MHZ
POWER: 1000 mW

3 METER TEST PEAK DETECT DATE: 05/18/2002

FREQUENCY MHz	POLARITY		SPEC A dBuV	AF/C dB/m	AMP Gain dB	Average Factor dB	Peak E-Field dbuV/m	Average Limit dBuV/m	MARGIN dB	CONDITION
	H	V								
2,744.10		V	39.00	35.00	25.00	0.00	49.00	54.00	5.00	PASS
3,658.80	H		35.00	36.00	25.00	0.00	46.00	54.00	8.00	PASS
4,573.50	H		30.00	39.00	25.00	0.00	44.00	54.00	10.00	PASS
7,317.60		V	30.00	37.00	25.00	0.00	42.00	54.00	12.00	PASS
8,232.30	H		31.00	38.00	25.00	0.00	44.00	54.00	10.00	PASS
9,147.00	H		27.00	39.00	25.00	0.00	41.00	54.00	13.00	PASS



FCC RADIATED EMISSIONS DATA

CLIENT: MICROHARD SYSTEMS
EUT: COMPACTRF900
ANTENNA: 3.5 dBi TRANSIT
FREQ.: 927.1 MHZ
POWER: 1000 mW

3 METER TEST

DATE: 05/18/2002

FREQUENCY MHz	POLARITY		SPEC A dBuV	AF/C dB/m	AMP Gain dB	Average Factor dB	Peak E-Field dbuV/m	Average Limit dBuV/m	MARGIN dB	CONDITION
	H	V								
2,781.30	H		37.00	35.00	25.00	0.00	47.00	54.00	7.00	PASS
3,708.40	H		34.00	36.00	25.00	0.00	45.00	54.00	9.00	PASS
4,635.50		V	30.00	39.00	25.00	0.00	44.00	54.00	10.00	PASS
7,416.80	H		30.00	37.00	25.00	0.00	42.00	54.00	12.00	PASS
8,343.90	H		26.00	38.00	25.00	0.00	39.00	54.00	15.00	PASS



Table 1
Support Equipment

1. Host PC - Toshiba 740C Pentium Notebook
2. Microhard OEM Testing Platform



Table 2

Interface Cables Used

1. A 1.2 meter RS-232 serial shielded cable is used to connect the EUT to the Host computer.
2. 2 feet of low-loss coaxial cable used to connect the EUT to the TX antenna (Reverse SMC to N connectors).



Table 3

Measurement Equipment Used

The following equipment is used to perform measurements:

HP 435A RF Peak Power Meter	- Serial No. 1362016
EMCO Model 3110 Biconical Antenna	- Serial No. 1619
Antenna Research MWH-1825B Horn Antenna	- Serial No. 1005
EMCO Model 3115 Ridged Horn Antenna	- Serial No. 3007
HP 8348A Preamplifier	- Serial No. 197-2564A
Solar 8012-50-R-24-BNC LISN	- Serial No. 924867
Bird 8306-300-N 30dB Attenuator	- S/N: 29198391515
HP 14IT w/8555A Spectrum Analyzer	- Serial No. 6-95-1124
4 Meter Antenna Mast	
Motorized Turntable	
Heliac FSJ1-50A 1/4" Superflex Coax Cable (12 Ft.)	