



CORDLESS TELEPHONE

900 MHz FILTERED SOUND™ WITH 40 CHANNEL AUTOSCAN

Model MH9008

OWNER'S MANUAL
INSTALLATION AND
OPERATING
INSTRUCTIONS

**PLEASE READ THIS
MANUAL CAREFULLY
BEFORE USE.
KEEP FOR YOUR
REFERENCE.**



*For Getting Started Information,
please see Installation Instructions
on page 8 or your separate
Quick Start guide.*

Special Features

Congratulations on your selection of a quality BellSouth Product. With proper care and by following the setup and user instructions in this manual, this unit will provide you with years of trouble free service. BellSouth is committed to providing quality products that fit your needs. We would like to have any comments or suggestions you might have on this product. You may mail your comments to:

**U.S. Electronics
105 Madison Avenue
New York, NY 10016**

When examining your new BellSouth cordless telephone, you will find an array of special features including:

- Filtered Sound™ System** - Gets considerably less noise than conventional cordless telephones because of a special circuit which delivers the clearest possible reception.
- 40 Channel Auto Scan** - Press the **(scan)** button on the **HANDSET** to find and lock on to the clearest channel for any call.
- Telephone Number Storage** - Store up to 10 frequently called numbers.
- Desk or Wall Mount** - Use this equipment as a desk phone or as a wall phone.
- Tone or Pulse Dialing** - Use this phone for either tone or push-button pulse (rotary) dialing.
- Automated Functions** - Redial the last number called, speed dial 10 numbers and automatic STANDBY.
- Security** - Ensures greater privacy because a built-in security code with 65,536 combinations prevents use of your telephone line by another nearby cordless phone.
- Dependable Battery** - Recharge your battery pack many times with the built-in charger. The battery low warning tone tells you when the battery pack needs recharging. (See page 19.)
- Special Services** - Use the **(flash)** button to access special services such as Call Waiting supplied by your telephone company or company switchboard.
- STANDBY Mode** - When in STANDBY mode, the phone is capable of receiving a call (ON-HOOK). When the **HANDSET** is on the **BASE UNIT**, it is automatically in the STANDBY mode (ON-HOOK). When the **HANDSET** is taken off the **BASE UNIT**, it remains in the STANDBY mode until you activate the **(talk)** button.
- Battery Power Saver** - Once fully charged, in STANDBY mode and with the RINGER SWITCH in the "ON" position, the **HANDSET** can receive/send calls for a maximum of five days without the need for recharging, depending on frequency of use.
- HANDSET Volume Control Switch** - Select the volume level (HI, MED, LOW).

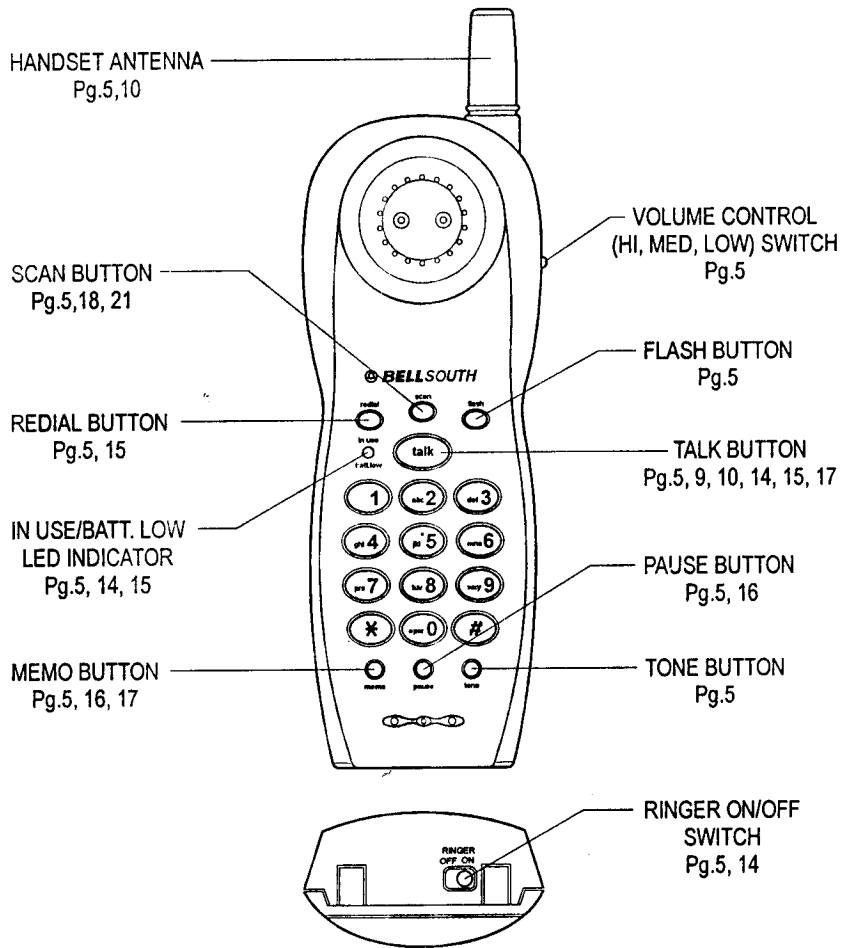

For Getting Started information, please see Installation Instructions on page 8 or your separate Quick Start guide.

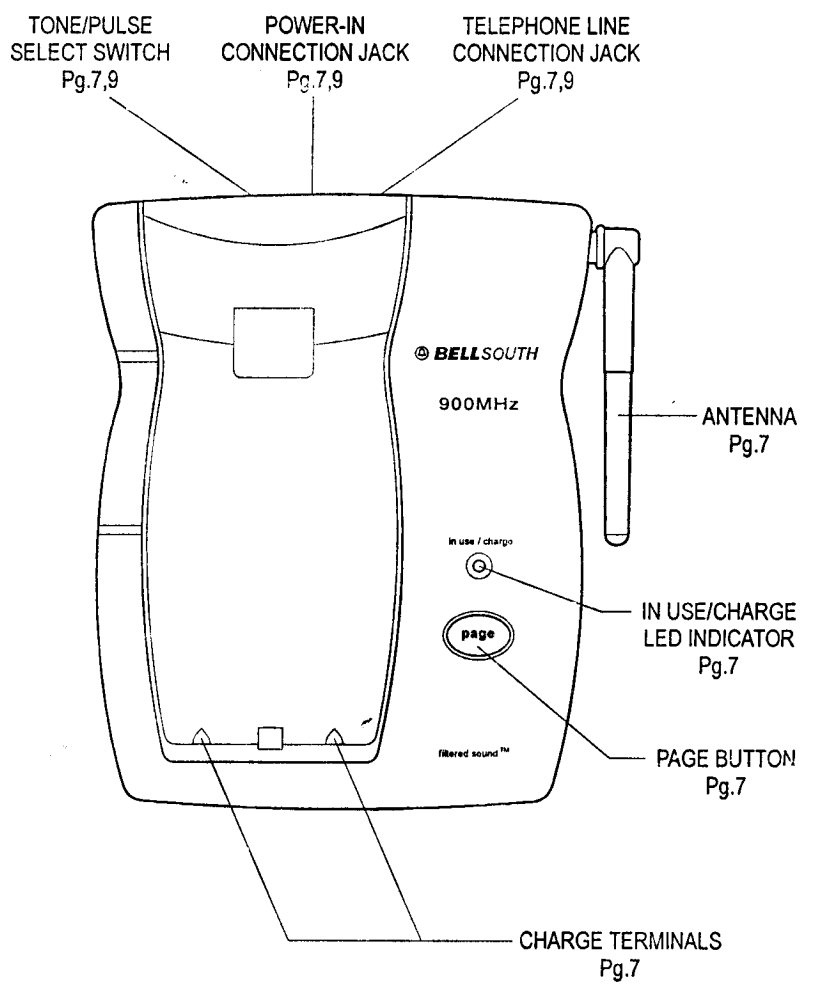

Contents

Safety Instructions.....	2
HANDSET Controls-Location and Function.....	4
BASE UNIT Controls-Location and Function.....	6
Getting Started.....	8
Desk Mounting.....	11
Wall Mounting.....	12
Basic Operation.....	13
Receiving Calls.....	14
Placing Calls.....	15
Storing Numbers.....	16
Recalling Stored Numbers.....	17
Security System.....	18
Recharging the Battery Pack.....	19
Changing the Battery Pack.....	20
Problem Solving.....	21
Technical Information.....	22
FCC Requirements.....	23
Warranty.....	25
Wall Mount Template.....	28

Safety Instructions

IMPORTANT SAFETY INSTRUCTIONS

To reduce the risk of fire, electric shock and/or injury, always follow these basic safety precautions when using your cordless telephone equipment.

1. Read and understand all instructions.
2. Follow all warnings and instructions marked on the telephone.
3. Unplug this telephone from the wall outlet before cleaning or replacing the battery pack. Do not use liquid cleaners or aerosol cleaners. Use a damp cloth for cleaning. If necessary, use only a mild soap.
4. Do not use this telephone near a bath tub, kitchen sink, wash bowl, laundry tub, swimming pool, in a wet basement, or anywhere else where there is water.
5. Do not place this telephone on an unstable cart, stand, or table. A fall could cause serious damage to the phone.
6. This product should never be placed near or over a radiator or heat register. This product should not be placed in a built-in installation unless proper ventilation is provided.
7. Operate this telephone only with the correct electrical voltage shown on the label or in the Owner's manual. If you are not sure of the voltage in your home, consult your dealer or local power company.
8. Do not allow anything to rest on the power cord. Do not install the phone where people will walk on the cord.
9. Do not overload wall outlets and extension cords. This can increase the risk of fire or electric shock.
10. Never push objects of any kind through slots in the phone. They could touch dangerous voltage points or short out parts that could result in a risk of fire or electric shock. Never spill liquid of any kind on the telephone.
11. To reduce the risk of electric shock, do not take this telephone apart. When service or repair work is required on this telephone, take it to a qualified service representative. Opening or removing covers may expose you to dangerous voltage or other risks. Incorrect re-assembly can cause electric shock when the appliance is used.
12. Unplug this telephone from the wall outlet and consult a qualified service representative in any of the following situations:
 - A. When the power supply cord is frayed or damaged.
 - B. If liquid has been spilled into the telephone.
 - C. If the product has been exposed to rain or water.
 - D. If the telephone does not operate normally by following the operating instructions. Adjust only those controls that are covered by the operating instructions. Improper adjustment of the other controls may result in damage and will often require extensive work by a qualified technician to restore the telephone to normal operation.
 - E. If the telephone has been dropped or the case has been damaged.

Safety Instructions

- F. If the telephone exhibits a distinct change in performance.
13. Avoid using a telephone (other than a cordless type) during an electrical storm. There may be a remote risk of electric shock from lightning.
 14. Do not use the telephone to report a gas leak in the vicinity of the leak.
 15. Never install telephone wiring during a lightning storm.
 16. Never install telephone jacks in wet locations unless the jack is specifically designed for wet locations.
 17. Never touch uninsulated telephone wires or terminals unless the telephone line has been disconnected at the network interface.
 18. Use caution when installing or modifying telephone lines.

SAVE THESE INSTRUCTIONS

Battery Cautionary Instructions

CAUTION:

To reduce the risk of fire or personal injury, read and follow these instructions:

1. Use only the following type and size of battery pack:
 - Cordless Telephone Battery Pack
 - 3.6V, 600mAh
 - U.S. Electronics Inc.
 - Ni-Cd Battery Pack: model B650
 - (See page 19 for ordering information.)
2. Do not dispose of the battery pack in a fire. It may explode. Check with local codes for possible special disposal instructions.
3. Do not open or mutilate the battery pack. Released electrolyte is corrosive and may cause damage to the eyes or skin. It may be toxic if swallowed.
4. Exercise care in handling the battery pack to prevent shorting the battery with conductive materials such as rings, bracelets and keys. The battery pack or conductor may overheat and cause burns.
5. Charge the battery pack provided with or identified for use with this product only in accordance with the instructions and limitations specified in this manual.
6. Observe proper polarity orientation between the battery pack and battery charger.

ATTENTION:

The product that you have purchased contains a rechargeable battery pack. The battery pack is recyclable. At the end of its useful life, under various States and local laws, it may be illegal to dispose of this battery pack into the municipal waste stream. Check with your local solid waste officials for details in your area for recycling options or proper disposal.

HANDSET Controls

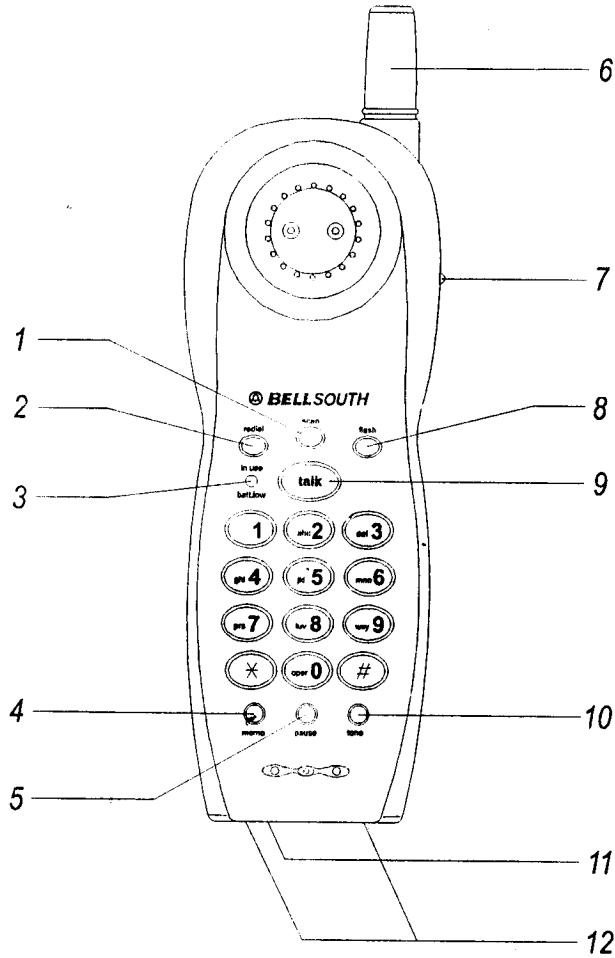



HANDSET Controls



1. **scan Button:** Press to change the operating channel when you hear interference.
2. **redial Button:** Press to redial the last number you dialed.
3. **in use/batt. low LED Indicator:** Lights up when the **HANDSET** is in TALK mode. Blinks when battery power is low. (See page 19 for detail.)
4. **memo Button:** Press to store phone numbers in memory or to call a number you have previously stored.
5. **pause Button:** Press to insert a pause while dialing. (You will need the **pause** button to dial numbers which use an alternative long distance access code.)
6. **HANDSET ANTENNA**
7. **Volume Control (hi, med, low) Switch:** Select the volume level (HI, MED, LOW).
8. **flash Button:** Press to answer an incoming call if you have Call Waiting.
9. **talk Button:** Press to answer an incoming call or to place a call. Press to end a call.
10. **Tone Button:** Press to temporarily change the dialing mode from Pulse to Tone for Rotary Service Users. (Press once before entering numbers to access the answering system or electronic banking services, etc.)
11. **RINGER ON/OFF Switch:** Set switch to OFF position to disengage the ringer on the **HANDSET**.
12. **Charge Contacts:** For charging the battery pack inside the **HANDSET**. We recommend cleaning periodically with a damp cloth.

IMPORTANT

In order to get maximum life from the HANDSET battery pack, be sure to charge the HANDSET for 12 hours before initial use.

BASE UNIT Controls

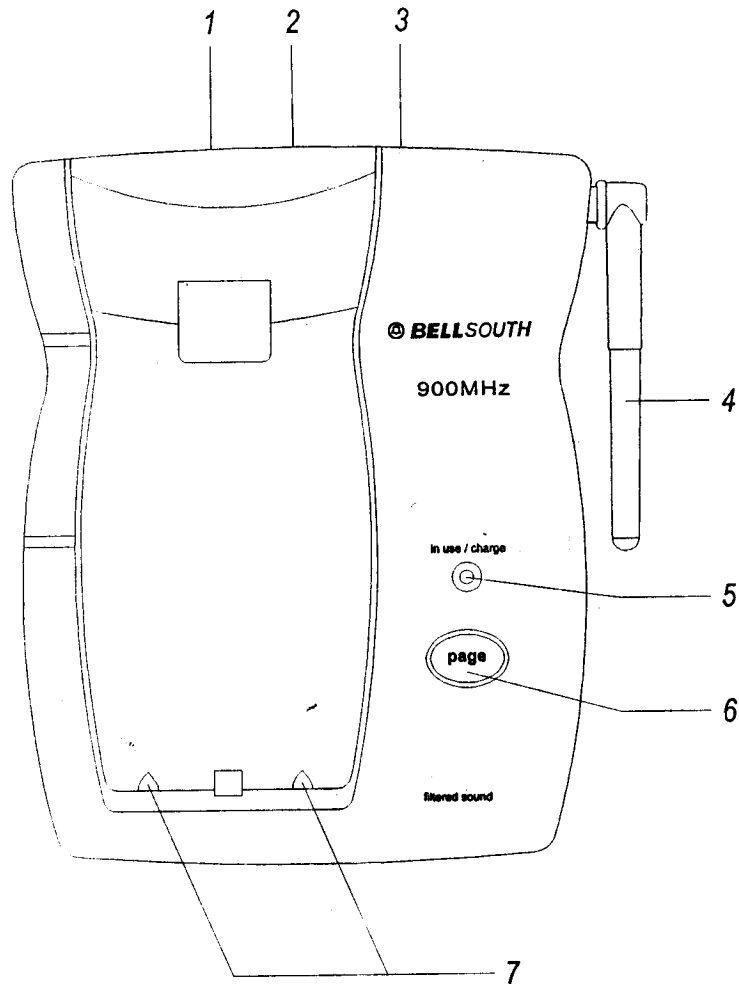



BASE UNIT Controls

1. Telephone Line Connection Jack
2. Power-In Connection Jack
3. Tone/Pulse Select Switch
4. Antenna: Raise or reposition for best reception.
5. in use/charge LED Indicator: Lights up to indicate the unit is ON or when the HANDSET is placed on the BASE UNIT for charging. It flashes to indicate the page function is in use.
6. page Button: Press to page the HANDSET.
7. Charge Terminals: For charging the HANDSET battery pack. For best performance, clean periodically with a damp cloth only.

IMPORTANT

Locating your BASE UNIT near appliances such as televisions, refrigerators, radios, or microwave ovens may cause interference.

7

Getting Started

Connecting Your Phone

This section is a reference guide to the basic functions and operations of your cordless telephone. For more detailed descriptions of the operations and features of this telephone, refer to the Contents on page 1.

1. Carefully remove your cordless telephone from its shipping carton. If there is any visible damage, do not attempt to operate this equipment. Return it to the place of purchase.
2. Check to be sure you have all items that come with this cordless telephone system. You should have a **HANDSET**, **BASE UNIT**, **AC ADAPTOR**, **MOUNTING BRACKET**, **TELEPHONE LINE CORD**, **SHORT TELEPHONE LINE CORD** and Owner's Manual.

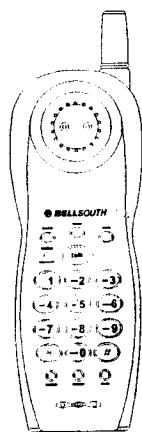

HANDSET

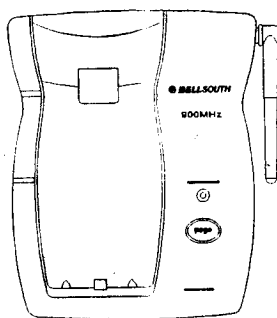

BASE UNIT

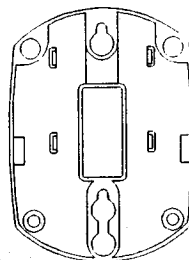

MOUNTING BRACKET

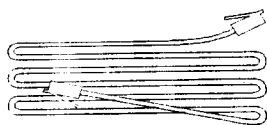

TELEPHONE LINE CORD

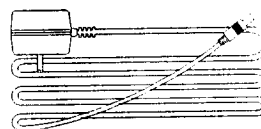

AC ADAPTOR



SHORT TELEPHONE LINE CORD

Getting Started

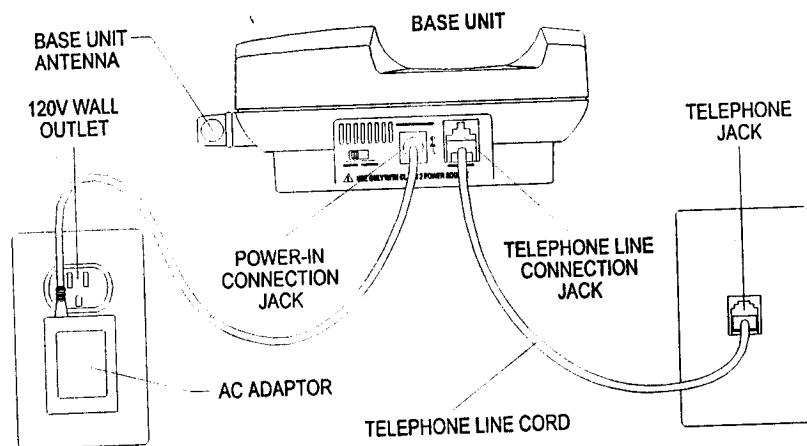

3. Insert the small plug on the end of the AC adaptor into the POWER-IN connection jack at the back of the **BASE UNIT**.
4. Plug the AC adaptor into a 120V AC wall outlet.
5. **⚠ USE ONLY WITH CLASS 2 POWER SOURCE 9V DC, 300mA.** Insert one plug of the TELEPHONE LINE CORD into the house TELEPHONE JACK and the other end into the telephone line jack at the back of the **BASE UNIT**. (If you have an older 4-prong telephone jack, you will need an RJ-11C TELEPHONE JACK ADAPTOR. This adaptor is available at the same place you purchased your telephone.)
6. Raise or reposition the antenna on the **BASE UNIT** for best reception.
7. We recommend not placing this unit next to appliances. Doing so may cause interference.
8. TONE/PULSE Select Switch:
 - A. If your home is equipped with a Tone dialing system, set the TONE/PULSE select switch to the TONE position.
 - B. If you have a rotary dialing system, set the TONE/PULSE select switch to PULSE position.
 - C. If you are unsure which system you have, set the TONE/PULSE select switch to the TONE position. Press the **talk** button on the **HANDSET** to get a dial tone, and press any key on the keypad except the zero. If the dial tone continues, it means that you do not have Touchtone dialing service. Press the **talk** button on the **HANDSET** to hang up. Set the TONE/PULSE select switch to the PULSE mode and then try again.

Getting Started

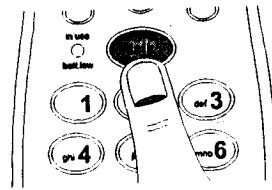
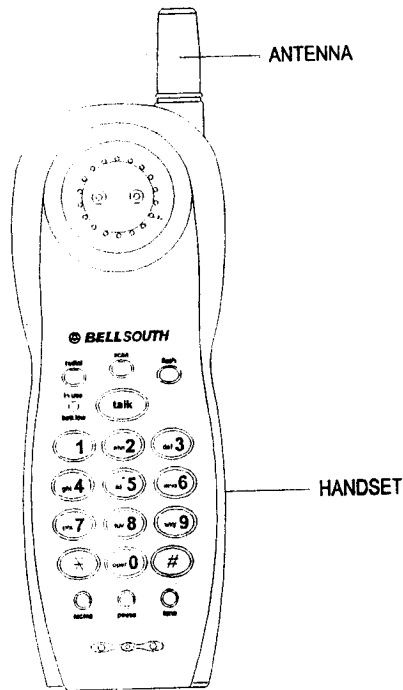

Press the **talk** button to confirm that you have a dial tone. If you do not get a dial tone, review steps 3 through 8. If you still have no dial tone, refer to the Problem Solving section on page 21.

9. Before initial use, charge the HANDSET for 12 hours.

***You are now ready to use your new
BellSouth Cordless Telephone.***

Desk Mounting

Desk Mounting

One of the special features of your telephone is the unique design of the MOUNTING BRACKET which can hold your phone at an angle of 30° when desk mounting. There are two positions to choose from:

1. NORMAL POSITION (Mounting Bracket not required)
For normal position, as shown in Figure 1, place the **BASE UNIT** on any desired but suitable location.

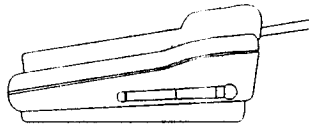

FIGURE 1

2. 30° POSITION (See Figure 2)
With the back of the **BASE UNIT** facing up, insert the hooks of the MOUNTING BRACKET (marked "30° DESK MOUNT") into the matching slots of the **BASE UNIT** (as shown in Figure 3). Then slide the MOUNTING BRACKET into place as indicated by the arrow.

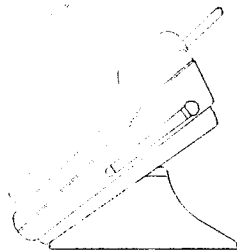

FIGURE 2

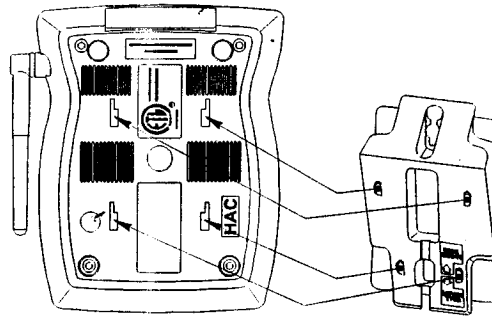

FIGURE 3

Wall Mounting

Wall Mounting

You may choose to put the **BASE UNIT** of your cordless telephone on a wall.

1. With the back of the **BASE UNIT** facing up, connect the **SHORT TELEPHONE LINE CORD** to the telephone line jack.
2. Insert the **SHORT TELEPHONE LINE CORD** through the hole of the **MOUNTING BRACKET**.
3. Insert the hooks of the **MOUNTING BRACKET** (marked "WALL MOUNT") into the matching slots of the **BASE UNIT** (as shown below). Then slide the **MOUNTING BRACKET** into place as indicated by the arrow. Plug the free end of the **SHORT TELEPHONE LINE CORD** into the **MODULAR WALL JACK**.
4. Align the upper keyhole on the **MOUNTING BRACKET** with the upper **STUD** of the wall plate, so that the opening end of the **MOUNTING BRACKET** matches the lower stud, then pull the **BASE UNIT** down until it is securely seated.

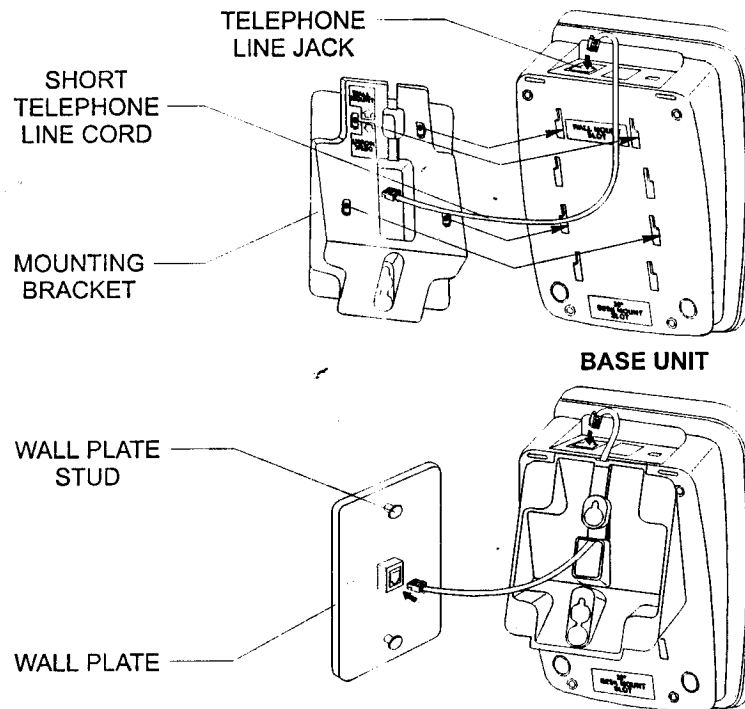

Basic Operation

Preparing for Use

Before you can use your cordless telephone, you must charge the **HANDSET** for 12 hours. Failure to do so will require recharging of the battery pack more often.

1. Place the **HANDSET** on the **BASE UNIT** for 12 hours.
2. After 12 hours, remove the **HANDSET** from the **BASE UNIT**.
3. Raise or reposition the **BASE UNIT** antenna for best reception.

*Before you can use your cordless telephone, you must charge the **HANDSET** for 12 hours. Failure to do so will require more frequent charging of the battery pack. See page 19 for more information on the battery pack.*

IMPORTANT

The AC ADAPTOR must always be plugged into an electrical outlet.

Receiving Calls

Receiving Calls with the HANDSET on the BASE UNIT

1. When the phone rings, lift the **HANDSET**. The IN USE LED indicator will light up. (NOTE: The HANDSET RINGER SWITCH must be in the "ON" position for ringer to operate.)
2. Start your conversation.
3. To end your conversation, either press the **(talk)** button or place the **HANDSET** on the **BASE UNIT**. If you place the **HANDSET** on the **BASE UNIT** charge cradle, you activate the automatic **STANDBY** feature.

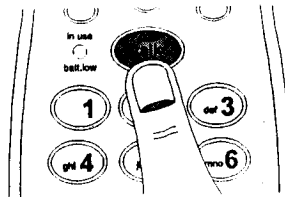

Receiving Calls with the HANDSET off the BASE UNIT

1. When the phone rings, press the **(talk)** button. The IN USE LED indicator will light up.
2. Start your conversation.
3. To end your conversation, either press the **(talk)** button or place the **HANDSET** on the **BASE UNIT**. If you place the **HANDSET** on the **BASE UNIT** charge cradle, you activate the automatic **STANDBY** feature.

(NOTE: The **BASE UNIT** has no ringer and does not ring when receiving an incoming call.)

NOTE:

Once the **HANDSET** is fully charged, it is operable for approximately 4 hours of continuous talk use and approximately 5 days when the **HANDSET** is left off the **BASE UNIT** in **STANDBY** mode depending on the frequency of use.

Placing Calls

Placing Calls

1. Press the **(talk)** button. The IN USE LED indicator will light up.
2. Listen for a dial tone.
3. Dial the phone number.
4. When you have finished with your call, press the **(talk)** button again. The IN USE LED indicator will turn off.

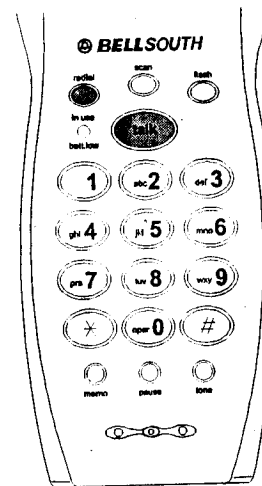

HANDSET Redial Feature

1. If you get a busy tone, press the **(talk)** button to hang up.
2. Later, press the **(talk)** button again.
3. Listen for a dial tone.
4. Press the **(redial)** button. This will automatically redial the last telephone number you called.

Note:

If you are far away from the **BASE UNIT**, the **HANDSET** emits beep sounds to warn you that the background noise level is too high for proper communication between the **HANDSET** and the **BASE UNIT**. When you hear this sound, you should move closer to the **BASE UNIT** to reduce the noise level. Otherwise, the call will automatically cut off.

IMPORTANT

When you hear interference, press the **(scan)** button to change the operating channel.

Storing Numbers

Storing Numbers

1. Be sure the **BASE UNIT IN USE** LED indicator is off and the **HANDSET** is in **STANDBY** mode.
2. Press the **(memo)** button.
3. Dial the number you want to store.
4. Press the **(memo)** button again.
5. Dial the index number (0-9) where you want to store that number. You will hear one confirmation beep.
6. Write the name of the person you will be calling with that number next to the corresponding index number on the telephone number card.
7. Repeat steps 1 through 6 for other telephone numbers.

EXAMPLE : To store the number 703-1968 under the index number 1 on the keypad:

- | | |
|---|--|
| 1 - Press the (memo) button. | 4 - Press 1 on the keypad |
| 2 - Dial 703-1968. | 5 - You have stored 703-1968 under key 1 on the keypad |
| 3 - Press the (memo) button again. | |

A total of 10 telephone numbers can be programmed in memory.

IMPORTANT: The maximum number of digits that can be stored for any phone number is 16 in pulse or tone mode. The maximum number of digits for mixed (tone and pulse in combination) dialing is 15. If you are using a switchboard system to access an outside line (such as an 8 or 9), press the **(pause)** button to store a pause.

Recalling Stored Numbers

Recalling Stored Numbers from Memory

1. Press the **(talk)** button.
2. Press the **(memo)** button.
3. Press the index number for the number you have stored. The stored number will be dialed automatically.

EXAMPLE: To recall number 703-1968 stored under key 1 on the keypad:

- Press the **(talk)** button.
- Press the **(memo)** button.
- Dial 1.

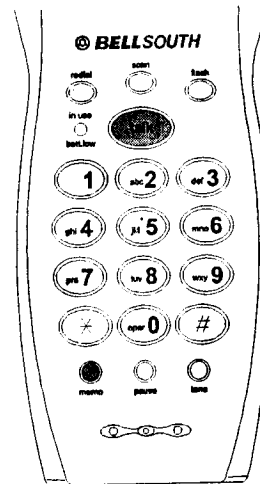

IMPORTANT

To obtain the best reception, be sure to raise or reposition the BASE UNIT antenna.



Security System

Security System

Your cordless telephone uses a digital coding security system to prevent unauthorized use of your telephone line by another nearby cordless telephone. The system has its own identifying signal created by microcomputers in both the **BASE UNIT** and **HANDSET**.

Security Code

This telephone has an internal security code with 65,536 possible combinations.

Multi-Channel Access

Your cordless telephone lets you select a channel from the 40 frequencies available to transmit signals between the **BASE UNIT** and **HANDSET**. When you notice interference from other cordless telephones, change to another channel by pressing the **(scan)** button on the **HANDSET**.

IMPORTANT

When you hear interference, press the **(scan)** button to change the operating channel.

18

Recharging the Battery Pack

Battery Type

Use the following type and size of battery pack:

Cordless Telephone Battery Pack
3.6V, 600mAh
U.S. Electronics Inc.
Ni-Cd Battery Pack: model B650



Ni-Cd

This battery pack is available through:
U.S. Electronics Service Center
105 Madison Avenue
New York, NY 10016
1-800-828-5208

Recharging the Battery Pack

The nickel cadmium (Ni-Cd) battery pack in the **HANDSET** can be recharged many times using the built-in charger in the **BASE UNIT**.

When the **BATTERY LOW** LED indicator starts to blink, a "beep" sound will be heard every 12 seconds. This indicates that the battery pack needs to be recharged.

Charge the battery pack at least once every 90 days of nonuse to avoid battery failure. When the battery pack can no longer be charged, replacement of the battery pack will be necessary.

The battery pack used in your telephone may develop a condition known as "MEMORY". Once subjected to a regular short discharging routine, the battery assumes the discharging pattern it was subjected to. This is known as a "MEMORY" condition which causes rapid discharging thereby shortening the battery pack charge span. If you believe your battery pack has developed a memory condition, do not charge the **HANDSET** until the **BATTERY LOW** LED indicator comes on. When it does come on, charge the **HANDSET** fully for 12 hours.

IMPORTANT

In order to get maximum life from the **HANDSET** battery pack, be sure to charge the **HANDSET** for 12 hours before initial use.

Changing the Battery Pack

Changing the Battery Pack

The battery pack provides power for the **HANDSET** of your cordless telephone.

To Replace the Battery Pack:

1. Remove the **HANDSET** battery compartment cover by sliding it down.
2. Pull out the battery connector and remove the battery pack.
3. Plug the new battery pack into the battery connector.
4. Slide the **HANDSET** battery compartment cover firmly into place in its closed position.
5. Before use, charge the new battery pack for 12 hours.

ATTENTION:

The product that you have purchased contains a rechargeable battery pack. The battery pack is recyclable. At the end of its useful life, under various state and local laws, it may be illegal to dispose of this battery pack into the municipal waste stream. Check with your local solid waste officials for details in your area for recycling options or proper disposal.

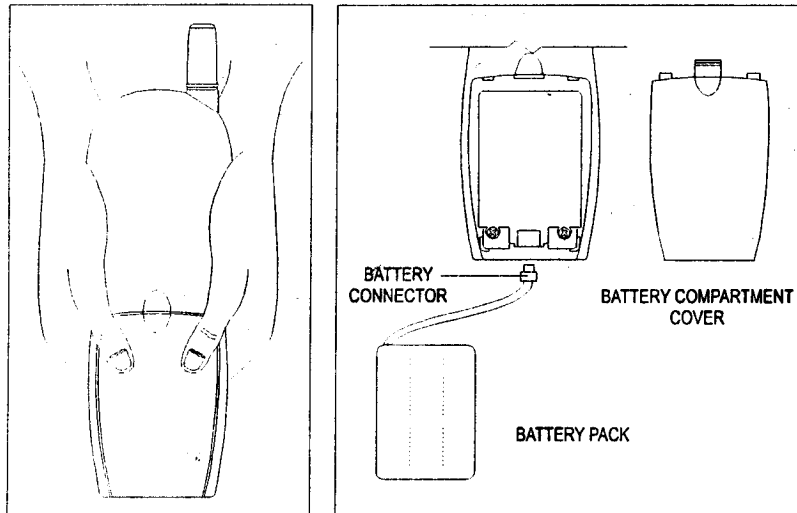

Remove the battery **HANDSET** compartment cover by sliding it down.

Problem Solving

Problem Solving Section

For your assistance, we have listed below a few common problems.

Phone does not work, check the following:

1. **BASE UNIT** is plugged into power source.
2. **HANDSET** is charged.
3. **TONE/PULSE** switch is in the right position.
4. **TELEPHONE LINE CORD** is plugged into the telephone jack.

Range of phone limited, check the following:

1. **ANTENNA** on **BASE UNIT** is raised.
2. **BASE UNIT** is centrally located in your residence.
3. **BASE UNIT** is not located near appliances.

No dial tone, check the following:

1. Telephone plug is connected to the telephone line.
2. **BASE UNIT** is plugged into power source.

Received signal flutters or fades, check the following:

1. Battery pack in **HANDSET** is fully charged.
2. **HANDSET** is not too far from the **BASE UNIT**.
3. **ANTENNA** on **BASE UNIT** is raised.

Interference on reception, check the following:

1. Noise may be picked up from electrical products in the home or electrical storms. Generally, this noise is a minor annoyance and should not be interpreted as a defect in your system. (See Technical Information on page 22).
2. Choose an alternate channel using the **scan** button on the **HANDSET**.

Excess static, check the following:

1. Check to see that the **ANTENNA** is not touching another metal object.
Raise the **ANTENNA**.

If after pressing the TALK button, you receive three beeps and no dial tone, check the following:

1. **BASE UNIT** is plugged into power source.

NOTE: If no telephones in the house are working, disconnect one set at a time to verify that none of the phones are causing the problem. If you still have a problem after doing this and your telephone still does not work, please contact your local phone company.



Technical Information

Technical Information

This cordless telephone uses radio frequencies to allow mobility. There are certain difficulties in using radio frequencies with a cordless telephone. While these are normal, the following could affect the operation of your system.

Noise

Electrical pulse noise is present in most homes at one time or another. This noise is most intense during electrical storms. Certain kinds of electrical equipment such as light dimmers, fluorescent bulbs, motors, and fans also generate noise pulses. Because radio frequencies are susceptible to these noise pulses, you may occasionally hear them in your **HANDSET**. Generally they are minor annoyance and should not be interpreted as a defect in your system.

Range

Because radio frequency is used, the location of the **BASE UNIT** can affect the operating range. Try several locations in your home or office and pick the one that gives you the clearest signal to the **HANDSET**.

Interference

Electronic circuits activate a relay to connect the cordless telephone to your telephone line. These electronic circuits operate in the radio frequency spectrum. While several protection circuits are used to prevent unwanted signals, there may be periods when these unwanted signals enter the **BASE UNIT**. You may hear clicks or hear the relay activate while you are not using the **HANDSET**. If the interference occurs frequently, it can be minimized or eliminated by lowering the height of your base antenna or by relocating the **BASE UNIT**. You can check for interference before selecting the final **BASE UNIT** location by plugging in the phone.

NOTICE:

This cordless telephone uses radio communication between the **HANDSET** and the **BASE UNIT** and may not ensure privacy of communication. Other devices, including other cordless telephone, may interfere with the operation of this cordless telephone or cause noise during operation. Units not containing coded access may be accessed by other radio communication systems. Cordless telephones must not cause interference to any licensed radio service.



FCC Requirements

Federal Communications Commission Requirements

This equipment complies with Part 68 of FCC Rules. A label on the **BASE UNIT** of this equipment contains, among other information, the FCC Registration Number and the Ringer Equivalence Number (REN) for this equipment. You must, upon request, provide this information to your telephone company.

The REN is also useful in determining the quantity of devices that you may connect to your telephone line and still allow these devices to ring when your telephone number is called. In most areas, but not all, the sum of the REN's for all devices connected to one line should not exceed five (5.0). To be certain of the number of devices that you may connect to your line, you should contact your local telephone company.

If your equipment should cause harm to the telephone network, the telephone company may temporarily disconnect your service. If possible, they will notify you in advance that temporary discontinuance of service may be required. However, when advance written notice is not possible, the telephone company may temporarily discontinue service without notice if such action is necessary under the circumstances. The telephone company may make changes in its communication facilities, equipment, operations, or procedures where such action is reasonably required in the operation of its business and is not inconsistent with the rules and regulations of the Federal Communications Commission. **Do not attempt to repair or modify this equipment.**

Warning: Changes or modifications not expressly approved by the party responsible for its compliance could void the user's authority to operate the equipment.

Some cordless telephones operate at frequencies that may cause interference to nearby TV's and VCR's. To minimize or prevent such interference, the base of the cordless telephone should not be placed on or near a TV or VCR. If interference is experienced, moving the cordless telephone farther away from the TV or VCR will often reduce or eliminate the interference.

This equipment should not be used on coin telephone lines. Connection to party line service is subject to state tariffs. If trouble is experienced, disconnect this equipment from the telephone line to determine if it is causing the malfunction. If the equipment is determined to be malfunctioning, its use should be disconnected until the problem has been corrected.

IMPORTANT

In order to get maximum life from the HANDSET battery pack, be sure to charge the HANDSET for 12 hours before initial use.







FCC Requirements

Federal Communications Commission Requirements (continued)

Note: This equipment has been tested and found to comply with the limits for a class B digital device, pursuant to Part 15 of the FCC Rules. These limits are designed to provide reasonable protection against harmful interference in a residential installation. This equipment generates, uses and can radiate radio frequency energy and, if not installed and used in accordance with the instructions, may cause harmful interference to radio communications.

However, there is no guarantee that interference will occur in a particular installation. If this equipment does cause harmful interference to radio or television reception, which can be determined by turning the equipment off and on, the user is encouraged to try to correct the interference by one of the following measures.

1. Reorient or relocate the receiving antenna.
2. Increase the distance between the equipment and the receiver.
3. Connect the equipment into an outlet on a circuit different from that to which the receiver is connected.
4. Consult the dealer or an experienced radio/TV technician for help.

Warranty

Warranty Information

BellSouth Products

One-Year Limited Warranty

This limited warranty sets forth all **BellSouth Products** responsibilities regarding your product. There are no other expressed or implied warranties from **BellSouth Products**.

Warranty Service Provided

If you purchased the new telephone from a retail vendor, **BellSouth Products** warrants the telephone against defects in material and workmanship for a period of one (1) year from the original date of purchase. This warranty is in lieu of all other express warranties. This warranty begins when you purchase the telephone and continues for one (1) year unless you sell or rent the telephone, in which case the warranty stops.

BellSouth Products disclaims any implied warranty, including the warranty of merchantability and the warranty of fitness for a particular purpose, as of the date of 90 days from your original purchase of the telephone. **BellSouth Products** assumes no responsibility for any special, incidental, or consequential damages.

This warranty gives you specific legal rights and you may have other rights which vary from state to state. Some states do not allow the exclusion or limitations of special, incidental or consequential damages, or limitations on how long a warranty lasts, so the above exclusion and limitation may not apply to you.

Warranty Service Not Provided

This warranty does not cover damage resulting from accident, misuse, abuse, improper installation or operation, lack of reasonable care, unauthorized modification, the affixing of any attachment not provided by **BellSouth Products** with the telephone and/or loss of parts. This warranty is voided in the event any unauthorized person opens, alters or repairs the telephone. All **BellSouth** equipment being returned for repair must be suitably packaged. Telephone companies use different types of equipment and offer various types of services to customers. **BellSouth Products** does not warrant that this telephone is compatible with the type of equipment of any particular telephone company or the services provided by it.



Warranty

What to Do for Warranty Service

During the first thirty (30) days, a defective product is eligible for over-the-counter exchange at the retailer from whom it was purchased. After thirty (30) days, the defective product should be returned to the authorized service center. Please allow 2-3 weeks for the return of your telephone product. The shipping address of the authorized service center is:

U.S. Electronics Service Center
105 Madison Avenue
New York, NY 10016

NOTE: A product received which was not made for **BellSouth Products** or which is not defective as determined by our test procedures will not be repaired and will be returned C.O.D., freight.

To Obtain Warranty Service

- Provide proof of the date of purchase within the package.
- Prepay all shipping costs to the authorized service center.
- Include a return shipping address within the package.

Please retain your sales receipt, the carton, the packing materials, and the printed material. The original carton is the best shipping container for the telephone should you have to return it.

For your reference:

Serial number _____

Date of Purchase _____

Name of Dealer _____

**Customer Service Telephone Number:
1-800-210-8950**

OUTSIDE THE U.S.A. CALL 1-212-242-6978



Notes





Wall Mount Template



This page serves as a template for attachment of screws to the wall when mounting this telephone on the wall.

1. Cut out this page.
2. Use this template to determine the distance between screws when mounting this phone on the wall.
The two cross hairs identify where to attach the screws.



IMPORTANT

In order to get maximum life from the **HANDSET** battery pack, be sure to charge the **HANDSET** for 12 hours before initial use.

IMPORTANT

Placing your **BASE UNIT** near appliances such as televisions, refrigerators, radios, or microwave ovens may cause interference.

IMPORTANT

When you hear interference, press the **scan** button to change the operating channel.

IMPORTANT

The **AC ADAPTOR** must always be plugged into an electrical outlet.

IMPORTANT

To obtain the best reception, be sure to raise or reposition the **BASE UNIT ANTENNA**.

IMPORTANT

If you live in an area which gets frequent thunderstorms, we strongly recommend plugging your **AC adaptor** into a surge protector.

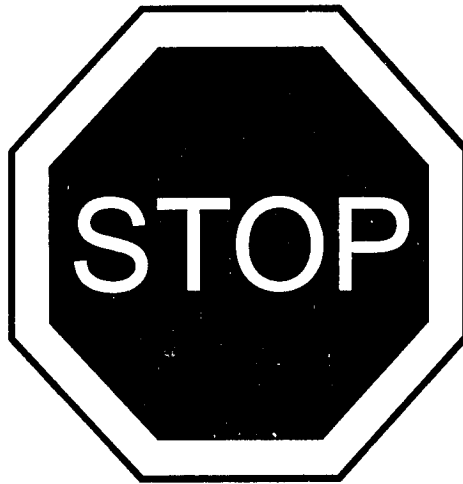

**Make certain you receive the best
performance from your telephone.
Read this manual first.**

 **BELLSOUTH**

MH9008A

Made in China