

# LABELLING INFORMATION FOR MODEL MH9003 SERIES

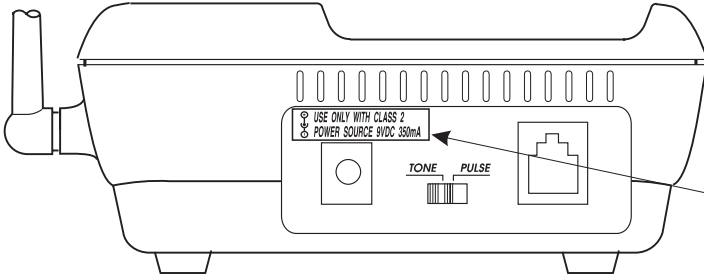

USE ONLY WITH CLASS 2  
POWER SOURCE 9VDC 350mA

PRINTED ON LABEL

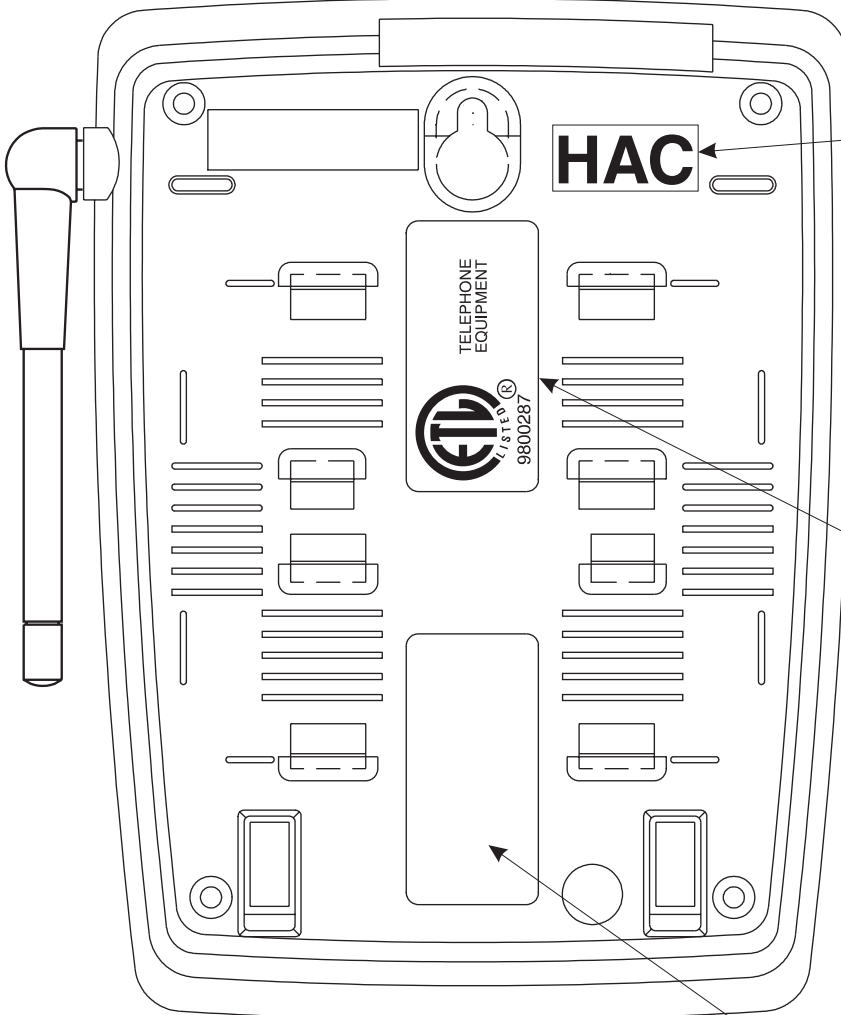

ENGRAVED ON CABINET

HAC



ENGRAVED ON CABINET

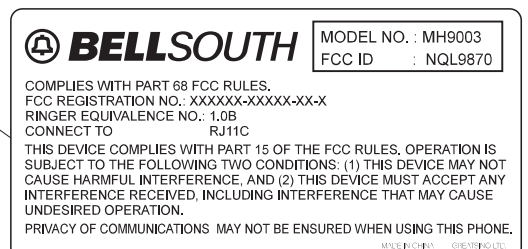

PRINTED ON THE LABEL

# LABELLING INFORMATION FOR MODEL MH9003 SERIES

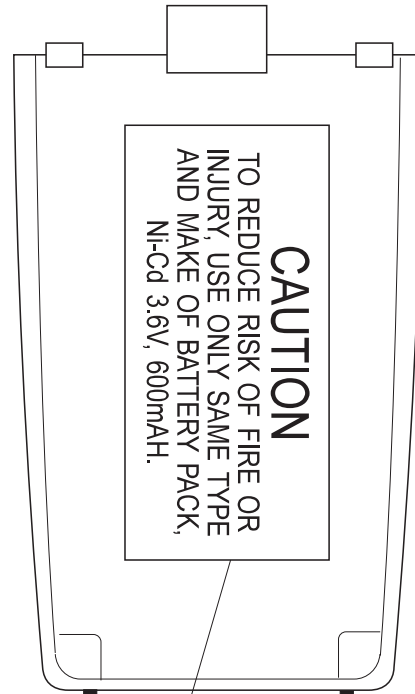
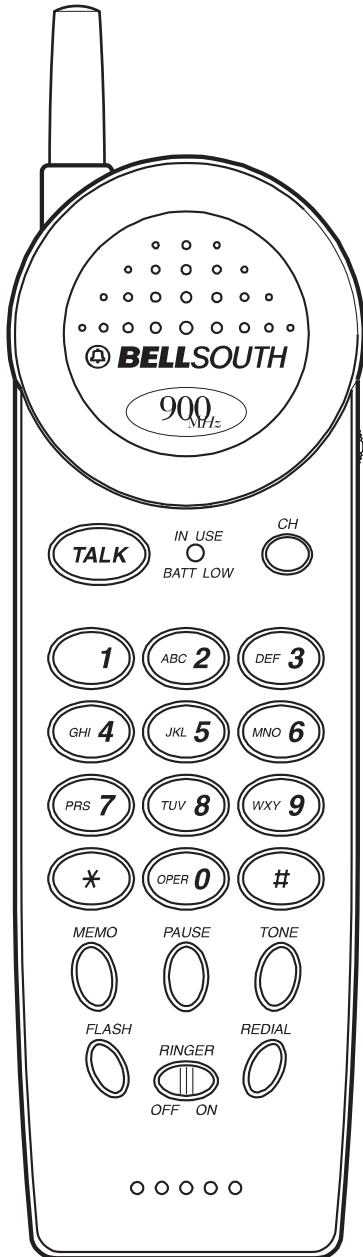

PRINTED ON THE LABEL

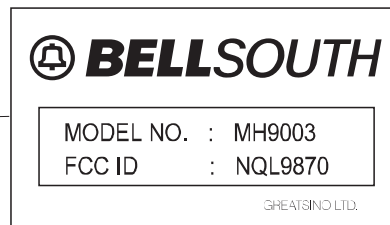
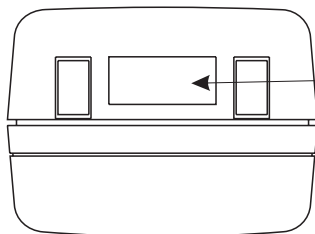

PRINTED ON THE LABEL