

INTERTEK TESTING SERVICES

EXHIBIT 5
PRODUCT LABELLING

INTERTEK TESTING SERVICES

5.0 **Product Labelling**

The FCC ID label and label location are attached.

INTERTEK TESTING SERVICES

5.1 Label Artwork

Figure 5.1 FCC ID Label

An engineering drawing of the label which will be permanently affixed to the unit is attached. This label will be attached to the unit at the location shown in Exhibit 5.2.

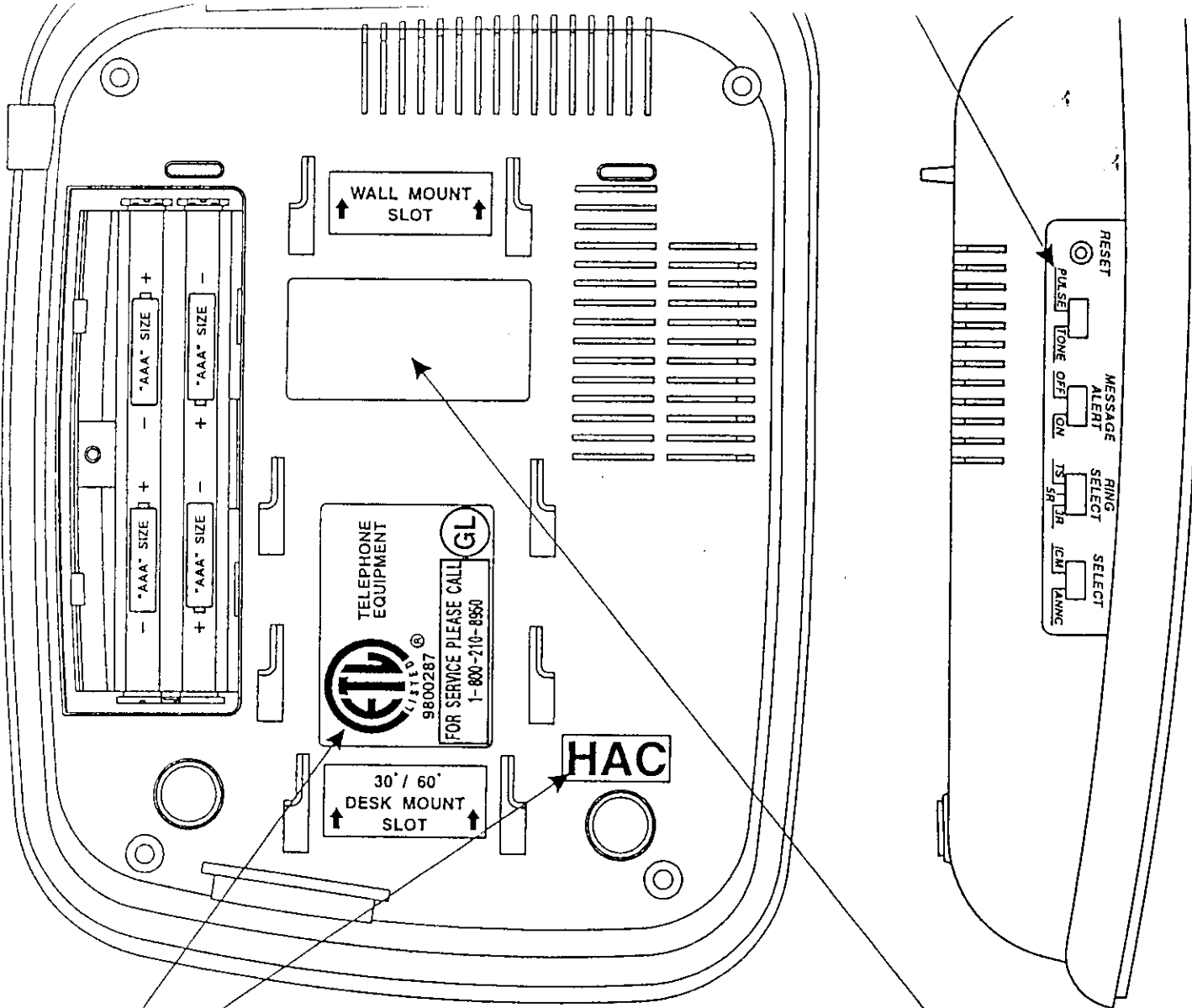

ENGRAVED ON THE CABINET

	MODEL NO.:	MH9043
	FCC ID:	NQL9830

COMPLIES WITH PART 68 FCC RULES.
 FCC REGISTRATION NO.: 6DLCHN-XXXX-W9-E
 RINGER EQUIVALENCE NO.: 1.0B
 CONNECT TO RJ11C

THIS DEVICE COMPLIES WITH PART 15 OF THE FCC RULES. OPERATION IS SUBJECT TO THE FOLLOWING TWO CONDITIONS: (1) THIS DEVICE MAY NOT CAUSE HARMFUL INTERFERENCE, AND (2) THIS DEVICE MUST ACCEPT ANY INTERFERENCE RECEIVED, INCLUDING INTERFERENCE THAT MAY CAUSE UNDESIRE OPERATION.

PRIVACY OF COMMUNICATIONS MAY NOT BE ENSURED WHEN USING THIS PHONE.

PRINTED ON THE LABEL

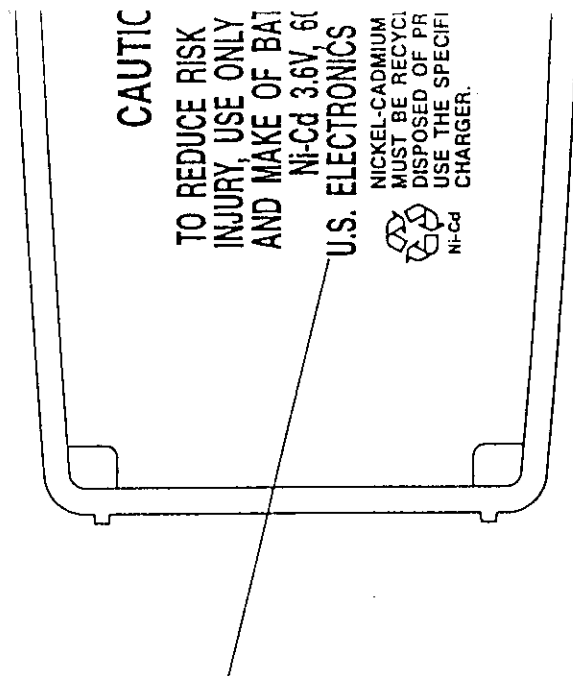
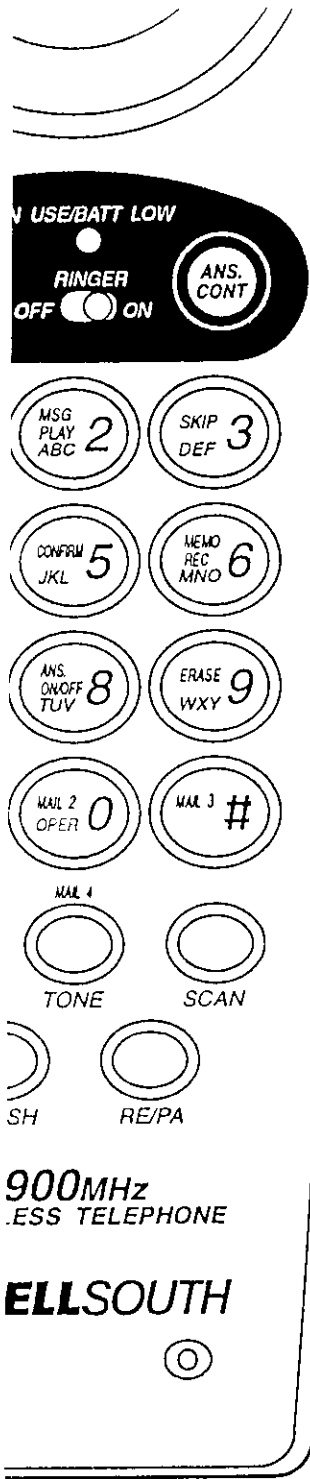

ENGRAVED ON THE CABINET

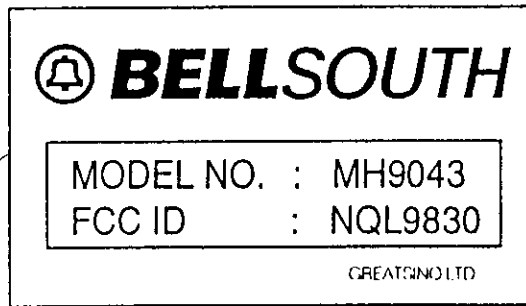

PRINTED ON THE LABEL

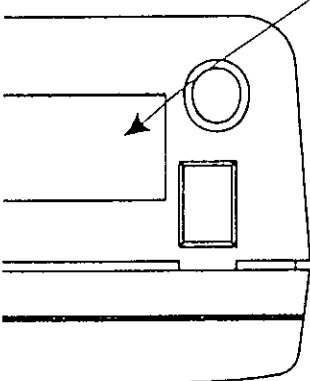

5.2 Label Location

Figure 5.2 Label Location

LABELLING INFORMATION FOR MODEL MH9043 SERIES

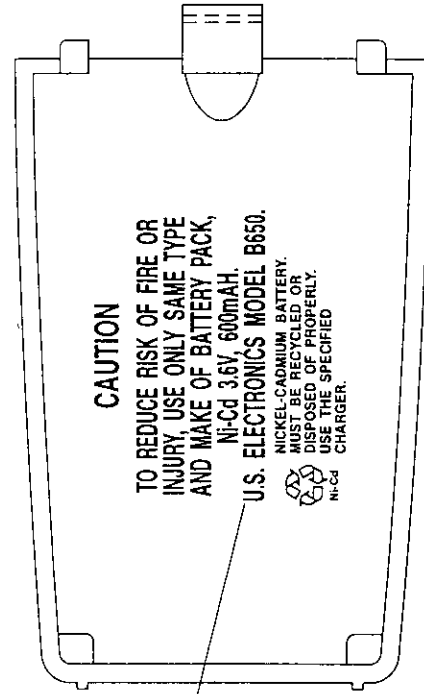
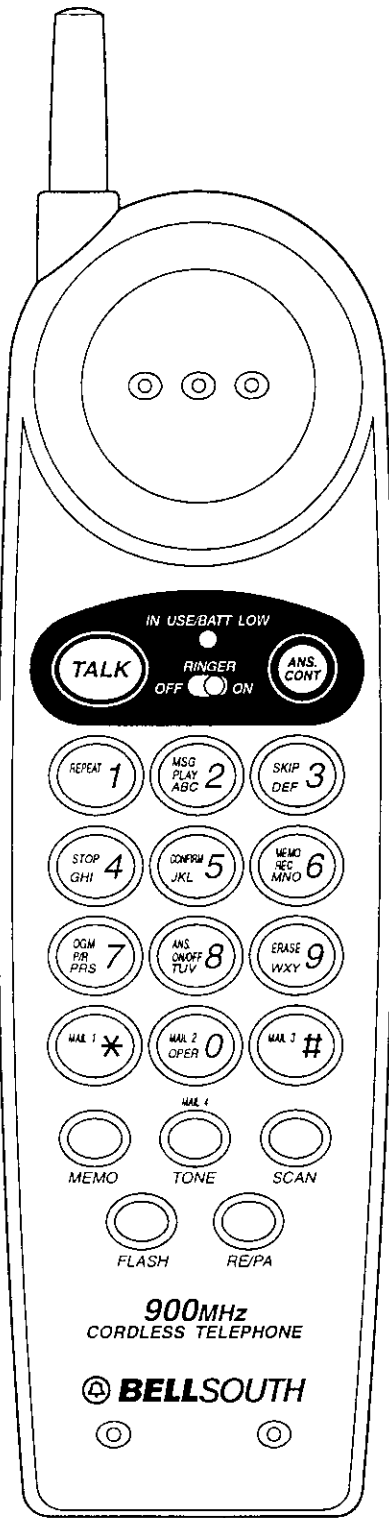

ENGRAVED ON THE CABINET

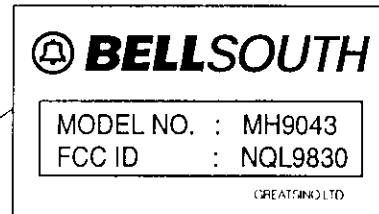

PRINTED ON THE LABEL

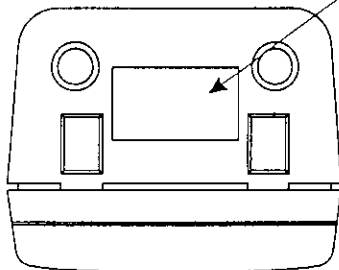

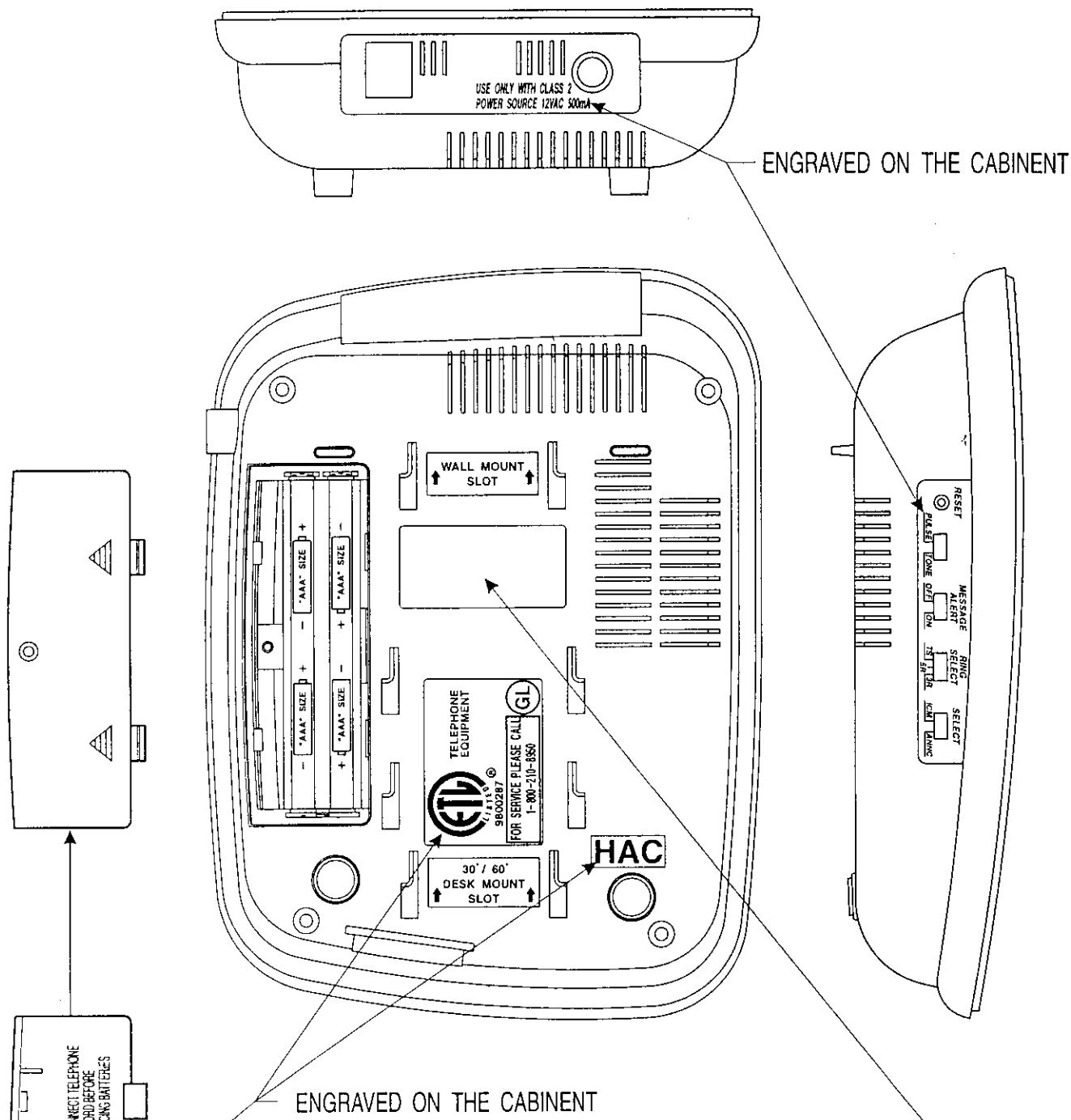

ENGRAVED ON THE CABINET

ENGRAVED ON THE CABINET

	MODEL NO. : MH9043
	FCC ID : NQL9830
COMPLIES WITH PART 68 FCC RULES. FCC REGISTRATION NO. : 6DLCHN-XXXX-W9-E RINGER EQUIVALENCE NO. : 1.0B CONNECT TO RJ11C	
THIS DEVICE COMPLIES WITH PART 15 OF THE FCC RULES. OPERATION IS SUBJECT TO THE FOLLOWING TWO CONDITIONS: (1) THIS DEVICE MAY NOT CAUSE HARMFUL INTERFERENCE, AND (2) THIS DEVICE MUST ACCEPT ANY INTERFERENCE RECEIVED, INCLUDING INTERFERENCE THAT MAY CAUSE UNDESIRABLE OPERATION.	
PRIVACY OF COMMUNICATIONS MAY NOT BE ENSURED WHEN USING THIS PHONE	

PRINTED ON THE LABEL