

**Exhibit 6: Test Report**

**TEST REPORT FROM:**

COMMUNICATION CERTIFICATION LABORATORY  
1940 W. Alexander Street  
Salt Lake City, Utah  
84119-2039

Type of Report: Certification

TEST OF: 900 SS Hopper

FCC ID: NQE-900SSHOPPER

To FCC PART 15.247, Subpart C

Test Report Serial No: 73-6848

Applicant:

World Wireless Communications, Inc.  
2441 South 3850 West  
West Valley City, UT 84116

Date(s) of Test: August 18 - 19, 1999

Issue Date: August 20, 1999

Equipment Receipt Date: August 18, 1999

**CERTIFICATION OF ENGINEERING REPORT**

This report has been prepared by Communication Certification Laboratory to determine compliance of the device described below with the requirements of FCC PART 15.247, Subpart C. This report may be reproduced in full, partial reproduction may only be made with the written consent of the laboratory. The results in this report apply only to the sample tested.

- Applicant: World Wireless Communications, Inc.
- Manufacturer: World Wireless Communications, Inc.
- Brand Name: WWC
- Model Number: 900 SS Hopper
- FCC ID: NQE-900SSHOPPER

On this 20<sup>th</sup> day of August 1999, I, individually, and for Communication Certification Laboratory, certify that the statements made in this engineering report are true, complete, and correct to the best of my knowledge, and are made in good faith.

COMMUNICATION CERTIFICATION LABORATORY

---

Checked by: William S. Hurst, P.E.  
Vice President

---

Tested by: Roger J. Midgley  
EMC Engineering Manager

**SECTION 1. CLIENT INFORMATION AND RESPONSIBLE PARTY:**

**1.1 Client Information:**

Company Name: World Wireless Communications, Inc.  
2441 South 3850 West  
West Valley City, UT 84116

Contact Name: Keith Hollcroft  
Title: Director of Engineering

**SECTION 2. EQUIPMENT UNDER TEST (EUT)**

**2.1 Identification of EUT:**

Trade Name: WWC  
Model Name or Number: 900 SS Hopper  
Serial Number: N/A  
Options Fitted: None  
Country of Manufacture: U.S.A.

**2.2 Description of EUT:**

See theory of operation (Exhibit 12). This report covers the transmitter only the receiver is covered under a separate verification report.

**2.3 Modification Incorporated/Special Accessories on EUT:**

The following modification was made to the 900 SS Hopper by the Client during testing to comply with the specification. These modifications will be implemented during manufacturing.

1. C73 was changed from 5.0pF to 7.0pF.

Signature: \_\_\_\_\_

Typed Name: Keith Hollcroft

Title: Director of Engineering

**2.4 EUT and Support Equipment:**

The FCC ID numbers for all the EUT and support equipment used during the test (including inserted cards) are listed below:

Brand Name Model Number Serial No.	FCC ID Number	Description	Name of Interface Ports/Interface Cables
BN: WWC MN: 900 SS Hopper SN: N/A	NQE- 900SSHOPPER	Data Radio	20 pin, 2mm dual in-line header / 9-32 VDC, TTL or RS232 serial interface

**SECTION 3. TEST SPECIFICATION, METHODS & PROCEDURES****3.1 Test Specification:**

Title: FCC PART 15.247, Subpart C (47 CFR 15).

Limits and methods of measurement of radio interference characteristics of radio frequency devices. Operation within the bands 902-928 MHz, 2400-2483.5 MHz and 5725-5850 MHz.

Purpose of Test: The tests were performed to demonstrate Initial compliance.

**3.2 Methods & Procedures:****3.2.1 § 15.247**

(a) Operation under the provisions of this section is limited to frequency hopping and direct sequence spread spectrum intentional radiators that comply with the following provisions:

(1) Frequency hopping systems shall have hopping channel carrier frequencies separated by a minimum of 25 kHz or the 20 dB bandwidth of the hopping channel, whichever is greater. The system shall hop to channel frequencies that are selected at the system-hopping rate from a pseudorandomly ordered list of hopping frequencies. Each frequency must be used equally on the average by each transmitter. The system receivers shall have input bandwidths that match the hopping channel bandwidths of their corresponding transmitters and shall shift frequencies in synchronization with the transmitting signals.

(i) For frequency hopping systems operating in the 902 - 928 MHz band: if the 20 dB bandwidth of the hopping channel is less than 250 kHz, the system shall use at least 50 hopping frequencies and the average time of occupancy on any frequency shall not be greater than 0.4 seconds within a 20 second period; if the 20 dB bandwidth of the hopping channel is 250 kHz or greater, the system shall use at least 25 hopping frequencies and the average time of occupancy on any frequency shall not be greater than 0.4 seconds within a 10 second period. The maximum allowed 20 dB bandwidth of the hopping channel is 500 kHz.

(ii) Frequency hopping systems operating in the 2400 - 2483.5 MHz and the 5725 - 5850 MHz bands shall use at least 75 hopping frequencies. The maximum allowed 20 dB bandwidth of the hopping channel is 1 MHz. The average time of occupancy on any frequency shall not be greater than 0.4 seconds within a 30 second period.

(2) For direct sequence systems, the minimum 6 dB bandwidth shall be at least 500 kHz.

(b) The maximum peak output power of the intentional radiator shall not exceed the following:

(1) For frequency hopping systems operating in the 2400 - 2483.5 MHz or 5725 - 5850 MHz band and for all direct sequence systems: 1 watt.

(2) For frequency hopping systems operating in the 902 - 928 MHz band: 1 watt for systems employing at least 50 hopping channels; and 0.25 watts for systems employing less than 50 hopping channels, but at least 25 hopping channels, as permitted under paragraph (a)(1)(i) of this section.

(3) Except as show in paragraphs (b)(3)(i), (ii) and (iii) of this section, if transmitting antennas of directional gain greater than 6 dBi are used the peak output power from the intentional radiator shall be reduced below the stated values in paragraphs (b)(1) or (b)(2) of this section, as appropriate, by the amount in dB that the directional gain of the antenna exceeds 6 dBi.

(i) Systems operating in the 2400 - 2483.5 MHz band that are used exclusively for fixed, point-to-point operations may employ transmitting antennas with directional gain greater than 6 dBi provided the maximum peak output power of the intentional radiator is reduced by 1 dB for every 3 dB that the directional gain of the antenna exceeds 6 dBi.

(ii) Systems operating in the 5725 - 5850 MHz band that are used exclusively for fixed, point-to-point operations may employ transmitting antennas with directional gain greater than 6 dBi without any corresponding reduction in transmitter peak output power.

(iii) Fixed, point-to-point operation, as used in paragraphs (b)(3)(i) and (b)(3)(ii) of this section, excludes the use of point-to-multipoint systems, omnidirectional applications, and multiple co-located intentional radiators transmitting the same information. The operator of the spread spectrum intentional radiator or, if the equipment is professionally installed, the

installer is responsible for ensuring that the system is used exclusively for fixed, point-to-point operations. The instruction manual furnished with the intentional radiator shall contain language in the installation instructions informing the operator and the installer of the responsibility.

(4) Systems operating under the provisions of this section shall be operated in a manner that ensures that the public is not exposed to radio frequency energy levels in excess of the Commission's guidelines. See Sec. 1.1307(b)(1) of this chapter.

(c) In any 100 kHz bandwidth outside the frequency band in which the spread spectrum intentional radiator is operating, the radio frequency power that is produced by the intentional radiator shall be at least 20 dB below that in any 100 kHz bandwidth within the band that contains the highest level of the desired power, based on either an RF conducted or a radiated measurement. Attenuation below the general levels specified in § 15.209(a) is not required. In addition, radiated emissions which fall in the restricted bands, as defined in § 15.205(a), must also comply with the radiated emission limits specified in § 15.209(a) (see § 15.205(c)).

(d) For direct sequence systems, the peak power density conducted from the intentional radiator to the antenna shall not be greater than 8 dBm in any 3 kHz band during any time interval of continuous transmission.

(e) The processing gain of a direct sequence system shall be at least 10 dB. The processing gain represents the improvement to the received signal-to-noise ratio, after filtering to the information bandwidth, from the spreading/despreading function. The processing gain may be determined using one of the following methods:

(1) As measured at the demodulated output of the receiver: the ratio in dB of the signal-to-noise ratio with the system spreading code turned off to the signal-to-noise ratio with the system spreading code turned on.

(2) As measured using the CW jamming margin method: a signal generator is stepped in 50 kHz increments across the passband of the system, recording at each point the generator level required to produce the recommended Bit Error Rate (BER). This level is the jammer level. The output power of the intentional radiator is measured at the same point. This jammer to signal ratio (J/S) is then calculated, discarding the worst 20% of the J/S data points. The lowest remaining J/S ratio is used to calculate the



processing gain, as follows:  $G_p = (S/N)_o + M_j + L_{sys}$ , where  $G_p$  = processing gain of the system,  $(S/N)_o$  = signal to noise ratio required for the chosen BER,  $M_j$  = J/S ratio, and  $L_{sys}$  = system losses. Note that total losses in a system, including intentional radiator and receiver, should be assumed to be no more than 2 dB.

(f) Hybrid systems that employ a combination of both direct sequence and frequency hopping modulation techniques shall achieve a processing gain of at least 17 dB from the combined techniques. The frequency hopping operation of the hybrid system, with the direct sequence operation turned off, shall have an average time of occupancy on any frequency not to exceed 0.4 seconds within a time period in seconds equal to the number of hopping frequencies employed multiplied by 0.4. The direct sequence operation of the hybrid system, with the frequency hopping operation turned off, shall comply with the power density requirements of paragraph (d) of this section.

(g) Frequency hopping spread spectrum systems are not required to employ all available hopping channels during each transmission. However, the system, consisting of both the transmitter and the receiver, must be designed to comply with all of the regulations in this section should the transmitter be presented with a continuous data (or information) stream. In addition, a system employing short transmission bursts must comply with the definition of a frequency hopping system and must distribute its transmission over the minimum number of hopping channels specified in this section.

(h) The incorporation of intelligence within a frequency hopping spread spectrum system that permits the system to recognize other users within the spectrum band so that it individually and independently chooses and adapts its hopset to avoid hopping on occupied channels is permitted. The coordination of frequency hopping systems in any other manner for the express purpose of avoiding the simultaneous occupancy of individual hopping frequencies by multiple transmitters is not permitted.

NOTE: Spread spectrum systems are sharing these bands on a non-interference basis with systems supporting critical Government requirements that have been allocated the usage of these bands, secondary only to ISM equipment operated under the provisions of part 18 of this chapter. Many of these Government systems are airborne radiolocation systems that emit a high EIRP, which can cause interference to other users. Also, investigations of the effect of spread spectrum interference to U.S. Government operations in the 902-928 MHz band may require a future

decrease in the power limits allowed for spread spectrum operation.

### **3.2.2 § 15.207 Conducted Limits**

(a) For an intentional radiator which is designed to be connected to the public utility (AC) power line, the radio frequency voltage that is conducted back onto the AC power line on any frequency or frequencies within the band 450 kHz to 30 MHz shall not exceed 250 microvolts. Compliance with the provision shall be based on the measurement of the radio frequency voltage between each power line and ground at the power terminals.

(b) The following option may be employed if the conducted emissions exceed the limits in paragraph (a) of this section when measured using instrumentation employing a quasi-peak detector function: If the level of the emission measured using the quasi-peak instrumentation is 6 dB, or more, higher than the level of the same emission measured with instrumentation having an average detector and a 9 kHz minimum bandwidth, that emission is considered broadband and the level obtained with the quasi-peak detector may be reduced by 13 dB for comparison to the limits. When employing this option, the following conditions shall be observed:

(1) The measuring instrumentation with the average detector shall employ a linear IF amplifier.

(2) Care must be taken not to exceed the dynamic range of the measuring instrument when measuring an emission with a low duty cycle.

(3) The test report required for verification of for an application for a grant of equipment authorization shall contain all details supporting the use of this option.

(c) The limit shown in paragraph (a) of this section shall not apply to carrier current systems operation as intentional radiators on frequencies below 30 MHz. In lieu thereof, these carrier current systems shall be subject to the following standards:

(1) For carrier current systems containing their fundamental emission within the frequency band 535-1705 kHz and intended to be received using a standard AM broadcast receiver: no limit on conducted emissions.

(2) For all other carrier current systems: 1000  $\mu$ V within the frequency band 535-1705 kHz.

(3) Carrier current systems operating below 30 MHz are also subject to the radiated emission limits in §§ 15.205, 15.209, 15.221, 15.223, 15.225 or 15.227, as appropriate.

(d) Measurements to demonstrate compliance with the conducted limits are not required for devices which only employ battery power for operation and which do not operate from the AC power lines or contain provisions for operation while connected to the AC power lines. Devices that include, or make provision for, the use of battery chargers which permit operation while charging, AC adapters or battery eliminators or that connect to the AC power lines indirectly, obtaining their power through another device which is connected to the AC power lines, shall be tested to demonstrate compliance with the conducted limits.

### **3.2.3 Test Procedure**

The testing was performed according to the procedures in ANSI C63.4 (1992). Testing was performed at CCL's anechoic chamber located in Salt Lake City, Utah. This site has been fully described in a report submitted to the FCC, and was accepted in a letter dated March 1, 1999 (31040/SIT).

CCL participates in the National Voluntary Laboratory Accreditation Program (NVLAP) and has been accepted under NVLAP Lab Code:100272-0, which is effective until September 30,1999.

For radiated emissions testing that is performed at distances closer than the specified distance, an inverse proportionality factor of 20 dB per decade is used to normalize the measured data for determining compliance.

**SECTION 4. OPERATION OF EUT DURING TESTING.****4.1 Operating Environment:**

Power Supply: 9-32 VDC  
AC Mains Frequency: N/A

**4.2 Operating Modes:**

Each mode of operation was exercised to produce worst case emissions. The worst case emissions were with the 900 SS Hopper running in the following mode. The 900 SS Hopper was placed in the transmit mode with the same type of modulation that would normally be used during normal operation.

The 900 SS Hopper receives its power from an AC to DC power supply or from the host device; therefore, the AC line conducted test was performed with the AC to DC power supply plugged into the LISN.

**4.3 Configuration & Peripherals:**

The 900 SS Hopper was placed on the table in the transmit mode with the same type of modulation that would normally be used during normal operation.

**SECTION 5. SUMMARY OF TEST RESULTS:****5.1 FCC PART 15.247, Subpart C****5.1.1 Summary of Tests:**

<b>Section</b>	<b>Test Performed</b>	<b>Frequency Range (MHz)</b>	<b>Result</b>
15.247 (a)(1)	Hopping Channel Carrier Frequencies	902 to 928	Complied
15.247 (a)(1)(i)	Emission Bandwidth	902 to 928	Complied
15.247 (b)(2)	Peak Output Power	902 to 928	Complied
15.247 (C)	Antenna Conducted Spurious Emissions	9 to 10,000	Complied
15.247 (C)	Radiated Spurious Emissions	9 to 10,000	Complied
15.207	Line Conducted Emissions (Hot Lead to Ground)	0.45 to 30	Complied
15.207	Line Conducted Emissions (Neutral Lead to Ground)	0.45 to 30	Complied

**5.2 Result**

In the configuration tested, the EUT complied with the requirements of the specification.

**SECTION 6. MEASUREMENTS, EXAMINATIONS AND DERIVED RESULTS:****6.1 General Comments:**

This section contains the test results only. Details of the test methods used, etc., can be found in Appendix B of this report.

**6.2 Test Results****6.2.1 § 15.247 (a) (1)****Demonstration of Compliance:**

See theory of operation in Exhibit 12.

**6.3.2 § 15.247 (a) (1) (i)****Demonstration of Compliance:**

See theory of operation in Exhibit 12.

**Measurement Data Emission Bandwidth:**

A diagram of the test configuration is enclosed in Appendix A and a list of reference codes for test equipment used is enclosed in Appendix B.

Test equipment used: 1, 3 and 4.

Frequency (MHz)	Measured Emission Bandwidth (kHz)
903.0	222.5
913.0	223.0
922.6	222.0

**RESULT**

In the configuration tested, the EUT complied with the requirements of the specification (see spectrum analyzer plots below).

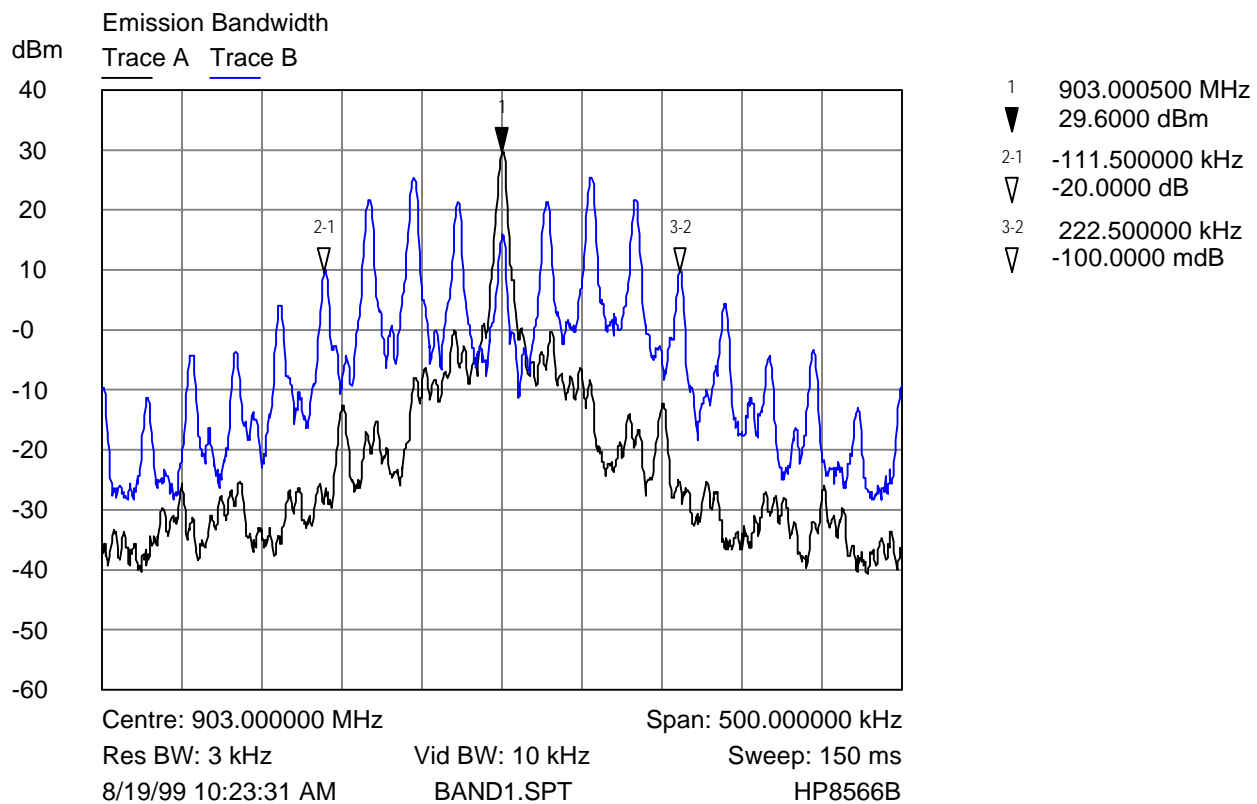

Emission Bandwidth (Low End of Band)

Trace A Unmodulated Carrier

Trace B Modulated Carrier

Emission Bandwidth (Low end of band)

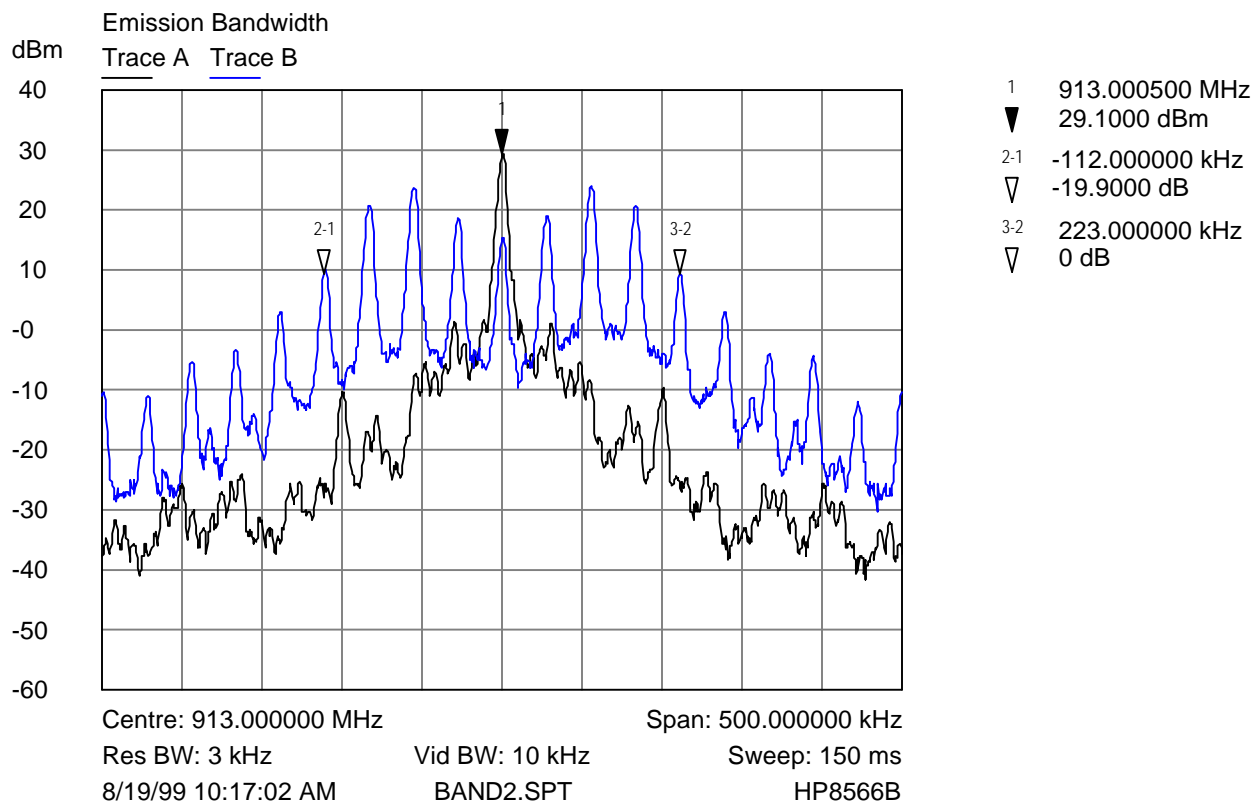

Emission Bandwidth (Middle of Band)

Trace A Unmodulated Carrier

Trace B Modulated Carrier

Emission Bandwidth (Middle of band)



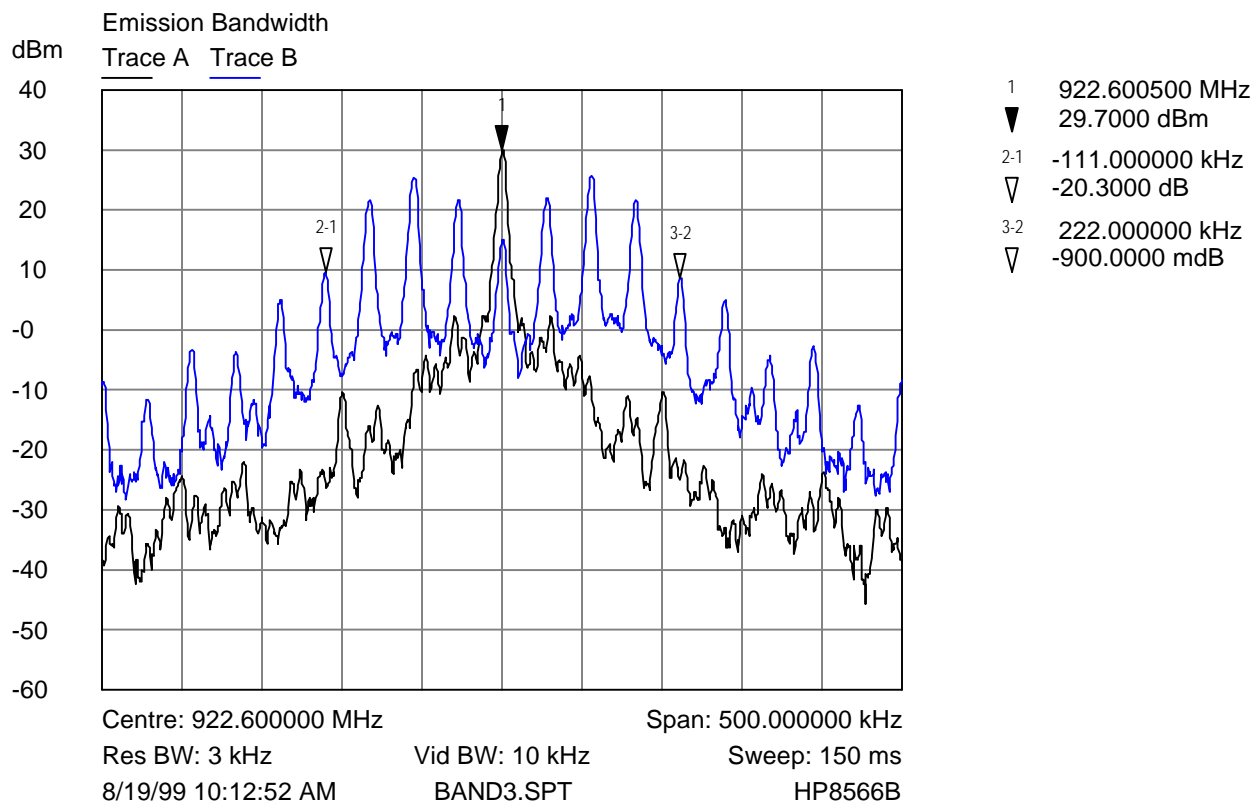

Emission Bandwidth (High End of Band)

Trace A Unmodulated Carrier

Trace B Modulated Carrier

Emission Bandwidth (High end of band)

**6.2.3 § 15.247 (b) Peak Output Power:****Measurement Data:**

The maximum peak output power measured for this device was 0.891 W or 29.5 dBm. Shown below is the measured peak output power. The 900 SS Hopper can be installed with the four different types of antennas listed below.

<u>Antenna Type</u>	<u>Model</u>	<u>Antenna Gain</u>
Small Dipole		0 dBi
Large Dipole		3 dBi
Comtelco Yagi	Y2283A-66	6 dBi
Maxrad Omni	MFB9155	5 dBi

The maximum directional gain of the each antenna is less than 6 dBi; therefore, the maximum output power is not required to be reduced from the value measured.

A diagram of the test configuration is enclosed in Appendix A and a list of reference codes for test equipment used is enclosed in Appendix B.

Test equipment used: 1, 3 and 4.

Frequency (MHz)	Measured Output Power (dBm)	Measured Output Power (W)
903.0	29.3	0.852
913.0	29.1	0.813
922.6	29.5	0.891

**RESULT**

In the configuration tested, the EUT complied with the requirements of the specification (see spectrum analyzer plots below).

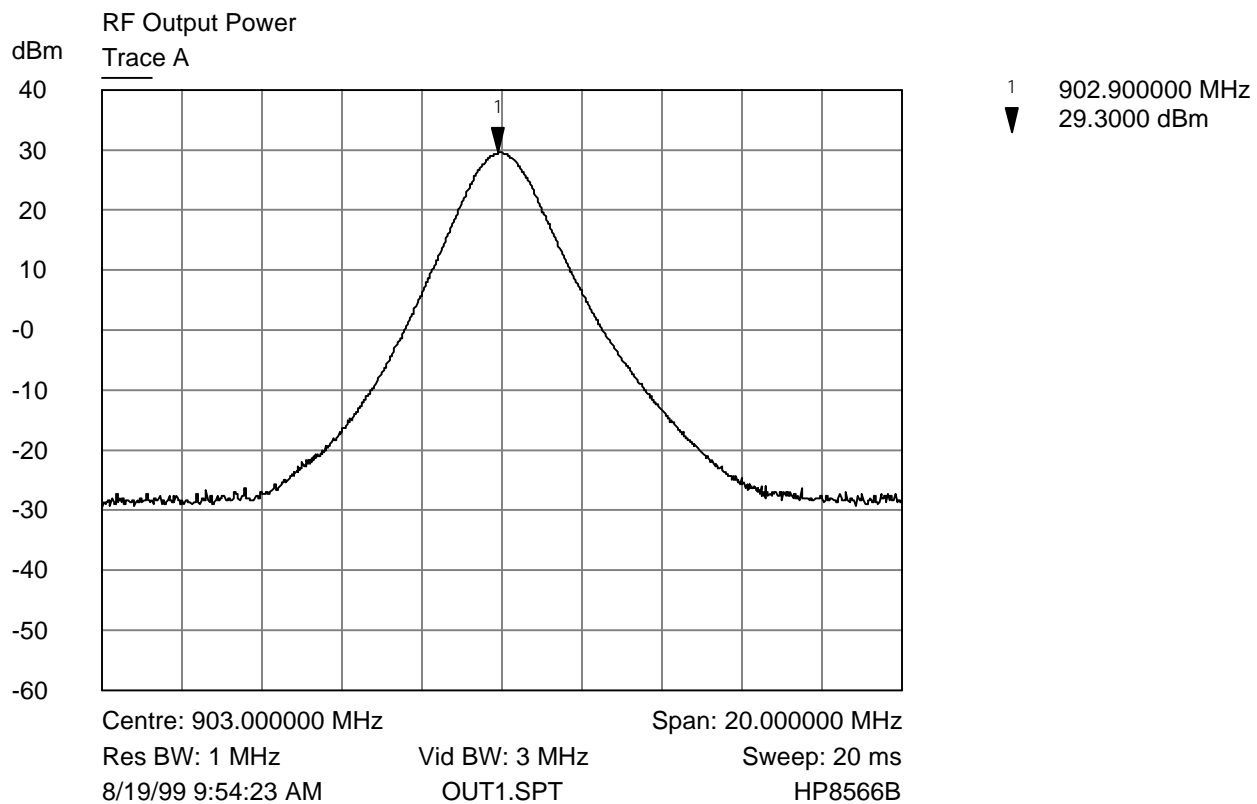

RF Output Power (Low End of Band)

Trace A 30.8 dB Offset (30 dB Attenuator and Cable)

RF Output Power (Low end of band)

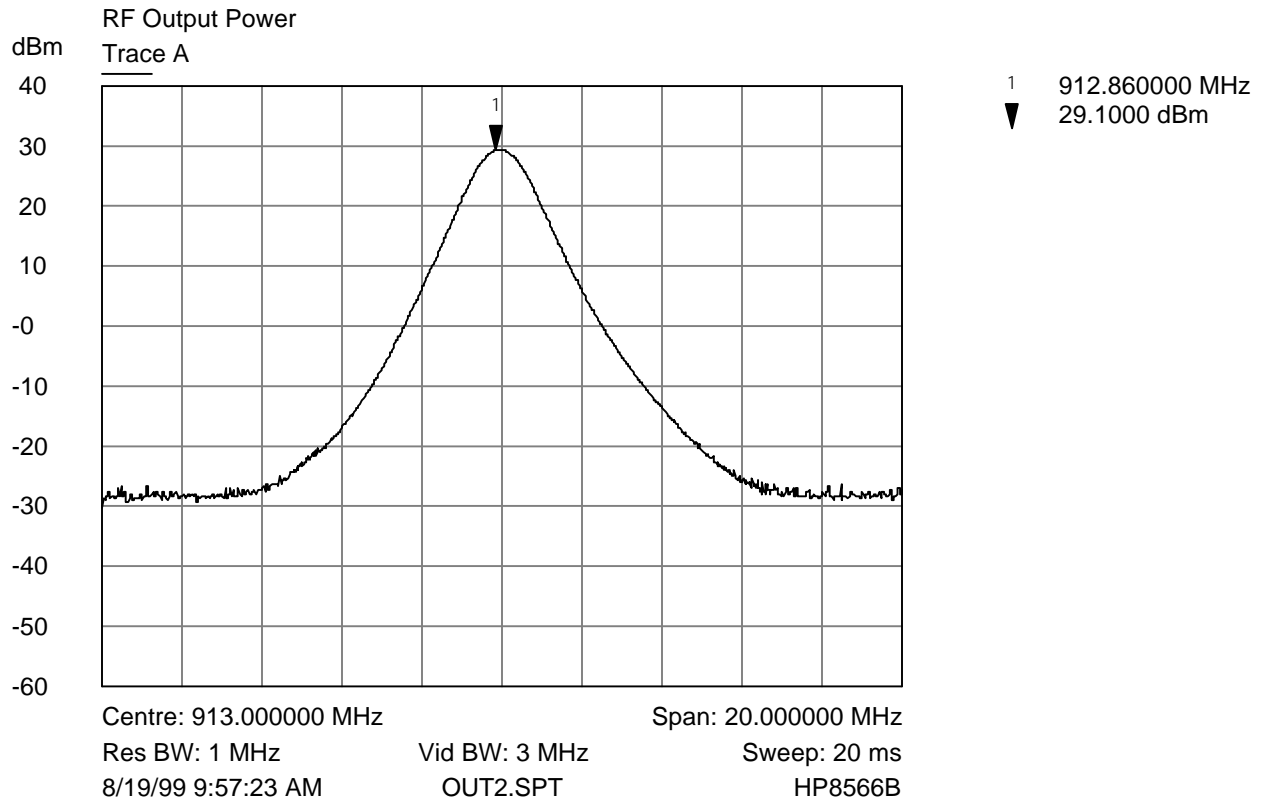

RF Output Power (Middle of Band)

Trace A 30.8 dB Offset (30 dB Attenuator and Cable)

RF Output Power (Middle of band)

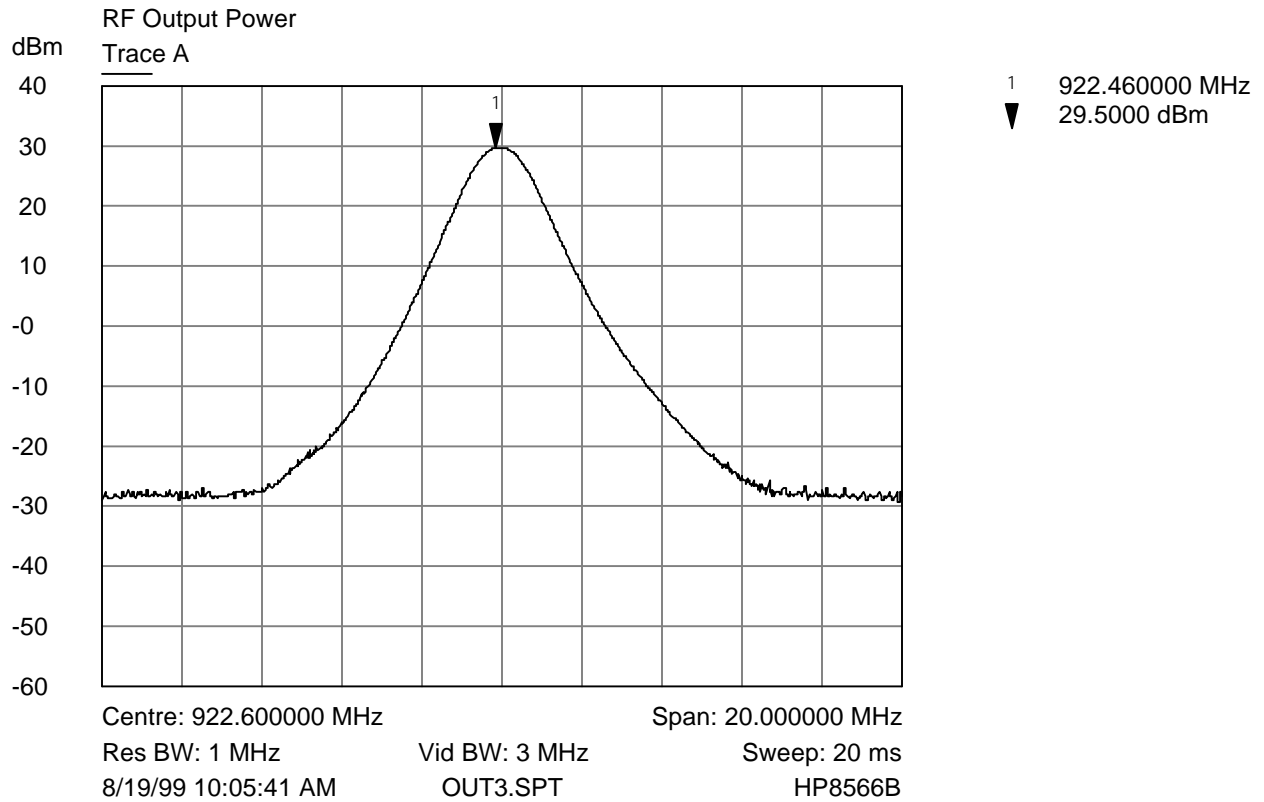

RF Output Power (High End of Band)

Trace A 30.8 dB Offset (30 dB Attenuator and Cable)

RF Output Power (High end of band)

**6.2.4 § 15.247 (c) Spurious Emissions:**

**Measurement Data Antenna Conducted Emissions:**

The frequency range from 9 MHz to the tenth harmonic of the highest fundamental frequency was investigated to measure any antenna-conducted emissions. Shown below are plots with the 900 SS Hopper tuned to the upper and lower band edges. These demonstrate compliance with the provisions of this section.

A diagram of the test configuration is enclosed in Appendix A and a list of reference codes for test equipment used is enclosed in Appendix B.

Test equipment used: 1, 3 and 4.

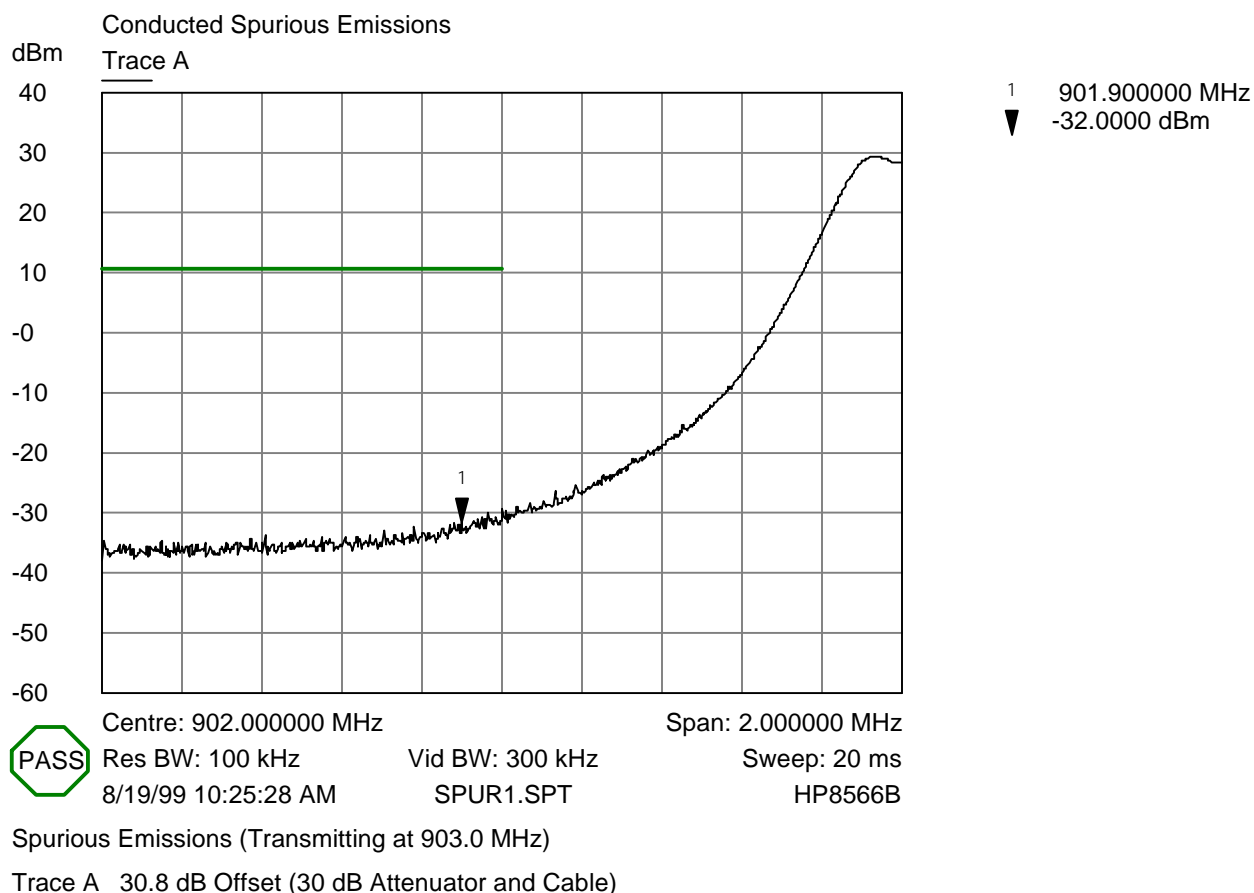

Conducted Spurious Emissions (Transmitting at 903.0 MHz)

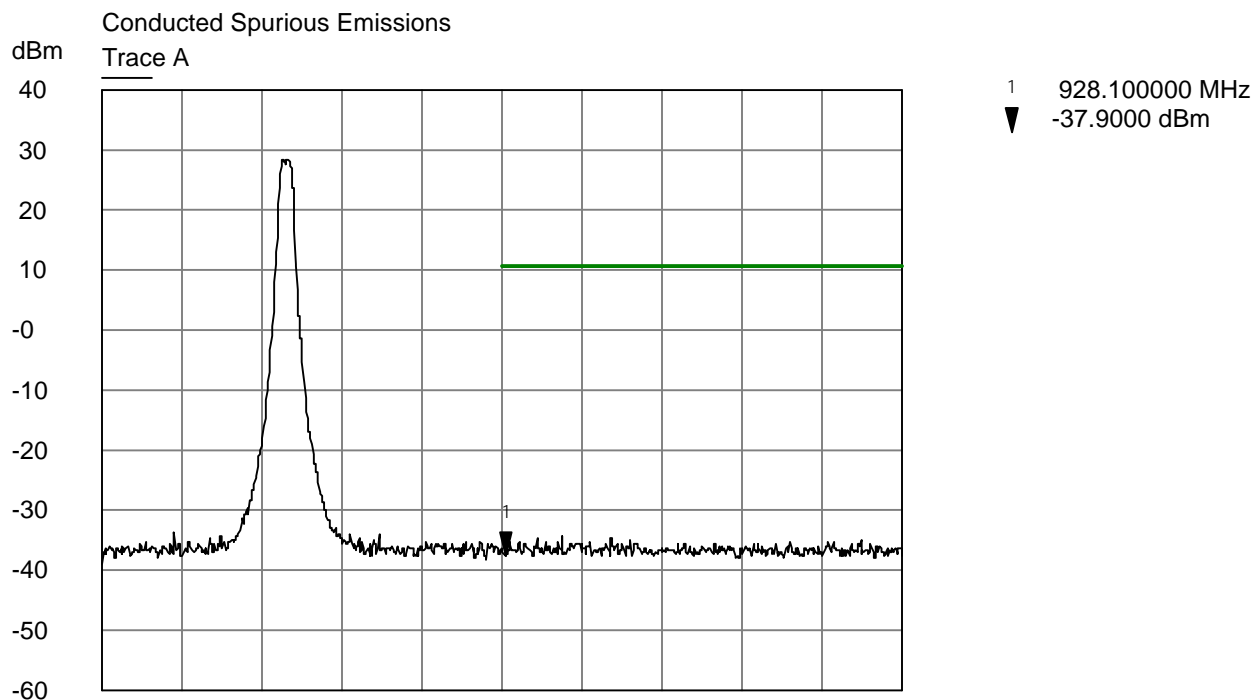

Centre: 928.000000 MHz Span: 20.000000 MHz  
Res BW: 100 kHz Vid BW: 300 kHz Sweep: 20 ms  
8/19/99 10:27:01 AM SPUR2.SPT HP8566B

Spurious Emissions (Transmitting at 922.6 MHz)

Trace A 30.8 dB Offset (30 dB Attenuator and Cable)

Conducted Spurious Emissions (Transmitting at 922.6 MHz)



The emissions must be attenuated 20 dB below the highest power level measured; therefore, the criteria is  $29.3 - 20.0 = 9.3$  dBm.

Transmitting at 903.0 MHz			
Frequency Range MHz	Frequency MHz	Corrected Level dBm	Criteria dBm
9 -200	182.9	-58.0	9.3
200 - 901.9	879.1	-37.2	9.3
928.1 - 1000	950.9	-54.7	9.3
1000 - 2000	1806.0	-50.6	9.3
2000 - 3000	2709.0	-51.5	9.3
3000 - 4000	3612.0	-70.1	9.3
4000 - 5000	4515.0	-55.5	9.3
5000 - 6000	5418.0	-50.6	9.3
6000 - 7000	6321.0	-69.2 *	9.3
7000 - 8000	7224.0	-68.1 *	9.3
8000 - 9000	8127.0	-67.5 *	9.3
9000 - 10000	9030.0	-63.2 *	9.3
* Noise Floor			

The emissions must be attenuated 20 dB below the highest power level measured; therefore, the criteria is  $29.1 - 20.0 = 9.1$  dBm.

Transmitting at 913.0 MHz			
Frequency Range MHz	Frequency MHz	Corrected Level dBm	Criteria dBm
9 -200	55.2	-46.5	9.1
200 - 901.9	888.9	-38.9	9.1
928.1 - 1000	936.9	-39.1	9.1
1000 - 2000	1826.0	-53.4	9.1
2000 - 3000	2739.0	-53.3	9.1
3000 - 4000	3652.0	-65.4	9.1
4000 - 5000	4565.0	-62.7	9.1
5000 - 6000	5478.0	-73.1 *	9.1
6000 - 7000	6391.0	-69.2 *	9.1
7000 - 8000	7304.0	-68.1 *	9.1
8000 - 9000	8217.0	-67.5 *	9.1
9000 - 10000	9130.0	-63.2 *	9.1
* Noise Floor			



The emissions must be attenuated 20 dB below the highest power level measured; therefore, the criteria is  $29.5 - 20.0 = 9.5$  dBm.

Transmitting at 922.6 MHz			
Frequency Range MHz	Frequency MHz	Corrected Level dBm	Criteria dBm
9 - 200	55.2	-49.1	9.5
200 - 901.9	898.6	-39.0	9.5
928.1 - 1000	946.6	-39.2	9.5
1000 - 2000	1845.2	-48.7	9.5
2000 - 3000	2767.8	-54.6	9.5
3000 - 4000	3690.4	-57.0	9.5
4000 - 5000	4613.0	-72.0	9.5
5000 - 6000	5535.6	-52.3	9.5
6000 - 7000	6458.2	-69.2 *	9.5
7000 - 8000	7380.8	-68.1 *	9.5
8000 - 9000	8303.4	-63.8	9.5
9000 - 10000	9226.0	-63.2 *	9.5
* Noise Floor			

#### Measurement Data Radiated Emissions Restricted Bands § 15.205:

The frequency range from 9 MHz to 10 GHz was investigated to measure any radiated emissions in the restricted bands.

A diagram of the test configuration is enclosed in Appendix A and a list of reference codes for test equipment used is enclosed in Appendix B.

Test equipment used: 1, 3, 4, 6, 7, 8, 9 and 12.

#### AVERAGE FACTOR

The 900 SS Hopper transmits continuously therefore, there is not an average factor for this device.

The 900 SS Hopper can be installed with the four different types of antennas listed below; therefore, measurements were performed with the 900 SS Hopper transmitting on all four antennas. The results for each measurement are shown below.

<u>Antenna Type</u>	<u>Model</u>	<u>Antenna Gain</u>
Small Dipole		0 dBi
Large Dipole		3 dBi
Comtelco Yagi	Y2283A-66	6 dBi
Maxrad Omni	MFB9155	5 dBi

**Vertical Polarity (Small Dipole Antenna)**

Transmitting at 903.0 MHz					
Frequency MHz	Detector	Receiver Reading dB $\mu$ V	Correction Factor dB	Corrected Reading dB $\mu$ V/m	Limit dB $\mu$ V/m
2709.0	Peak	8.4	36.7	45.1	74.0
2709.0	Average	-1.5	36.7	35.2	54.0
3612.0	Peak	6.5	39.9	46.4	74.0
3612.0	Average	-2.0	39.9	37.9	54.0
4515.0	Peak	7.5	41.4	48.9	74.0
4515.0	Average	-2.6	41.4	38.8	54.0
5418.0	Peak	8.4 *	45.8	54.2	74.0
5418.0	Average	-0.2 *	45.8	45.6	54.0
8127.0	Peak	13.6 *	40.8	54.4	74.0
8127.0	Average	2.0 *	40.8	42.8	54.0
9030.0	Peak	14.3 *	41.6	55.9	74.0
9030.0	Average	3.2 *	41.6	44.8	54.0
* No emissions were detected with the antenna 1 meter from the EUT, the indicated readings are the noise floor measurements from the spectrum analyzer					

Transmitting at 913.0 MHz					
Frequency MHz	Detector	Receiver Reading dB $\mu$ V	Correction Factor dB	Corrected Reading dB $\mu$ V/m	Limit dB $\mu$ V/m
2739.0	Peak	9.3	36.7	46.0	74.0
2739.0	Average	-1.8	36.7	34.9	54.0
3652.0	Peak	5.4	39.9	45.3	74.0
3652.0	Average	-2.4	39.9	37.5	54.0
4565.0	Peak	8.1	41.4	49.5	74.0
4565.0	Average	-2.1	41.4	39.3	54.0
7304.0	Peak	7.6 *	45.8	53.4	74.0
7304.0	Average	-2.4 *	45.8	43.4	54.0
8217.0	Peak	13.6 *	40.8	54.4	74.0
8217.0	Average	2.0 *	40.8	42.8	54.0
9130.0	Peak	14.3 *	41.6	55.9	74.0
9130.0	Average	3.2 *	41.6	44.8	54.0
* No emissions were detected with the antenna 1 meter from the EUT, the indicated readings are the noise floor measurements from the spectrum analyzer					

Transmitting at 922.6 MHz					
Frequency MHz	Detector	Receiver Reading dB $\mu$ V	Correction Factor dB	Corrected Reading dB $\mu$ V/m	Limit dB $\mu$ V/m
2767.8	Peak	8.8	36.7	45.5	74.0
2767.8	Average	-1.0	36.7	35.7	54.0
3690.4	Peak	7.3	39.9	47.2	74.0
3690.4	Average	-1.5	39.9	38.4	54.0
4613.0	Peak	6.4	41.4	47.8	74.0
4613.0	Average	-2.5	41.4	38.9	54.0
7380.8	Peak	7.6 *	45.8	53.4	74.0
7380.8	Average	-2.4 *	45.8	43.4	54.0
8303.4	Peak	13.6 *	40.8	54.4	74.0
8303.4	Average	2.0 *	40.8	42.8	54.0
* No emissions were detected with the antenna 1 meter from the EUT, the indicated readings are the noise floor measurements from the spectrum analyzer					

**Horizontal Polarity (Small Dipole Antenna)**

Transmitting at 903.0 MHz					
Frequency MHz	Detector	Receiver Reading dB $\mu$ V	Correction Factor dB	Corrected Reading dB $\mu$ V/m	Limit dB $\mu$ V/m
2709.0	Peak	7.1	36.7	43.8	74.0
2709.0	Average	-2.5	36.7	34.2	54.0
3612.0	Peak	5.4	39.9	45.3	74.0
3612.0	Average	-2.8	39.9	37.1	54.0
4515.0	Peak	8.1	41.4	49.5	74.0
4515.0	Average	-2.0	41.4	39.4	54.0
5418.0	Peak	8.4 *	45.8	54.2	74.0
5418.0	Average	-0.2 *	45.8	45.6	54.0
8127.0	Peak	13.6 *	40.8	54.4	74.0
8127.0	Average	2.0 *	40.8	42.8	54.0
9030.0	Peak	14.3 *	41.6	55.9	74.0
9030.0	Average	3.2 *	41.6	44.8	54.0
* No emissions were detected with the antenna 1 meter from the EUT, the indicated readings are the noise floor measurements from the spectrum analyzer					

Transmitting at 913.0 MHz					
Frequency MHz	Detector	Receiver Reading dB $\mu$ V	Correction Factor dB	Corrected Reading dB $\mu$ V/m	Limit dB $\mu$ V/m
2739.0	Peak	10.1	36.7	46.8	74.0
2739.0	Average	-1.5	36.7	35.2	54.0
3652.0	Peak	6.1	39.9	46.0	74.0
3652.0	Average	-2.1	39.9	37.8	54.0
4565.0	Peak	7.6	41.4	49.0	74.0
4565.0	Average	-2.6	41.4	38.8	54.0
7304.0	Peak	7.6 *	45.8	53.4	74.0
7304.0	Average	-2.4 *	45.8	43.4	54.0
8217.0	Peak	13.6 *	40.8	54.4	74.0
8217.0	Average	2.0 *	40.8	42.8	54.0
9130.0	Peak	14.3 *	41.6	55.9	74.0
9130.0	Average	3.2 *	41.6	44.8	54.0
* No emissions were detected with the antenna 1 meter from the EUT, the indicated readings are the noise floor measurements from the spectrum analyzer					

Transmitting at 922.6 MHz					
Frequency MHz	Detector	Receiver Reading dB $\mu$ V	Correction Factor dB	Corrected Reading dB $\mu$ V/m	Limit dB $\mu$ V/m
2767.8	Peak	8.5	36.7	45.2	74.0
2767.8	Average	-1.2	36.7	35.5	54.0
3690.4	Peak	7.6	39.9	47.5	74.0
3690.4	Average	-1.2	39.9	38.7	54.0
4613.0	Peak	5.6	41.4	47.0	74.0
4613.0	Average	-2.8	41.4	38.6	54.0
7380.8	Peak	7.6 *	45.8	53.4	74.0
7380.8	Average	-2.4 *	45.8	43.4	54.0
8303.4	Peak	13.6 *	40.8	54.4	74.0
8303.4	Average	2.0 *	40.8	42.8	54.0
* No emissions were detected with the antenna 1 meter from the EUT, the indicated readings are the noise floor measurements from the spectrum analyzer					

**Vertical Polarity (Large Dipole Antenna)**

Transmitting at 903.0 MHz					
Frequency MHz	Detector	Receiver Reading dB $\mu$ V	Correction Factor dB	Corrected Reading dB $\mu$ V/m	Limit dB $\mu$ V/m
2709.0	Peak	10.5	36.7	47.2	74.0
2709.0	Average	0.5	36.7	37.2	54.0
3612.0	Peak	8.6	39.9	48.5	74.0
3612.0	Average	-1.0	39.9	38.9	54.0
4515.0	Peak	8.1	41.4	49.5	74.0
4515.0	Average	-2.0	41.4	39.4	54.0
5418.0	Peak	8.4 *	45.8	54.2	74.0
5418.0	Average	-0.2 *	45.8	45.6	54.0
8127.0	Peak	13.6 *	40.8	54.4	74.0
8127.0	Average	2.0 *	40.8	42.8	54.0
9030.0	Peak	14.3 *	41.6	55.9	74.0
9030.0	Average	3.2 *	41.6	44.8	54.0
* No emissions were detected with the antenna 1 meter from the EUT, the indicated readings are the noise floor measurements from the spectrum analyzer					



Transmitting at 913.0 MHz					
Frequency MHz	Detector	Receiver Reading dB $\mu$ V	Correction Factor dB	Corrected Reading dB $\mu$ V/m	Limit dB $\mu$ V/m
2739.0	Peak	11.6	36.7	48.3	74.0
2739.0	Average	1.2	36.7	37.9	54.0
3652.0	Peak	7.8	39.9	47.7	74.0
3652.0	Average	-1.2	39.9	38.7	54.0
4565.0	Peak	8.9	41.4	50.3	74.0
4565.0	Average	-1.6	41.4	39.8	54.0
7304.0	Peak	7.6 *	45.8	53.4	74.0
7304.0	Average	-2.4 *	45.8	43.4	54.0
8217.0	Peak	13.6 *	40.8	54.4	74.0
8217.0	Average	2.0 *	40.8	42.8	54.0
9130.0	Peak	14.3 *	41.6	55.9	74.0
9130.0	Average	3.2 *	41.6	44.8	54.0
* No emissions were detected with the antenna 1 meter from the EUT, the indicated readings are the noise floor measurements from the spectrum analyzer					

Transmitting at 922.6 MHz					
Frequency MHz	Detector	Receiver Reading dB $\mu$ V	Correction Factor dB	Corrected Reading dB $\mu$ V/m	Limit dB $\mu$ V/m
2767.8	Peak	9.7	36.7	46.4	74.0
2767.8	Average	0.8	36.7	37.5	54.0
3690.4	Peak	8.5	39.9	48.4	74.0
3690.4	Average	-0.2	39.9	39.7	54.0
4613.0	Peak	7.2	41.4	48.6	74.0
4613.0	Average	-1.5	41.4	39.9	54.0
7380.8	Peak	7.6 *	45.8	53.4	74.0
7380.8	Average	-2.4 *	45.8	43.4	54.0
8303.4	Peak	13.6 *	40.8	54.4	74.0
8303.4	Average	2.0 *	40.8	42.8	54.0
* No emissions were detected with the antenna 1 meter from the EUT, the indicated readings are the noise floor measurements from the spectrum analyzer					

**Horizontal Polarity (Large Dipole Antenna)**

Transmitting at 903.0 MHz					
Frequency MHz	Detector	Receiver Reading dB $\mu$ V	Correction Factor dB	Corrected Reading dB $\mu$ V/m	Limit dB $\mu$ V/m
2709.0	Peak	9.5	36.7	46.2	74.0
2709.0	Average	-0.5	36.7	36.2	54.0
3612.0	Peak	7.2	39.9	47.1	74.0
3612.0	Average	-1.4	39.9	38.5	54.0
4515.0	Peak	7.9	41.4	49.3	74.0
4515.0	Average	-2.2	41.4	39.2	54.0
5418.0	Peak	8.4 *	45.8	54.2	74.0
5418.0	Average	-0.2 *	45.8	45.6	54.0
8127.0	Peak	13.6 *	40.8	54.4	74.0
8127.0	Average	2.0 *	40.8	42.8	54.0
9030.0	Peak	14.3 *	41.6	55.9	74.0
9030.0	Average	3.2 *	41.6	44.8	54.0
* No emissions were detected with the antenna 1 meter from the EUT, the indicated readings are the noise floor measurements from the spectrum analyzer					

Transmitting at 913.0 MHz					
Frequency MHz	Detector	Receiver Reading dB $\mu$ V	Correction Factor dB	Corrected Reading dB $\mu$ V/m	Limit dB $\mu$ V/m
2739.0	Peak	10.6	36.7	47.3	74.0
2739.0	Average	-0.6	36.7	36.1	54.0
3652.0	Peak	7.1	39.9	47.0	74.0
3652.0	Average	-0.4	39.9	39.5	54.0
4565.0	Peak	7.6	41.4	49.0	74.0
4565.0	Average	-2.5	41.4	38.9	54.0
7304.0	Peak	7.6 *	45.8	53.4	74.0
7304.0	Average	-2.4 *	45.8	43.4	54.0
8217.0	Peak	13.6 *	40.8	54.4	74.0
8217.0	Average	2.0 *	40.8	42.8	54.0
9130.0	Peak	14.3 *	41.6	55.9	74.0
9130.0	Average	3.2 *	41.6	44.8	54.0
* No emissions were detected with the antenna 1 meter from the EUT, the indicated readings are the noise floor measurements from the spectrum analyzer					

Transmitting at 922.6 MHz					
Frequency MHz	Detector	Receiver Reading dB $\mu$ V	Correction Factor dB	Corrected Reading dB $\mu$ V/m	Limit dB $\mu$ V/m
2767.8	Peak	11.4	36.7	48.1	74.0
2767.8	Average	0.7	36.7	37.4	54.0
3690.4	Peak	7.1	39.9	47.0	74.0
3690.4	Average	-1.8	39.9	38.1	54.0
4613.0	Peak	7.8	41.4	49.2	74.0
4613.0	Average	-1.2	41.4	40.2	54.0
7380.8	Peak	7.6 *	45.8	53.4	74.0
7380.8	Average	-2.4 *	45.8	43.4	54.0
8303.4	Peak	13.6 *	40.8	54.4	74.0
8303.4	Average	2.0 *	40.8	42.8	54.0
* No emissions were detected with the antenna 1 meter from the EUT, the indicated readings are the noise floor measurements from the spectrum analyzer					

**Vertical Polarity (Comtelco Model Y2283A-66 Yagi Antenna)**

Transmitting at 903.0 MHz					
Frequency MHz	Detector	Receiver Reading dB $\mu$ V	Correction Factor dB	Corrected Reading dB $\mu$ V/m	Limit dB $\mu$ V/m
2709.0	Peak	12.1	36.7	48.8	74.0
2709.0	Average	1.3	36.7	38.0	54.0
3612.0	Peak	10.6	39.9	50.5	74.0
3612.0	Average	-2.0	39.9	37.9	54.0
4515.0	Peak	11.4	41.4	52.8	74.0
4515.0	Average	-1.0	41.4	40.4	54.0
5418.0	Peak	9.6	45.8	55.4	74.0
5418.0	Average	-0.2	45.8	45.6	54.0
8127.0	Peak	13.6 *	40.8	54.4	74.0
8127.0	Average	2.0 *	40.8	42.8	54.0
9030.0	Peak	14.3 *	41.6	55.9	74.0
9030.0	Average	3.2 *	41.6	44.8	54.0
* No emissions were detected with the antenna 1 meter from the EUT, the indicated readings are the noise floor measurements from the spectrum analyzer					

Transmitting at 913.0 MHz					
Frequency MHz	Detector	Receiver Reading dB $\mu$ V	Correction Factor dB	Corrected Reading dB $\mu$ V/m	Limit dB $\mu$ V/m
2739.0	Peak	17.6	36.7	54.3	74.0
2739.0	Average	5.4	36.7	42.1	54.0
3652.0	Peak	9.5	39.9	49.4	74.0
3652.0	Average	-1.2	39.9	38.7	54.0
4565.0	Peak	8.4	41.4	49.8	74.0
4565.0	Average	-2.5	41.4	38.9	54.0
7304.0	Peak	7.6	45.8	53.4	74.0
7304.0	Average	-2.4	45.8	43.4	54.0
8217.0	Peak	13.6 *	40.8	54.4	74.0
8217.0	Average	2.0 *	40.8	42.8	54.0
9130.0	Peak	14.3 *	41.6	55.9	74.0
9130.0	Average	3.2 *	41.6	44.8	54.0
* No emissions were detected with the antenna 1 meter from the EUT, the indicated readings are the noise floor measurements from the spectrum analyzer					

Transmitting at 922.6 MHz					
Frequency MHz	Detector	Receiver Reading dB $\mu$ V	Correction Factor dB	Corrected Reading dB $\mu$ V/m	Limit dB $\mu$ V/m
2767.8	Peak	16.4	36.7	53.1	74.0
2767.8	Average	4.1	36.7	40.8	54.0
3690.4	Peak	11.5	39.9	51.4	74.0
3690.4	Average	-0.5	39.9	39.4	54.0
4613.0	Peak	11.6	41.4	53.0	74.0
4613.0	Average	0.8	41.4	42.2	54.0
7380.8	Peak	12.4	45.8	58.2	74.0
7380.8	Average	-0.5	45.8	45.3	54.0
8303.4	Peak	13.6 *	40.8	54.4	74.0
8303.4	Average	2.0 *	40.8	42.8	54.0
* No emissions were detected with the antenna 1 meter from the EUT, the indicated readings are the noise floor measurements from the spectrum analyzer					



**Horizontal Polarity (Comtelco Model Y2283A-66 Yagi Antenna)**

Transmitting at 903.0 MHz					
Frequency MHz	Detector	Receiver Reading dB $\mu$ V	Correction Factor dB	Corrected Reading dB $\mu$ V/m	Limit dB $\mu$ V/m
2709.0	Peak	11.3	36.7	48.0	74.0
2709.0	Average	-1.0	36.7	35.7	54.0
3612.0	Peak	14.1	39.9	54.0	74.0
3612.0	Average	-1.7	39.9	38.2	54.0
4515.0	Peak	11.1	41.4	52.5	74.0
4515.0	Average	-1.2	41.4	40.2	54.0
5418.0	Peak	10.4	45.8	56.2	74.0
5418.0	Average	-1.7	45.8	44.1	54.0
8127.0	Peak	13.6 *	40.8	54.4	74.0
8127.0	Average	2.0 *	40.8	42.8	54.0
9030.0	Peak	14.3 *	41.6	55.9	74.0
9030.0	Average	3.2 *	41.6	44.8	54.0
* No emissions were detected with the antenna 1 meter from the EUT, the indicated readings are the noise floor measurements from the spectrum analyzer					

Transmitting at 913.0 MHz					
Frequency MHz	Detector	Receiver Reading dB $\mu$ V	Correction Factor dB	Corrected Reading dB $\mu$ V/m	Limit dB $\mu$ V/m
2739.0	Peak	20.5	36.7	57.2	74.0
2739.0	Average	8.4	36.7	45.1	54.0
3652.0	Peak	12.5	39.9	52.4	74.0
3652.0	Average	0.2	39.9	41.1	54.0
4565.0	Peak	10.8	41.4	52.2	74.0
4565.0	Average	-0.1	41.4	41.3	54.0
7304.0	Peak	8.4	45.8	54.2	74.0
7304.0	Average	-1.4	45.8	44.4	54.0
8217.0	Peak	13.6 *	40.8	54.4	74.0
8217.0	Average	2.0 *	40.8	42.8	54.0
9130.0	Peak	14.3 *	41.6	55.9	74.0
9130.0	Average	3.2 *	41.6	44.8	54.0
* No emissions were detected with the antenna 1 meter from the EUT, the indicated readings are the noise floor measurements from the spectrum analyzer					

Transmitting at 922.6 MHz					
Frequency MHz	Detector	Receiver Reading dB $\mu$ V	Correction Factor dB	Corrected Reading dB $\mu$ V/m	Limit dB $\mu$ V/m
2767.8	Peak	19.5	36.7	56.2	74.0
2767.8	Average	7.4	36.7	44.1	54.0
3690.4	Peak	12.7	39.9	52.6	74.0
3690.4	Average	2.4	39.9	42.3	54.0
4613.0	Peak	10.8	41.4	52.2	74.0
4613.0	Average	0.9	41.4	42.3	54.0
7380.8	Peak	12.6	45.8	58.4	74.0
7380.8	Average	0.4	45.8	46.2	54.0
8303.4	Peak	13.6 *	40.8	54.4	74.0
8303.4	Average	2.0 *	40.8	42.8	54.0
* No emissions were detected with the antenna 1 meter from the EUT, the indicated readings are the noise floor measurements from the spectrum analyzer					

**Vertical Polarity (Maxrad Model MFB9155 Omni Antenna)**

Transmitting at 903.0 MHz					
Frequency MHz	Detector	Receiver Reading dB $\mu$ V	Correction Factor dB	Corrected Reading dB $\mu$ V/m	Limit dB $\mu$ V/m
2709.0	Peak	10.2	36.7	46.9	74.0
2709.0	Average	1.1	36.7	37.8	54.0
3612.0	Peak	13.4	39.9	53.3	74.0
3612.0	Average	0.5	39.9	40.4	54.0
4515.0	Peak	9.5	41.4	50.9	74.0
4515.0	Average	-1.9	41.4	39.5	54.0
5418.0	Peak	11.1	45.8	56.9	74.0
5418.0	Average	-0.6	45.8	45.2	54.0
8127.0	Peak	13.6 *	40.8	54.4	74.0
8127.0	Average	2.0 *	40.8	42.8	54.0
9030.0	Peak	14.3 *	41.6	55.9	74.0
9030.0	Average	3.2 *	41.6	44.8	54.0
* No emissions were detected with the antenna 1 meter from the EUT, the indicated readings are the noise floor measurements from the spectrum analyzer					

Transmitting at 913.0 MHz					
Frequency MHz	Detector	Receiver Reading dB $\mu$ V	Correction Factor dB	Corrected Reading dB $\mu$ V/m	Limit dB $\mu$ V/m
2739.0	Peak	24.9	36.7	61.6	74.0
2739.0	Average	9.8	36.7	46.5	54.0
3652.0	Peak	11.3	39.9	51.2	74.0
3652.0	Average	-1.2	39.9	38.7	54.0
4565.0	Peak	11.7	41.4	53.1	74.0
4565.0	Average	-1.1	41.4	40.3	54.0
7304.0	Peak	10.9	45.8	56.7	74.0
7304.0	Average	-1.4	45.8	44.4	54.0
8217.0	Peak	13.6 *	40.8	54.4	74.0
8217.0	Average	2.0 *	40.8	42.8	54.0
9130.0	Peak	14.3 *	41.6	55.9	74.0
9130.0	Average	3.2 *	41.6	44.8	54.0
* No emissions were detected with the antenna 1 meter from the EUT, the indicated readings are the noise floor measurements from the spectrum analyzer					

Transmitting at 922.6 MHz					
Frequency MHz	Detector	Receiver Reading dB $\mu$ V	Correction Factor dB	Corrected Reading dB $\mu$ V/m	Limit dB $\mu$ V/m
2767.8	Peak	18.6	36.7	55.3	74.0
2767.8	Average	5.4	36.7	42.1	54.0
3690.4	Peak	13.7	39.9	53.6	74.0
3690.4	Average	1.0	39.9	40.9	54.0
4613.0	Peak	12.5	41.4	53.9	74.0
4613.0	Average	-0.8	41.4	40.6	54.0
7380.8	Peak	15.2	45.8	61.0	74.0
7380.8	Average	2.2	45.8	48.0	54.0
8303.4	Peak	13.6 *	40.8	54.4	74.0
8303.4	Average	2.0 *	40.8	42.8	54.0
* No emissions were detected with the antenna 1 meter from the EUT, the indicated readings are the noise floor measurements from the spectrum analyzer					

**Horizontal Polarity (Maxrad Model MFB9155 Omni Antenna)**

Transmitting at 903.0 MHz					
Frequency MHz	Detector	Receiver Reading dB $\mu$ V	Correction Factor dB	Corrected Reading dB $\mu$ V/m	Limit dB $\mu$ V/m
2709.0	Peak	10.8	36.7	47.5	74.0
2709.0	Average	-0.9	36.7	35.8	54.0
3612.0	Peak	14.0	39.9	53.9	74.0
3612.0	Average	-1.5	39.9	38.4	54.0
4515.0	Peak	11.2	41.4	52.6	74.0
4515.0	Average	-0.9	41.4	40.5	54.0
5418.0	Peak	10.4	45.8	56.2	74.0
5418.0	Average	-1.3	45.8	44.5	54.0
8127.0	Peak	13.6 *	40.8	54.4	74.0
8127.0	Average	2.0 *	40.8	42.8	54.0
9030.0	Peak	14.3 *	41.6	55.9	74.0
9030.0	Average	3.2 *	41.6	44.8	54.0
* No emissions were detected with the antenna 1 meter from the EUT, the indicated readings are the noise floor measurements from the spectrum analyzer					

Transmitting at 913.0 MHz					
Frequency MHz	Detector	Receiver Reading dB $\mu$ V	Correction Factor dB	Corrected Reading dB $\mu$ V/m	Limit dB $\mu$ V/m
2739.0	Peak	11.5	36.7	48.2	74.0
2739.0	Average	-0.9	36.7	35.8	54.0
3652.0	Peak	14.2	39.9	54.1	74.0
3652.0	Average	8.0	39.9	47.9	54.0
4565.0	Peak	11.1	41.4	52.5	74.0
4565.0	Average	-1.2	41.4	40.2	54.0
7304.0	Peak	10.8	45.8	56.6	74.0
7304.0	Average	-1.5	45.8	44.3	54.0
8217.0	Peak	13.6 *	40.8	54.4	74.0
8217.0	Average	2.0 *	40.8	42.8	54.0
9130.0	Peak	14.3 *	41.6	55.9	74.0
9130.0	Average	3.2 *	41.6	44.8	54.0
* No emissions were detected with the antenna 1 meter from the EUT, the indicated readings are the noise floor measurements from the spectrum analyzer					



Transmitting at 922.6 MHz					
Frequency MHz	Detector	Receiver Reading dB $\mu$ V	Correction Factor dB	Corrected Reading dB $\mu$ V/m	Limit dB $\mu$ V/m
2767.8	Peak	10.8	36.7	47.5	74.0
2767.8	Average	-1.0	36.7	35.7	54.0
3690.4	Peak	13.8	39.9	53.7	74.0
3690.4	Average	7.6	39.9	47.5	54.0
4613.0	Peak	11.0	41.4	52.4	74.0
4613.0	Average	-0.9	41.4	40.5	54.0
7380.8	Peak	9.5	45.8	55.3	74.0
7380.8	Average	2.1	45.8	47.9	54.0
8303.4	Peak	13.6 *	40.8	54.4	74.0
8303.4	Average	2.0 *	40.8	42.8	54.0
* No emissions were detected with the antenna 1 meter from the EUT, the indicated readings are the noise floor measurements from the spectrum analyzer					

**Sample Field Strength Calculation:**

The field strength is calculated by adding the Correction Factor (Antenna Factor + Cable Factor), to the measured level from the receiver. The basic equation with a sample calculation is shown below:

FS = RA + CF - AF Where

FS = Field Strength

RA = Receiver Amplitude (Receiver Reading - Amplifier Gain)

CF = Correction Factor (Antenna Factor + Cable Factor)

AF = Average Factor

**RESULT**

In the configuration tested, the EUT complied with the requirements of the specification.

**6.2.5 § 15.207 Conducted Limits**

The frequency range from 450 kHz to 30 MHz was investigated to measure any AC line conducted emissions.

A diagram of the test configuration is enclosed in Appendix A and a list of reference codes for test equipment used is enclosed in Appendix B.

Test equipment used: 1, 3, 4 and 13.

**Line Conducted Data - (Hot Lead)**

Frequency MHz	Detector	Measured Level dB $\mu$ V	Limit dB $\mu$ V
0.68	Peak	43.2	48.0
0.87	Peak	38.4	48.0
0.97	Peak	41.6	48.0
4.70	Peak	36.5	48.0
12.25	Peak	38.3	48.0
15.00	Peak	35.8	48.0
15.77	Peak	34.0	48.0
15.98	Peak	33.8	48.0
16.64	Peak	32.5	48.0

**Line Conducted Data - (Neutral Lead)**

Frequency MHz	Detector	Measured Level dB $\mu$ V	Limit dB $\mu$ V
0.68	Peak	43.4	48.0
0.97	Peak	39.4	48.0
1.26	Peak	30.3	48.0
1.56	Peak	29.7	48.0
15.56	Peak	22.7	48.0
19.08	Peak	21.5	48.0
24.06	Peak	24.3	48.0
26.22	Peak	26.6	48.0

**RESULT**

In the configuration tested, the EUT complied with the requirements of the specification.

**APPENDIX A TEST EQUIPMENT USED:**

Reference No.	Type	Manufacturer	Model
1	Anechoic Chamber	EMC Test Systems	N/A
2	Wanship Open Area Test Site	CCL	N/A
3	Spectrum Analyzer	Hewlett Packard	8568B or 8566B
4	Quasi-Peak Detector	Hewlett Packard	8565A
5	Biconical Antenna	EMCO	3108 or 3104P
6	Log-Periodic Antenna	EMCO	3146
7	Biconilog Antenna	EMCO	3142
8	Double Ridged Guide Antenna	EMCO	3115
9	Pre-Amplifier	Hewlett Packard	8447D
10	Power Amplifier	Hewlett Packard	8447E
11	Power Amplifier	Hewlett Packard	8449A
12	Power Amplifier	Hewlett Packard	8449B
13	LISN Anechoic Chamber	EMCO	3825/2
14	LISN Wanship	EMCO	3725

An independent calibration laboratory following outlined calibration procedures calibrates all the equipment listed above every 12 months.

**APPENDIX B TEST PROCEDURES:****Line Conducted Emissions:**

The line-conducted emission from the digital apparatus was measured using a spectrum analyzer with a quasi-peak adapter for peak, quasi-peak and average readings. The quasi-peak adapter uses a bandwidth of 9 kHz, with the spectrum analyzer's resolution bandwidth set at 100 kHz, for readings in the 450 kHz to 30 MHz frequency ranges.

The line conducted emissions measurements are performed in a screen room using a (50  $\Omega$ /50  $\mu$ H) Line Impedance Stabilization Network (LISN).

Where mains flexible power cords are longer than 1 m, the excess cable is folded back and forth as far as possible so as to form a bundle not exceeding 0.4 m in length.

Where the EUT is a collection of digital apparatus with each digital apparatus having its own power cord, the point of connection for the LISN is determined from the following rules:

- a) Each power cord, which is terminated in a mains supply plug, shall be tested separately.
- b) Power cords, which are not specified by the manufacturer to be connected via a host unit, shall be tested separately.
- c) Power cords which are specified by the manufacturer to be connected via a host unit or other power supplying equipment shall be connected to that host unit and the power cords of that host unit connected to the LISN and tested.

Desktop digital apparatus are placed on a non-conducting table at least 80 cm from the metallic floor. The equipment is placed a minimum of 40 cm from all walls. Floor standing equipment is placed directly on the earth grounded floor.

## Line Conducted Emissions Test

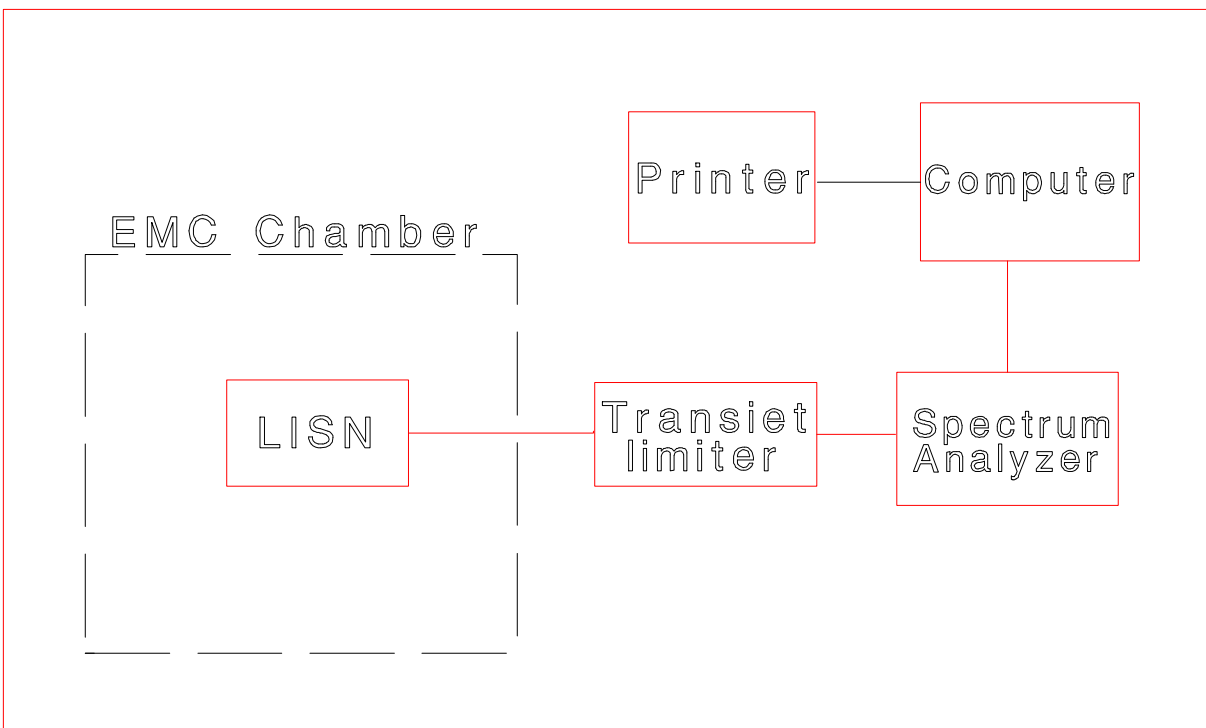

### **Radiated Spurious Emissions:**

The radiated emission from the transmitter was measured using a spectrum analyzer with a quasi-peak adapter for peak and quasi-peak readings. A preamplifier with a fixed gain of 30 dB was used to increase the sensitivity of the measuring instrumentation.

A Biconilog antenna was used to measure the frequency range of 30 to 1000 MHz and a Double Ridge Guide Horn antenna was used to measure the frequency range 1 GHz to 10 GHz, at a distance of 3 meters from the EUT. The readings obtained by these antennas are correlated to the levels obtained with a tuned dipole antenna by adding antenna factors.

The configuration of the transmitter was varied to find the maximum radiated emission. The EUT was connected to the peripherals listed in Section 2.4 via the interconnecting cables listed in Section 2.5. These interconnecting cables were manipulated manually by a technician to obtain worst case radiated emissions. The digital apparatus was rotated 360

degrees, and the antenna height was varied from 1 to 4 meters to find the maximum radiated emission. Where there were multiple interface ports all of the same type, cables are either placed on all of the ports or cables added to these ports until the emissions do not increase by more than 2 dB.

Transmitters are measured on a non-conducting table one-meter above the ground plane. The table is placed on a turntable which is level with the ground plane. The turntable has slip rings, which supply AC power to the digital apparatus. For equipment normally placed on floors, the equipment shall be placed directly on the turntable.

### R a d i a t e d   E m i s s i o n s   T e s t

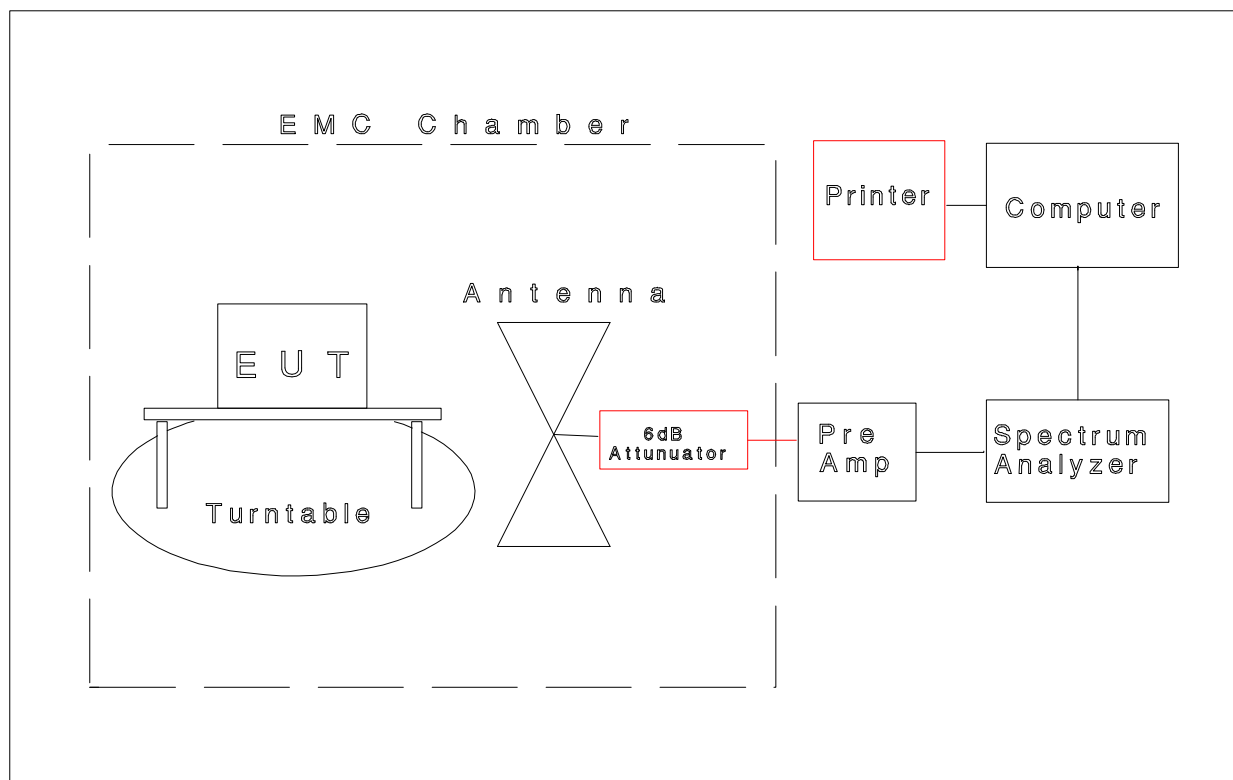

**FCC Sections 15.247 Peak Transmit Power, Emission Bandwidth and Spurious Emissions (antenna conducted)**

The EUT was directly connected to the spectrum analyzer via the antenna output port as shown in the block diagram below.

The measurements were performed on three channels, as per 47 CFR 15.31(m), one near the bottom of the spectrum, one near the middle of the spectrum and one near the top of the spectrum.

The spectrum analyzer's resolution bandwidth and video bandwidth were set as follows:

**Peak Transmit Power**

RBW = 100 kHz  
VBW = 300 kHz

**Emission Bandwidth**

RBW = 3 kHz  
VBW = 10 kHz

**Spurious Emissions (Antenna Conducted)**

RBW = 100 kHz - 30 MHz to 1000 MHz  
VBW = 300 kHz

RBW = 1 MHz - 1 GHz to 10 GHz  
VBW = 3 MHz

**Test Configuration Block Diagram**