

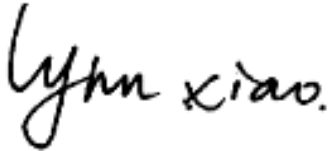



TEST REPORT

Report No.:	EM201301038-4	Application No.:	ZJ00038221
Applicant:	Pace Micro Technology plc		
Applicant Address:	Saltaire, Shipley, West Yorkshire, BD18 3LF, UK		
Sample Description:	EPON ONU		
Model:	ONT-2-E4021iWn		
Adding Model:	/		
FCC ID:	NQ8-ONT2E4021IWN		
Test Specification:	FCC Part 15, Subpart C (Section 15.247)		
Test Date:	2013-12-10 to 2013-12-23		
Issue Date:	2013-12-24		
Test Result:	PASS		
Prepared By:	Reviewed By:	Approved By:	
Lynn Xiao / Test Engineer	Jane Cao / Technical Assistance	Gavin Wu / Manager	
			
Other Aspects:			
/			
Abbreviations: ok / P = passed; fail / F = failed; n.a. / N = not applicable			
The test result in this test report refers exclusively to the presented test sample. This report shall not be reproduced except in full, without the written approval of GRGT.			

DIRECTIONS OF TEST

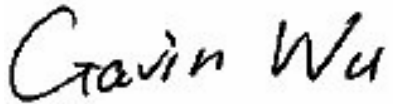
1. This station carries out test task according to the national regulation of verifications which can be traced to National Primary Standards and BIPM.
2. The test report merely corresponds to the test sample. It is not permitted to copy extracts of these test result without the written permission of the test laboratory.
3. If there is any objection concerning the test, the client should inform the laboratory within 15 days from the date of receiving the test report.

Table of Contents

TABLE OF CONTENTS	3
1. TEST RESULT SUMMARY	5
2. GENERAL DESCRIPTION OF EUT	6
2.1 APPLICANT	6
2.2 MANUFACTURER	6
2.3 BASIC DESCRIPTION OF EQUIPMENT UNDER TEST	6
3. LABORATORY AND ACCREDITATIONS.....	7
3.1 LABORATORY	7
3.2 ACCREDITATIONS	7
3.3 MEASUREMENT UNCERTAINTY	7
3.4 LIST OF USED TEST EQUIPMENT AT GRGT	8
4. ANTENNA REQUIREMENT	9
5. CONDUCTED EMISSION MEASUREMENT	9
5.1 LIMITS	10
5.2 TEST PROCEDURES	10
5.3 TEST SETUP	11
5.4 TEST RESULTS.....	12
6. RADIATED ELECTROMAGNETIC DISTURBANCE	14
6.1 LIMITS	14
6.2 TEST PROCEDURES	14
6.3 TEST SETUP	15
6.4 TEST RESULTS.....	17
7. 6DB BANDWIDTH TESTING.....	53
7.1 LIMITS	53
7.2 TEST PROCEDURES	53
7.3 TEST SETUP	53
7.4 TEST RESULTS.....	53
8. MAXIMUM PEAK OUTPUT POWER.....	62
8.1 LIMITS	62
8.2 TEST PROCEDURES	62
8.3 TEST SETUP	62
8.4 TEST RESULTS.....	62
9. POWER SPECTRAL DENSITY	72
9.1 LIMITS	72
9.2 TEST PROCEDURES	72
9.3 TEST SETUP	72
9.4 TEST RESULTS.....	73
10. EMISSIONS IN NON-RESTRICTED FREQUENCY BANDS	85
10.1 LIMITS	85
10.2 TEST PROCEDURES	85
10.3 TEST SETUP	85
10.4 TEST RESULTS.....	85
11. EMISSIONS IN RESTRICTED FREQUENCY BANDS	110
11.1 LIMITS	110
11.2 TEST PROCEDURES	110
11.3 TEST SETUP	111
11.4 TEST RESULTS.....	112
12. BAND-EDGE MEASUREMENTS	144
12.1 LIMITS	144

12.2 TEST PROCEDURES 144
12.3 TEST SETUP..... 144
12.4 TEST RESULTS..... 144
APPENDIX A: PHOTOGRAPH OF THE TEST ARRANGEMENT.....153
APPENDIX B: PHOTOGRAPH OF THE EUT.....155

1. TEST RESULT SUMMARY

FCC Part 15.247:2012			
Standard	Item	Limit / Severity	Result
FCC Part 15,Subpart C (15.247)	Antenna Requirement	§15.203	PASS
	Conducted Emissions	§15.207 (a)	PASS
	Radiated Electromagnetic Disturbance	§15.247(d)	PASS
	6 dB Bandwidth	§15.247 (a)(2)	PASS
	Maximum Peak Output Power	§15.247(b)(3)	PASS
	Power Spectral Density	§15.247(e)	PASS
	Emissions In Non-Rest ricted Frequency Bands	§15.247(d)	PASS
	Emissions In Restricted Frequency Bands	§15.205	PASS
	Band-Edge Measurements	§15.247(d)	PASS

2. GENERAL DESCRIPTION OF EUT

2.1 APPLICANT

Name: Pace Micro Technology plc
Address: Saltaire, Shipley, West Yorkshire, BD18 3LF, UK

2.2 MANUFACTURER

Name: Pace Micro Technology plc
Address: Saltaire, Shipley, West Yorkshire, BD18 3LF, UK

2.3 BASIC DESCRIPTION OF EQUIPMENT UNDER TEST

Equipment: EPON ONU
Model No.: ONT-2-E4021iWn
Adding Model /
Trade Name: Aurora
Power Supply: 100-240V~50/60Hz
AC adapter: S24B12-120A150-04
Input :100-240V~50/60Hz MAX 0.7A
Output: 12V 1.5A
Operating Frequency Range: 2412MHz~2462MHz: 802.11b; 802.11g; 802.11n(HT20)
2422MHz~2452 MHz: 802.11n(HT40)
Antenna gain: 5dBi
Type of emission: WIFI
Modulation type: DSSS (802.11b) OFDM (802.11g/n20/n40)
Note: Pre-test for antenna 0 and antenna 1 on 802.11b/g mode, to find antenna 0 is the worst case, so only record antenna 0 test data.

3. LABORATORY AND ACCREDITATIONS

3.1 LABORATORY

The tests and measurements refer to this report were performed by Guangzhou GRG Metrology and Test CO., LTD.

Add. : 163 Pingyun Rd, West of Huangpu Ave, Guangzhou, 510656, P. R. China

Telephone: +86-20-38699959, 38699960, 38699961

Fax : +86-20-38695185

3.2 ACCREDITATIONS

Our laboratories are accredited and approved by the following approval agencies according to ISO/IEC 17025.

USA	FCC Listed Lab (No. 688188)
China	CNAS (No.L0446)
China	DILAC (No.DL175)
Canada	Registration No.:8355A-1

3.3 MEASUREMENT UNCERTAINTY

Where relevant, the following measurement uncertainty levels have been estimated for tests performed on the EUT as specified in CISPR 16-4-2:

Measurement		Frequency	Uncertainty
Radiated Emission		9kHz~30MHz	3.9dB
Radiated Emission	Horizontal	30MHz~1000MHz	4.2dB
		1GHz~26.5GHz	4.2dB
	Vertical	30MHz~1000MHz	4.4dB
		1GHz~26.5GHz	4.4dB
Conducted Emission		150kHz~30MHz	3.1 dB

This uncertainty represents an expanded uncertainty factor of k=2 and the Confidence Level is 95%.

3.4 LIST OF USED TEST EQUIPMENT AT GRGT

Name of Equipment	Manufacturer	Model	Serial Number	Calibration Due
Conducted Emissions				
EMI Receiver	R&S	ESU40	100529	2014-01-24
L.I.S.N	SCHWARZBECK	NSLK 8127	8127450	2014-08-05
Spurious Emissions at Antenna Port				
Receiver	R&S	ESU40	100106	2014-01-24
Radiated Spurious Emissions				
Receiver	R&S	ESU40	100106	2014-01-24
Loop antenna	R&S	HFH2-Z2	881058/58	2014-05-26
Biconical Log-periodic Antenna	ETS.LINDGREN	3142C	00075971	2014-05-26
Horn antenna	SCHWARZBECK	BBHA9120D	D752	2014-10-14
Horn antenna	SCHWARZBECK	BBHA 9170	411	2014-11-21
Pre-amplifier	SCHWARZBECK	9742	332	2014-11-25
Pre-amplifier	Decentest	DC7110EM A	001	2014-10-10
Restricted Bands				
Receiver	R&S	ESU40	100106	2014-01-24
Horn antenna	SCHWARZBECK	BBHA9120 D	D752	2014-10-14
Pre-amplifier	SCHWARZBECK	9742	332	2014-11-25
6 dB Bandwidth				
Receiver	R&S	ESU40	100106	2014-01-24
Maximum Peak Output Power				
Receiver	R&S	ESU40	100106	2014-01-24
100kHz Bandwidth of Frequency Band Edge				
Receiver	R&S	ESU40	100106	2014-01-24
Power Spectral Density				
Receiver	R&S	ESU40	100106	2014-01-24

4. ANTENNA REQUIREMENT

The EUT has two antennas. The antennas are exposed antenna.

The gain of antennas is 5dBi .which accordance 15.203 is considered sufficient to comply with the provisions of this section.

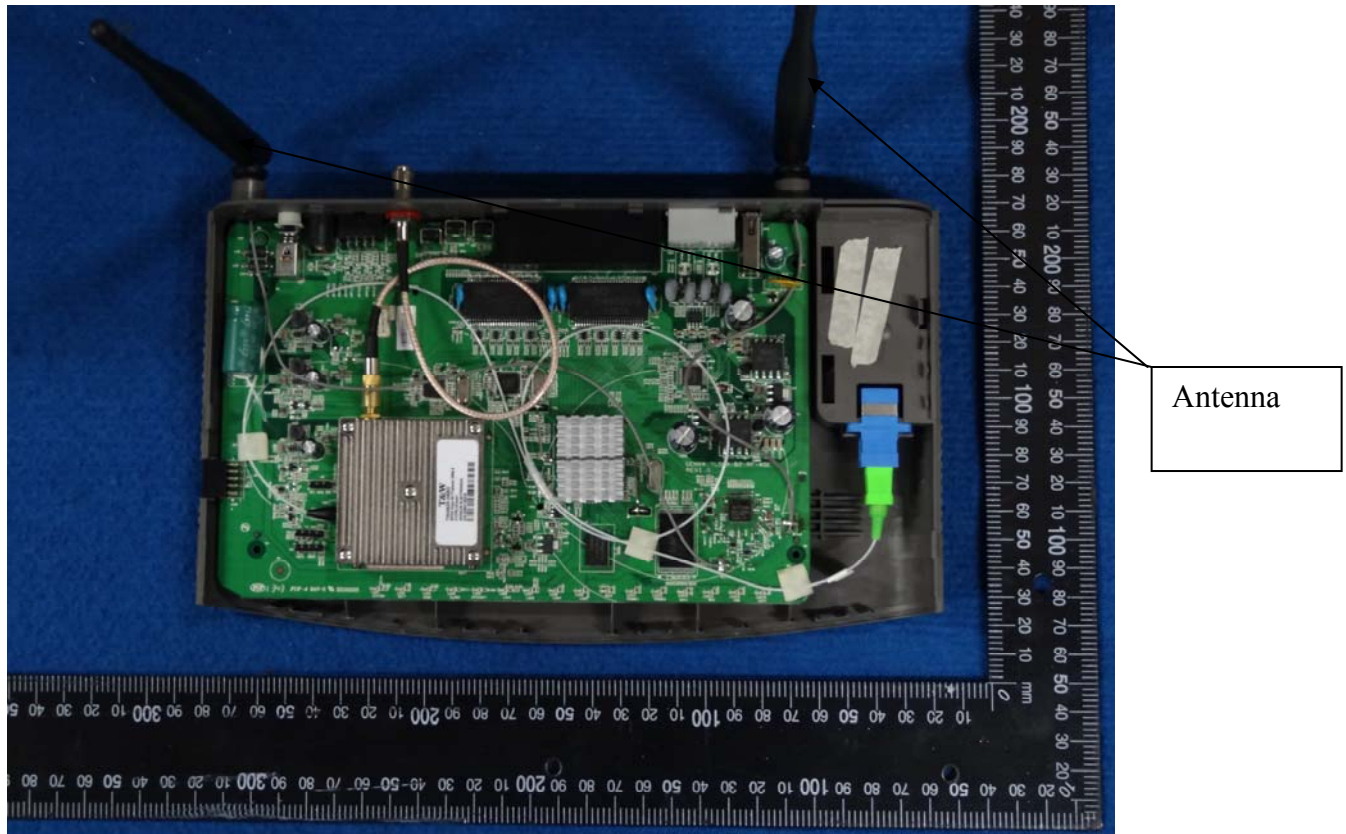

5. CONDUCTED EMISSION MEASUREMENT

5.1 LIMITS

Frequency range	Limits (dB μ V)	
	Quasi-peak	Average
150kHz ~ 0.5MHz	66~56	56~46
0.5 MHz ~ 5 MHz	56	46
5 MHz ~ 30 MHz	60	50

NOTE: (1) The lower limit shall apply at the transition frequencies.

(2) The limit decreases in line with the logarithm of the frequency in the range of 150 kHz to 0.5MHz.

5.2 TEST PROCEDURES

Procedure of Preliminary Test

Test procedures follow ANSI C63.4:2009.

For measurement of the disturbance voltage the equipment under test (EUT) is connected to the power supply mains and any other extended network via one or more artificial network(s). An EUT, whether intended to be grounded or not, and which is to be used on a table is configured as follows:

- Either the bottom or the rear of the EUT shall be at a controlled distance of 40 cm from a reference ground plane. This ground plane is normally the wall or floor of a shielded room. It may also be a grounded metal plane of at least 2 m by 2 m. This is physically accomplished as follows:

- 1) place the EUT on a table of non-conducting material which is at least 80 cm high. Place the EUT so that it is 40 cm from the wall of the shielded room, or

- 2) place the EUT on a table of non-conducting material which is 40 cm high so that the bottom of the EUT is 40 cm above the ground plane;

- All other conductive surfaces of the EUT shall be at least 80 cm from the reference ground plane;

- The EUT are placed on the floor that one side of the housings is 40 cm from the vertical reference ground plane and other metallic parts;

- Interconnecting cables that hang closer than 40 cm to the ground plane shall be folded back and forth forming a bundle 30 cm to 40 cm long, hanging approximately in the middle between the ground plane and the table.

- I/O cables that are connected to a peripheral shall be bundled in the centre. The end of the cable may be terminated if required using correct terminating impedance. The total length shall not exceed 1 m.

The test mode(s) described in Item 2.4 were scanned during the preliminary test. After the preliminary scan, we found the test mode described in Item 2.4 producing the highest emission level. The EUT configuration and cable configuration of the above highest emission levels were recorded for reference of the final test.

Procedure of Final Test

EUT and support equipment were set up on the test bench as per the configuration with highest emission level in the preliminary test. A scan was taken on both power lines, recording at least the six highest emissions. Emission frequency and amplitude were recorded into a computer in which correction factors were used to calculate the emission level and compare reading to the applicable limit. The test data of the worst-case condition(s) was recorded.

5.3 TEST SETUP

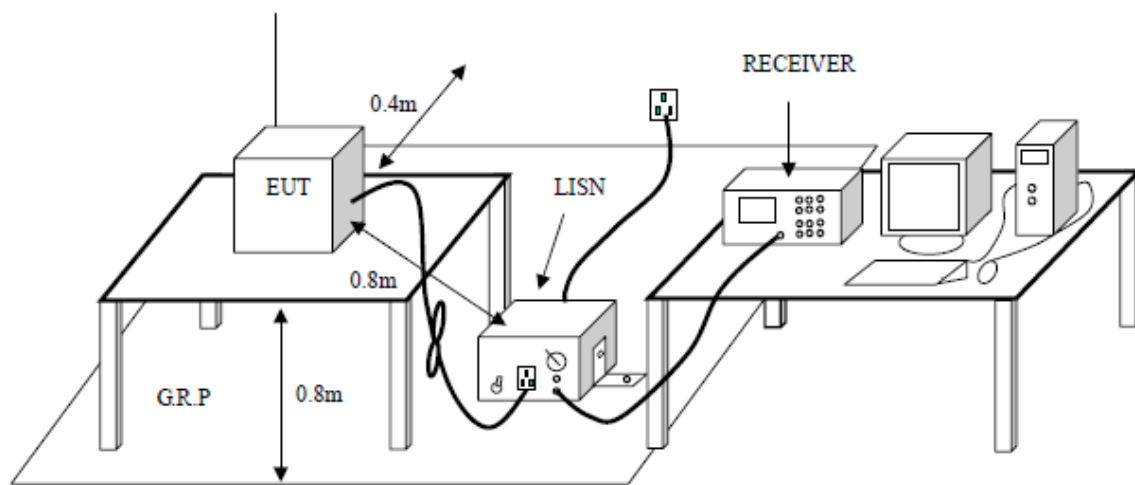

5.4 TEST RESULTS

Project No.:	ZJ00038221	Probe:	L1
Standard:	(CE)FCC PART 15 class B_QP	Power Source:	AC 120V/60Hz
Test item:	Conduction Test	Date:	2013-12-12
Temp./Hum.(%RH):	23/57%RH	Time:	11:36:05
EUT:	EPON ONU	Test Result:	Pass
Model:	ONT-2-E402iWn		
Note:			

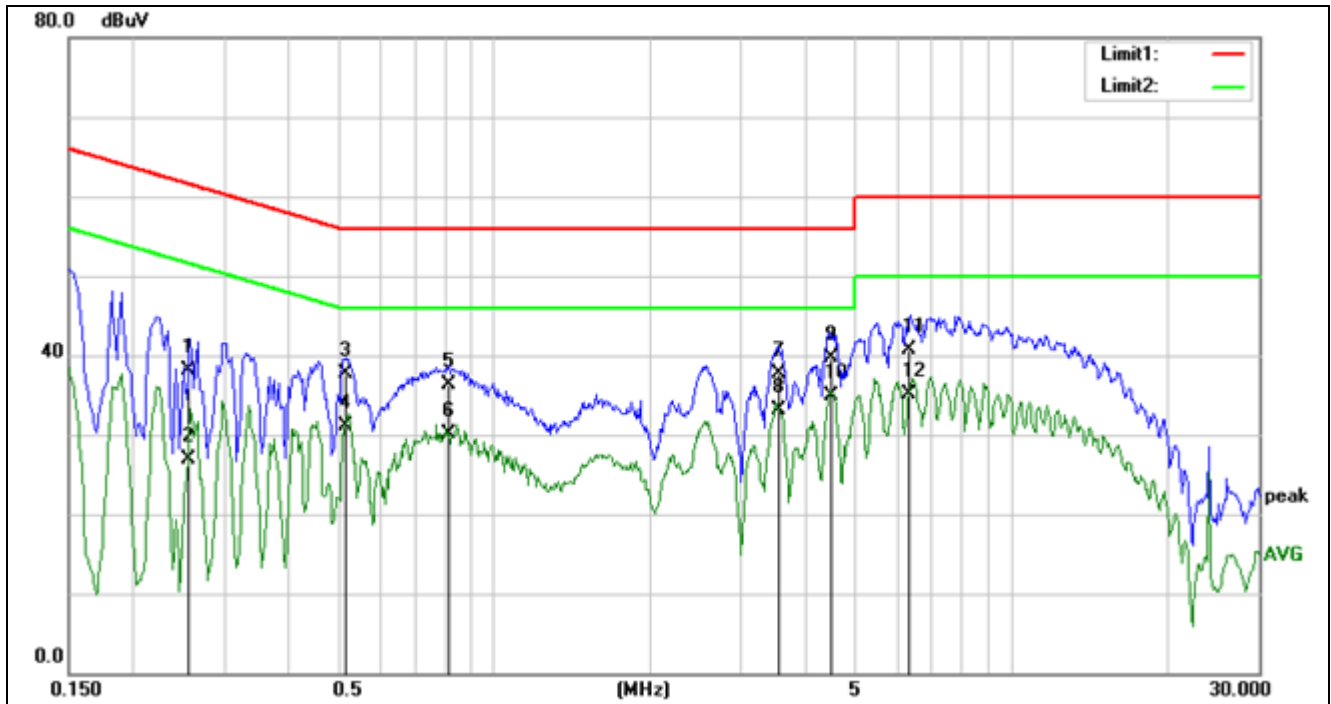

No.	Frequency (MHz)	Reading (dBuV)	Correct Factor(dB)	Result (dBuV)	Limit (dBuV)	Margin (dB)	Remark
1	0.2556	31.68	6.50	38.18	61.57	-23.39	QP
2	0.2556	20.32	6.50	26.82	51.57	-24.75	AVG
3	0.5178	31.22	6.52	37.74	56.00	-18.26	QP
4	0.5178	24.54	6.52	31.06	46.00	-14.94	AVG
5	0.8133	29.83	6.47	36.30	56.00	-19.70	QP
6	0.8133	23.66	6.47	30.13	46.00	-15.87	AVG
7	3.5463	31.13	6.61	37.74	56.00	-18.26	QP
8	3.5463	26.40	6.61	33.01	46.00	-12.99	AVG
9	4.4689	32.97	6.71	39.68	56.00	-16.32	QP
10	4.4689	28.24	6.71	34.95	46.00	-11.05	AVG
11	6.3368	34.04	6.75	40.79	60.00	-19.21	QP
12	6.3368	28.39	6.75	35.14	50.00	-14.86	AVG

Project No.:	ZJ00038221	Probe:	N
Standard:	(CE)FCC PART 15 class B_QP	Power Source:	AC 120V/60Hz
Test item:	Conduction Test	Date:	2013-12-12
Temp./Hum.(%RH):	23/57%RH	Time:	11:40:31
EUT:	EPON ONU	Test Result:	Pass
Model:	ONT-2-E402iWn		
Note:			

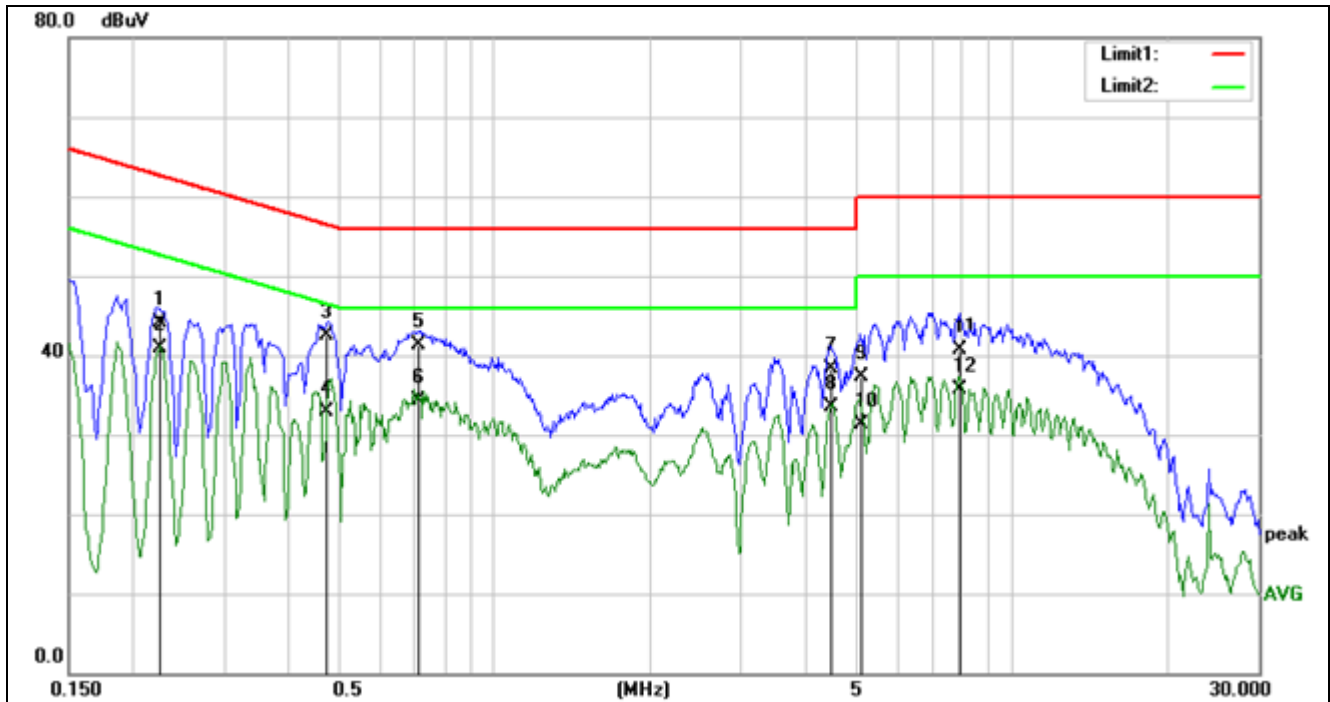

No.	Frequency (MHz)	Reading (dBuV)	Correct Factor(dB)	Result (dBuV)	Limit (dBuV)	Margin (dB)	Remark
1	0.2259	37.66	6.42	44.08	62.60	-18.52	QP
2	0.2259	34.54	6.42	40.96	52.60	-11.64	AVG
3	0.4740	35.89	6.52	42.41	56.44	-14.03	QP
4	0.4740	26.45	6.52	32.97	46.44	-13.47	AVG
5	0.7132	34.76	6.47	41.23	56.00	-14.77	QP
6	0.7132	27.74	6.47	34.21	46.00	-11.79	AVG
7	4.4849	31.62	6.71	38.33	56.00	-17.67	QP
8	4.4849	26.81	6.71	33.52	46.00	-12.48	AVG
9	5.1428	30.46	6.79	37.25	60.00	-22.75	QP
10	5.1428	24.51	6.79	31.30	50.00	-18.70	AVG
11	7.9142	33.96	6.83	40.79	60.00	-19.21	QP
12	7.9142	28.79	6.83	35.62	50.00	-14.38	AVG

6. RADIATED ELECTROMAGNETIC DISTURBANCE

6.1 LIMITS

Frequency (MHz)	Quasi-peak(μ V/m)	Measurement distance(m)	Quasi-peak(dB μ V/m)@distance 3m
0.009-0.490	2400/F(kHz)	300	53.8~88.5
0.490-1.705	24000/F(kHz)	30	43~53.8
1.705-30.0	30	30	49.5
30 ~ 88	100	3	40
88~216	150	3	43.5
216 ~ 960	200	3	46
Above 960	500	3	54

NOTE: (1) The lower limit shall apply at the transition frequencies.

Frequency (GHz)	Quasi-peak(dB μ V/m)
1 ~ 26.5	74
1~ 26.5	54

6.2 TEST PROCEDURES

Test procedures follow ANSI C63.4:2009.

Procedure of Preliminary Test

Radiated emission tests shall be made with the receive or transmit antenna located at a horizontal distance of 3 m plus half of the maximum width of the EUT being tested, measured from the centre of the EUT. The tests shall be performed with the equipment configured as closely as possible to its typical, practical operation. Unless stated otherwise, cables and wiring shall be as specified by the manufacturer and the equipment shall be in its housing (or cabinet) with all covers and access panels in place. Any deviation from normal EUT operating conditions shall be included in the test report.

The EUT (on a non-conductive support structure, where applicable) shall be placed on a remotely operated turntable, to allow the EUT to be rotated. The height of the EUT above the ground plane shall be according to the following requirements.

- Table-top equipment is placed on a non-conductive set-up table with height 0,8 m \pm 0,01 m, ANSI C63.4 specifies the method to determine the impact of the non-conductive set-up table on test results.
- Floor-standing equipment is placed on a non-conductive support, as specified in the applicable product standard. If there are no EUT height placement requirements in the product standard, the EUT shall be placed on a non-conductive support at a height of 5 cm to 15 cm above the ground plane.

Interface cables, loads, and devices should be connected to at least one of each type of the interface ports of the EUT and, where practical, each cable shall be terminated in a device typical for its actual use. Where there are multiple interface ports of the same type, a typical number of these devices shall be connected to devices or loads. It is sufficient to connect only one of the loads, provided that it can be shown, for example by preliminary testing, that the connection of further ports would not significantly increase the level of disturbance (that is, more than 2 dB) or significantly degrade the immunity level.

The test mode(s) described in Item 2.4 were scanned during the preliminary test. After the preliminary scan, we found the test mode described in Item 2.4 producing the highest emission level. The EUT and cable configuration, antenna position, polarization and turntable position of the above highest emission level were recorded for the final test.

Procedure of Final Test

EUT and support equipment were set up on the turntable as per the configuration with highest emission level in the preliminary test. The Analyzer / Receiver scanned from 30MHz to 1000MHz. Emissions were scanned and measured rotating the EUT to 360 degrees, varying cable placement and positioning the antenna 1 to 4 meters above the ground plane, in both the vertical and the horizontal polarization, to maximize the emission reading level. Record at least six highest emissions. Emission frequency, amplitude, antenna position, polarization and turntable position were recorded into a computer in which correction factors were used to calculate the emission level and compare reading to the applicable limit and only QP reading is presented. The test data of the worst-case condition(s) was recorded.

Procedure of Final Test

EUT and support equipment were set up on the test bench as per the configuration with highest emission level in the preliminary test. A scan was taken on both power lines, recording at least the six highest emissions. Emission frequency and amplitude were recorded into a computer in which correction factors were used to calculate the emission level and compare reading to the applicable limit. The test data of the worst-case condition(s) was recorded.

Below 1GHz Set the spectrum analyzer: RBW =100KHz VBW \geq RBW , Span = enough to catch the trace. Sweep = auto; Detector Function = Peak. Trace = Max,hold.

Above 1GHz Set the spectrum analyzer: RBW =1MHz VBW \geq RBW , Span = enough to catch the trace. Sweep = auto; Detector Function = Peak. Trace = Max,hold.

6.3 TEST SETUP

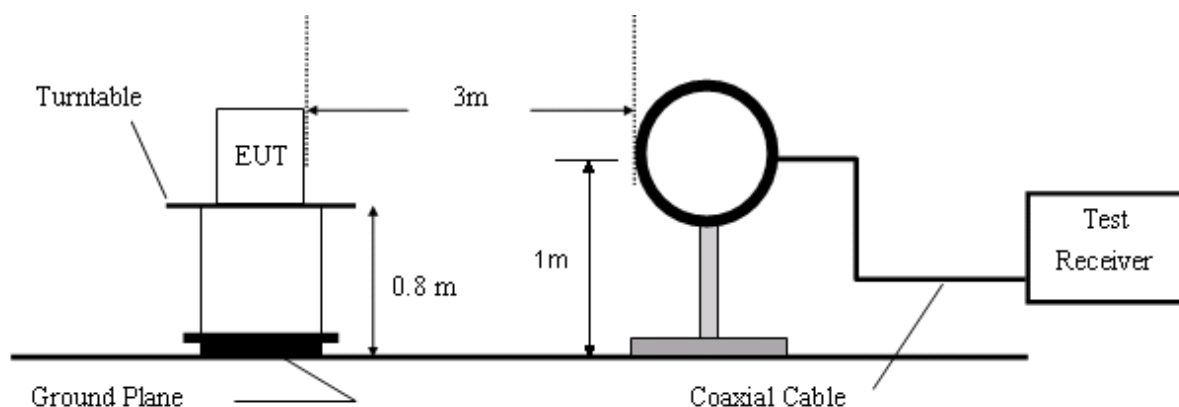

Figure 1. 9KHz to 30MHz radiated emissions test configuration

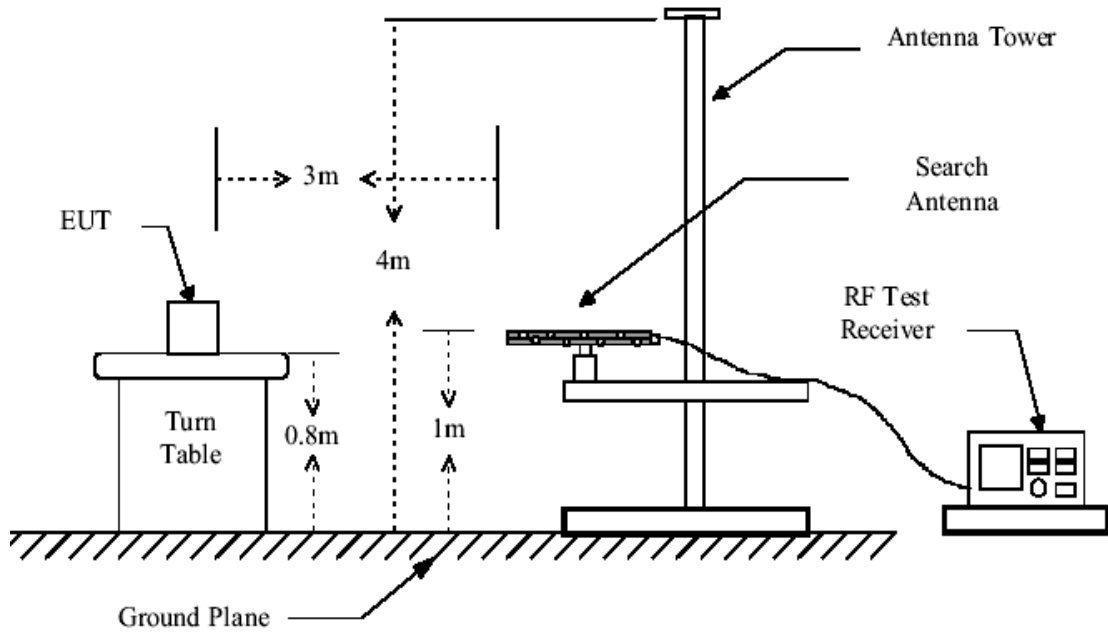

Figure 2. 30MHz to 1GHz radiated emissions test configuration

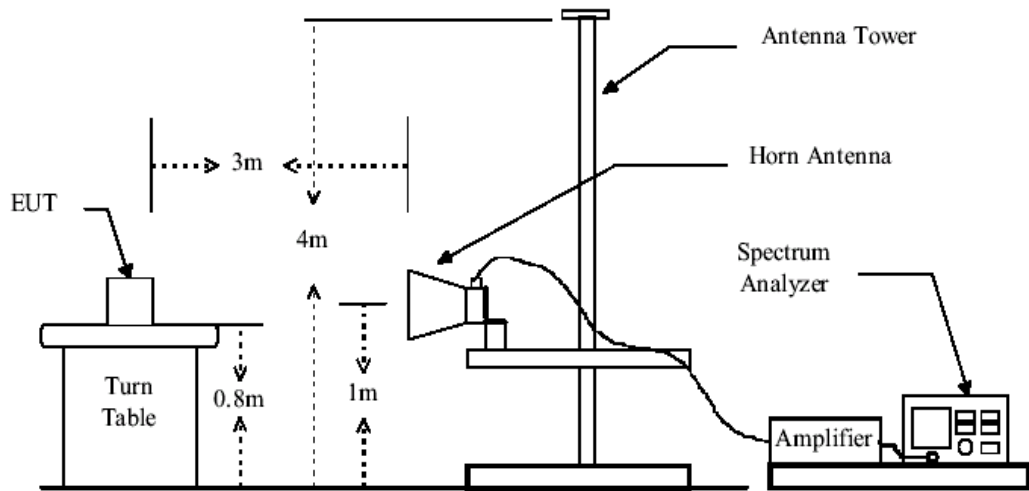
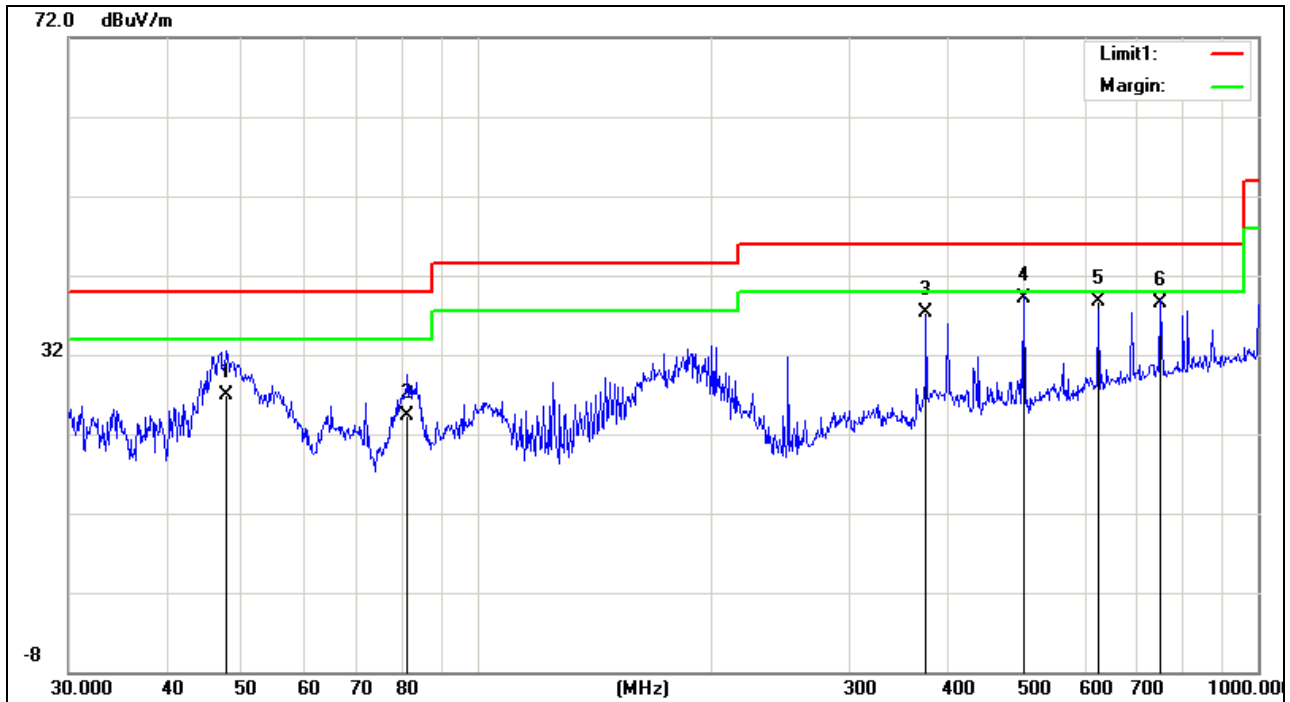

Figure 3. Above 1GHz radiated emissions test configuration

6.4 TEST RESULTS

Project No.:	ZJ00038221	Polarziation:	Vertical
Standard:	(RE)FCC PART 15 class B 3m	Power Source:	AC 120V/60Hz
Test item:	Radiation Test	Date:	2013-12-19
Temp./Hum.(%RH):	23/57%RH	Time:	17:19:35
EUT:	EPON ONU	Distance:	3m
Model:	ONT-2-E4021iWn	Test Result:	Pass
Note:	WIFI-b-2412		



No.	Frequency (MHz)	Reading (dBuV/m)	Correct Factor(dB/m)	Result (dBuV/m)	Limit (dBuV/m)	Margin (dB)	Remark
1	47.8260	16.38	10.52	26.90	40.00	-13.10	QP
2	81.4970	15.58	8.72	24.30	40.00	-15.70	QP
3	375.9385	19.58	17.72	37.30	46.00	-8.70	QP
4	501.1790	19.30	19.80	39.10	46.00	-6.90	QP
5	625.0780	15.87	22.83	38.70	46.00	-7.30	QP
6	750.1083	14.39	24.21	38.60	46.00	-7.40	QP

Emission from 9 kHz to 30MHz:

No.	Frequency (MHz)	Reading (dBuV/m)	Correct Factor(dB/m)	Result (dBuV/m)	Limit (dBuV/m)	Margin (dB)	Remark
1	0.0349	19.41	21.22	40.63	116.61	-75.98	QP
2	0.1539	12.49	20.83	33.32	103.80	-70.48	QP
3	0.3459	12.17	20.87	33.04	96.80	-63.76	QP
4	3.7459	7.51	21.16	28.67	69.50	-40.83	QP
5	7.9300	5.95	21.13	27.08	69.50	-42.42	QP
6	19.3140	0.39	21.84	22.23	69.50	-47.27	QP

Emission above 1GHz:

No.	Frequency (MHz)	Reading (dBuV/m)	Correct Factor(dB/m)	Result (dBuV/m)	Limit (dBuV/m)	Margin (dB)	Remark
1	1580.522	40.19	12.02	52.21	74.00	-21.79	peak
2	1580.522	24.48	12.02	36.50	54.00	-17.50	AVG
3	1835.663	38.79	13.46	52.25	74.00	-21.75	peak
4	1835.663	24.74	13.46	38.20	54.00	-15.80	AVG
5	1901.452	42.40	13.70	56.10	74.00	-17.90	peak
6	1901.452	28.60	13.70	42.30	54.00	-11.70	AVG
7	6551.118	30.15	18.39	48.54	74.00	-25.46	peak
8	6551.118	19.41	18.39	37.80	54.00	-16.20	AVG
9	8195.667	29.64	23.64	53.28	74.00	-20.72	peak
10	8195.667	18.46	23.64	42.10	54.00	-11.90	AVG
11	12937.883	29.32	28.02	57.34	74.00	-16.66	peak
12	12937.883	17.88	28.02	45.90	54.00	-8.10	AVG

Project No.:	ZJ00038221	Polarization:	Horizontal
Standard:	(RE)FCC PART 15 class B 3m	Power Source:	AC 120V/60Hz
Test item:	Radiation Test	Date:	2013-12-19
Temp./Hum.(%RH):	23/57%RH	Time:	16:49:01
EUT:	EPON ONU	Distance:	3m
Model:	ONT-2-E4021iWn	Test Result:	Pass
Note:	WIFI-b-2412		

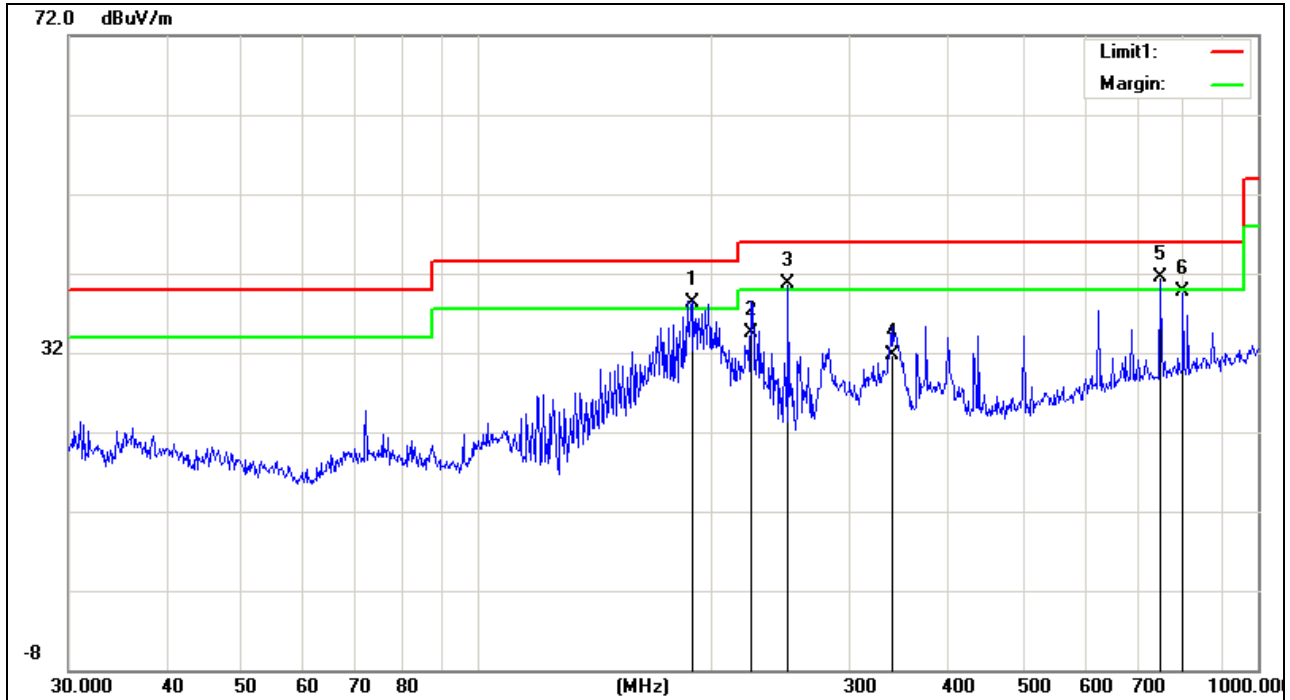

No.	Frequency (MHz)	Reading (dBuV/m)	Correct Factor(dB/m)	Result (dBuV/m)	Limit (dBuV/m)	Margin (dB)	Remark
1	188.4125	27.00	11.40	38.40	43.50	-5.10	QP
2	224.5193	21.77	12.73	34.50	46.00	-11.50	QP
3	250.3012	27.12	13.68	40.80	46.00	-5.20	QP
4	339.5888	14.74	16.96	31.70	46.00	-14.30	QP
5	750.1083	17.29	24.21	41.50	46.00	-4.50	QP
6	801.7863	14.62	25.08	39.70	46.00	-6.30	QP

Emission above 1GHz:

No.	Frequency (MHz)	Reading (dBuV/m)	Correct Factor(dB/m)	Result (dBuV/m)	Limit (dBuV/m)	Margin (dB)	Remark
1	1729.004	45.16	12.93	58.09	74.00	-15.91	peak
2	1729.004	25.27	12.93	38.20	54.00	-15.80	AVG
3	1835.663	40.17	13.46	53.63	74.00	-20.37	peak
4	1835.663	28.54	13.46	42.00	54.00	-12.00	AVG
5	1901.452	40.03	13.70	53.73	74.00	-20.27	peak
6	1901.452	25.40	13.70	39.10	54.00	-14.90	AVG
7	8125.371	28.71	23.51	52.22	74.00	-21.78	peak
8	8125.371	18.89	23.51	42.40	54.00	-11.60	AVG
9	9680.827	28.27	25.17	53.44	74.00	-20.56	peak
10	9680.827	18.53	25.17	43.70	54.00	-10.30	AVG
11	14305.713	26.70	30.67	57.37	74.00	-16.63	peak
12	14305.713	17.43	30.67	48.10	54.00	-5.90	AVG

Project No.:	ZJ00038221	Polarziation:	Vertical
Standard:	(RE)FCC PART 15 class B 3m	Power Source:	AC 120V/60Hz
Test item:	Radiation Test	Date:	2013-12-19
Temp./Hum.(%RH):	23/57%RH	Time:	17:25:59
EUT:	EPON ONU	Distance:	3m
Model:	ONT-2-E4021iWn	Test Result:	Pass
Note:	WIFI-b-2437		

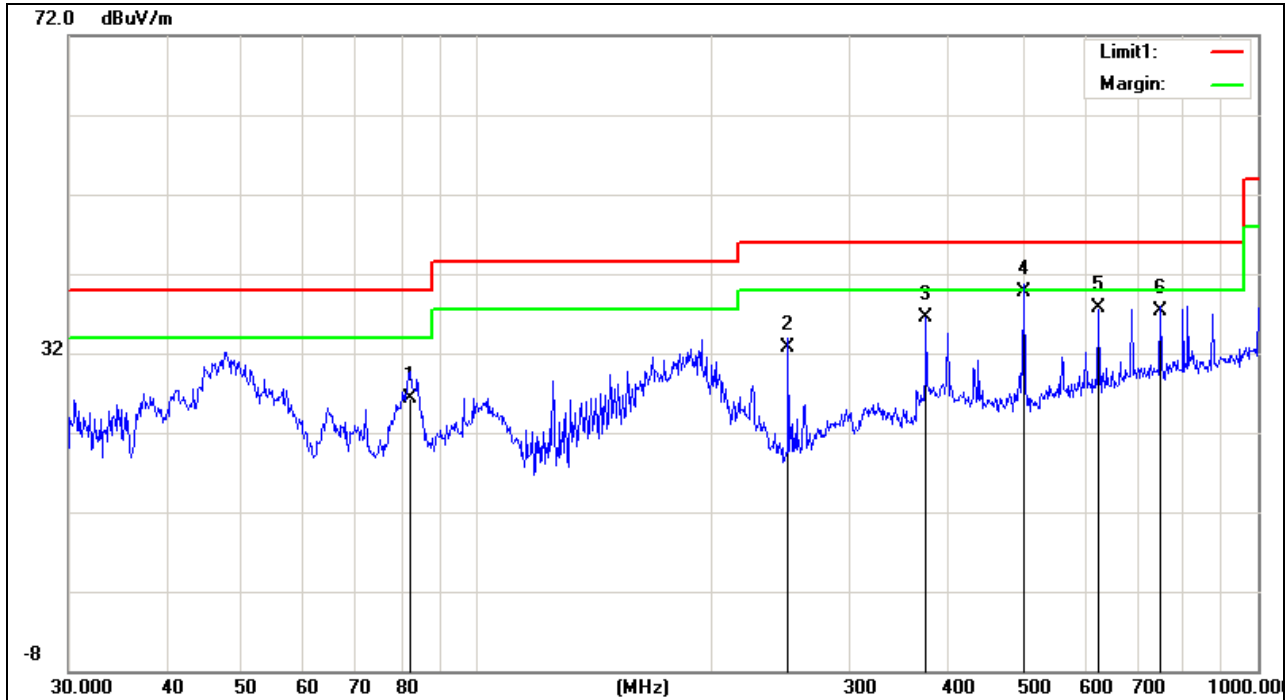

No.	Frequency (MHz)	Reading (dBuV/m)	Correct Factor(dB/m)	Result (dBuV/m)	Limit (dBuV/m)	Margin (dB)	Remark
1	82.0706	17.62	8.78	26.40	40.00	-13.60	QP
2	250.3012	19.02	13.68	32.70	46.00	-13.30	QP
3	375.9385	18.88	17.72	36.60	46.00	-9.40	QP
4	501.1790	20.00	19.80	39.80	46.00	-6.20	QP
5	625.0780	14.87	22.83	37.70	46.00	-8.30	QP
6	750.1083	13.19	24.21	37.40	46.00	-8.60	QP

Emission from 9 kHz to 30MHz:

No.	Frequency (MHz)	Reading (dBuV/m)	Correct Factor(dB/m)	Result (dBuV/m)	Limit (dBuV/m)	Margin (dB)	Remark
1	0.0349	19.34	21.22	40.56	116.61	-76.05	QP
2	0.1539	13.40	20.83	34.23	103.80	-69.57	QP
3	0.3059	11.63	20.87	32.50	97.87	-65.37	QP
4	3.0499	6.76	21.13	27.89	69.50	-41.61	QP
5	7.1260	6.53	21.14	27.67	69.50	-41.83	QP
6	19.3140	0.50	21.84	22.34	69.50	-47.16	QP

Emission above 1GHz:

No.	Frequency (MHz)	Reading (dBuV/m)	Correct Factor(dB/m)	Result (dBuV/m)	Limit (dBuV/m)	Margin (dB)	Remark
1	1577.742	39.97	12.00	51.97	74.00	-22.03	peak
2	1577.742	22.60	12.00	34.60	54.00	-19.40	AVG
3	1835.663	39.93	13.46	53.39	74.00	-20.61	peak
4	1835.663	25.44	13.46	38.90	54.00	-15.10	AVG
5	1911.522	39.98	13.74	53.72	74.00	-20.28	peak
6	1911.522	25.43	13.74	39.17	54.00	-14.83	AVG
7	6329.231	30.10	18.13	48.23	74.00	-25.77	peak
8	6329.231	18.67	18.13	36.80	54.00	-17.20	AVG
9	9962.833	28.06	25.63	53.69	74.00	-20.31	peak
10	9962.833	17.97	25.63	43.60	54.00	-10.40	AVG
11	13821.178	28.07	29.67	57.74	74.00	-16.26	peak
12	13821.178	18.23	29.67	47.90	54.00	-6.10	AVG

Project No.:	ZJ00038221	Polarziation:	Horizontal
Standard:	(RE)FCC PART 15 class B 3m	Power Source:	AC 120V/60Hz
Test item:	Radiation Test	Date:	2013-12-19
Temp./Hum.(%RH):	23/57%RH	Time:	16:57:42
EUT:	EPON ONU	Distance:	3m
Model:	ONT-2-E4021iWn	Test Result:	Pass
Note:	WIFI-b-2437		

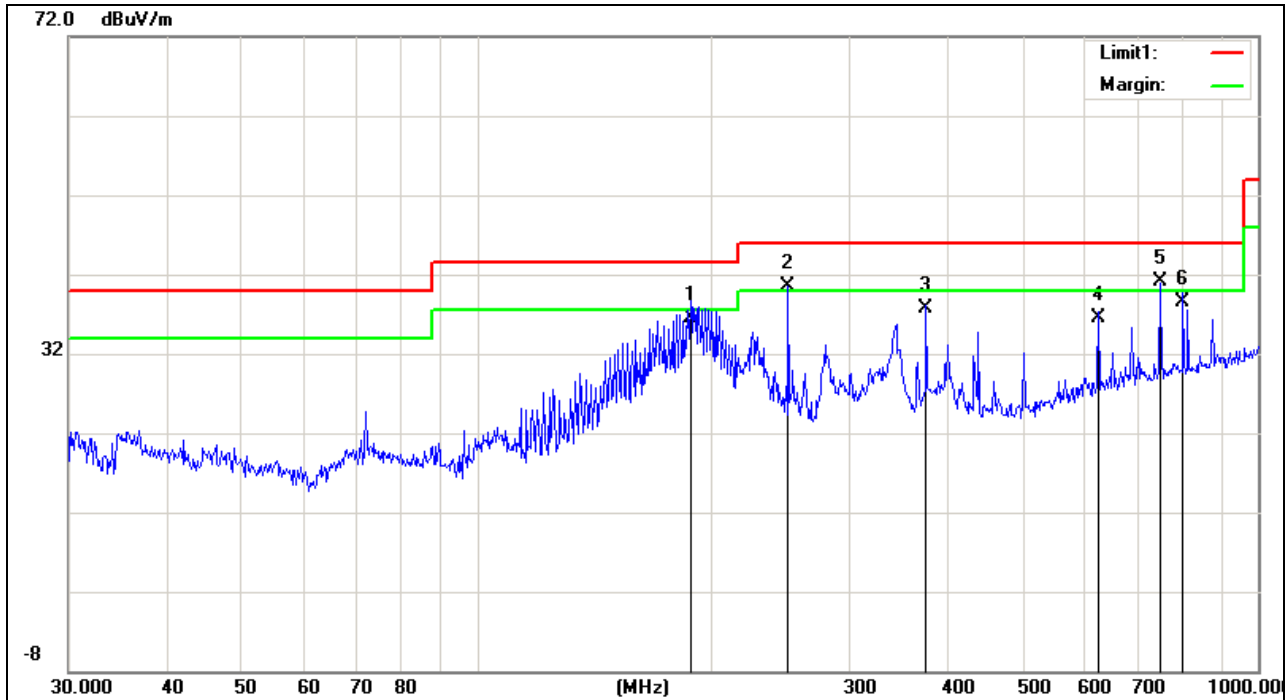

No.	Frequency (MHz)	Reading (dBuV/m)	Correct Factor(dB/m)	Result (dBuV/m)	Limit (dBuV/m)	Margin (dB)	Remark
1	187.7529	25.22	11.38	36.60	43.50	-6.90	QP
2	250.3011	26.82	13.68	40.50	46.00	-5.50	QP
3	375.9384	20.08	17.72	37.80	46.00	-8.20	QP
4	625.0779	13.67	22.83	36.50	46.00	-9.50	QP
5	750.1082	16.89	24.21	41.10	46.00	-4.90	QP
6	801.7862	13.52	25.08	38.60	46.00	-7.40	QP

Emission above 1GHz:

No.	Frequency (MHz)	Reading (dBuV/m)	Correct Factor(dB/m)	Result (dBuV/m)	Limit (dBuV/m)	Margin (dB)	Remark
1	1835.663	39.47	13.46	52.93	74.00	-21.07	peak
2	1835.663	28.14	13.46	41.60	54.00	-12.40	AVG
3	1904.803	39.59	13.72	53.31	74.00	-20.69	peak
4	1904.803	25.48	13.72	39.20	54.00	-14.80	AVG
5	2973.707	36.35	23.44	59.79	74.00	-14.21	peak
6	2973.707	23.36	23.44	46.80	54.00	-7.20	AVG
7	6664.961	29.29	18.55	47.84	74.00	-26.16	peak
8	6664.961	18.95	18.55	37.50	54.00	-16.50	AVG
9	10194.340	27.66	25.28	52.94	74.00	-21.06	peak
10	10194.340	18.32	25.28	43.60	54.00	-10.40	AVG
11	15727.575	27.90	31.05	58.95	74.00	-15.05	peak
12	15727.575	18.15	31.05	49.20	54.00	-4.80	AVG

Project No.:	ZJ00038221	Polarziation:	Vertical
Standard:	(RE)FCC PART 15 class B 3m	Power Source:	AC 120V/60Hz
Test item:	Radiation Test	Date:	2013-12-19
Temp./Hum.(%RH):	23/57%RH	Time:	17:27:30
EUT:	EPON ONU	Distance:	3m
Model:	ONT-2-E4021iWn	Test Result:	Pass
Note:	WIFI-b-2462		

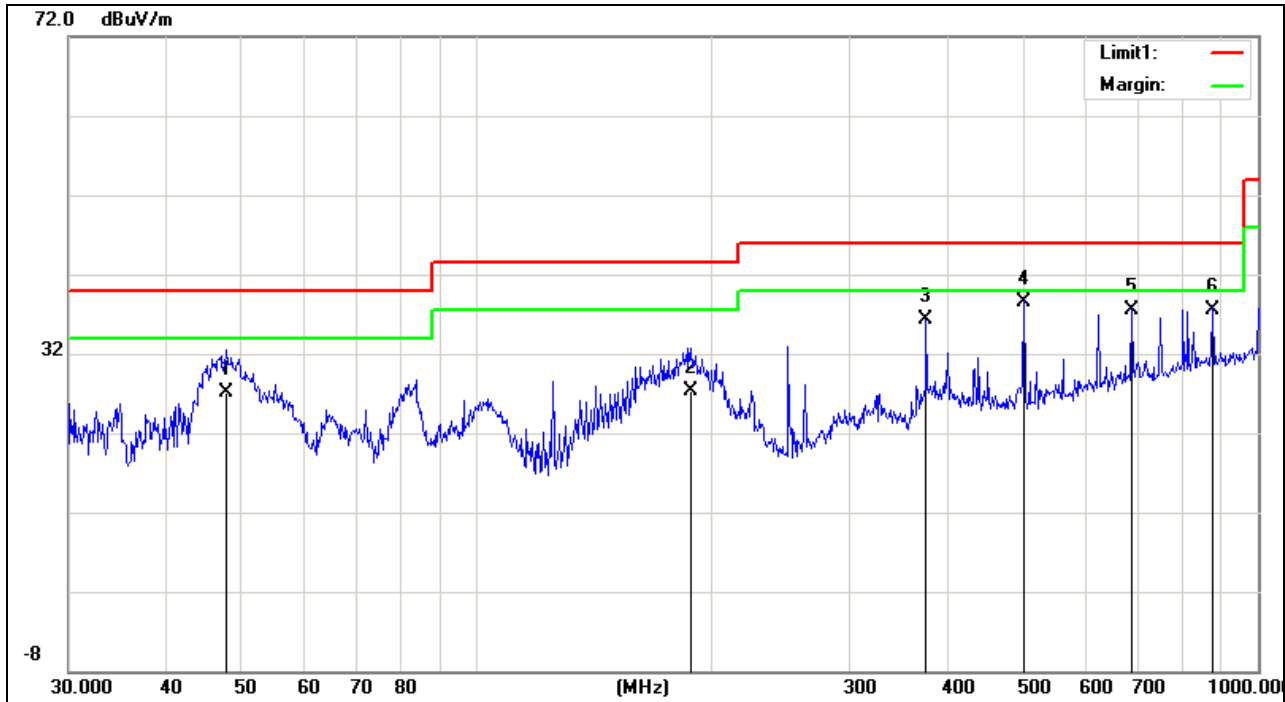

No.	Frequency (MHz)	Reading (dBuV/m)	Correct Factor(dB/m)	Result (dBuV/m)	Limit (dBuV/m)	Margin (dB)	Remark
1	47.8260	16.68	10.52	27.20	40.00	-12.80	QP
2	187.7530	15.92	11.38	27.30	43.50	-16.20	QP
3	375.9385	18.58	17.72	36.30	46.00	-9.70	QP
4	501.1790	18.70	19.80	38.50	46.00	-7.50	QP
5	689.5644	13.50	24.00	37.50	46.00	-8.50	QP
6	875.2470	12.01	25.59	37.60	46.00	-8.40	QP

Emission from 9 kHz to 30MHz:

No.	Frequency (MHz)	Reading (dBuV/m)	Correct Factor(dB/m)	Result (dBuV/m)	Limit (dBuV/m)	Margin (dB)	Remark
1	0.0349	20.01	21.22	41.23	116.61	-75.38	QP
2	0.1700	13.41	20.84	34.25	102.94	-68.69	QP
3	0.3457	12.17	20.87	33.04	96.81	-63.77	QP
4	2.0139	10.15	21.08	31.23	69.50	-38.27	QP
5	7.1260	6.37	21.14	27.51	69.50	-41.99	QP
6	19.3140	1.37	21.84	23.21	69.50	-46.29	QP

Emission above 1GHz:

No.	Frequency (MHz)	Reading (dBuV/m)	Correct Factor(dB/m)	Result (dBuV/m)	Limit (dBuV/m)	Margin (dB)	Remark
1	1678.022	36.31	12.64	48.95	74.00	-25.05	peak
2	1678.022	23.66	12.64	36.30	54.00	-17.70	AVG
3	1942.052	36.21	13.85	50.06	74.00	-23.94	peak
4	1942.052	23.25	13.85	37.10	54.00	-16.90	AVG
5	2271.495	34.39	15.63	50.02	74.00	-23.98	peak
6	2271.495	22.17	15.63	37.80	54.00	-16.20	AVG
7	6958.300	28.56	18.92	47.48	74.00	-26.52	peak
8	6958.300	18.78	18.92	37.70	54.00	-16.30	AVG
9	9326.119	27.84	24.63	52.47	74.00	-21.53	peak
10	9326.119	18.07	24.63	42.70	54.00	-11.30	AVG
11	13429.960	28.14	28.83	56.97	74.00	-17.03	peak
12	13429.960	18.27	28.83	47.10	54.00	-6.90	AVG

Project No.:	ZJ00038221	Polarziation:	Horizontal
Standard:	(RE)FCC PART 15 class B 3m	Power Source:	AC 120V/60Hz
Test item:	Radiation Test	Date:	2013-12-19
Temp./Hum.(%RH):	23/57%RH	Time:	16:59:23
EUT:	EPON ONU	Distance:	3m
Model:	ONT-2-E4021iWn	Test Result:	Pass
Note:	WIFI-b-2462		

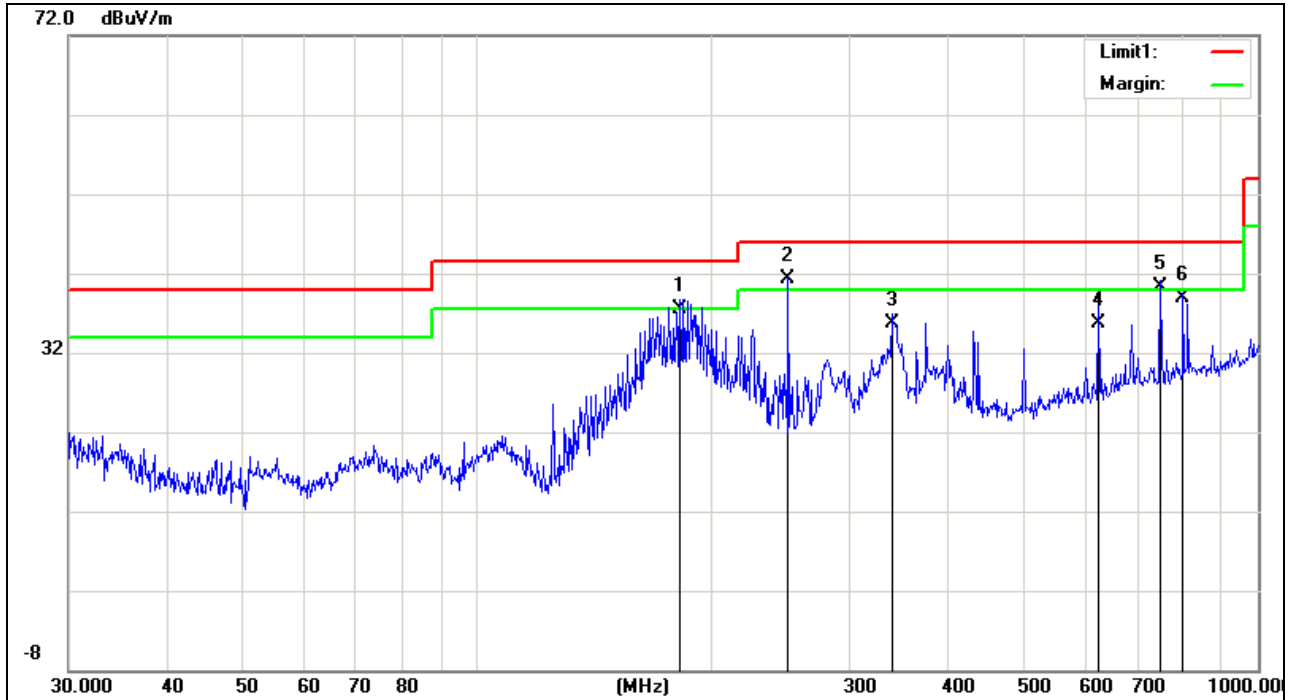

No.	Frequency (MHz)	Reading (dBuV/m)	Correct Factor(dB/m)	Result (dBuV/m)	Limit (dBuV/m)	Margin (dB)	Remark
1	181.9202	26.35	11.15	37.50	43.50	-6.00	QP
2	250.3012	27.72	13.68	41.40	46.00	-4.60	QP
3	339.5888	18.84	16.96	35.80	46.00	-10.20	QP
4	625.0780	12.97	22.83	35.80	46.00	-10.20	QP
5	750.1083	16.09	24.21	40.30	46.00	-5.70	QP
6	801.7863	13.82	25.08	38.90	46.00	-7.10	QP

Emission above 1GHz:

No.	Frequency (MHz)	Reading (dBuV/m)	Correct Factor(dB/m)	Result (dBuV/m)	Limit (dBuV/m)	Margin (dB)	Remark
1	1580.522	39.44	12.02	51.46	74.00	-22.54	peak
2	1580.522	24.88	12.02	36.90	54.00	-17.10	AVG
3	1878.162	38.38	13.62	52.00	74.00	-22.00	peak
4	1878.162	25.18	13.62	38.80	54.00	-15.20	AVG
5	1911.522	39.99	13.74	53.73	74.00	-20.27	peak
6	1911.522	25.26	13.74	39.00	54.00	-15.00	AVG
7	7716.076	27.68	22.27	49.95	74.00	-24.05	peak
8	7716.076	18.23	22.27	40.50	54.00	-13.50	AVG
9	10312.104	28.56	25.02	53.58	74.00	-20.42	peak
10	10312.104	18.08	25.02	43.10	54.00	-10.90	AVG
11	14892.515	26.72	31.21	57.93	74.00	-16.07	peak
12	14892.515	17.59	31.21	48.80	54.00	-5.20	AVG

Project No.:	ZJ00038221	Polarziation:	Vertical
Standard:	(RE)FCC PART 15 class B 3m	Power Source:	AC 120V/60Hz
Test item:	Radiation Test	Date:	2013-12-19
Temp./Hum.(%RH):	23/57%RH	Time:	17:29:08
EUT:	EPON ONU	Distance:	3m
Model:	ONT-2-E4021iWn	Test Result:	Pass
Note:	WIFI-g-2412		

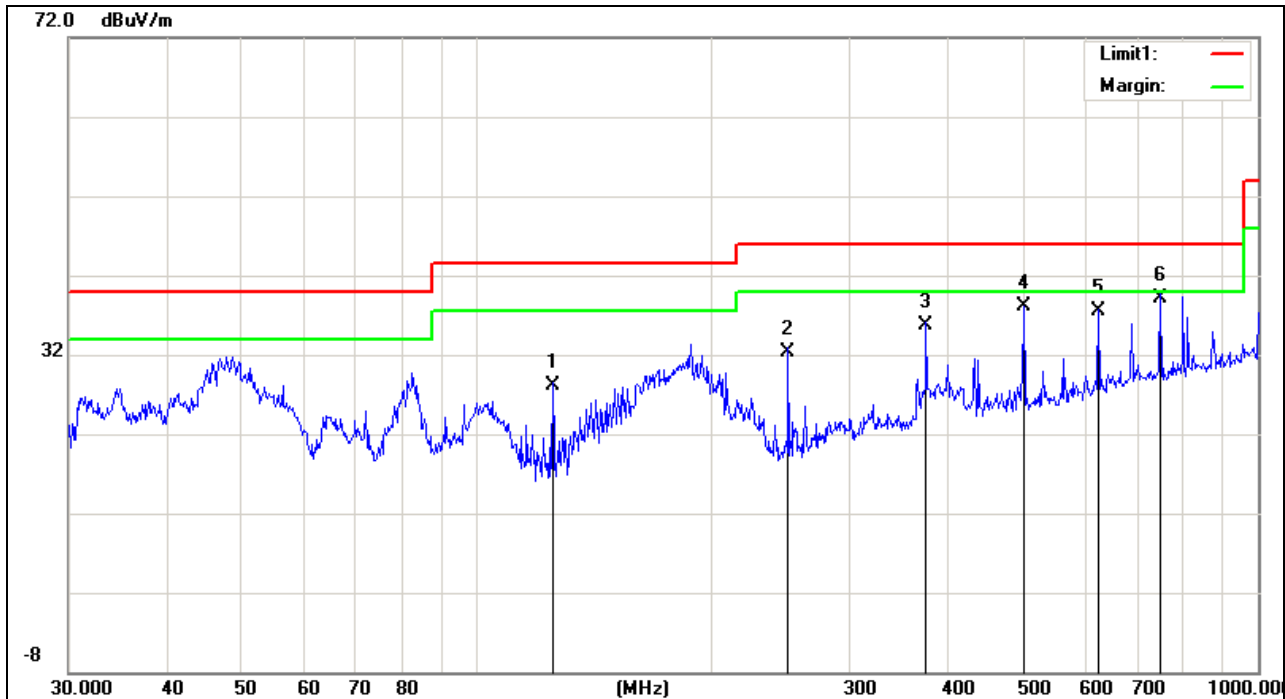

No.	Frequency (MHz)	Reading (dBuV/m)	Correct Factor(dB/m)	Result (dBuV/m)	Limit (dBuV/m)	Margin (dB)	Remark
1	125.0066	19.34	8.76	28.10	43.50	-15.40	QP
2	250.3011	18.62	13.68	32.30	46.00	-13.70	QP
3	375.9384	17.98	17.72	35.70	46.00	-10.30	QP
4	501.1789	18.30	19.80	38.10	46.00	-7.90	QP
5	625.0779	14.67	22.83	37.50	46.00	-8.50	QP
6	750.1082	14.99	24.21	39.20	46.00	-6.80	QP

Emission from 9 kHz to 30MHz:

No.	Frequency (MHz)	Reading (dBuV/m)	Correct Factor(dB/m)	Result (dBuV/m)	Limit (dBuV/m)	Margin (dB)	Remark
1	0.0349	18.46	21.22	39.68	116.61	-76.93	QP
2	0.1539	11.03	20.83	31.86	103.80	-71.94	QP
3	0.3059	11.63	20.87	32.50	97.87	-65.37	QP
4	3.0499	7.69	21.13	28.82	69.50	-40.68	QP
5	7.9298	5.95	21.13	27.08	69.50	-42.42	QP
6	19.3140	2.01	21.84	23.85	69.50	-45.65	QP

Emission above 1GHz:

No.	Frequency (MHz)	Reading (dBuV/m)	Correct Factor(dB/m)	Result (dBuV/m)	Limit (dBuV/m)	Margin (dB)	Remark
1	1822.781	36.07	13.43	49.50	74.00	-24.50	peak
2	1822.781	23.27	13.43	36.70	54.00	-17.30	AVG
3	2699.257	34.13	19.54	53.67	74.00	-20.33	peak
4	2699.257	20.96	19.54	40.50	54.00	-13.50	AVG
5	2942.459	36.38	23.02	59.40	74.00	-14.60	peak
6	2942.459	22.28	23.02	45.30	54.00	-8.70	AVG
7	8580.980	28.49	24.23	52.72	74.00	-21.28	peak
8	8580.980	17.77	24.23	42.00	54.00	-12.00	AVG
9	10194.340	29.37	25.28	54.65	74.00	-19.35	peak
10	10194.340	18.32	25.28	43.60	54.00	-10.40	AVG
11	14346.850	28.16	30.74	58.90	74.00	-15.10	peak
12	14346.850	17.26	30.74	48.00	54.00	-6.00	AVG

Project No.:	ZJ00038221	Polarization:	Horizontal
Standard:	(RE)FCC PART 15 class B 3m	Power Source:	AC 120V/60Hz
Test item:	Radiation Test	Date:	2013-12-19
Temp./Hum.(%RH):	23/57%RH	Time:	16:49:01
EUT:	EPON ONU	Distance:	3m
Model:	ONT-2-E4021iWn	Test Result:	Pass
Note:	WIFI-g-2412		

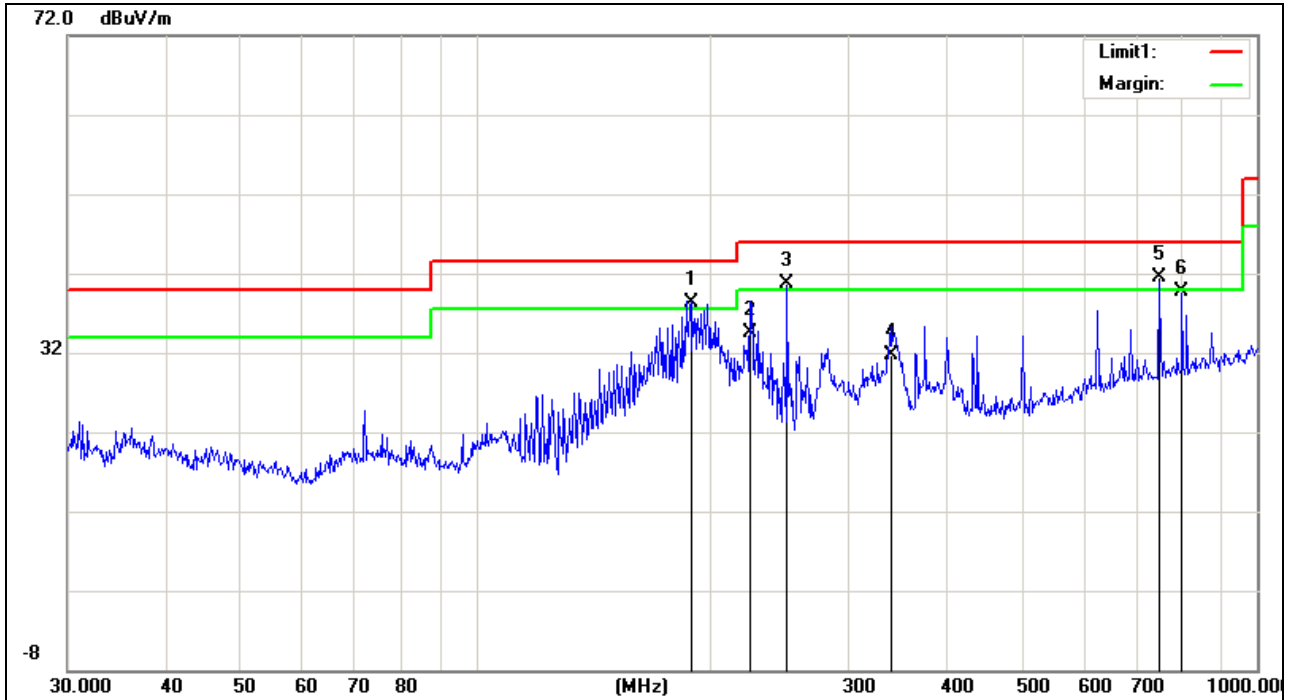

No.	Frequency (MHz)	Reading (dBuV/m)	Correct Factor(dB/m)	Result (dBuV/m)	Limit (dBuV/m)	Margin (dB)	Remark
1	188.4125	27.00	11.40	38.40	43.50	-5.10	QP
2	224.5193	21.77	12.73	34.50	46.00	-11.50	QP
3	250.3012	27.12	13.68	40.80	46.00	-5.20	QP
4	339.5888	14.74	16.96	31.70	46.00	-14.30	QP
5	750.1083	17.29	24.21	41.50	46.00	-4.50	QP
6	801.7863	14.62	25.08	39.70	46.00	-6.30	QP

Emission above 1GHz:

No.	Frequency (MHz)	Reading (dBuV/m)	Correct Factor(dB/m)	Result (dBuV/m)	Limit (dBuV/m)	Margin (dB)	Remark
1	1574.966	40.73	11.98	52.71	74.00	-21.29	peak
2	1574.966	22.32	11.98	34.30	54.00	-19.70	AVG
3	1881.472	39.41	13.63	53.04	74.00	-20.96	peak
4	1881.472	22.67	13.63	36.30	54.00	-17.70	AVG
5	1914.890	40.65	13.76	54.41	74.00	-19.59	peak
6	1914.890	21.94	13.76	35.70	54.00	-18.30	AVG
7	7738.264	28.06	22.34	50.40	74.00	-23.60	peak
8	7738.264	18.56	22.34	40.90	54.00	-13.10	AVG
9	9792.658	28.20	25.35	53.55	74.00	-20.45	peak
10	9792.658	18.15	25.35	43.50	54.00	-10.50	AVG
11	15282.394	29.73	31.01	60.74	74.00	-13.26	peak
12	15282.394	18.29	31.01	49.30	54.00	-4.70	AVG

Project No.:	ZJ00038221	Polarziation:	Vertical
Standard:	(RE)FCC PART 15 class B 3m	Power Source:	AC 120V/60Hz
Test item:	Radiation Test	Date:	2013-12-19
Temp./Hum.(%RH):	23/57%RH	Time:	17:25:59
EUT:	EPON ONU	Distance:	3m
Model:	ONT-2-E4021iWn	Test Result:	Pass
Note:	WIFI-g-2437		

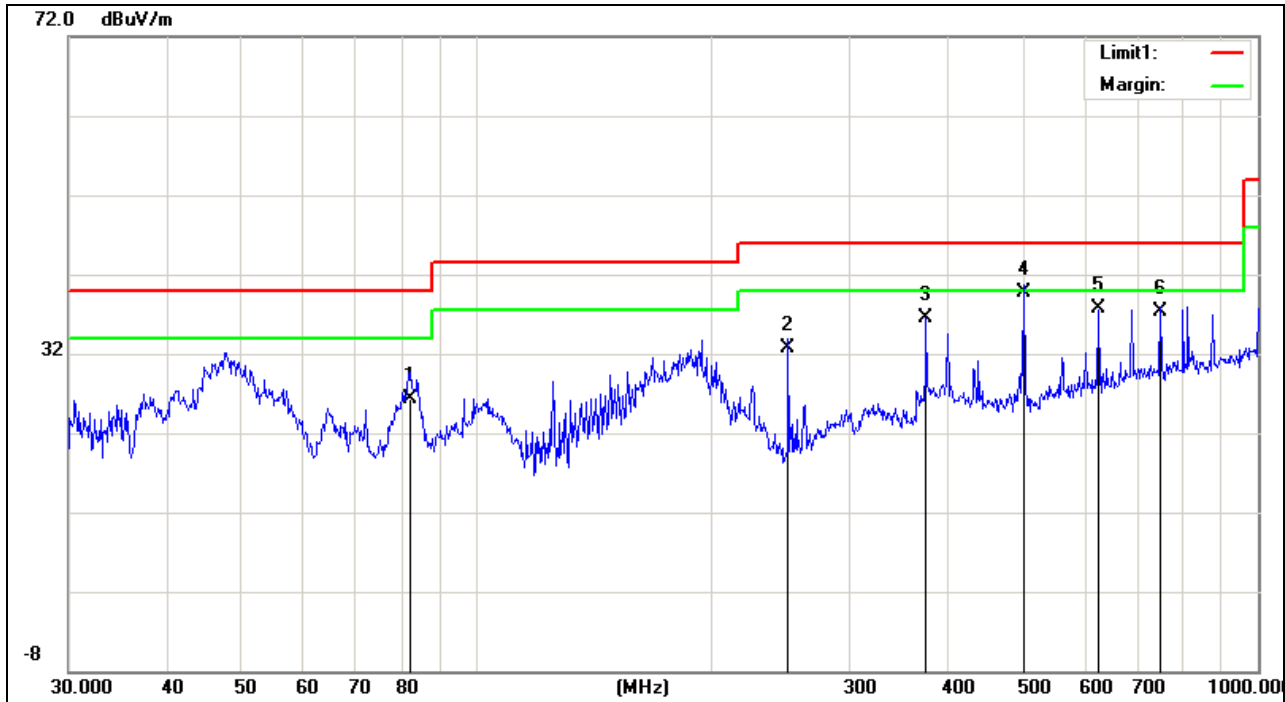

No.	Frequency (MHz)	Reading (dBuV/m)	Correct Factor(dB/m)	Result (dBuV/m)	Limit (dBuV/m)	Margin (dB)	Remark
1	82.0706	17.62	8.78	26.40	40.00	-13.60	QP
2	250.3012	19.02	13.68	32.70	46.00	-13.30	QP
3	375.9385	18.88	17.72	36.60	46.00	-9.40	QP
4	501.1790	20.00	19.80	39.80	46.00	-6.20	QP
5	625.0780	14.87	22.83	37.70	46.00	-8.30	QP
6	750.1083	13.19	24.21	37.40	46.00	-8.60	QP

Emission from 9 kHz to 30MHz:

No.	Frequency (MHz)	Reading (dBuV/m)	Correct Factor(dB/m)	Result (dBuV/m)	Limit (dBuV/m)	Margin (dB)	Remark
1	0.0349	18.99	21.22	40.21	116.61	-76.40	QP
2	0.1539	13.04	20.83	33.87	103.80	-69.93	QP
3	0.3457	10.98	20.87	31.85	96.81	-64.96	QP
4	2.0139	9.03	21.08	30.11	69.50	-39.39	QP
5	7.1260	4.72	21.14	25.86	69.50	-43.64	QP
6	19.3140	1.51	21.84	23.35	69.50	-46.15	QP

Emission above 1GHz:

No.	Frequency (MHz)	Reading (dBuV/m)	Correct Factor(dB/m)	Result (dBuV/m)	Limit (dBuV/m)	Margin (dB)	Remark
1	1648.737	35.97	12.47	48.44	74.00	-25.56	peak
2	1648.737	24.13	12.47	36.60	54.00	-17.40	AVG
3	1997.536	36.17	14.05	50.22	74.00	-23.78	peak
4	1997.536	22.35	14.05	36.40	54.00	-17.60	AVG
5	2984.196	36.05	23.58	59.63	74.00	-14.37	peak
6	2984.196	21.92	23.58	45.50	54.00	-8.50	AVG
7	8009.548	28.46	23.28	51.74	74.00	-22.26	peak
8	8009.548	18.82	23.28	42.10	54.00	-11.90	AVG
9	10282.536	28.64	25.08	53.72	74.00	-20.28	peak
10	10282.536	18.42	25.08	43.50	54.00	-10.50	AVG
11	14849.814	27.32	31.20	58.52	74.00	-15.48	peak
12	14849.814	17.60	31.20	48.80	54.00	-5.20	AVG

Project No.:	ZJ00038221	Polarziation:	Horizontal
Standard:	(RE)FCC PART 15 class B 3m	Power Source:	AC 120V/60Hz
Test item:	Radiation Test	Date:	2013-12-19
Temp./Hum.(%RH):	23/57%RH	Time:	16:57:42
EUT:	EPON ONU	Distance:	3m
Model:	ONT-2-E4021iWn	Test Result:	Pass
Note:	WIFI-g-2437		

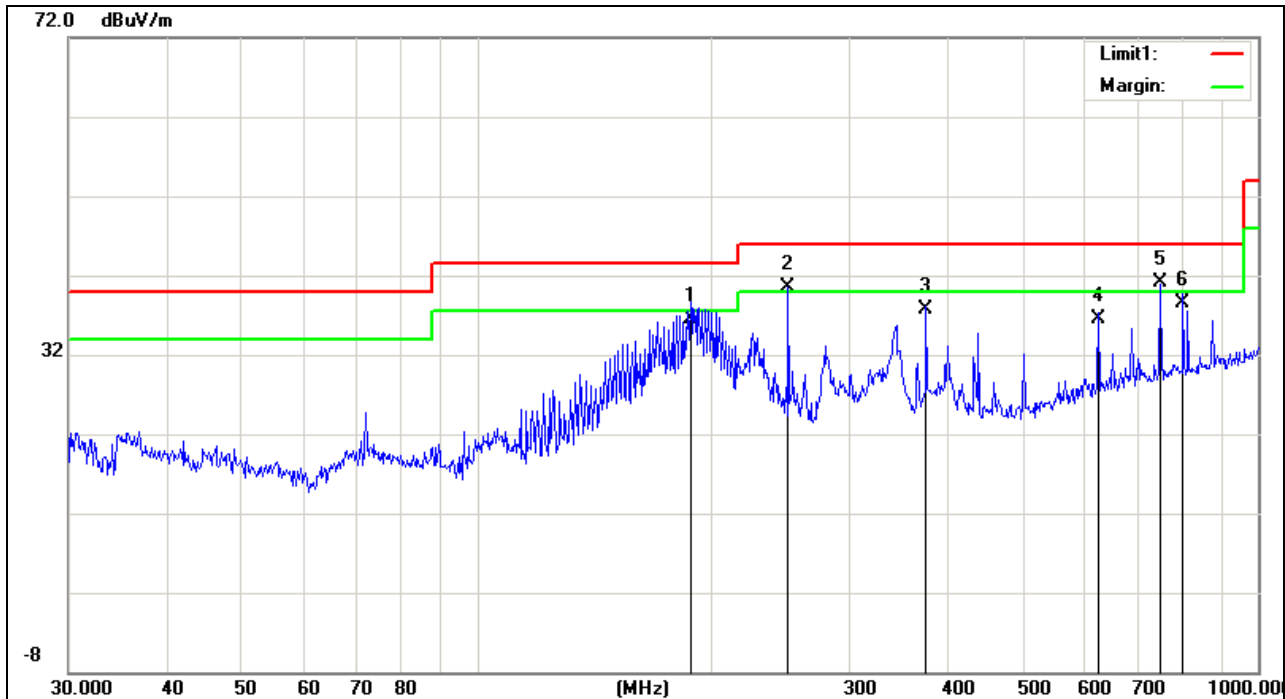

No.	Frequency (MHz)	Reading (dBuV/m)	Correct Factor(dB/m)	Result (dBuV/m)	Limit (dBuV/m)	Margin (dB)	Remark
1	187.7529	25.22	11.38	36.60	43.50	-6.90	QP
2	250.3011	26.82	13.68	40.50	46.00	-5.50	QP
3	375.9384	20.08	17.72	37.80	46.00	-8.20	QP
4	625.0779	13.67	22.83	36.50	46.00	-9.50	QP
5	750.1082	16.89	24.21	41.10	46.00	-4.90	QP
6	801.7862	13.52	25.08	38.60	46.00	-7.40	QP

Emission above 1GHz:

No.	Frequency (MHz)	Reading (dBuV/m)	Correct Factor(dB/m)	Result (dBuV/m)	Limit (dBuV/m)	Margin (dB)	Remark
1	1577.742	39.52	12.00	51.52	74.00	-22.48	peak
2	1577.742	23.30	12.00	35.30	54.00	-18.70	AVG
3	1874.858	38.70	13.60	52.30	74.00	-21.70	peak
4	1874.858	23.80	13.60	37.40	54.00	-16.60	AVG
5	2947.644	35.97	23.09	59.06	74.00	-14.94	peak
6	2947.644	24.31	23.09	47.40	54.00	-6.60	AVG
7	8009.548	29.49	23.28	52.77	74.00	-21.23	peak
8	8009.548	18.72	23.28	42.00	54.00	-12.00	AVG
9	9764.580	28.55	25.31	53.86	74.00	-20.14	peak
10	9764.580	18.29	25.31	43.60	54.00	-10.40	AVG
11	16705.118	27.32	32.56	59.88	74.00	-14.12	peak
12	16753.154	18.55	32.75	51.30	54.00	-2.70	AVG

Project No.:	ZJ00038221	Polarization:	Vertical
Standard:	(RE)FCC PART 15 class B 3m	Power Source:	AC 120V/60Hz
Test item:	Radiation Test	Date:	2013-12-19
Temp./Hum.(%RH):	23/57%RH	Time:	17:27:30
EUT:	EPON ONU	Distance:	3m
Model:	ONT-2-E4021iWn	Test Result:	Pass
Note:	WIFI-g-2462		

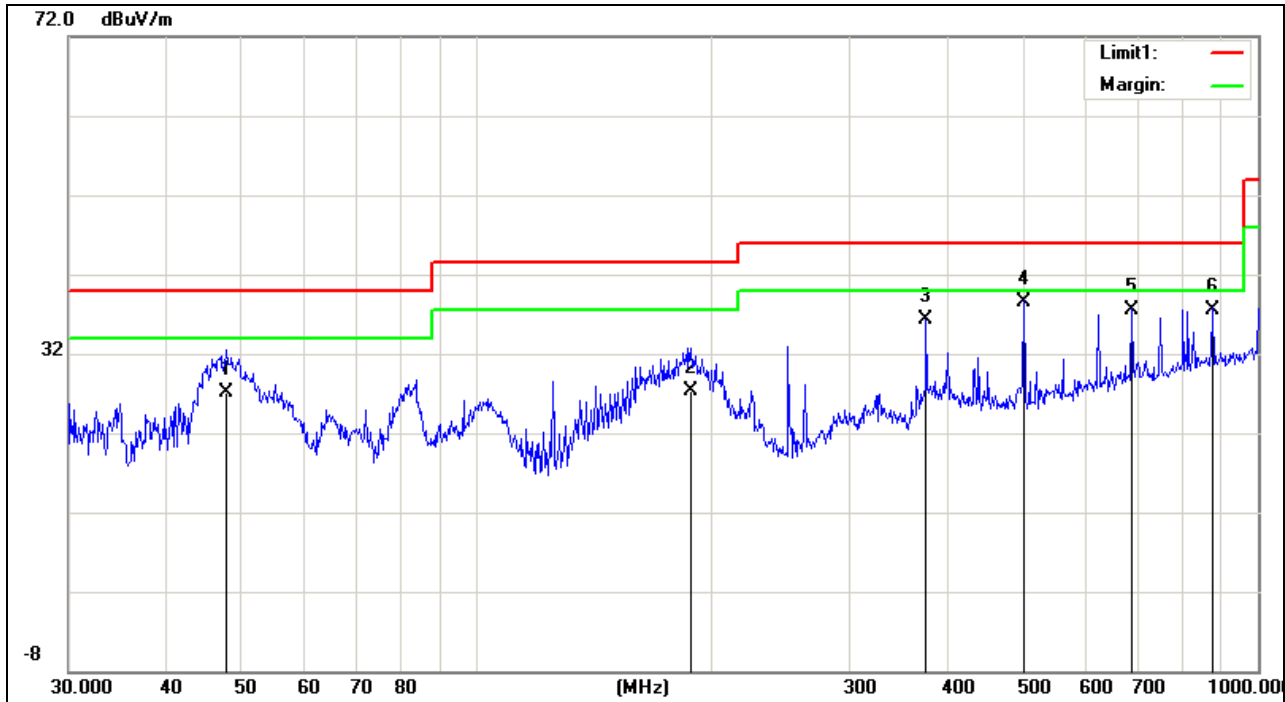

No.	Frequency (MHz)	Reading (dBuV/m)	Correct Factor(dB/m)	Result (dBuV/m)	Limit (dBuV/m)	Margin (dB)	Remark
1	47.8260	16.68	10.52	27.20	40.00	-12.80	QP
2	187.7530	15.92	11.38	27.30	43.50	-16.20	QP
3	375.9385	18.58	17.72	36.30	46.00	-9.70	QP
4	501.1790	18.70	19.80	38.50	46.00	-7.50	QP
5	689.5644	13.50	24.00	37.50	46.00	-8.50	QP
6	875.2470	12.01	25.59	37.60	46.00	-8.40	QP

Emission from 9 kHz to 30MHz:

No.	Frequency (MHz)	Reading (dBuV/m)	Correct Factor(dB/m)	Result (dBuV/m)	Limit (dBuV/m)	Margin (dB)	Remark
1	0.0349	20.31	21.22	41.53	116.61	-75.08	QP
2	0.1539	13.42	20.83	34.25	103.80	-69.55	QP
3	0.2827	11.69	20.86	32.55	98.55	-66.00	QP
4	3.2500	6.81	21.14	27.95	69.50	-41.55	QP
5	6.8098	5.94	21.15	27.09	69.50	-42.41	QP
6	19.3140	0.39	21.84	22.23	69.50	-47.27	QP

Emission above 1GHz:

No.	Frequency (MHz)	Reading (dBuV/m)	Correct Factor(dB/m)	Result (dBuV/m)	Limit (dBuV/m)	Margin (dB)	Remark
1	1966.134	36.04	13.94	49.98	74.00	-24.02	peak
2	1966.134	25.46	13.94	39.40	54.00	-14.60	AVG
3	2369.532	35.98	16.20	52.18	74.00	-21.82	peak
4	2369.532	24.10	16.20	40.30	54.00	-13.70	AVG
5	2963.254	36.83	23.29	60.12	74.00	-13.88	peak
6	2963.254	25.81	23.29	49.10	54.00	-4.90	AVG
7	8078.842	27.93	23.41	51.34	74.00	-22.66	peak
8	8078.842	18.29	23.41	41.70	54.00	-12.30	AVG
9	10431.228	29.09	24.75	53.84	74.00	-20.16	peak
10	10431.228	18.15	24.75	42.90	54.00	-11.10	AVG
11	14807.235	27.52	31.17	58.69	74.00	-15.31	peak
12	14807.235	17.53	31.17	48.70	54.00	-5.30	AVG

Project No.:	ZJ00038221	Polarziation:	Horizontal
Standard:	(RE)FCC PART 15 class B 3m	Power Source:	AC 120V/60Hz
Test item:	Radiation Test	Date:	2013-12-19
Temp./Hum.(%RH):	23/57%RH	Time:	16:59:23
EUT:	EPON ONU	Distance:	3m
Model:	ONT-2-E4021iWn	Test Result:	Pass
Note:	WIFI-g-2462		

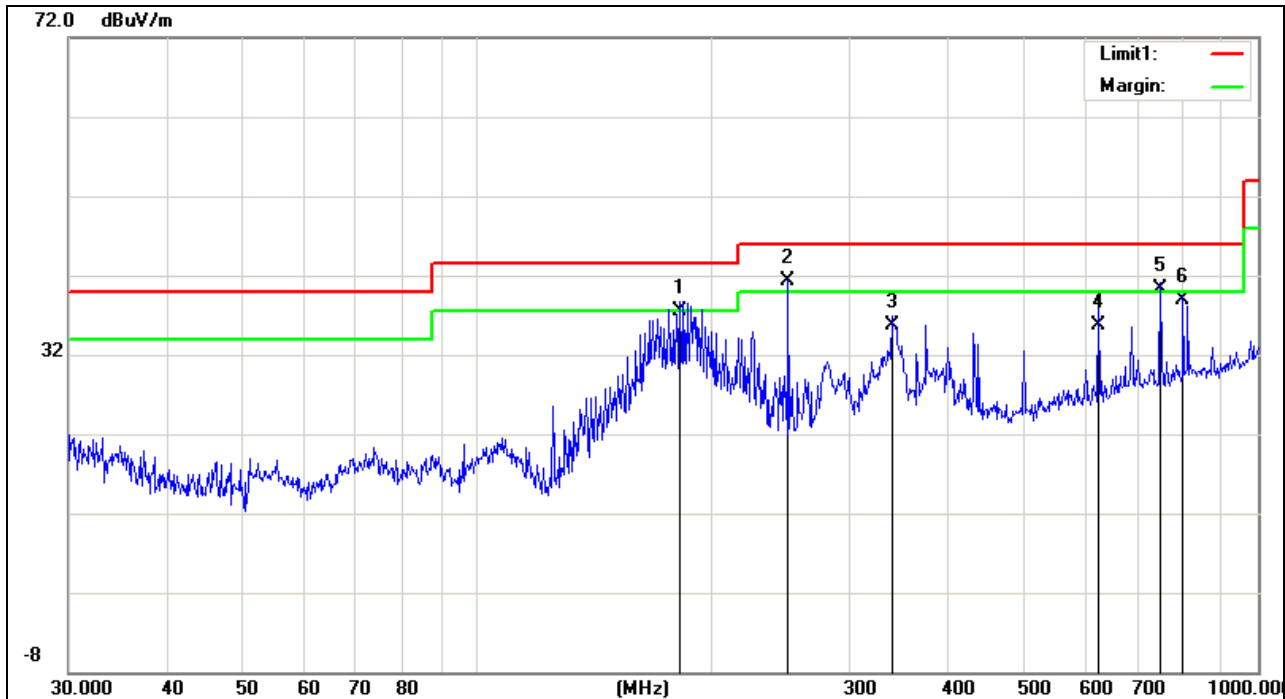

No.	Frequency (MHz)	Reading (dBuV/m)	Correct Factor(dB/m)	Result (dBuV/m)	Limit (dBuV/m)	Margin (dB)	Remark
1	181.9202	26.35	11.15	37.50	43.50	-6.00	QP
2	250.3012	27.72	13.68	41.40	46.00	-4.60	QP
3	339.5888	18.84	16.96	35.80	46.00	-10.20	QP
4	625.0780	12.97	22.83	35.80	46.00	-10.20	QP
5	750.1083	16.09	24.21	40.30	46.00	-5.70	QP
6	801.7863	13.82	25.08	38.90	46.00	-7.10	QP

Emission above 1GHz:

No.	Frequency (MHz)	Reading (dBuV/m)	Correct Factor(dB/m)	Result (dBuV/m)	Limit (dBuV/m)	Margin (dB)	Remark
1	2083.749	36.45	14.54	50.99	74.00	-23.01	peak
2	2083.749	24.36	14.54	38.90	54.00	-15.10	AVG
3	2390.483	37.08	16.33	53.41	74.00	-20.59	peak
4	2390.483	24.37	16.33	40.70	54.00	-13.30	AVG
5	2968.476	36.10	23.37	59.47	74.00	-14.53	peak
6	2968.476	25.63	23.37	49.00	54.00	-5.00	AVG
7	7079.220	28.30	19.38	47.68	74.00	-26.32	peak
8	7079.220	17.92	19.38	37.30	54.00	-16.70	AVG
9	9792.658	28.43	25.35	53.78	74.00	-20.22	peak
10	9792.658	18.25	25.35	43.60	54.00	-10.40	AVG
11	14388.105	27.43	30.82	58.25	74.00	-15.75	peak
12	14388.105	17.38	30.82	48.20	54.00	-5.80	AVG

Project No.:	ZJ00038221	Polarziation:	Vertical
Standard:	(RE)FCC PART 15 class B 3m	Power Source:	AC 120V/60Hz
Test item:	Radiation Test	Date:	2013-12-19
Temp./Hum.(%RH):	23/57%RH	Time:	17:50:43
EUT:	EPON ONU	Distance:	3m
Model:	ONT-2-E4021iWn	Test Result:	Pass
Note:	WIFI-n20-2412		

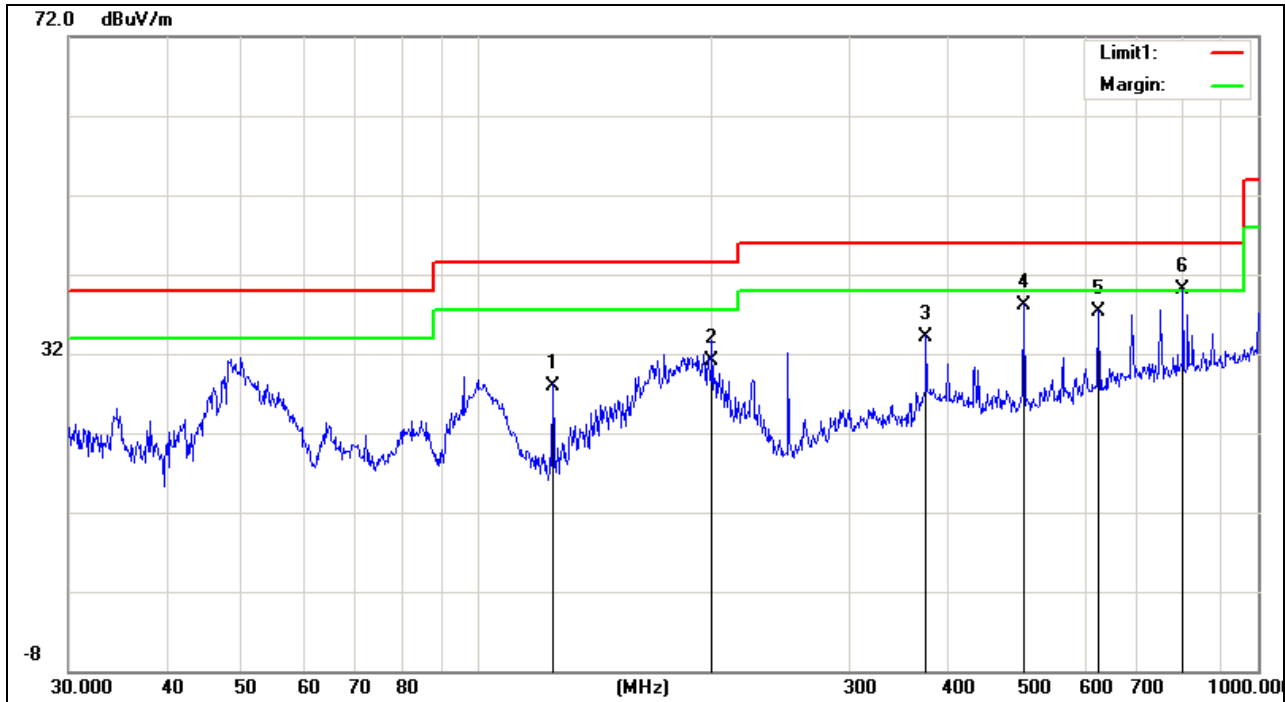

No.	Frequency (MHz)	Reading (dBuV/m)	Correct Factor(dB/m)	Result (dBuV/m)	Limit (dBuV/m)	Margin (dB)	Remark
1	125.0066	19.14	8.76	27.90	43.50	-15.60	QP
2	199.9856	19.82	11.38	31.20	43.50	-12.30	QP
3	375.9385	16.38	17.72	34.10	46.00	-11.90	QP
4	501.1790	18.40	19.80	38.20	46.00	-7.80	QP
5	625.0780	14.57	22.83	37.40	46.00	-8.60	QP
6	801.7863	15.02	25.08	40.10	46.00	-5.90	QP

Emission from 9 kHz to 30MHz:

No.	Frequency (MHz)	Reading (dBuV/m)	Correct Factor(dB/m)	Result (dBuV/m)	Limit (dBuV/m)	Margin (dB)	Remark
1	0.0349	21.01	21.22	42.23	116.61	-74.38	QP
2	0.1602	10.35	20.83	31.18	103.45	-72.27	QP
3	0.3738	11.44	20.89	32.33	96.13	-63.80	QP
4	2.4980	6.64	21.10	27.74	69.50	-41.76	QP
5	7.1820	4.82	21.14	25.96	69.50	-43.54	QP
6	19.3140	-1.28	21.84	20.56	69.50	-48.94	QP

Emission above 1GHz:

No.	Frequency (MHz)	Reading (dBuV/m)	Correct Factor(dB/m)	Result (dBuV/m)	Limit (dBuV/m)	Margin (dB)	Remark
1	1781.536	36.66	13.23	49.89	74.00	-24.11	peak
2	1781.536	25.27	13.23	38.50	54.00	-15.50	AVG
3	2087.421	35.97	14.56	50.53	74.00	-23.47	peak
4	2087.421	24.24	14.56	38.80	54.00	-15.20	AVG
5	2989.455	36.37	23.66	60.03	74.00	-13.97	peak
6	2989.455	25.84	23.66	49.50	54.00	-4.50	AVG
7	8102.073	28.71	23.46	52.17	74.00	-21.83	peak
8	8102.073	18.24	23.46	41.70	54.00	-12.30	AVG
9	11079.578	28.25	24.86	53.11	74.00	-20.89	peak
10	11079.578	18.24	24.86	43.10	54.00	-10.90	AVG
11	15503.386	28.32	30.83	59.15	74.00	-14.85	peak
12	15503.386	18.17	30.83	49.00	54.00	-5.00	AVG

Project No.:	ZJ00038221	Polarziation:	Horizontal
Standard:	(RE)FCC PART 15 class B 3m	Power Source:	AC 120V/60Hz
Test item:	Radiation Test	Date:	2013-12-19
Temp./Hum.(%RH):	23/57%RH	Time:	17:08:52
EUT:	EPON ONU	Distance:	3m
Model:	ONT-2-E4021iWn	Test Result:	Pass
Note:	WIFI-n20-2412		

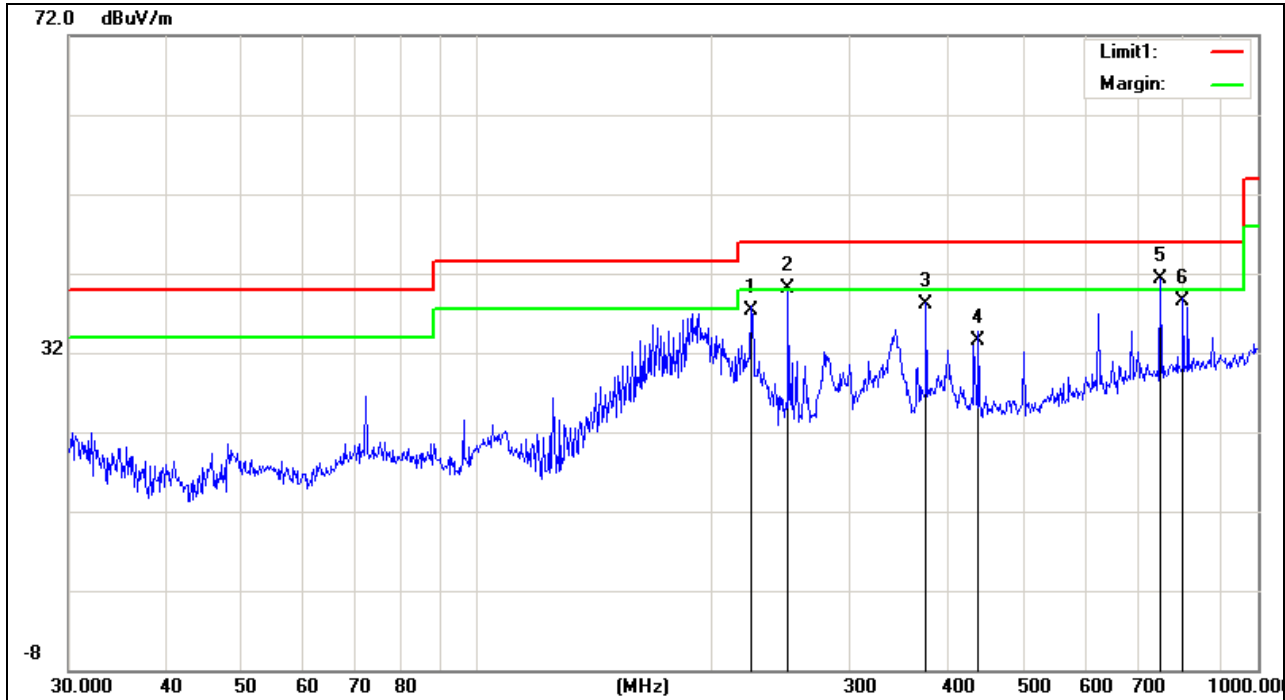

No.	Frequency (MHz)	Reading (dBuV/m)	Correct Factor(dB/m)	Result (dBuV/m)	Limit (dBuV/m)	Margin (dB)	Remark
1	224.5192	24.67	12.73	37.40	46.00	-8.60	QP
2	250.3011	26.52	13.68	40.20	46.00	-5.80	QP
3	375.9384	20.48	17.72	38.20	46.00	-7.80	QP
4	438.6553	14.86	18.64	33.50	46.00	-12.50	QP
5	750.1082	17.09	24.21	41.30	46.00	-4.70	QP
6	801.7862	13.42	25.08	38.50	46.00	-7.50	QP

Emission above 1GHz:

No.	Frequency (MHz)	Reading (dBuV/m)	Correct Factor(dB/m)	Result (dBuV/m)	Limit (dBuV/m)	Margin (dB)	Remark
1	1904.803	41.09	13.72	54.81	74.00	-19.19	peak
2	1904.803	25.18	13.72	38.90	54.00	-15.10	AVG
3	1962.675	36.55	13.92	50.47	74.00	-23.53	peak
4	1962.675	25.48	13.92	39.40	54.00	-14.60	AVG
5	2947.644	36.49	23.09	59.58	74.00	-14.42	peak
6	2947.644	25.71	23.09	48.80	54.00	-5.20	AVG
7	4790.583	31.57	16.06	47.63	74.00	-26.37	peak
8	4790.583	19.54	16.06	35.60	54.00	-18.40	AVG
9	10582.070	29.01	24.66	53.67	74.00	-20.33	peak
10	10582.070	18.24	24.66	42.90	54.00	-11.10	AVG
11	14807.235	27.80	31.17	58.97	74.00	-15.03	peak
12	14807.235	17.53	31.17	48.70	54.00	-5.30	AVG

Project No.:	ZJ00038221	Polarization:	Vertical
Standard:	(RE)FCC PART 15 class B 3m	Power Source:	AC 120V/60Hz
Test item:	Radiation Test	Date:	2013-12-19
Temp./Hum.(%RH):	23/57%RH	Time:	17:51:53
EUT:	EPON ONU	Distance:	3m
Model:	ONT-2-E4021iWn	Test Result:	Pass
Note:	WIFI-n20-2437		

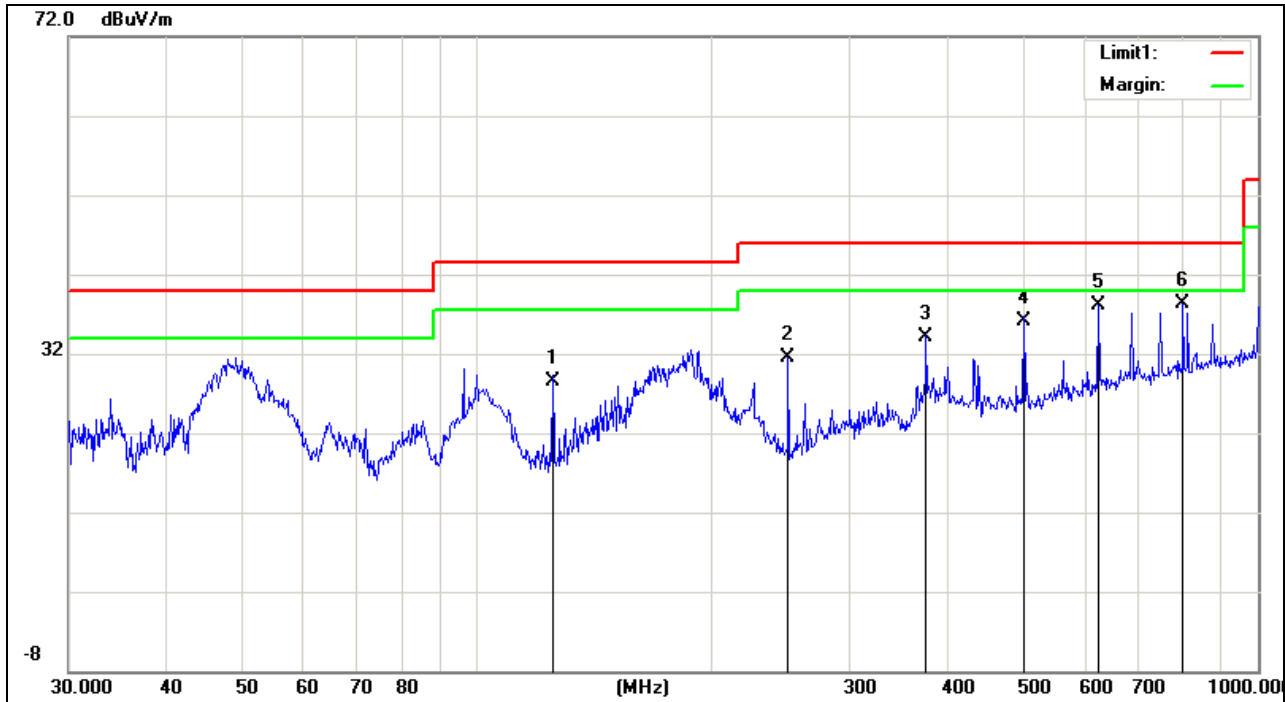

No.	Frequency (MHz)	Reading (dBuV/m)	Correct Factor(dB/m)	Result (dBuV/m)	Limit (dBuV/m)	Margin (dB)	Remark
1	125.0066	19.84	8.76	28.60	43.50	-14.90	QP
2	250.3012	17.82	13.68	31.50	46.00	-14.50	QP
3	375.9385	16.38	17.72	34.10	46.00	-11.90	QP
4	501.1790	16.40	19.80	36.20	46.00	-9.80	QP
5	625.0780	15.27	22.83	38.10	46.00	-7.90	QP
6	801.7863	13.22	25.08	38.30	46.00	-7.70	QP

Emission from 9 kHz to 30MHz:

No.	Frequency (MHz)	Reading (dBuV/m)	Correct Factor(dB/m)	Result (dBuV/m)	Limit (dBuV/m)	Margin (dB)	Remark
1	0.0349	20.35	21.22	41.57	116.61	-75.04	QP
2	0.1683	11.40	20.83	32.23	103.02	-70.79	QP
3	0.4218	10.17	20.90	31.07	95.09	-64.02	QP
4	2.2259	6.77	21.09	27.86	69.50	-41.64	QP
5	7.3658	4.75	21.14	25.89	69.50	-43.61	QP
6	19.3140	2.37	21.84	24.21	69.50	-45.29	QP

Emission above 1GHz:

No.	Frequency (MHz)	Reading (dBuV/m)	Correct Factor(dB/m)	Result (dBuV/m)	Limit (dBuV/m)	Margin (dB)	Remark
1	1908.159	36.07	13.73	49.80	74.00	-24.20	peak
2	1908.159	25.17	13.73	38.90	54.00	-15.10	AVG
3	2870.819	34.45	22.02	56.47	74.00	-17.53	peak
4	2870.819	24.68	22.02	46.70	54.00	-7.30	AVG
5	2952.838	35.61	23.15	58.76	74.00	-15.24	peak
6	2952.838	25.75	23.15	48.90	54.00	-5.10	AVG
7	5001.426	29.55	16.78	46.33	74.00	-27.67	peak
8	5001.426	19.62	16.78	36.40	54.00	-17.60	AVG
9	8125.371	29.63	23.51	53.14	74.00	-20.86	peak
10	8125.371	18.89	23.51	42.40	54.00	-11.60	AVG
11	14021.041	28.37	30.14	58.51	74.00	-15.49	peak
12	14021.041	17.86	30.14	48.00	54.00	-6.00	AVG

Project No.:	ZJ00038221	Polarziation:	Horizontal
Standard:	(RE)FCC PART 15 class B 3m	Power Source:	AC 120V/60Hz
Test item:	Radiation Test	Date:	2013-12-19
Temp./Hum.(%RH):	23/57%RH	Time:	17:10:03
EUT:	EPON ONU	Distance:	3m
Model:	ONT-2-E4021iWn	Test Result:	Pass
Note:	WIFI-n20-2437		

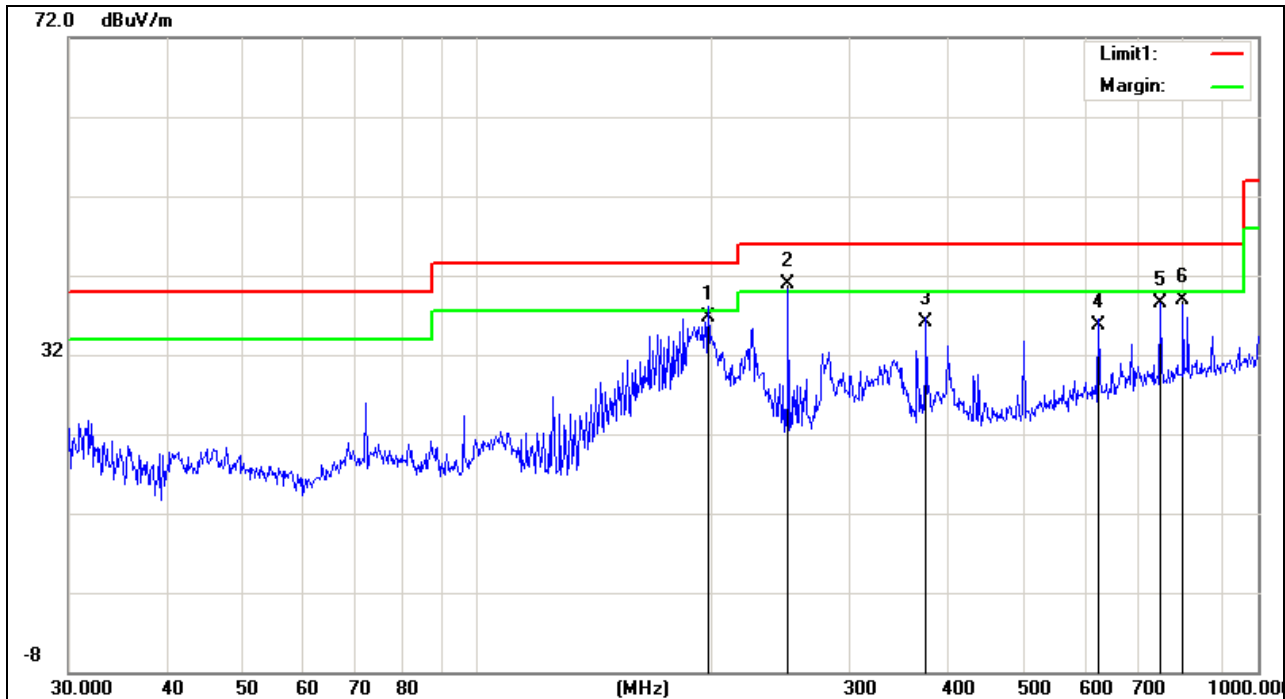

No.	Frequency (MHz)	Reading (dBuV/m)	Correct Factor(dB/m)	Result (dBuV/m)	Limit (dBuV/m)	Margin (dB)	Remark
1	197.8928	25.31	11.39	36.70	43.50	-6.80	QP
2	250.3012	27.22	13.68	40.90	46.00	-5.10	QP
3	375.9385	18.48	17.72	36.20	46.00	-9.80	QP
4	625.0780	12.97	22.83	35.80	46.00	-10.20	QP
5	750.1083	14.29	24.21	38.50	46.00	-7.50	QP
6	801.7863	13.82	25.08	38.90	46.00	-7.10	QP

Emission above 1GHz:

No.	Frequency (MHz)	Reading (dBuV/m)	Correct Factor(dB/m)	Result (dBuV/m)	Limit (dBuV/m)	Margin (dB)	Remark
1	1955.776	36.56	13.90	50.46	74.00	-23.54	peak
2	1955.776	25.40	13.90	39.30	54.00	-14.70	AVG
3	2275.497	34.96	15.66	50.62	74.00	-23.38	peak
4	2275.497	23.24	15.66	38.90	54.00	-15.10	AVG
5	2937.283	35.53	22.94	58.47	74.00	-15.53	peak
6	2937.283	25.56	22.94	48.50	54.00	-5.50	AVG
7	8805.626	27.17	24.22	51.39	74.00	-22.61	peak
8	8805.626	17.78	24.22	42.00	54.00	-12.00	AVG
9	12180.790	27.33	25.67	53.00	74.00	-21.00	peak
10	12180.790	17.93	25.67	43.60	54.00	-10.40	AVG
11	14935.339	27.37	31.23	58.60	74.00	-15.40	peak
12	14935.339	17.57	31.23	48.80	54.00	-5.20	AVG

Project No.:	ZJ00038221	Polarziation:	Vertical
Standard:	(RE)FCC PART 15 class B 3m	Power Source:	AC 120V/60Hz
Test item:	Radiation Test	Date:	2013-12-19
Temp./Hum.(%RH):	23/57%RH	Time:	17:53:08
EUT:	EPON ONU	Distance:	3m
Model:	ONT-2-E4021iWn	Test Result:	Pass
Note:	WIFI-n20-2462		

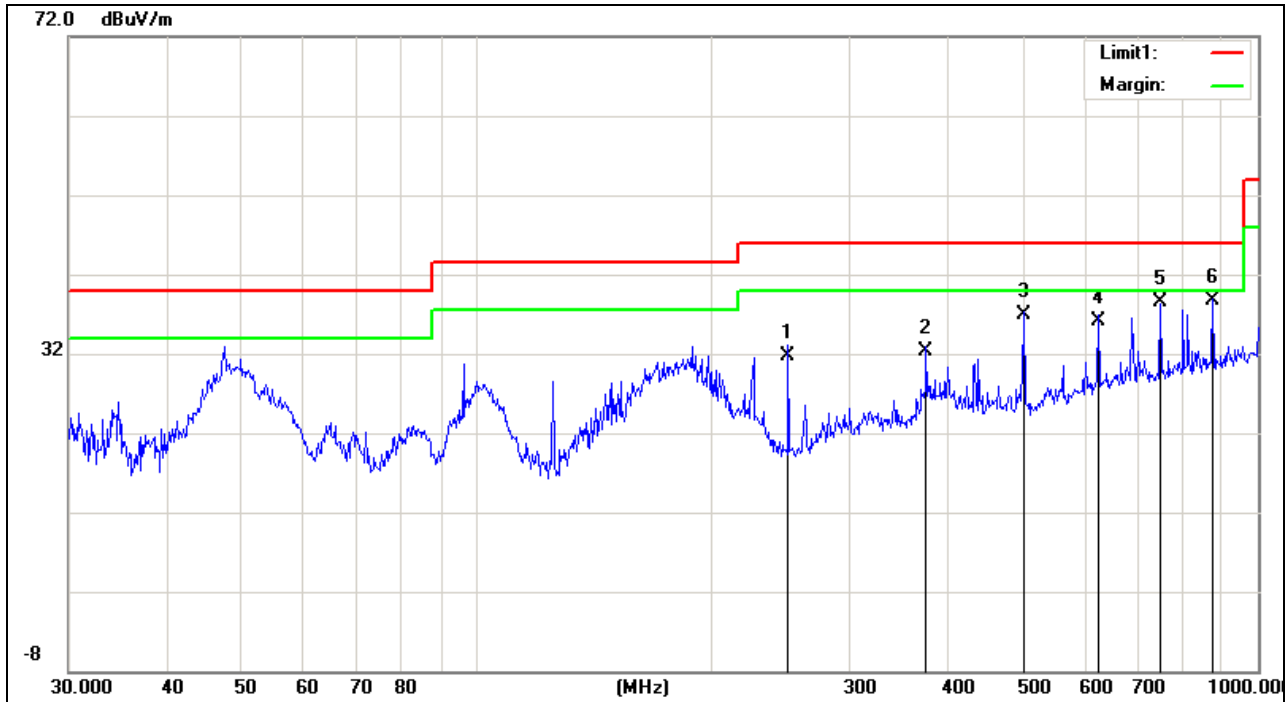

No.	Frequency (MHz)	Reading (dBuV/m)	Correct Factor(dB/m)	Result (dBuV/m)	Limit (dBuV/m)	Margin (dB)	Remark
1	250.3012	18.02	13.68	31.70	46.00	-14.30	QP
2	375.9385	14.58	17.72	32.30	46.00	-13.70	QP
3	501.1790	17.10	19.80	36.90	46.00	-9.10	QP
4	625.0780	13.37	22.83	36.20	46.00	-9.80	QP
5	750.1083	14.39	24.21	38.60	46.00	-7.40	QP
6	875.2470	13.11	25.59	38.70	46.00	-7.30	QP

Emission from 9 kHz to 30MHz:

No.	Frequency (MHz)	Reading (dBuV/m)	Correct Factor(dB/m)	Result (dBuV/m)	Limit (dBuV/m)	Margin (dB)	Remark
1	0.0349	20.13	21.22	41.35	116.61	-75.26	QP
2	0.2500	10.82	20.85	31.67	99.61	-67.94	QP
3	0.3339	10.00	20.87	30.87	97.11	-66.24	QP
4	3.0819	5.89	21.13	27.02	69.50	-42.48	QP
5	7.0300	5.22	21.14	26.36	69.50	-43.14	QP
6	19.3140	1.49	21.84	23.33	69.50	-46.17	QP

Emission above 1GHz:

No.	Frequency (MHz)	Reading (dBuV/m)	Correct Factor(dB/m)	Result (dBuV/m)	Limit (dBuV/m)	Margin (dB)	Remark
1	1790.970	36.79	13.29	50.08	74.00	-23.92	peak
2	1790.970	25.21	13.29	38.50	54.00	-15.50	AVG
3	1959.223	36.00	13.91	49.91	74.00	-24.09	peak
4	1959.223	25.39	13.91	39.30	54.00	-14.70	AVG
5	2840.653	34.76	21.59	56.35	74.00	-17.65	peak
6	2840.653	24.01	21.59	45.60	54.00	-8.40	AVG
7	6365.683	30.02	18.18	48.20	74.00	-25.80	peak
8	6365.683	19.52	18.18	37.70	54.00	-16.30	AVG
9	10461.223	28.63	24.70	53.33	74.00	-20.67	peak
10	10461.223	18.60	24.70	43.30	54.00	-10.70	AVG
11	14183.010	27.30	30.45	57.75	74.00	-16.25	peak
12	14183.010	17.75	30.45	48.20	54.00	-5.80	AVG

Project No.:	ZJ00038221	Polarziation:	Horizontal
Standard:	(RE)FCC PART 15 class B 3m	Power Source:	AC 120V/60Hz
Test item:	Radiation Test	Date:	2013-12-19
Temp./Hum.(%RH):	23/57%RH	Time:	17:11:26
EUT:	EPON ONU	Distance:	3m
Model:	ONT-2-E4021iWn	Test Result:	Pass
Note:	WIFI-n20-2462		

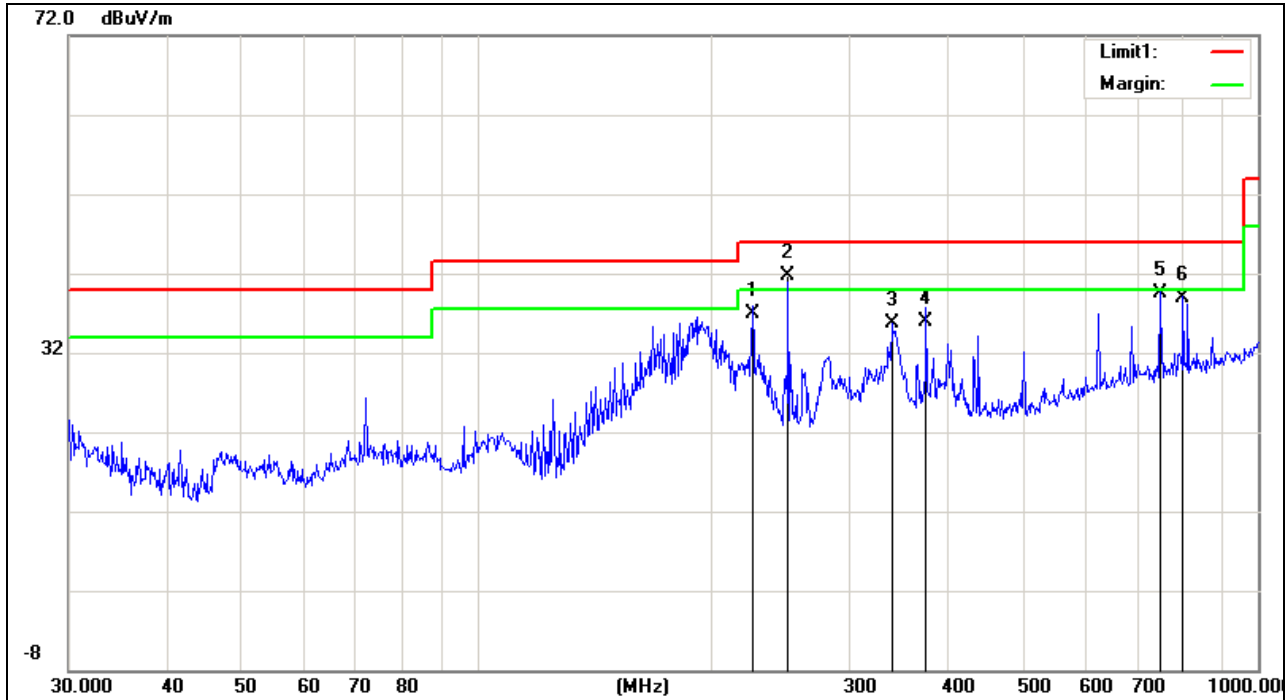

No.	Frequency (MHz)	Reading (dBuV/m)	Correct Factor(dB/m)	Result (dBuV/m)	Limit (dBuV/m)	Margin (dB)	Remark
1	225.3080	24.14	12.76	36.90	46.00	-9.10	QP
2	250.3012	28.02	13.68	41.70	46.00	-4.30	QP
3	339.5888	18.84	16.96	35.80	46.00	-10.20	QP
4	375.9385	18.18	17.72	35.90	46.00	-10.10	QP
5	750.1083	15.29	24.21	39.50	46.00	-6.50	QP
6	801.7863	13.82	25.08	38.90	46.00	-7.10	QP

Emission above 1GHz:

No.	Frequency (MHz)	Reading (dBuV/m)	Correct Factor(dB/m)	Result (dBuV/m)	Limit (dBuV/m)	Margin (dB)	Remark
1	1794.126	36.70	13.30	50.00	74.00	-24.00	peak
2	1794.126	25.20	13.30	38.50	54.00	-15.50	AVG
3	2324.084	35.15	15.94	51.09	74.00	-22.91	peak
4	2324.084	23.56	15.94	39.50	54.00	-14.50	AVG
5	2958.042	36.01	23.22	59.23	74.00	-14.77	peak
6	2958.042	25.78	23.22	49.00	54.00	-5.00	AVG
7	5873.919	28.52	17.41	45.93	74.00	-28.07	peak
8	5873.919	19.19	17.41	36.60	54.00	-17.40	AVG
9	8386.111	28.62	24.01	52.63	74.00	-21.37	peak
10	8386.111	17.89	24.01	41.90	54.00	-12.10	AVG
11	14101.793	26.95	30.29	57.24	74.00	-16.76	peak
12	14101.793	17.71	30.29	48.00	54.00	-6.00	AVG

Project No.:	ZJ00038221	Polarization:	Vertical
Standard:	(RE)FCC PART 15 class B 3m	Power Source:	AC 120V/60Hz
Test item:	Radiation Test	Date:	2013-12-19
Temp./Hum.(%RH):	23/57%RH	Time:	17:54:15
EUT:	EPON ONU	Distance:	3m
Model:	ONT-2-E4021iWn	Test Result:	Pass
Note:	WIFI-n40-2422		

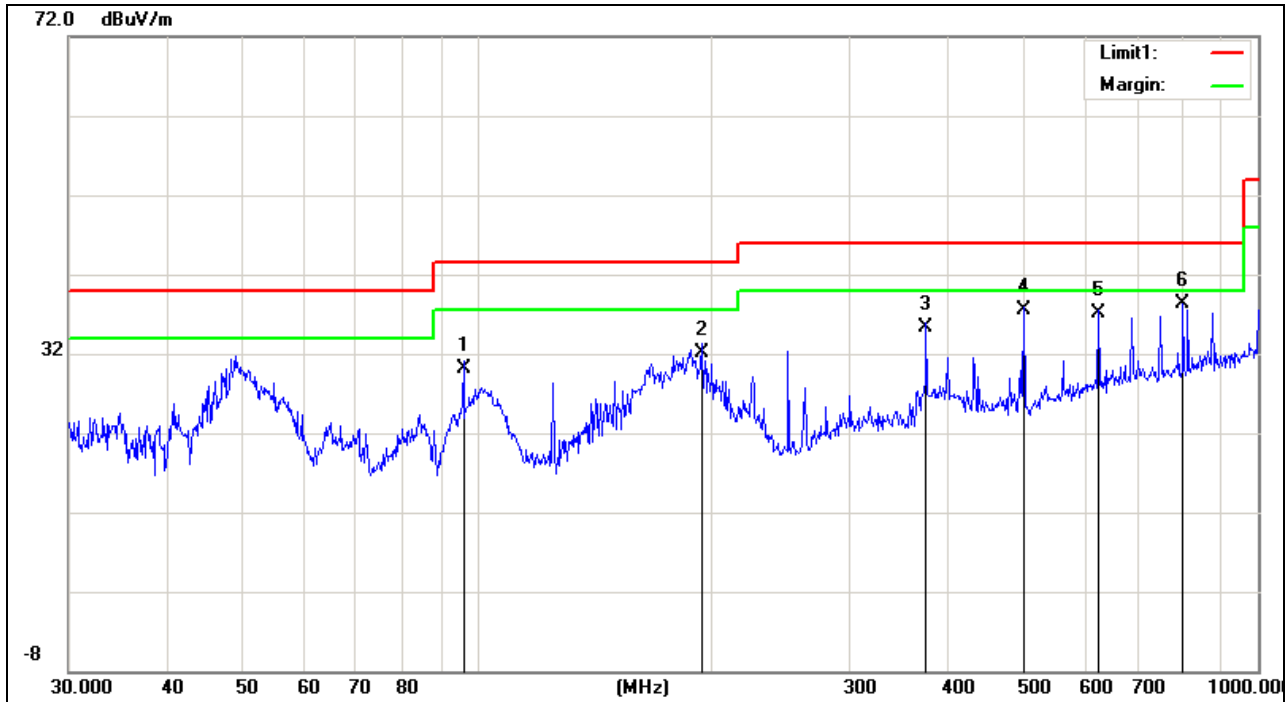

No.	Frequency (MHz)	Reading (dBuV/m)	Correct Factor(dB/m)	Result (dBuV/m)	Limit (dBuV/m)	Margin (dB)	Remark
1	96.0986	20.23	9.87	30.10	43.50	-13.40	QP
2	193.7727	20.67	11.43	32.10	43.50	-11.40	QP
3	375.9384	17.58	17.72	35.30	46.00	-10.70	QP
4	501.1789	17.70	19.80	37.50	46.00	-8.50	QP
5	625.0779	14.37	22.83	37.20	46.00	-8.80	QP
6	801.7862	13.22	25.08	38.30	46.00	-7.70	QP

Emission from 9 kHz to 30MHz:

No.	Frequency (MHz)	Reading (dBuV/m)	Correct Factor(dB/m)	Result (dBuV/m)	Limit (dBuV/m)	Margin (dB)	Remark
1	0.0349	20.13	21.22	41.35	116.61	-75.26	QP
2	0.1527	12.05	20.83	32.88	103.86	-70.98	QP
3	0.2584	9.97	20.85	30.82	99.32	-68.50	QP
4	2.8980	6.62	21.12	27.74	69.50	-41.76	QP
5	5.6420	5.88	21.16	27.04	69.50	-42.46	QP
6	19.3140	2.28	21.84	24.12	69.50	-45.38	QP

Emission above 1GHz:

No.	Frequency (MHz)	Reading (dBuV/m)	Correct Factor(dB/m)	Result (dBuV/m)	Limit (dBuV/m)	Margin (dB)	Remark
1	1790.970	36.28	13.29	49.57	74.00	-24.43	peak
2	1790.970	25.21	13.29	38.50	54.00	-15.50	AVG
3	1973.069	36.00	13.97	49.97	74.00	-24.03	peak
4	1973.069	25.53	13.97	39.50	54.00	-14.50	AVG
5	2911.540	34.98	22.58	57.56	74.00	-16.44	peak
6	2911.540	24.82	22.58	47.40	54.00	-6.60	AVG
7	7738.264	29.39	22.34	51.73	74.00	-22.27	peak
8	7738.264	18.16	22.34	40.50	54.00	-13.50	AVG
9	9680.827	28.78	25.17	53.95	74.00	-20.05	peak
10	9680.827	18.43	25.17	43.60	54.00	-10.40	AVG
11	15238.575	27.85	31.05	58.90	74.00	-15.10	peak
12	15238.575	18.15	31.05	49.20	54.00	-4.80	AVG

Project No.:	ZJ00038221	Polarziation:	Horizontal
Standard:	(RE)FCC PART 15 class B 3m	Power Source:	AC 120V/60Hz
Test item:	Radiation Test	Date:	2013-12-19
Temp./Hum.(%RH):	23/57%RH	Time:	17:12:44
EUT:	EPON ONU	Distance:	3m
Model:	ONT-2-E4021iWn	Test Result:	Pass
Note:	WIFI-n40-2422		

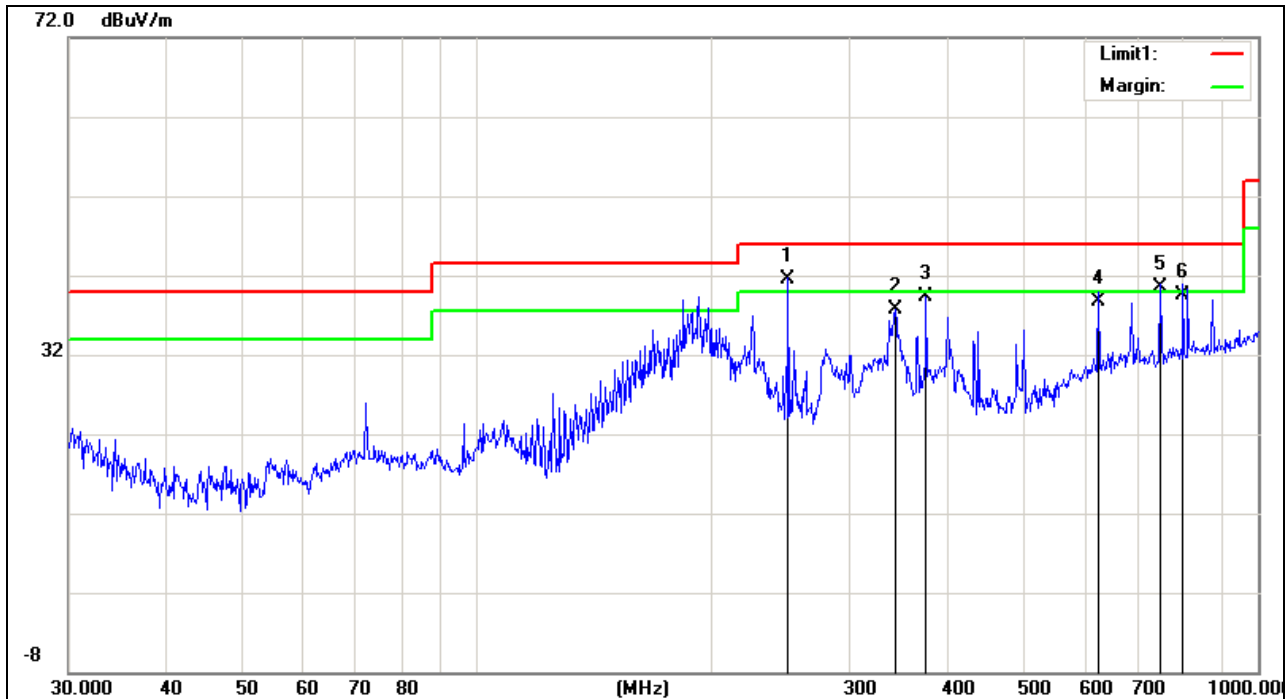

No.	Frequency (MHz)	Reading (dBuV/m)	Correct Factor(dB/m)	Result (dBuV/m)	Limit (dBuV/m)	Margin (dB)	Remark
1	250.3012	27.82	13.68	41.50	46.00	-4.50	QP
2	343.1800	20.73	17.07	37.80	46.00	-8.20	QP
3	375.9385	21.68	17.72	39.40	46.00	-6.60	QP
4	625.0780	15.97	22.83	38.80	46.00	-7.20	QP
5	750.1083	16.29	24.21	40.50	46.00	-5.50	QP
6	801.7863	14.42	25.08	39.50	46.00	-6.50	QP

Emission above 1GHz:

No.	Frequency (MHz)	Reading (dBuV/m)	Correct Factor(dB/m)	Result (dBuV/m)	Limit (dBuV/m)	Margin (dB)	Remark
1	1701.823	36.07	12.78	48.85	74.00	-25.15	peak
2	1701.823	25.22	12.78	38.00	54.00	-16.00	AVG
3	1969.599	36.30	13.96	50.26	74.00	-23.74	peak
4	1969.599	25.44	13.96	39.40	54.00	-14.60	AVG
5	2958.042	36.00	23.22	59.22	74.00	-14.78	peak
6	2958.042	25.78	23.22	49.00	54.00	-5.00	AVG
7	5206.578	31.09	16.60	47.69	74.00	-26.31	peak
8	5206.578	19.50	16.60	36.10	54.00	-17.90	AVG
9	8125.371	29.52	23.51	53.03	74.00	-20.97	peak
10	8125.371	18.89	23.51	42.40	54.00	-11.60	AVG
11	10253.053	28.66	25.15	53.81	74.00	-20.19	peak
12	10253.053	18.35	25.15	43.50	54.00	-10.50	AVG

Project No.:	ZJ00038221	Polarziation:	Vertical
Standard:	(RE)FCC PART 15 class B 3m	Power Source:	AC 120V/60Hz
Test item:	Radiation Test	Date:	2013-12-19
Temp./Hum.(%RH):	23/57%RH	Time:	17:54:53
EUT:	EPON ONU	Distance:	3m
Model:	ONT-2-E4021iWn	Test Result:	Pass
Note:	WIFI-n40-2437		

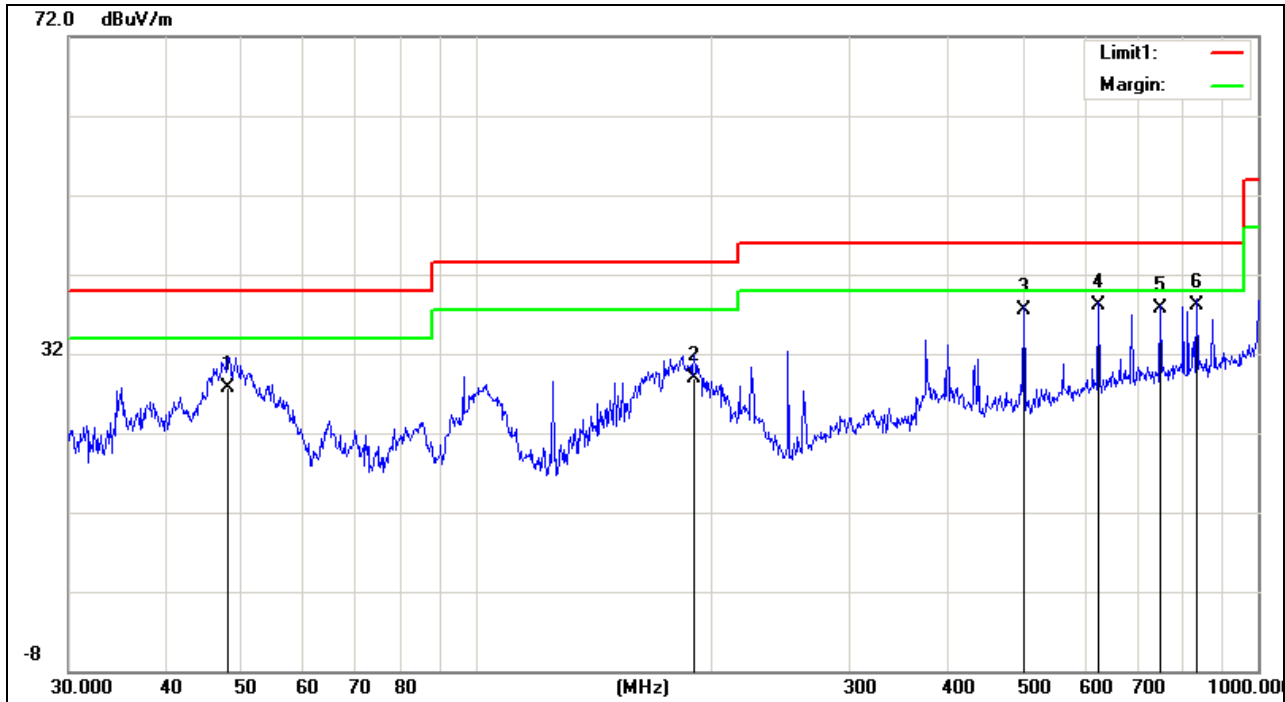

No.	Frequency (MHz)	Reading (dBuV/m)	Correct Factor(dB/m)	Result (dBuV/m)	Limit (dBuV/m)	Margin (dB)	Remark
1	47.9939	17.34	10.46	27.80	40.00	-12.20	QP
2	189.7384	17.44	11.46	28.90	43.50	-14.60	QP
3	501.1789	17.70	19.80	37.50	46.00	-8.50	QP
4	625.0779	15.27	22.83	38.10	46.00	-7.90	QP
5	750.1082	13.59	24.21	37.80	46.00	-8.20	QP
6	836.2441	12.96	25.24	38.20	46.00	-7.80	QP

Emission from 9 kHz to 30MHz:

No.	Frequency (MHz)	Reading (dBuV/m)	Correct Factor(dB/m)	Result (dBuV/m)	Limit (dBuV/m)	Margin (dB)	Remark
1	0.0349	20.10	21.22	41.32	116.61	-75.29	QP
2	0.1710	11.81	20.84	32.65	102.89	-70.24	QP
3	0.3462	12.05	20.87	32.92	96.80	-63.88	QP
4	1.0780	9.50	21.03	30.53	66.97	-36.44	QP
5	2.5178	5.24	21.11	26.35	69.50	-43.15	QP
6	19.3140	1.70	21.84	23.54	69.50	-45.96	QP

Emission above 1GHz:

No.	Frequency (MHz)	Reading (dBuV/m)	Correct Factor(dB/m)	Result (dBuV/m)	Limit (dBuV/m)	Margin (dB)	Remark
1	1716.870	36.51	12.87	49.38	74.00	-24.62	peak
2	1716.870	25.13	12.87	38.00	54.00	-16.00	AVG
3	2033.016	35.52	14.26	49.78	74.00	-24.22	peak
4	2033.016	24.14	14.26	38.40	54.00	-15.60	AVG
5	2952.838	36.15	23.15	59.30	74.00	-14.70	peak
6	2952.838	25.75	23.15	48.90	54.00	-5.10	AVG
7	5873.919	28.99	17.41	46.40	74.00	-27.60	peak
8	5873.919	19.19	17.41	36.60	54.00	-17.40	AVG
9	8410.225	28.04	24.07	52.11	74.00	-21.89	peak
10	8410.225	18.13	24.07	42.20	54.00	-11.80	AVG
11	15107.870	27.21	31.17	58.38	74.00	-15.62	peak
12	15107.870	17.73	31.17	48.90	54.00	-5.10	AVG

Project No.:	ZJ00038221	Polarziation:	Horizontal
Standard:	(RE)FCC PART 15 class B 3m	Power Source:	AC 120V/60Hz
Test item:	Radiation Test	Date:	2013-12-19
Temp./Hum.(%RH):	23/57%RH	Time:	17:14:19
EUT:	EPON ONU	Distance:	3m
Model:	ONT-2-E4021iWn	Test Result:	Pass
Note:	WIFI-n40-2437		

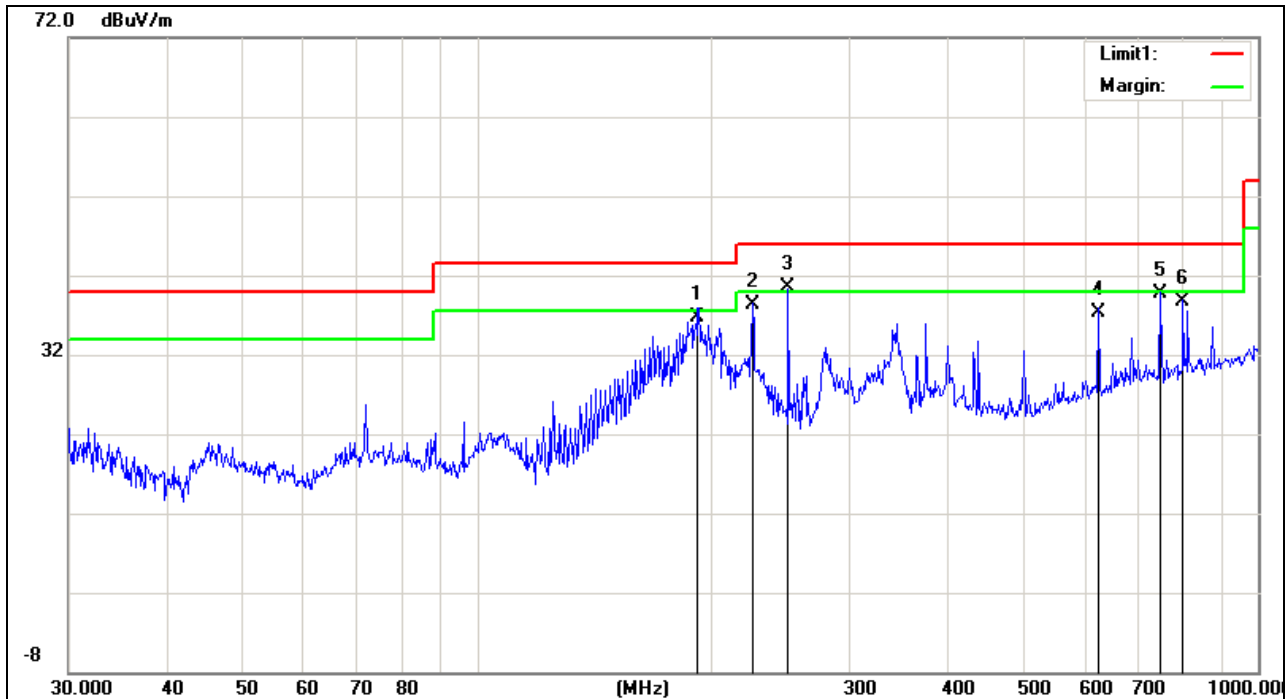

No.	Frequency (MHz)	Reading (dBuV/m)	Correct Factor(dB/m)	Result (dBuV/m)	Limit (dBuV/m)	Margin (dB)	Remark
1	191.7450	25.25	11.45	36.70	43.50	-6.80	QP
2	225.3080	25.64	12.76	38.40	46.00	-7.60	QP
3	250.3012	26.92	13.68	40.60	46.00	-5.40	QP
4	625.0780	14.57	22.83	37.40	46.00	-8.60	QP
5	750.1083	15.59	24.21	39.80	46.00	-6.20	QP
6	801.7863	13.72	25.08	38.80	46.00	-7.20	QP

Emission above 1GHz:

No.	Frequency (MHz)	Reading (dBuV/m)	Correct Factor(dB/m)	Result (dBuV/m)	Limit (dBuV/m)	Margin (dB)	Remark
1	1976.546	36.43	13.97	50.40	74.00	-23.60	peak
2	1976.546	25.53	13.97	39.50	54.00	-14.50	AVG
3	2267.499	34.75	15.61	50.36	74.00	-23.64	peak
4	2267.499	23.99	15.61	39.60	54.00	-14.40	AVG
5	2947.644	36.50	23.09	59.59	74.00	-14.41	peak
6	2947.644	25.71	23.09	48.80	54.00	-5.20	AVG
7	7738.264	28.40	22.34	50.74	74.00	-23.26	peak
8	7738.264	18.56	22.34	40.90	54.00	-13.10	AVG
9	10582.070	28.19	24.66	52.85	74.00	-21.15	peak
10	10582.070	18.24	24.66	42.90	54.00	-11.10	AVG
11	15772.800	28.05	31.08	59.13	74.00	-14.87	peak
12	15772.800	18.02	31.08	49.10	54.00	-4.90	AVG

Project No.:	ZJ00038221	Polarziation:	Vertical
Standard:	(RE)FCC PART 15 class B 3m	Power Source:	AC 120V/60Hz
Test item:	Radiation Test	Date:	2013-12-19
Temp./Hum.(%RH):	23/57%RH	Time:	17:55:45
EUT:	EPON ONU	Distance:	3m
Model:	ONT-2-E4021iWn	Test Result:	Pass
Note:	WIFI-n40-2452		

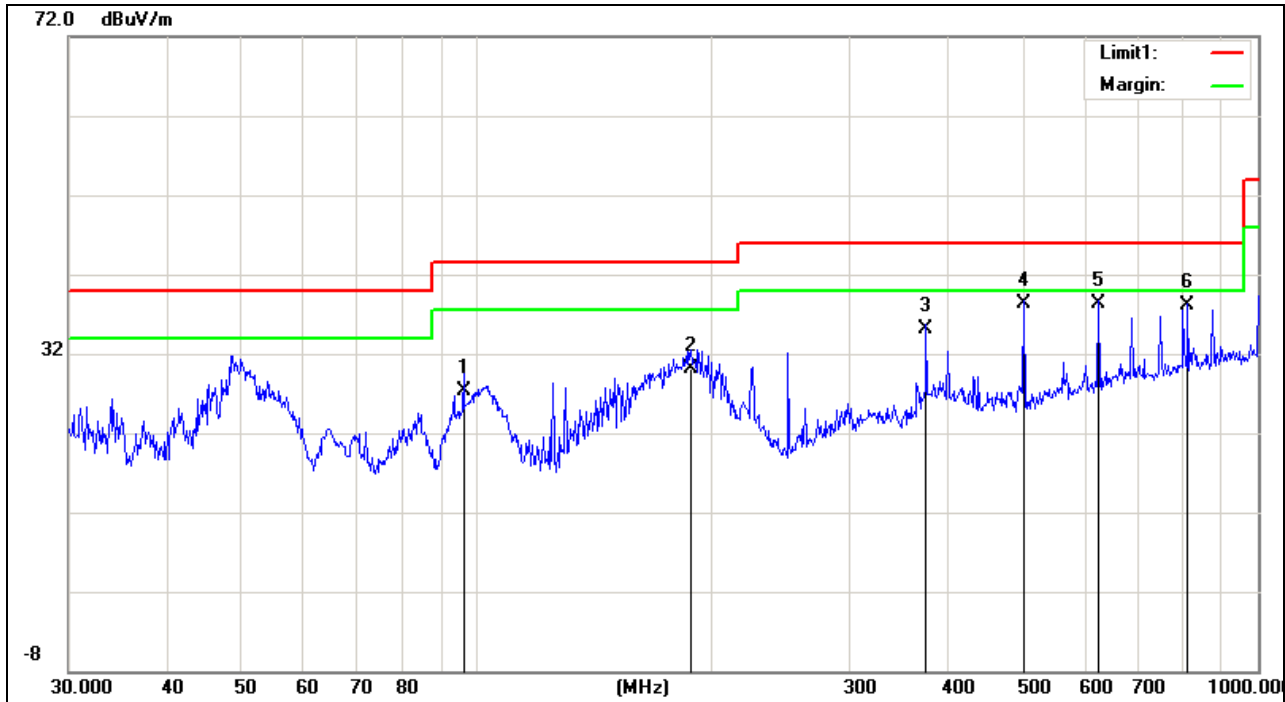

No.	Frequency (MHz)	Reading (dBuV/m)	Correct Factor(dB/m)	Result (dBuV/m)	Limit (dBuV/m)	Margin (dB)	Remark
1	96.0986	17.43	9.87	27.30	43.50	-16.20	QP
2	187.7529	18.72	11.38	30.10	43.50	-13.40	QP
3	375.9384	17.48	17.72	35.20	46.00	-10.80	QP
4	501.1789	18.50	19.80	38.30	46.00	-7.70	QP
5	625.0779	15.57	22.83	38.40	46.00	-7.60	QP
6	813.1115	12.91	25.19	38.10	46.00	-7.90	QP

Emission from 9 kHz to 30MHz:

No.	Frequency (MHz)	Reading (dBuV/m)	Correct Factor(dB/m)	Result (dBuV/m)	Limit (dBuV/m)	Margin (dB)	Remark
1	0.0349	20.99	21.22	42.21	116.61	-74.40	QP
2	0.1794	10.39	20.84	31.23	102.47	-71.24	QP
3	0.3351	9.90	20.87	30.77	97.08	-66.31	QP
4	2.5299	7.20	21.11	28.31	69.50	-41.19	QP
5	7.4020	4.31	21.13	25.44	69.50	-44.06	QP
6	19.3140	1.02	21.84	22.86	69.50	-46.64	QP

Emission above 1GHz:

No.	Frequency (MHz)	Reading (dBuV/m)	Correct Factor(dB/m)	Result (dBuV/m)	Limit (dBuV/m)	Margin (dB)	Remark
1	1829.211	35.92	13.44	49.36	74.00	-24.64	peak
2	1829.211	25.26	13.44	38.70	54.00	-15.30	AVG
3	2208.401	35.08	15.26	50.34	74.00	-23.66	peak
4	2208.401	23.64	15.26	38.90	54.00	-15.10	AVG
5	2947.644	35.24	23.09	58.33	74.00	-15.67	peak
6	2947.644	25.71	23.09	48.80	54.00	-5.20	AVG
7	8125.371	30.32	23.51	53.83	74.00	-20.17	peak
8	8125.371	18.89	23.51	42.40	54.00	-11.60	AVG
9	9515.470	28.35	24.89	53.24	74.00	-20.76	peak
10	9515.470	18.31	24.89	43.20	54.00	-10.80	AVG
11	12975.086	27.78	28.16	55.94	74.00	-18.06	peak
12	12975.086	17.74	28.16	45.90	54.00	-8.10	AVG

Project No.:	ZJ00038221	Polarziation:	Horizontal
Standard:	(RE)FCC PART 15 class B 3m	Power Source:	AC 120V/60Hz
Test item:	Radiation Test	Date:	2013-12-19
Temp./Hum.(%RH):	23/57%RH	Time:	17:16:44
EUT:	EPON ONU	Distance:	3m
Model:	ONT-2-E4021iWn	Test Result:	Pass
Note:	WIFI-n40-2452		

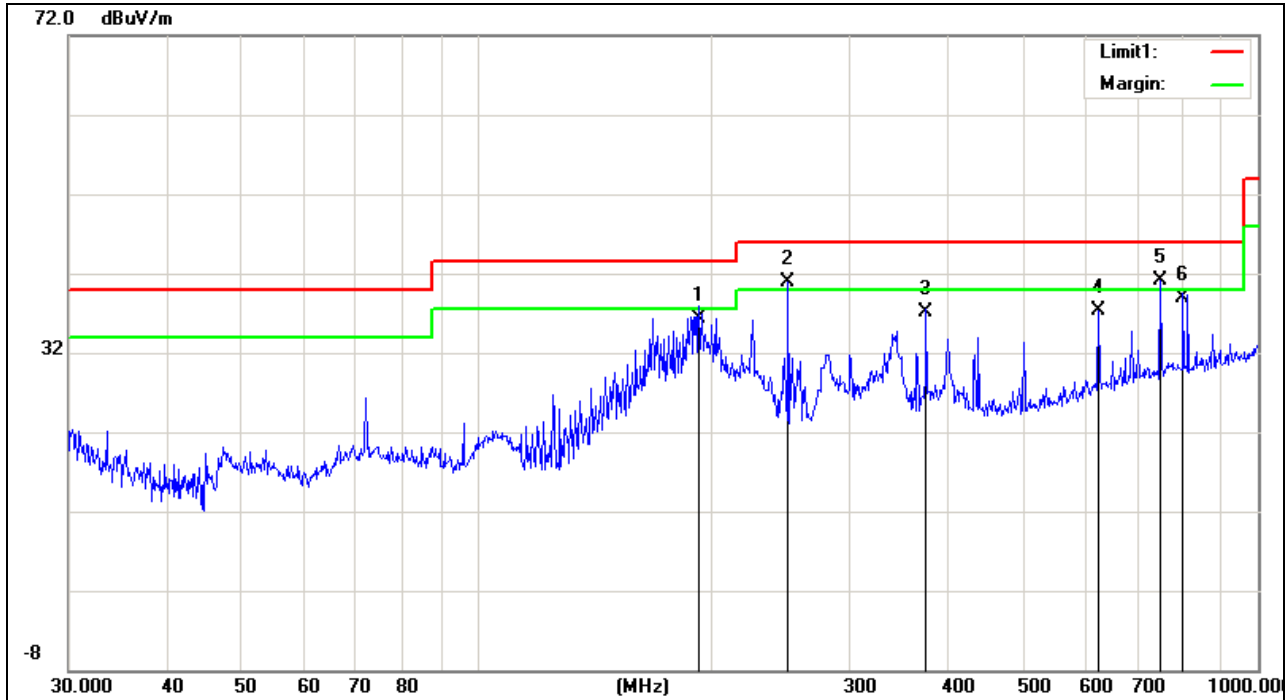

No.	Frequency (MHz)	Reading (dBuV/m)	Correct Factor(dB/m)	Result (dBuV/m)	Limit (dBuV/m)	Margin (dB)	Remark
1	192.4186	24.96	11.44	36.40	43.50	-7.10	QP
2	250.3012	27.22	13.68	40.90	46.00	-5.10	QP
3	375.9385	19.48	17.72	37.20	46.00	-8.80	QP
4	625.0780	14.57	22.83	37.40	46.00	-8.60	QP
5	750.1083	16.89	24.21	41.10	46.00	-4.90	QP
6	801.7863	13.82	25.08	38.90	46.00	-7.10	QP

Emission above 1GHz:

No.	Frequency (MHz)	Reading (dBuV/m)	Correct Factor(dB/m)	Result (dBuV/m)	Limit (dBuV/m)	Margin (dB)	Remark
1	1772.151	36.64	13.19	49.83	74.00	-24.17	peak
2	1772.151	25.41	13.19	38.60	54.00	-15.40	AVG
3	2072.772	35.11	14.49	49.60	74.00	-24.40	peak
4	2072.772	24.51	14.49	39.00	54.00	-15.00	AVG
5	2906.418	34.86	22.51	57.37	74.00	-16.63	peak
6	2906.418	24.89	22.51	47.40	54.00	-6.60	AVG
7	8009.548	29.14	23.28	52.42	74.00	-21.58	peak
8	8009.548	18.82	23.28	42.10	54.00	-11.90	AVG
9	10194.340	29.46	25.28	54.74	74.00	-19.26	peak
10	10194.340	18.32	25.28	43.60	54.00	-10.40	AVG
11	15326.339	28.13	30.98	59.11	74.00	-14.89	peak
12	15370.410	18.26	30.94	49.20	54.00	-4.80	AVG

7. 6dB BANDWIDTH TESTING

7.1 LIMITS

Systems using digital modulation techniques may operate in the 902–928 MHz, 2400–2483.5 MHz, and 5725–5850 MHz bands. The minimum 6 dB bandwidth shall be at least 500 kHz.

7.2 TEST PROCEDURES

Test procedures follow ANSI C63.4:2009 and KDB 558074 D01 DTS Measurement Guidance v03r01.

1. Check the calibration of the measuring instrument using either an internal calibrator or a known signal from an external generator.
2. Position the EUT without connection to measurement instrument. Turn on the EUT and connect it to measurement instrument. Then set it to any one convenient frequency within its operating range. Set a reference level on the measuring instrument equal to the highest peak value.
3. Set resolution bandwidth (RBW) = 100kHz. Set the video bandwidth (VBW) $\geq 3 \times$ RBW. Detector = Peak. Trace mode = max hold. Sweep = auto couple. Allow the trace to stabilize.
4. Measure the maximum width of the emission that is constrained by the frequencies associated with the two outermost amplitude points (upper and lower) that are attenuated by 6 dB relative to the maximum level measured in the fundamental emission. Compare the resultant bandwidth with the RBW setting of the analyzer.
5. Repeat above procedures until all frequencies measured were complete.

7.3 TEST SETUP

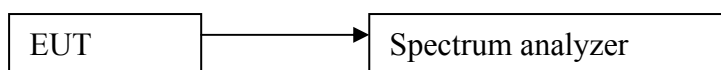

7.4 TEST RESULTS

Channel	Channel Frequency (MHz)	Data Rate (Mbps)	6dB Bandwidth (MHz)	Limit (kHz)
802.11b Mode				
Low Channel	2412	11	8.40	> 500
Middle Channel	2437	11	8.32	> 500
High Channel	2462	11	8.72	> 500

802.11b mode:
Channel 2412MHz



Ref 20 dBm Att 40 dB SWT 5 ms
*RBW 100 kHz Marker 1 [T1]
*VBW 300 kHz -2.05 dBm
2.407760000 GHz

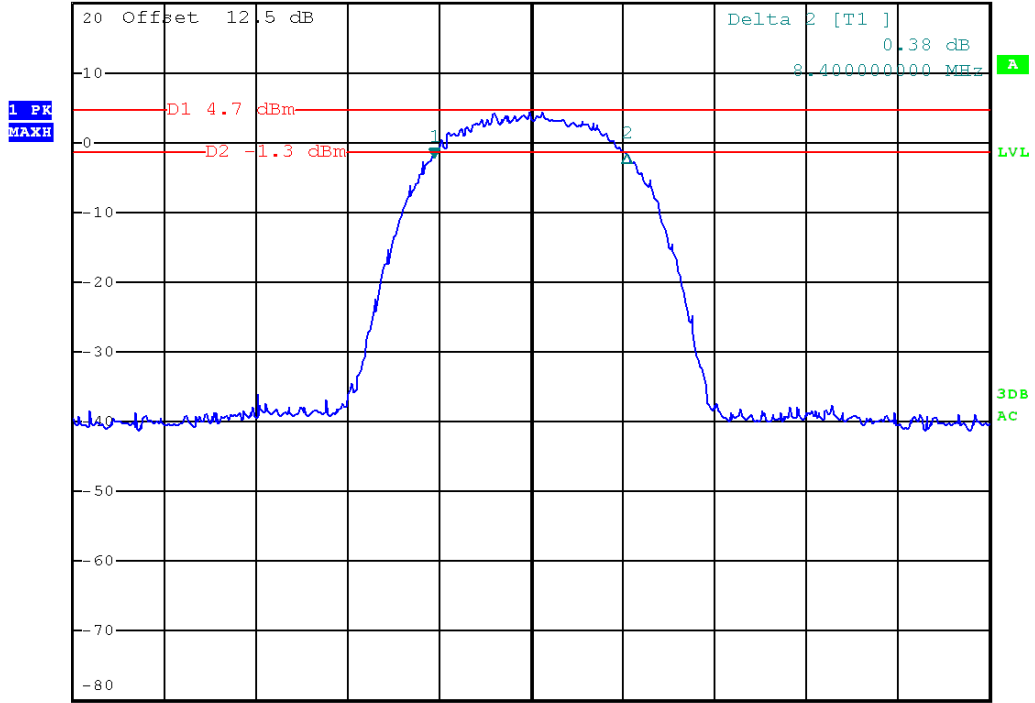

Center 2.412 GHz 4 MHz/ Span 40 MHz

Channel 2437MHz



Ref 20 dBm Att 40 dB SWT 5 ms
*RBW 100 kHz Delta 2 [T1]
*VBW 300 kHz -2.12 dBm
8.320000000 MHz

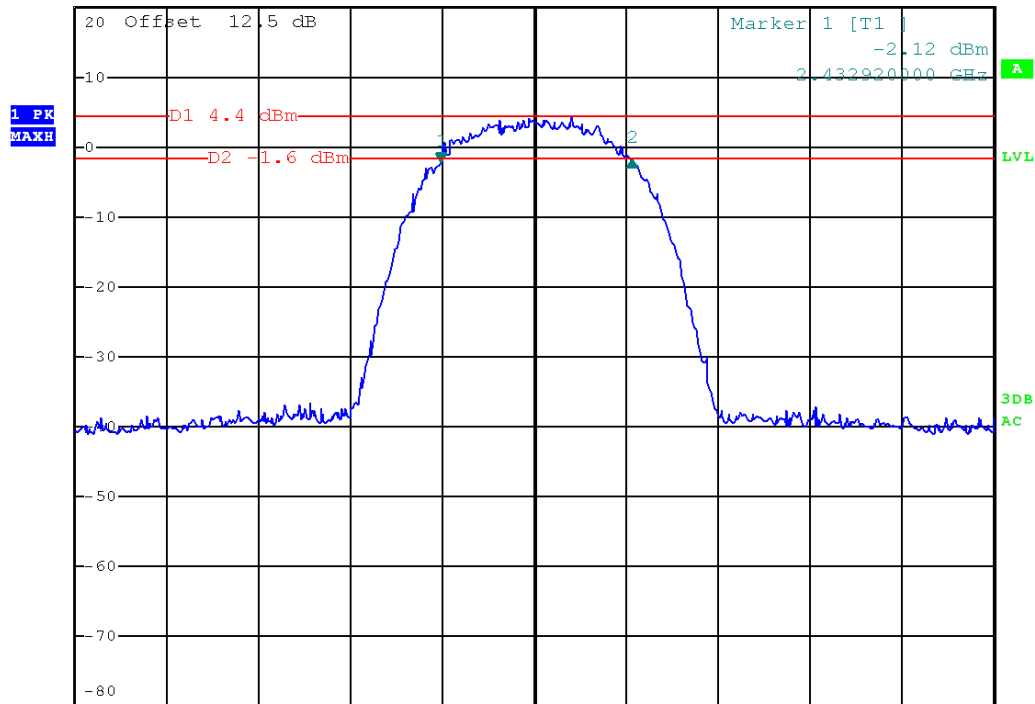

Center 2.437 GHz 4 MHz/ Span 40 MHz

Channel 2462MHz



*RBW 100 kHz Marker 1 [T1]
*VBW 300 kHz -2.05 dBm
SWT 5 ms 2.457280000 GHz

Ref 20 dBm Att 40 dB

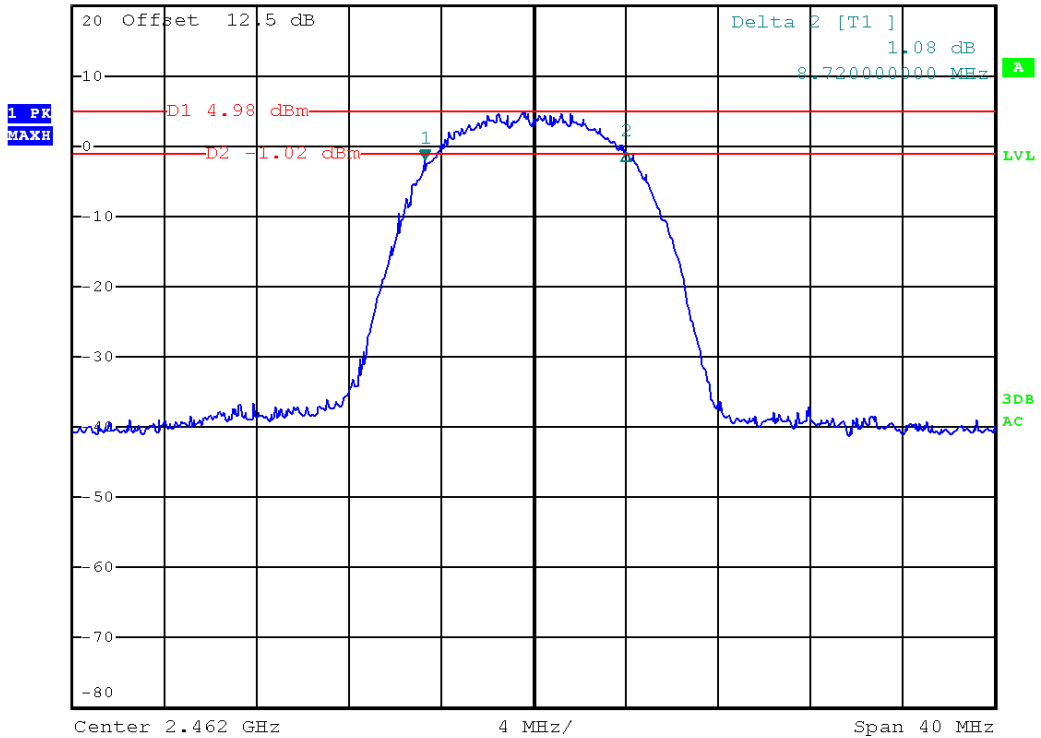

Channel	Channel Frequency (MHz)	Data Rate (Mbps)	6dB Bandwidth (MHz)	Limit (kHz)
802.11g Mode				
Low Channel	2412	54	15.92	>500
Middle Channel	2437	54	15.76	>500
High Channel	2462	54	16.04	>500

802.11g mode:
Channel 2412MHz

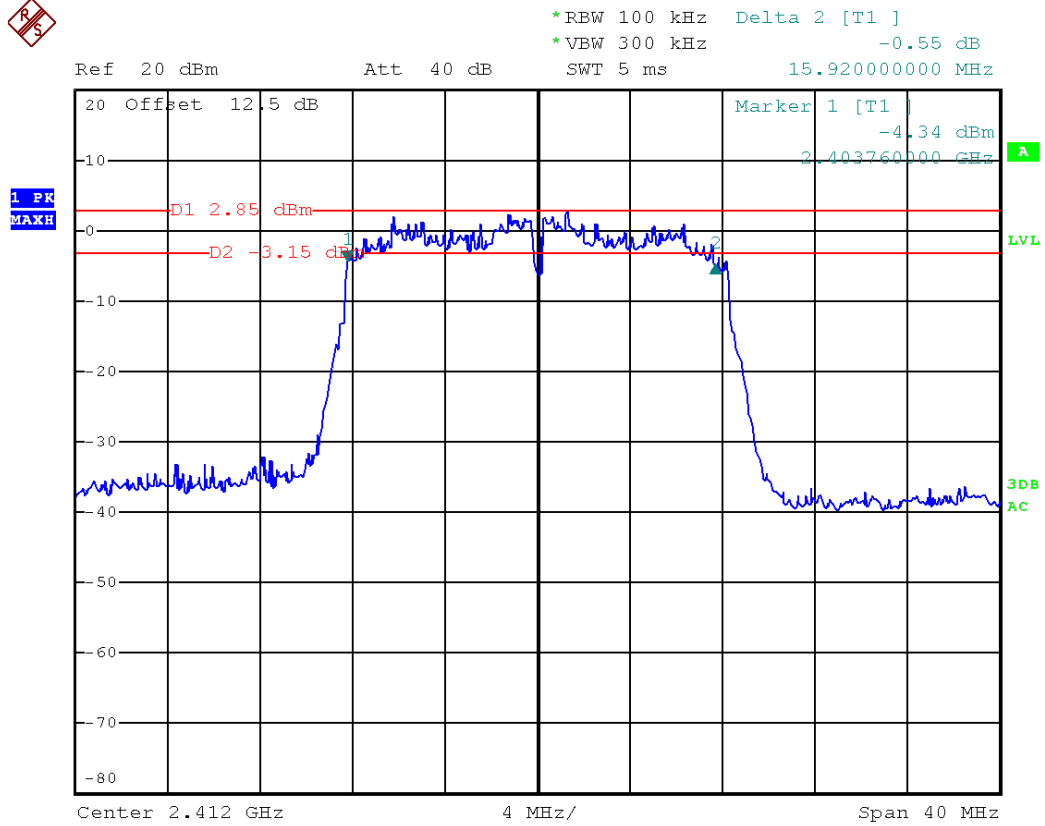

Channel 2437MHz

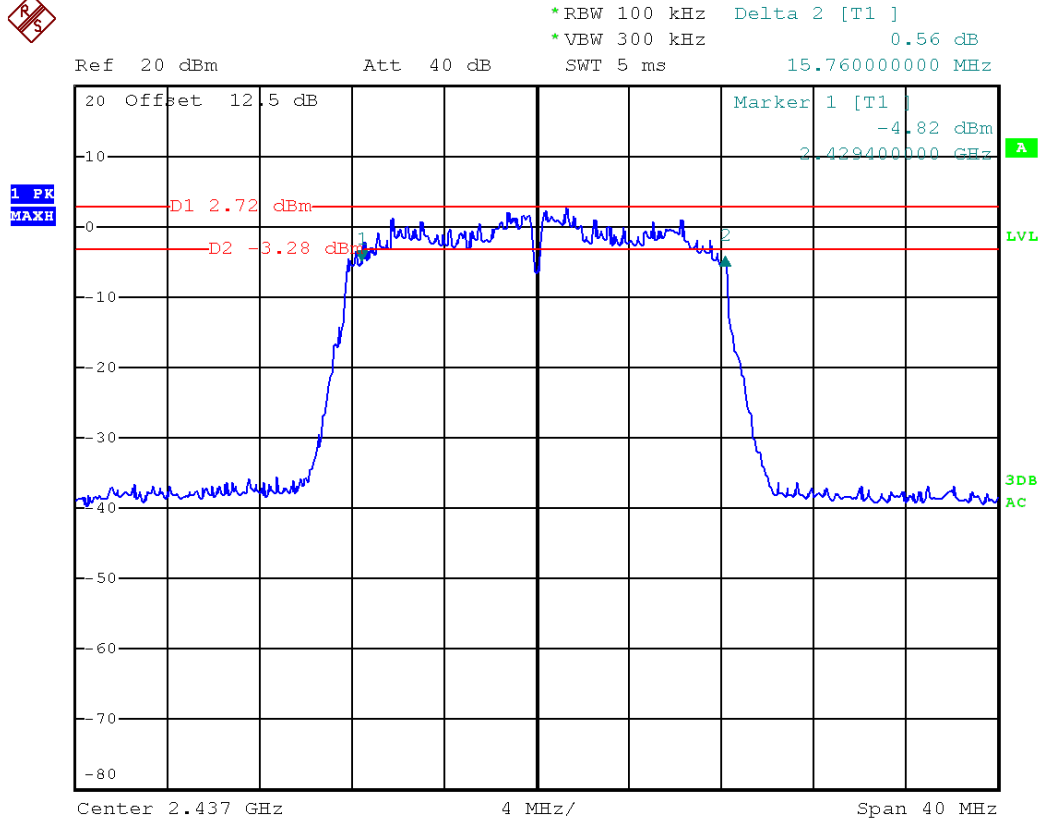

Channel 2462MHz

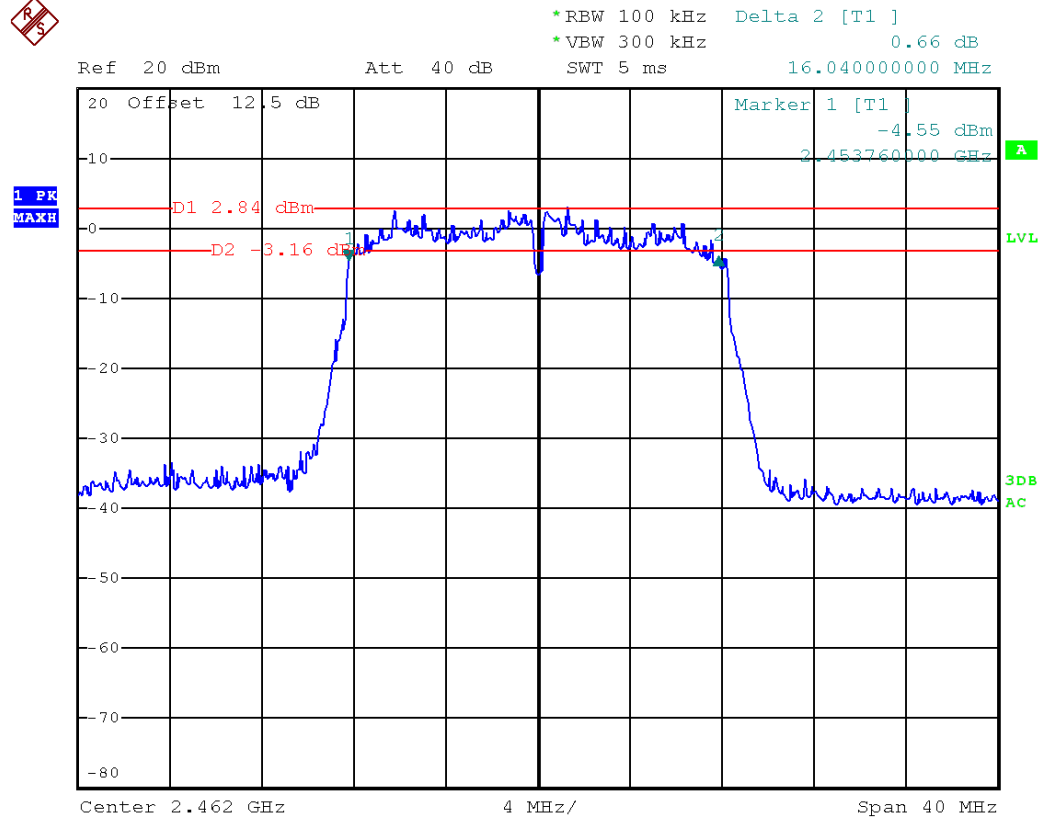

Channel	Channel Frequency (MHz)	Data Rate (Mbps)	6dB Bandwidth (MHz)	Limit (kHz)
802.11n20 Mode				
Low Channel	2412	MCS7	16.96	>500
Middle Channel	2437	MCS7	16.80	>500
High Channel	2462	MCS7	16.92	>500

802.11n20 mode:
Channel 2412MHz

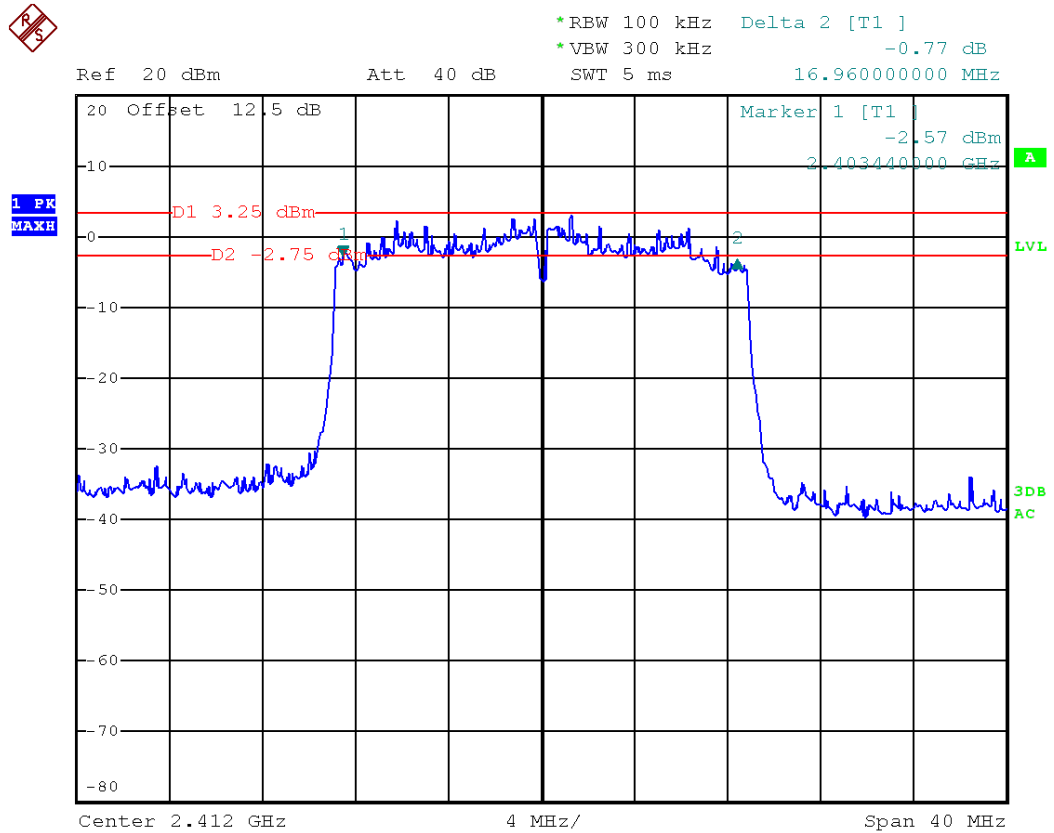

Channel 2437MHz

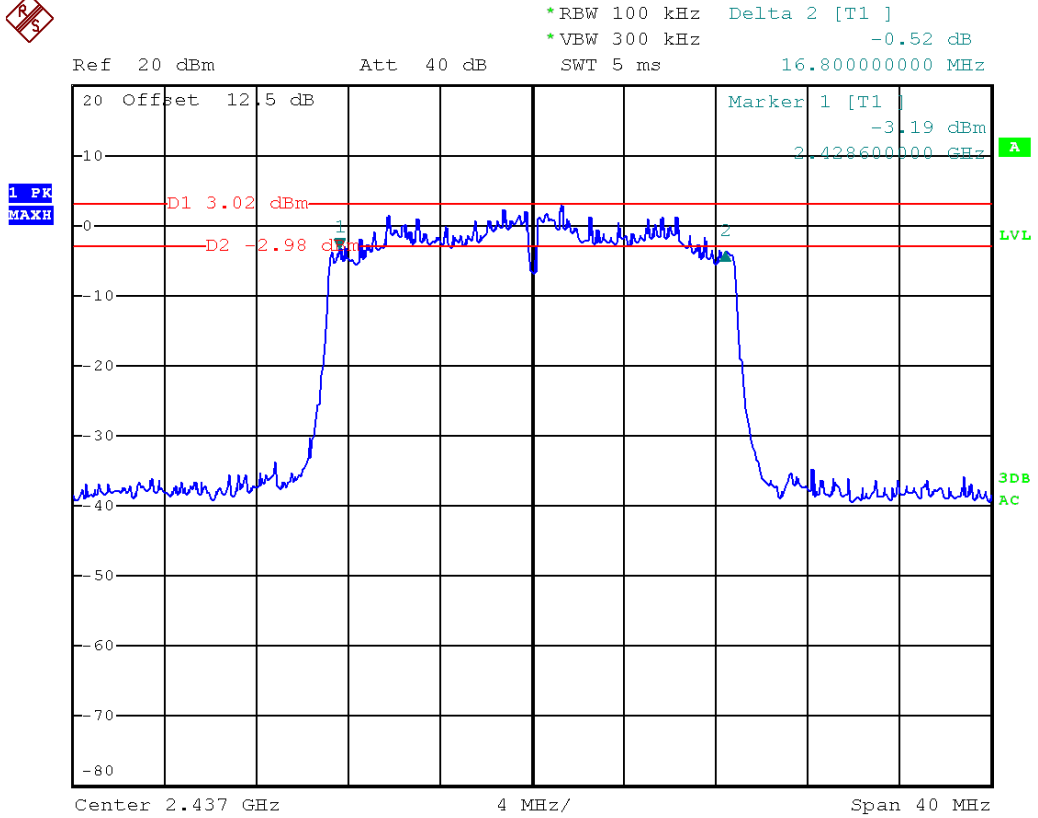

Channel 2462MHz

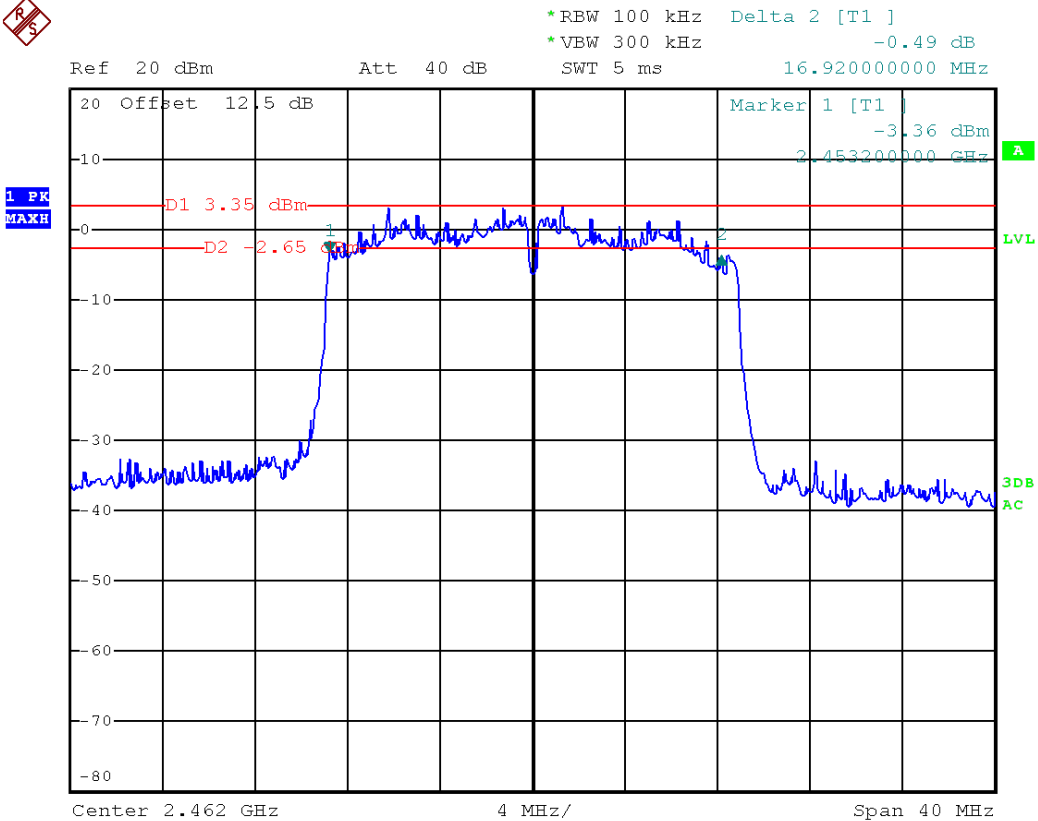

Channel	Channel Frequency (MHz)	Data Rate (Mbps)	6dB Bandwidth (MHz)	Limit (kHz)
802.11n40 Mode				
Low Channel	2422	MCS15	36.80	>500
Middle Channel	2437	MCS15	36.84	>500
High Channel	2452	MCS15	36.80	>500

802.11n40 mode:
Channel 2422MHz

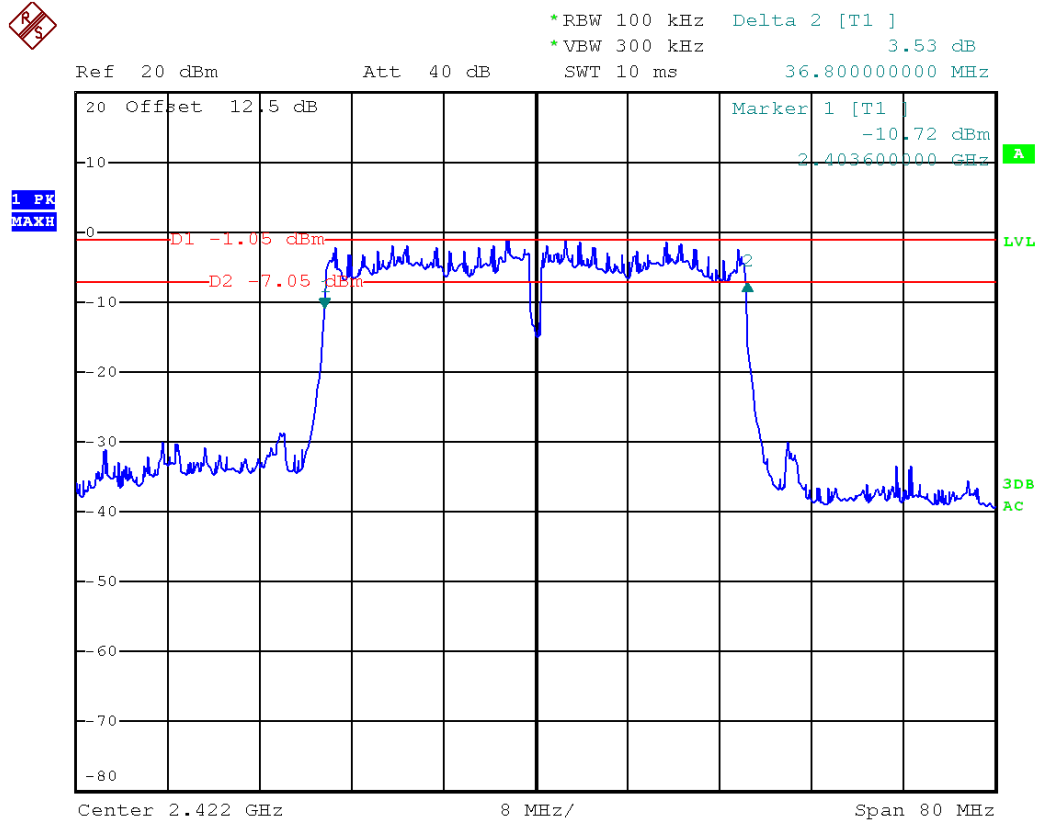

Channel 2437MHz

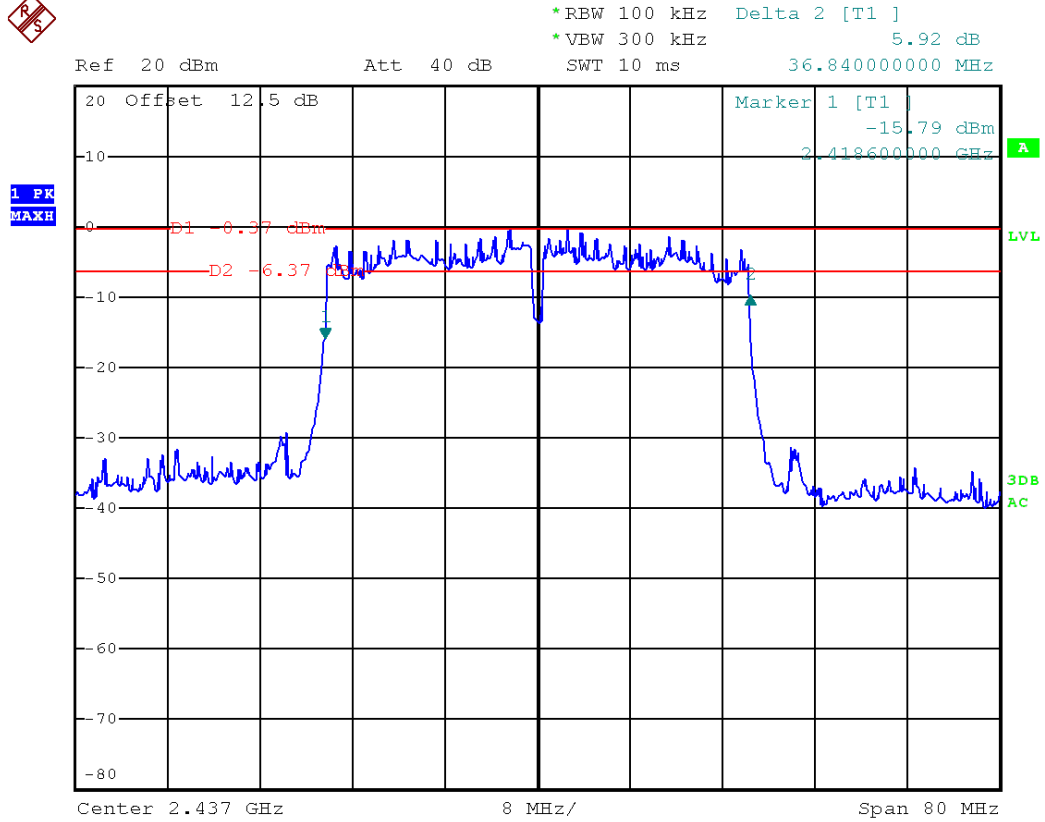

Channel 2452MHz

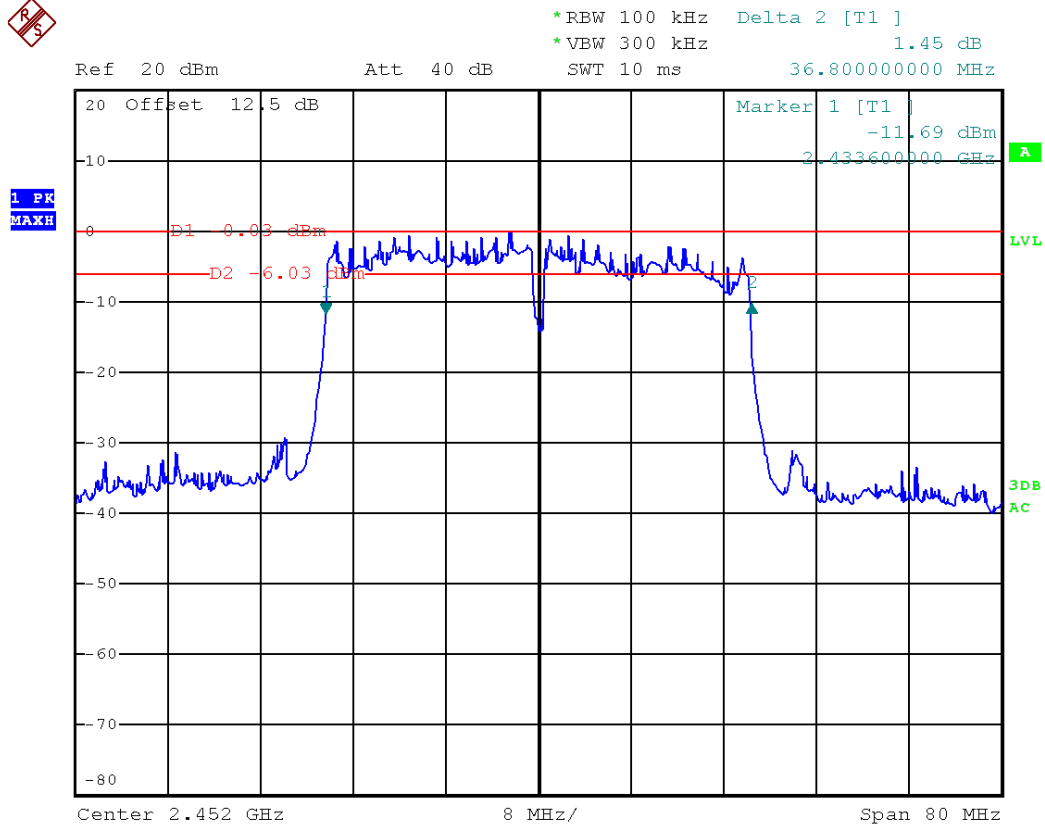

8. MAXIMUM PEAK OUTPUT POWER

8.1 LIMITS

The maximum Peak output power measurement is 1W

8.2 TEST PROCEDURES

Test procedures follow KDB 558074 D01 DTS Measurement Guidance v03r01.

1. Place the EUT on a bench and set it in transmitting mode.
2. Remove the antenna from the EUT and then connect a low loss RF cable from the antenna port to an EMI Test Receiver.
3. The spectrum analyzer resolution bandwidth that is \leq EBW. So we test the Maximum Conducted Output Power — Integrated band power method.
4. Set the analyzer span \geq 1.5 x DTS bandwidth. Set the RBW = 1 MHz. Set the VBW \geq 3 MHz. Sweep time = auto couple. Detector = peak. Allow trace to fully stabilize.

8.3 TEST SETUP

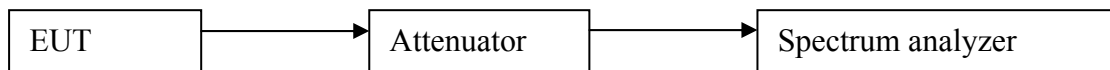

8.4 TEST RESULTS

802.11b Mode:

Channel No.	Frequency (MHz)	Mode	Data Rate	Measured Channel Power (dBm)	Limit	Result
1	2412	802.11b	1Mbps	18.28	1W (30dBm)	Pass
6	2437			17.72		Pass
11	2462			18.61		Pass
1	2412		2Mbps	18.32		Pass
6	2437			17.89		Pass
11	2462			18.68		Pass
1	2412		5.5Mbps	18.41		Pass
6	2437			17.95		Pass
11	2462			18.77		Pass
1	2412		11Mbps	18.56		Pass
6	2437			18.06		Pass
11	2462			18.84		Pass

802.11b mode: 11Mbps
Channel 2412MHz

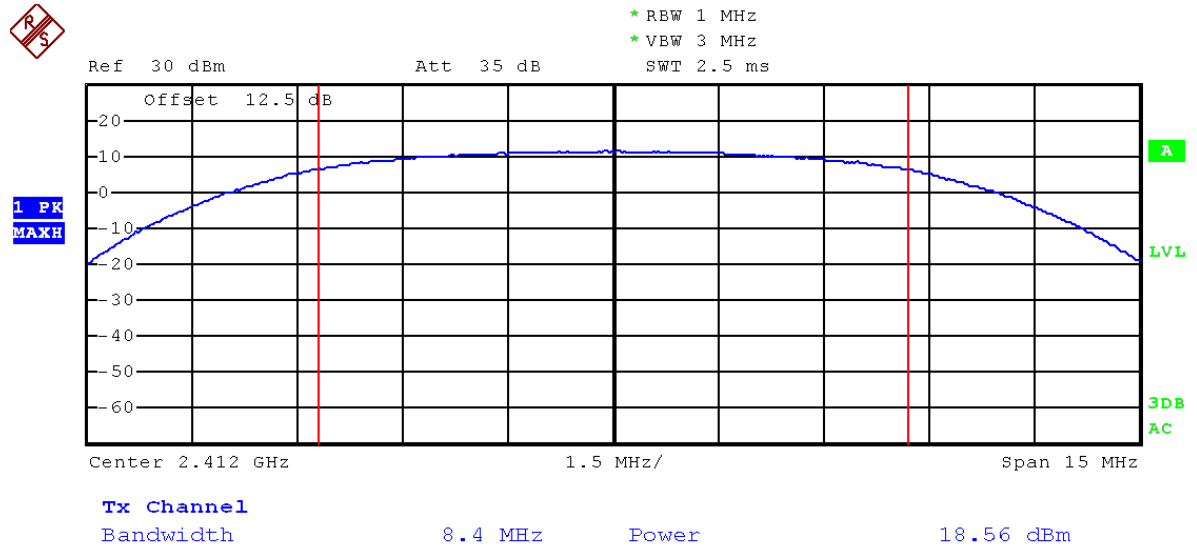

Channel 2437MHz

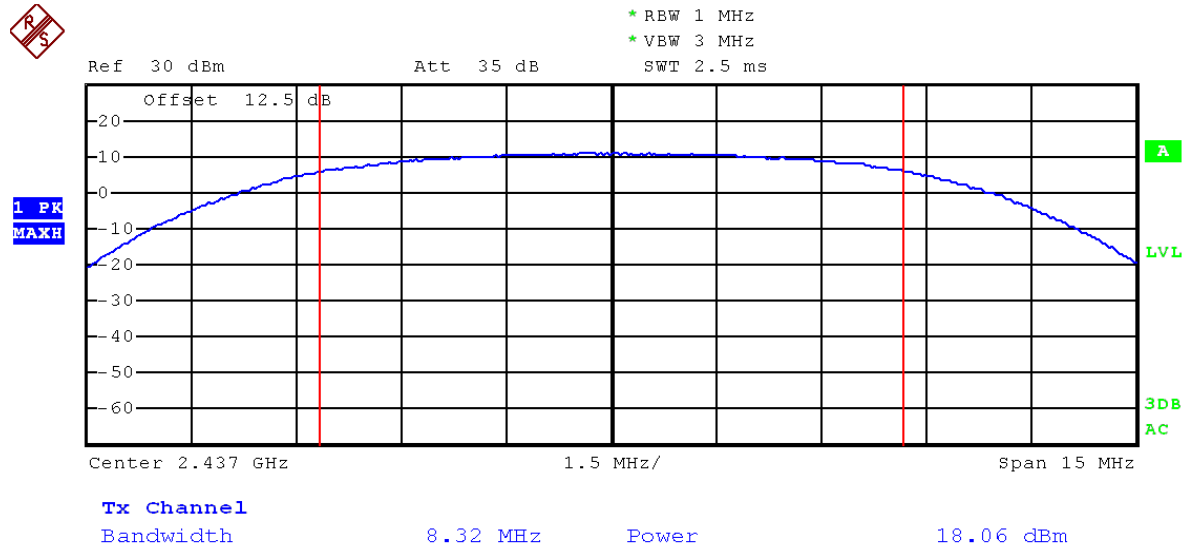

Channel 2462MHz

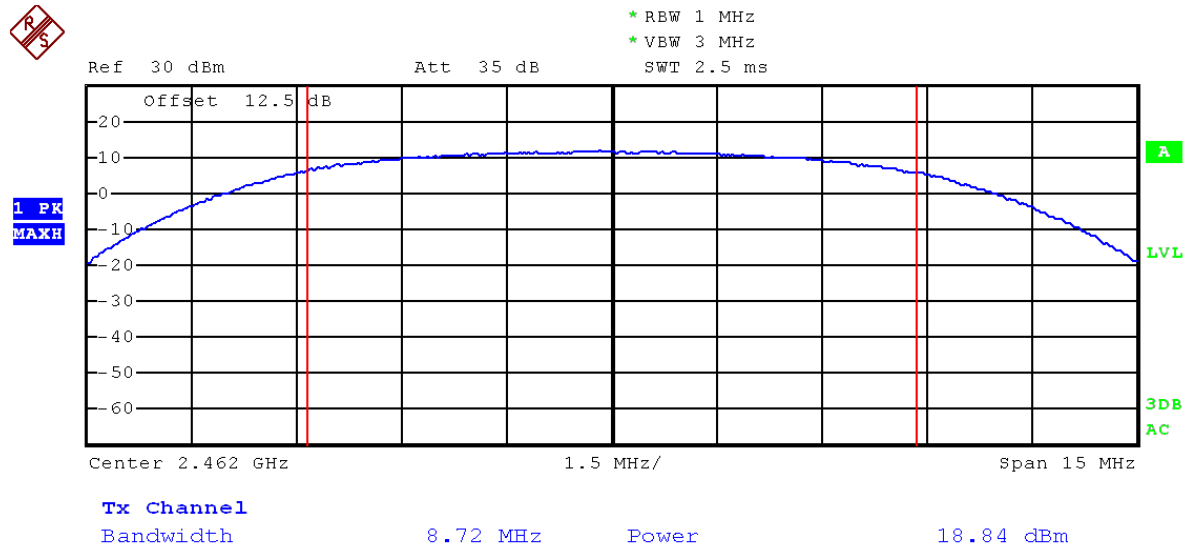

802.11g Mode:

Channel No.	Frequency (MHz)	Mode	Data Rate	Measured Channel Power (dBm)	Limit	Result
1	2412	802.11g	6Mbps	21.53	1W (30dbm)	Pass
6	2437			20.65		Pass
11	2462			20.77		Pass
1	2412		9Mbps	21.64		Pass
6	2437			20.73		Pass
11	2462			20.89		Pass
1	2412		12Mbps	21.72		Pass
6	2437			20.88		Pass
11	2462			20.96		Pass
1	2412		18Mbps	21.84		Pass
6	2437			20.91		Pass
11	2462			21.03		Pass
1	2412		24Mbps	21.97		Pass
6	2437			20.99		Pass
11	2462			21.15		Pass
1	2412		36Mbps	22.01		Pass
6	2437			21.05		Pass
11	2462			21.24		Pass
1	2412		48Mbps	22.09		Pass
6	2437			21.11		Pass
11	2462			21.38		Pass
1	2412	54Mbps	22.15	Pass		
6	2437		21.24	Pass		
11	2462		21.46	Pass		

802.11g mode: 54Mbps
Channel 2412MHz

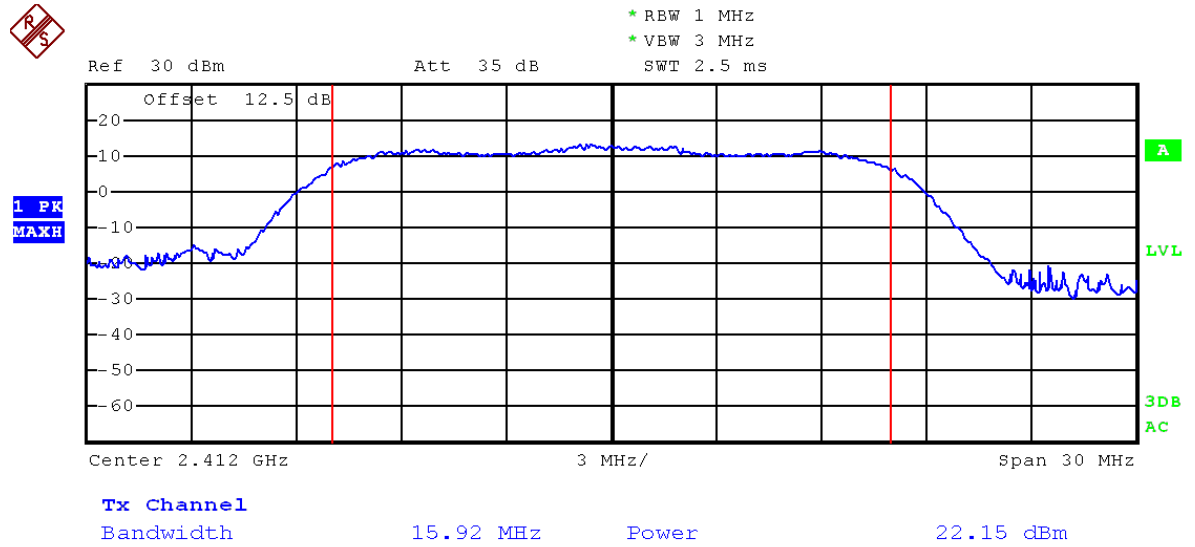

Channel 2437MHz

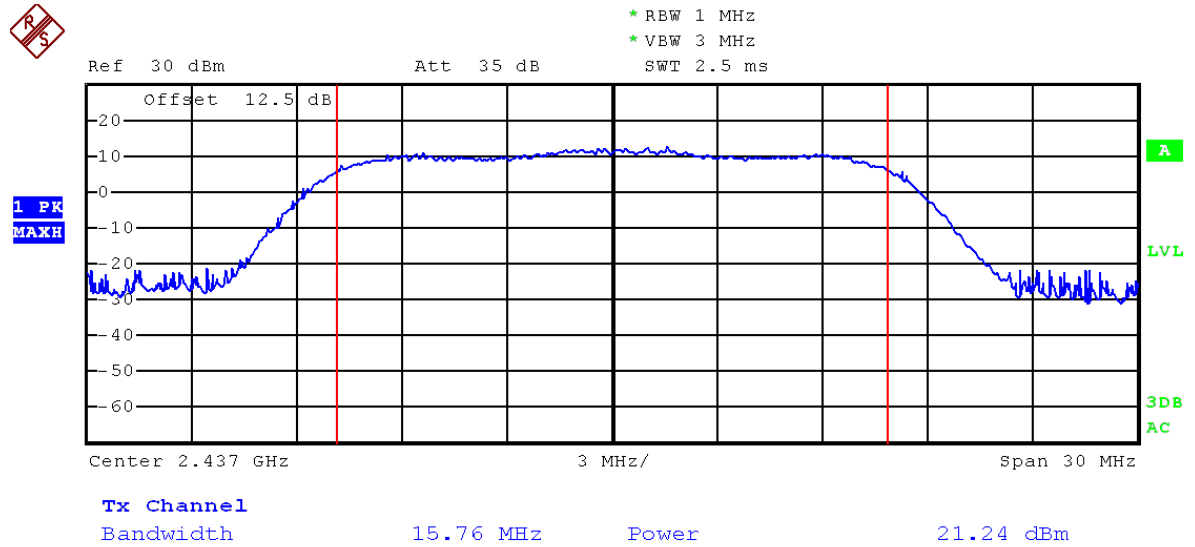

Channel 2462MHz

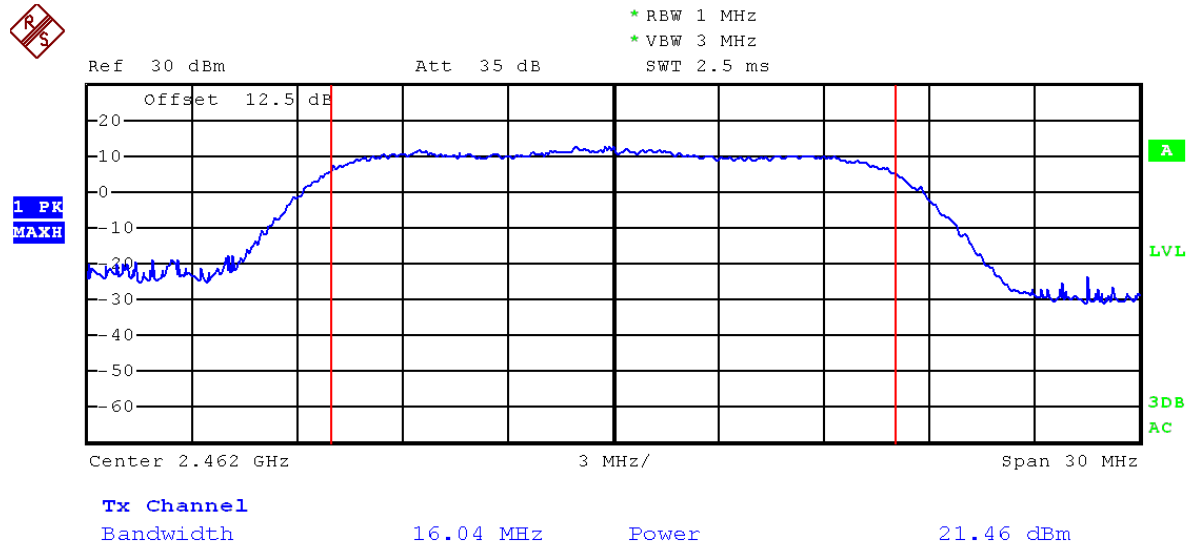

802.11n20 Mode:

Channel No.	Frequency (MHz)	Mode	Data Rate	Measured Power(dBm) (Ant 0)	Measured Power(dBm) (Ant 1)	Output Power (dBm)	Limit	Result
1	2412	802.11n20	13 Mbps	20.92	21.17	24.06	1W (30dBm)	Pass
6	2437			20.68	21.32	24.02		Pass
11	2462			21.04	21.03	24.05		Pass
1	2412		26 Mbps	21.06	21.20	24.14		Pass
6	2437			20.72	21.39	24.08		Pass
11	2462			21.13	21.11	24.13		Pass
1	2412		39 Mbps	21.14	21.22	24.19		Pass
6	2437			20.77	21.43	24.12		Pass
11	2462			21.21	21.15	24.19		Pass
1	2412		52 Mbps	21.22	21.28	24.26		Pass
6	2437			20.81	21.49	24.17		Pass
11	2462			21.26	21.20	24.24		Pass
1	2412		78 Mbps	21.27	21.32	24.31		Pass
6	2437			20.86	21.53	24.22		Pass
11	2462			21.42	21.25	24.35		Pass
1	2412		104 Mbps	21.38	21.38	24.39		Pass
6	2437			20.99	21.60	24.32		Pass
11	2462			21.45	21.28	24.38		Pass
1	2412		117 Mbps	21.41	21.43	24.43		Pass
6	2437			21.02	21.67	24.37		Pass
11	2462			21.50	21.31	24.42		Pass
1	2412	135 Mbps	21.46	21.47	24.48	Pass		
6	2437		21.08	21.73	24.43	Pass		
11	2462		21.58	21.34	24.47	Pass		

802.11n20 Antenna0 Mode:

802.11n20 mode: 135 Mbps
Channel 2412MHz

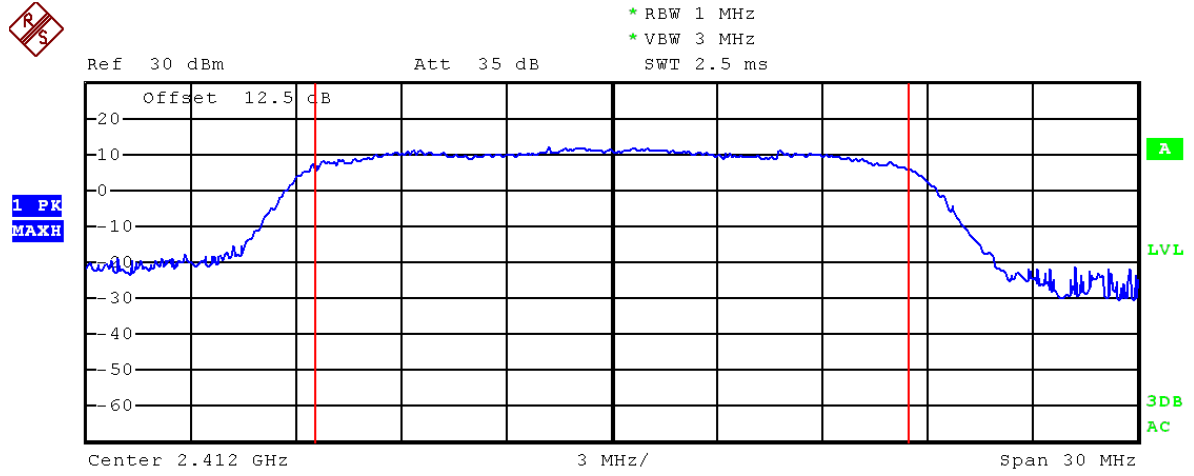

Tx Channel
Bandwidth 16.96 MHz Power 21.46 dBm

Channel 2437MHz

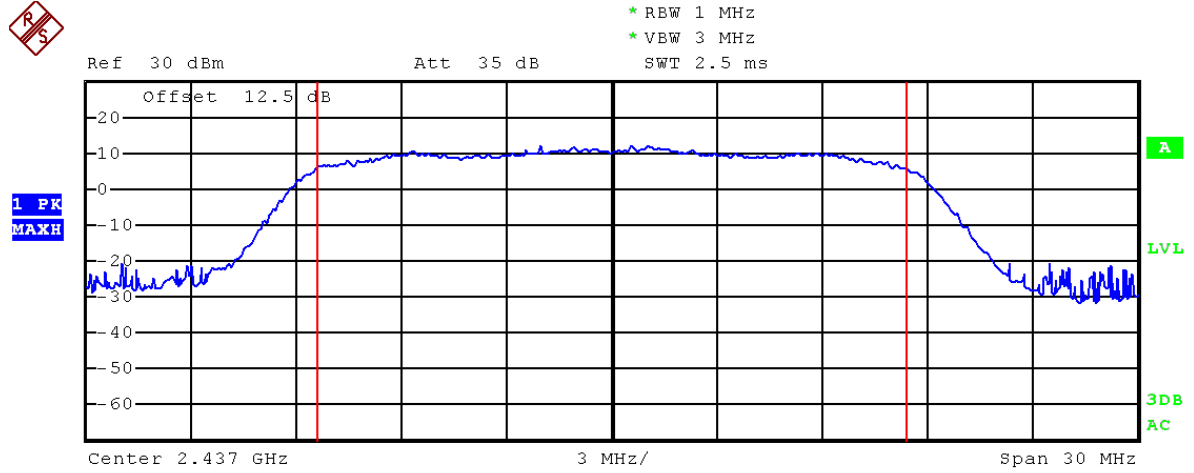

Tx Channel
Bandwidth 16.8 MHz Power 21.08 dBm

Channel 2462MHz

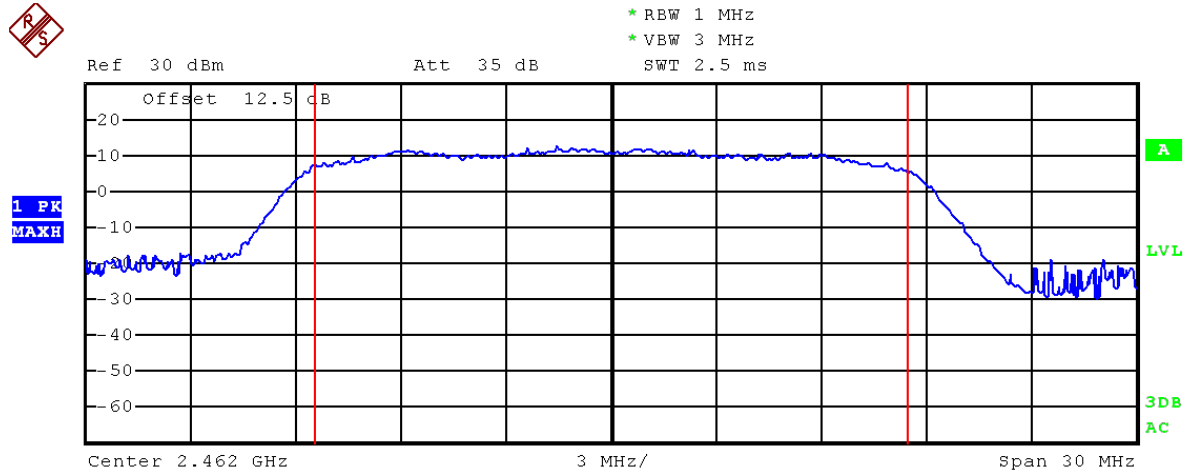

Tx Channel
Bandwidth 16.92 MHz Power 21.58 dBm

802.11n20 Antenna Mode:

802.11n20 mode: 135 Mbps
Channel 2412MHz

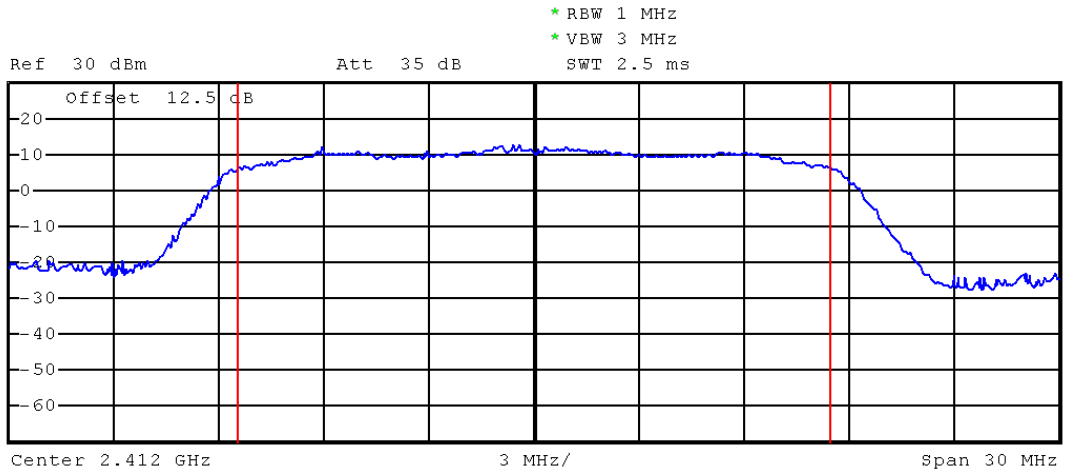

Tx Channel
Bandwidth 16.96 MHz Power 21.47 dBm

Channel 2437MHz

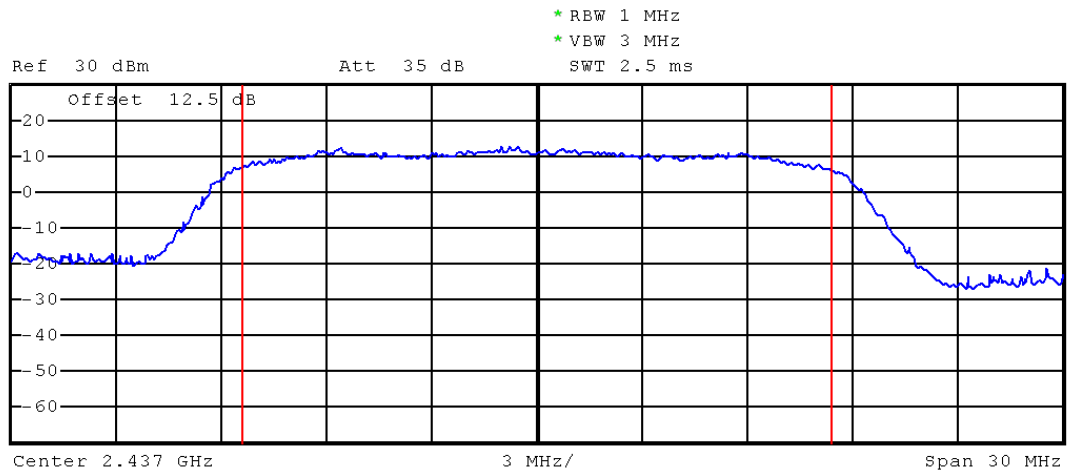

Tx Channel
Bandwidth 16.8 MHz Power 21.73 dBm

Channel 2462MHz

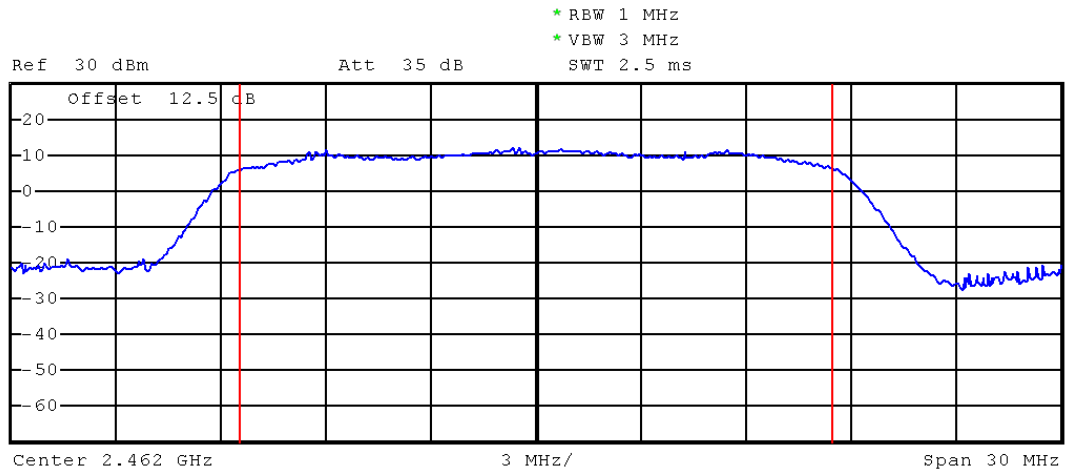

Tx Channel
Bandwidth 16.92 MHz Power 21.34 dBm

802.11n40 Mode:

Channel No.	Frequency (MHz)	Mode	Data Rate	Measured Power(dBm) (Ant 0)	Measured Power(dBm) (Ant 1)	Output Power (dBm)	Limit	Result
3	2422	802.11n40	27 Mbps	19.63	21.49	23.67	1W (30dBm)	Pass
6	2437			20.21	21.41	23.86		Pass
9	2452			20.39	20.94	23.68		Pass
3	2422		54 Mbps	19.74	21.55	23.75		Pass
6	2437			20.34	21.48	23.96		Pass
9	2452			20.43	21.00	23.73		Pass
3	2422		81 Mbps	19.87	21.63	23.85		Pass
6	2437			20.42	21.51	24.01		Pass
9	2452			20.51	21.05	23.80		Pass
3	2422		108 Mbps	19.95	21.68	23.91		Pass
6	2437			20.48	21.55	24.06		Pass
9	2452			20.60	21.11	23.87		Pass
3	2422		162 Mbps	19.99	21.73	23.96		Pass
6	2437			20.53	21.59	24.10		Pass
9	2452			20.69	21.15	23.94		Pass
3	2422		216 Mbps	20.03	21.77	24.00		Pass
6	2437			20.58	21.62	24.14		Pass
9	2452			20.77	21.18	23.99		Pass
3	2422		243 Mbps	20.09	21.79	24.03		Pass
6	2437			20.64	21.65	24.18		Pass
9	2452			20.82	21.23	24.04		Pass
3	2422	270 Mbps	20.14	21.83	24.08	Pass		
6	2437		20.71	21.69	24.24	Pass		
9	2452		20.88	21.27	24.09	Pass		

802.11n40 Antenna0 Mode:

802.11n40 mode: MCS15

Channel 2422MHz

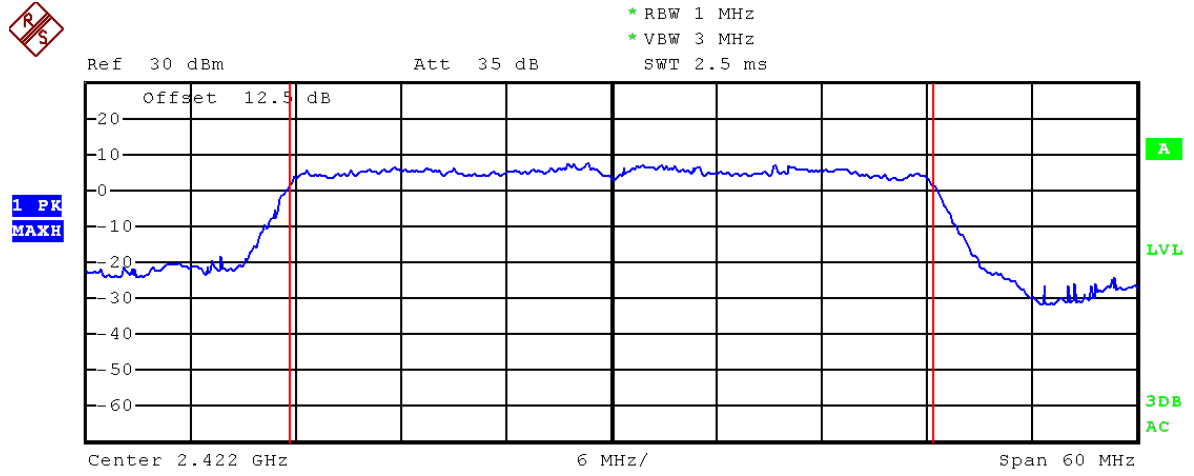

Tx Channel
Bandwidth 36.8 MHz Power 20.14 dBm

Channel 2437MHz

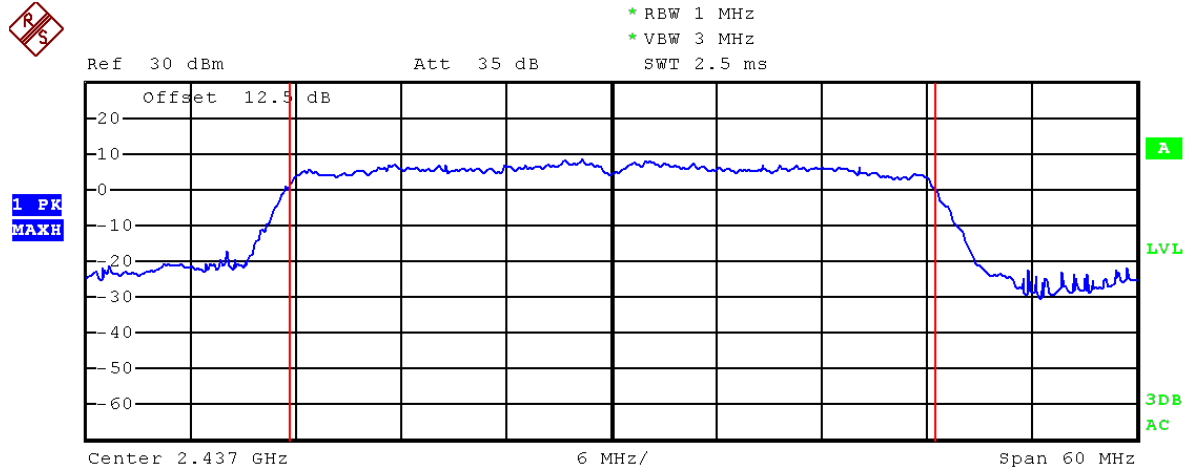

Tx Channel
Bandwidth 36.84 MHz Power 20.71 dBm

Channel 2452MHz

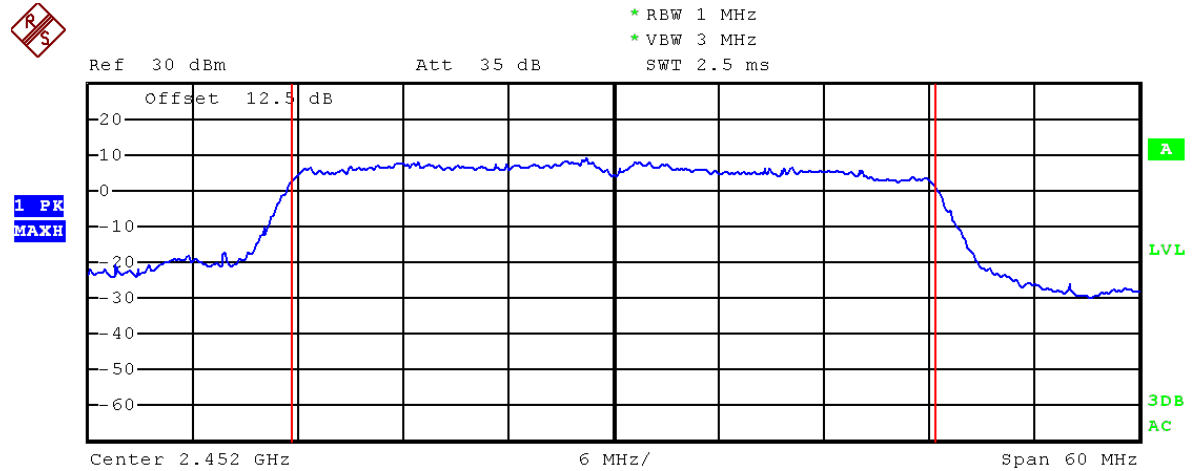

Tx Channel
Bandwidth 36.8 MHz Power 20.88 dBm

802.11n40 Antenna Mode:

802.11n40 mode: MCS15

Channel 2422MHz

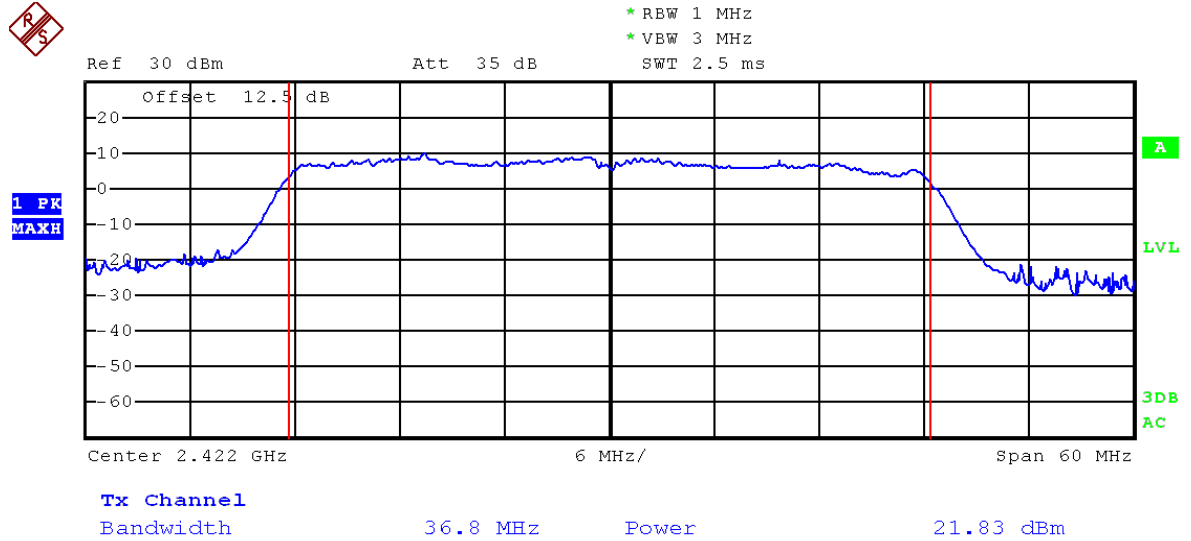

Channel 2437MHz

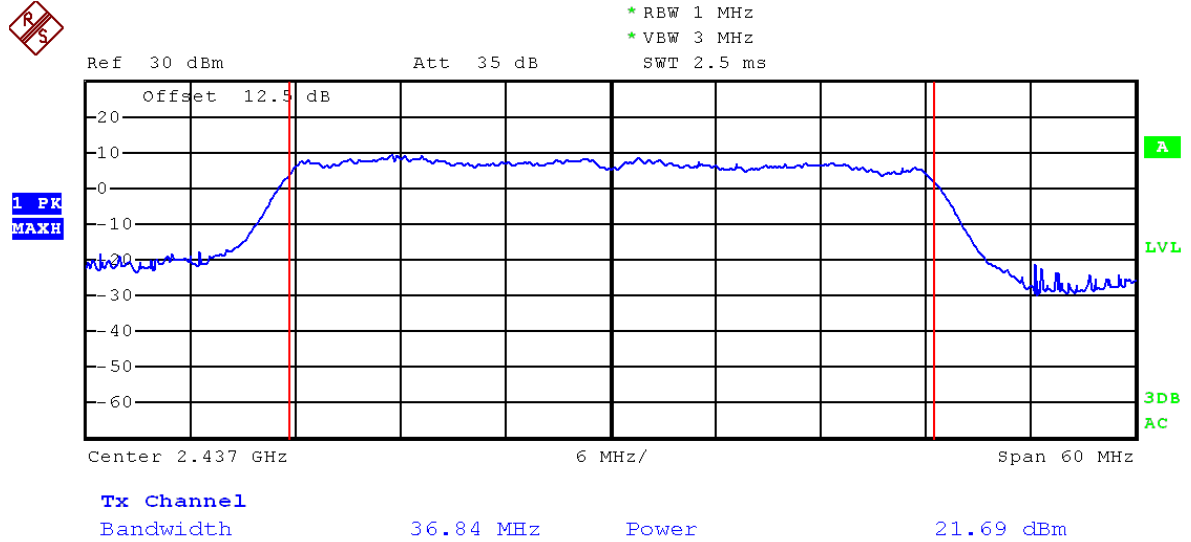

Channel 2452MHz

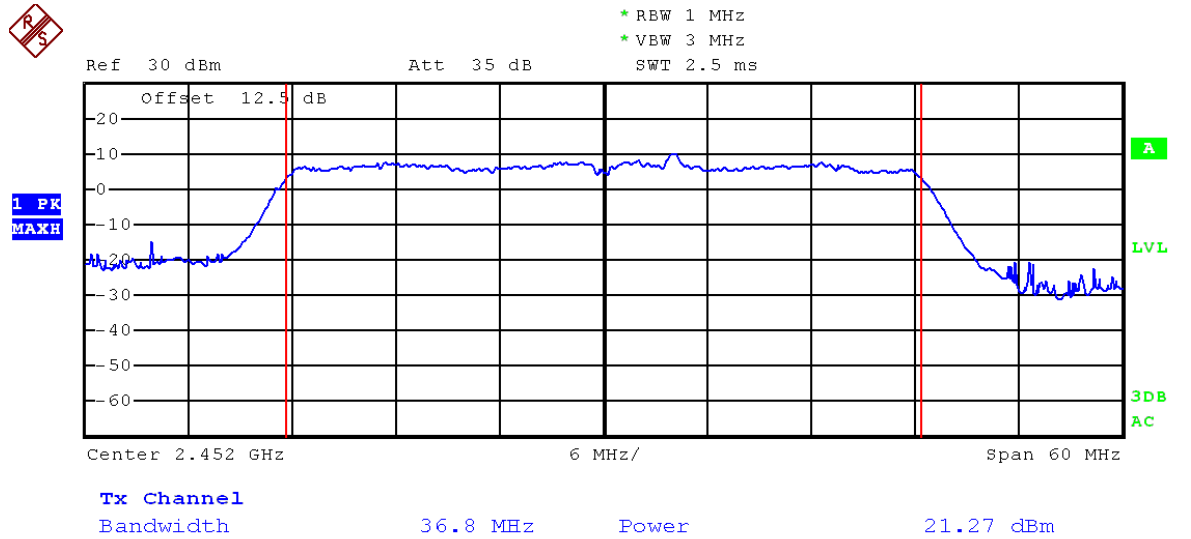

9. POWER SPECTRAL DENSITY

9.1 LIMITS

For digitally modulated systems, the power spectral density conducted from the intentional radiator to the antenna shall not be greater than 8 dBm in any 3 kHz band during any time interval of continuous transmission. This power spectral density shall be determined in accordance with the provisions of paragraph (b) of this section. The same method of determining the conducted output power shall be used to determine the power spectral density.

9.2 TEST PROCEDURES

Test procedures follow KDB 558074 D01 DTS Measurement Guidance v03r01.

1. Check the calibration of the measuring instrument using either an internal calibrator or a known signal from an external generator.
2. Position the EUT was set without connection to measurement instrument. Turn on the EUT and connect its antenna terminal to measurement instrument via a low loss cable. Then set it to any one measured frequency within its operating range, and make sure the instrument is operated in its linear range.
3. Set the analyzer span to 1.5 times the DTS bandwidth. Set the RBW = 3 kHz. Set the VBW \geq 3 RBW. Detector = peak. Ensure that the number of measurement points in the sweep \geq 2 x span/RBW (use of a greater number of measurement points than this minimum requirement is recommended).
4. Repeat above procedures until all frequencies measured were complete.

9.3 TEST SETUP



9.4 TEST RESULTS

802.11b mode:

Channel No.	Frequency (MHz)	Mode	Data Rate	PSD (dBm/100KHz)	Factor (100kHz/3kHz) (dB)	PSD (dBm/3KHz)	Limit	Result
1	2412	802.11b	11Mbps	5.05	-15.2	-10.15	8dBm/3KHz	Pass
6	2437			4.64	-15.2	-10.56		Pass
11	2462			5.22	-15.2	-9.98		Pass

802.11b mode:
Channel 2412MHz

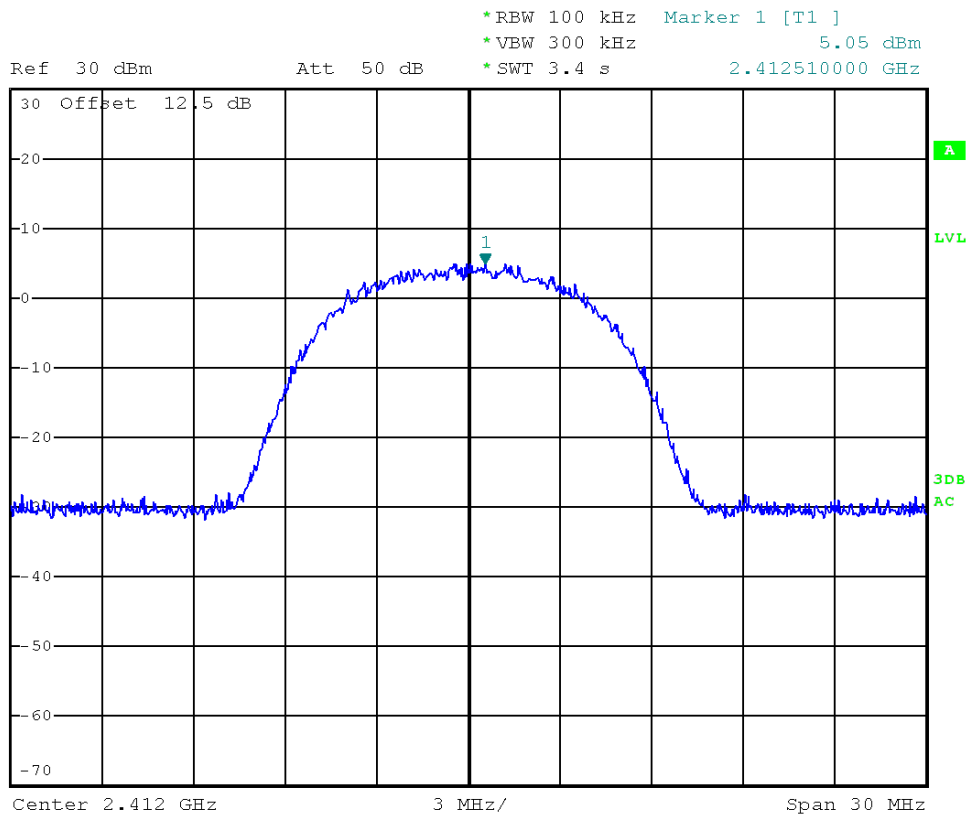

Channel 2437MHz

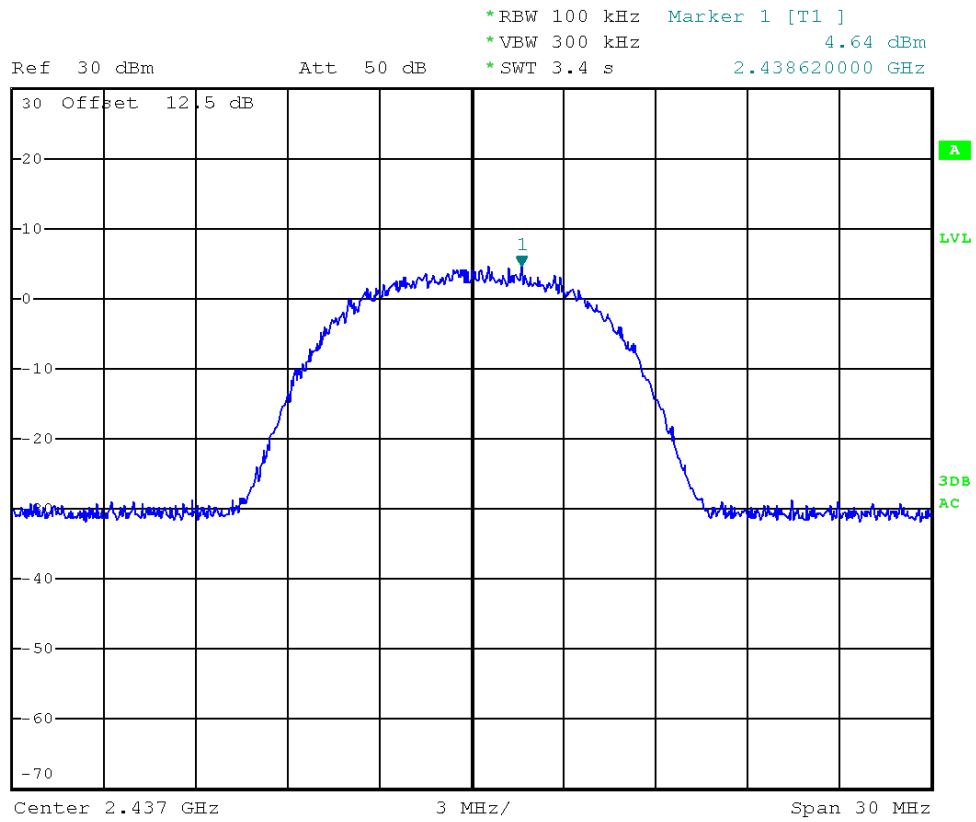

Channel 2462MHz

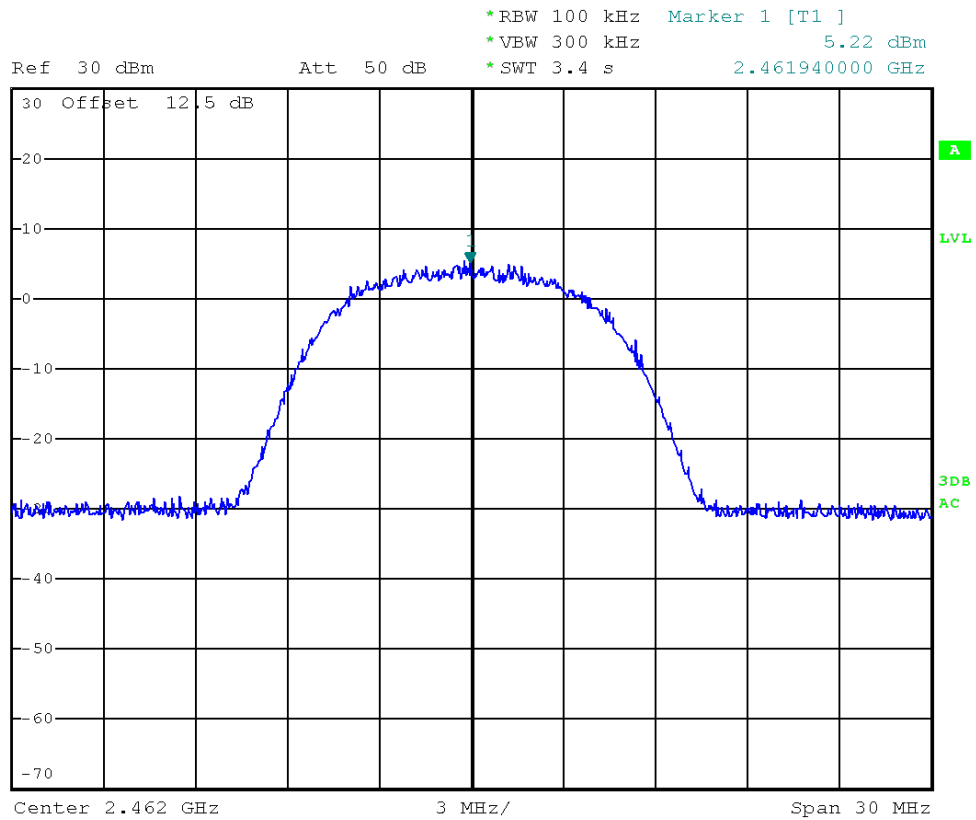

802.11g mode:

Channel No.	Frequency (MHz)	Mode	Data Rate	PSD (dBm/100KHz)	Factor (100kHz/3kHz) (dB)	PSD (dBm/3KHz)	Limit	Result
1	2412	802.11g	54Mbps	2.62	-15.2	-12.58	8dBm/3KHz	Pass
6	2437			2.59	-15.2	-12.61		Pass
11	2462			3.08	-15.2	-12.12		Pass

802.11g mode:
Channel 2412MHz

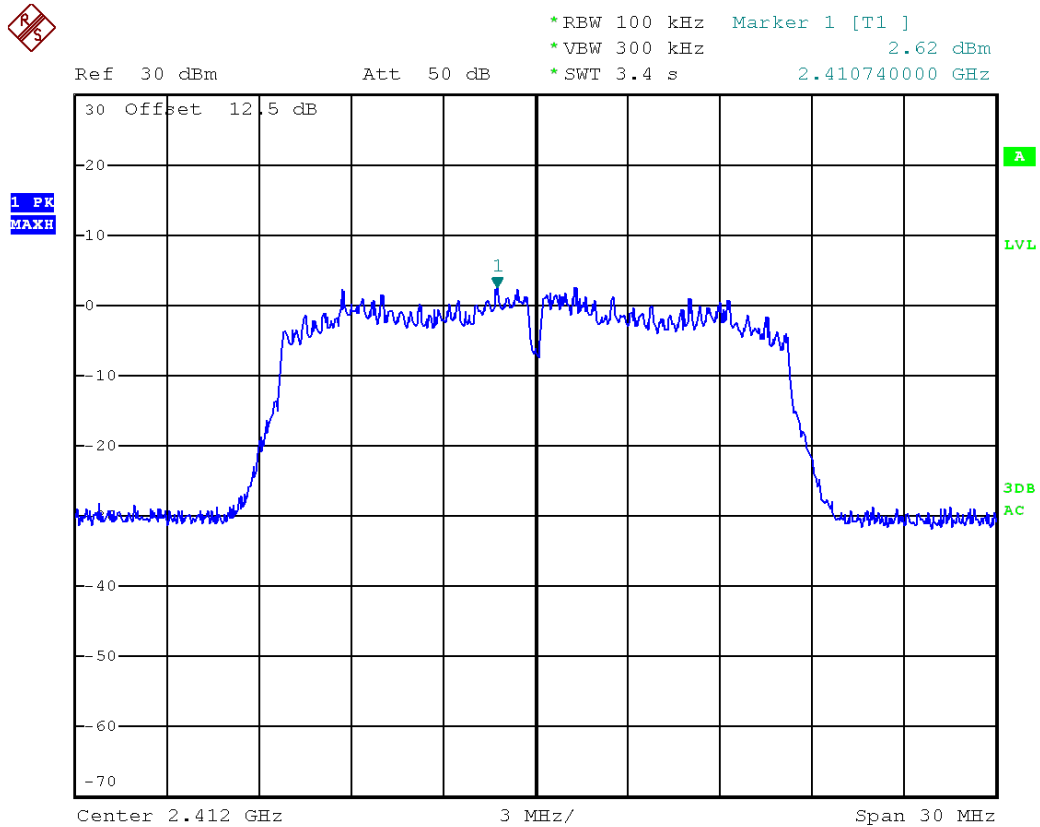

Channel 2437MHz

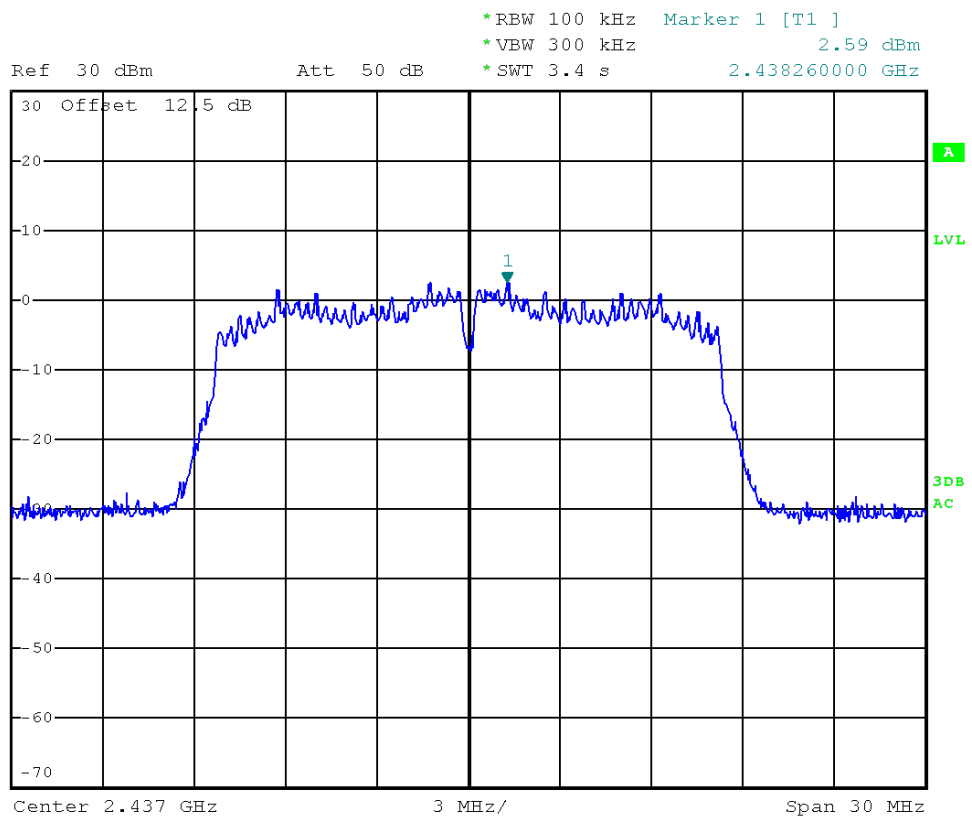

Channel 2462MHz

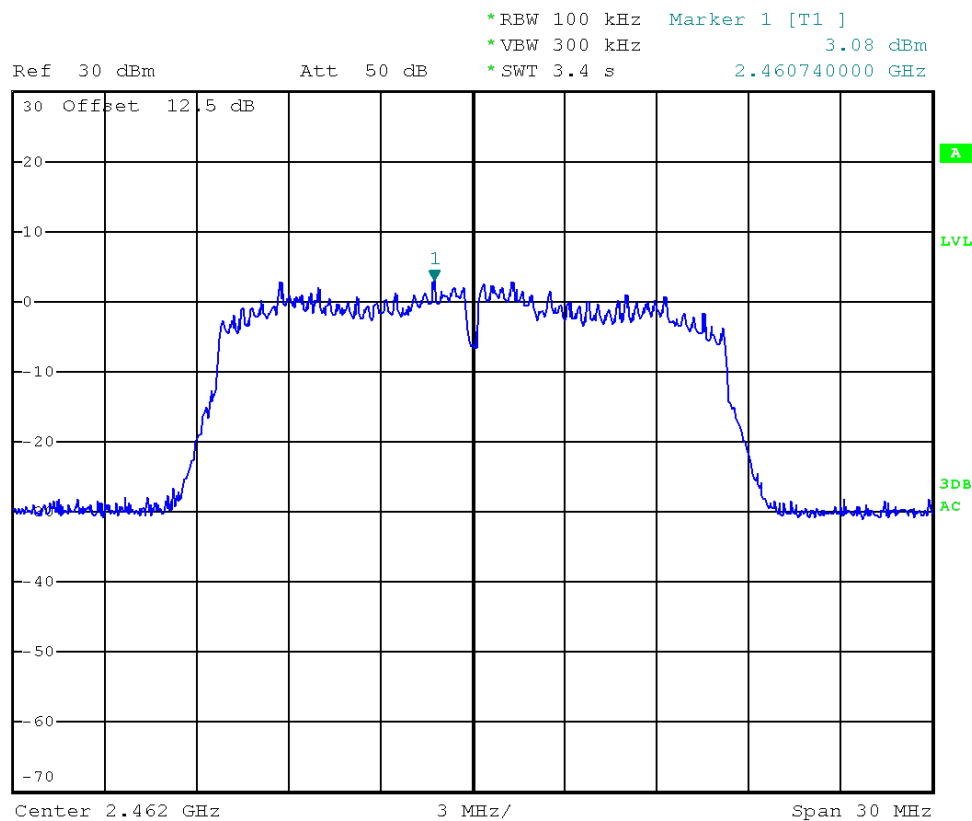

802.11n20 mode:

Channel No.	Frequency (MHz)	Mode	Data Rate	PSD (dBm/100KHz) Antenna0	PSD (dBm/100KHz) Antenna1	PSD (dBm/3KHz)	Limit	Result
1	2412	802.11n20	MCS 7	3.06	2.98	-9.17	8dBm/3KHz	Pass
6	2437			2.95	3.22	-9.10		Pass
11	2462			3.14	2.42	-9.39		Pass

802.11n20 antenna 0 mode:

Channel 2412MHz

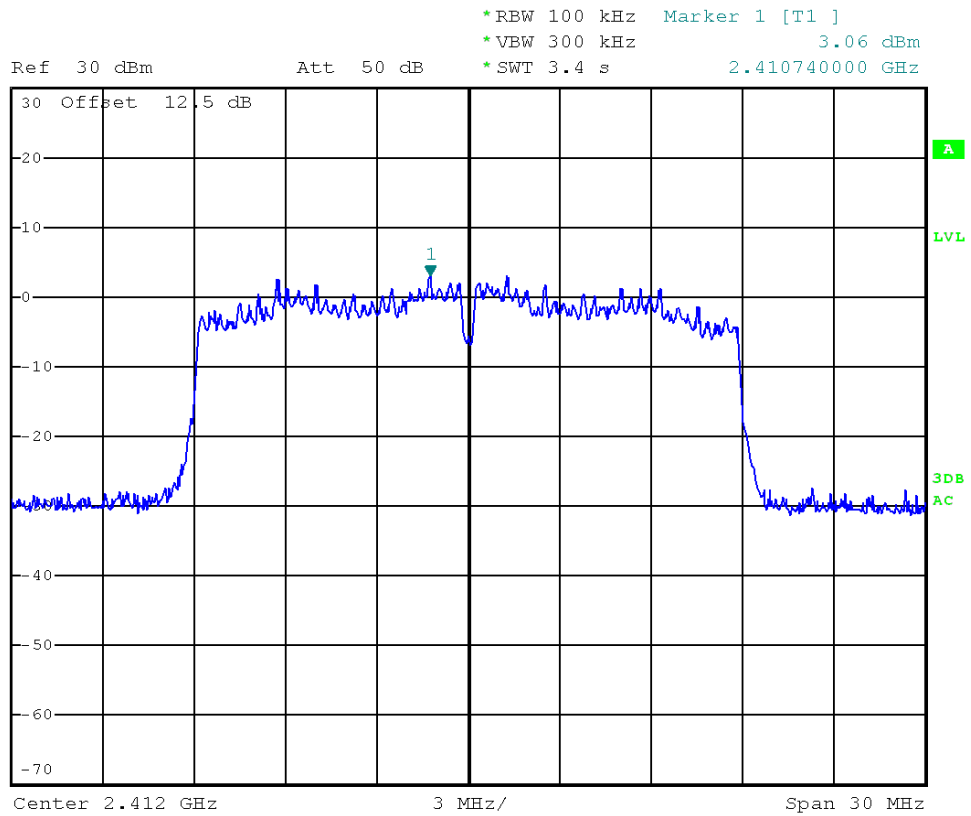

Channel 2437MHz



Ref 30 dBm Att 50 dB *RBW 100 kHz Marker 1 [T1]
*VBW 300 kHz 2.95 dBm
*SWT 3.4 s 2.438260000 GHz

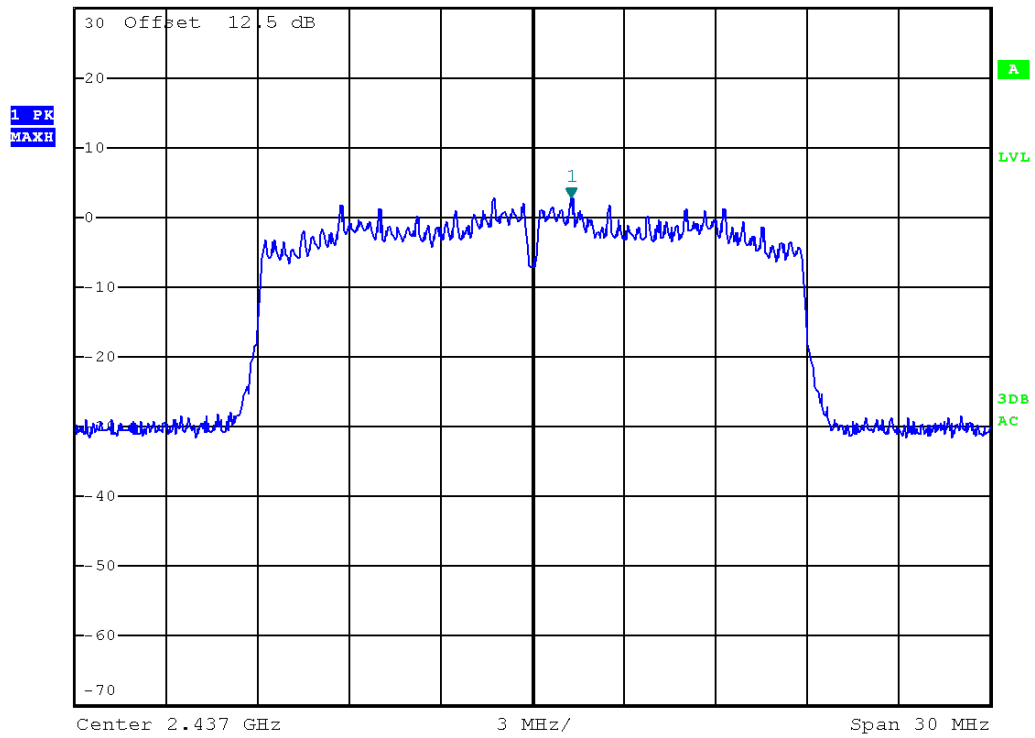

Channel 2462MHz



Ref 30 dBm Att 50 dB *RBW 100 kHz Marker 1 [T1]
*VBW 300 kHz 3.14 dBm
*SWT 3.4 s 2.460740000 GHz

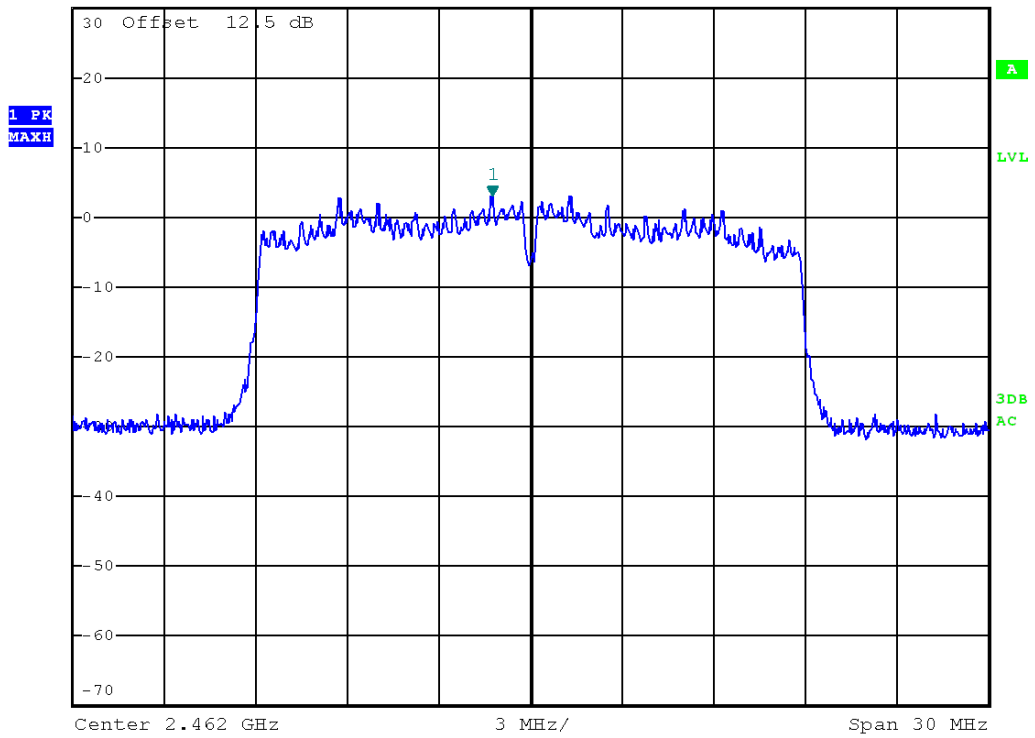

Channel 2437MHz



Ref 30 dBm Att 50 dB *RBW 100 kHz Marker 1 [T1]
*VBW 300 kHz 3.22 dBm
*SWT 3.4 s 2.435740000 GHz

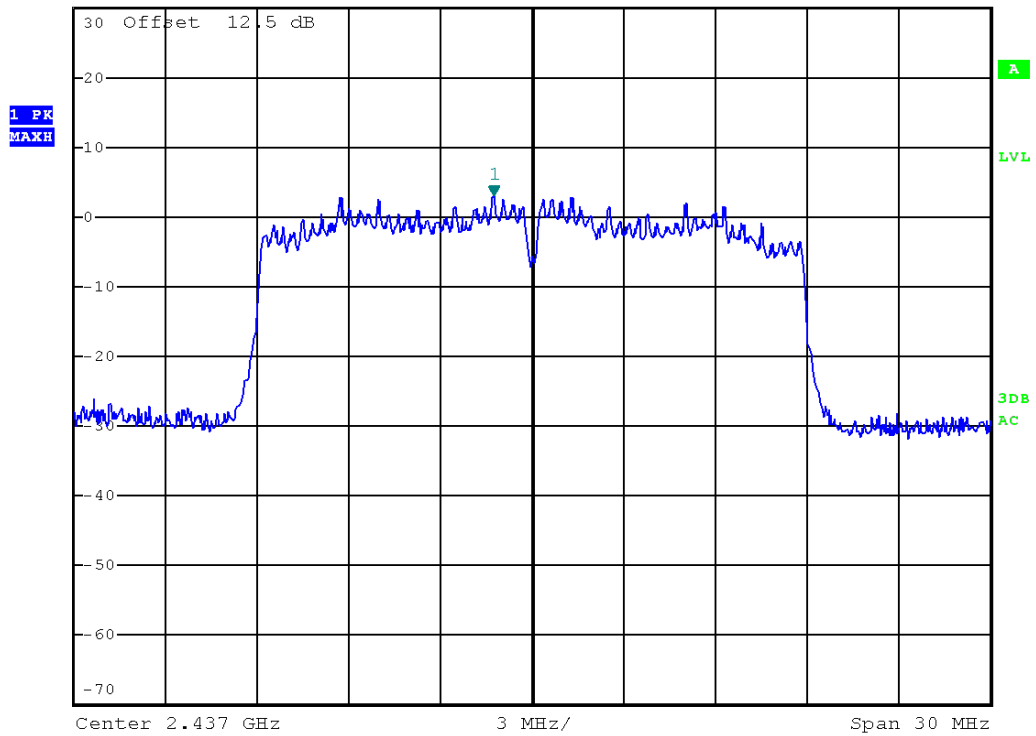

Channel 2462MHz



Ref 30 dBm Att 50 dB *RBW 100 kHz Marker 1 [T1]
*VBW 300 kHz 2.42 dBm
*SWT 3.4 s 2.463260000 GHz

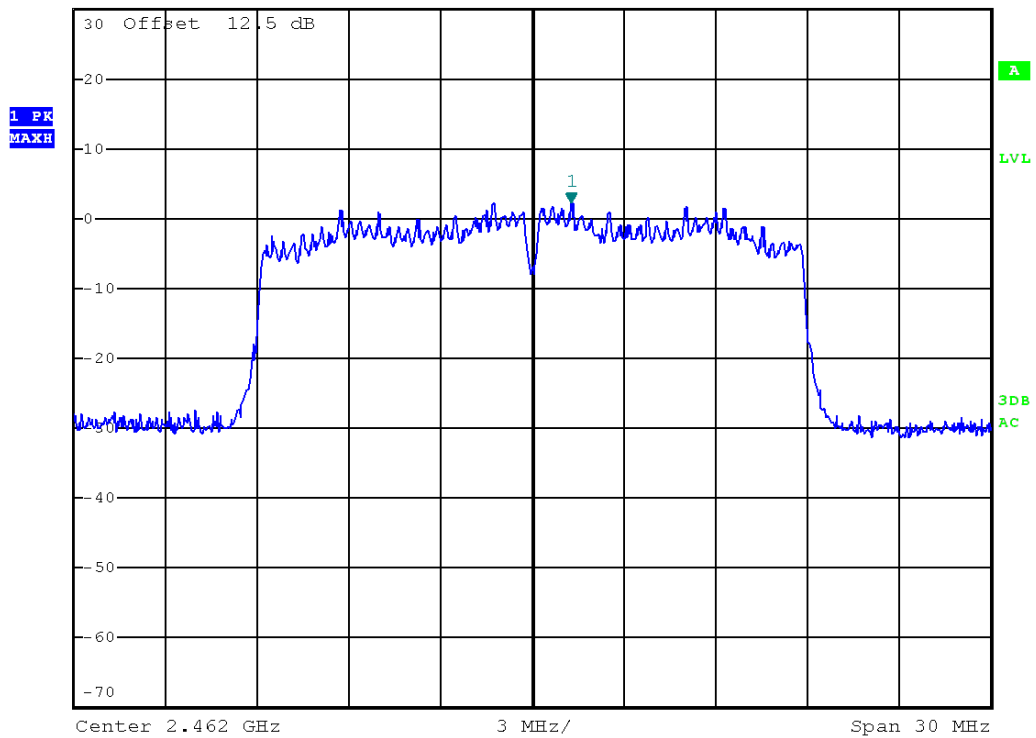

802.11n40 mode:

Channel No.	Frequency (MHz)	Mode	Data Rate	PSD (dBm/3KHz)	PSD (dBm/3KHz)	PSD (dBm/3KHz)	Limit	Result
				Antenna0	Antenna1			
3	2422	802.11n40	MCS15	-0.83	0.53	-12.29	8dBm/3KHz	Pass
6	2437			-0.25	0.31	-12.15		Pass
9	2452			0.46	-0.33	-12.11		Pass

802.11n40 antenna 0 mode:

Channel 2422MHz

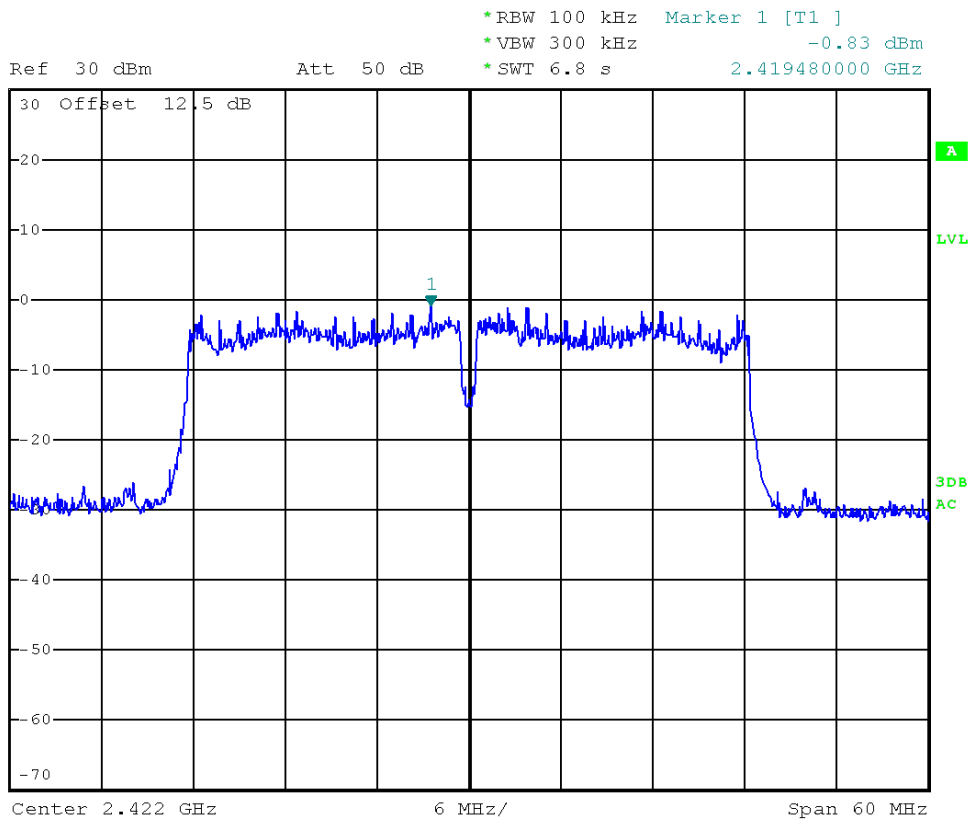

Channel 2437MHz



Ref 30 dBm Att 50 dB *RBW 100 kHz Marker 1 [T1]
*VBW 300 kHz -0.25 dBm
*SWT 6.8 s 2.434480000 GHz

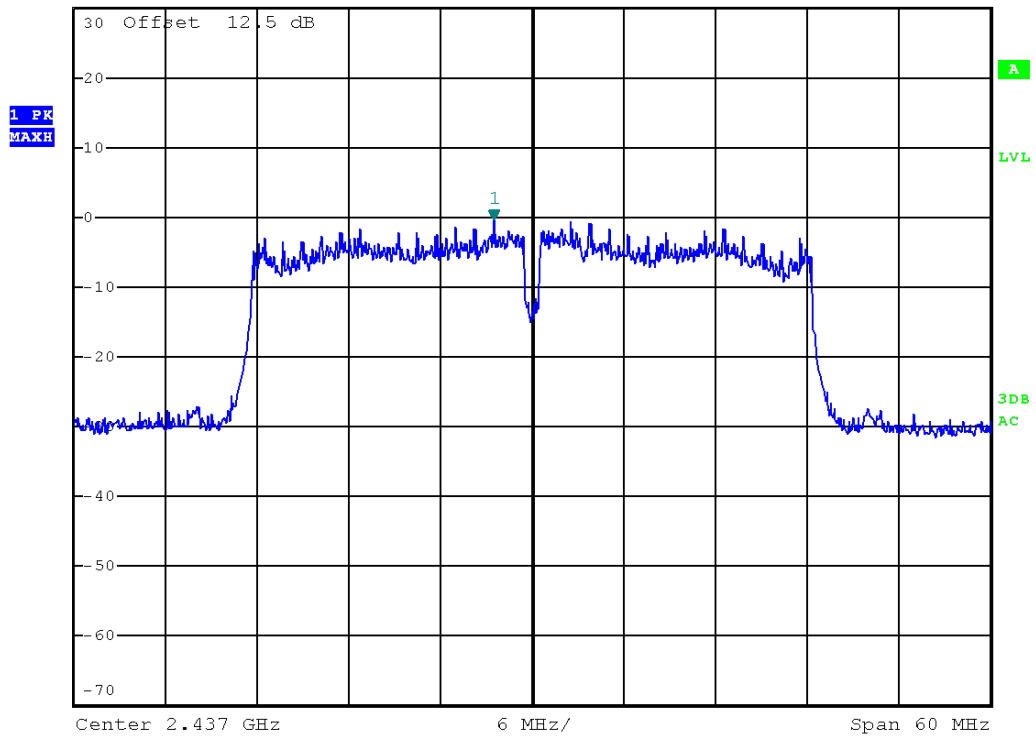

Channel 2452MHz



Ref 30 dBm Att 50 dB *RBW 100 kHz Marker 1 [T1]
*VBW 300 kHz 0.46 dBm
*SWT 6.8 s 2.449480000 GHz

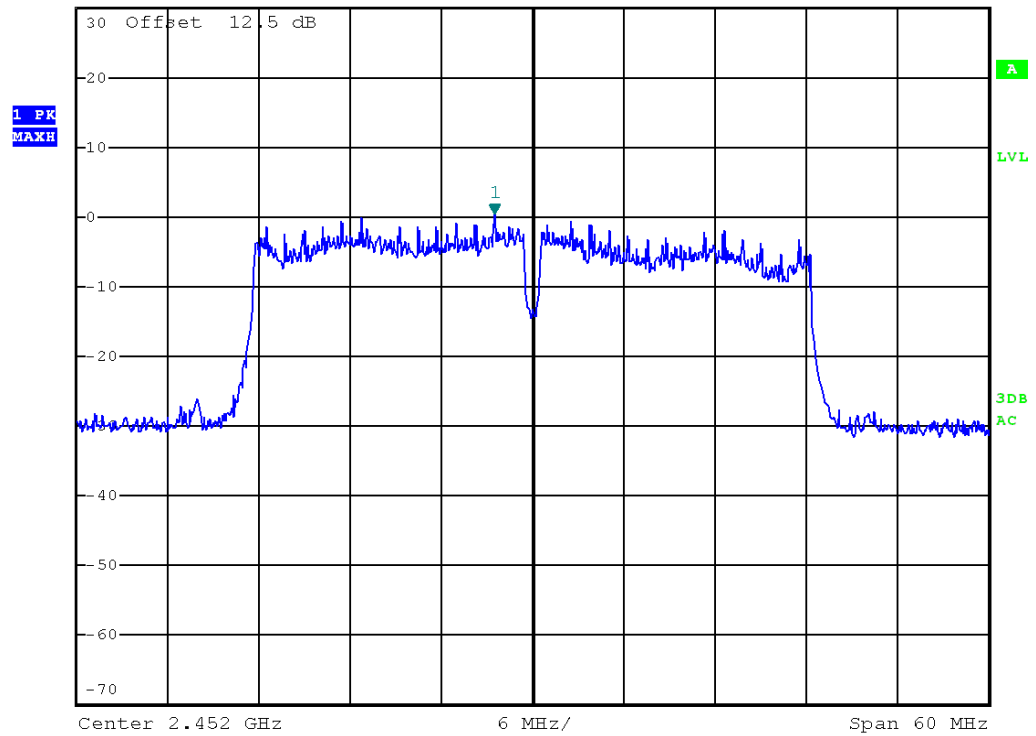

802.11n40 antenna1 mode:
Channel 2422MHz



*RBW 100 kHz Marker 1 [T1]
*VBW 300 kHz 0.53 dBm
*SWT 6.8 s 2.419480000 GHz

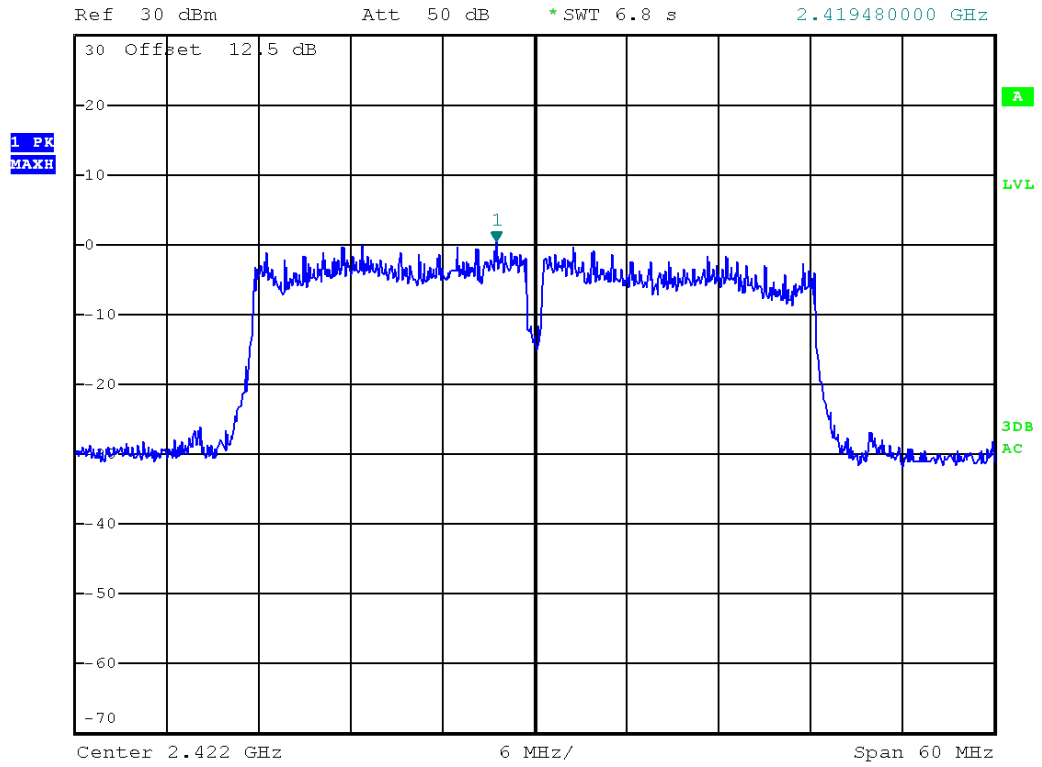

Channel 2437MHz



Ref 30 dBm Att 50 dB *RBW 100 kHz Marker 1 [T1] 0.31 dBm
*VBW 300 kHz *SWT 6.8 s 2.434480000 GHz

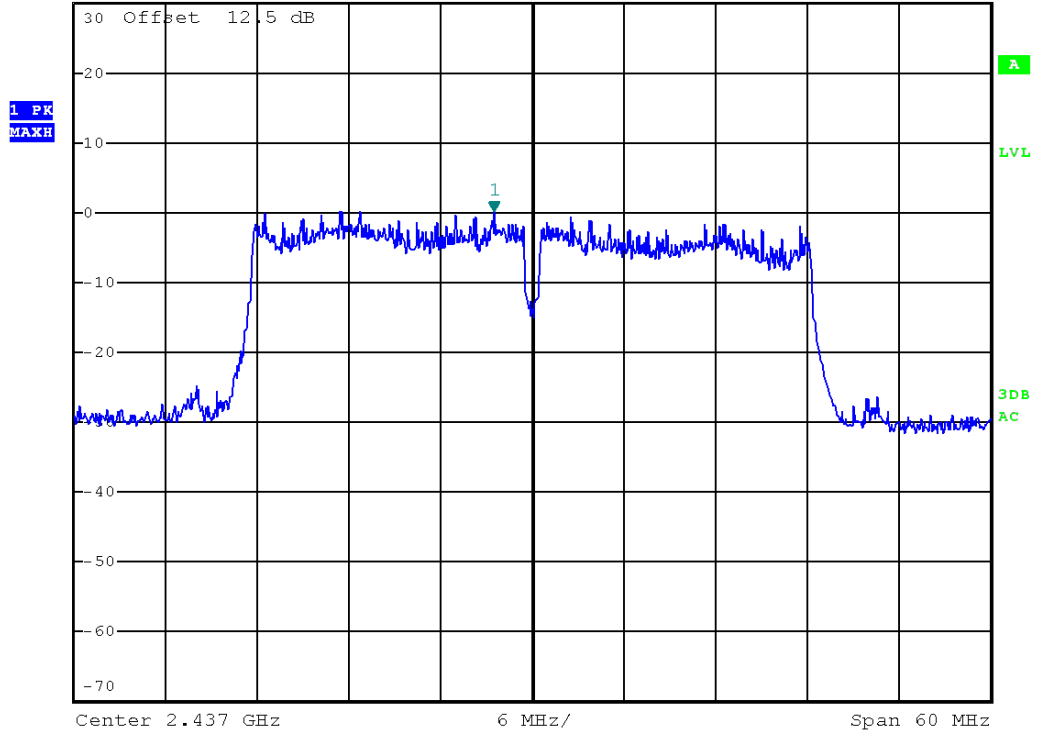

Channel 2452MHz



Ref 30 dBm Att 50 dB *RBW 100 kHz Marker 1 [T1] -0.33 dBm
*VBW 300 kHz *SWT 6.8 s 2.449480000 GHz

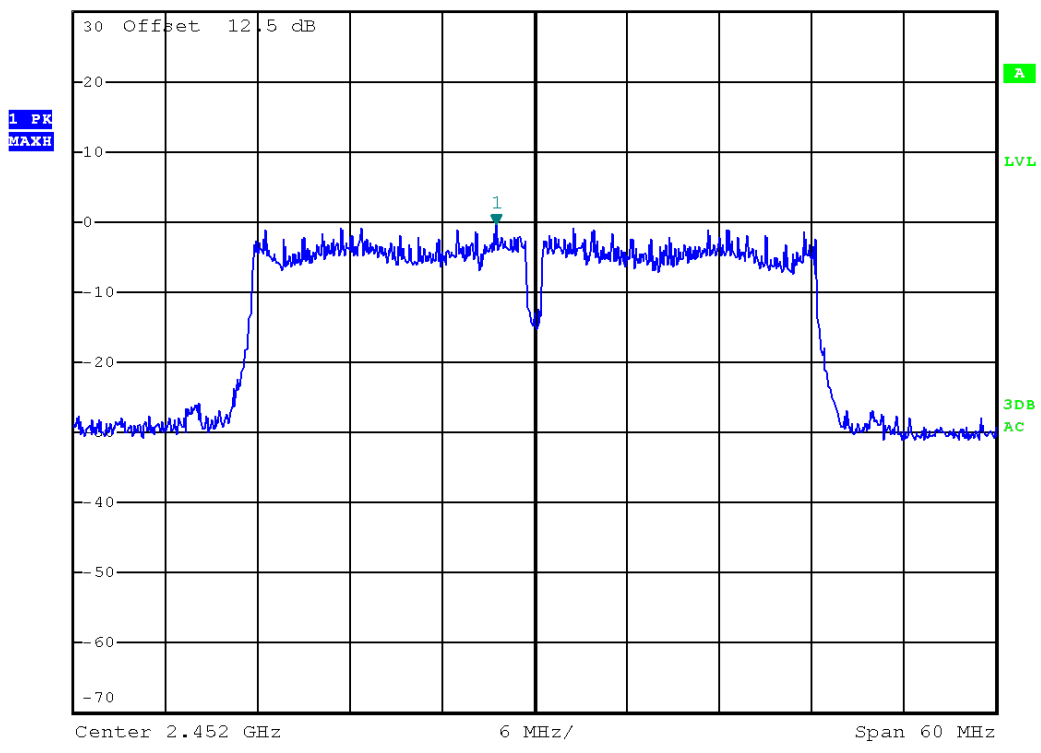

10. EMISSIONS IN NON-RESTRICTED FREQUENCY BANDS

10.1 LIMITS

FCC 15.247(d) & 15.209

10.2 TEST PROCEDURES

Test procedures follow KDB 558074 D01 DTS Measurement Guidance v03r01.

Remove the antenna from the EUT and then connect a low attenuation cable from the antenna port to the spectrum.

1. Reference level measurement

Below 1GHz Set the spectrum analyzer: RBW =100KHz VBW \geq 3*RBW, Set the span to \geq 1.5 times the DTS bandwidth. Sweep = auto; Detector Function = peak. Trace = Max-hold. Allow the trace to stabilize.

2. Set the spectrum analyzer: RBW =100KHz VBW \geq 3*RBW, Set the span to \geq 1.5 times the DTS bandwidth. Sweep = auto; Detector Function = peak. Trace = Max-hold. Allow the trace to stabilize.

10.3 TEST SETUP

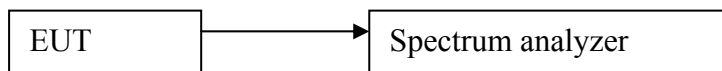

10.4 TEST RESULTS

802.11b mode:
Channel 2412MHz
reference level:

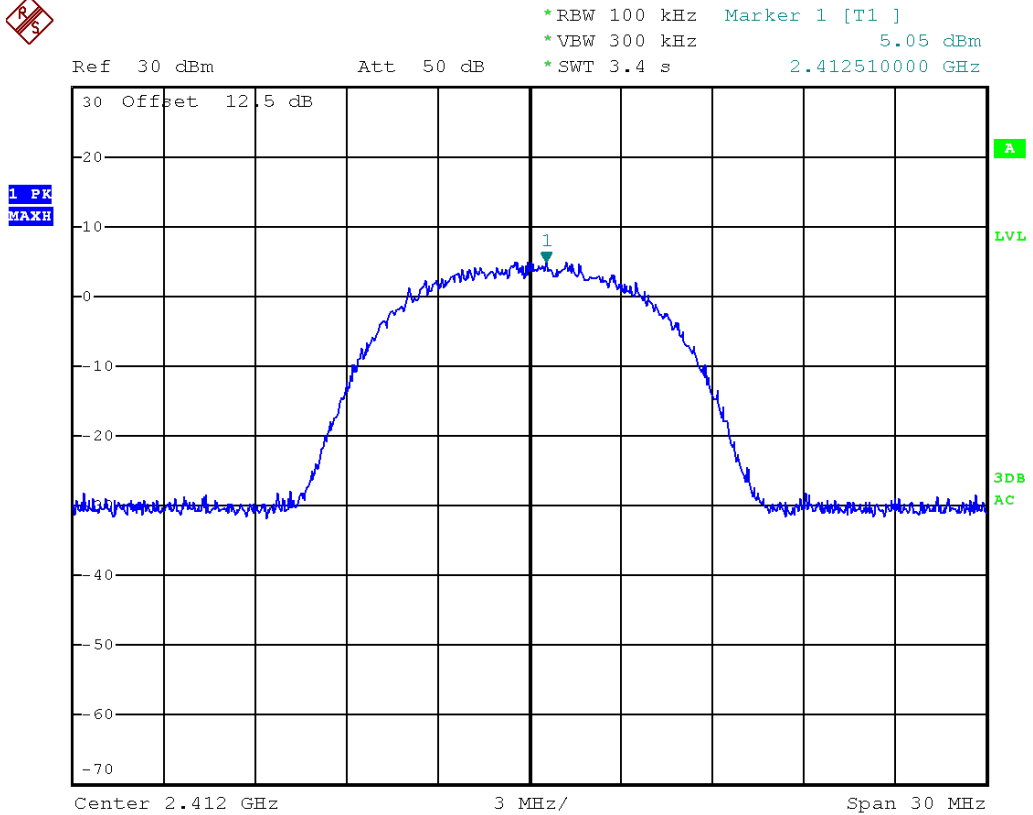

So limit is -14.95dBm
30M-1G

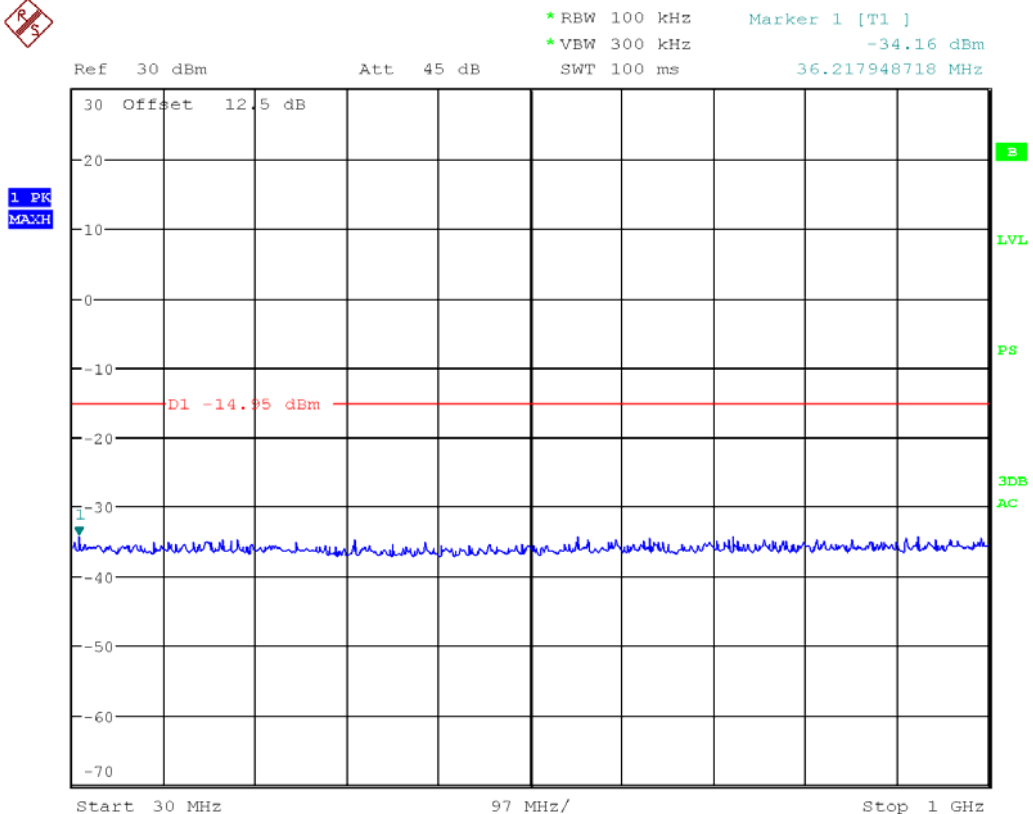

1G-10G

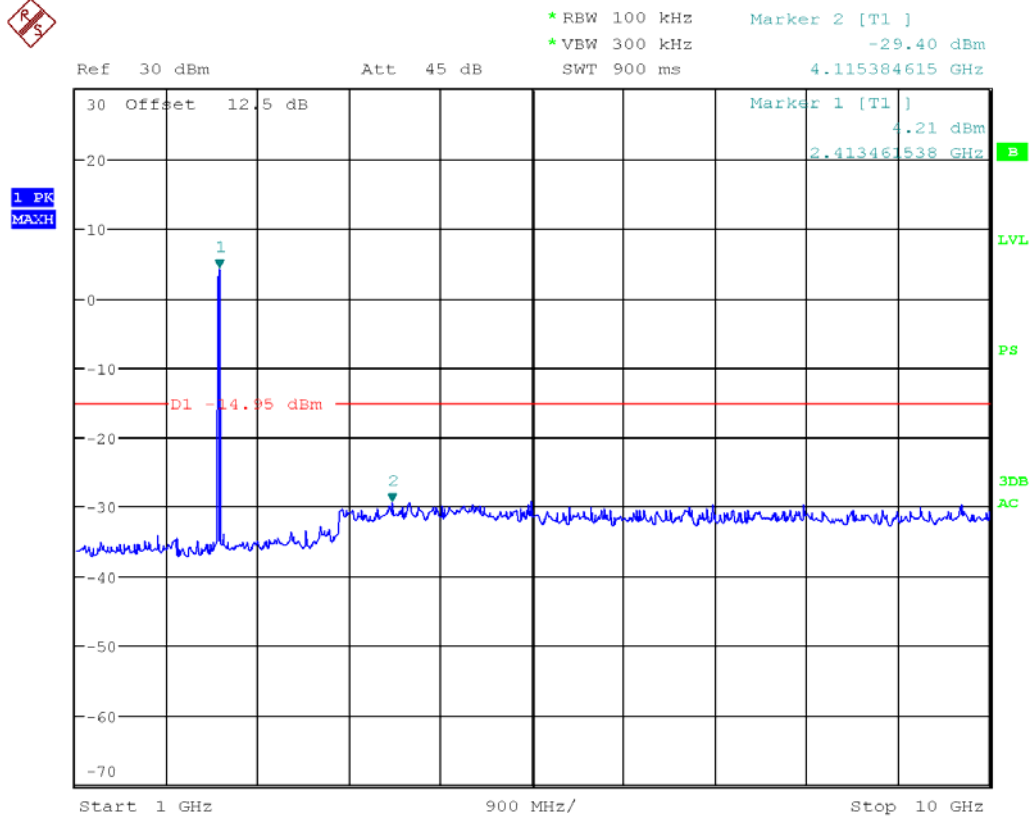

10G-25G

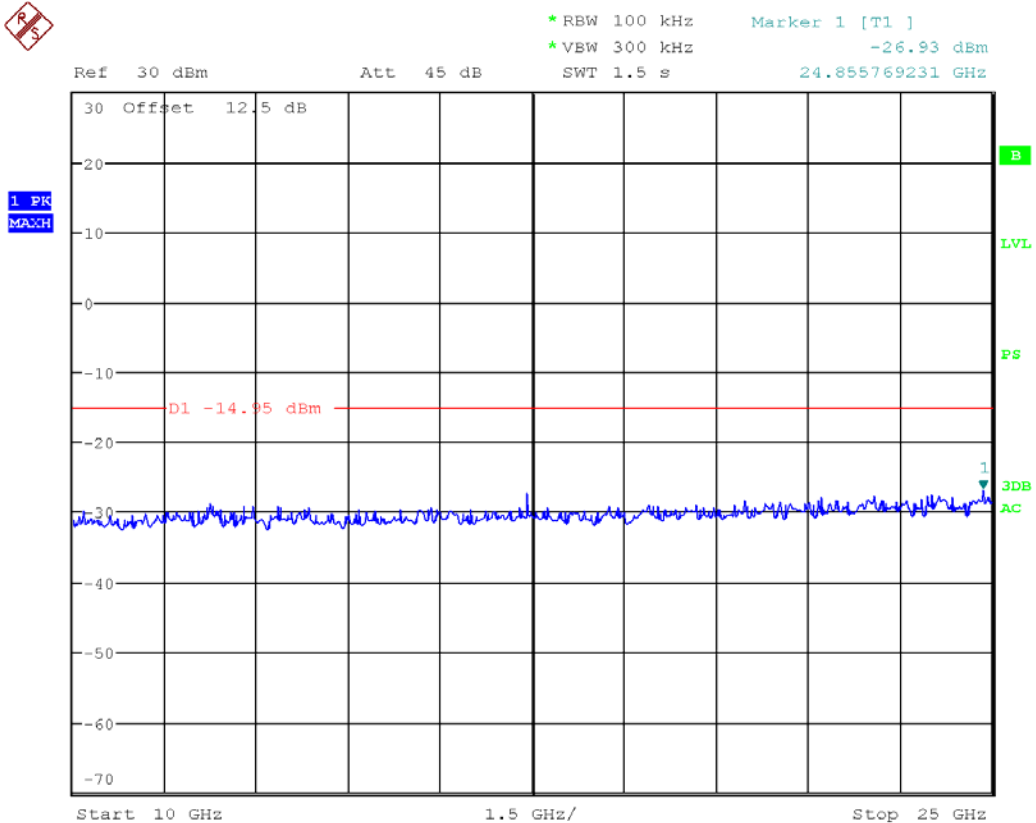

802.11b mode:
Channel 2437MHz
Reference level

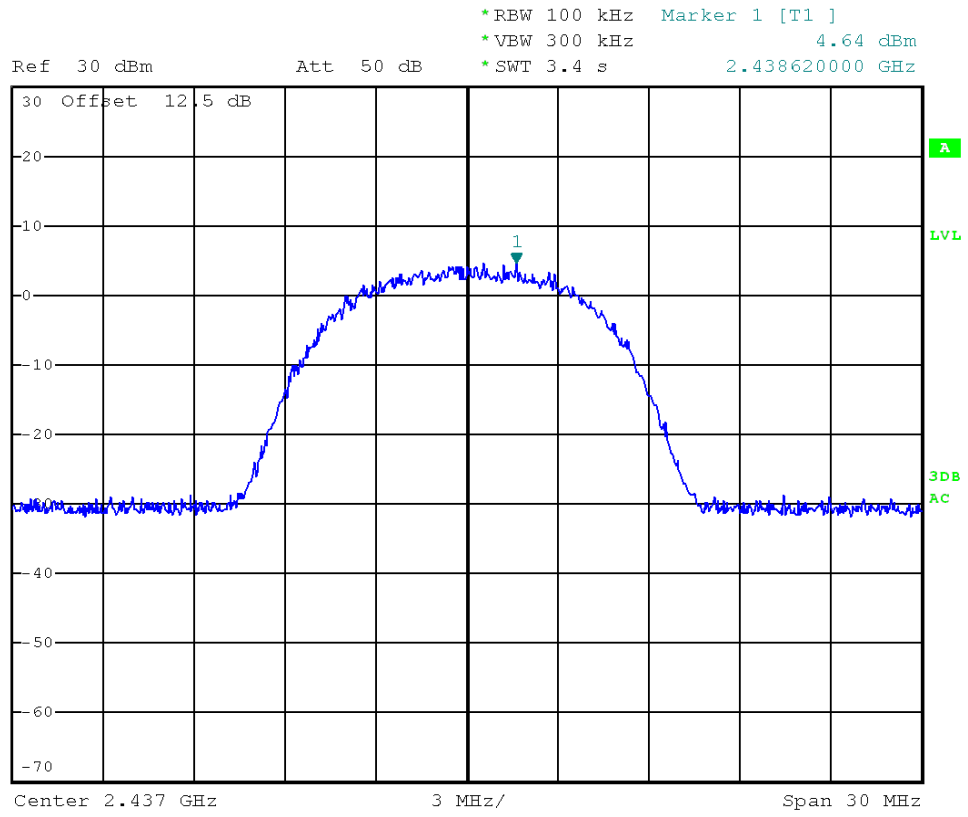

So the limit is -15.36dBm
30M-1G

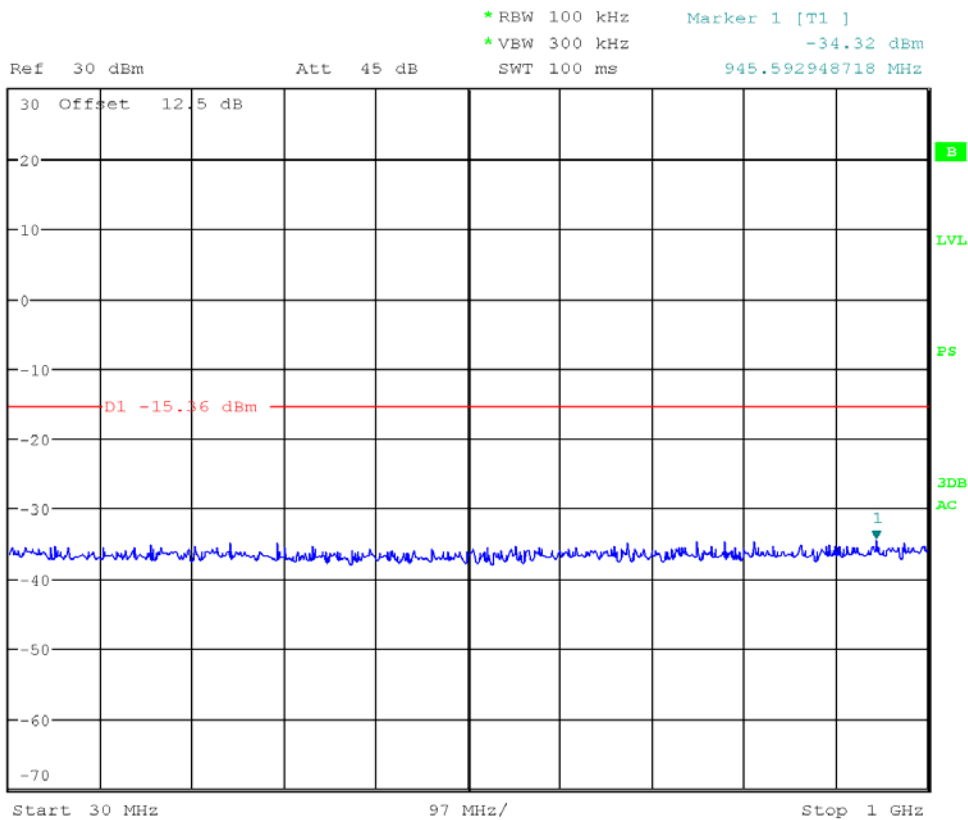

1G-10G

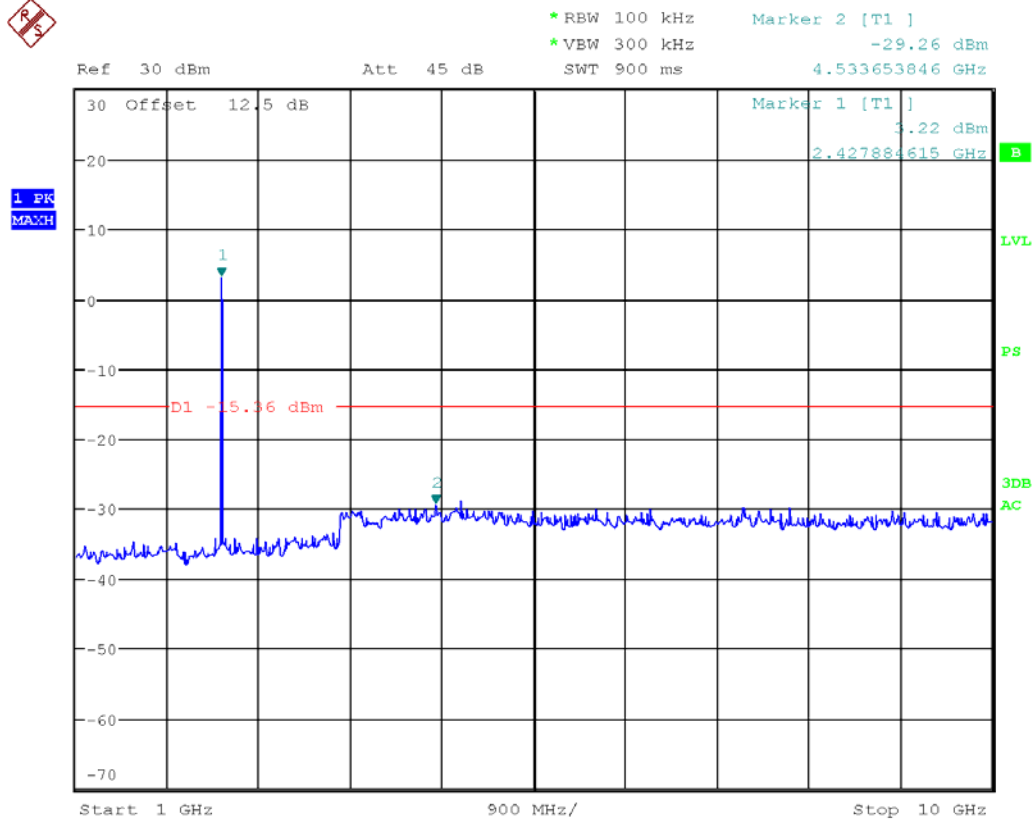

10G-25G

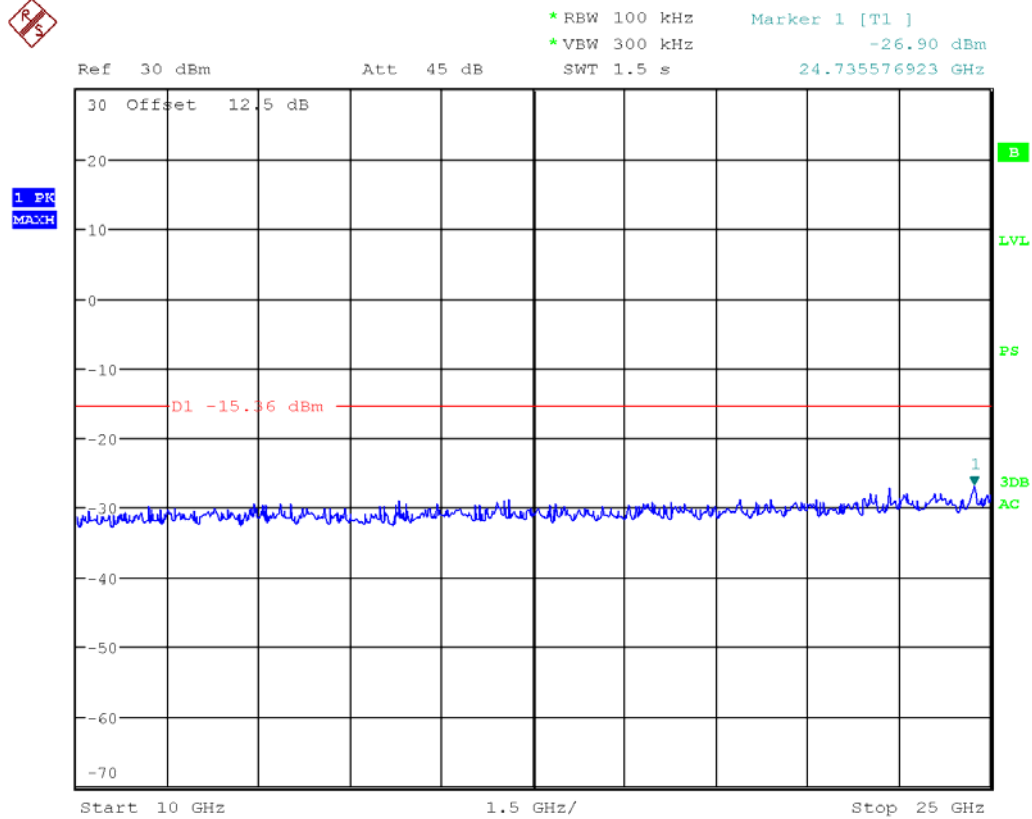

802.11b mode:
Channel 2462MHz
Reference level

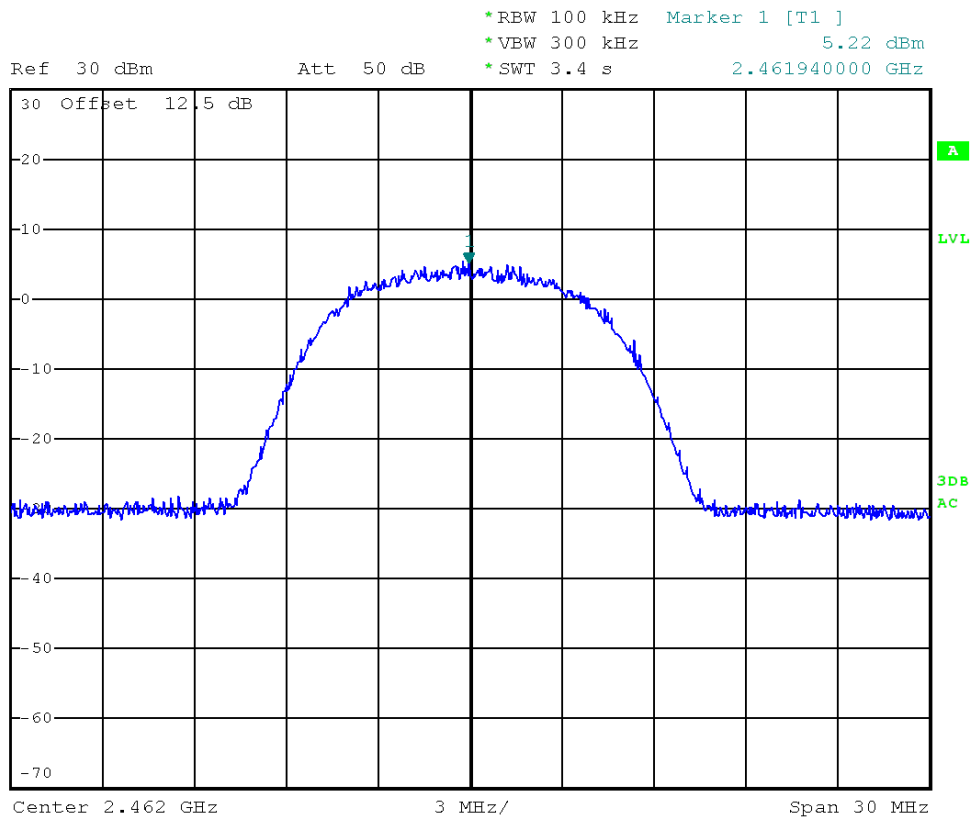

So the limit is -14.78dBm
30M-1G

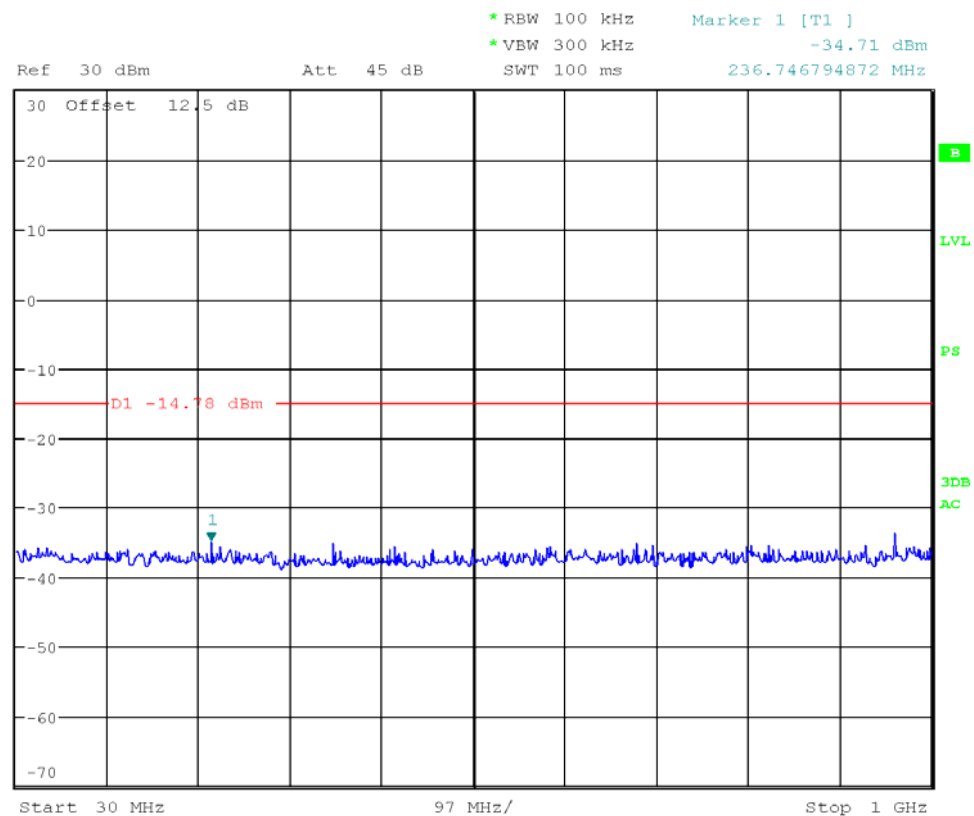

1G-10G

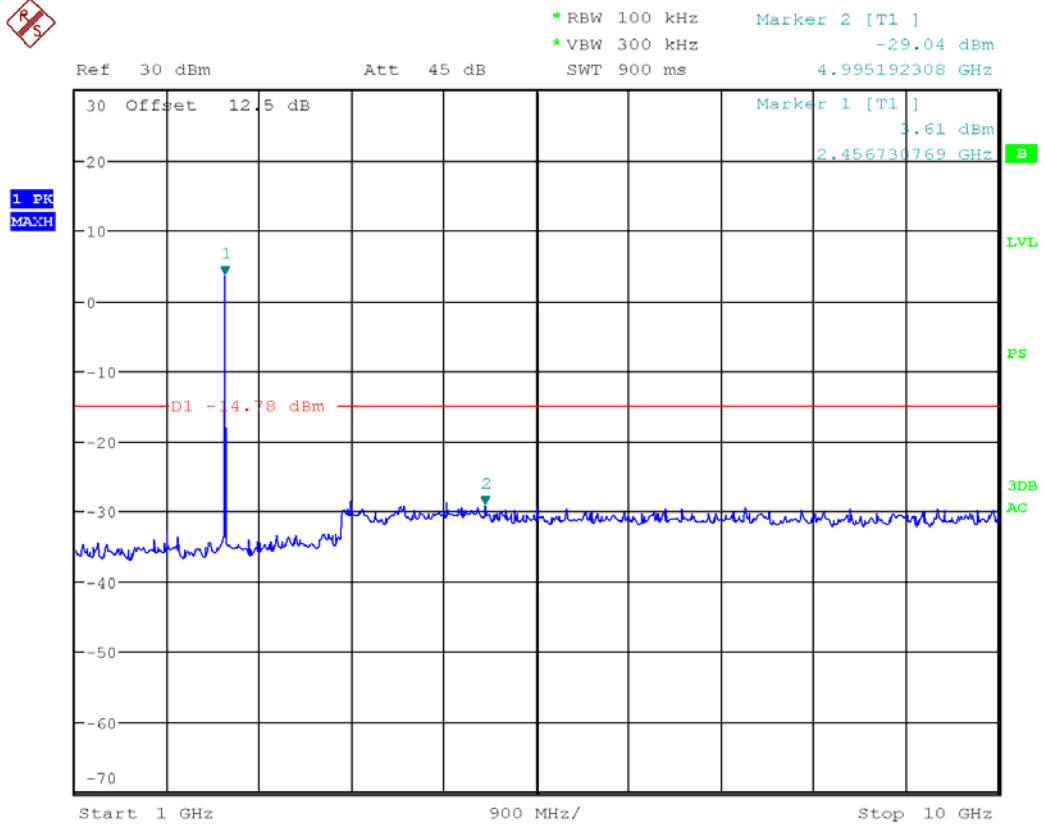

10G-25G

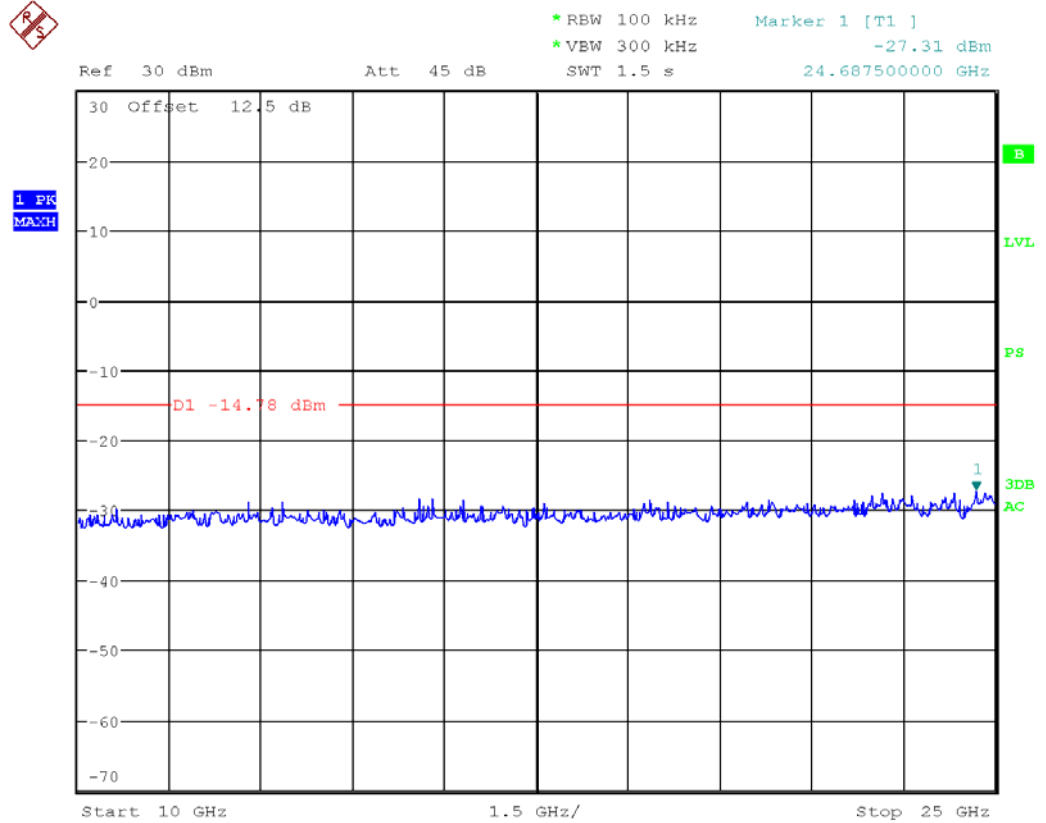

802.11g mode:
Channel 2412MHz
Reference level



Ref 30 dBm Att 50 dB *RBW 100 kHz Marker 1 [T1]
*VBW 300 kHz 2.62 dBm
*SWT 3.4 s 2.410740000 GHz

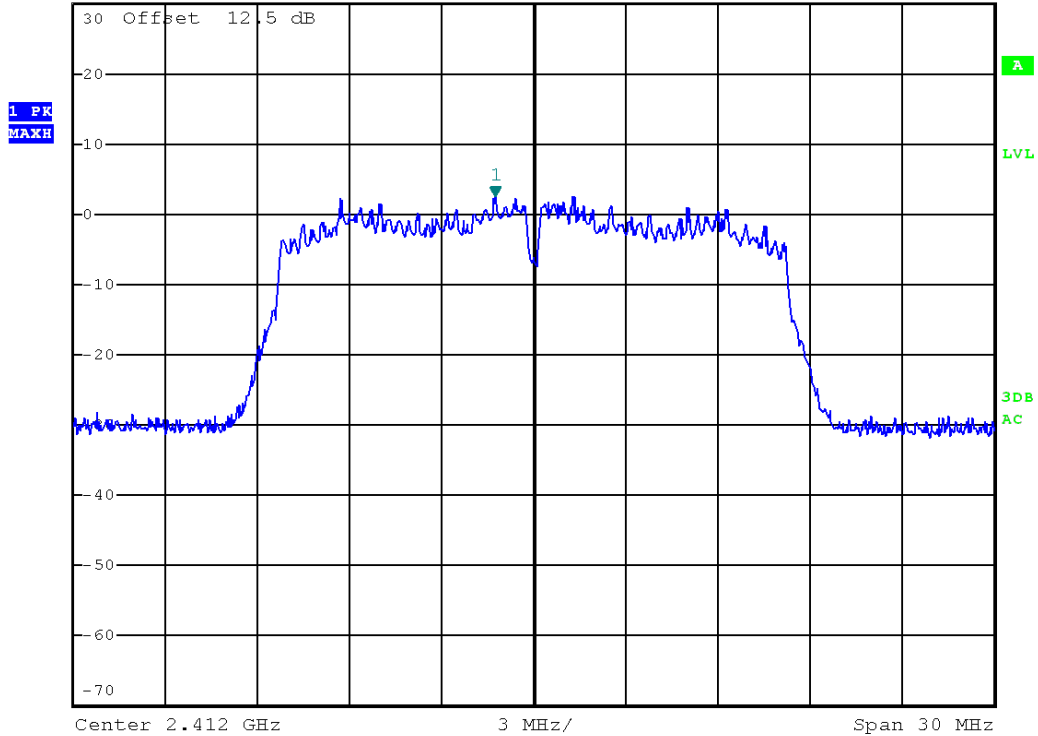

So the limit is -17.38dBm
30M-1G



Ref 30 dBm Att 45 dB *RBW 100 kHz Marker 1 [T1]
*VBW 300 kHz -34.68 dBm
SWT 100 ms 726.410256410 MHz

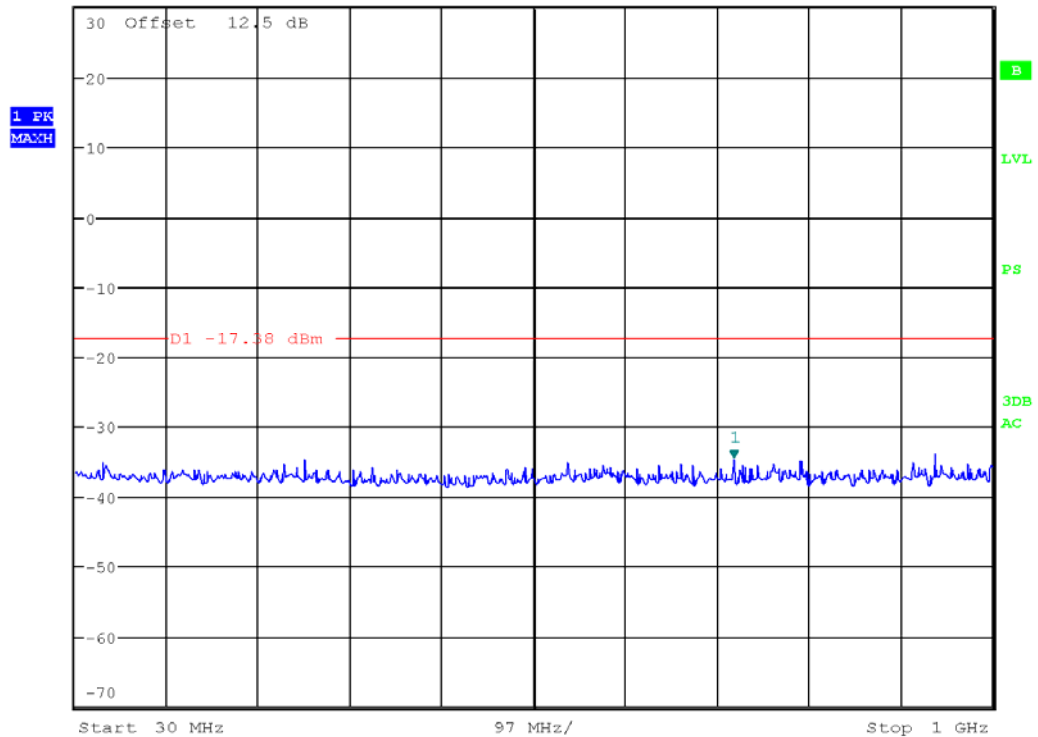

1G-10G

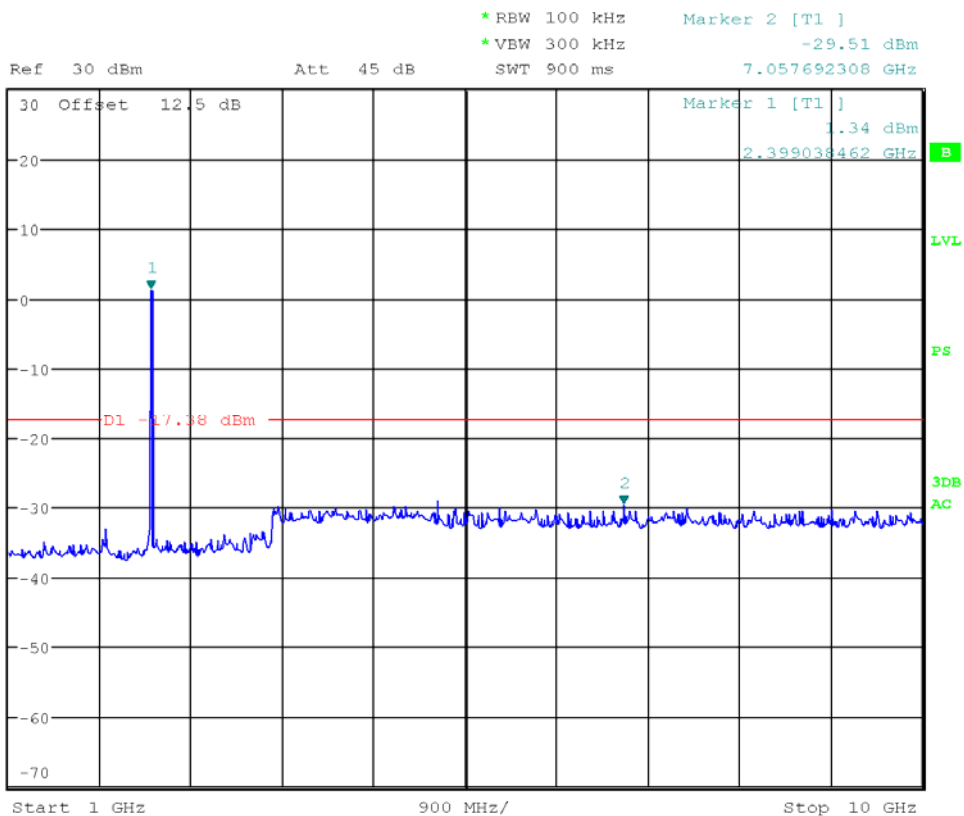

10G-25G

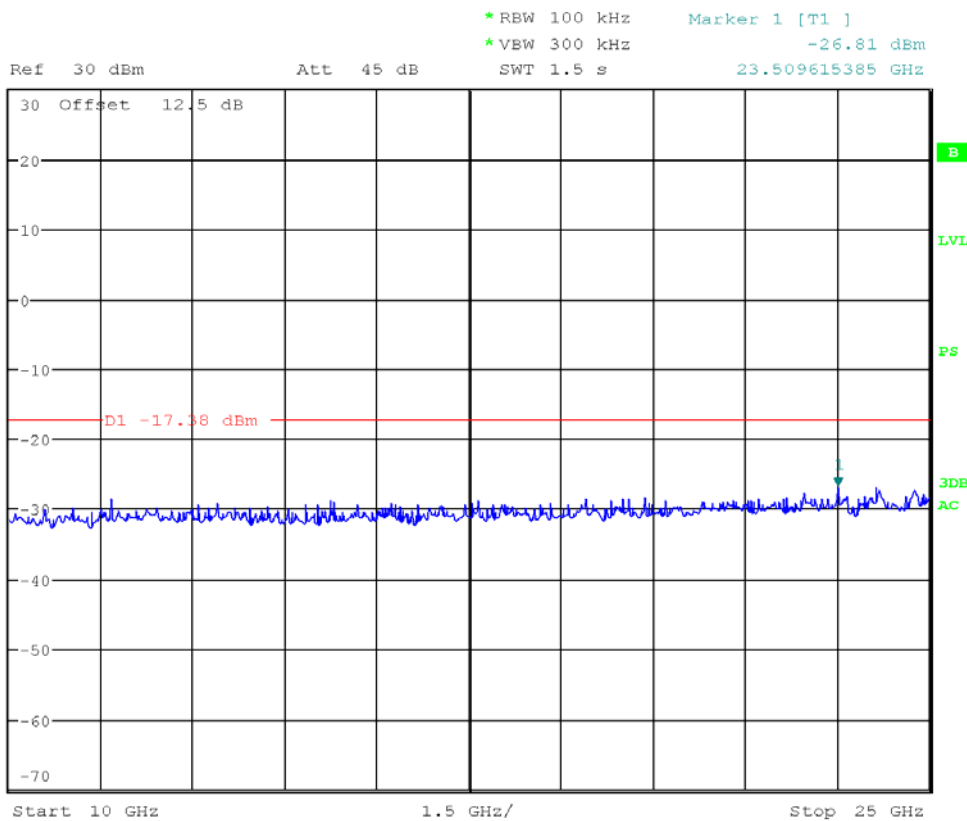

802.11g mode:
Channel 2437MHz
Reference level



Ref 30 dBm Att 50 dB
*RBW 100 kHz Marker 1 [T1]
*VBW 300 kHz 2.59 dBm
*SWT 3.4 s 2.438260000 GHz

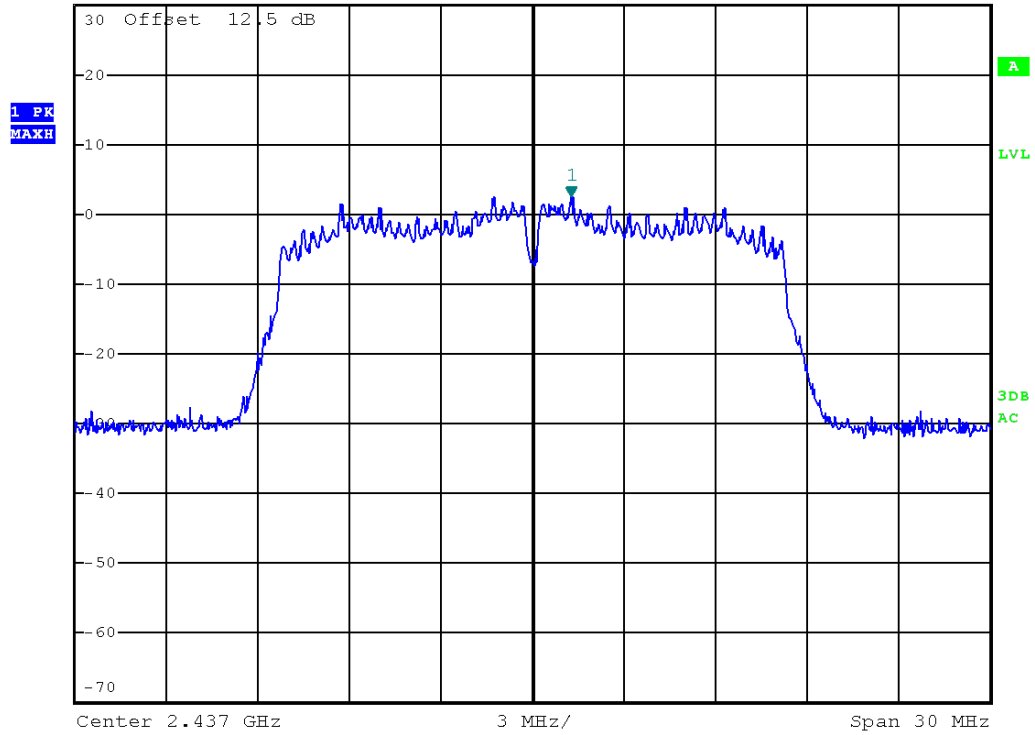

So the limit is -17.41dBm
30M-1G



Ref 30 dBm Att 45 dB
*RBW 100 kHz Marker 1 [T1]
*VBW 300 kHz -34.69 dBm
SWT 100 ms 577.179487179 MHz

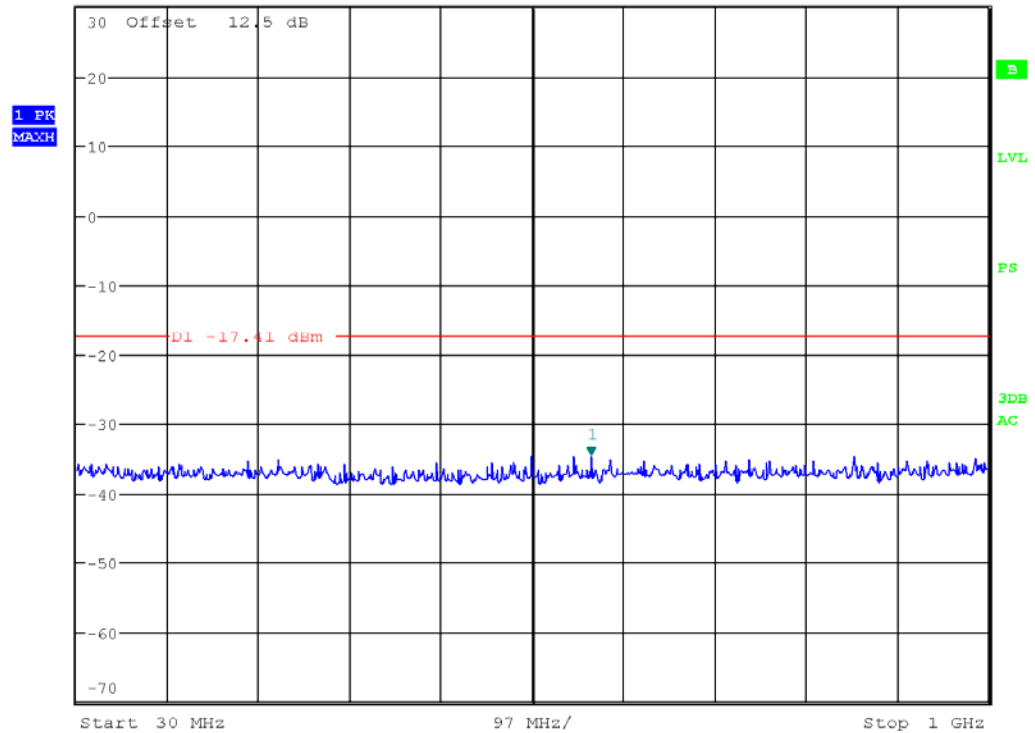

1G-10G

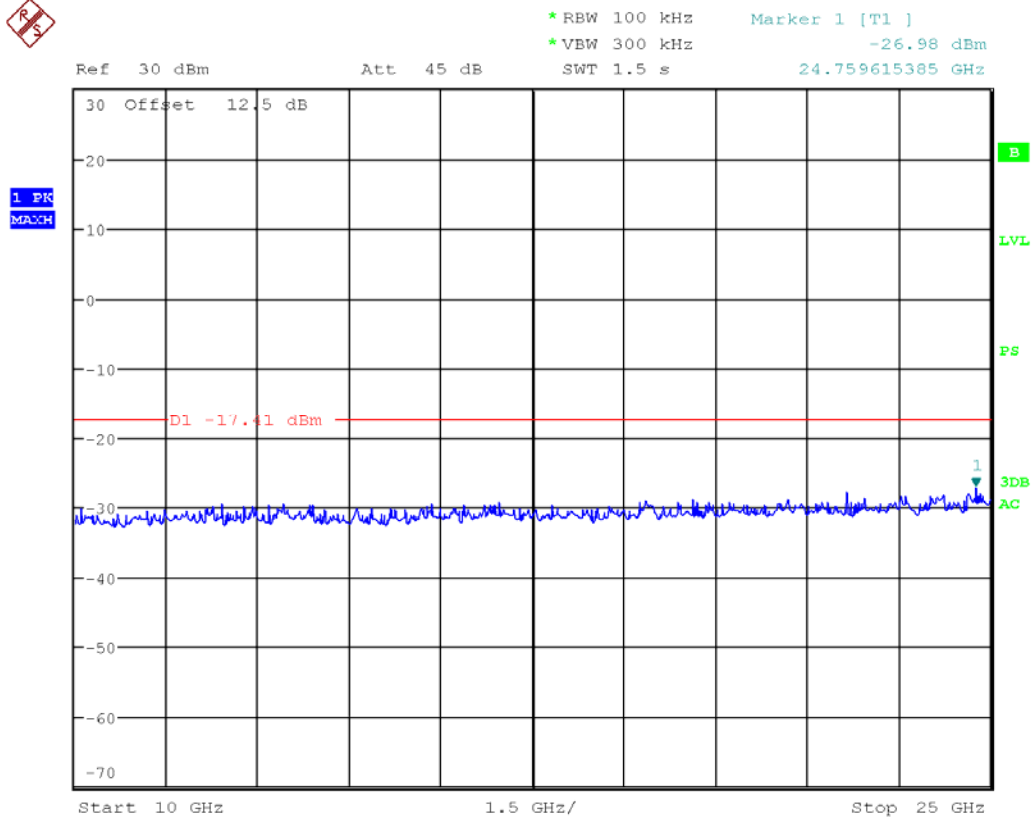

10G-25G

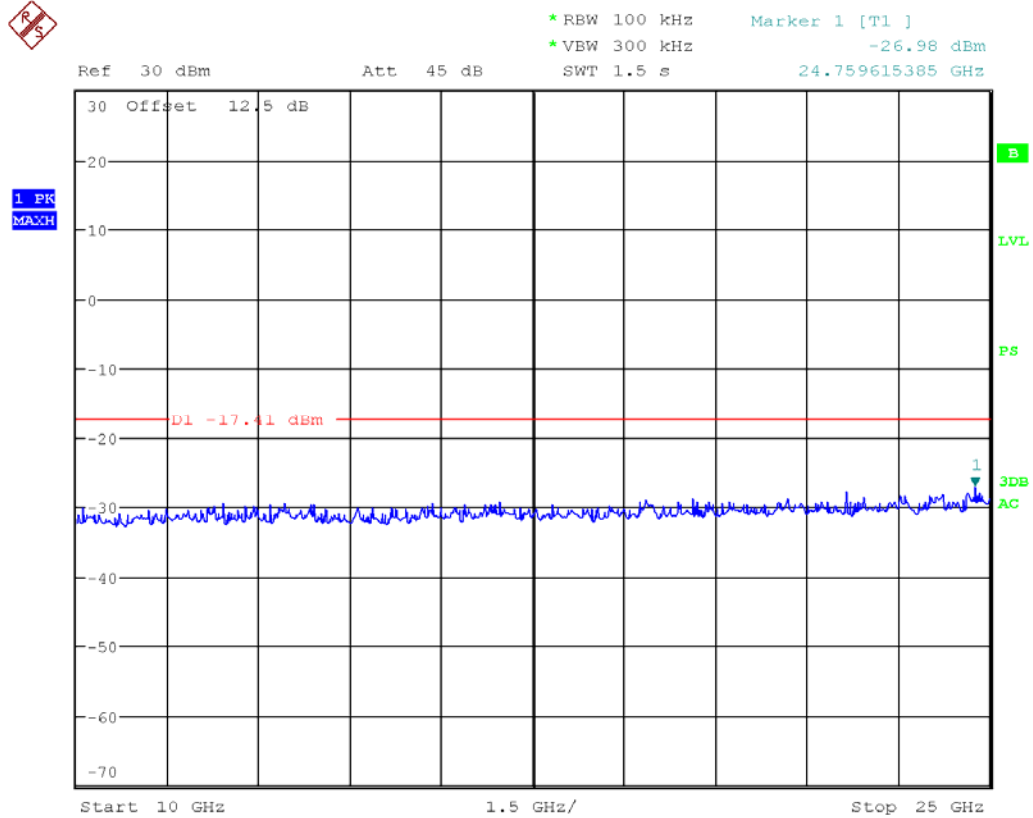

802.11g mode:
Channel 2462MHz
Reference level



Ref 30 dBm Att 50 dB *RBW 100 kHz Marker 1 [T1]
*VBW 300 kHz 3.08 dBm
*SWT 3.4 s 2.460740000 GHz

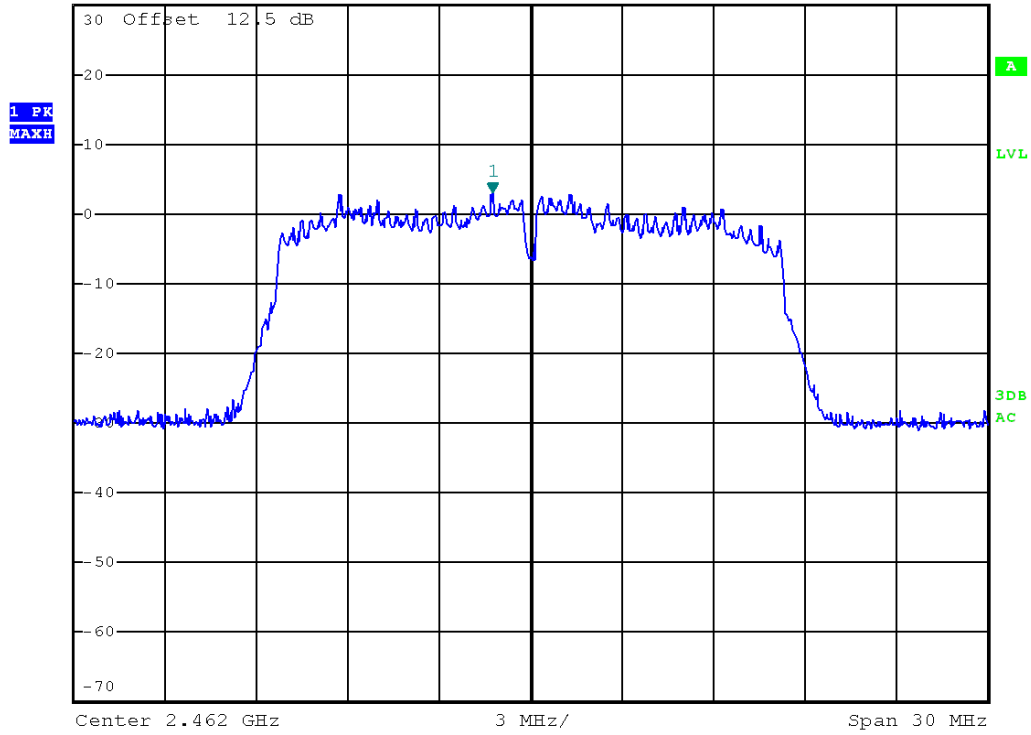

So the limit is -16.92dBm
30M-1G



Ref 30 dBm Att 45 dB *RBW 100 kHz Marker 1 [T1]
*VBW 300 kHz -34.32 dBm
SWT 100 ms 1.000000000 GHz

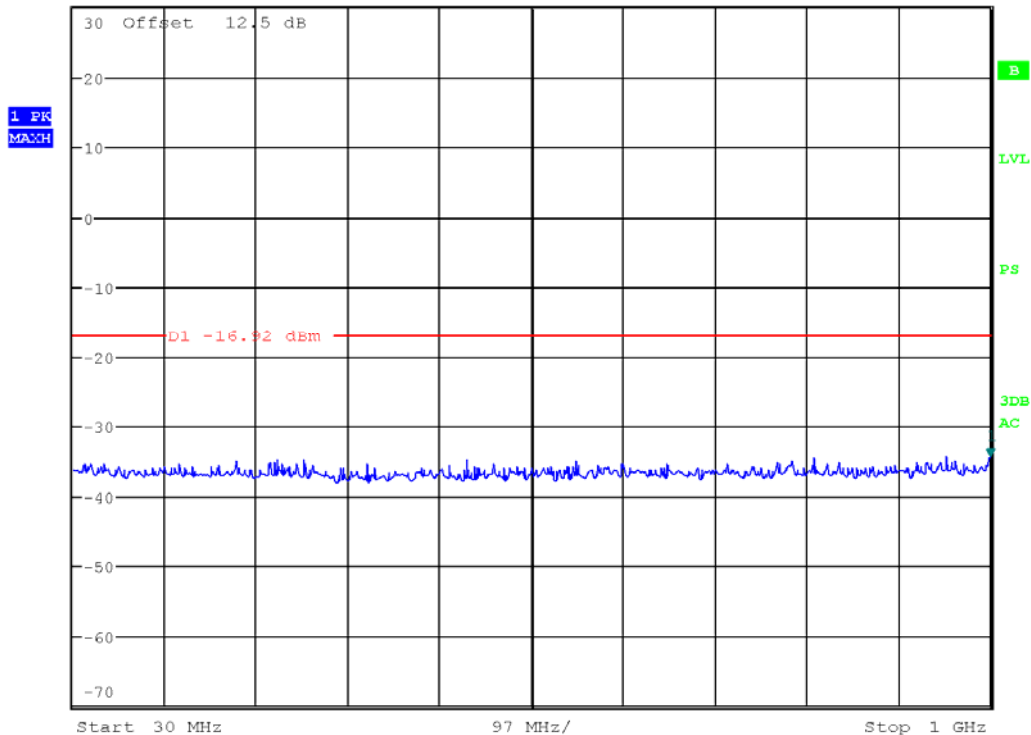

1G-10G

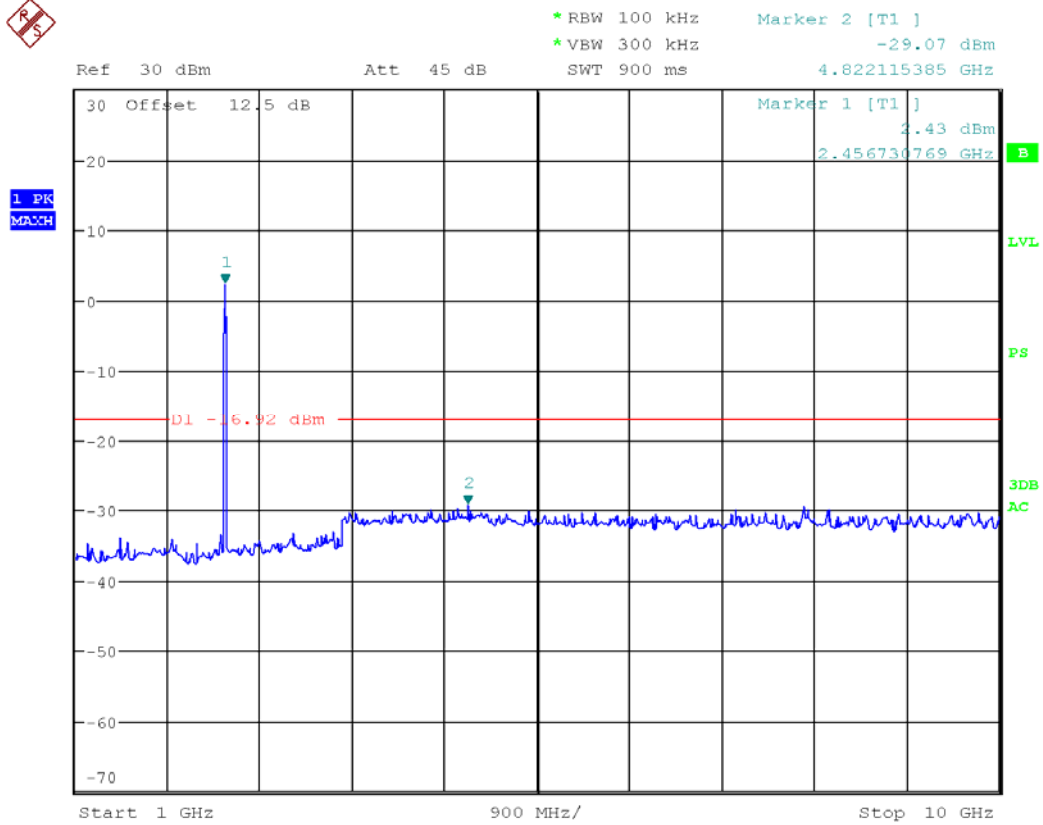

10G-25G

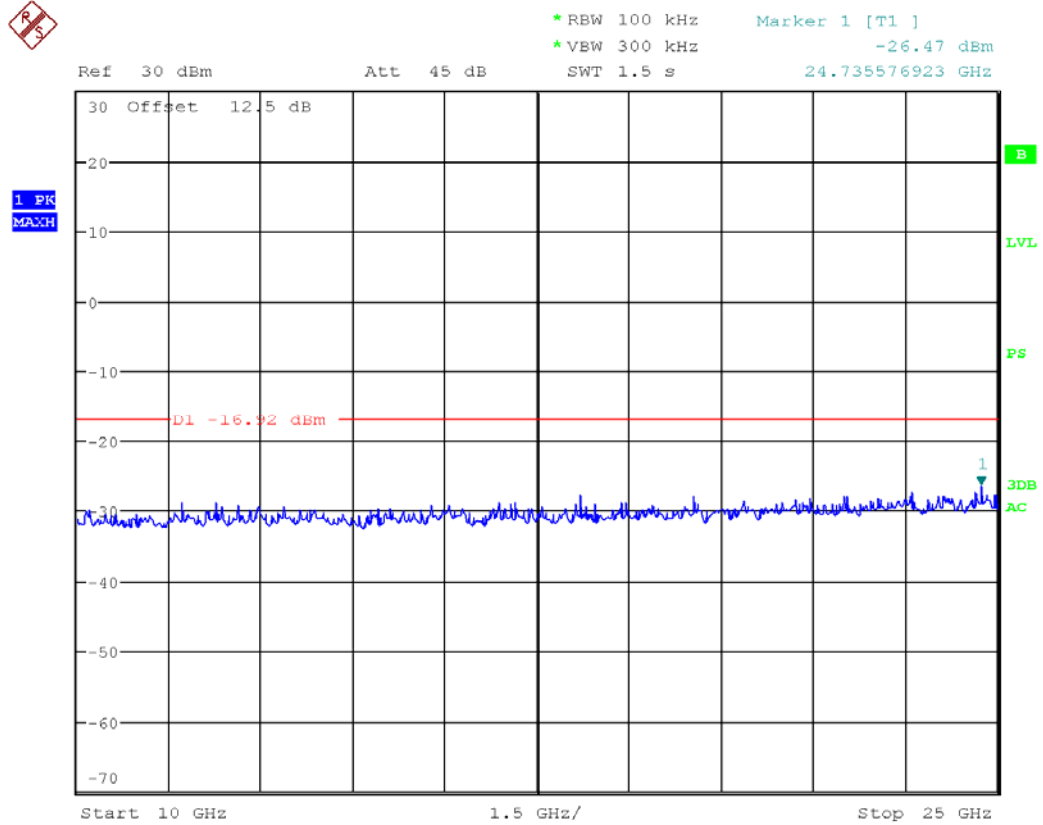

802.11n20 mode:
Channel 2412MHz
Reference level



Ref 30 dBm Att 50 dB *RBW 100 kHz Marker 1 [T1]
*VBW 300 kHz 3.06 dBm
*SWT 3.4 s 2.410740000 GHz

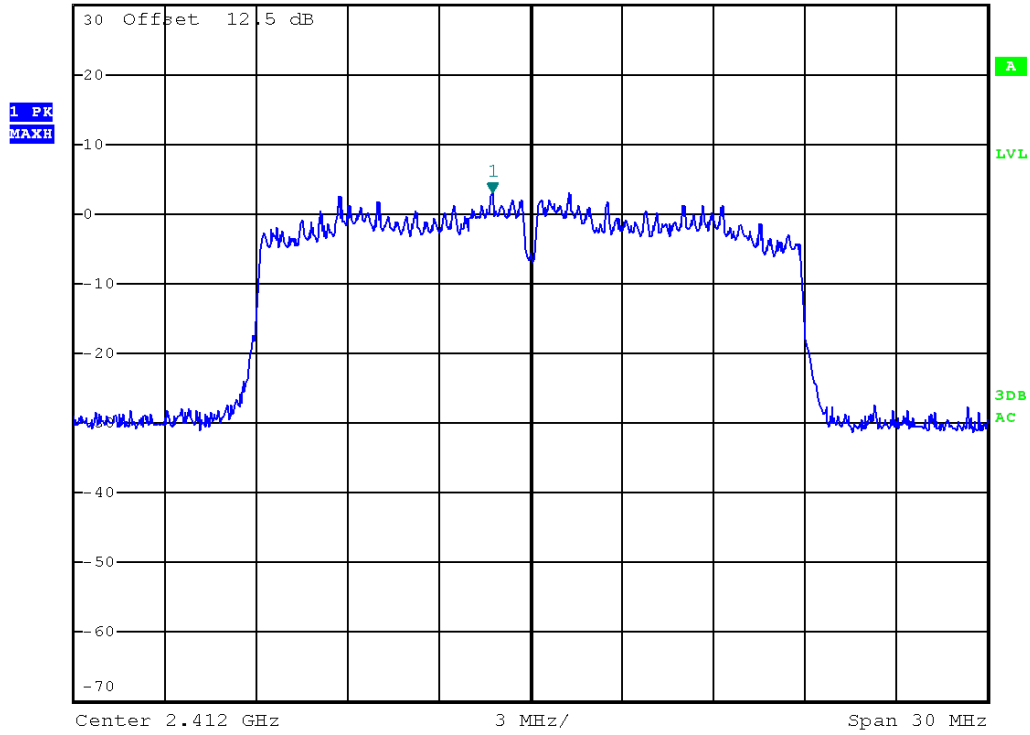

So the limit is -16.94dBm
30M-1G



Ref 30 dBm Att 45 dB *RBW 100 kHz Marker 1 [T1]
*VBW 300 kHz -33.46 dBm
SWT 100 ms 992.227564103 MHz

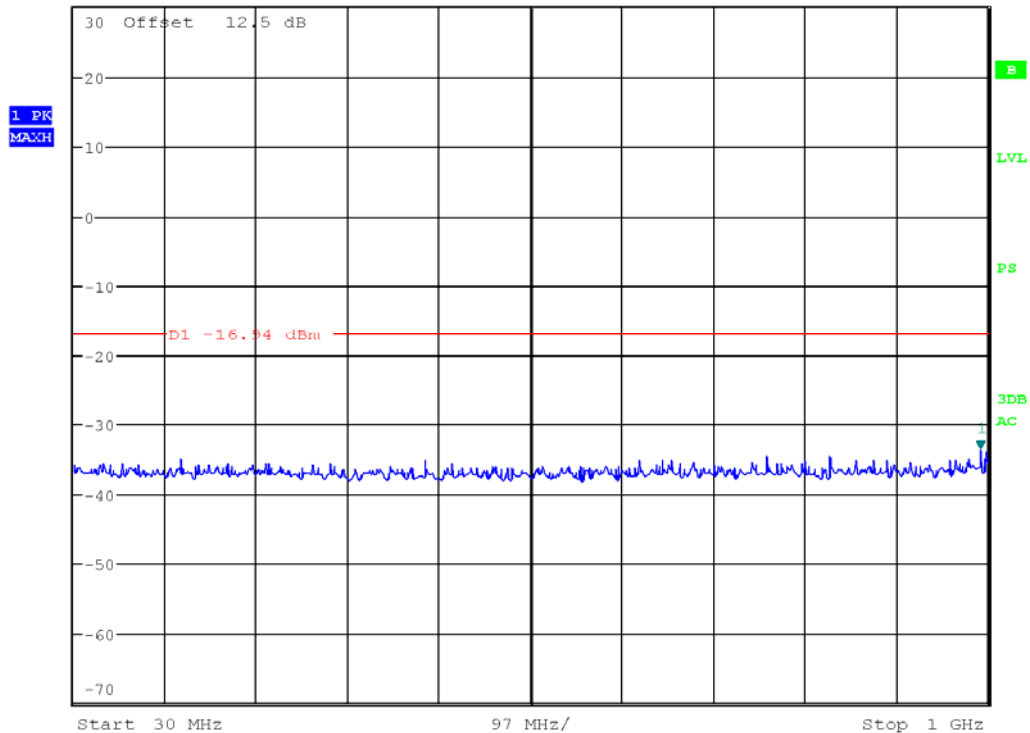

1G-10G

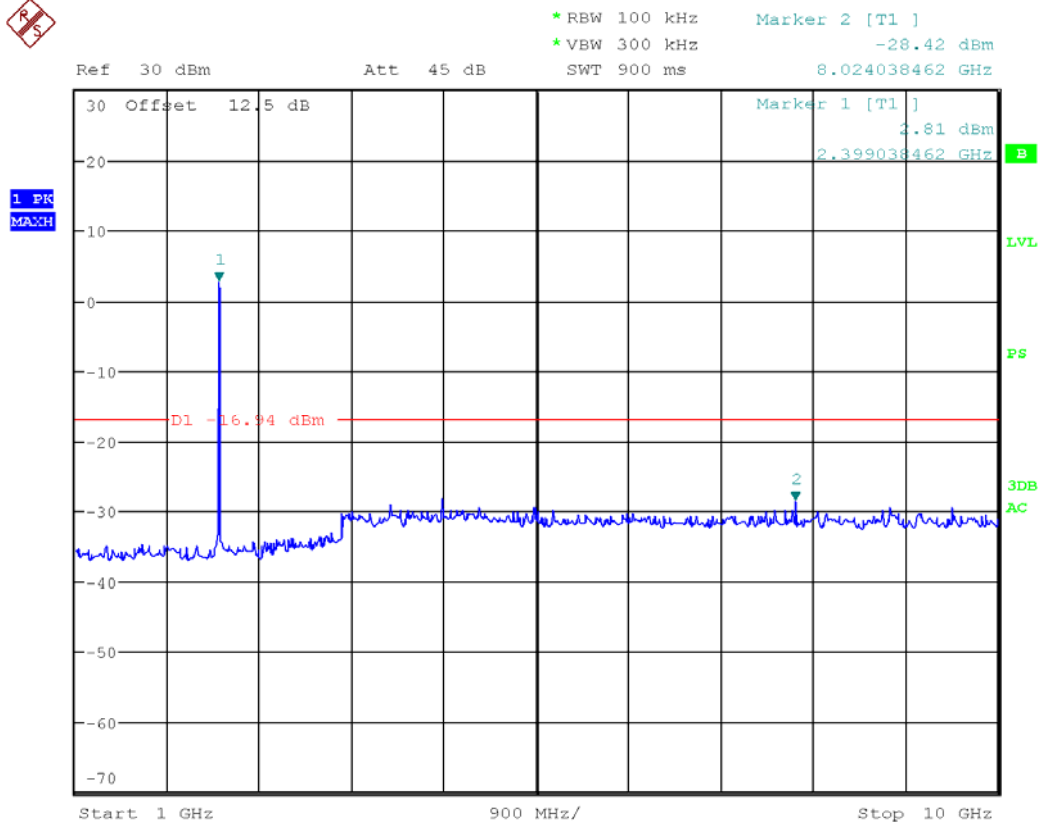

10G-25G

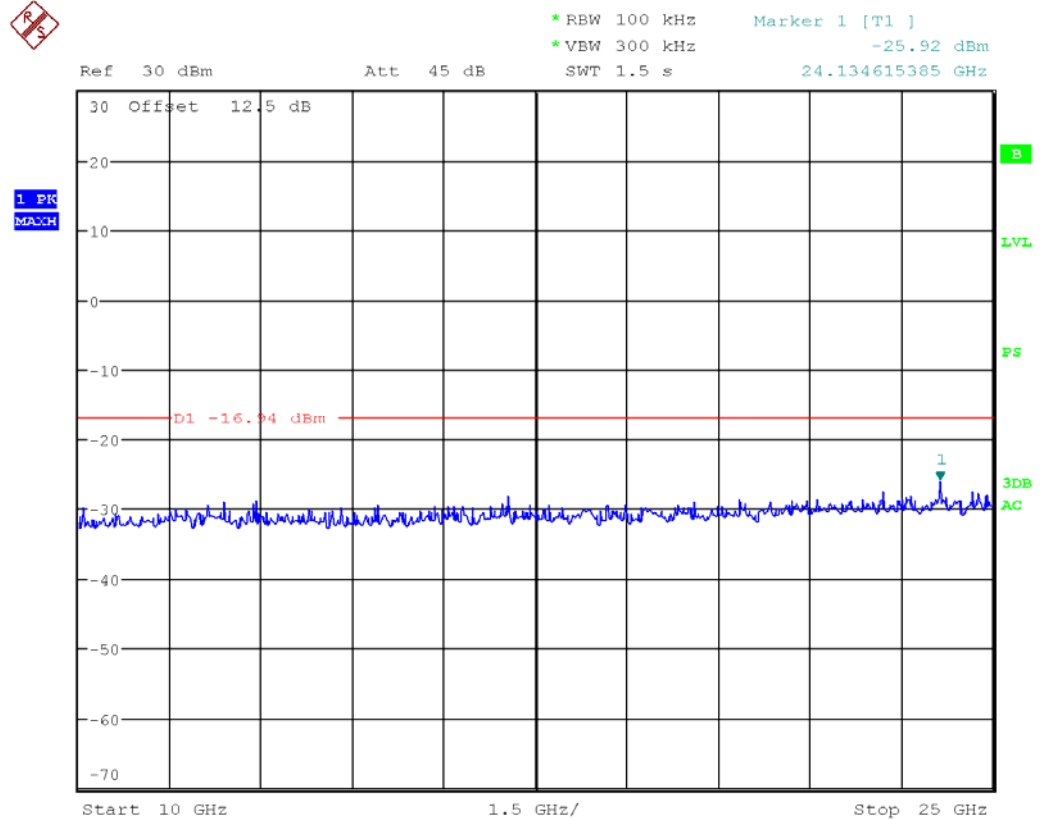

802.11n20 mode:
Channel 2437MHz
Reference level



Ref 30 dBm Att 50 dB
*RBW 100 kHz Marker 1 [T1]
*VBW 300 kHz 2.95 dBm
*SWT 3.4 s 2.438260000 GHz

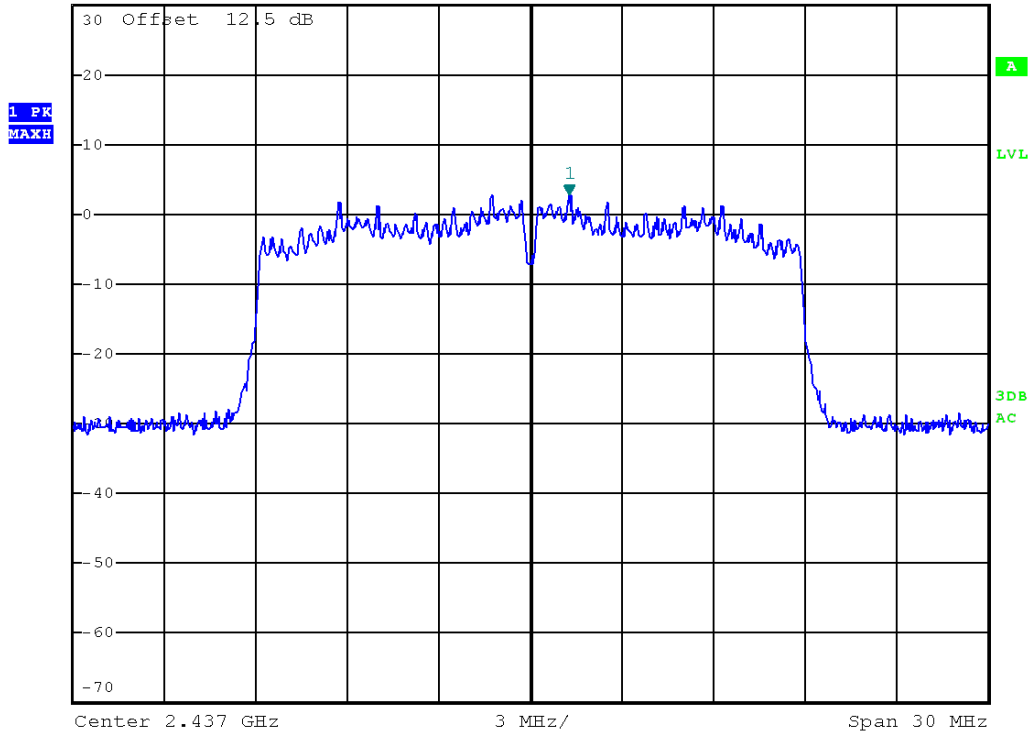

So the limit is -17.05dBm
30M-1G



Ref 30 dBm Att 45 dB
*RBW 100 kHz Marker 1 [T1]
*VBW 300 kHz -34.69 dBm
SWT 100 ms 982.900641026 MHz

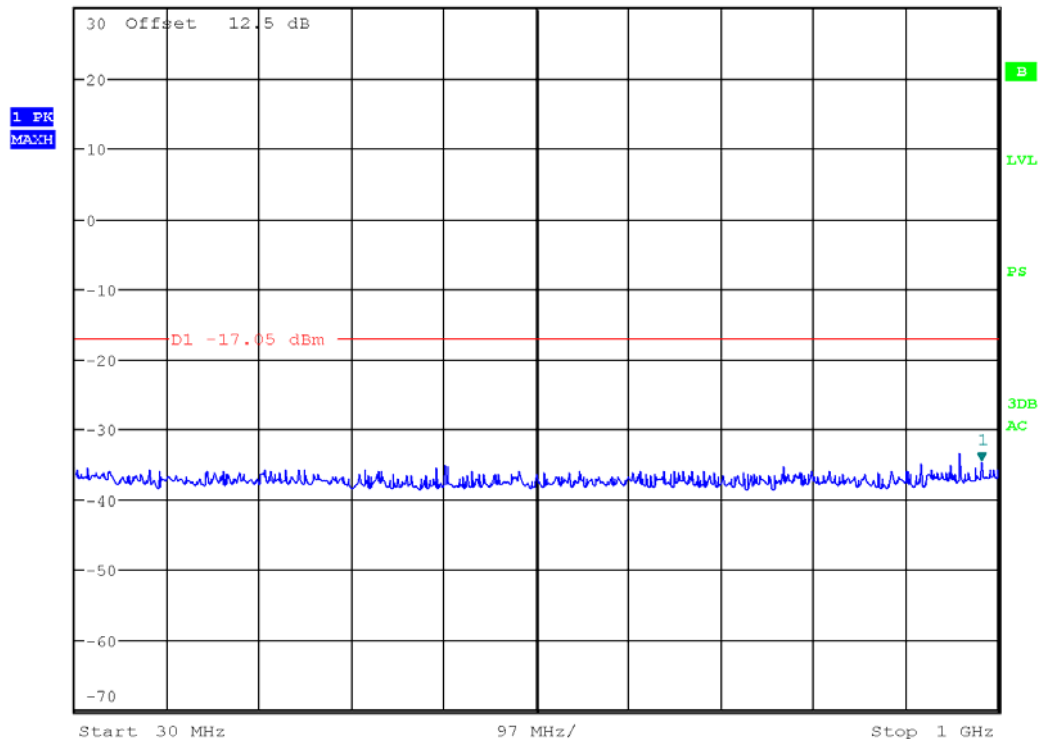

1G-10G

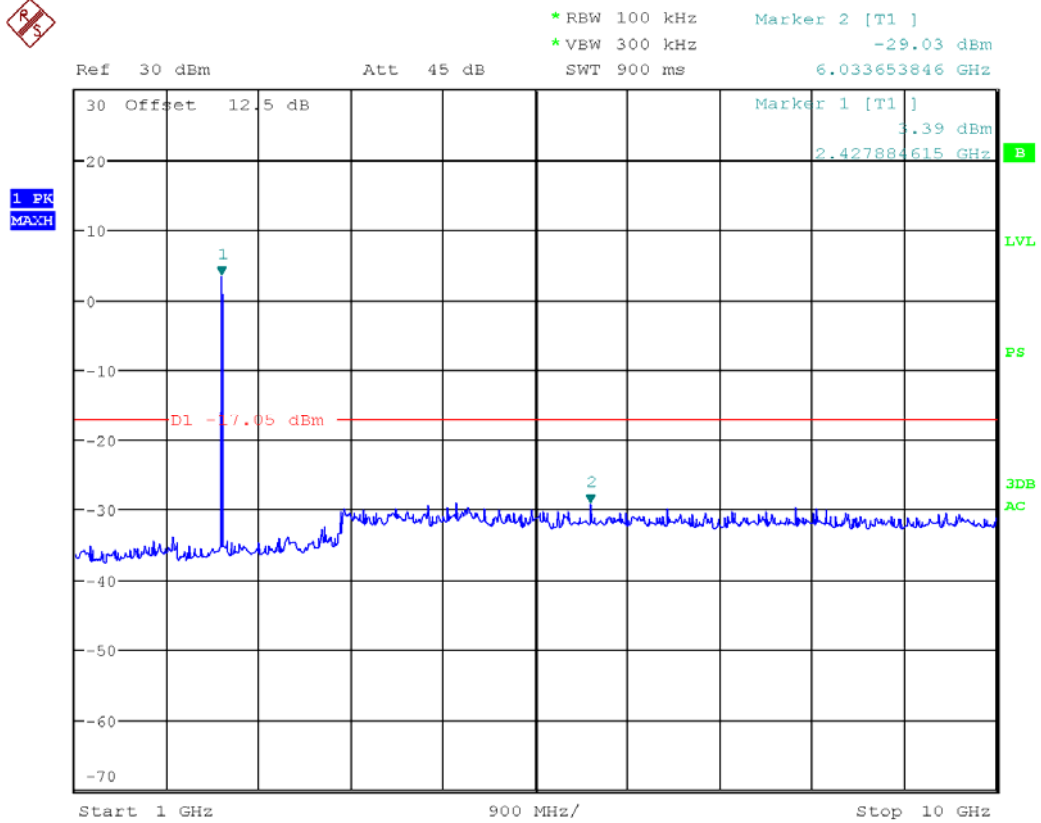

10G-25G

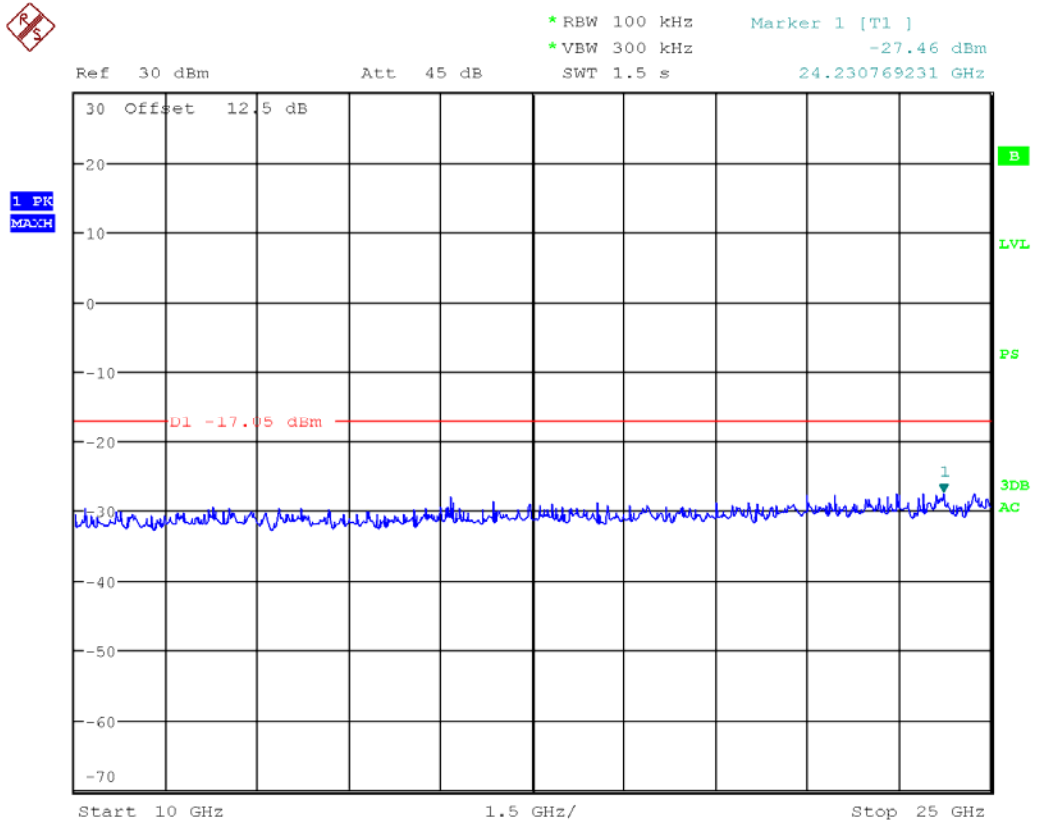

802.11n20 mode:
Channel 2462MHz
Reference level

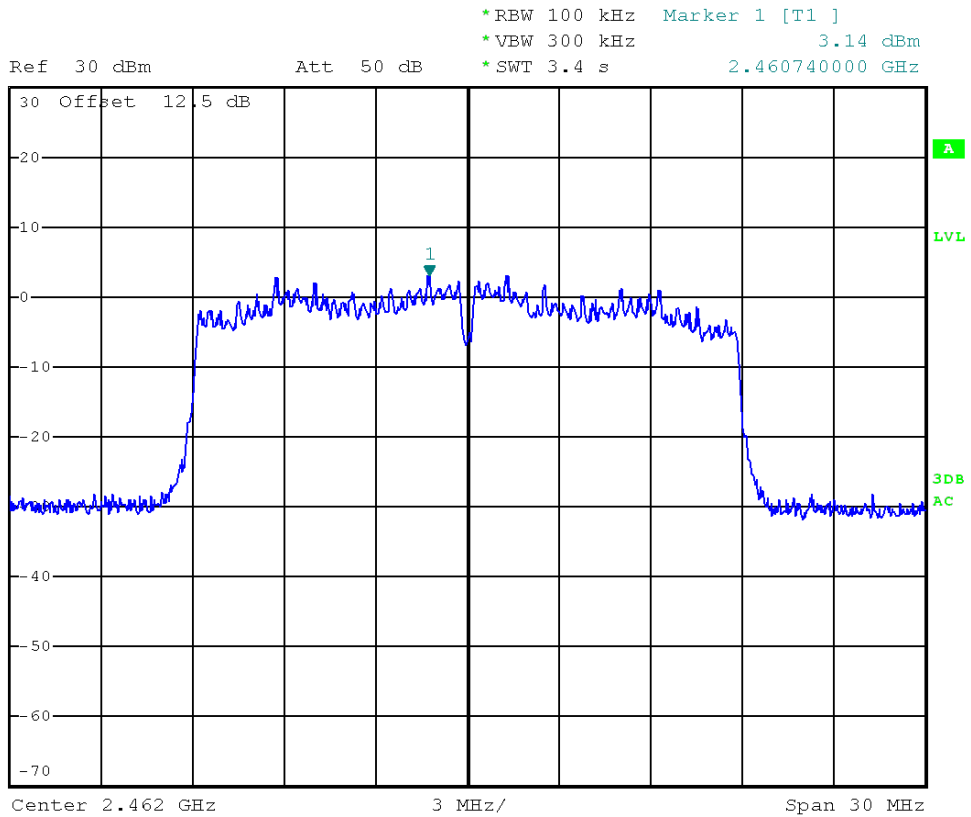

So the limit is -16.86dBm
30M-1G

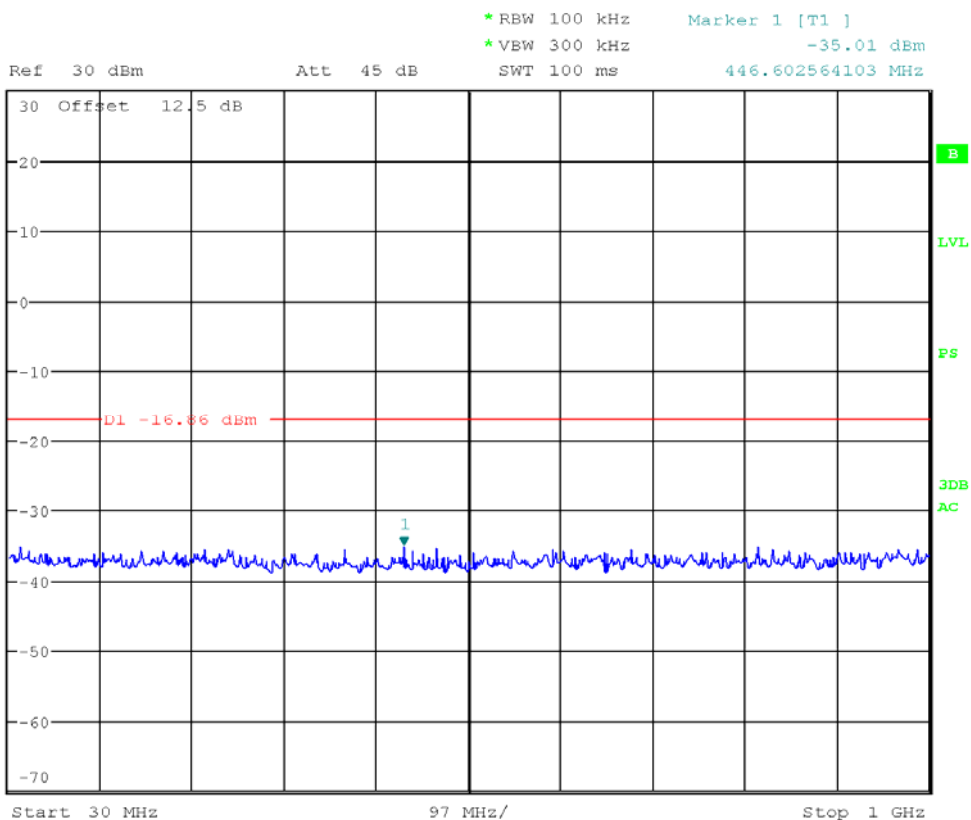

1G-10G

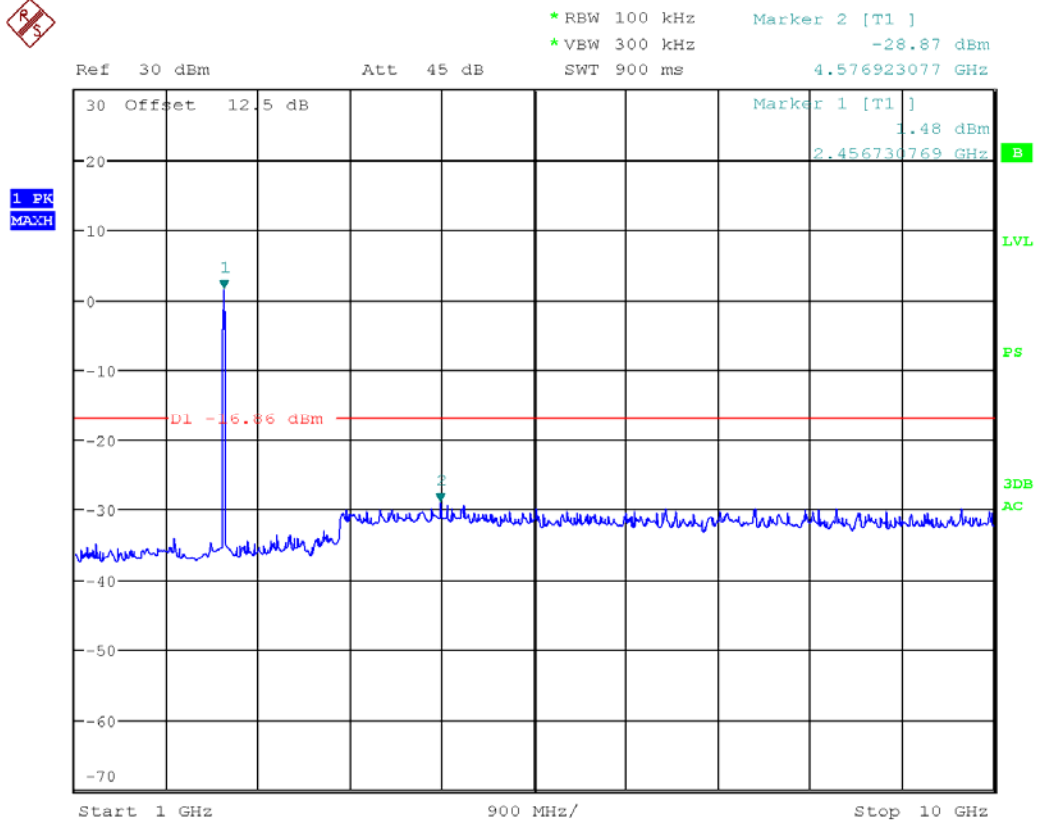

10G-25G

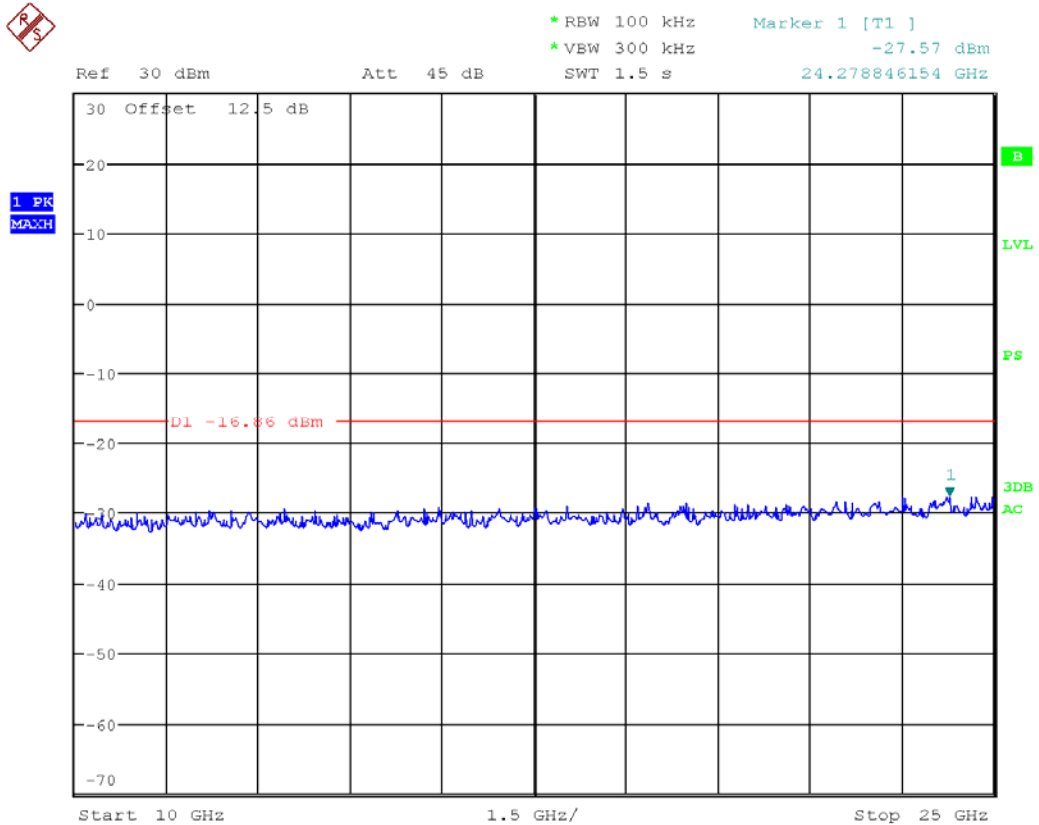

802.11n40 mode:
Channel 2422MHz
Reference level



Ref 30 dBm Att 50 dB *RBW 100 kHz Marker 1 [T1]
*VBW 300 kHz -0.83 dBm
*SWT 6.8 s 2.419480000 GHz

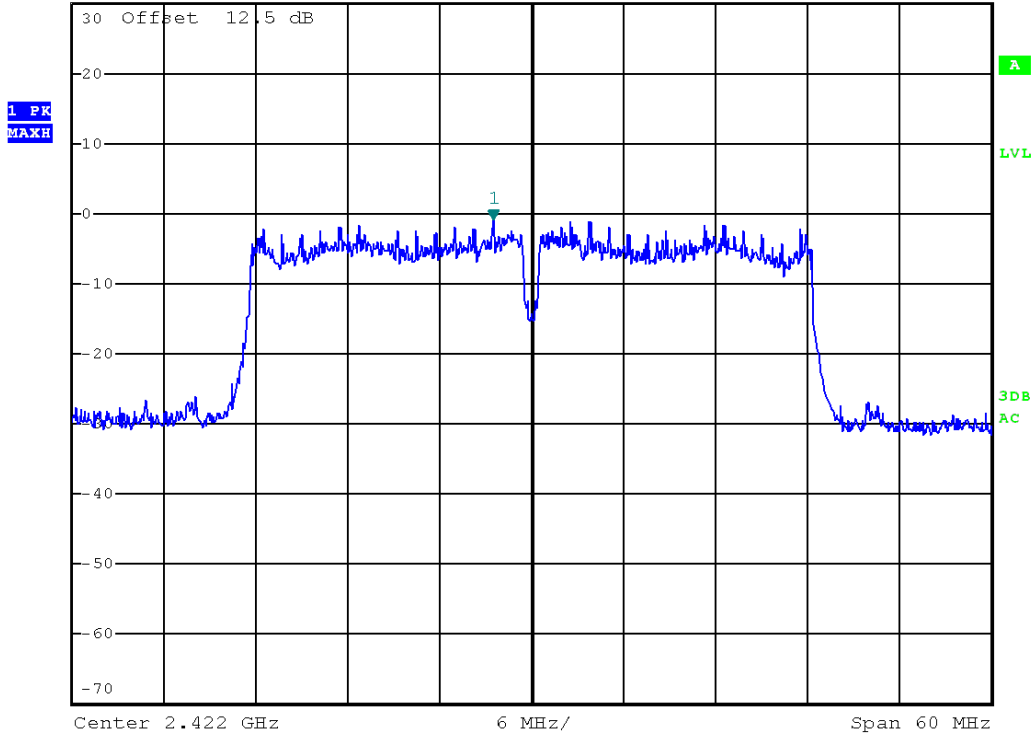

So the limit is -20.83dBm
30M-1G



Ref 30 dBm Att 45 dB *RBW 100 kHz Marker 1 [T1]
*VBW 300 kHz -34.99 dBm
SWT 100 ms 216.538461538 MHz

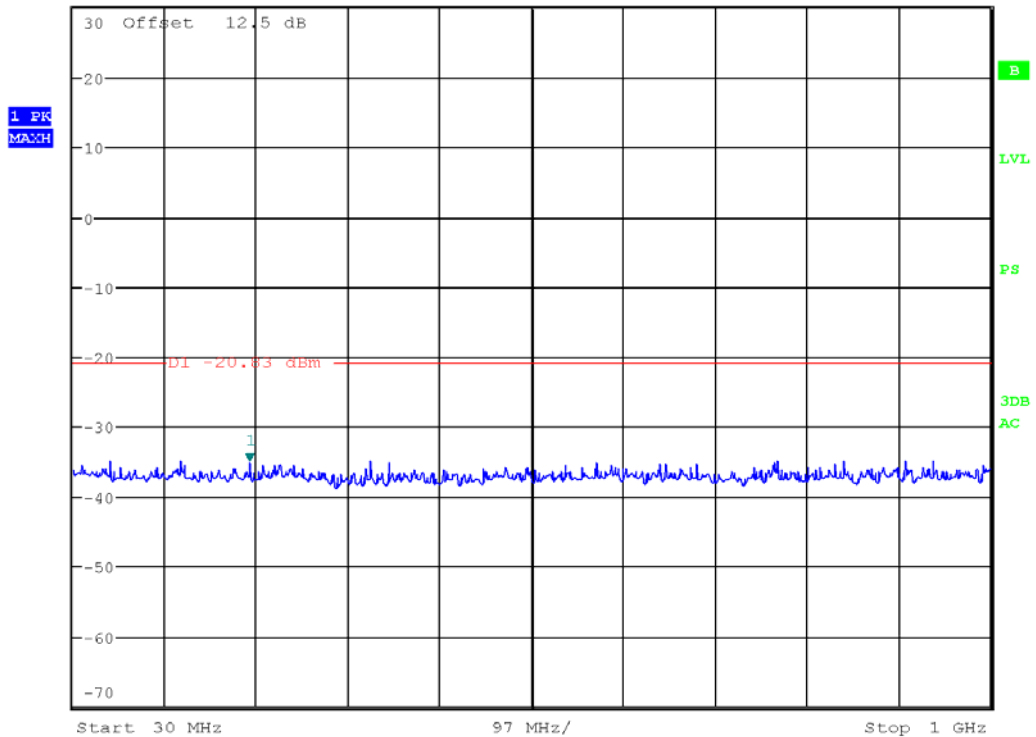

1G-10G

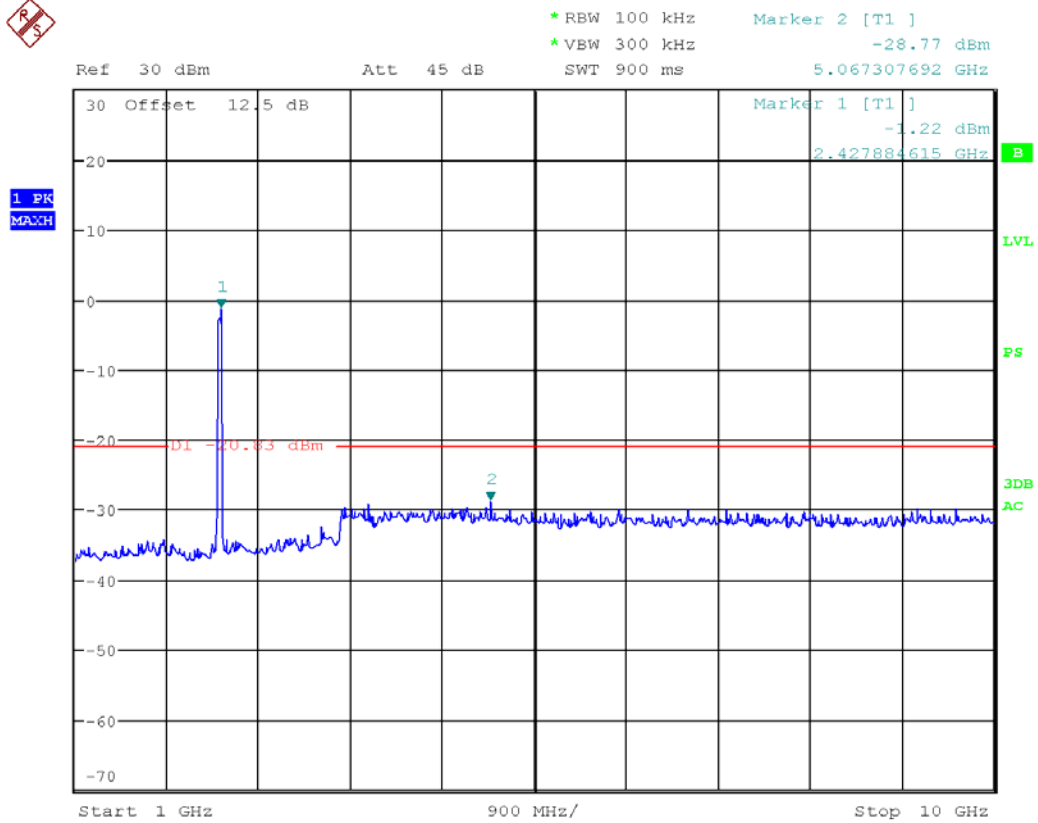

10G-25G

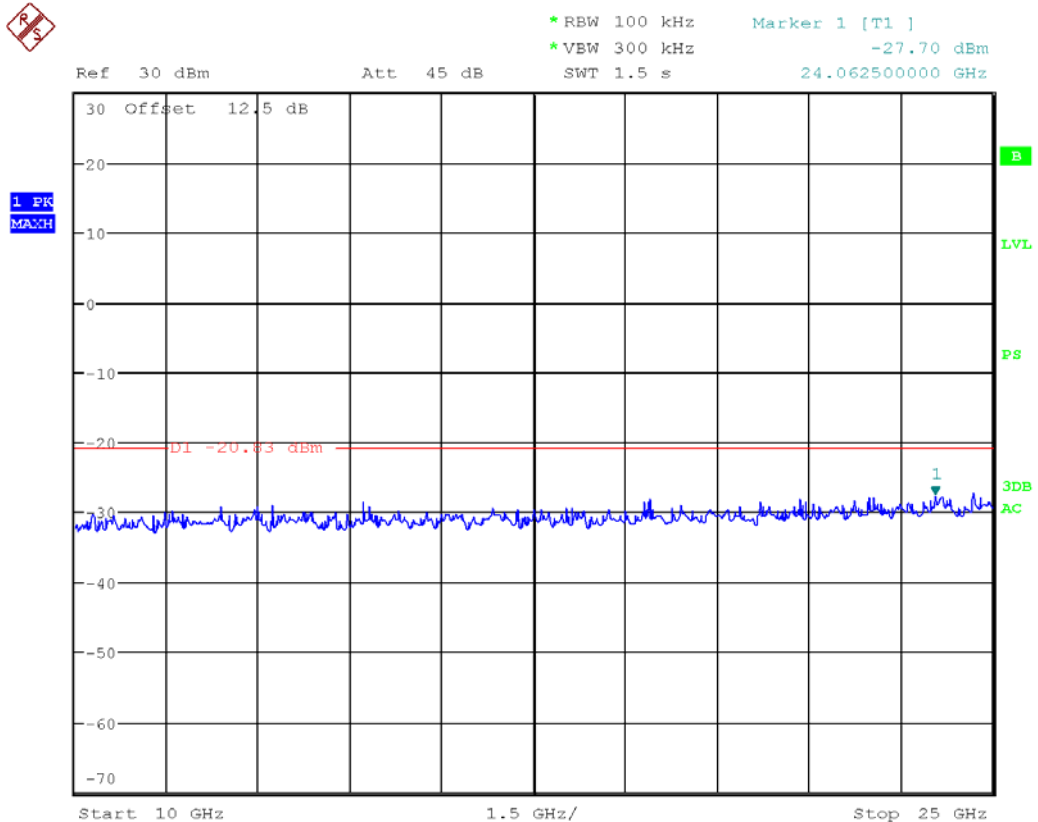

802.11n40 mode:
Channel 2437MHz
Reference level

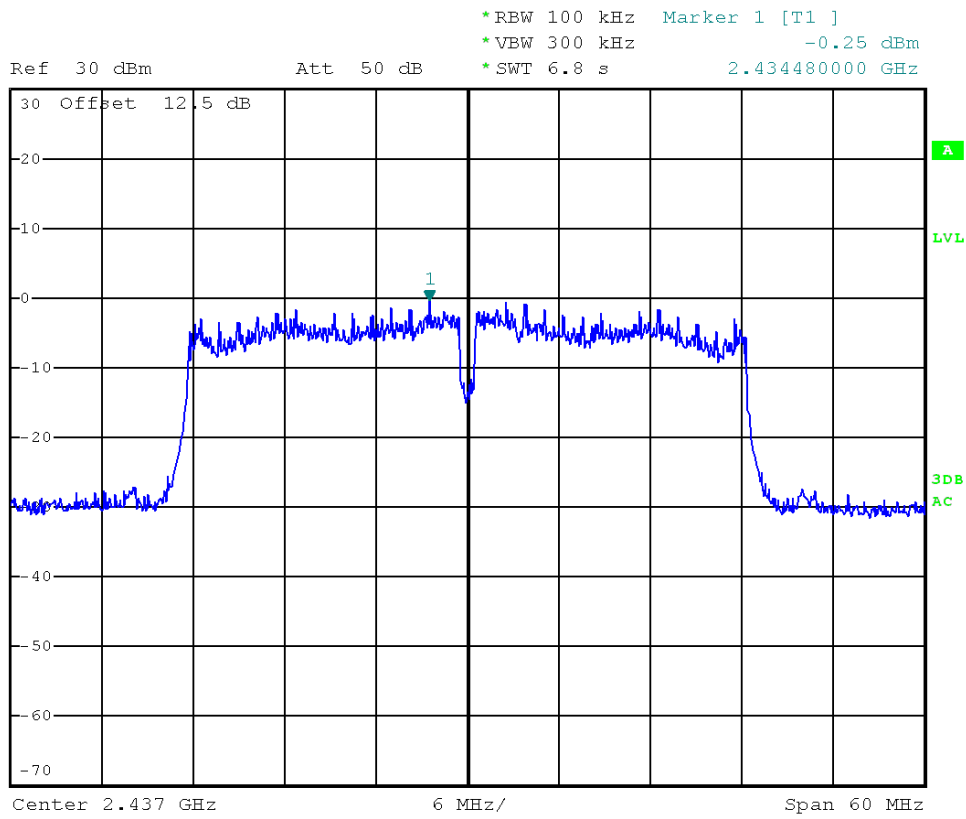

So the limit is -20.25dBm
30M-1G

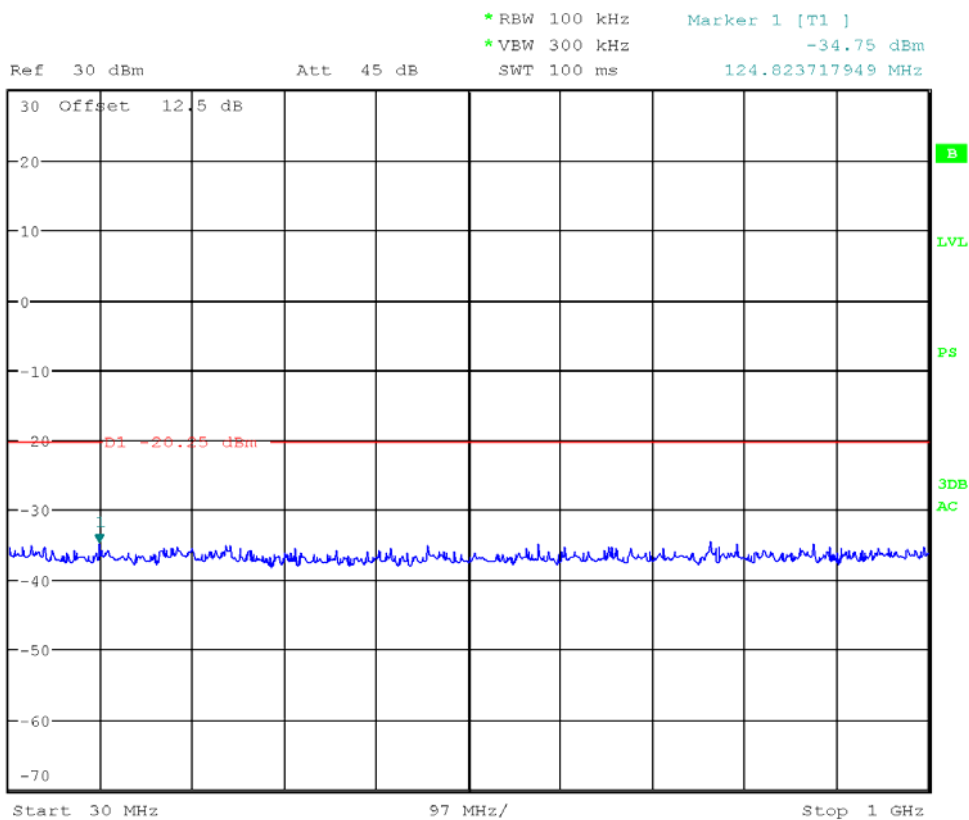

1G-10G

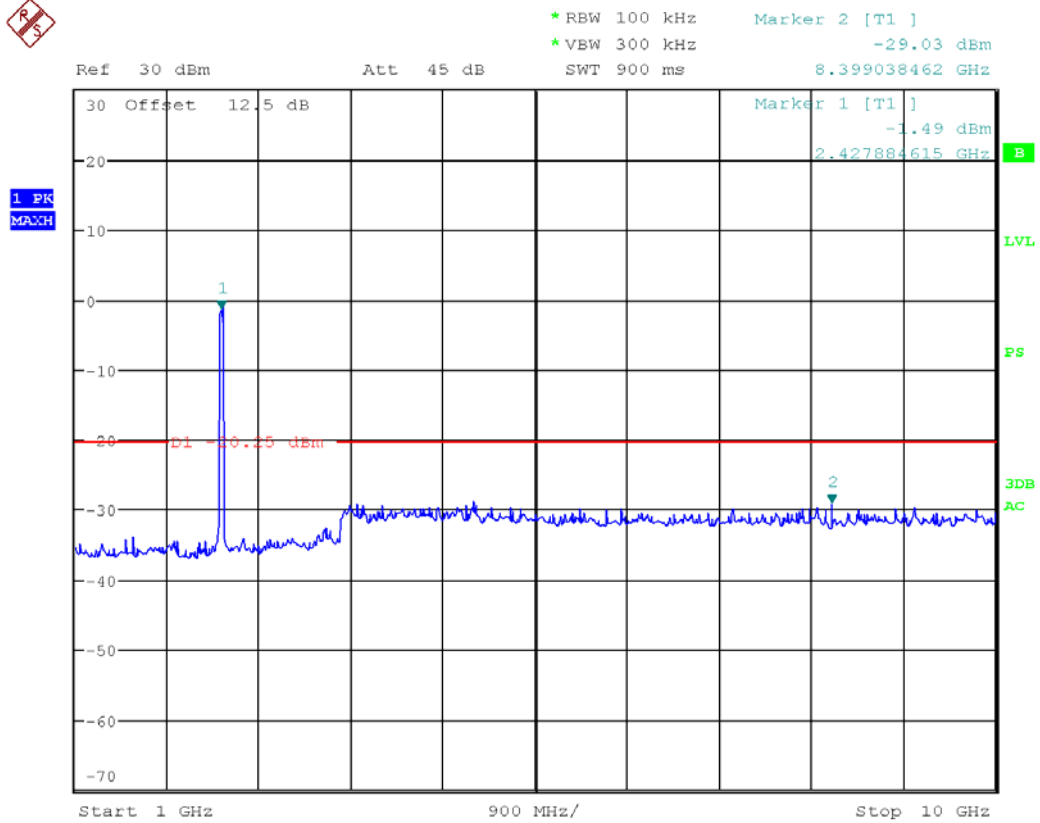

10G-25G

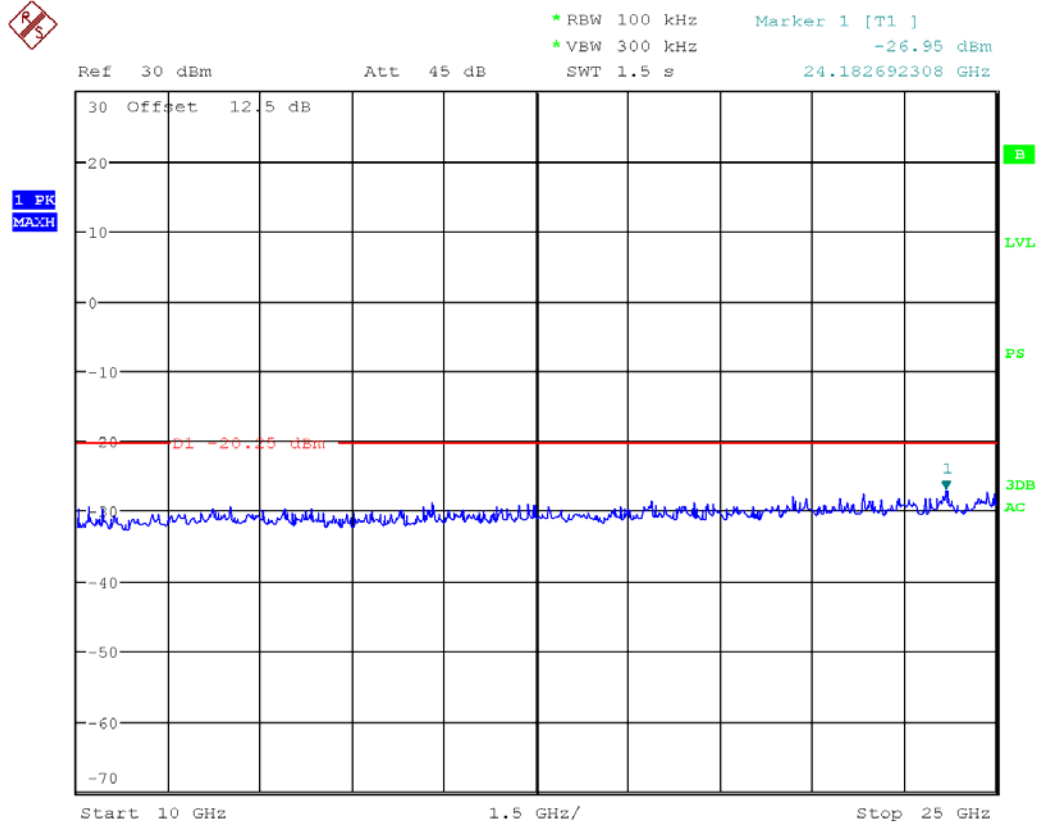

802.11n40 mode:
Channel 2452MHz
Reference level



Ref 30 dBm Att 50 dB *RBW 100 kHz Marker 1 [T1]
*VBW 300 kHz 0.46 dBm
*SWT 6.8 s 2.449480000 GHz

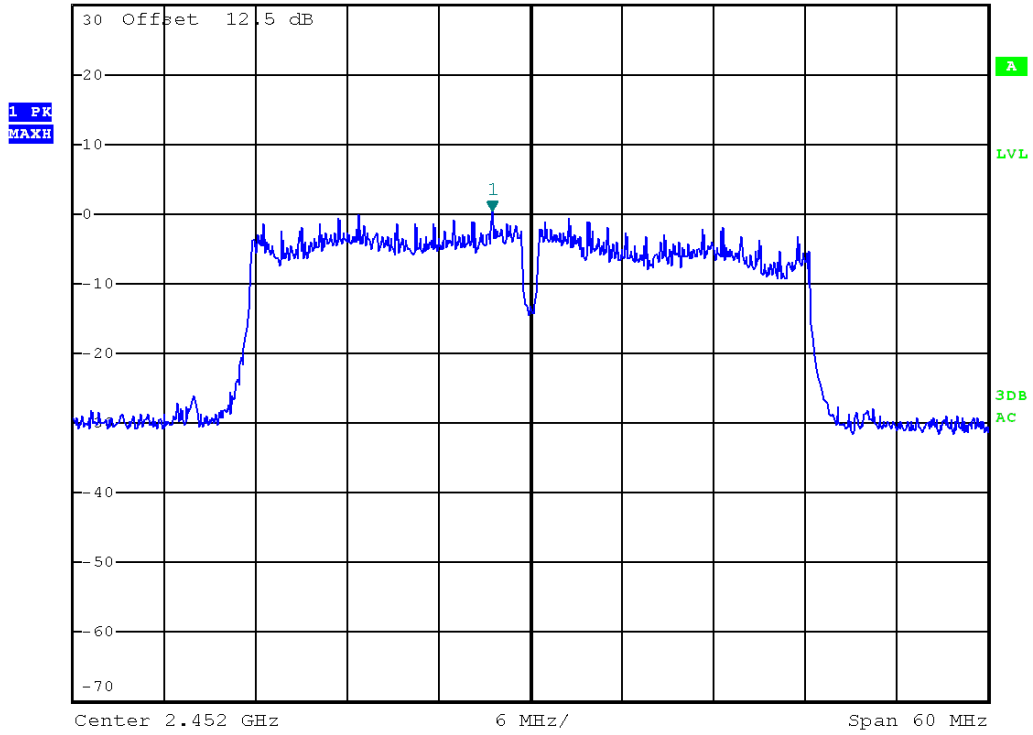

So the limit is -19.54dBm
30M-1G



Ref 30 dBm Att 45 dB *RBW 100 kHz Marker 1 [T1]
*VBW 300 kHz -35.07 dBm
SWT 100 ms 365.769230769 MHz

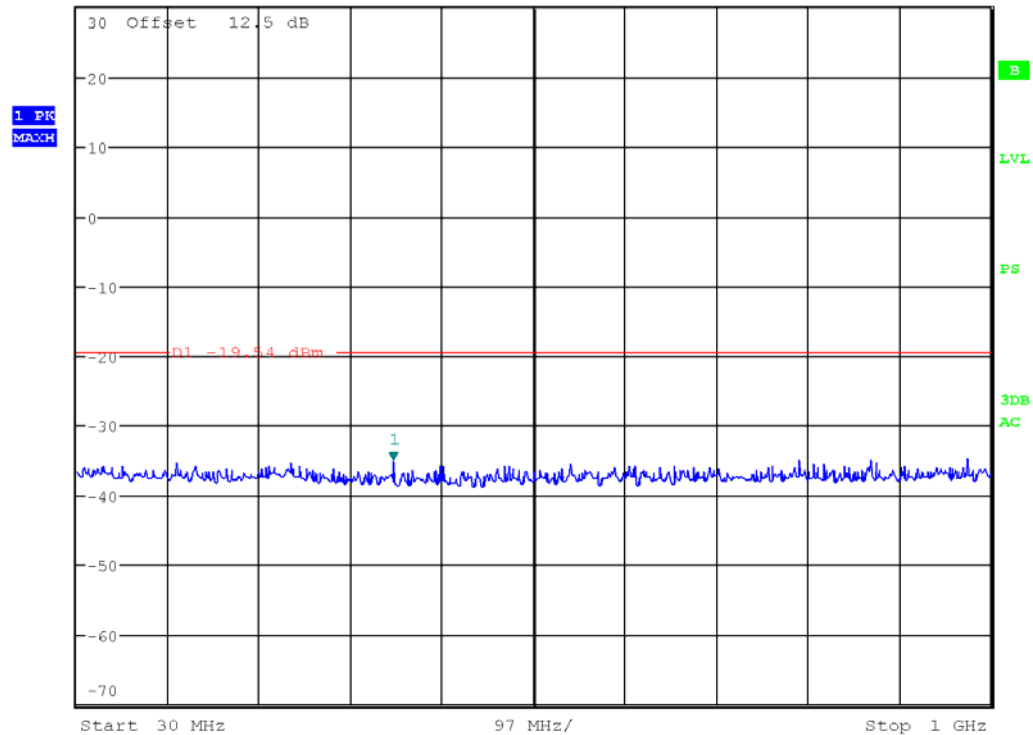

1G-10G

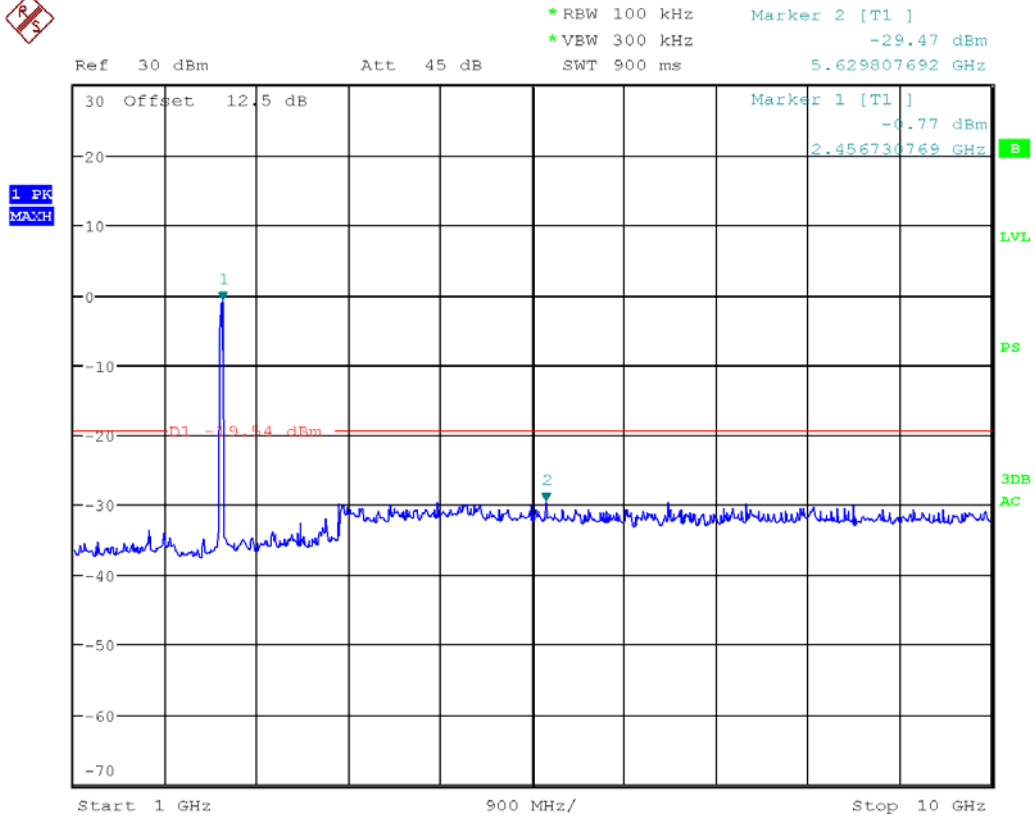

10G-25G

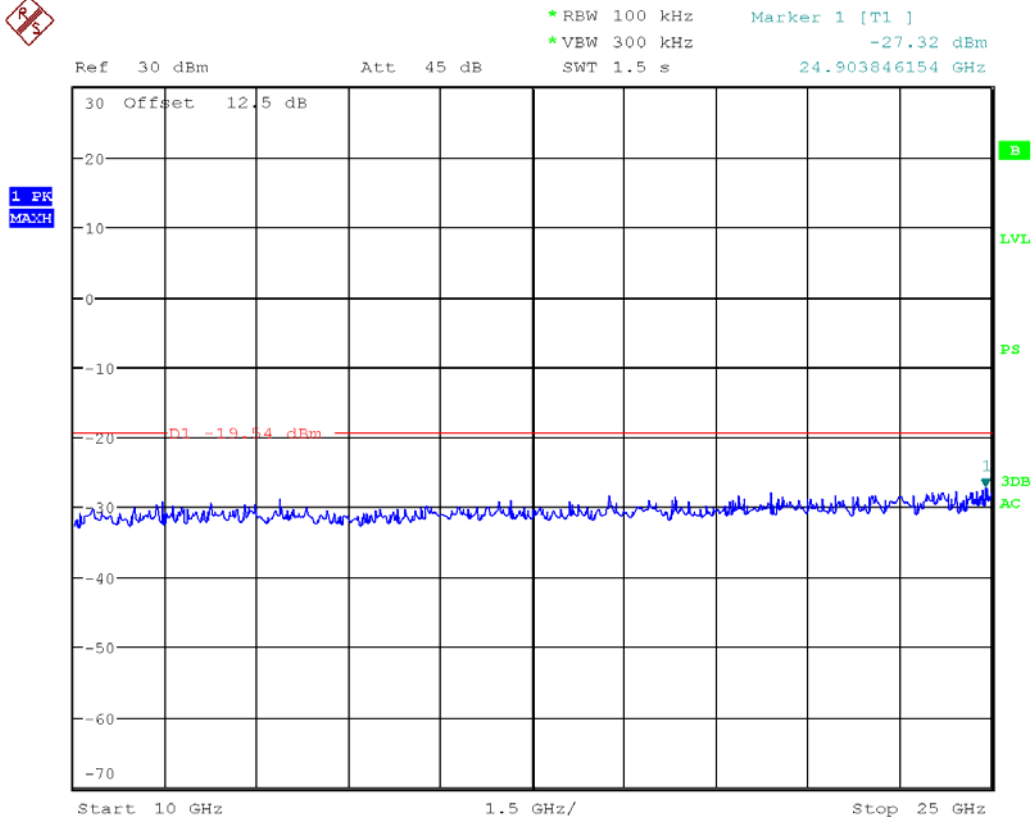

11. EMISSIONS IN RESTRICTED FREQUENCY BANDS

11.1 LIMITS

The DTS rules specify that emissions which fall into restricted frequency bands shall comply with the general radiated emission limits..

11.2 TEST PROCEDURES

Test procedures follow KDB 558074 D01 DTS Meas Guidance v03r01.

1. Check the calibration of the measuring instrument using either an internal calibrator or a known signal from an external generator.
2. Position the EUT without connection to measurement instrument. Turn on the EUT and connect its antenna terminal to measurement instrument via a low loss cable. Then set it to any one measured frequency within its operating range, and make sure the instrument is operated in its linear range.
3. Set the analyzer span to encompass the entire unwanted emission bandwidth above the measurement system noise level.
4. When Detector = peak, Set the RBW = 1 MHz. Set the VBW \geq 3 MHz. Ensure that the number of measurement points in the sweep \geq 2 x (span/RBW). Set sweep time = auto couple. When Detector = average. Set the RBW = 1 MHz. Set the VBW = 10Hz. Ensure that the number of measurement points in the sweep \geq 2 x (span/RBW). Set sweep time = auto couple. Employ trace averaging over a minimum of 100 traces.
5. Use the peak marker function to determine the maximum average power level in any 1 MHz of the unwanted emission.
6. Repeat above procedures until all measured frequencies were complete.

11.3 TEST SETUP

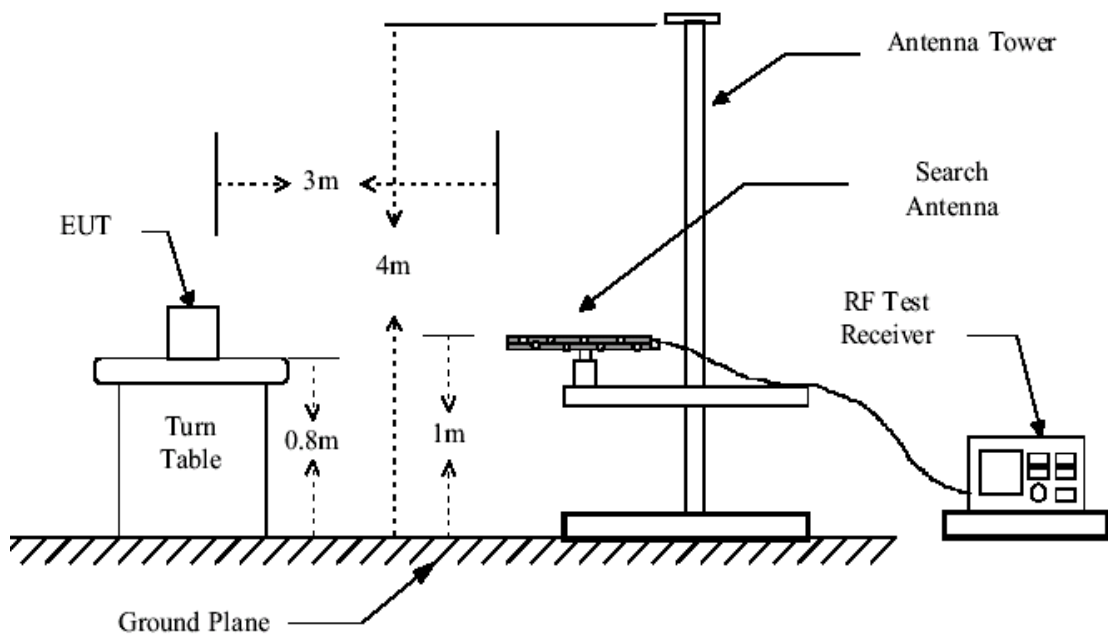

Figure 1. 30MHz to 1GHz radiated emissions test configuration

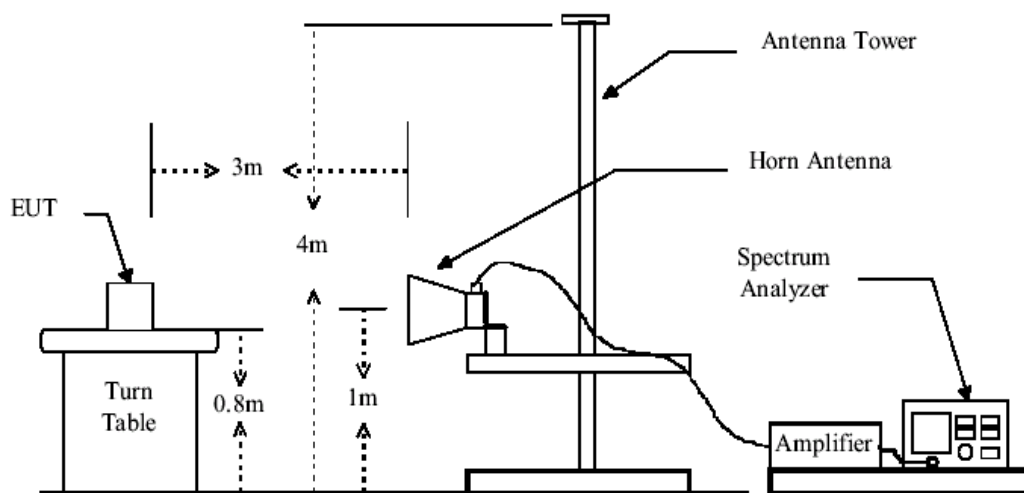
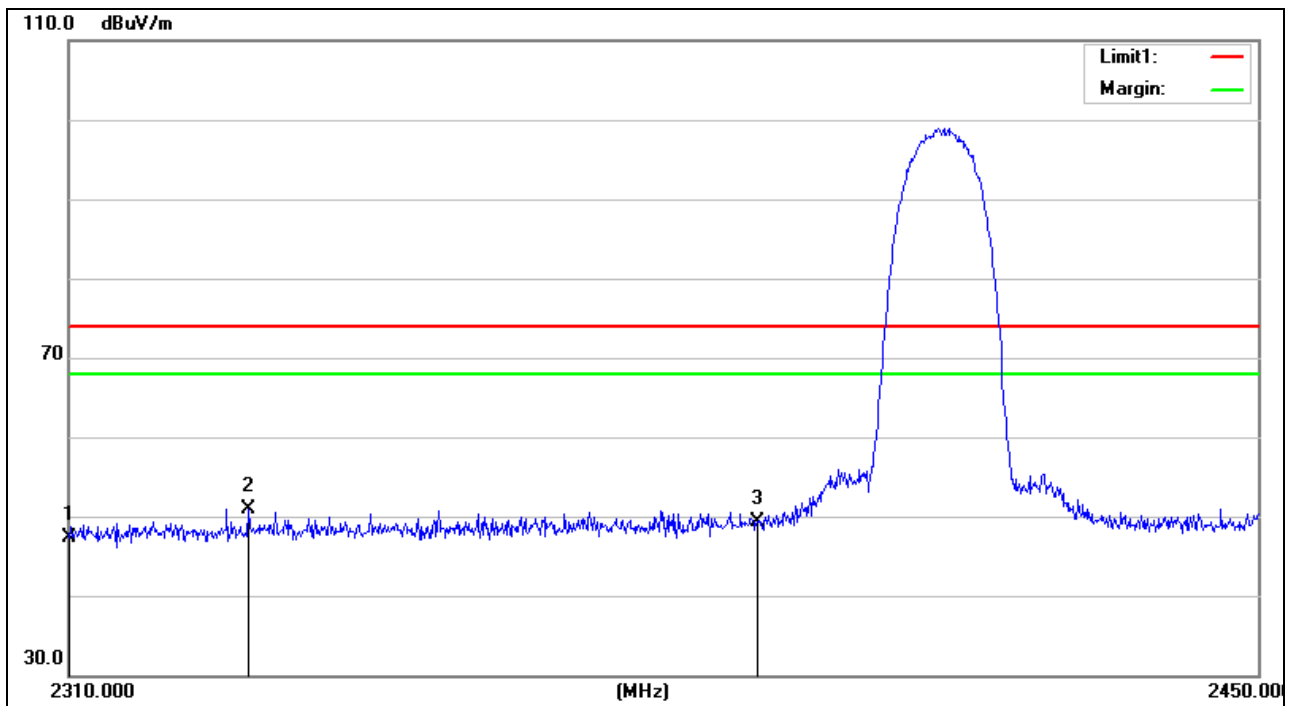

Figure 2. Above 1GHz radiated emissions test configuration

11.4 TEST RESULTS

Project No.:	ZJ00038221	Polarziation:	Vertical
Standard:	(RE)FCC PART 15 class B 3m PEAK	Power Source:	AC 120V/60Hz
Test item:	Radiation Test	Date:	2013-12-17
Temp./Hum.(%RH):	23.8/59%RH	Time:	15:18:40
EUT:	EPON ONU	Distance:	
Model:	ONT-2-E4021iWn	Test Result:	Pass
Note:	802.11 b-2412		



No.	Frequency (MHz)	Reading (dBuV/m)	Correct Factor(dB/m)	Result (dBuV/m)	Limit (dBuV/m)	Margin (dB)	Remark
1	2310.000	31.52	15.85	47.37	74.00	-26.63	peak
2	2330.720	34.91	15.98	50.89	74.00	-23.11	peak
3	2390.000	32.98	16.32	49.30	74.00	-24.70	peak

Project No.:	ZJ00038221	Polarziation:	Horizontal
Standard:	(RE)FCC PART 15 class B 3m_PEAK	Power Source:	AC 120V/60Hz
Test item:	Radiation Test	Date:	2013-12-17
Temp./Hum.(%RH):	23.8/59%RH	Time:	15:19:40
EUT:	EPON ONU	Distance:	
Model:	ONT-2-E4021iWn	Test Result:	Pass
Note:	802.11 b-2412		

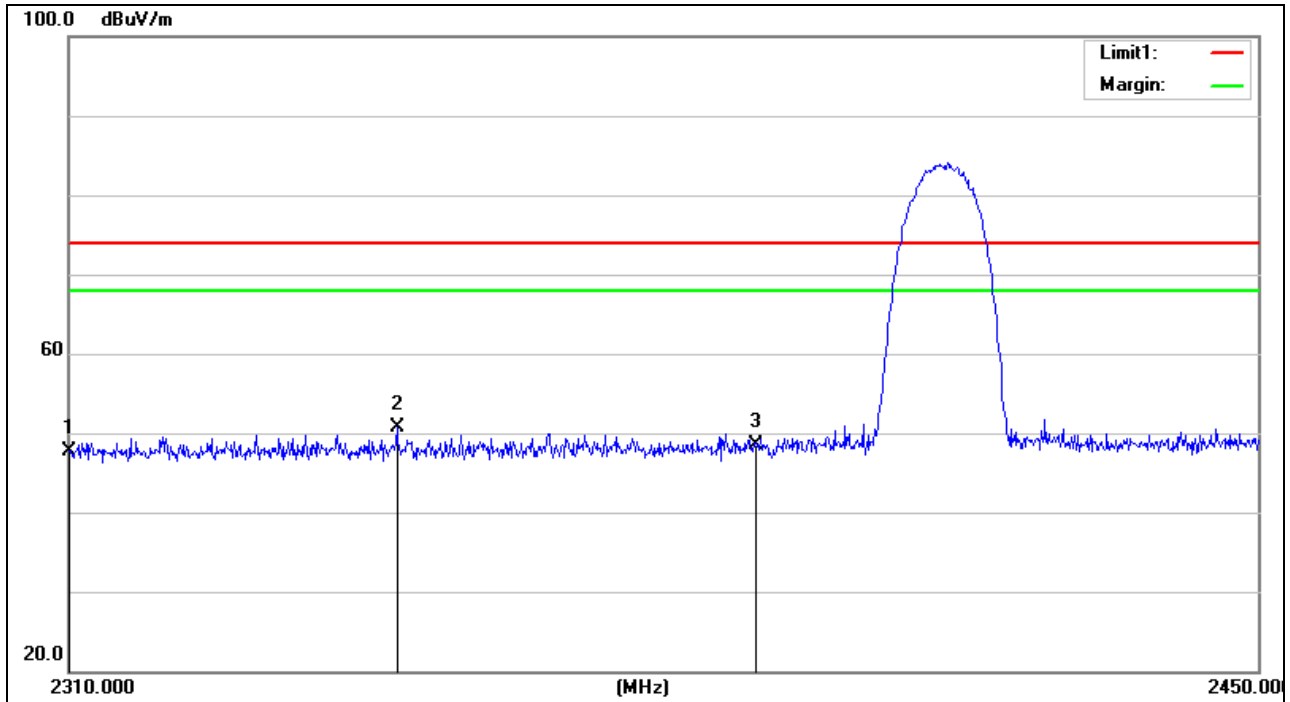

No.	Frequency (MHz)	Reading (dBuV/m)	Correct Factor(dB/m)	Result (dBuV/m)	Limit (dBuV/m)	Margin (dB)	Remark
1	2310.000	31.85	15.85	47.70	74.00	-26.30	peak
2	2347.940	34.73	16.07	50.80	74.00	-23.20	peak
3	2390.000	32.11	16.32	48.43	74.00	-25.57	peak

Project No.:	ZJ00038221	Polarziation:	Vertical
Standard:	(RE)FCC PART 15 class B 3m_AVG	Power Source:	AC 120V/60Hz
Test item:	Radiation Test	Date:	2013-12-17
Temp./Hum.(%RH):	23.8/59%RH	Time:	15:22:30
EUT:	EPON ONU	Distance:	
Model:	ONT-2-E4021iWn	Test Result:	Pass
Note:	802.11 b-2412		

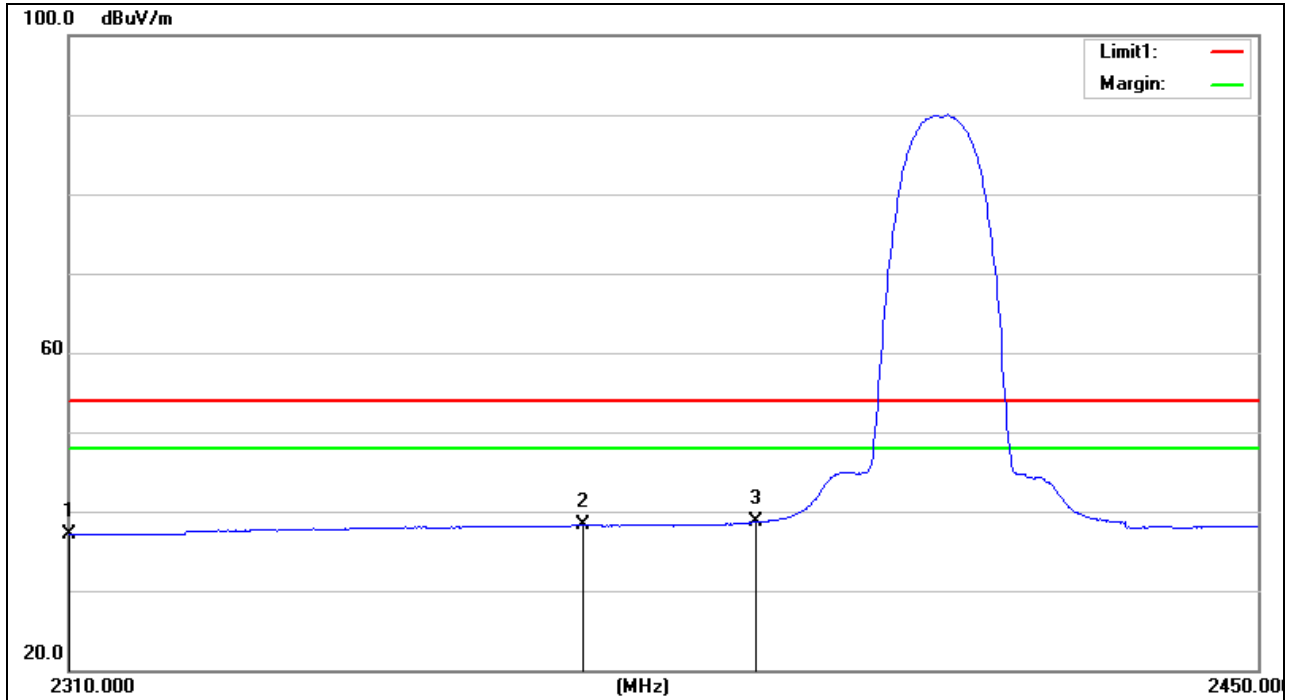

No.	Frequency (MHz)	Reading (dBuV/m)	Correct Factor(dB/m)	Result (dBuV/m)	Limit (dBuV/m)	Margin (dB)	Remark
1	2310.000	21.19	15.85	37.04	54.00	-16.96	AVG
2	2369.500	22.07	16.20	38.27	54.00	-15.73	AVG
3	2390.000	22.33	16.32	38.65	54.00	-15.35	AVG

Project No.:	ZJ00038221	Polarziation:	Horizontal
Standard:	(RE)FCC PART 15 class B 3m_AVG	Power Source:	AC 120V/60Hz
Test item:	Radiation Test	Date:	2013-12-17
Temp./Hum.(%RH):	23.8/59%RH	Time:	15:20:59
EUT:	EPON ONU	Distance:	
Model:	ONT-2-E4021iWn	Test Result:	Pass
Note:	802.11 b-2412		

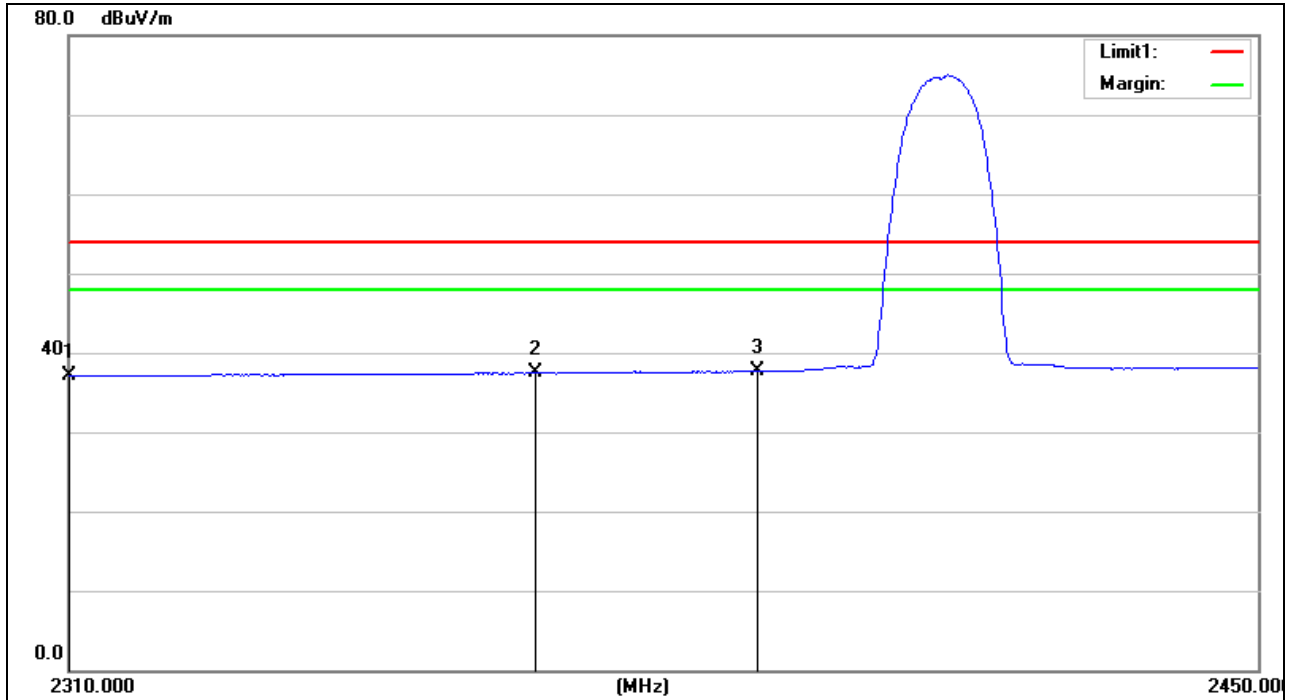

No.	Frequency (MHz)	Reading (dBuV/m)	Correct Factor(dB/m)	Result (dBuV/m)	Limit (dBuV/m)	Margin (dB)	Remark
1	2310.000	21.21	15.85	37.06	54.00	-16.94	AVG
2	2364.040	21.32	16.17	37.49	54.00	-16.51	AVG
3	2390.000	21.35	16.32	37.67	54.00	-16.33	AVG

Project No.:	ZJ00038221	Polarziation:	Vertical
Standard:	(RE)FCC PART 15 class B 3m_PEAK	Power Source:	AC 120V/60Hz
Test item:	Radiation Test	Date:	2013-12-17
Temp./Hum.(%RH):	23.8/59%RH	Time:	15:28:15
EUT:	EPON ONU	Distance:	
Model:	ONT-2-E4021iWn	Test Result:	Pass
Note:	802.11 b-2462		

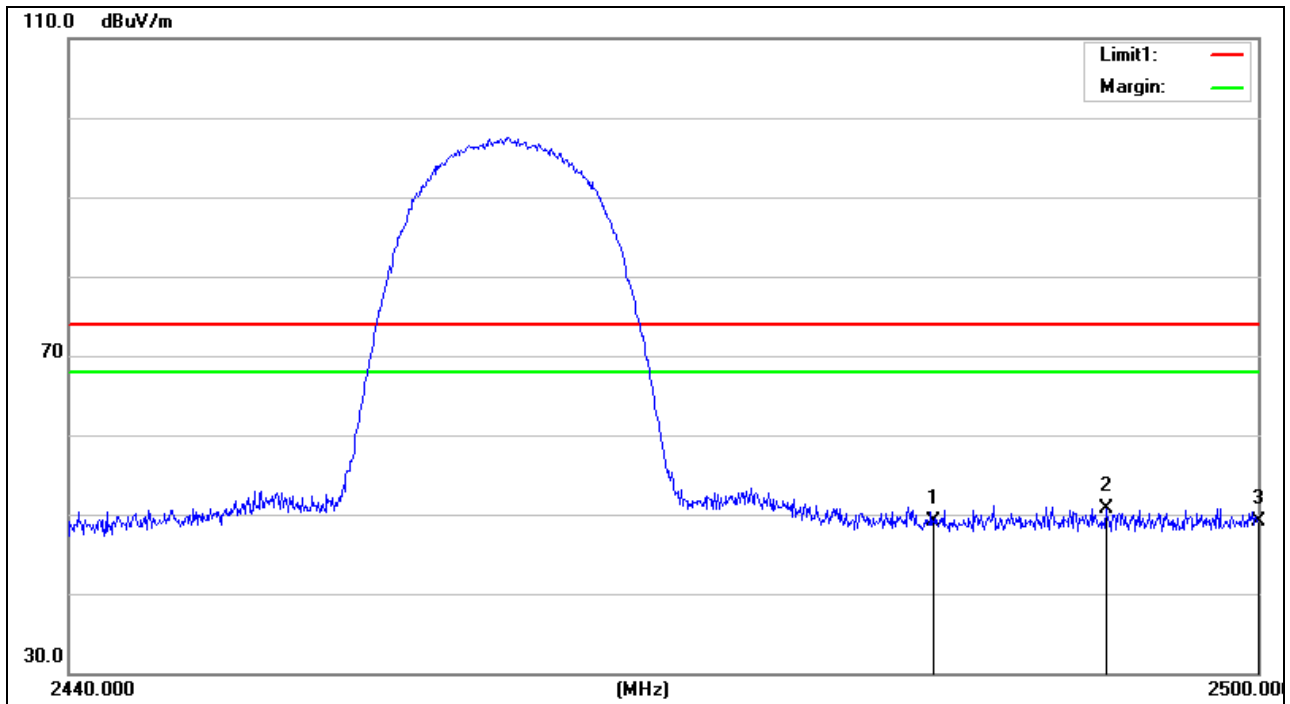

No.	Frequency (MHz)	Reading (dBuV/m)	Correct Factor(dB/m)	Result (dBuV/m)	Limit (dBuV/m)	Margin (dB)	Remark
1	2483.500	32.18	16.87	49.05	74.00	-24.95	peak
2	2492.260	33.77	16.93	50.70	74.00	-23.30	peak
3	2500.000	32.07	16.97	49.04	74.00	-24.96	peak

Project No.:	ZJ00038221	Polarziation:	Horizontal
Standard:	(RE)FCC PART 15 class B 3m_PEAK	Power Source:	AC 120V/60Hz
Test item:	Radiation Test	Date:	2013-12-17
Temp./Hum.(%RH):	23.8/59%RH	Time:	15:27:56
EUT:	EPON ONU	Distance:	
Model:	ONT-2-E4021iWn	Test Result:	Pass
Note:	802.11 b-2462		

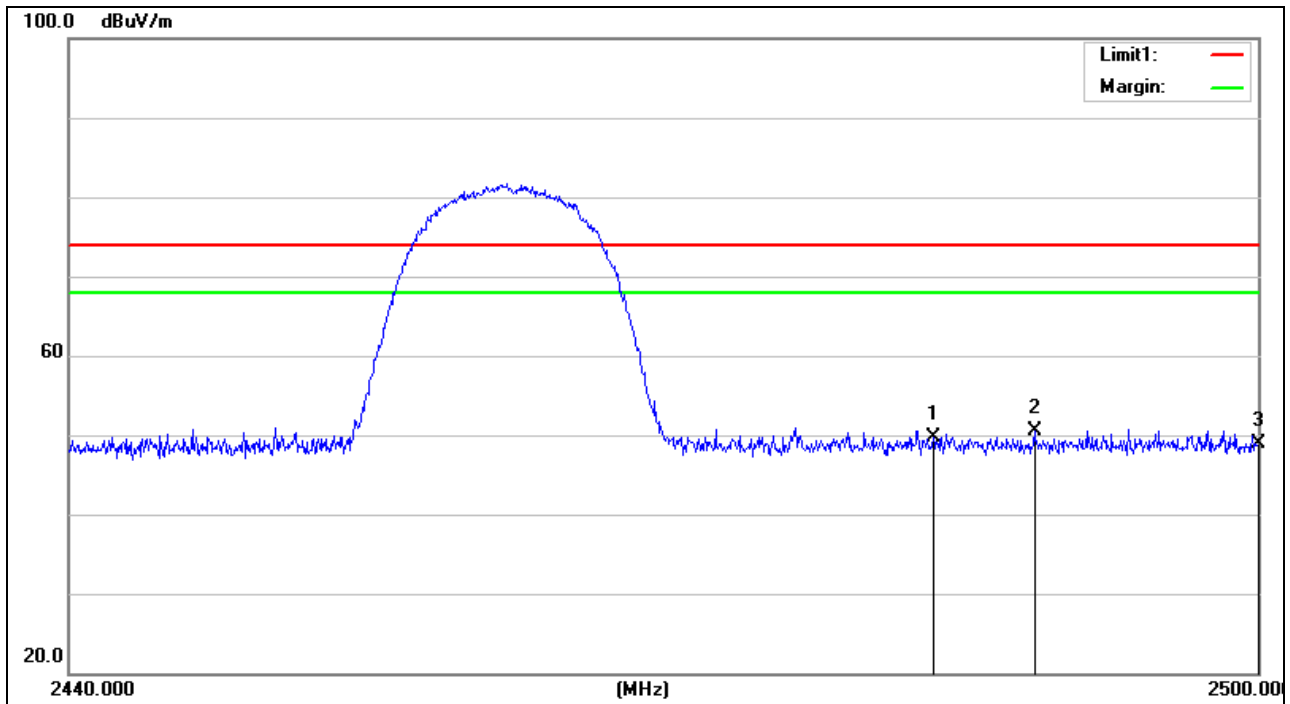

No.	Frequency (MHz)	Reading (dBuV/m)	Correct Factor(dB/m)	Result (dBuV/m)	Limit (dBuV/m)	Margin (dB)	Remark
1	2483.500	32.76	16.87	49.63	74.00	-24.37	peak
2	2488.660	33.53	16.90	50.43	74.00	-23.57	peak
3	2500.000	31.87	16.97	48.84	74.00	-25.16	peak

Project No.:	ZJ00038221	Polarziation:	Vertical
Standard:	(RE)FCC PART 15 class B 3m_AVG	Power Source:	AC 120V/60Hz
Test item:	Radiation Test	Date:	2013-12-17
Temp./Hum.(%RH):	23.8/59%RH	Time:	15:26:47
EUT:	EPON ONU	Distance:	
Model:	ONT-2-E4021iWn	Test Result:	Pass
Note:	802.11 b-2462		

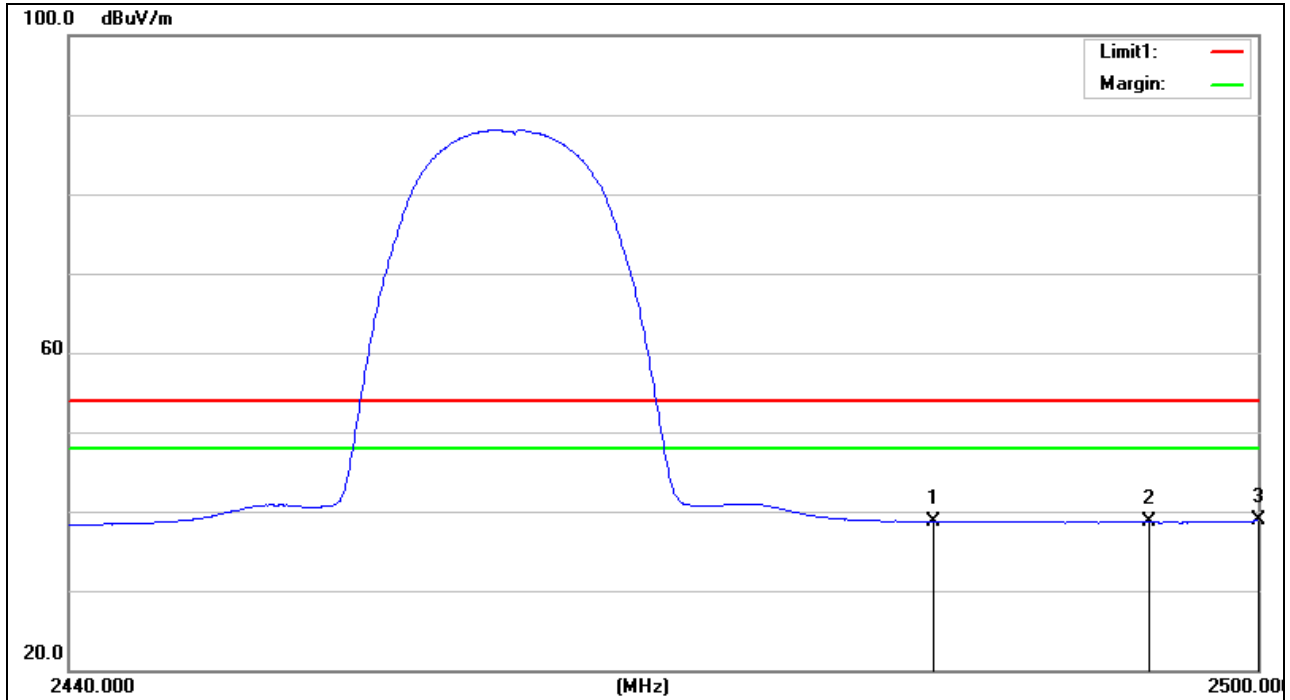

No.	Frequency (MHz)	Reading (dBuV/m)	Correct Factor(dB/m)	Result (dBuV/m)	Limit (dBuV/m)	Margin (dB)	Remark
1	2483.500	21.80	16.87	38.67	54.00	-15.33	AVG
2	2494.540	21.72	16.94	38.66	54.00	-15.34	AVG
3	2500.000	21.92	16.97	38.89	54.00	-15.11	AVG

Project No.:	ZJ00038221	Polarziation:	Horizontal
Standard:	(RE)FCC PART 15 class B 3m_AVG	Power Source:	AC 120V/60Hz
Test item:	Radiation Test	Date:	2013-12-17
Temp./Hum.(%RH):	23.8/59%RH	Time:	15:25:58
EUT:	EPON ONU	Distance:	
Model:	ONT-2-E4021iWn	Test Result:	Pass
Note:	802.11 b-2462		

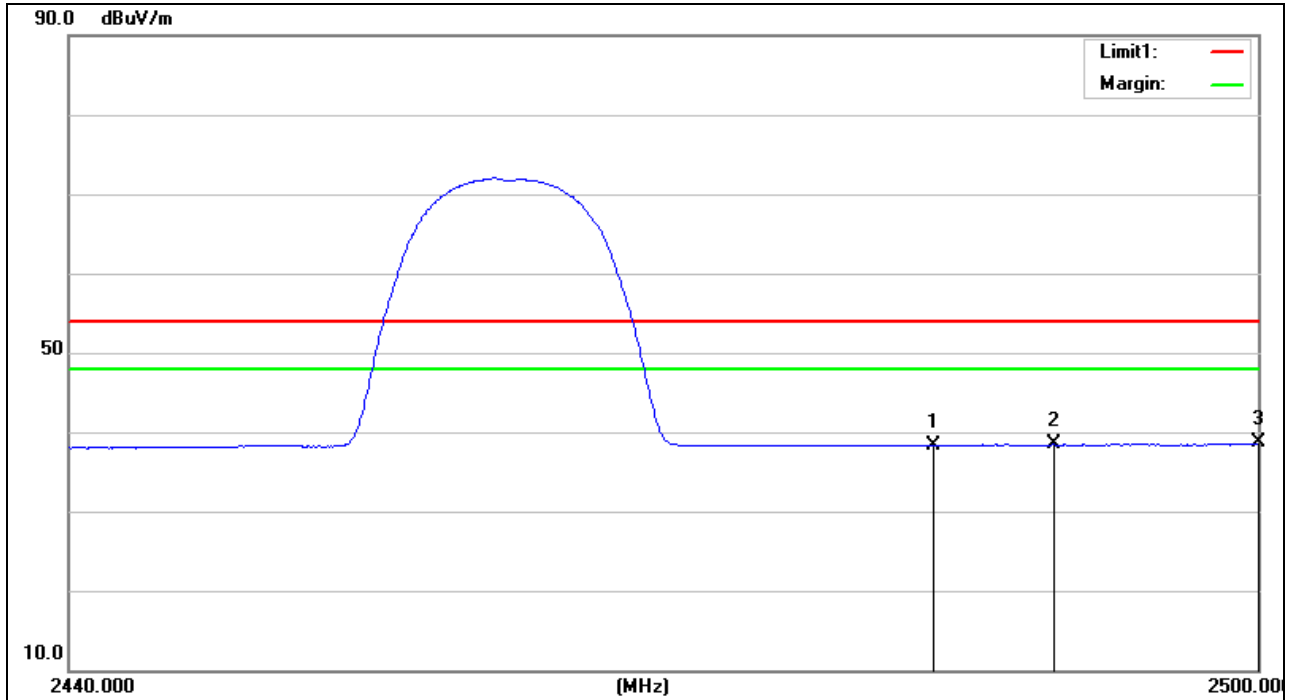

No.	Frequency (MHz)	Reading (dBuV/m)	Correct Factor(dB/m)	Result (dBuV/m)	Limit (dBuV/m)	Margin (dB)	Remark
1	2483.500	21.42	16.87	38.29	54.00	-15.71	AVG
2	2489.620	21.51	16.91	38.42	54.00	-15.58	AVG
3	2500.000	21.64	16.97	38.61	54.00	-15.39	AVG

Project No.:	ZJ00038221	Polarziation:	Vertical
Standard:	(RE)FCC PART 15 class B 3m_PEAK	Power Source:	AC 120V/60Hz
Test item:	Radiation Test	Date:	2013-12-17
Temp./Hum.(%RH):	23.8/59%RH	Time:	15:14:31
EUT:	EPON ONU	Distance:	
Model:	ONT-2-E4021iWn	Test Result:	Pass
Note:	802.11 g-2412		

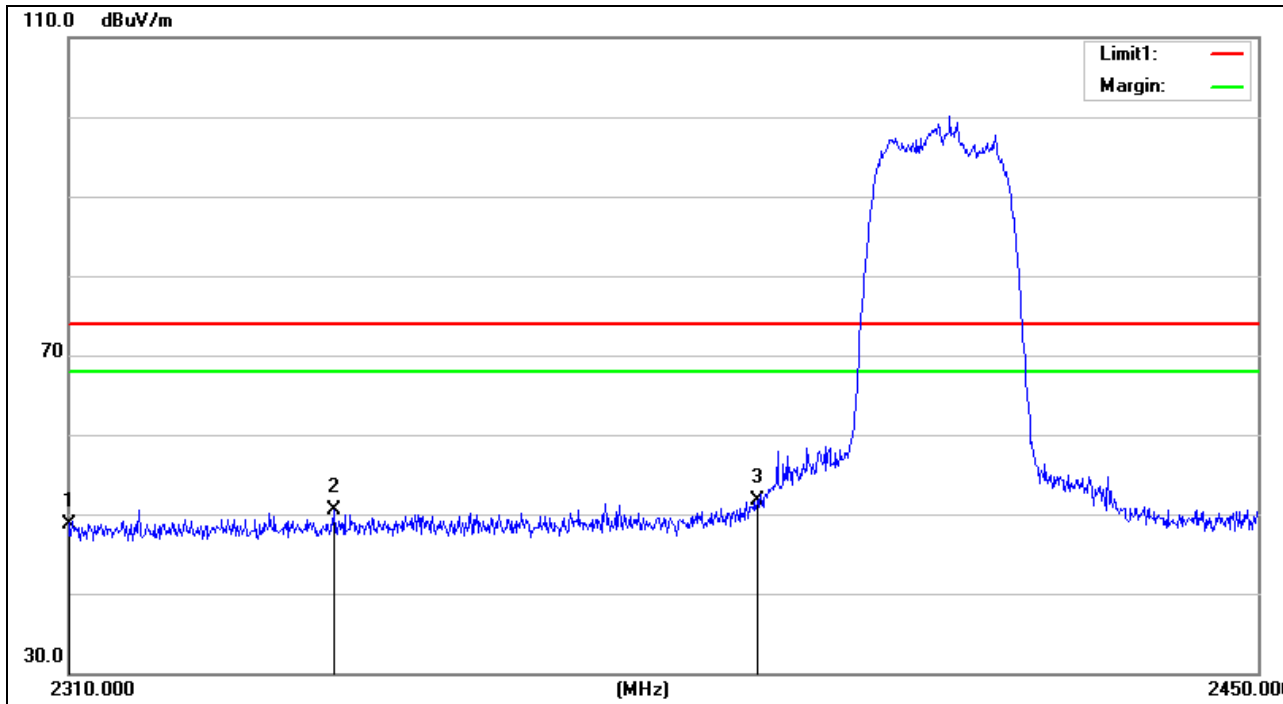

No.	Frequency (MHz)	Reading (dBuV/m)	Correct Factor(dB/m)	Result (dBuV/m)	Limit (dBuV/m)	Margin (dB)	Remark
1	2310.000	32.95	15.85	48.80	74.00	-25.20	peak
2	2340.520	34.49	16.03	50.52	74.00	-23.48	peak
3	2390.000	35.48	16.32	51.80	74.00	-22.20	peak

Project No.:	ZJ00038221	Polarization:	Horizontal
Standard:	(RE)FCC PART 15 class B 3m_PEAK	Power Source:	AC 120V/60Hz
Test item:	Radiation Test	Date:	2013-12-17
Temp./Hum.(%RH):	23.8/59%RH	Time:	15:13:48
EUT:	EPON ONU	Distance:	
Model:	ONT-2-E4021iWn	Test Result:	Pass
Note:	802.11 g-2412		

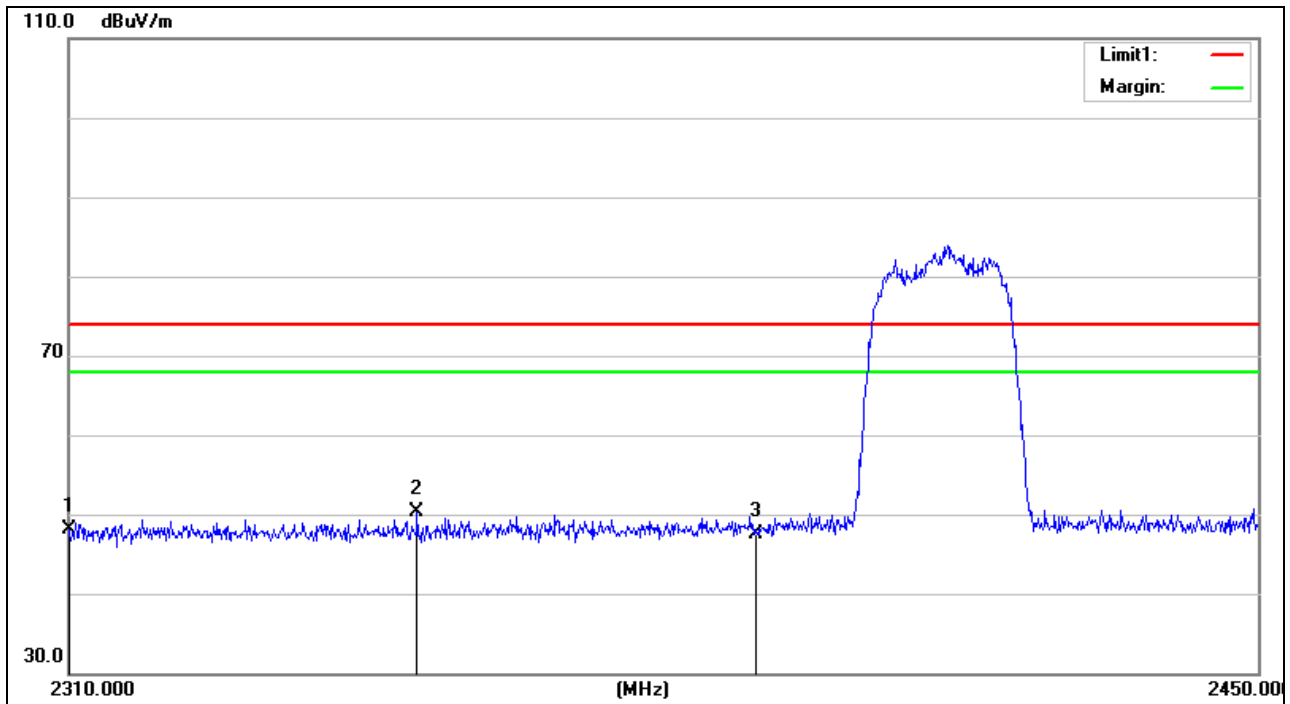

No.	Frequency (MHz)	Reading (dBuV/m)	Correct Factor(dB/m)	Result (dBuV/m)	Limit (dBuV/m)	Margin (dB)	Remark
1	2310.000	32.30	15.85	48.15	74.00	-25.85	peak
2	2350.180	34.15	16.10	50.25	74.00	-23.75	peak
3	2390.000	31.10	16.32	47.42	74.00	-26.58	peak

Project No.:	ZJ00038221	Polarziation:	Vertical
Standard:	(RE)FCC PART 15 class B 3m_AVG	Power Source:	AC 120V/60Hz
Test item:	Radiation Test	Date:	2013-12-17
Temp./Hum.(%RH):	23.8/59%RH	Time:	15:12:58
EUT:	EPON ONU	Distance:	
Model:	ONT-2-E4021iWn	Test Result:	Pass
Note:	802.11 g-2412		

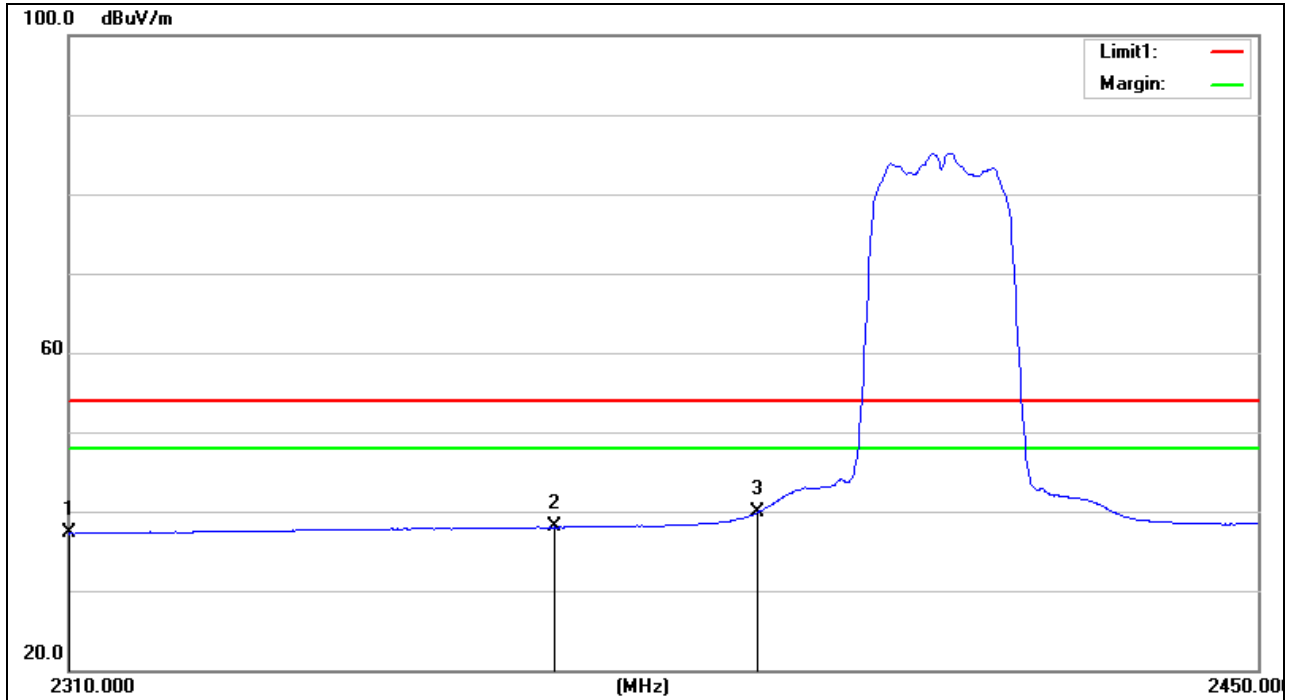

No.	Frequency (MHz)	Reading (dBuV/m)	Correct Factor(dB/m)	Result (dBuV/m)	Limit (dBuV/m)	Margin (dB)	Remark
1	2310.000	21.35	15.85	37.20	54.00	-16.80	AVG
2	2366.280	21.85	16.18	38.03	54.00	-15.97	AVG
3	2390.000	23.54	16.32	39.86	54.00	-14.14	AVG

Project No.:	ZJ00038221	Polarziation:	Horizontal
Standard:	(RE)FCC PART 15 class B 3m_AVG	Power Source:	AC 120V/60Hz
Test item:	Radiation Test	Date:	2013-12-17
Temp./Hum.(%RH):	23.8/59%RH	Time:	15:11:09
EUT:	EPON ONU	Distance:	
Model:	ONT-2-E4021iWn	Test Result:	Pass
Note:	802.11 g-2412		

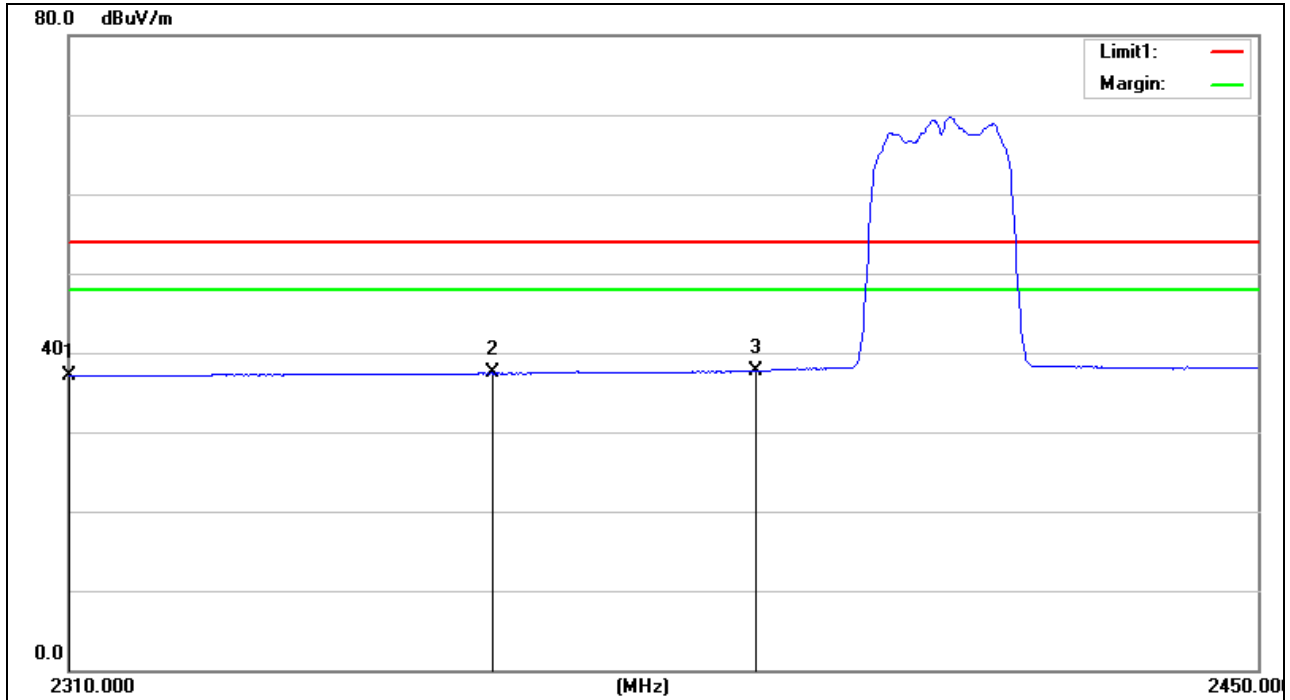

No.	Frequency (MHz)	Reading (dBuV/m)	Correct Factor(dB/m)	Result (dBuV/m)	Limit (dBuV/m)	Margin (dB)	Remark
1	2310.000	21.24	15.85	37.09	54.00	-16.91	AVG
2	2359.140	21.27	16.15	37.42	54.00	-16.58	AVG
3	2390.000	21.40	16.32	37.72	54.00	-16.28	AVG

Project No.:	ZJ00038221	Polarziation:	Vertical
Standard:	(RE)FCC PART 15 class B 3m_PEAK	Power Source:	AC 120V/60Hz
Test item:	Radiation Test	Date:	2013-12-17
Temp./Hum.(%RH):	23.8/59%RH	Time:	15:29:57
EUT:	EPON ONU	Distance:	
Model:	ONT-2-E4021iWn	Test Result:	Pass
Note:	802.11 g-2462		

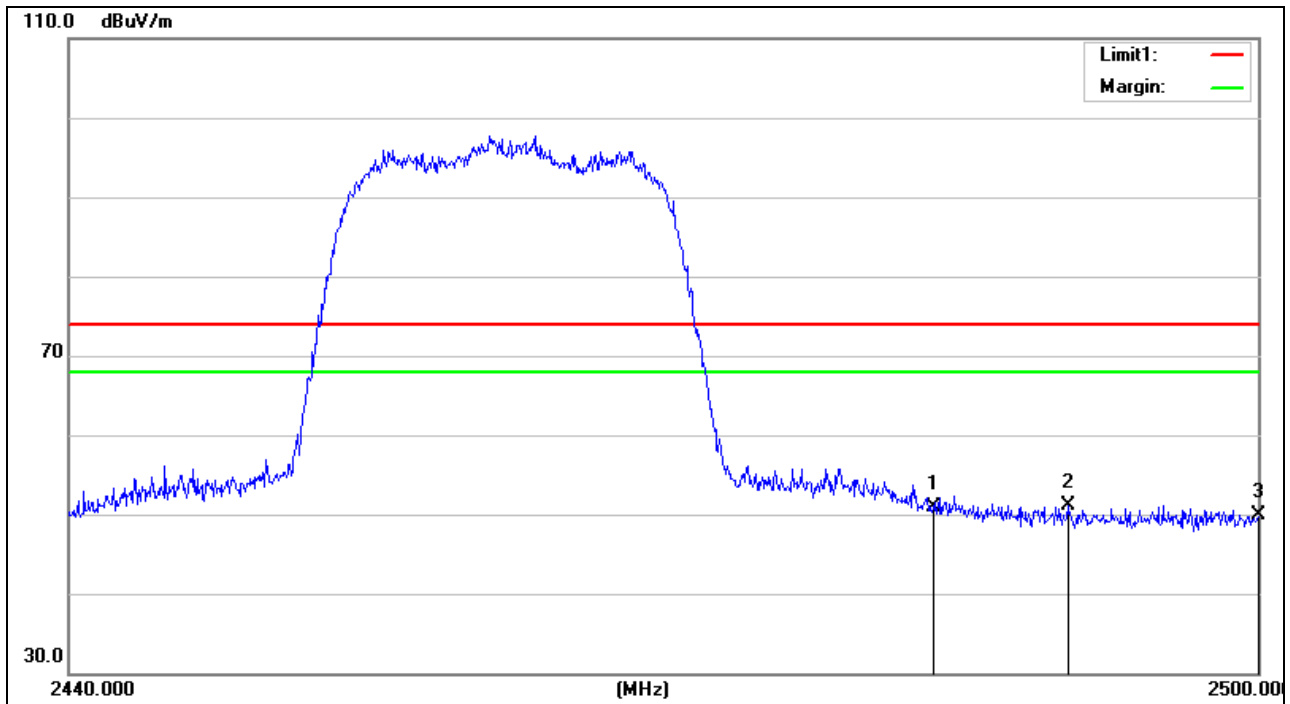

No.	Frequency (MHz)	Reading (dBuV/m)	Correct Factor(dB/m)	Result (dBuV/m)	Limit (dBuV/m)	Margin (dB)	Remark
1	2483.500	34.06	16.87	50.93	74.00	-23.07	peak
2	2490.340	34.12	16.91	51.03	74.00	-22.97	peak
3	2500.000	32.88	16.97	49.85	74.00	-24.15	peak

Project No.:	ZJ00038221	Polarziation:	Horizontal
Standard:	(RE)FCC PART 15 class B 3m_PEAK	Power Source:	AC 120V/60Hz
Test item:	Radiation Test	Date:	2013-12-17
Temp./Hum.(%RH):	23.8/59%RH	Time:	15:30:36
EUT:	EPON ONU	Distance:	
Model:	ONT-2-E4021iWn	Test Result:	Pass
Note:	802.11 g-2462		

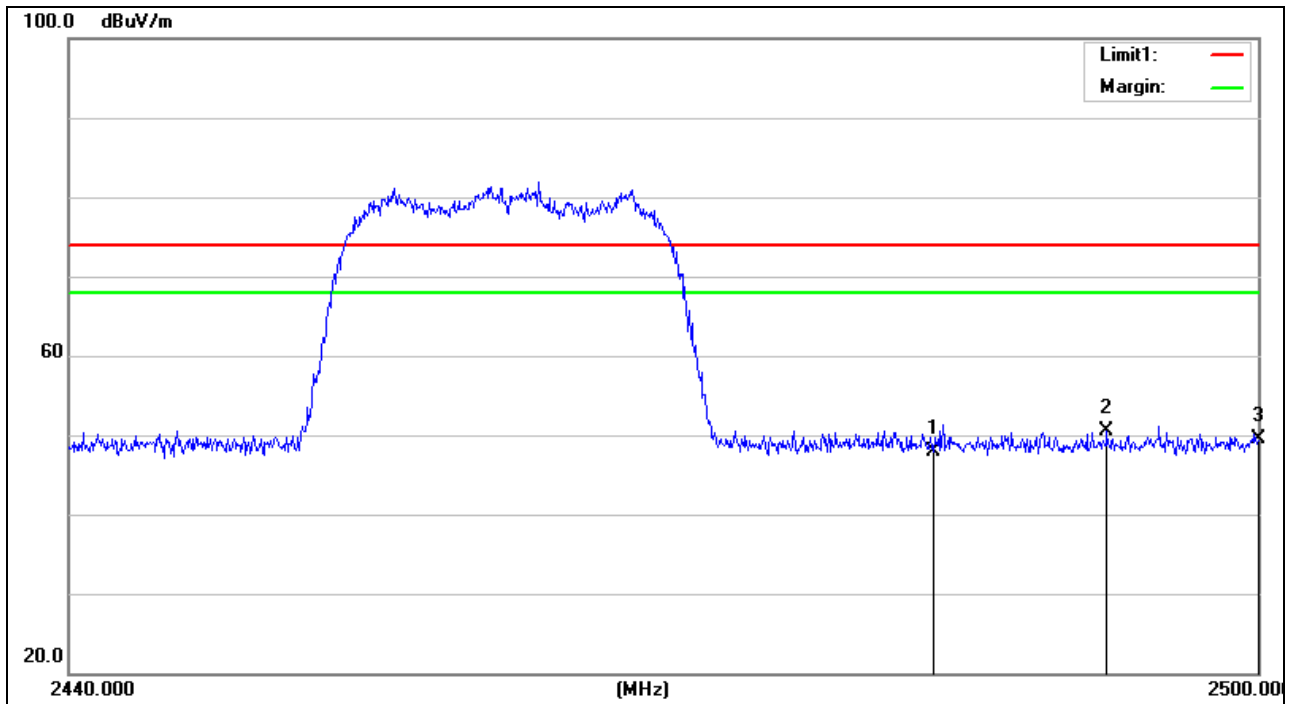

No.	Frequency (MHz)	Reading (dBuV/m)	Correct Factor(dB/m)	Result (dBuV/m)	Limit (dBuV/m)	Margin (dB)	Remark
1	2483.500	31.08	16.87	47.95	74.00	-26.05	peak
2	2492.320	33.57	16.93	50.50	74.00	-23.50	peak
3	2500.000	32.54	16.97	49.51	74.00	-24.49	peak

Project No.:	ZJ00038221	Polarziation:	Vertical
Standard:	(RE)FCC PART 15 class B 3m_AVG	Power Source:	AC 120V/60Hz
Test item:	Radiation Test	Date:	2013-12-17
Temp./Hum.(%RH):	23.8/59%RH	Time:	15:32:27
EUT:	EPON ONU	Distance:	
Model:	ONT-2-E4021iWn	Test Result:	Pass
Note:	802.11 g-2462		

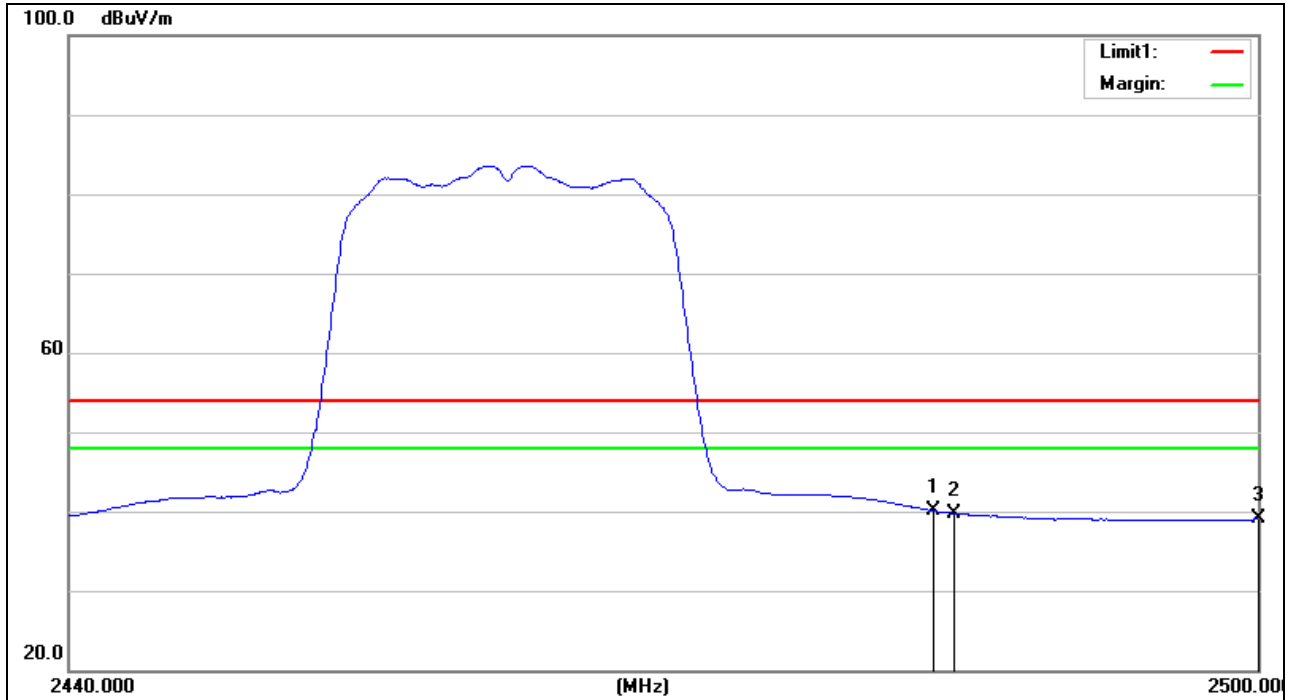

No.	Frequency (MHz)	Reading (dBuV/m)	Correct Factor(dB/m)	Result (dBuV/m)	Limit (dBuV/m)	Margin (dB)	Remark
1	2483.500	23.29	16.87	40.16	54.00	-13.84	AVG
2	2484.520	22.92	16.87	39.79	54.00	-14.21	AVG
3	2500.000	22.19	16.97	39.16	54.00	-14.84	AVG

Project No.:	ZJ00038221	Polarziation:	Horizontal
Standard:	(RE)FCC PART 15 class B 3m_AVG	Power Source:	AC 120V/60Hz
Test item:	Radiation Test	Date:	2013-12-17
Temp./Hum.(%RH):	23.8/59%RH	Time:	15:31:38
EUT:	EPON ONU	Distance:	
Model:	ONT-2-E4021iWn	Test Result:	Pass
Note:	802.11 g-2462		

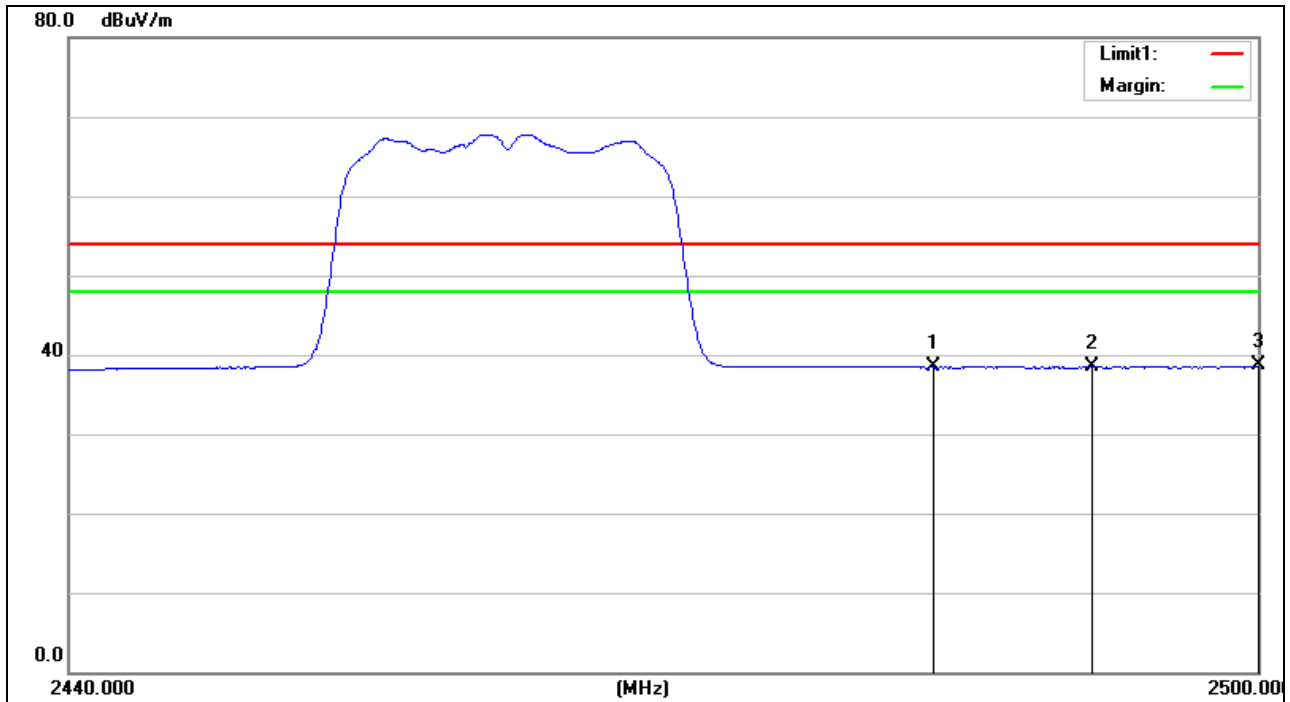

No.	Frequency (MHz)	Reading (dBuV/m)	Correct Factor(dB/m)	Result (dBuV/m)	Limit (dBuV/m)	Margin (dB)	Remark
1	2483.500	21.54	16.87	38.41	54.00	-15.59	AVG
2	2491.540	21.55	16.91	38.46	54.00	-15.54	AVG
3	2500.000	21.64	16.97	38.61	54.00	-15.39	AVG

Project No.:	ZJ00038221	Polarziation:	Vertical
Standard:	(RE)FCC PART 15 class B 3m_PEAK	Power Source:	AC 120V/60Hz
Test item:	Radiation Test	Date:	2013-12-17
Temp./Hum.(%RH):	23.8/59%RH	Time:	14:57:33
EUT:	EPON ONU	Distance:	
Model:	ONT-2-E4021iWn	Test Result:	Pass
Note:	802.11 n20-2412		

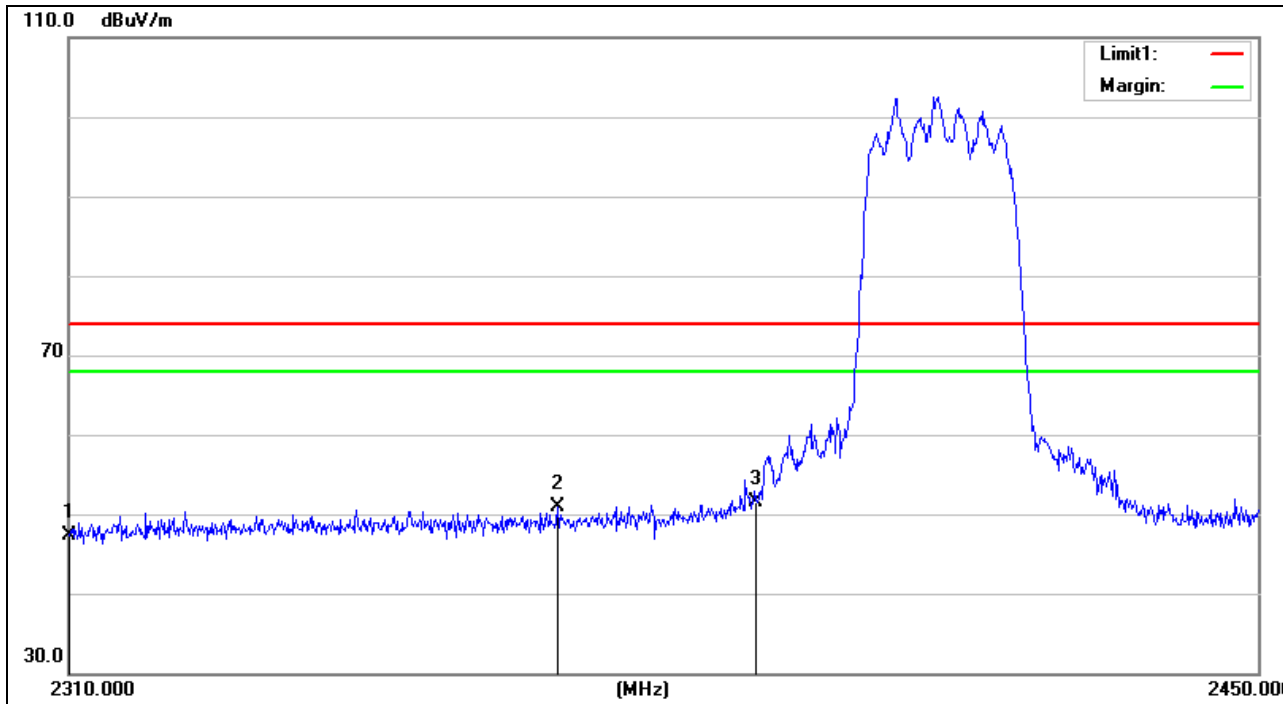

No.	Frequency (MHz)	Reading (dBuV/m)	Correct Factor(dB/m)	Result (dBuV/m)	Limit (dBuV/m)	Margin (dB)	Remark
1	2310.000	31.48	15.85	47.33	74.00	-26.67	peak
2	2366.560	34.74	16.18	50.92	74.00	-23.08	peak
3	2390.000	35.22	16.32	51.54	74.00	-22.46	peak

Project No.:	ZJ00038221	Polarization:	Horizontal
Standard:	(RE)FCC PART 15 class B 3m_PEAK	Power Source:	AC 120V/60Hz
Test item:	Radiation Test	Date:	2013-12-17
Temp./Hum.(%RH):	23.8/59%RH	Time:	14:57:08
EUT:	EPON ONU	Distance:	Pass
Model:	ONT-2-E4021iWn	Test Result:	Pass
Note:	802.11 n20-2412		

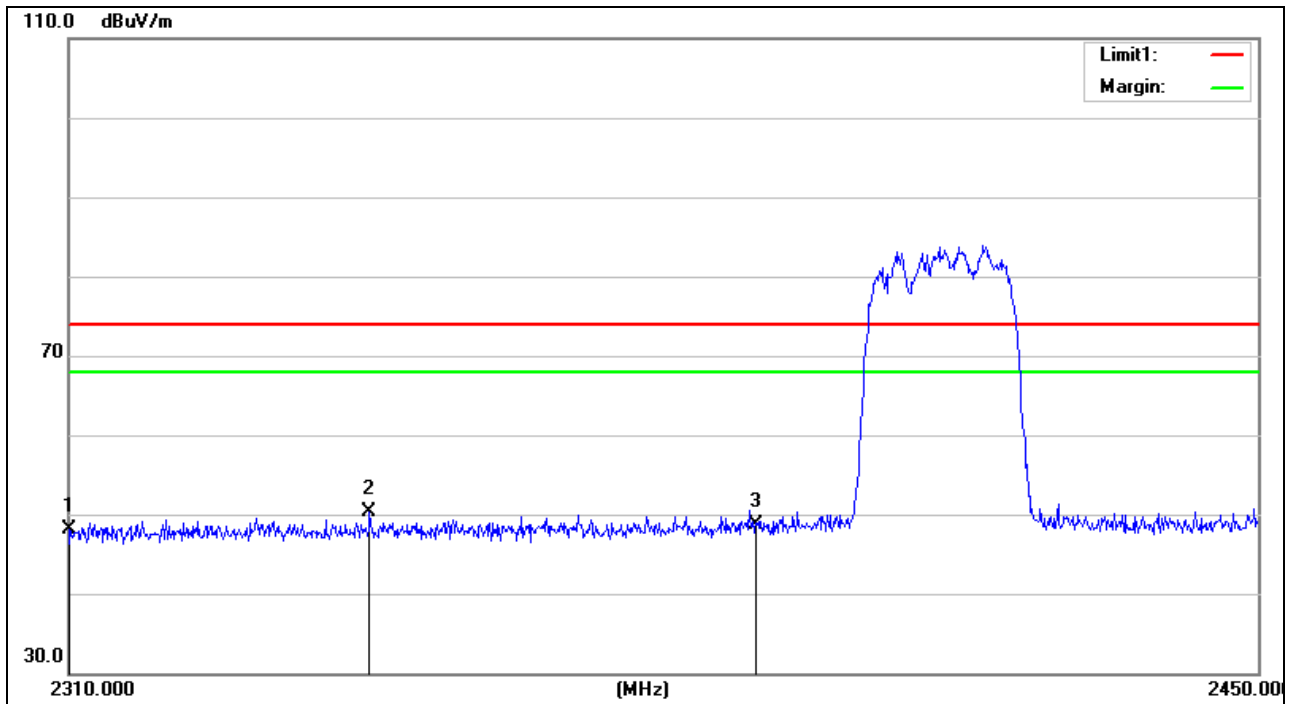

No.	Frequency (MHz)	Reading (dBuV/m)	Correct Factor(dB/m)	Result (dBuV/m)	Limit (dBuV/m)	Margin (dB)	Remark
1	2310.000	32.23	15.85	48.08	74.00	-25.92	peak
2	2344.720	34.27	16.05	50.32	74.00	-23.68	peak
3	2390.000	32.29	16.32	48.61	74.00	-25.39	peak

Project No.:	ZJ00038221	Polarziation:	Vertical
Standard:	(RE)FCC PART 15 class B 3m_AVG	Power Source:	AC 120V/60Hz
Test item:	Radiation Test	Date:	2013-12-17
Temp./Hum.(%RH):	23.8/59%RH	Time:	15:01:02
EUT:	EPON ONU	Distance:	
Model:	ONT-2-E4021iWn	Test Result:	Pass
Note:	802.11 n20-2412		

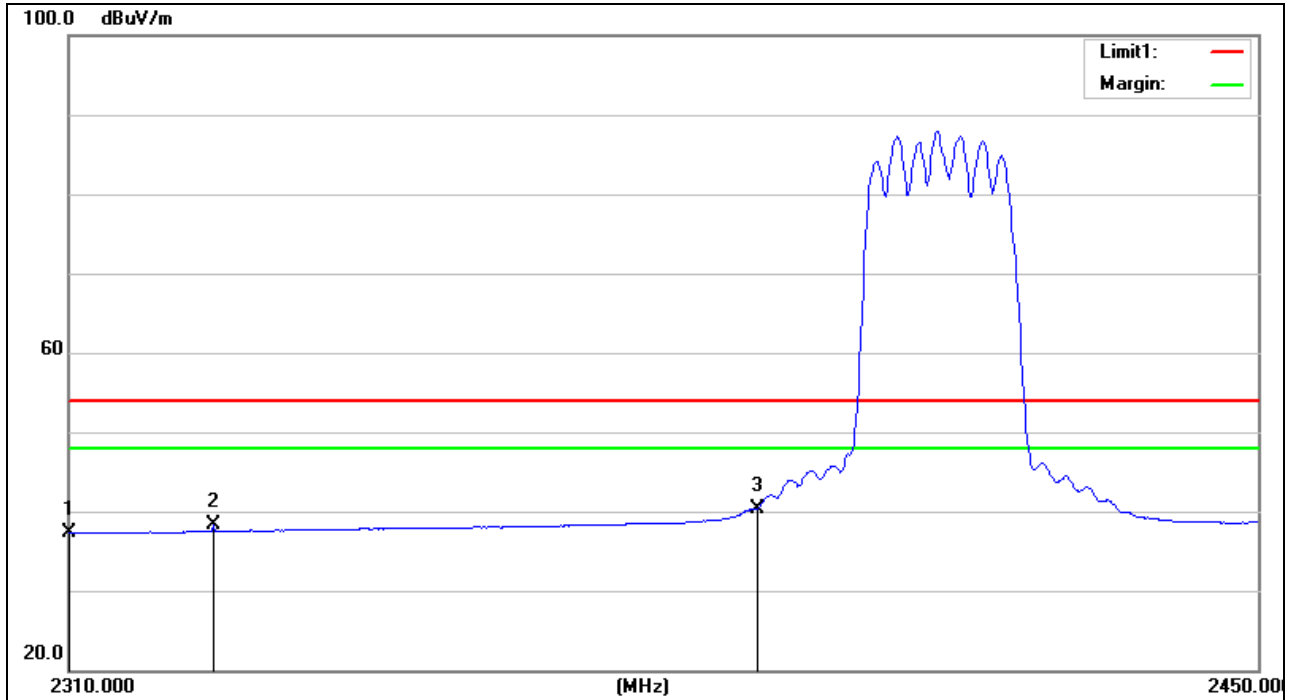

No.	Frequency (MHz)	Reading (dBuV/m)	Correct Factor(dB/m)	Result (dBuV/m)	Limit (dBuV/m)	Margin (dB)	Remark
1	2310.000	21.38	15.85	37.23	54.00	-16.77	AVG
2	2326.660	22.39	15.95	38.34	54.00	-15.66	AVG
3	2390.000	23.98	16.32	40.30	54.00	-13.70	AVG

Project No.:	ZJ00038221	Polarziation:	Horizontal
Standard:	(RE)FCC PART 15 class B 3m_AVG	Power Source:	AC 120V/60Hz
Test item:	Radiation Test	Date:	2013-12-17
Temp./Hum.(%RH):	23.8/59%RH	Time:	14:59:57
EUT:	EPON ONU	Distance:	
Model:	ONT-2-E4021iWn	Test Result:	Pass
Note:	802.11 n20-2412		

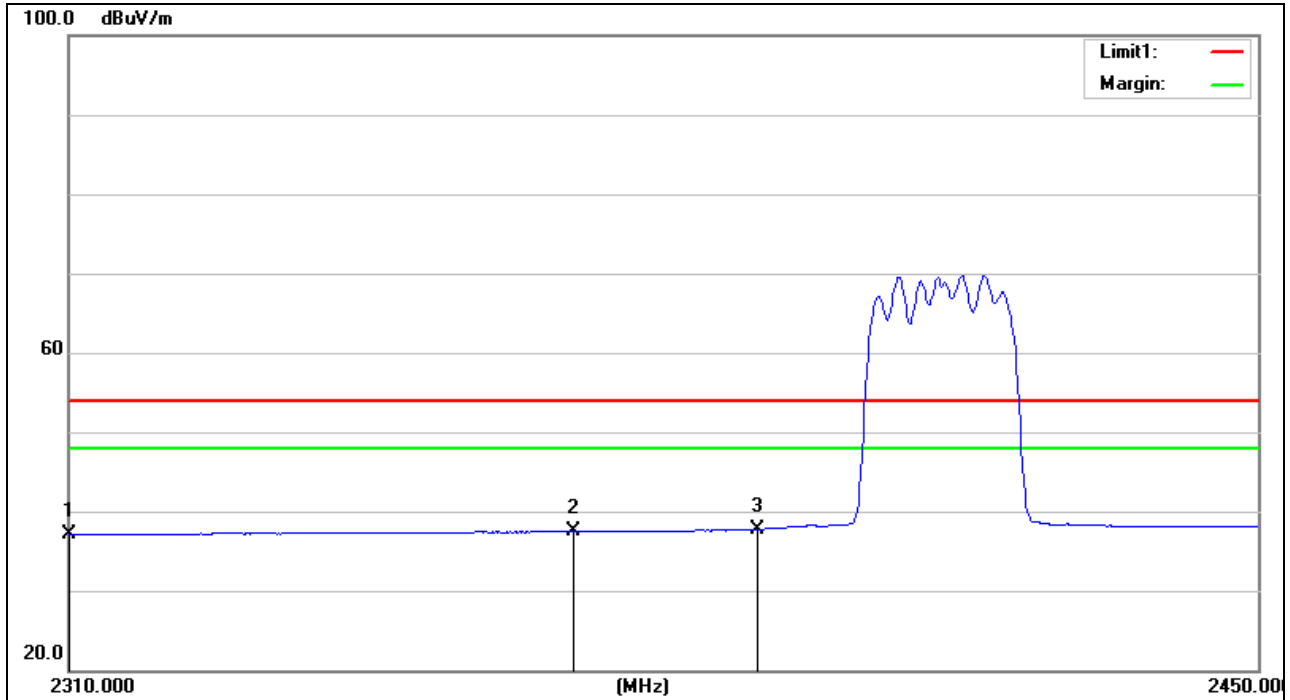

No.	Frequency (MHz)	Reading (dBuV/m)	Correct Factor(dB/m)	Result (dBuV/m)	Limit (dBuV/m)	Margin (dB)	Remark
1	2310.000	21.23	15.85	37.08	54.00	-16.92	AVG
2	2368.520	21.32	16.20	37.52	54.00	-16.48	AVG
3	2390.000	21.42	16.32	37.74	54.00	-16.26	AVG

Project No.:	ZJ00038221	Polarziation:	Vertical
Standard:	(RE)FCC PART 15 class B 3m_PEAK	Power Source:	AC 120V/60Hz
Test item:	Radiation Test	Date:	2013-12-17
Temp./Hum.(%RH):	23.8/59%RH	Time:	15:39:44
EUT:	EPON ONU	Distance:	
Model:	ONT-2-E4021iWn	Test Result:	Pass
Note:	802.11 n20-2462		

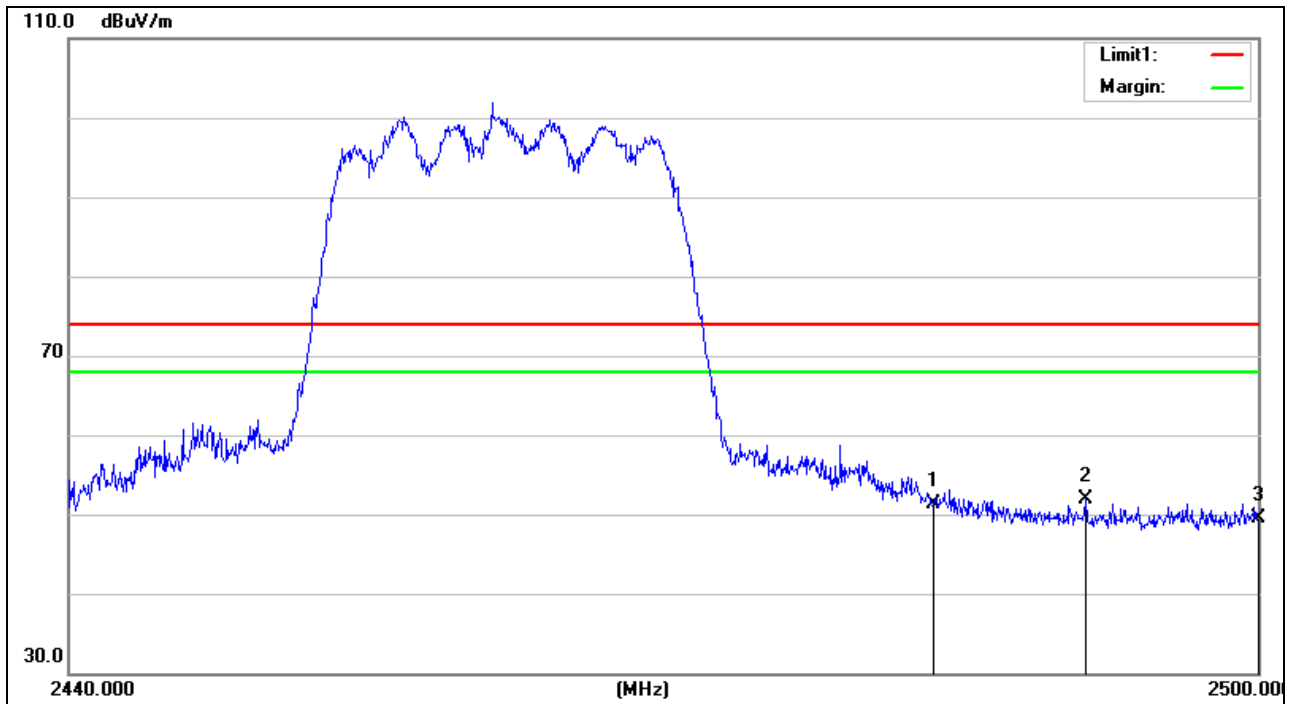

No.	Frequency (MHz)	Reading (dBuV/m)	Correct Factor(dB/m)	Result (dBuV/m)	Limit (dBuV/m)	Margin (dB)	Remark
1	2483.500	34.37	16.87	51.24	74.00	-22.76	peak
2	2491.240	35.02	16.91	51.93	74.00	-22.07	peak
3	2500.000	32.45	16.97	49.42	74.00	-24.58	peak

Project No.:	ZJ00038221	Polarziation:	Horizontal
Standard:	(RE)FCC PART 15 class B 3m_PEAK	Power Source:	AC 120V/60Hz
Test item:	Radiation Test	Date:	2013-12-17
Temp./Hum.(%RH):	23.8/59%RH	Time:	15:38:49
EUT:	EPON ONU	Distance:	
Model:	ONT-2-E4021iWn	Test Result:	Pass
Note:	802.11 n20-2462		

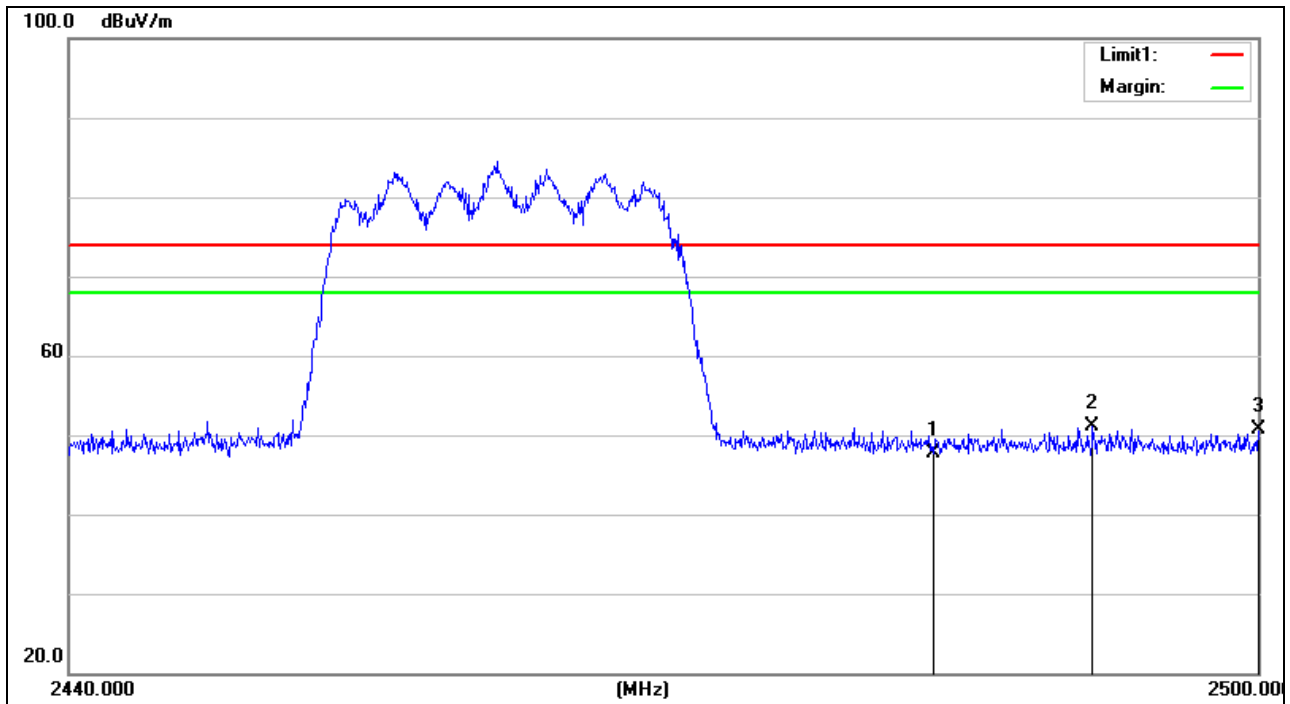

No.	Frequency (MHz)	Reading (dBuV/m)	Correct Factor(dB/m)	Result (dBuV/m)	Limit (dBuV/m)	Margin (dB)	Remark
1	2483.500	30.84	16.87	47.71	74.00	-26.29	peak
2	2491.600	34.20	16.91	51.11	74.00	-22.89	peak
3	2500.000	33.78	16.97	50.75	74.00	-23.25	peak

Project No.:	ZJ00038221	Polarziation:	Vertical
Standard:	(RE)FCC PART 15 class B 3m_AVG	Power Source:	AC 120V/60Hz
Test item:	Radiation Test	Date:	2013-12-17
Temp./Hum.(%RH):	23.8/59%RH	Time:	15:34:11
EUT:	EPON ONU	Distance:	
Model:	ONT-2-E4021iWn	Test Result:	Pass
Note:	802.11 n20-2462		

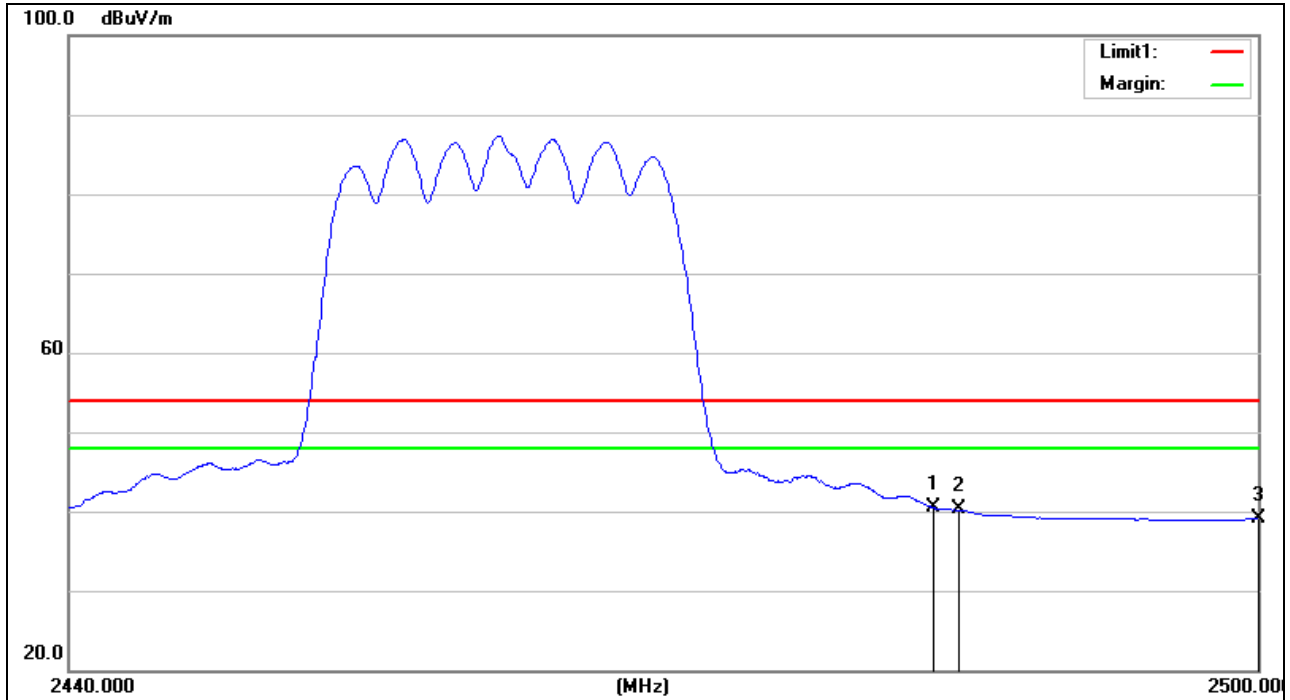

No.	Frequency (MHz)	Reading (dBuV/m)	Correct Factor(dB/m)	Result (dBuV/m)	Limit (dBuV/m)	Margin (dB)	Remark
1	2483.500	23.59	16.87	40.46	54.00	-13.54	AVG
2	2484.760	23.32	16.88	40.20	54.00	-13.80	AVG
3	2500.000	22.12	16.97	39.09	54.00	-14.91	AVG

Project No.:	ZJ00038221	Polarziation:	Horizontal
Standard:	(RE)FCC PART 15 class B 3m_AVG	Power Source:	AC 120V/60Hz
Test item:	Radiation Test	Date:	2013-12-17
Temp./Hum.(%RH):	23.8/59%RH	Time:	15:34:47
EUT:	EPON ONU	Distance:	
Model:	ONT-2-E4021iWn	Test Result:	Pass
Note:	802.11 n20-2462		

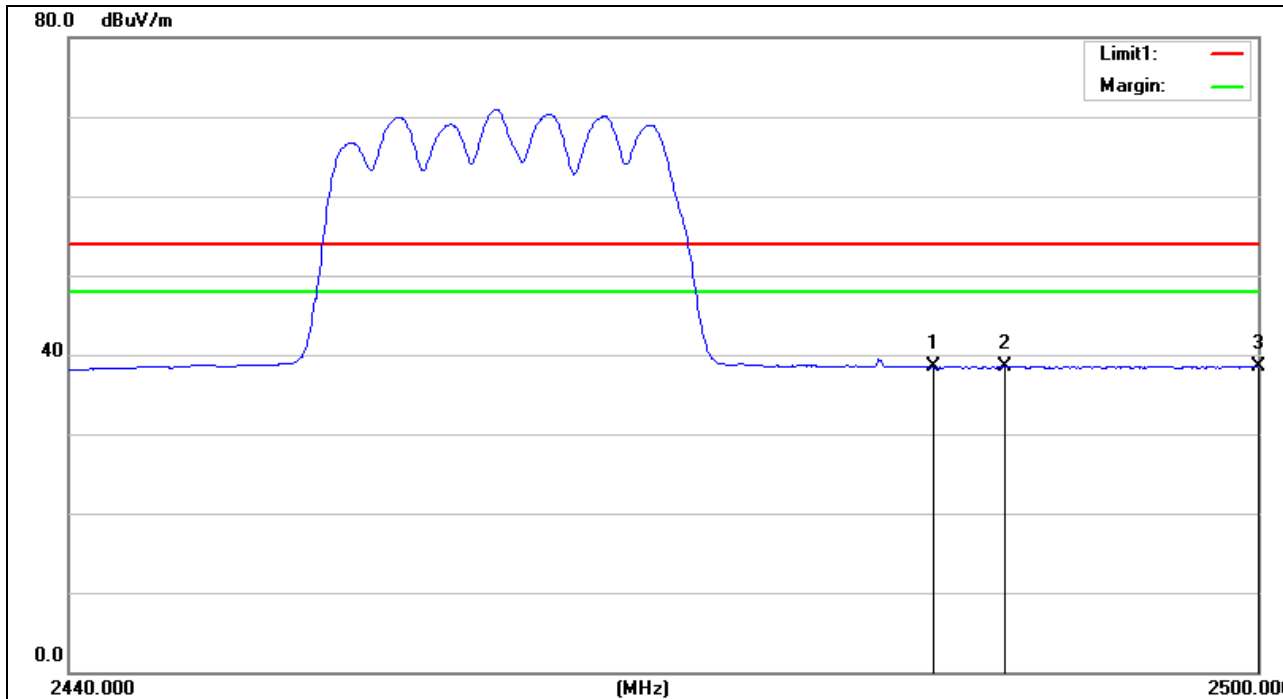

No.	Frequency (MHz)	Reading (dBuV/m)	Correct Factor(dB/m)	Result (dBuV/m)	Limit (dBuV/m)	Margin (dB)	Remark
1	2483.500	21.54	16.87	38.41	54.00	-15.59	AVG
2	2487.100	21.56	16.89	38.45	54.00	-15.55	AVG
3	2500.000	21.63	16.97	38.60	54.00	-15.40	AVG

Project No.:	ZJ00038221	Polarziation:	Vertical
Standard:	(RE)FCC PART 15 class B 3m_PEAK	Power Source:	AC 120V/60Hz
Test item:	Radiation Test	Date:	2013-12-17
Temp./Hum.(%RH):	23.8/59%RH	Time:	14:41:52
EUT:	EPON ONU	Distance:	
Model:	ONT-2-E4021iWn	Test Result:	Pass
Note:	802.11 n40-2422		

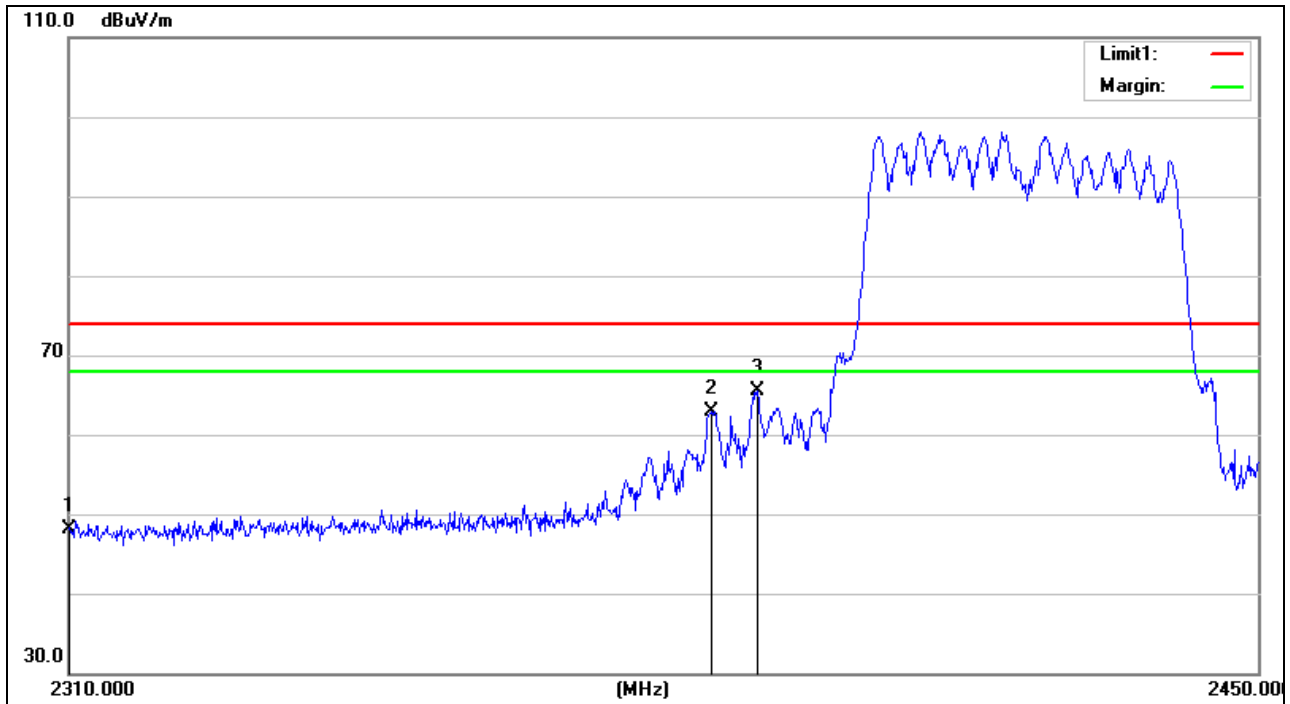

No.	Frequency (MHz)	Reading (dBuV/m)	Correct Factor(dB/m)	Result (dBuV/m)	Limit (dBuV/m)	Margin (dB)	Remark
1	2310.000	32.16	15.85	48.01	74.00	-25.99	peak
2	2384.620	46.62	16.28	62.90	74.00	-11.10	peak
3	2390.000	49.08	16.32	65.40	74.00	-8.60	peak

Project No.:	ZJ00038221	Polarziation:	Horizontal
Standard:	(RE)FCC PART 15 class B 3m_PEAK	Power Source:	AC 120V/60Hz
Test item:	Radiation Test	Date:	2013-12-17
Temp./Hum.(%RH):	23.8/59%RH	Time:	14:43:13
EUT:	EPON ONU	Distance:	
Model:	ONT-2-E4021iWn	Test Result:	Pass
Note:	802.11 n40-2422		

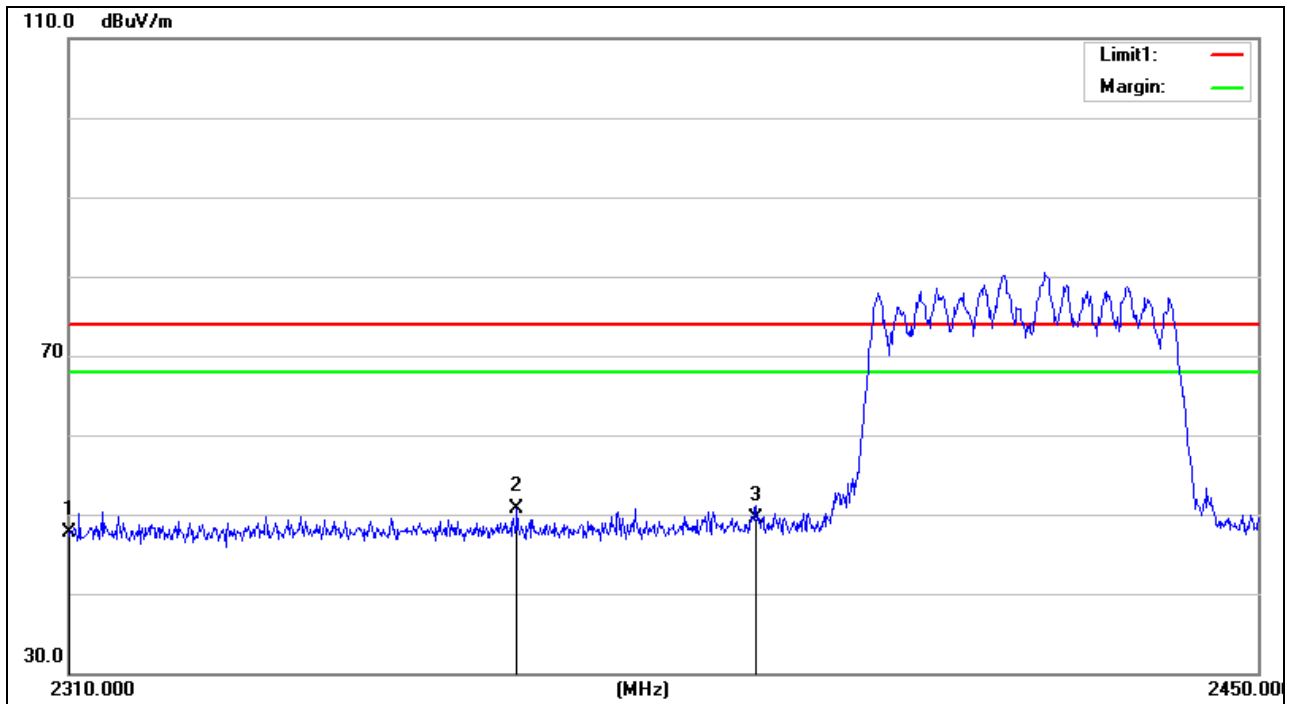

No.	Frequency (MHz)	Reading (dBuV/m)	Correct Factor(dB/m)	Result (dBuV/m)	Limit (dBuV/m)	Margin (dB)	Remark
1	2310.000	31.87	15.85	47.72	74.00	-26.28	peak
2	2361.940	34.52	16.16	50.68	74.00	-23.32	peak
3	2390.000	33.19	16.32	49.51	74.00	-24.49	peak

Project No.:	ZJ00038221	Polarziation:	Vertical
Standard:	(RE)FCC PART 15 class B 3m_AVG	Power Source:	AC 120V/60Hz
Test item:	Radiation Test	Date:	2013-12-17
Temp./Hum.(%RH):	23.8/59%RH	Time:	14:37:06
EUT:	EPON ONU	Distance:	
Model:	ONT-2-E4021iWn	Test Result:	Pass
Note:	802.11 n40-2422		

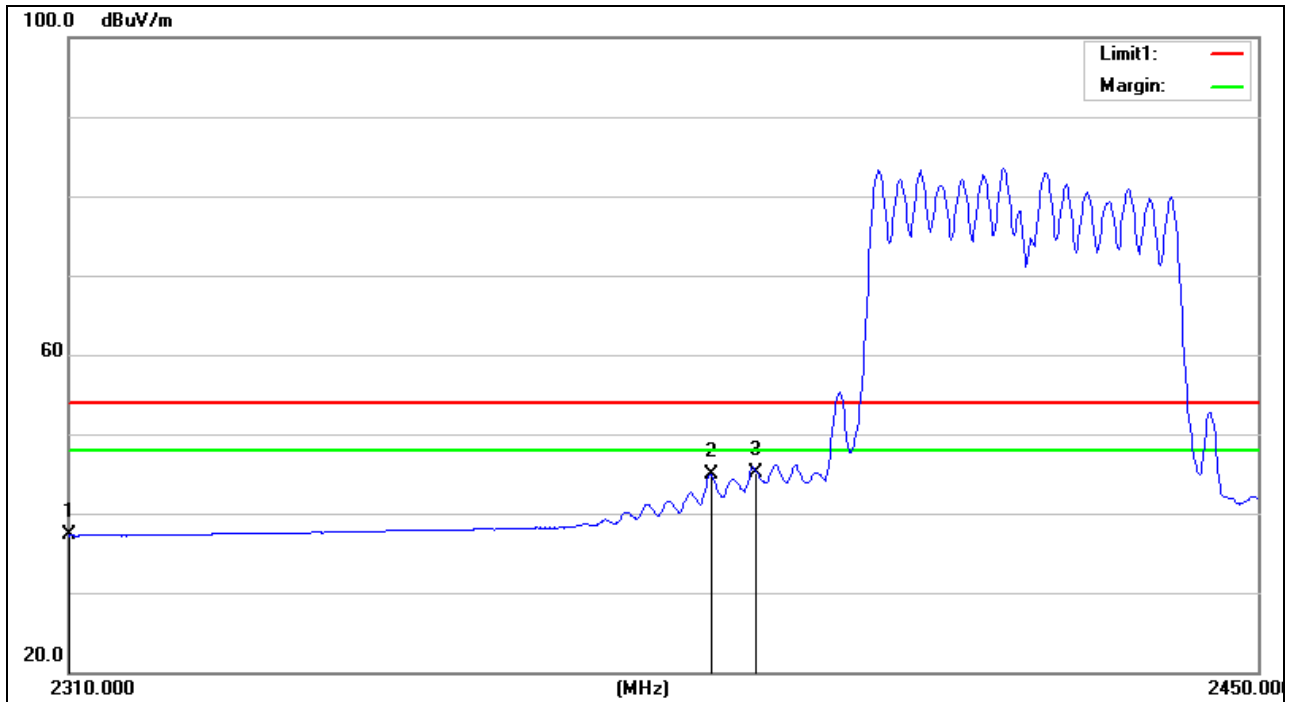

No.	Frequency (MHz)	Reading (dBuV/m)	Correct Factor(dB/m)	Result (dBuV/m)	Limit (dBuV/m)	Margin (dB)	Remark
1	2310.000	21.35	15.85	37.20	54.00	-16.80	AVG
2	2384.620	28.53	16.28	44.81	54.00	-9.19	AVG
3	2390.000	28.80	16.32	45.12	54.00	-8.88	AVG

Project No.:	ZJ00038221	Polarziation:	Horizontal
Standard:	(RE)FCC PART 15 class B 3m_AVG	Power Source:	AC 120V/60Hz
Test item:	Radiation Test	Date:	2013-12-17
Temp./Hum.(%RH):	23.8/59%RH	Time:	14:40:12
EUT:	EPON ONU	Distance:	
Model:	ONT-2-E4021iWn	Test Result:	Pass
Note:	802.11 n40-2422		

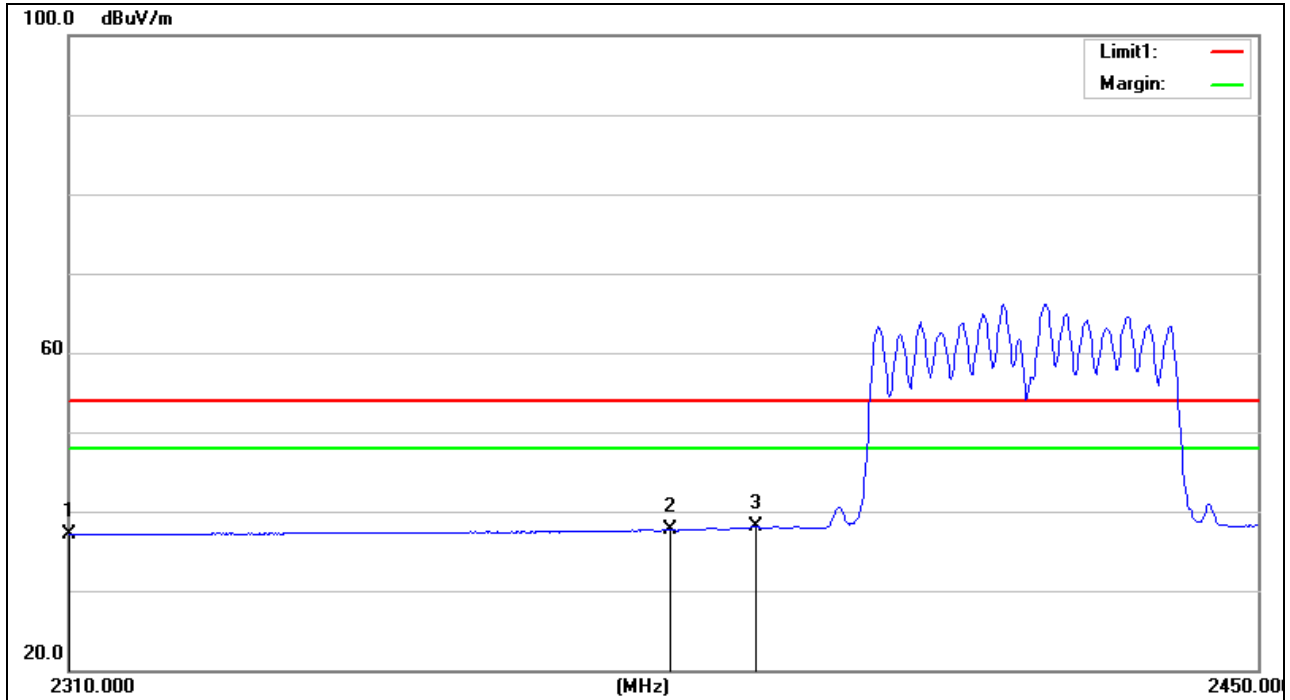

No.	Frequency (MHz)	Reading (dBuV/m)	Correct Factor(dB/m)	Result (dBuV/m)	Limit (dBuV/m)	Margin (dB)	Remark
1	2310.000	21.20	15.85	37.05	54.00	-16.95	AVG
2	2379.860	21.43	16.26	37.69	54.00	-16.31	AVG
3	2390.000	21.71	16.32	38.03	54.00	-15.97	AVG

Project No.:	ZJ00038221	Polarziation:	Vertical
Standard:	(RE)FCC PART 15 class B 3m_PEAK	Power Source:	AC 120V/60Hz
Test item:	Radiation Test	Date:	2013-12-17
Temp./Hum.(%RH):	23.8/59%RH	Time:	15:44:05
EUT:	EPON ONU	Distance:	
Model:	ONT-2-E4021iWn	Test Result:	Pass
Note:	802.11 n40-2452		

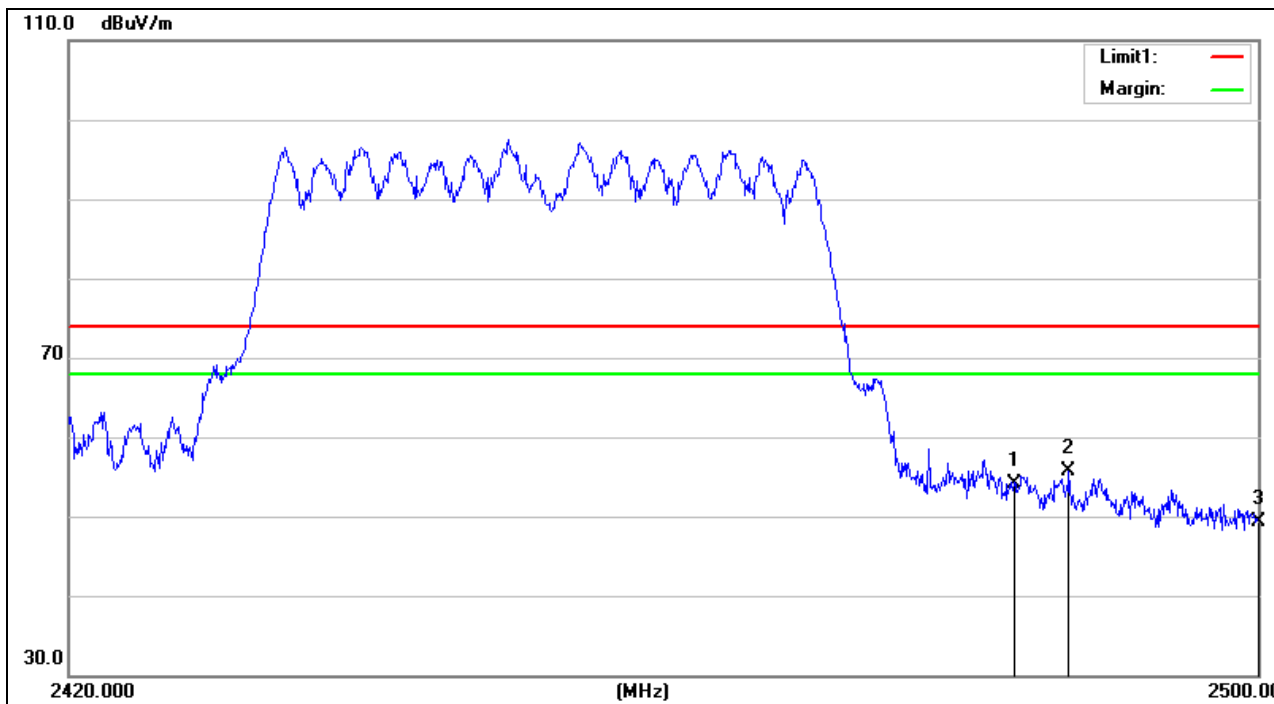

No.	Frequency (MHz)	Reading (dBuV/m)	Correct Factor(dB/m)	Result (dBuV/m)	Limit (dBuV/m)	Margin (dB)	Remark
1	2483.500	37.17	16.87	54.04	74.00	-19.96	peak
2	2487.120	38.74	16.89	55.63	74.00	-18.37	peak
3	2500.000	32.37	16.97	49.34	74.00	-24.66	peak

Project No.:	ZJ00038221	Polarziation:	Horizontal
Standard:	(RE)FCC PART 15 class B 3m_PEAK	Power Source:	AC 120V/60Hz
Test item:	Radiation Test	Date:	2013-12-17
Temp./Hum.(%RH):	23.8/59%RH	Time:	15:43:43
EUT:	EPON ONU	Distance:	
Model:	ONT-2-E4021iWn	Test Result:	Pass
Note:	802.11 n40-2452		

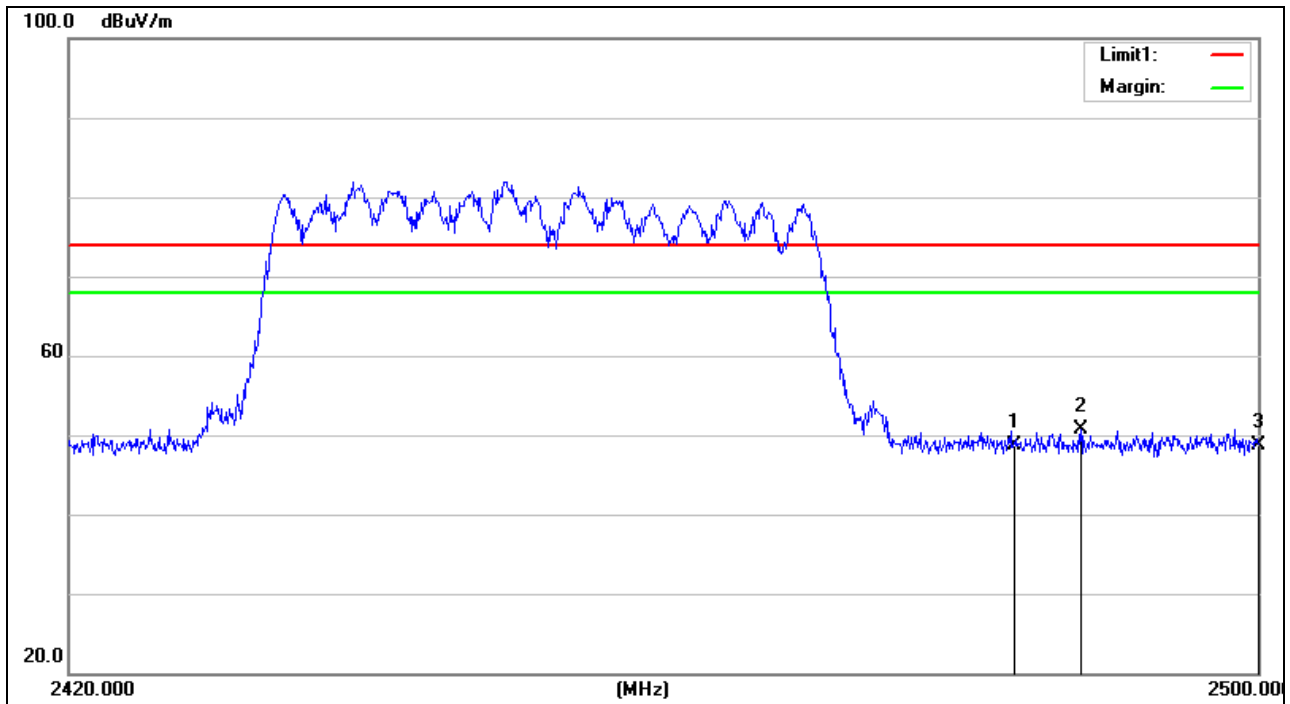

No.	Frequency (MHz)	Reading (dBuV/m)	Correct Factor(dB/m)	Result (dBuV/m)	Limit (dBuV/m)	Margin (dB)	Remark
1	2483.500	31.82	16.87	48.69	74.00	-25.31	peak
2	2487.920	33.86	16.89	50.75	74.00	-23.25	peak
3	2500.000	31.72	16.97	48.69	74.00	-25.31	peak

Project No.:	ZJ00038221	Polarziation:	Vertical
Standard:	(RE)FCC PART 15 class B 3m_AVG	Power Source:	AC 120V/60Hz
Test item:	Radiation Test	Date:	2013-12-17
Temp./Hum.(%RH):	23.8/59%RH	Time:	15:47:12
EUT:	EPON ONU	Distance:	
Model:	ONT-2-E4021iWn	Test Result:	Pass
Note:	802.11 n40-2452		

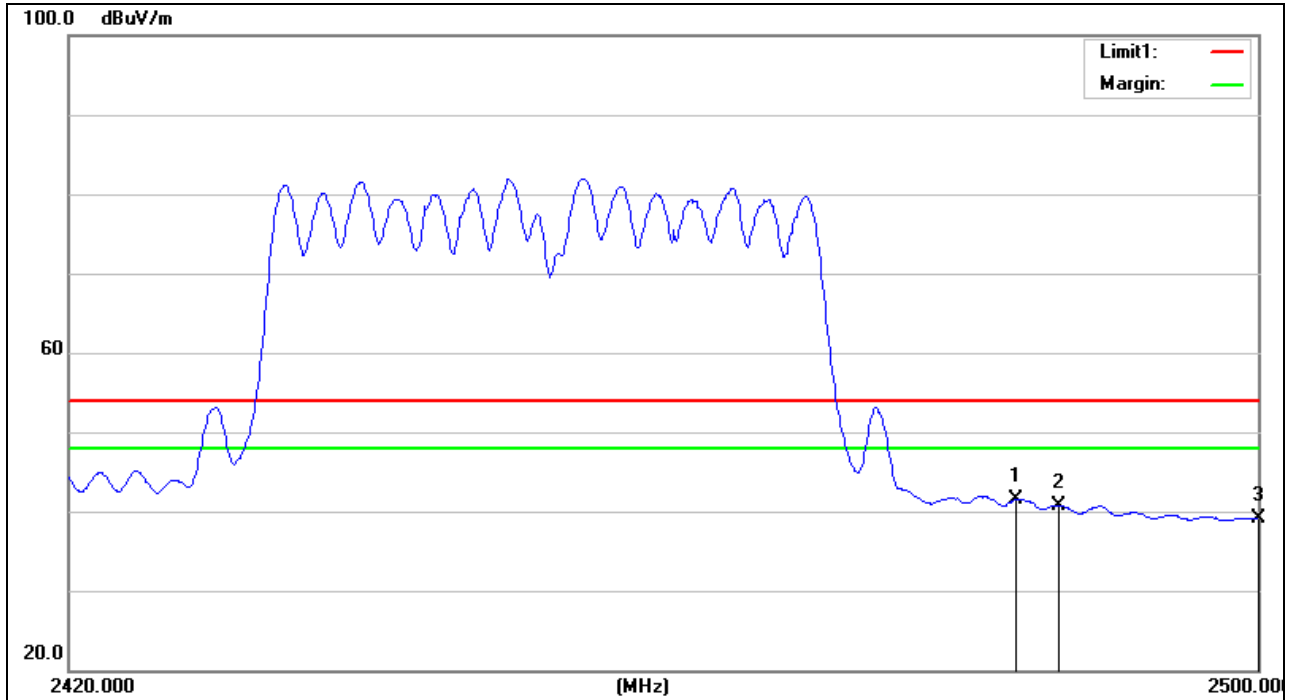

No.	Frequency (MHz)	Reading (dBuV/m)	Correct Factor(dB/m)	Result (dBuV/m)	Limit (dBuV/m)	Margin (dB)	Remark
1	2483.500	24.59	16.87	41.46	54.00	-12.54	AVG
2	2486.400	23.86	16.89	40.75	54.00	-13.25	AVG
3	2500.000	22.04	16.97	39.01	54.00	-14.99	AVG

Project No.:	ZJ00038221	Polarization:	Horizontal
Standard:	(RE)FCC PART 15 class B 3m_AVG	Power Source:	AC 120V/60Hz
Test item:	Radiation Test	Date:	2013-12-17
Temp./Hum.(%RH):	23.8/59%RH	Time:	15:46:35
EUT:	EPON ONU	Distance:	
Model:	ONT-2-E4021iWn	Test Result:	Pass
Note:	802.11 n40-2452		

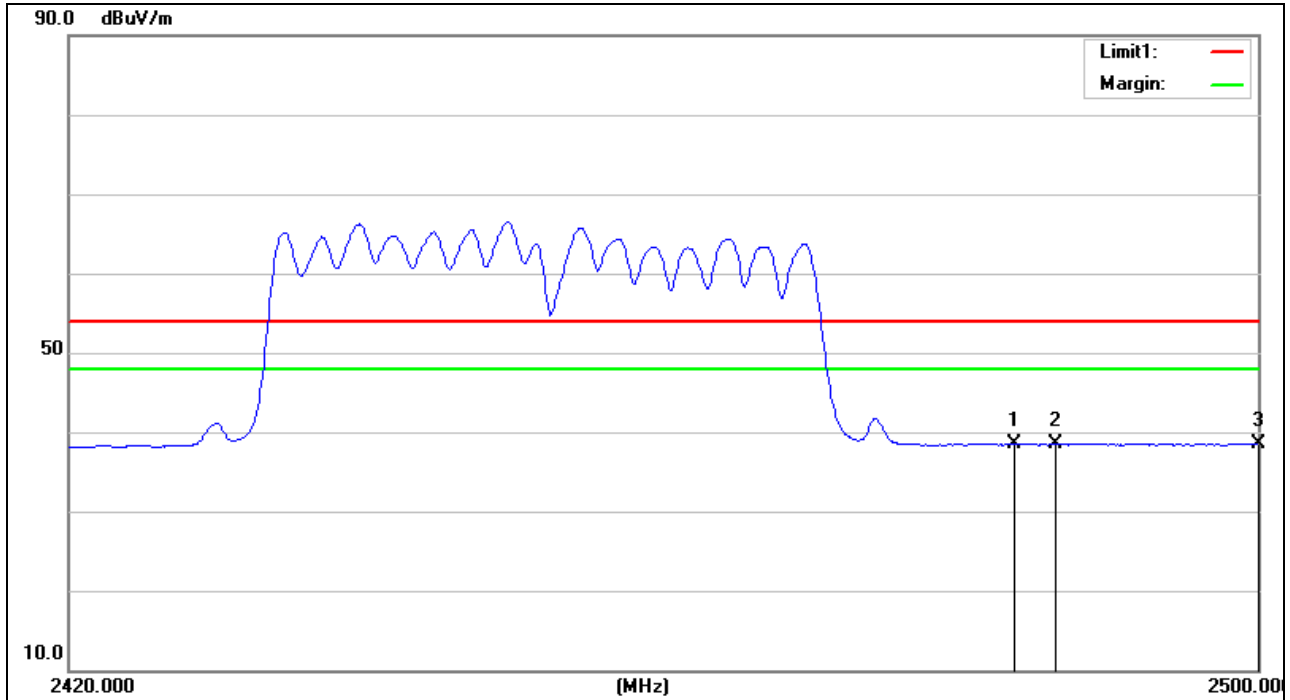

No.	Frequency (MHz)	Reading (dBuV/m)	Correct Factor(dB/m)	Result (dBuV/m)	Limit (dBuV/m)	Margin (dB)	Remark
1	2483.500	21.56	16.87	38.43	54.00	-15.57	AVG
2	2486.240	21.64	16.89	38.53	54.00	-15.47	AVG
3	2500.000	21.61	16.97	38.58	54.00	-15.42	AVG

Note: factor =Cable loss+ Space loss-Antenna factor-Amplifier

12. BAND-EDGE MEASUREMENTS

12.1 LIMITS

FCC 15.247(d) & 15.209

12.2 TEST PROCEDURES

Test procedures follow KDB 558074 D01 DTS Measurement Guidance v03r01.

Remove the antenna from the EUT and then connect a low attenuation cable from the antenna port to the spectrum.

1. Reference level measurement

Below 1GHz Set the spectrum analyzer: RBW =100KHz VBW \geq 3*RBW, Set the span to \geq 1.5 times the DTS bandwidth. Sweep = auto; Detector Function = peak. Trace = Max-hold. Allow the trace to stabilize.

2. Set the spectrum analyzer: RBW =100KHz VBW \geq 3*RBW, Set the span to \geq 1.5 times the DTS bandwidth. Sweep = auto; Detector Function = peak. Trace = Max-hold. Allow the trace to stabilize.

12.3 TEST SETUP

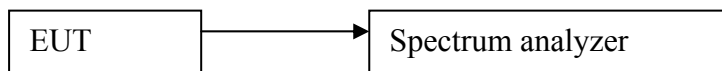

12.4 TEST RESULTS

802.11b mode:
Channel 2412MHz
reference level:

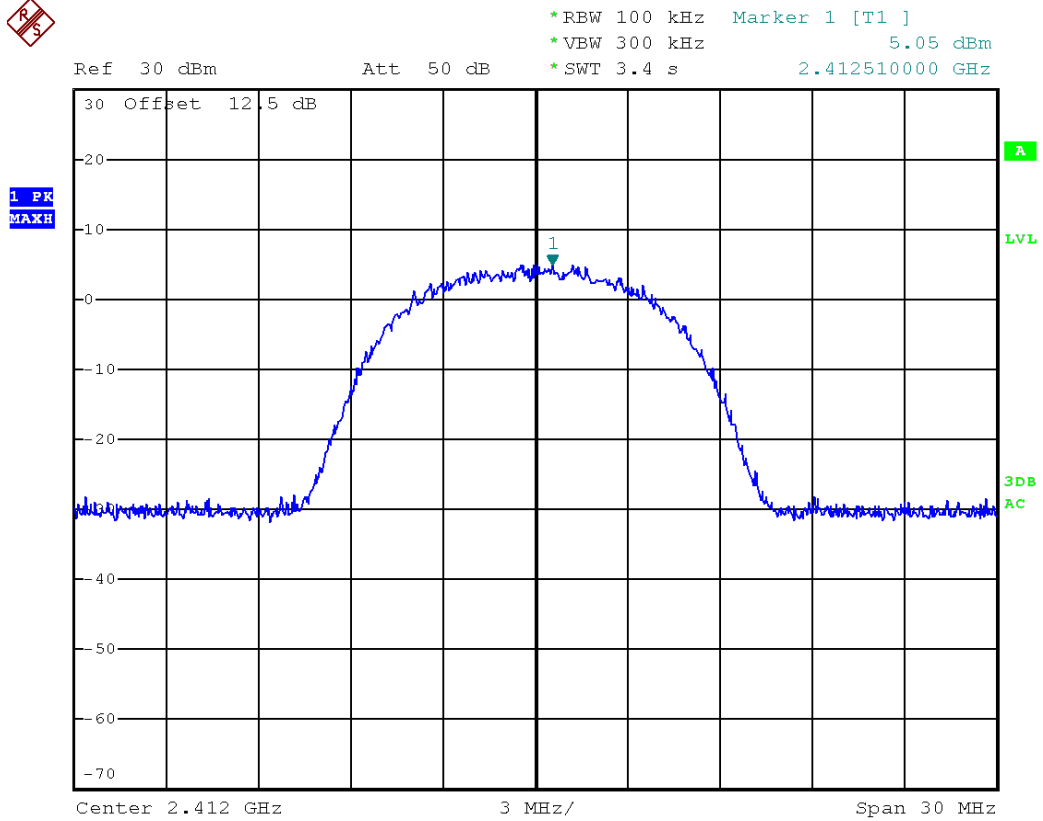

Band edge:

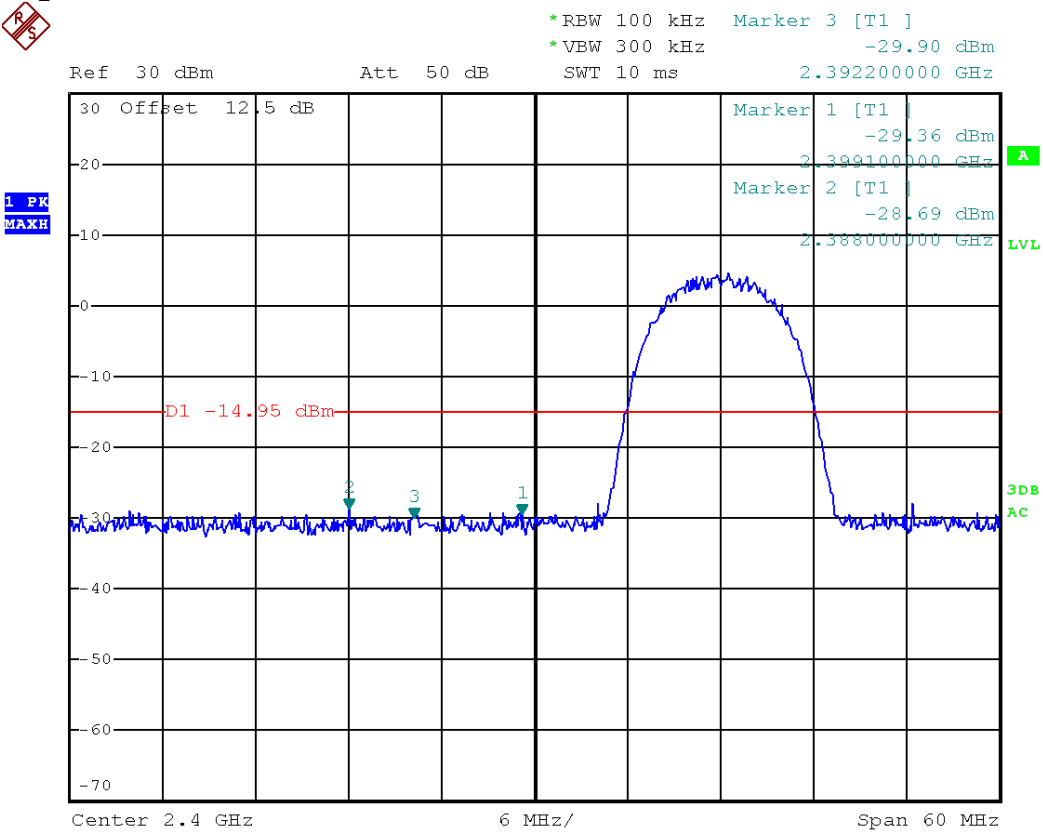

802.11b mode:
Channel 2462MHz
reference level:

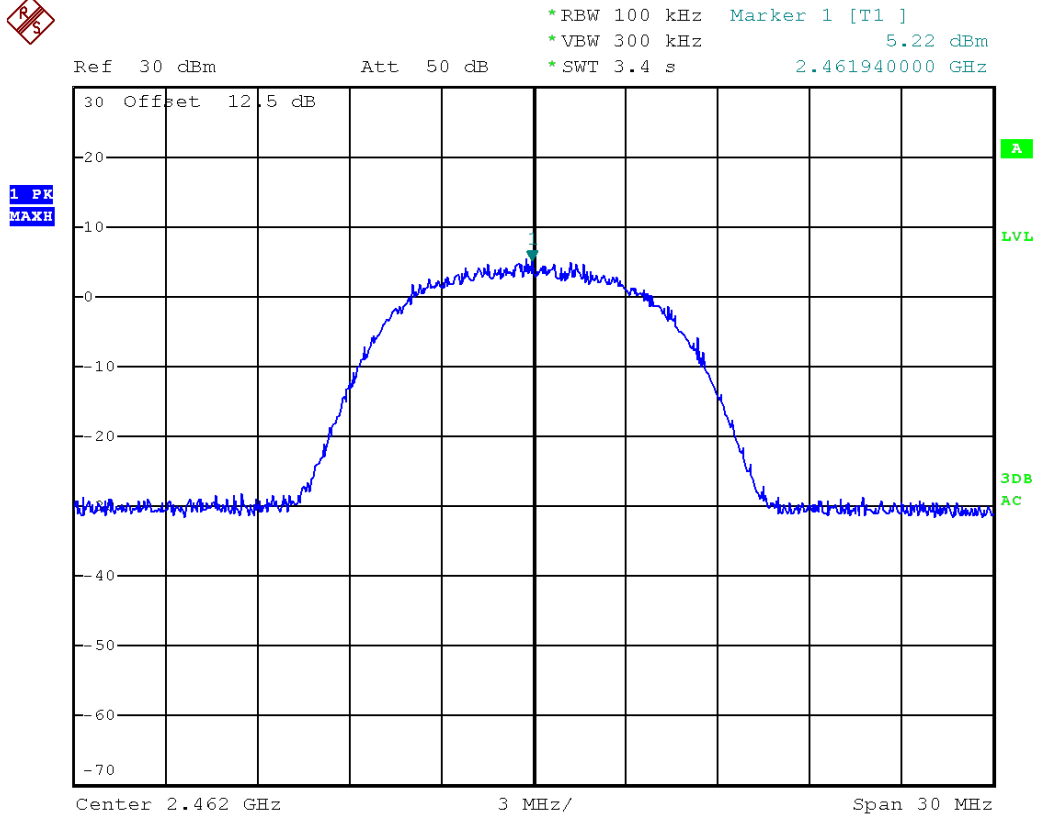

Band edge:

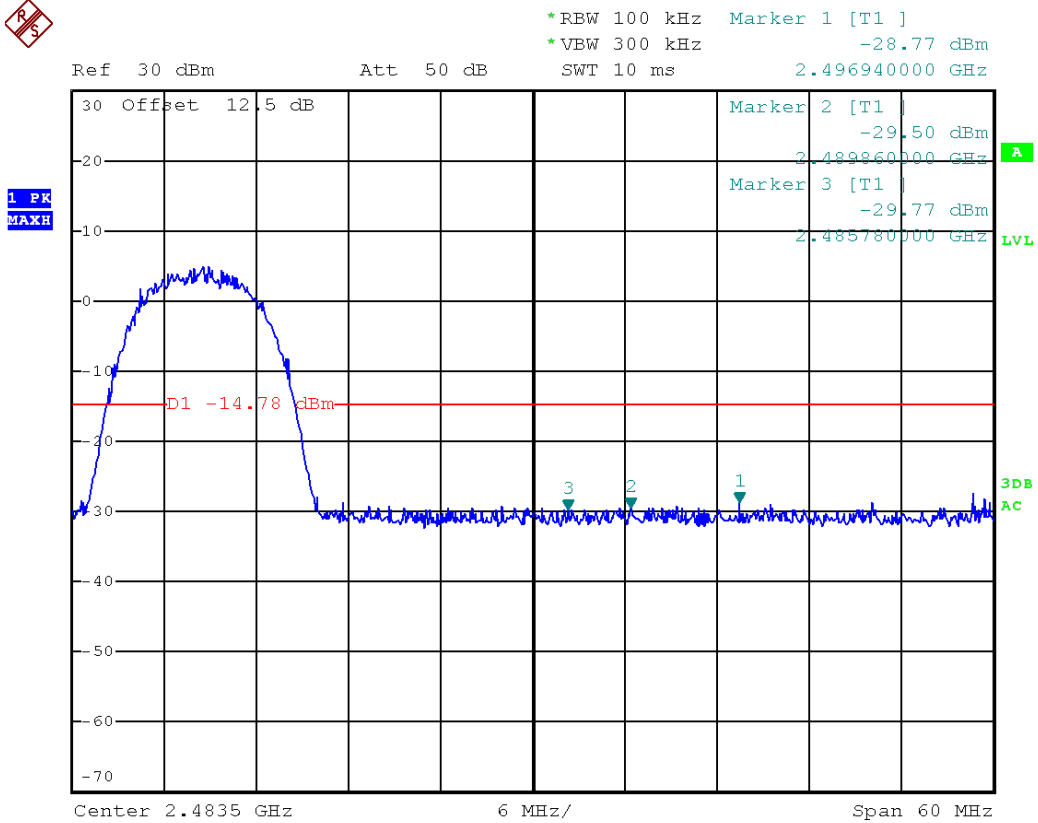

802.11g mode:
Channel 2412MHz
reference level:

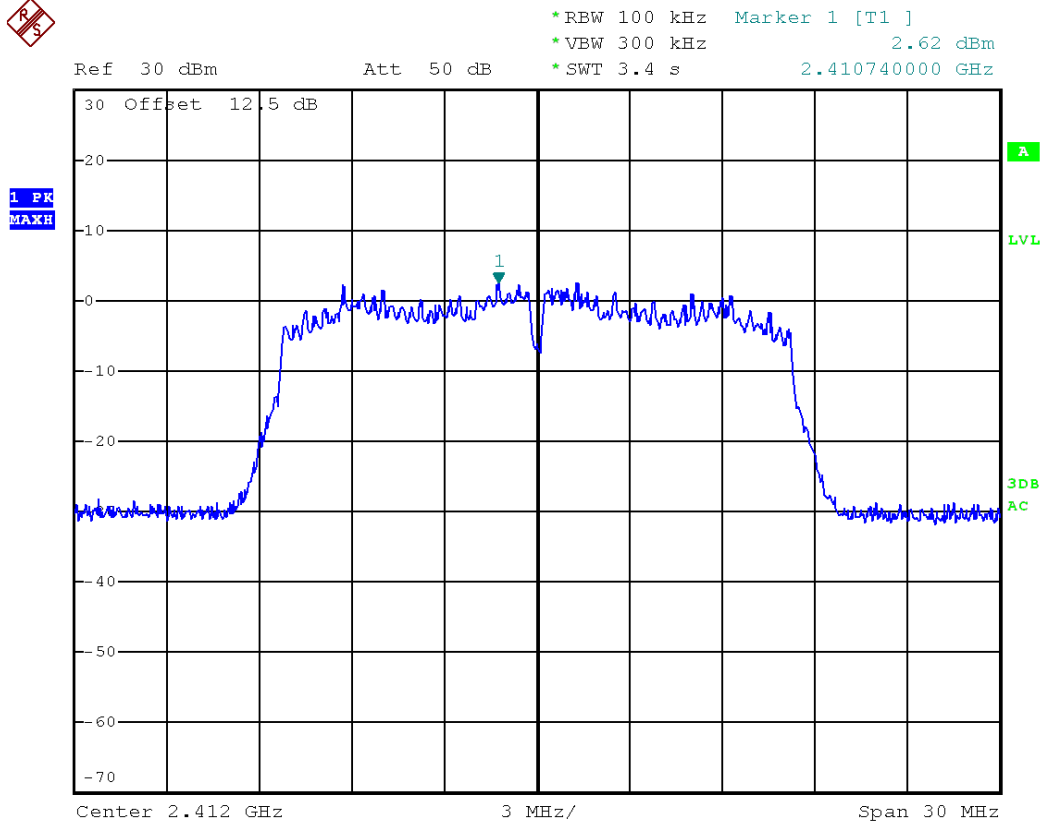

Band edge:

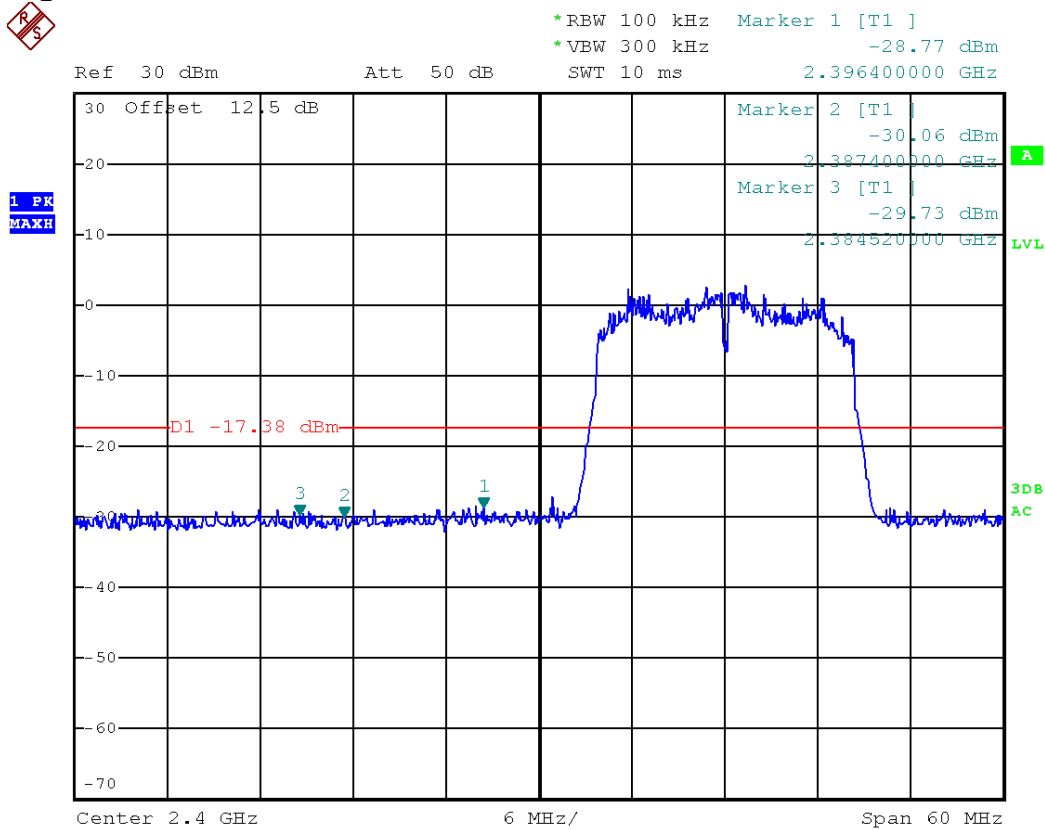

802.11g mode:
Channel 2462MHz
reference level:

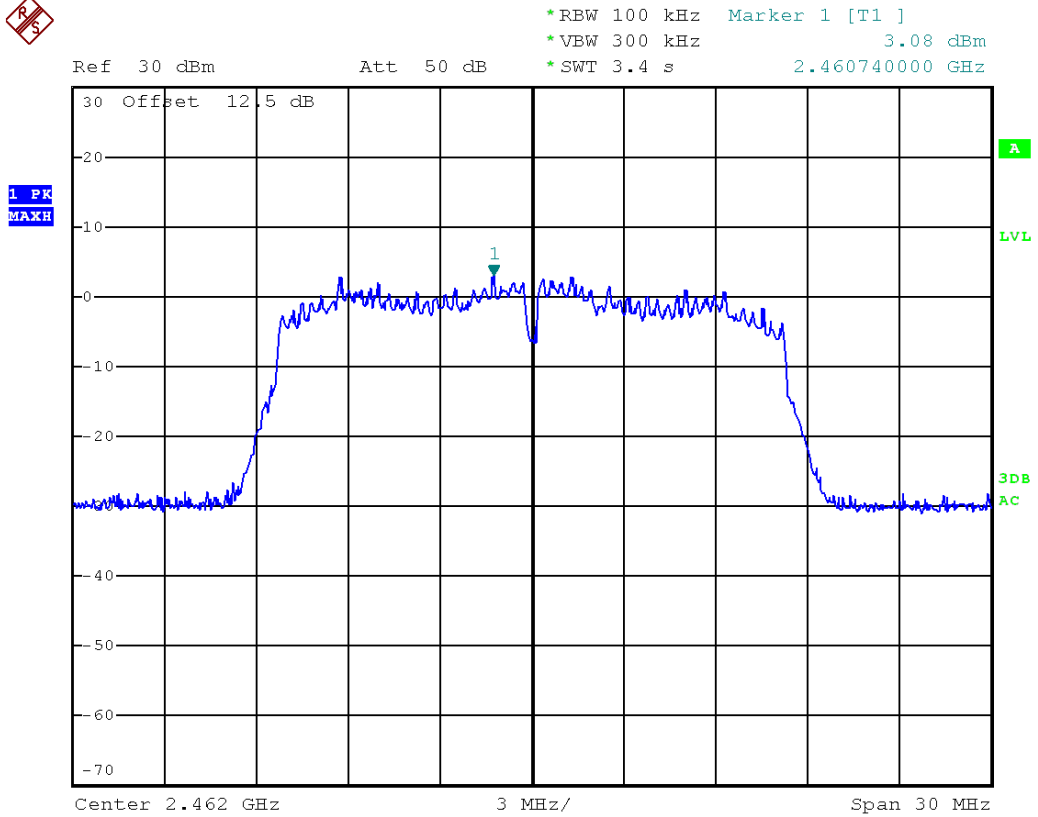

Band edge:

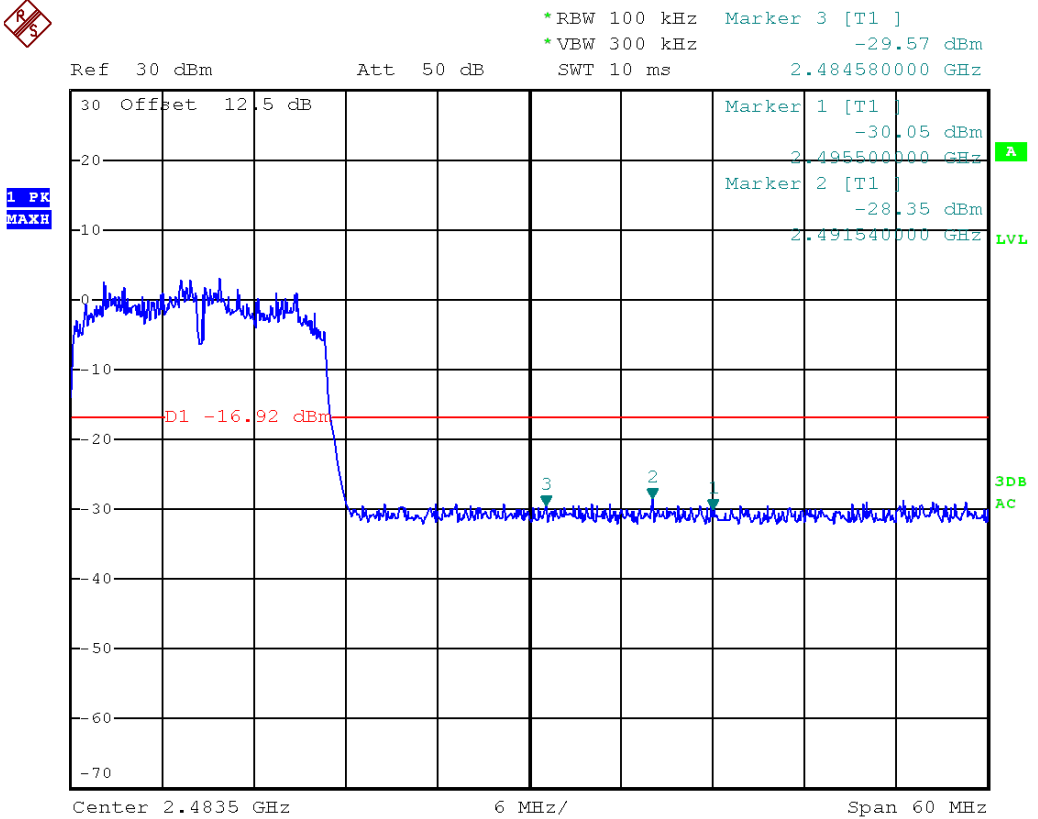

802.11n20 mode:
Channel 2412MHz
reference level:

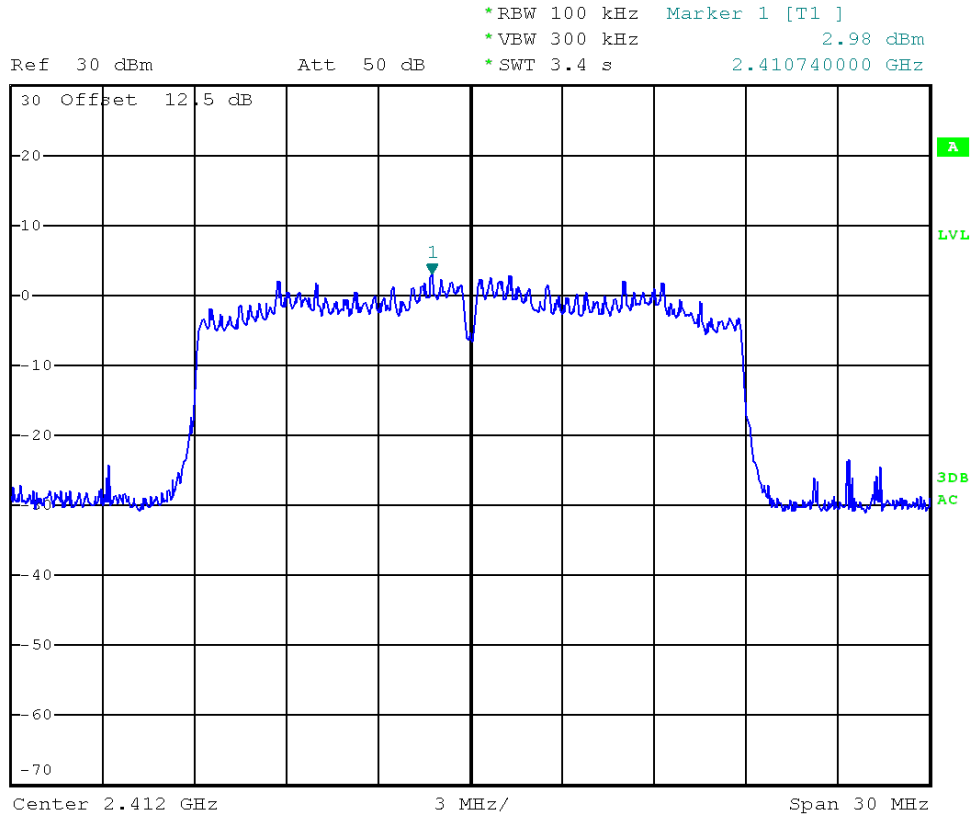

Band edge:

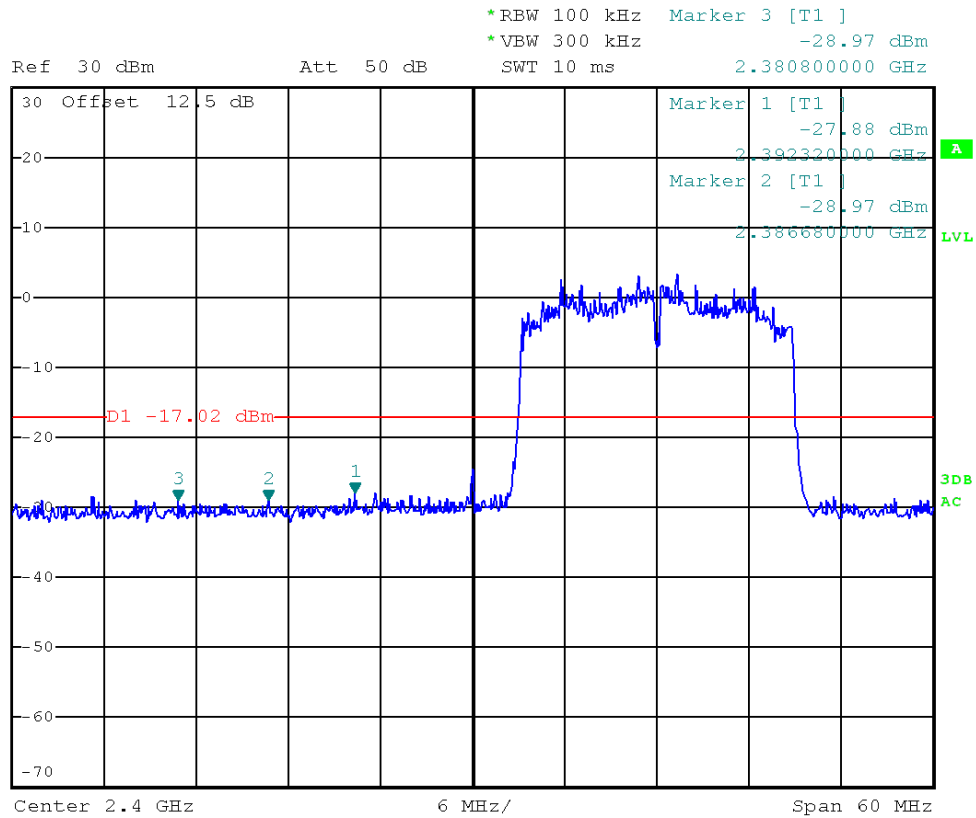

802.11n20 mode:
Channel 2462MHz
reference level:

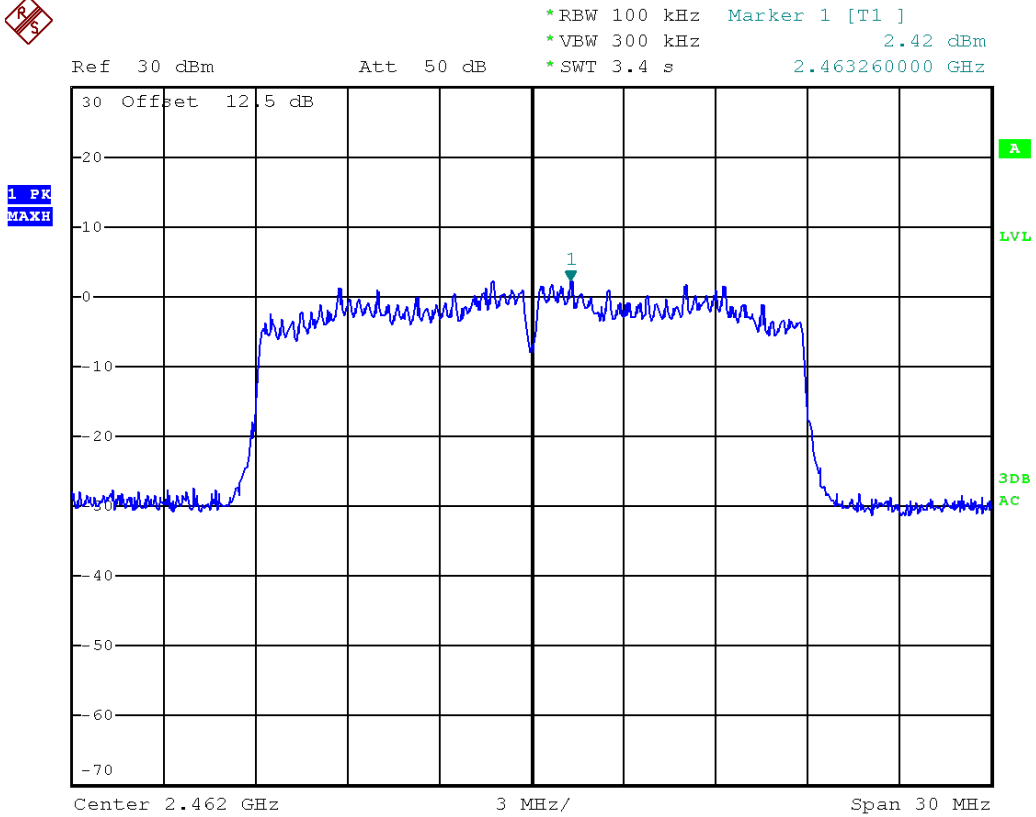

Band edge:

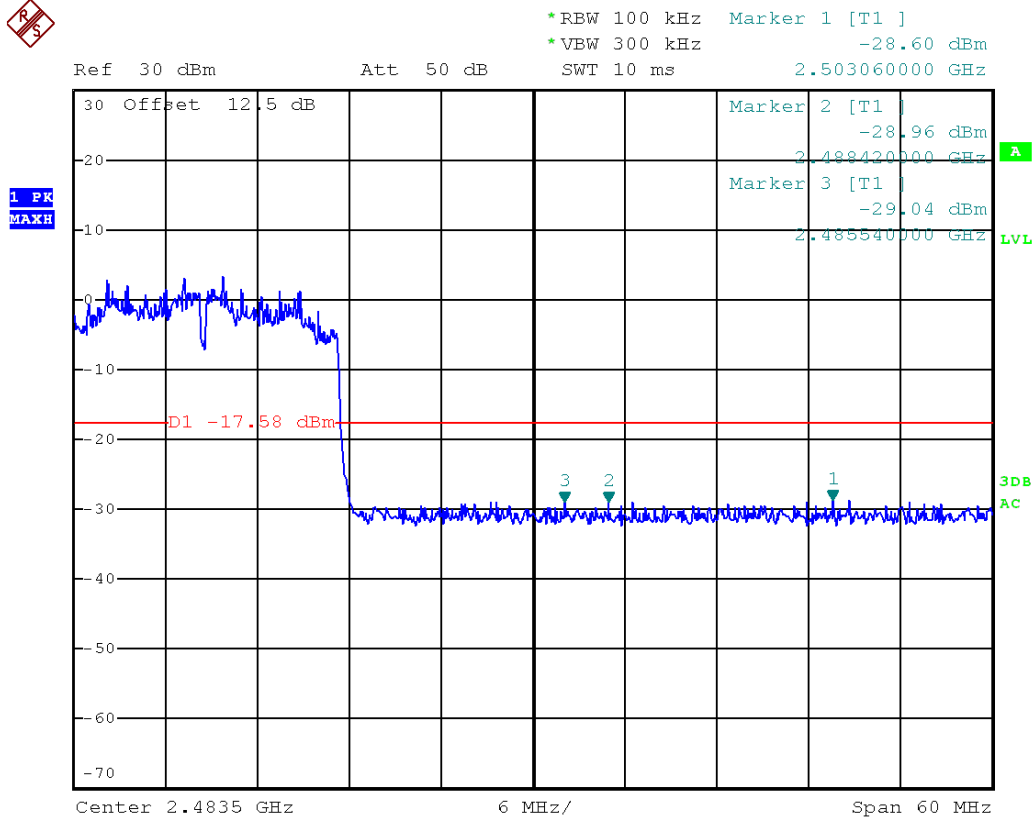

802.11n40 mode:
Channel 2422MHz
reference level:

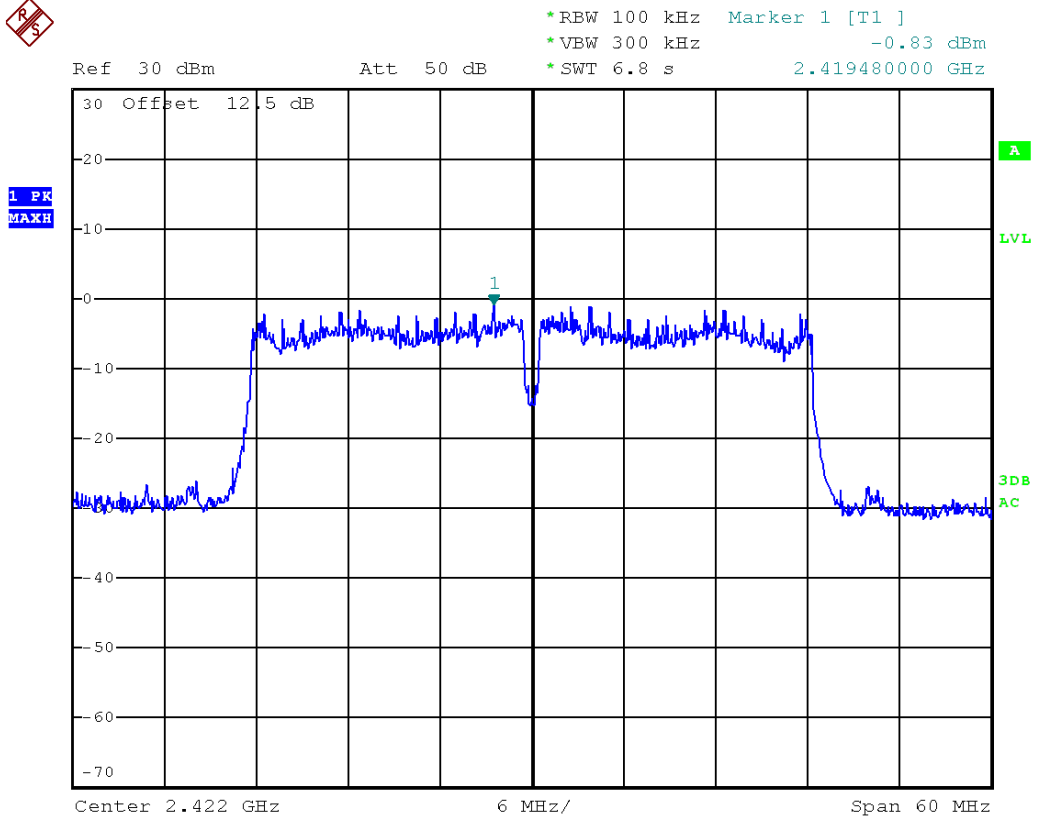

Band edge:

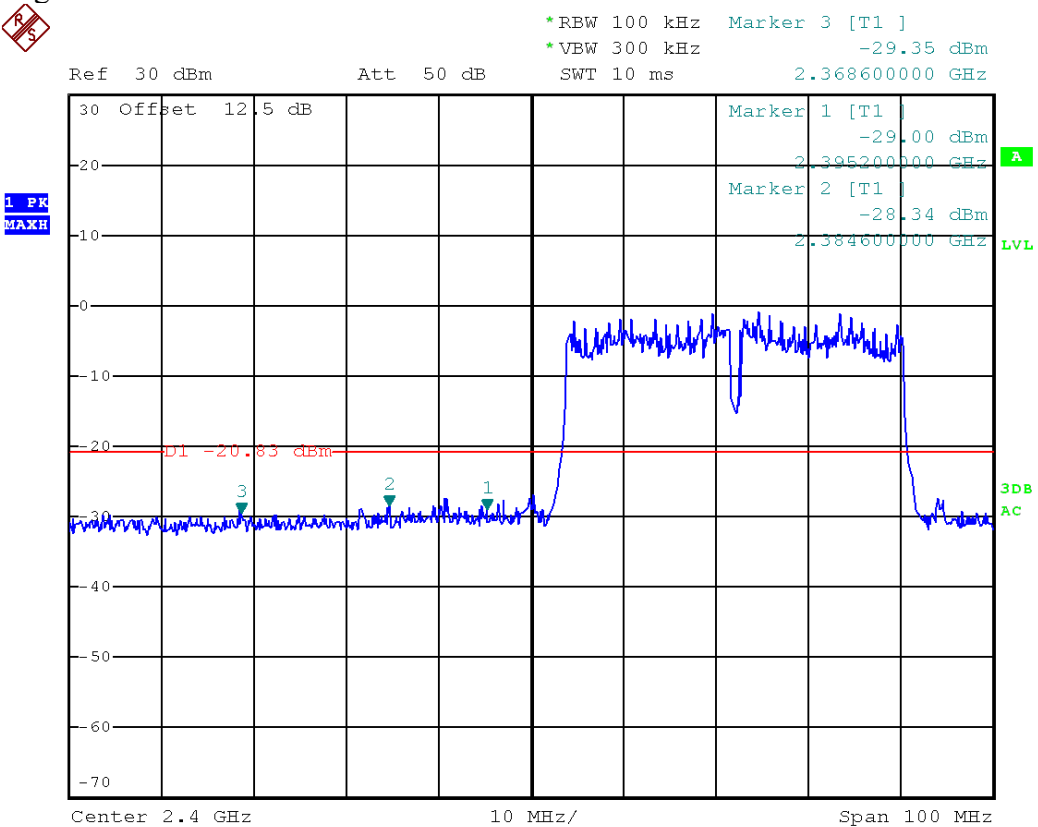

802.11n40 mode:
Channel 2452MHz
reference level:

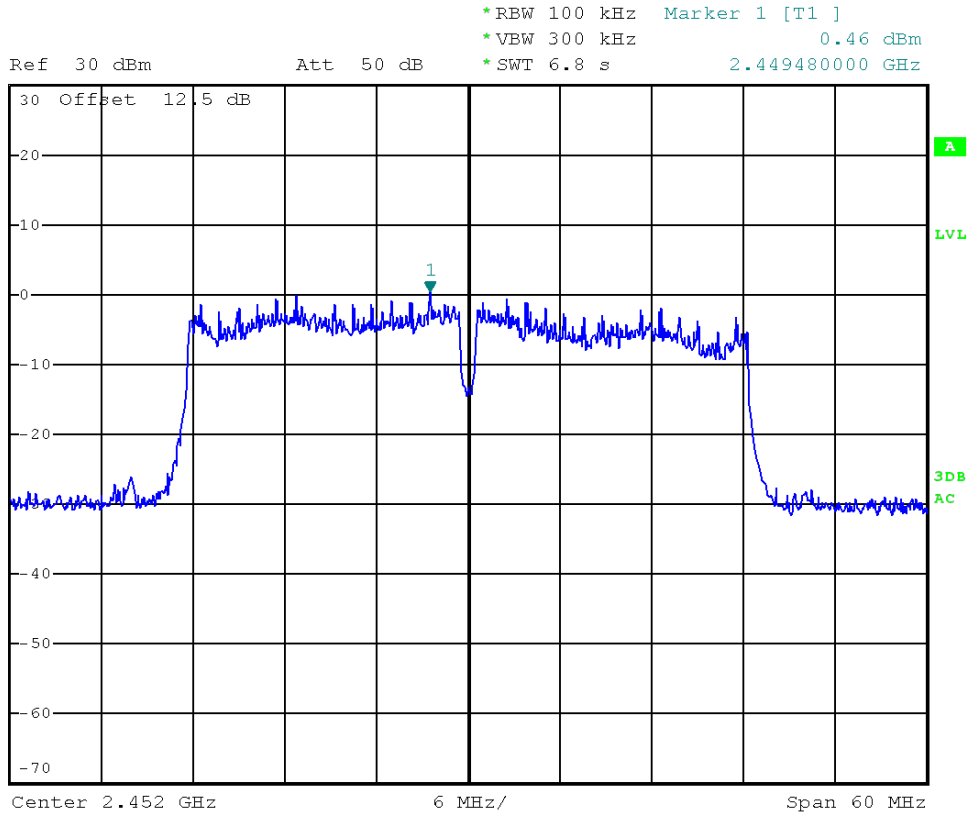

Band edge:

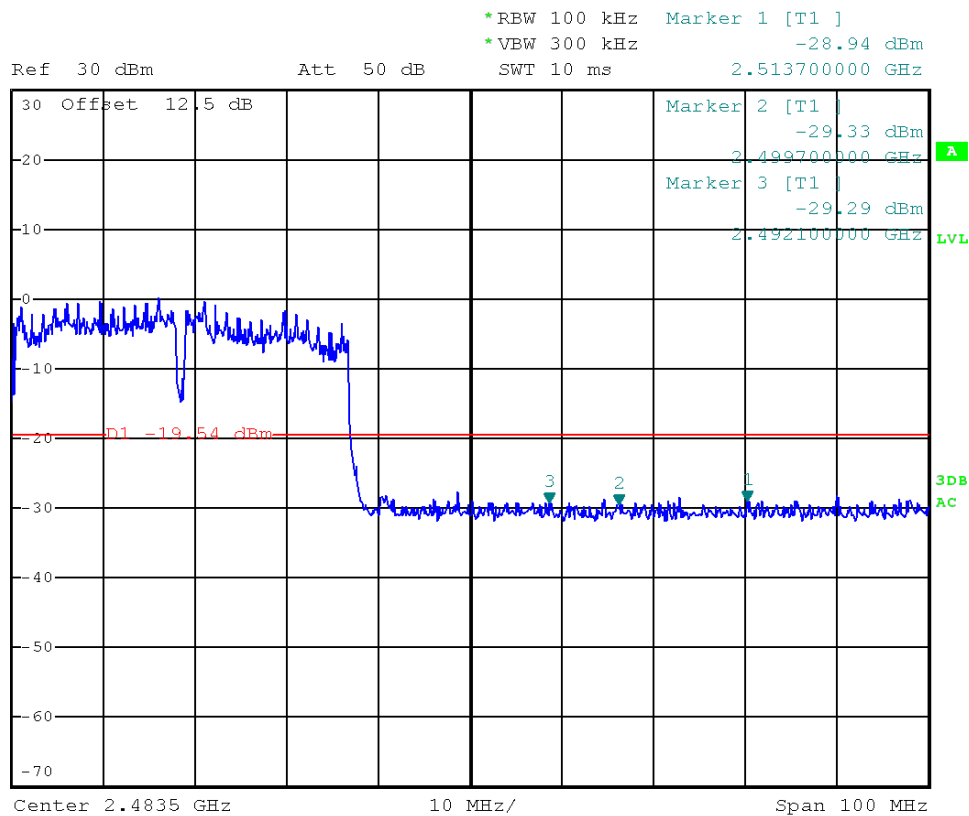

APPENDIX A: PHOTOGRAPH OF THE TEST ARRANGEMENT

RSE (9K-30M)



RSE (30M-1G)

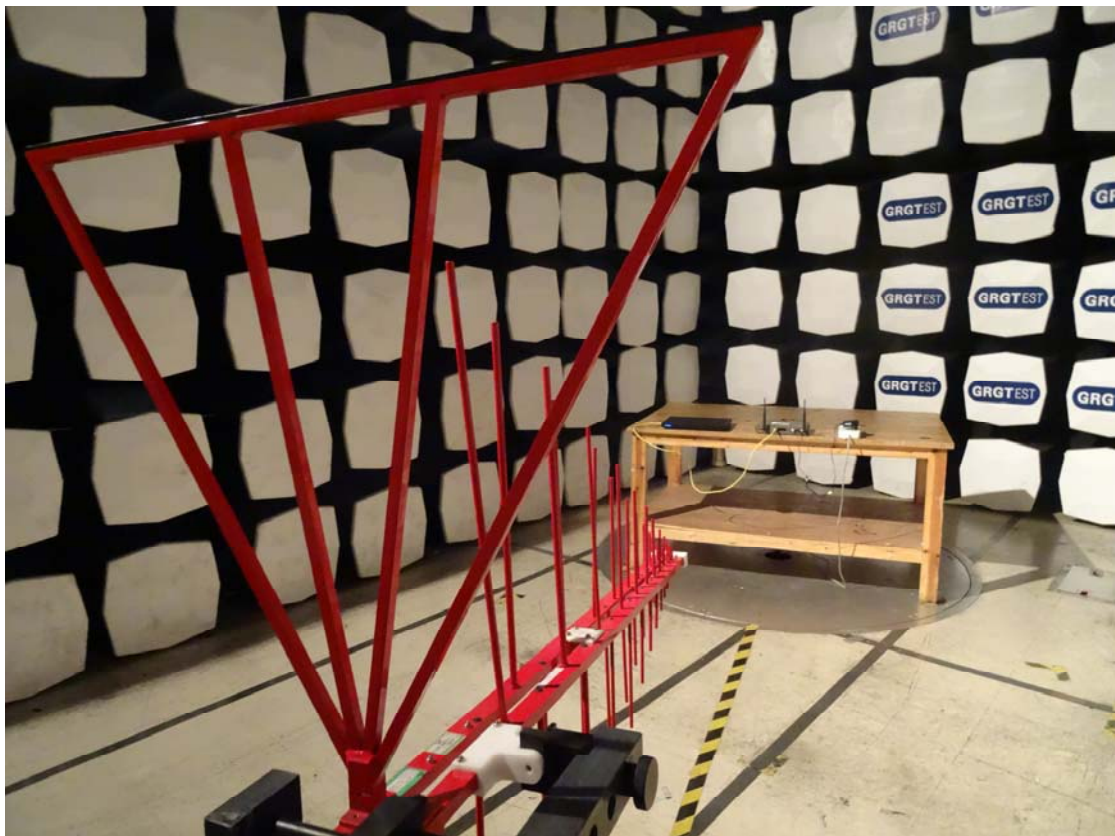

RSE (Above 1GHz)



CE



APPENDIX B: PHOTOGRAPH OF THE EUT

Model:ONT-2-E4021iWn

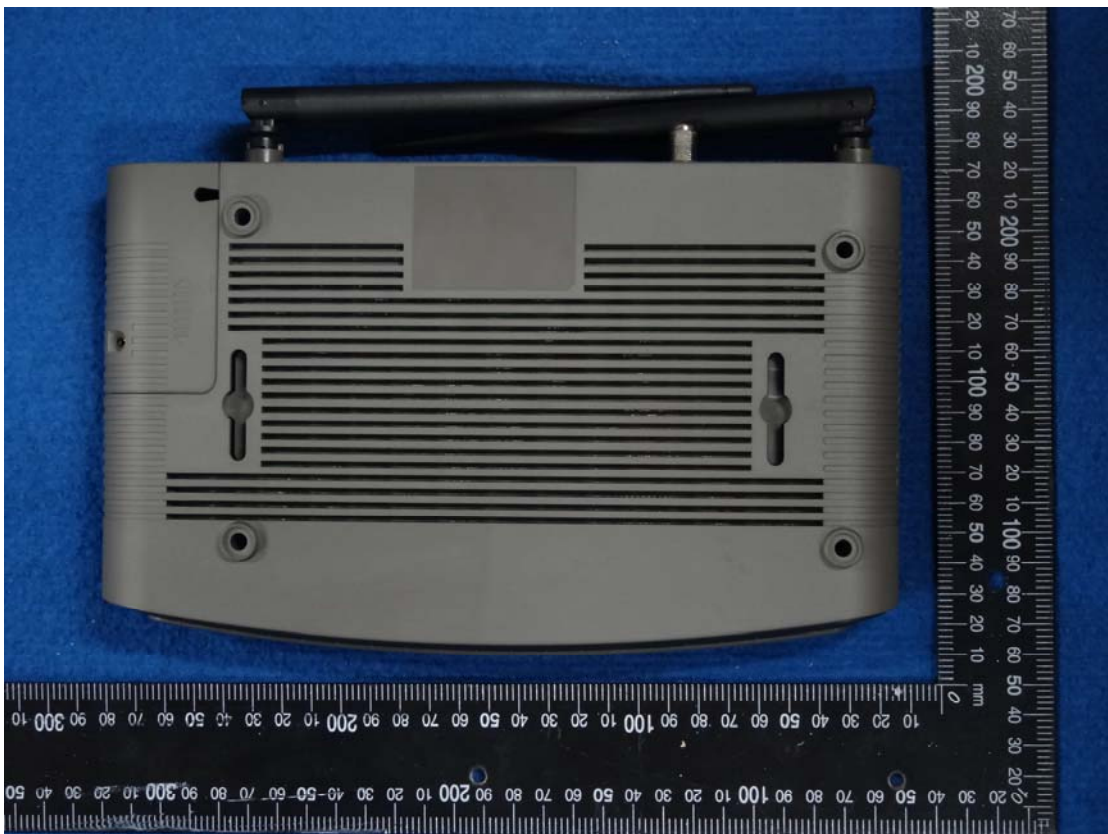





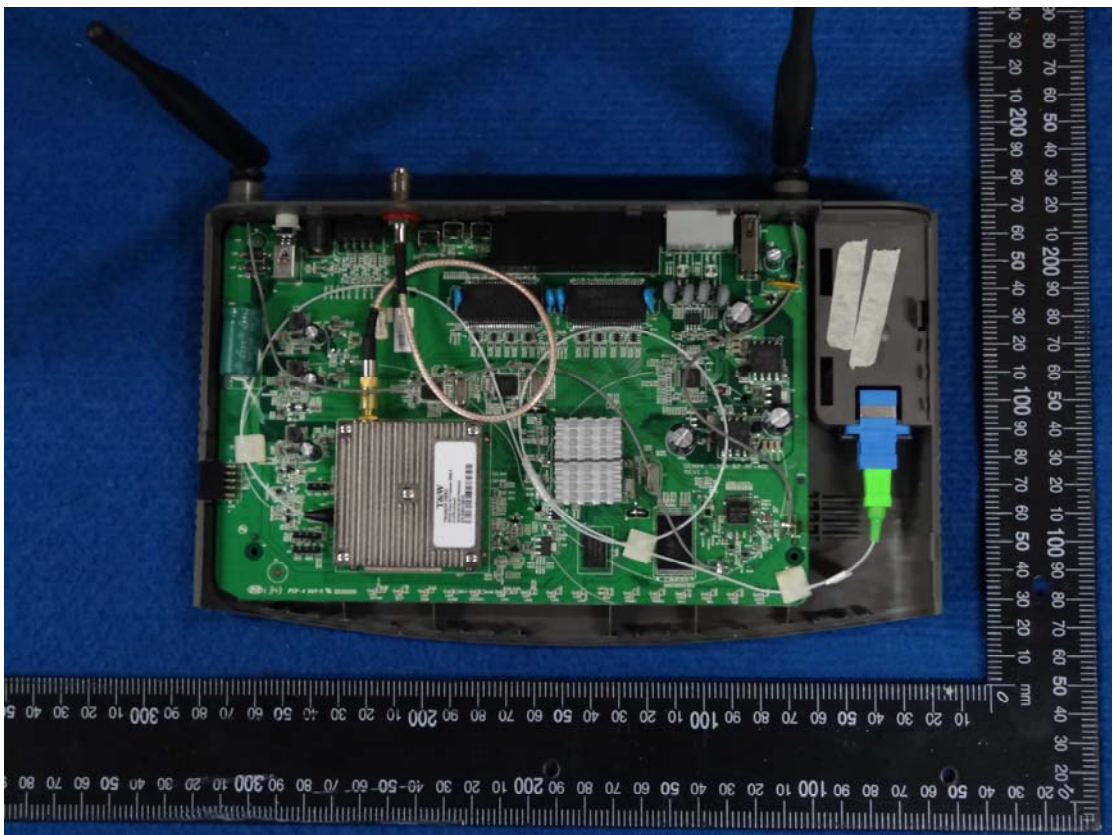
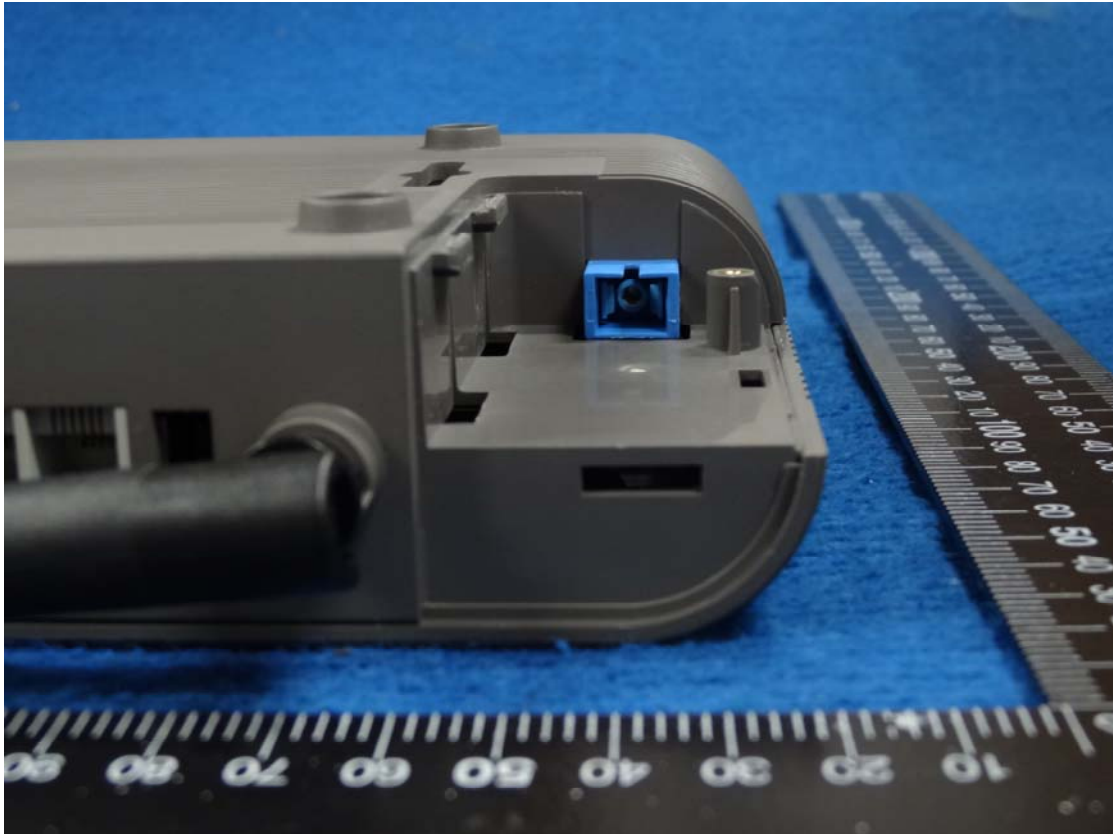

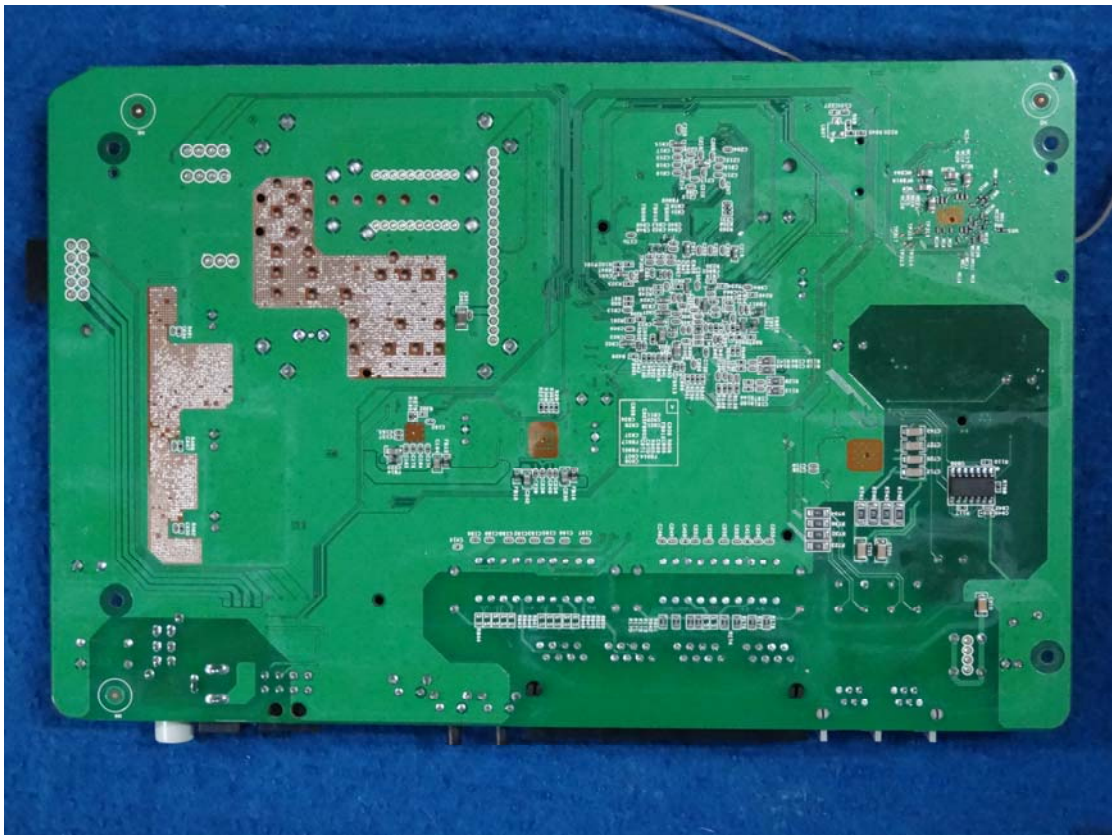

Adapter: S24B12-120A150-04



-----This is the last page of the report. -----