



### Title Search [DVD]

1. Press [SEARCH MODE] **once** while holding [SHIFT] down during playback or in the stop mode.  
The title search screen appears on the TV screen.  
Example:



2. Press the number button(s) to enter the title number.  
Example:  
To select Title No.3, press [3].  
To select Title No.10, press [1], then [0].  
To select Title No.24, press [2], then [4].  
Note:  
If you make a mistake, press [CLEAR].
3. Press [ENTER] or [▶] (Play).  
Playback starts from the selected title.

### Chapter Search [DVD]

1. Press [SEARCH MODE] **twice** while holding [SHIFT] down during playback.  
The chapter search screen appears on the TV screen.  
Example:

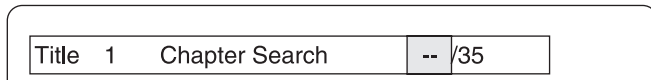

2. Press the number button(s) to enter the chapter number.  
Example:  
To select Chapter No.3, press [3].  
To select Chapter No.10, press [1], then [0].  
To select Chapter No.24, press [2], then [4].  
Note:  
If you make a mistake, press [CLEAR].
3. Press [ENTER] or [▶] (Play).  
Playback starts from the selected chapter.

### Time Search [DVD]

1. Press [SEARCH MODE] **three times** while holding [SHIFT] down during playback.  
The time search screen appears on the TV screen.

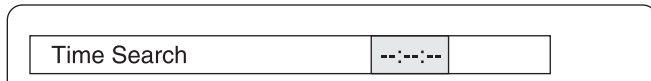

2. Press the number button(s) to enter the time.  
Example:  
20 minutes 5 seconds      Press [2], [0], [0] and [5].  
42 minutes 39 seconds      Press [4], [2], [3] and [9].  
1 hour 4 minutes 35 seconds      Press [1], [0], [4], [3] and [5].  
Note:  
If you make a mistake, press [CLEAR].
3. Press [ENTER] or [▶] (Play).  
Playback starts from the searched time.

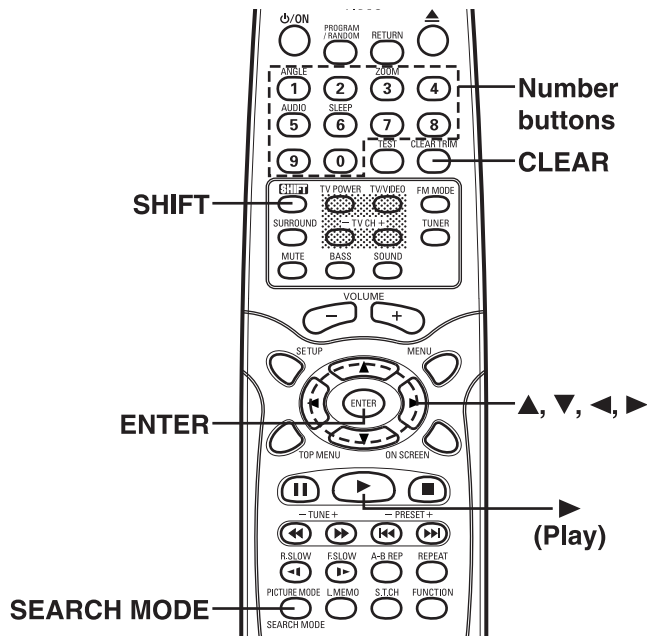

### Time Search [CD]

1. Press [SEARCH MODE] **once** while holding [SHIFT] down during playback.  
The time search screen appears on the TV screen.

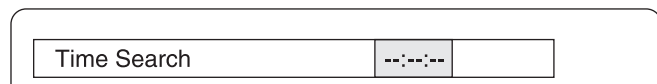

2. Press the number button(s) to enter the time.  
Example:  
2 minutes 5 seconds      Press [2], [0] and [5].  
42 minutes 39 seconds      Press [4], [2], [3] and [9].  
Note:  
If you make a mistake, press [CLEAR].
3. Press [ENTER] or [▶] (Play).  
Playback starts from the searched time in the track.

### Track Search [CD]

1. Press the number buttons during playback or in the stop mode.

Example:  
To select Track No. 3, press [3].  
To select Track No. 10, press [1], then [0].  
To select Track No. 24, press [2], then [4].

2. Press [ENTER] or [▶] (Play).  
Playback starts from the selected track.

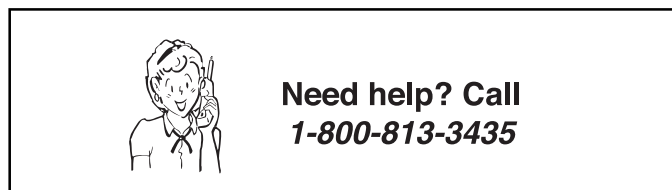



## Fast Playback

### Fast forward playback

Press [▶▶] repeatedly to select the fast speed forward playback.

[DVD]

▶▶ 1 → ▶▶ 2 → ▶▶ 3 → ▶▶ 4 (4 steps)

[CD]

▶▶ 1 → ▶▶ 2 (2 steps)

Press [▶] (Play) to return to normal playback.

### Fast reverse playback

Press [◀◀] repeatedly to select the fast speed reverse playback.

[DVD]

◀◀ 1 → ◀◀ 2 → ◀◀ 3 → ◀◀ 4 (4 steps)

[CD]

◀◀ 1 → ◀◀ 2 (2 steps)

Press [▶] (Play) to return to normal playback.

Note:

The sound is muted during fast playback in DVD.

## Slow Motion Playback [DVD]

### Forward slow playback

Press [F.SLOW ▶] repeatedly to select the forward slow speed playback.

▶ 1 → ▶ 2 → ▶ 3 → ▶ 4 (4 steps)

Press [▶] (Play) to return to normal playback.

### Reverse slow playback

Press [R.SLOW ◀] repeatedly to select the reverse slow speed playback.

◀ 1 → ◀ 2 → ◀ 3 → ◀ 4 (4 steps)

Press [▶] (Play) to return to normal playback.

Note:

The sound is muted during slow motion playback.

## Still Picture (Pause)

Press [⏸] during playback.

- "⏸" appears on the FL display.
- "⏸" appears briefly on the TV screen.

[DVD]

Still picture mode

[CD]

Pause mode

Press [▶] (Play) to return to normal playback.

Note: The sound is muted.

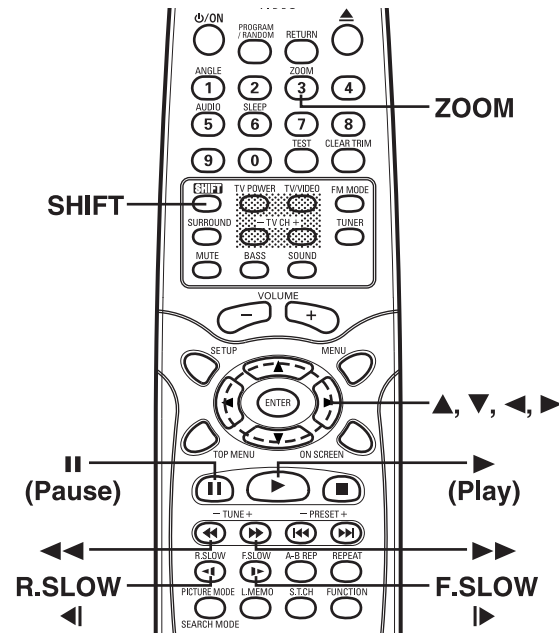

## Frame by Frame Advance Playback [DVD]

Press [⏹] during still picture.

- "⏹" appears briefly on the TV screen.
  - Each time the button is pressed, the picture advances one frame.
- Press [▶] (Play) to return to normal playback.

Notes:

- The sound is muted.
- Frame playback is operated forward only.

## Picture Zoom [DVD]

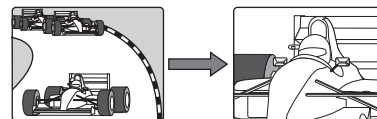

1. Press [ZOOM] while holding [SHIFT] down during normal/slow playback or still picture. The central part of the picture is magnified, and "Q1" appears on the TV screen.
  - Each time the button is pressed, the zoom mode will be changed as follows:

Q1 → Q2 → Q3 → Q4 → QOff

- Press [▲], [▶], [▼] or [◀] to change the zoom point.

2. Press [ZOOM] while holding [SHIFT] down to select "QOff" to return to the original screen.

Note:

Picture Zoom may not work on some discs.

### Important Note:

"⊘" may appear on the TV screen during operation. This icon means that the function is not available on the disc now.



Need help? Call  
1-800-813-3435

## Viewing from a Desired Camera Angle (Multi-Angle) [DVD]

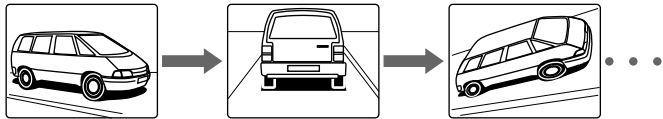

Some DVD video discs may contain scenes which have been shot simultaneously from a number of different camera angles. The jacket or case of discs that are recorded with angles will be marked.

Example:



Note:

The recorded angles differ depending on the disc used.

1. Play the disc that is recorded with angles.
2. Press [ANGLE] repeatedly while holding [SHIFT] down until the desired angle appears.

Example:

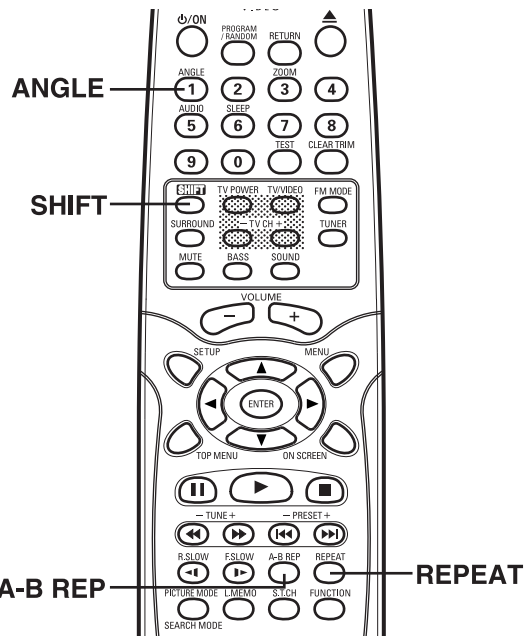

## Designated Range Repeat Playback (A-B Repeat)

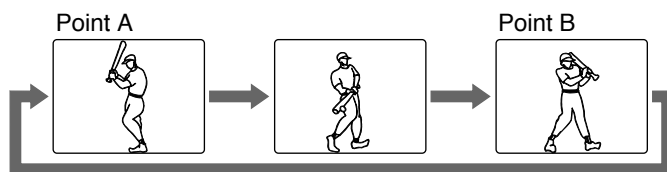

1. Press [A-B REP] during playback at the beginning of the section you want to repeat (Point A).
  - “A” appears on the TV screen.
  - “REP. A->B” appears, and “A->B” blinks on the display.
2. Press [A-B REP] again at the end of the section you want to repeat (Point B).
  - “B” appears briefly on the TV screen.
  - “REP. A->B” remains lit on the display.

The section between points A and B is played repeatedly.
3. To return to normal playback, press [A-B REP] again.
  - “Off” appears briefly on the TV screen.

Note:

Repeat playback or A-B repeat playback mode may not work correctly with some discs.

### Important Note:

“⊘” may appear on the TV screen during operation. This icon means that the function is not available on the disc now.



**Need help? Call  
1-800-813-3435**

## Repeat Playback

Press [REPEAT] during playback (or programmed or random playback) of the title (or track) you want to repeat. Each time the button is pressed, the repeat mode will be changed as follows.

[DVD]

TV screen	Display	Operation
Chapter	REP.1	Repeat of the chapter being played
Title	ALL REP.	Repeat of the title being played
Off		Repeat off mode

[CD]

During Normal Playback

TV screen	Display	Operation
1	REP.1	Repeat of the track being played
All	ALL REP.	Repeat all tracks
Off		Repeat off mode

During Programmed Playback

TV screen	Display	Operation
Program 1	REP.1	Repeat the programmed track being played
Program All	ALL REP.	Repeat all programmed tracks
Off		Repeat off mode

During Random Playback

TV screen	Display	Operation
1	REP.1	Repeat of the track being played
All	ALL REP.	Repeat all tracks at random
Off		Repeat off mode



### Random Playback [CD]

1. Press [PROGRAM/RANDOM] **once** in the stop mode.
  - “Random On” appears on the TV screen.
  - “RND” blinks on the display.
2. Press [▶] (Play) to begin random playback.
  - “RND” remains lit on the display.
 The unit will automatically select tracks at random.

Note:

To stop random playback, press [■].

### Programmed Playback [CD]

Up to 20 selections can be programmed.

#### Programming procedure

1. Press [PROGRAM/RANDOM] **twice** in the stop mode.
  - “Program Mode” screen appears on the TV screen.
  - “-- Pr. 1” appears, and “PROG.” blinks on the display.
2. Press the number buttons to select the track number.  
Example:  
To select Track No.3, press [0], then [3].  
To select Track No.10, press [1], then [0].  
To select Track No.24, press [2], then [4].  
Notes:
  - If you make a mistake, press [CLEAR].
  - To quit the “Program Mode” screen, press [PROGRAM/RANDOM].
3. Press [▼] to move the highlighted box down.  
Example:

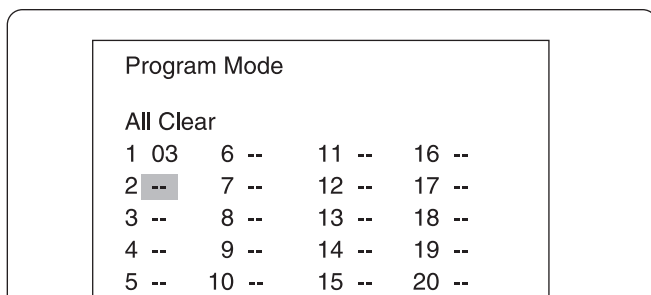

4. Repeat steps 2 and 3 as above to select other tracks.
5. Press [▶] (Play) to start playback.  
When all programmed selections have played, the unit stops automatically.
  - The programmed contents are retained in memory.

Note:

To play the program again, press [PROGRAM/RANDOM] **twice** to call up the “Program Mode” screen, then press [▶] (Play).

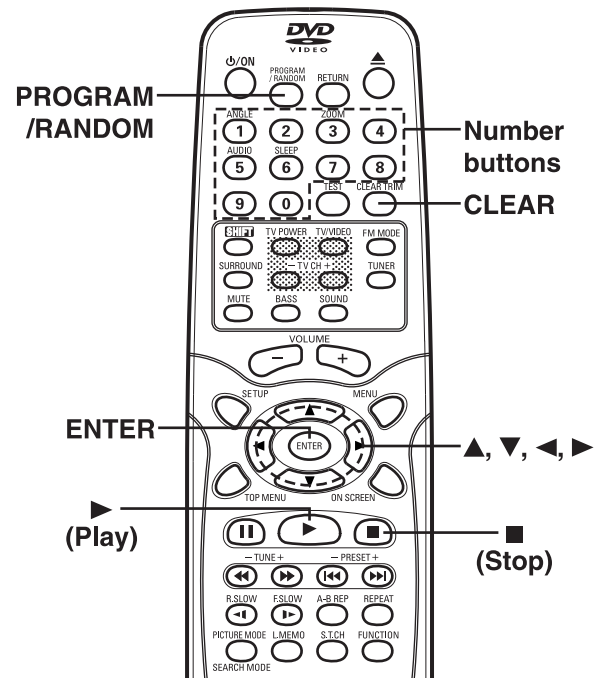

#### To clear the program one by one

1. Press [PROGRAM/RANDOM] **twice** to display the “Program Mode” screen.
2. Press [▲], [▶], [▼] or [◀] to select the track number.
3. Press [CLEAR].

#### To clear all the programs

1. Press [PROGRAM/RANDOM] **twice** to display the “Program Mode” screen.
2. Press [▲] to select “All Clear”.
3. Press [ENTER].

#### To change the program

1. Press [PROGRAM/RANDOM] **twice** to display the “Program Mode” screen.
2. Press [▲], [▶], [▼] or [◀] to select the track number.
3. Press the number buttons to select the track number to be replaced.

Note:

To quit the “Program Mode” screen, press [PROGRAM/RANDOM].

#### Important Note:

“⊘” may appear on the TV screen during operation. This icon means that the function is not available on the disc now.



**Need help? Call  
1-800-813-3435**



## Selecting Subtitle Language [DVD]

This operation works only with discs on which multiple subtitle languages are recorded.

Press [S.T.CH] repeatedly during playback until the desired subtitle language appears on the TV screen.

Example:

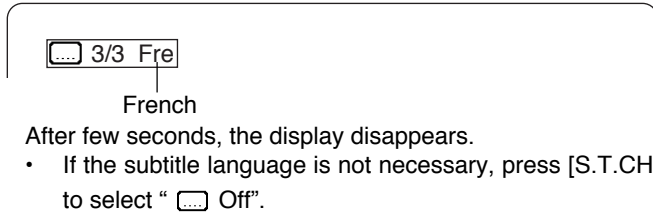

Notes:

- In some cases, the subtitle language is not changed to the selected one.
- When a disc supporting closed caption is played, the subtitle and the closed caption may overlap each other on the TV screen. In this case, turn the subtitle off.
- When the desired language is not selected even if the button is pressed, the language is not available on the disc.
- When the power is turned on or the disc is replaced, select the subtitle language again.
- Please refer to "Setting Language" on page E33.

## Selecting Audio Soundtrack Language (Multi-Language) [DVD]

This operation works only with discs on which multiple audio soundtrack languages are recorded.

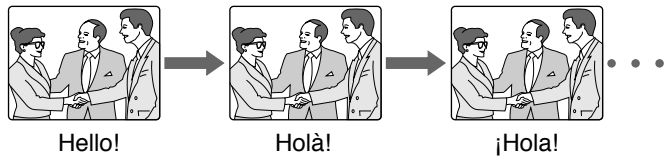

Press [AUDIO] repeatedly while holding [SHIFT] down during playback until the desired language appears on the TV screen.

Examples:

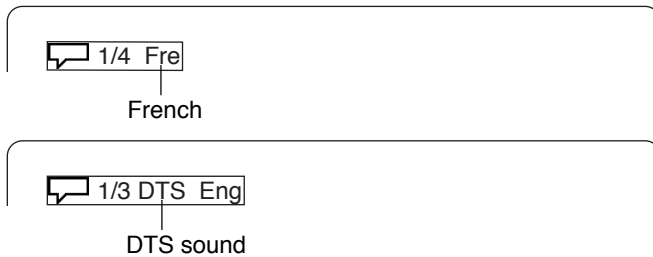

Notes:

- When the desired language is not selected even if the button is pressed, the language is not available on the disc.
- When the power is turned on or the disc is replaced, select the language again.
- If the language is not recorded on the disc, only the available language on the disc will be heard.

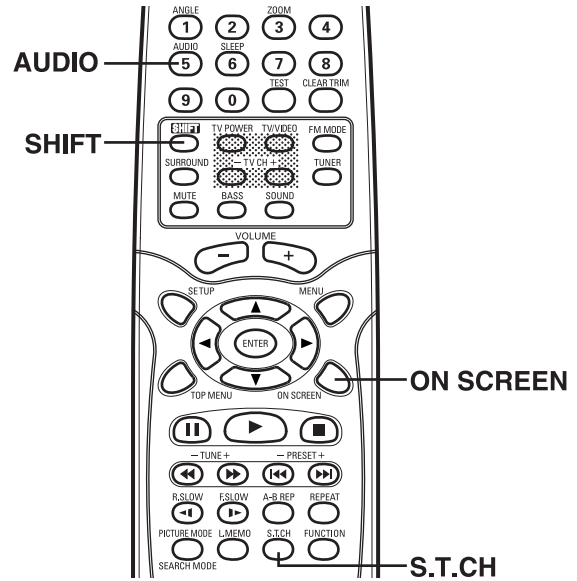

## Selecting On-Screen Information

Press [ON SCREEN] repeatedly to show the disc information (Title, Chapter, Title elapsed playing time, Language, etc.).

Example for DVD:

1. Press [ON SCREEN] during playback.

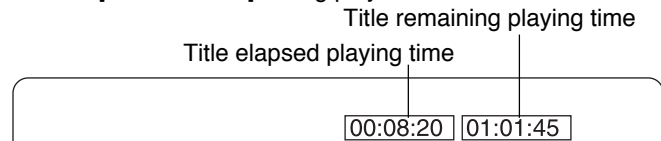

2. Press [ON SCREEN] again.

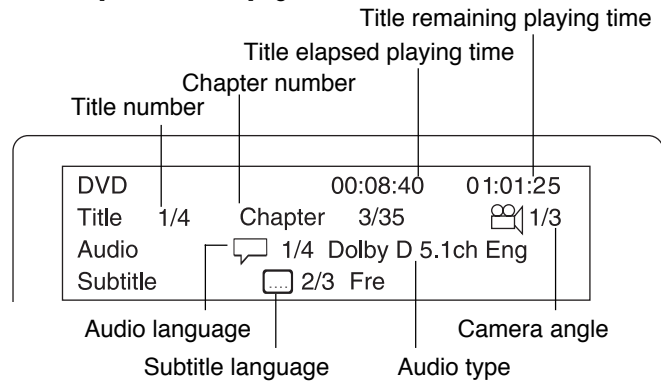

3. Press [ON SCREEN] to close the disc information.

Example for Audio CD:

1. Press [ON SCREEN].

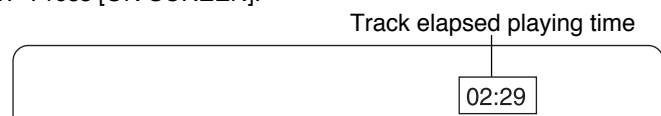

2. Press [ON SCREEN] again.

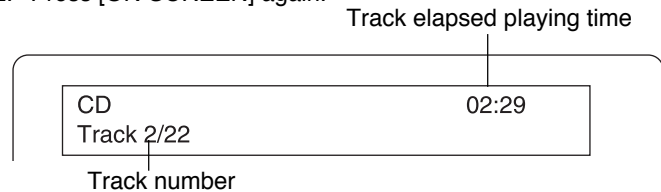

3. Press [ON SCREEN] to close the disc information.

# TVGuardian® OPERATION

## Before Setting

- Initial setting is "CC Channel CC2" on this unit.
- Please set "CC2" or "C2" (Closed caption on channel 2) on your TV first. For more details, please refer to your TV's owner manual.
- When "TVG" is set, the subtitle language may not appear.
- TVG works on the discs with closed caption. See page E20.

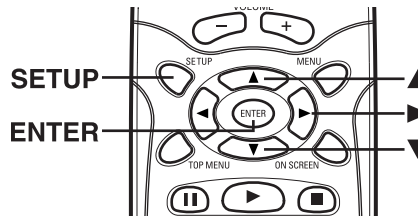

## Setting TVGuardian®

1. Press [SETUP] in the stop mode. The setup screen appears.
2. Press [▶] to select "Parental".
3. Press [ENTER]. "Parental" screen appears.

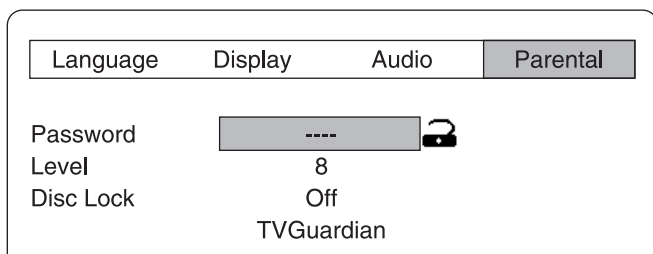

4. Press [▼] to select "TVGuardian".

**Note:**

If the parental lock "🔒" is set, the highlighted box does not move. **You must enter the password to release the parental lock first.** See page E37.

5. Press [ENTER]. "TVG Setup" screen appears.

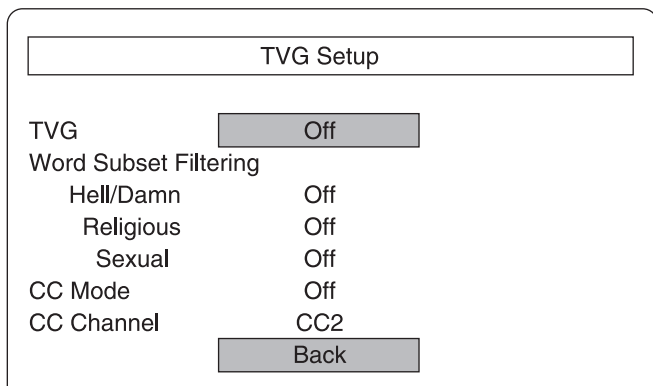

**Note:**

If you do not set "TVG", press [▼] to select "Back", and then press [ENTER]. "Parental" screen returns.

6. Press [ENTER]. The submenu appears.

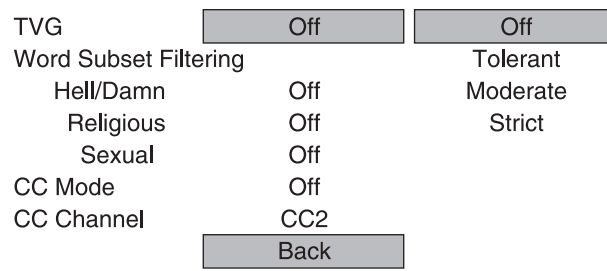

7. Press [▼] or [▲] to select the submenu.

**Off:**

TVG does not operate.

**Tolerant:**

Only the most offensive foul language will be filtered.

**Moderate:**

More offensive foul language will be filtered.

**Strict:**

All the foul language will be filtered.

8. Press [ENTER]. The submenu is set.

9. Press [▼] (or [▲]) to select the item ("Hell/Damn", "Religious" or "Sexual") of "Word Subset Filtering".

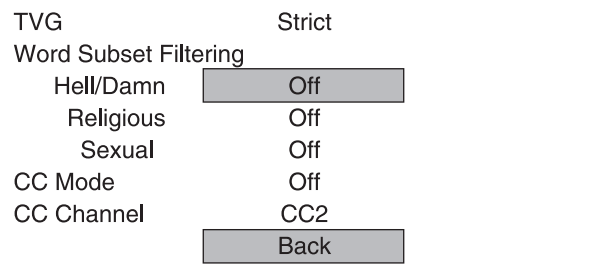

10. Press [ENTER]. The submenu ("Off" and "On") appears.

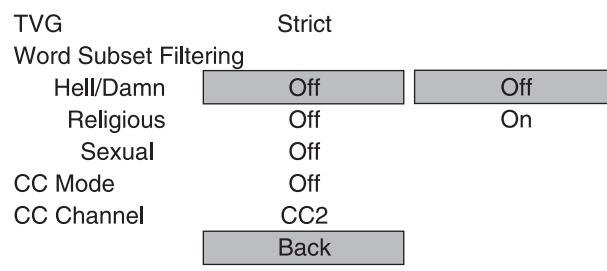



11. Press [▼] or [▲] to select "On" or "Off".
12. Press [ENTER].  
The submenu is set.
13. Repeat steps 9 ~ 12 to set other items.
14. Press [▼] to select "CC Mode" (Closed caption mode).
15. Press [ENTER].  
The submenu ("Off", "On Mute" and "Continuous") appears.

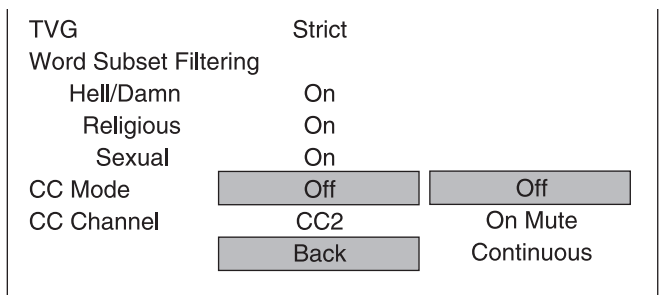

16. Press [▼] or [▲] to select the submenu.
  - Off:**  
No closed caption.
  - On Mute:**  
Display the modified text only.
  - Continuous:**  
Display all text with the modified text.

17. Press [ENTER].  
The submenu is set.
18. Press [▼] to skip "CC Channel CC2", and select "Back".

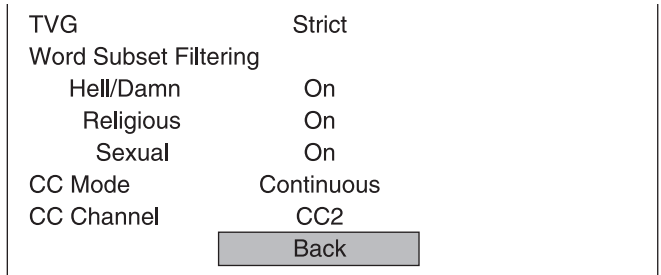

Note:  
Because, your TV is already set to "CC2" or "C2" in "Before Setting" (See page E29), this step can be skipped.  
If your TV is set to "CC1" or "C1", select "CC Channel" and then select the submenu "CC1" in step 18.

19. Press [ENTER].  
"Parental" screen returns.

20. **After step 19, you must set the parental lock as shown below.**  
(For more details, please refer to "Setting Parental" on page E37.)
  - 1) Press [▼] to select "Level".
  - 2) Press [ENTER] repeatedly to select the parental lock level.
  - 3) Press [▼] to select "Disc Lock".
  - 4) Press [ENTER]. The submenu ("On" and "Off") appears.
  - 5) Press [▼] or [▲] to select "On" or "Off".
  - 6) Press [ENTER]. The submenu is set.
  - 7) Press [▲] to select "Password".
  - 8) Press the number buttons to enter the 4 digits password.
  - 9) Press [ENTER].  
"🔒" appears.

**Note:**  
**If you do not set it, the TVGuardian does not work, and it returns to the initial settings.**

21. Press [SETUP].  
The setup screen disappears.

### How It Works After Setting TVGuardian®:

When a disc supporting closed caption is played, it mutes the entire phrase instead of just the swear word and displays the modified text, by design. It turns the sound back on when the phrase is completed.

Examples:  
The phrase "Get the hell out.", is muted and "Get Out.", is displayed.  
The phrase "Move you're a—!", is muted and "Move your tail!", is displayed.

**IMPORTANT INFORMATION:**

- Use a TV with closed caption capability and set the function to "On".
- Set the same closed caption channel number on both the unit and your TV.
- The built-in TVGuardian® Foul Language Filter (TVG®) works only English language DVD video disc supporting closed caption, not any other languages.
- **For improvement, on-screen displays subject to change without notice.**

- Notes:
- Foul word that are normally filtered are missed when closed-captioning errors exist (i.e. a foul word is not captioned, misspelled or is not synchronized with the spoken word.)
  - The built-in Foul Language Filter may not work on some discs depending on recording conditions.
  - DVD video discs may or may not respond to the TVG Mode settings. Make sure this function works with your DVD video discs.
  - When playback starts, the TVG information may appear on the TV screen.

TVGuardian® and TVG® are registered trademarks of Principle Solutions, Inc.



**Need help? Call**  
**1-800-813-3435**





# MP3/WMA CD OPERATION

## Before Starting

This unit can play back the CD that has recorded music data, MP3 or WMA (Window Media Audio) files.

- Select "DVD/CD" function.
- The file system is ISO9660 Level 1 and Level 2.
- If the CD has both audio CD tracks and MP3/WMA files, only MP3/WMA files are played.
- It would take 30 seconds or more for this unit to read MP3/WMA files depending on its structure.
- This unit can recognize up to 1500 files or folders per disc. The CD with 1501 files or folders and over is not available to this unit.
- MP3/WMA CDs may not be played in the recorded order.
  1. Please use the MP3 or WMA software with the function that can record data alphabetically or numerically.
  2. Please refrain from making many sub-folders by preference.

However, some MP3/WMA CDs cannot be played back depending on the recording conditions.

Before playing back MP3 or WMA files, please read the following.

### MP3 CD

- MP3 files must have the extension letters, ".MP3" or ".mp3".
- This unit can recognize MP3 files making compression way is MPEG-1, Layer 3 only.
- Standard, sampling frequency, and the bit rate:  
MPEG-1 Audio  
32kHz, 44.1kHz, 48kHz  
32kbps ~ 320kbps (constant bit rate or variable bit rate)
- The recommended recording setting for a high-quality sound is 44.1kHz of sampling frequency and 128kbps of constant bit rate.

### WMA CD

- WMA files must have the extension letters, ".WMA" or ".wma".
- Standard, sampling frequency, and the bit rate:  
WMA version 7, 8 and 9  
32kHz, 48kbps ~ 64kbps  
44.1kHz, 48kbps ~ 192kbps  
48kHz, 128kbps ~ 192kbps  
WMA9 Professional files, WMA9 Lossless files or DRM (copyright protection) files cannot be played back.
- When creating a WMA disc, be sure the copyright function is off.

Microsoft, Windows Media, and Windows Logo are trademarks or registered trademarks of Microsoft Corporation in both the United States and other countries.

### LIMITATIONS ON DISPLAY

- Available letters for display are the following: capital or small alphabets of A through Z, and numbers of 0 through 9.
- Other letters than those above are replaced in "-" (hyphen).

### CAUTION:

- Some MP3/WMA CDs cannot be played back depending on the recording conditions.
- The CD has no music data or non-MP3/WMA files cannot be played back.

#### Important Note:

"⊘" may appear on the TV screen during operation. This icon means that the function is not available on the disc now.

## MP3/WMA CD Playback

**Load the MP3/WMA CD.** (Please refer to page E22.)

Playback starts from the first file automatically, and a table of contents in the first directory appears on the TV screen.

Example:

File	1/24	00:00:08
HYPER-EURO-MAX		
1	MUSIC001	MUSIC006
2	MUSIC002	MUSIC007
3	MUSIC003	MUSIC008
4	MUSIC004	MUSIC009
5	MUSIC005	MUSIC010

File: MUSIC001

File information

- Press [II] to pause. Press [▶] (Play) to continue.
- Press [▶▶] or [◀◀], it skips to the next or previous file.

### Note:

If the disc is loaded with the label side downward, or if a badly scratched disc is loaded, "NO DISC" (or "NO PLAY") appears on the TV screen. If this occurs, load the disc correctly or replace the disc.

**To stop play**, press [■] **once** (for resuming play) or **twice** (for complete stop). (Please refer to page E23.)

**To start play from the desired file**, press [▲], [▶], [▼] or [◀] to select the file, then press [ENTER] or [▶] (Play) button.

**To repeat playback**, press [REPEAT] during playback.

Each time the button is pressed, the repeat mode will be changed as follows:

TV screen	Display	Operation
🔄 1	REP.1	Repeat of the file being played
🔄 All	ALL REP.	Repeat all files
🔄 Off		Repeat off mode

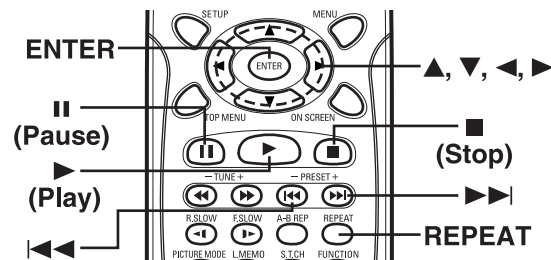

**Need help? Call**  
**1-800-813-3435**







# PICTURE DISC OPERATION

## Before Starting

You can view digital images from KODAK Picture/JPEG files.

- Select "DVD/CD" function.
- The file system is ISO9660 level 1 and level 2.
- If the CD has both audio CD tracks and JPEG files, only JPEG files are played.
- It would take 30 seconds or more for this unit to read JPEG files depending on its structure.
- This unit can recognize up to 1500 files or folders per disc.
- JPEG CDs may not be played in the recorded order.
- JPEG files must have the extension letters, ".JPG" or ".jpg".
- JPEG resolution is up to 5760 x 3840.
- Some discs cannot be played back depending on the recording conditions.

## KODAK Picture/JPEG CD Playback

With KODAK Picture CD, it is easy to turn film into pictures you can email from your PC and view on the unit.

Just bring your film in for processing, and check the box for KODAK Picture CD. You will get back your prints and negatives as usual - plus you will get a special CD that contains your pictures along with software that lets you view, enhance, share, and print your pictures from your PC and view them on the unit. You can also view digital images from JPEG files on disc created by your PC.

**Load the KODAK Picture or JPEG CD.** (Please refer to page E22.)

"PHOTO" appears on the display, and the slide show starts from the first file.

### During the slide show:

- Press [II] to pause. Press [▶] (Play) to continue.
- Press [▶▶] or [◀◀], it skips to the next or previous file.
- If the picture appears upside down or sideways, press [ANGLE] repeatedly while holding [SHIFT] down until it's right side up. "↶90°", "↷180°", "↷270°" or "Normal" appears briefly on the TV screen.

**To stop the slide show**, press [■] **once** (for resuming play) or **twice** (for complete stop). The file list appears.

- After the last picture has displayed, the file list appears.

Example: (KODAK Picture CD)

Picture CD		4/37	
PICTURES			
1	001-1A	6	006-6A
2	002-2A	7	007-7A
3	003-3A	8	008-8A
4	004-4A	9	009-9A
5	005-5A	10	010-10A

Example: (JPEG CD)

File		8/43	
Root			
1	001	6	006
2	002	7	007
3	003	8	008
4	004	9	009
5	005	10	010

### To start the slide show from the file list:

1. Press [▲], [▶], [▼] or [◀] to select the desired file.
2. Press [ENTER] or [▶] (Play) to start the slide show from the selected file.

**If [TOP MENU] is pressed during the slide show, the thumbnail pictures appear.**

Example:

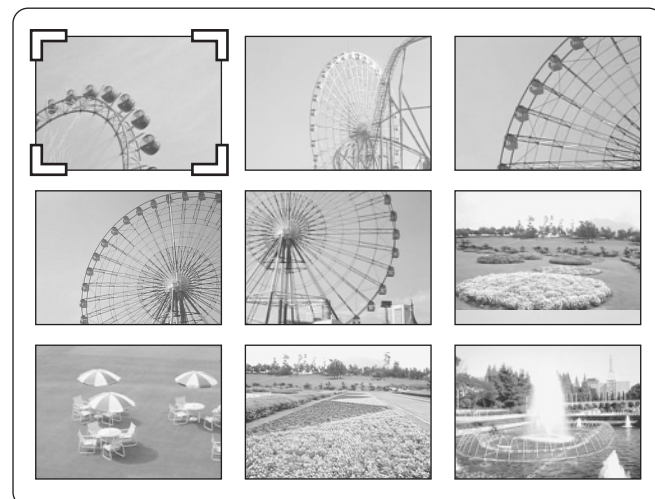

### To start the slide show from the thumbnail pictures:

1. Press [▲], [▶], [▼] or [◀] to select the desired picture.
  - To go to the next or previous thumbnail pictures, press [▶▶] or [◀◀].
2. Press [ENTER] or [▶] (Play) to start the slide show from the selected picture.

### Picture zoom

1. Press [II] at the desired picture (KODAK Picture and JPEG CD).
2. Press [ZOOM] repeatedly while holding [SHIFT] down. The picture is magnified. (Please refer to page E25.)
3. Press [▶] (Play) to resume the slide show.

Note:

FUJICOLOR CD can be used.

KODAK and Picture CD are registered trademarks of Eastman Kodak Company.

# INITIAL SETTINGS

Once the initial settings have been completed, the unit can always be operated under the same conditions. The settings will be retained in the memory until they are changed, even if the power is turned off.

**Notes:**

- In this instruction manual, the language in on-screen display is English. If you change the language, please follow the selected language in on-screen display.
- The disc information takes priority in various setting.
- For improvement, on-screen displays subject to change without notice.

## Setting Language

1. Press [SETUP] in the stop mode. The setup screen appears. "Language" is highlighted.
2. Press [ENTER]. "Language" screen appears.
3. Press [▼] or [▲] to select the item (highlighted). Example:

Language	Display	Audio	Parental
OSD		English	
Audio		Disc	
Subtitle		Disc	
DVD Menu		Disc	

4. Press [ENTER]. The submenu appears. Example:

Language	Display	Audio	Parental
OSD		English	English
Audio		Disc	Español
Subtitle		Disc	Français
DVD Menu		Disc	Deutsch
			Portugues

5. Press [▼] or [▲] to select the language (highlighted).
6. Press [ENTER]. The selected language remains.
7. Repeat steps 3 ~ 6 for other items. Note: If "Others" is selected, enter the language code. (See "Language Code List" on page E38.)
8. Press [▲] to skip back to the setup screen (or press [SETUP]).

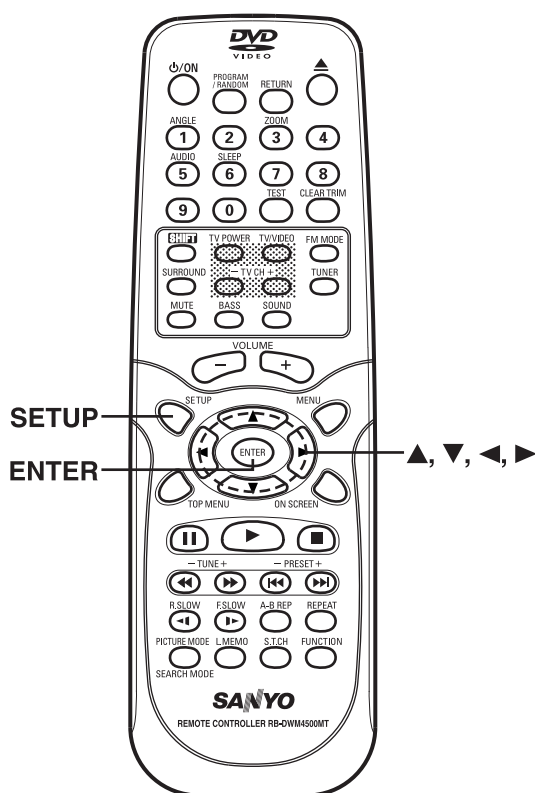



**Need help? Call  
1-800-813-3435**

## Setting Display

1. Press [SETUP] in the stop mode.  
The setup screen appears.
2. Press [▶] to select "Display".
3. Press [ENTER].  
"Display" screen appears.  
"TV System NTSC" is highlighted.

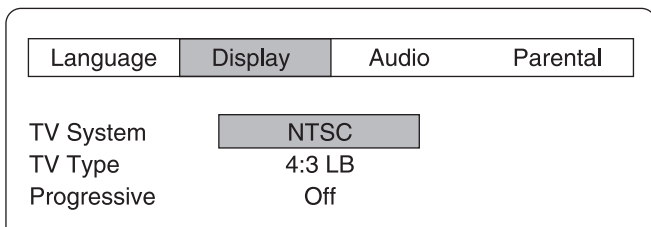

4. Press [▼] to skip "TV System NTSC".

Note:

Because, "NTSC" is used for TV System in North America. It is not necessary to change TV System. Skip "TV System NTSC".

If necessary, you can select the appropriate setting for the connected TV system.

- 1) In "Display" screen, press [▼] or [▲] to select "TV System", then press [ENTER]. The submenu appears.

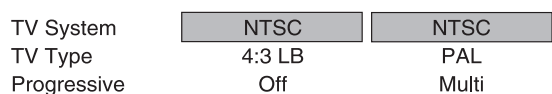

- 2) Press [▼] or [▲] to select the appropriate TV system.

NTSC: For NTSC TV

PAL: For PAL TV

Multi: For Multi TV

Example: To set "Multi"

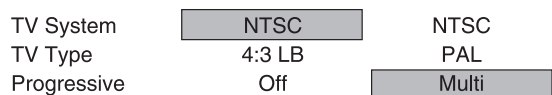

- 3) Press [ENTER].

"Changing TV System" screen appears.

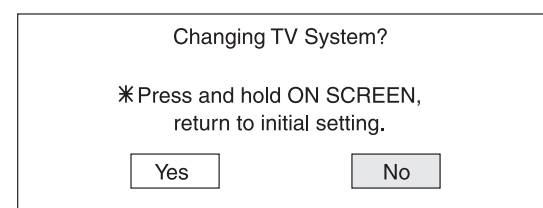

- 4) Press [◀] to select "Yes", and then press [ENTER].

In this example, "TV System Multi" is set.

Note:

- If you do not want it, select "No", then press [ENTER].
- If the selected TV system and the playback disc's color system (NTSC/PAL) differ, the video and audio may not be played back smoothly.

### If you accidentally change the TV System...

Press and hold [ON SCREEN] down for at least 5 seconds in no disc mode. It returns to "TV System: NTSC" and "Progressive: Off".

5. **Setting TV type**

Select the playback picture size according to the aspect ratio of the TV.

- 1) In "Display" screen, press [▼] or [▲] to select "TV Type".

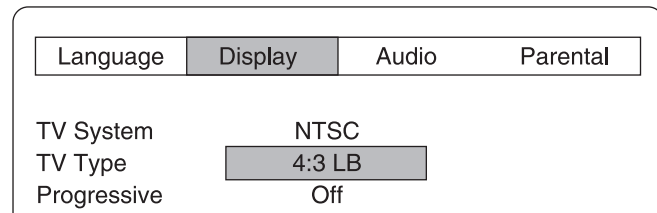

- 2) Press [ENTER]. The submenu appears.

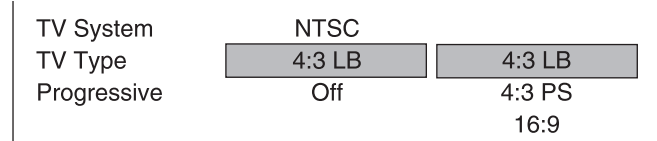

- 3) Press [▼] or [▲] to select the appropriate TV type (4:3 LB, 4:3 PS or 16:9).

- 4) Press [ENTER].

Example: "TV Type 4:3 PS" is set.

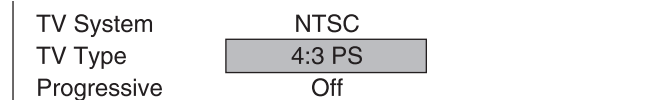

- 5) Press [▲] to skip back to the setup screen or press [SETUP] to quit the setup screen.

### 4:3 LB (Letterbox):

Select when a conventional TV set is connected.

When the wide screen disc is played back, the black bands appear at the top and bottom of screen.



### 4:3 PS (Panscan):

Select when a conventional TV set is connected.

When the wide screen disc is played back, it displays pictures cropped to fill to your TV screen. The left and right edges are cut off.

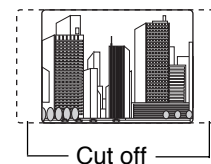

### 16:9 :

Select when a wide screen TV set is connected.

Played in "FULL" size. (Setting the wide screen TV to "FULL" mode is also necessary.)

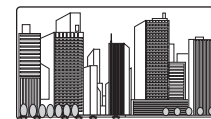

Notes:

- The screen size may differ depending on the DVD video discs.
- If you select 16:9 to get rid of the black bands on screen when wide screen disc is played back, picture may be slightly distorted.
- In some discs, even if 4:3 PS is selected, the black bands may remain on the screen.

## 6. Setting progressive mode

1) In "Display" screen, press [▼] to select "Progressive".

Language	Display	Audio	Parental
TV System	NTSC		
TV Type	4:3 PS		
Progressive	Off		

2) Press [ENTER]. The submenu appears.

Language	Display	Audio	Parental
TV System	NTSC		
TV Type	4:3 PS		
Progressive	Off	Off	On

**Note:**

**If "Progressive" is not selected...**

First, press [⏻/ON] to turn the power off.  
Then, confirm that the VIDEO OUT SELECT switch is set to the COMPONENT position. (See page E15.)  
Next, press [⏻/ON] again to turn the power on, and press [SETUP] to open the setup screen.

2) Press [▼] or [▲] to select the progressive mode ("On" or "Off").

3) Press [ENTER]. The submenu is set.

4) Press [▲] to skip back to the setup screen or press [SETUP] to quit the setup screen.

**Note:**

**To reset to the initial setting "TV System: NTSC" and "Progressive: Off"...**

In the no disc mode, press [ON SCREEN] for at least 5 seconds even if "⊙" appears.

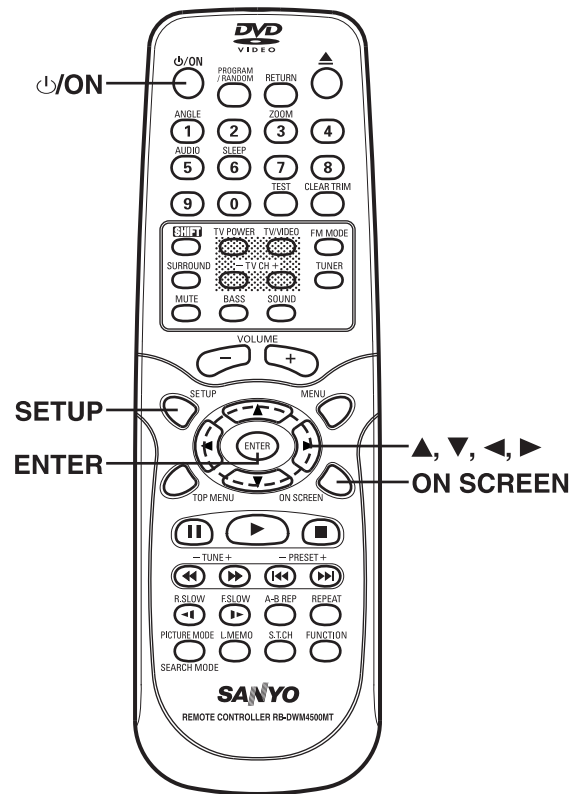

ON/OFF

SETUP

ENTER

▲, ▼, ◀, ▶  
ON SCREEN



**Need help? Call  
1-800-813-3435**



## Setting Audio

The sound from speakers can reach the listening position at different times depending the speaker placements. You can allow for this difference by changing the delay time of the center and surround speakers.

You also can change the Dynamic Range Control (DRC).

1. Press [SETUP] in the stop mode.  
The setup screen appears.

2. Press [▶] to select "Audio".

3. Press [ENTER].  
"Audio" screen appears.

Audio DRC	Off
Center Delay	0ms
Surr Delay	5ms

4. Press [ENTER] to select "Audio DRC".  
The submenu ("On" and "Off") appears.
5. Press [▼] or [▲] to select "On" or "Off" as desired.  
On: It will compress the dynamic range. It may have no effect with some discs.  
Off: Sound with a wide dynamic range.
6. Press [ENTER].  
"Audio DRC On" or "Audio DRC Off" remains.
7. Press [▼] to select "Center Delay".
8. Press [ENTER].  
The submenu ("0ms", "1ms", "2ms", "3ms", "4ms" and "5ms") appears.
9. Press [▼] or [▲] to select the center speaker delay time.

### Center speaker delay time

If  $D1 \leq D2$ , set the delay time to "0ms".

If  $D1 > D2$ , set the delay time as follows:

Difference between D1 and D2	Delay time
1 foot (Approx. 30cm)	1ms
2 feet (Approx. 60cm)	2ms
3 feet (Approx. 90cm)	3ms
4 feet (Approx. 120cm)	4ms
5 feet (Approx. 150cm)	5ms

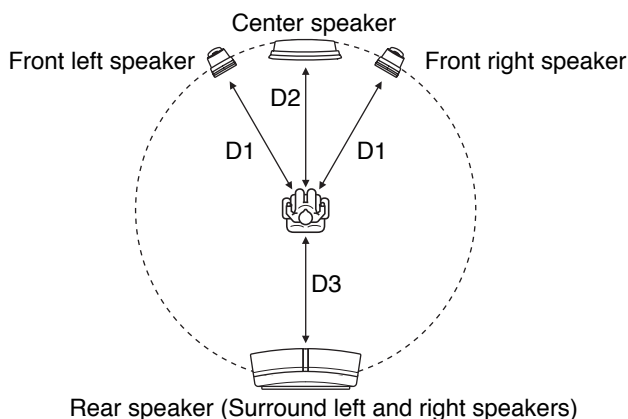

D1: The distance from the front speaker  
 D2: The distance from the center speaker  
 D3: The distance from the rear speaker

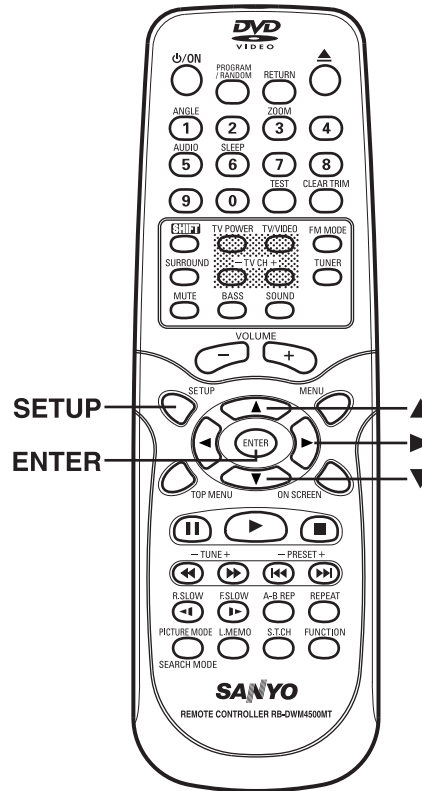

10. Press [ENTER].  
"Center Delay" and the selected delay time remain.
11. Press [▼] to select "Surr Delay".
12. Press [ENTER].  
The submenu ("0ms", "5ms", "10ms" and "15ms") appears.
13. Press [▼] or [▲] to select the rear speaker (surround left and right speakers) delay time.

### Rear speaker (Surround left and right speakers) delay time

If  $D1 \leq D3$ , set the delay time to "0ms".

If  $D1 > D3$ , set the delay time as follows:

Difference between D1 and D3	Delay time
5 feet (Approx. 150cm)	5ms
10 feet (Approx. 300cm)	10ms
15 feet (Approx. 450cm)	15ms

14. Press [ENTER].  
"Surr Delay" and the selected delay time remain.
15. Press [▲] to skip back to the setup screen (or press [SETUP]).



**Need help? Call**  
**1-800-813-3435**



## Setting Parental

### Note:

If you set "TVGuardian", set it first.  
See "Setting TVGuardian®" on page E29.

1. Press [SETUP] in the stop mode.  
The setup screen appears.
2. Press [▶] to select "Parental".
3. Press [ENTER].  
"Parental" screen appears.

Language	Display	Audio	Parental
Password	----		
Level	8		
Disc Lock	Off		
TVGuardian			

### Setting "Level"

- 1) Press [▼] to skip "Password ----" and select "Level".
- 2) Press [ENTER] repeatedly to select the parental lock level ("Level 1" ~ "Level 8").  
Example: To select "Level 1"

Password	----	
Level	1	
Disc Lock	Off	
TVGuardian		

### Setting "Disc Lock"

- 1) Press [▼] to select "Disc Lock".
- 2) Press [ENTER]. The submenu ("On" and "Off") appears.

Password	----	
Level	1	
Disc Lock	Off	On
TVGuardian		

- 3) Press [▼] or [▲] to select "On" or "Off".
  - 4) Press [ENTER].
4. Press [▲] to select "Password".
  5. Press the number buttons to enter the 4 digits password.

Password	****	
Level	1	
Disc Lock	Off	
TVGuardian		

### Note:

If you make a mistake, press [CLEAR].

6. Press [ENTER].  
The password is now set.

Password	----	
Level	1	
Disc Lock	Off	
TVGuardian		

### Note:

If you do not set it, Parental Control does not work, and it returns to the initial settings.

7. Press [SETUP].  
The setup screen disappears.

### Parental Control

MPAA (Motion Picture Association of America) Guideline is a rating system that provides advanced cautionary information to parent about the content of movie programs.

The parental lock level is equivalent to the following MPAA Rating System.

- Level 8: Adult
- Level 7: NC-17 (No one 17 and under admitted)
- Level 6: R (Restricted)
- Level 4: PG-13 (Parents strongly cautioned)
- Level 3: PG (Parental guidance suggested)
- Level 1: G (General audiences)

Some DVD discs contain a restriction level which enables parents to prevent playback of discs by children. This unit is equipped with a password designed to prevent children changing the level.

You cannot play DVD video discs rated higher than the level you selected unless you cancel the parental lock function.

For example, when you select level "5", the unit will not play discs with ratings of "6", "7" or "8".  
The information will appear on the TV screen.

### Note:

DVD video discs may or may not respond to the parental lock settings. Make sure this function works with your DVD video discs.

### To Lock the Disc Door

First, select "Disc Lock On".

You can lock the disc door to prevent misuse of young children. While the disc door is opened, press the ▲ button (**main unit**) until "LOCKED" appears on the display.

- The ▲ button will not function.

To release this mode, press the ▲ button until "UNLOCKED" appears.

### If you forget the password...

Enter "788444" even if 4 digits "----" appears, then press [ENTER] to clear the current password.

Enter a new password and set the parental lock level again.



**Need help? Call**  
**1-800-813-3435**



## Language Code List

Enter the appropriate code number for the initial settings "Audio", "Subtitle" and "DVD Menu" on page E33.

Code	Abbreviation of the language	Language	Code	Abbreviation of the language	Language	Code	Abbreviation of the language	Language
6565	aa	Afar	7369	ie	Interlingue	8278	rn	Kirundi
6566	ab	Abkhazian	7375	ik	Inupiak	8279	ro	Romanian
6570	af	Afrikaans	7378	in	Indonesian	8285	ru	Russian
6577	am	Amharic	7383	is	Icelandic	8287	rw	Kinyarwanda
6582	ar	Arabic	7384	it	Italian	8365	sa	Sanskrit
6583	as	Assamese	7387	iw	Hebrew	8368	sd	Sindhi
6589	ay	Aymara	7465	ja	Japanese	8371	sg	Sangro
6590	az	Azerbaijani	7473	ji	Yiddish	8372	sh	Serbo-Croatian
6665	ba	Bashkir	7487	jw	Javanese	8373	si	Singhalese
6669	be	Byelorussian	7565	ka	Georgian	8375	sk	Slovak
6671	bg	Bulgarian	7575	kk	Kazakh	8376	sl	Slovenian
6672	bh	Bihari	7576	kl	Greenlandic	8377	sm	Samoan
6673	bi	Bislama	7577	km	Cambodian	8378	sn	Shona
6678	bn	Bengali; Bangla	7578	kn	Kannada	8379	so	Somali
6679	bo	Tibetan	7579	ko	Korean	8381	sq	Albanian
6682	br	Breton	7583	ks	Kashmiri	8382	sr	Serbian
6765	ca	Catalan	7585	ku	Kurdish	8383	ss	Siswati
6779	co	Corsican	7589	ky	Kirghiz	8384	st	Sesotho
6783	cs	Czech	7665	la	Latin	8385	su	Sundanese
6789	cy	Welsh	7678	ln	Lingala	8386	sv	Swedish
6865	da	Danish	7679	lo	Laothian	8387	sw	Swahili
6869	de	German	7684	lt	Lithuanian	8465	ta	Tamil
6890	dz	Bhutani	7686	lv	Latvian, Lettish	8469	te	Telugu
6976	el	Greek	7771	mg	Malagasy	8471	tg	Tajik
6978	en	English	7773	mi	Maori	8472	th	Thai
6979	eo	Esperanto	7775	mk	Macedonian	8473	ti	Tigrinya
6983	es	Spanish	7776	ml	Malayalam	8475	tk	Turkmen
6984	et	Estonian	7778	mn	Mongolian	8476	tl	Tagalog
6985	eu	Basque	7779	mo	Moldavian	8478	tn	Setswana
7065	fa	Persian	7782	mr	Marathi	8479	to	Tonga
7073	fi	Finnish	7783	ms	Malay	8482	tr	Turkish
7074	fj	Fiji	7784	mt	Maltese	8483	ts	Tsonga
7079	fo	Faeroese	7789	my	Burmese	8484	tt	Tatar
7082	fr	French	7865	na	Nauru	8487	tw	Twi
7089	fy	Frisian	7869	ne	Nepali	8575	uk	Ukrainian
7165	ga	Irish	7876	nl	Dutch	8582	ur	Urdu
7168	gd	Scots Gaelic	7879	no	Norwegian	8590	uz	Uzbek
7176	gl	Galician	7967	oc	Occitan	8673	vi	Vietnamese
7178	gn	Guarani	7977	om	(Afan) Oromo	8679	vo	Volapük
7185	gu	Gujarati	7982	or	Oriya	8779	wo	Wolof
7265	ha	Hausa	8065	pa	Punjabi	8872	xh	Xhosa
7273	hi	Hindi	8076	pl	Polish	8979	yo	Yoruba
7282	hr	Croatian	8083	ps	Pashto, Pushto	9072	zh	Chinese
7285	hu	Hungarian	8084	pt	Portuguese	9085	zu	Zulu
7289	hy	Armenian	8185	qu	Quechua			
7365	ia	Interlingua	8277	rm	Rhaeto-Romance			

# LISTENING TO THE RADIO (FM ONLY)

To turn the unit on and listen to the last received station, press [TUNER] on the remote control.

## Preparation

Press [FUNCTION] to select "FM TUNER".  
Note: This unit doesn't have "AM TUNER".

## Automatic/Manual Tuning

### Automatic tuning

Press [TUNE] + or - for at least 1 second to tune in a station. The unit will scan up or down the band and receive the next receivable station. Press the button again to continue.

### Manual tuning

Press [TUNE] + or - briefly until the desired frequency is displayed. The frequency changes in 200 kHz steps for FM.

Example:

103.1 MHz

## To Preset Stations

Up to 24 FM stations can be preset.

### Automatic presetting (APT)

Press [PROGRAM/RANDOM] for at least 3 seconds. "PROG." blinks.

The automatic tuning mode is set and automatic presetting begins from the low end of the band.

When 24 FM stations have been preset or the high end of the band is reached, automatic presetting stops. "PROG." disappears and the station memorized on the preset number 1 will be heard.

Note:

If APT is activated, all previously programmed stations of the band will be cleared and new stations will be programmed.

### Manual presetting

1. Tune in the station to be preset as described in "Automatic/Manual Tuning".

2. Press [PROGRAM/RANDOM]. "PROG." blinks.

103.1 

3. While "PROG." is blinking, press [PRESET] + or - to select the number to be preset.

- The number buttons on the remote control can also be used.
- In this example, the preset number is "9".

103.1 

4. While it is blinking, press [PROGRAM/RANDOM].

- In this example, "103.1 MHz" FM station is preset on the preset number 9.

103.1 



103.1 9

5. Repeat steps above to add more preset stations.

- When presetting a new station, the previous preset station is cleared.

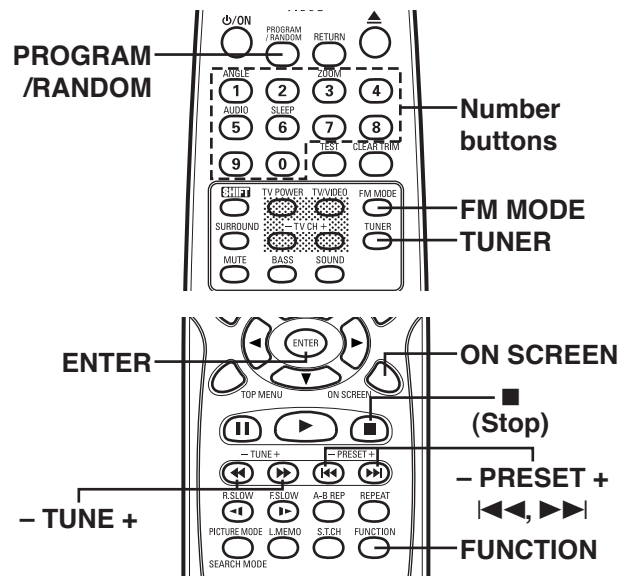

## Listening to Preset Stations

### Preset tuning

Press [PRESET] + or - briefly to select the desired channel.

- If using the number buttons, press the number button(s), then press [ENTER].

### Preset scan tuning

- Press [PRESET] + or - for at least 1 second.
  - The preset number appears.
  - The preset stations are selected in sequence for approximately five seconds each.
- Press  when the desired station has been selected. Preset scanning will stop.

### To receive FM stereo broadcasts

Make sure that "MONO" is not displayed. If "MONO" appears, press [FM MODE] to turn the "MONO" indication off.

You can enjoy FM stereo sound when an FM stereo broadcast is received.

- If the signal from an FM stereo station is weak and reception is poor, press [FM MODE] to change to monaural (MONO) reception. The reception may be improved, but the sound will be monaural.

### When beat interference is heard

A high-pitched noise called "beat" is sometimes heard during reception of radio broadcasts.

If this occurs, while holding [ON SCREEN] down on the remote control, press  on the main unit to select "bc-A" or "bc-B". Select the setting that gives the best results.

### Changing the reception frequencies

If necessary, use the following procedure to change the reception frequencies.

While holding [ON SCREEN] down on the remote control, press  on the main unit.

To return the original setting, repeat steps above.

87.9 ~ 107.9 MHz  87.5 ~ 108.0 MHz  
(200 kHz steps) (50 kHz steps)





## ENJOYING OTHER SOURCES

1. Press [FUNCTION] to select "AUX".
2. Follow the instructions supplied with TV or other compatible/video component.

## SLEEP TIMER OPERATION

The sleep timer automatically switches off the power after a preset time has elapsed. The volume will gradually be reduced (fade-out) during the 1 minute period before the unit turns off. There are 4 time periods available: 30, 60, 90, and 120 minutes.

Press [SLEEP] repeatedly while holding [SHIFT] down to select the desired sleep time. "SLEEP" appears, and the selected time blinks on the display.

After several seconds, the original display returns and the brightness of the display reduces. "SLEEP" blinks on the display.

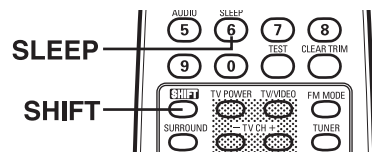

### To check the remaining sleep time

Press [SLEEP] **once** while holding [SHIFT] down. The remaining time is displayed.

After several seconds, the original display returns.

### To release the sleep timer while in operation

Press [SLEEP] repeatedly while holding [SHIFT] down until "SLEEP" disappears.

The timer is also released if the power is switched off.



**Need help? Call**  
**1-800-813-3435**

## MAINTENANCE

### WARNING:

FOR YOUR PERSONAL SAFETY, BE SURE TO DISCONNECT THE AC POWER CORD BEFORE PROCEEDING WITH ANY MAINTENANCE OR CLEANING.

### Cleaning the cabinet

Use a clean soft cloth moistened with plain lukewarm water and wrung dry. Never use benzol, benzene or other strong chemical cleaners since these could damage the finish of your unit. It is important that no liquid reaches the inside of the unit.

### Cleaning the DVD player lens

The lens should never be touched. If dust is on the lens, blow it off using a camera lens blower. (Please consult your dealer.)

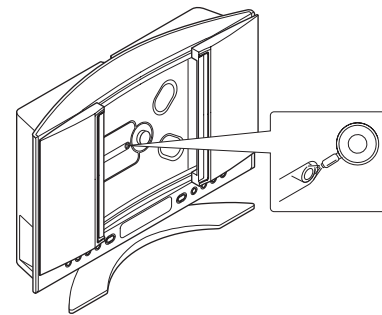

## TROUBLESHOOTING GUIDE

If you have followed the instructions and are having difficulty operating the unit, locate the SYMPTOM in the left column below. Check the corresponding POSSIBLE CAUSE and CORRECTIVE ACTION columns to locate and remedy the problem.

SYMPTOM	POSSIBLE CAUSE	CORRECTIVE ACTION
No power.	No power plug connection at the AC wall outlet.	Insert the power plug into the AC wall outlet.
	The system cable is not connected.	Connect the system cable. (See page E8.)
The power is on, but the player does not work.	No disc is loaded.	Load a disc.
No picture.	An unplayable disc is loaded.	Load a playable disc. (Check the disc logo, type, color system and region number.) (See page E20.)
	The TV is not set to receive signal from the unit.	Select the correct input function on the TV.
	The video cable is not connected.	Connect the video cable into the jack.
	"PROGRESSIVE" mode is set.	Select "INTERLACE" mode. (See page E21.)



SYMPTOM	POSSIBLE CAUSE	CORRECTIVE ACTION
No sound.	Volume control is set to minimum.	Turn up the volume.
	The wrong function is selected.	Select the correct function.
	Faulty speaker connections.	Connect the speaker wires firmly to the speaker terminals. (See page E10.)
	DTS disc is played back.	Press the ON SCREEN button to see if "DTS sound" is not selected. If "DTS sound" is selected, change the sound. (See page E28.)
Sound is heard from only one speaker.	Faulty connection of speaker wires.	Connect the speaker wires firmly to the speaker terminals. (See page E10.)
No sound from the rear speaker.	The power (⏻/ON) switch is not on.	Press the power (⏻/ON) switch. (See page E17.)
	The FREQUENCY switch position doesn't match.	Match the FREQUENCY switch position on both sub-woofer and rear speaker. (See page E12.)
Noise is heard from the rear speaker.	It is electronic jamming.	Change the FREQUENCY switch position on both sub-woofer and rear speaker. (See page E12.)
		Use the assistant speaker cable. (See page E12.)
The playback picture is poor.	An unplayable disc is loaded.	Load a playable disc. (Check the disc logo, type, color system, and region number.) (See page E20.)
Part of On-Screen-Display is cut off.	Incorrect aspect ratio setup on TV.	Refer to the instruction manual of your TV.
"⊘" appears on the TV screen.	The selected function does not operate on the disc now.	The feature or action cannot be completed at this time because: <ul style="list-style-type: none"> <li>• The feature is not available at the moment.</li> <li>• The DVD software restricts it.</li> <li>• The DVD software doesn't support the feature (e.g., angles).</li> </ul>
The unit does not start playback. ("NO DISC" (or "NO PLAY") appears.)	No disc is loaded.	Load a disc.
	An unplayable disc is loaded.	Load a playable disc. (Check the disc logo, type, color system, and region number.) (See page E20.)
	The disc is not loaded correctly.	Load the disc with the label facing toward you.
	The disc is dirty.	Clean the disc or replace it.
	"Parental" is set.	Cancel the parental lock function or change the rating level. Reset it after play. (See page E37.)
The TV screen is not steadied.	The Screen Saver is set.	This is not a malfunction. The unit is automatically set to the Screen Saver mode after approximately 5 minutes have elapsed under the stop or pause mode. Press the ► (Play) button to cancel it.
All files (MP3, WMA, KODAK Picture CD or JPEG CD) do not appear.	The disc has more than 1500 files or folders.	The unit can recognize up to 1500 files or folders per disc. (See pages E31 and E32.)
FM stereo broadcast is hard to hear due to much noise.	Weak signal.	Press the FM MODE button on the remote control to display "MONO". (See page E39.)
		Reorient the FM antenna lead wire or install an outdoor FM antenna. (See page E16.)
The remote control does not work properly.	The batteries in the remote control are weak, or installed incorrectly.	Check the battery polarity (+ or -). Replace the batteries. (See page E7.)
	The remote control is not aimed at the remote sensor window.	Aim the remote control at the remote sensor window. (See page E7.)

**SERVICING:**

Should this product require service, refer to the SANYO AUDIO/VIDEO limited warranty.

If you do not have a convenient SANYO service station nearby, contact the SANYO dealer where you purchased the unit. Be sure to give the model number and explain the problem. The dealer will advise you how to obtain service.



# SPECIFICATIONS

## DVD Receiver (DWM-4500)

### DVD Video Player

Signal format: NTSC color  
Laser: Semiconductor laser, wavelength 650/790 nm  
Wow and flutter: Below measurable level

### FM Tuner

Frequency range: 87.9 MHz ~ 107.9 MHz (200 kHz steps)  
Usable sensitivity: 20.2 dBf (mono)

### Inputs/Outputs

SYSTEM: System cable terminal  
FM ANT.: FM antenna terminal  
PHONES: Stereo headphones jack

### General

Dimensions (W x H x D):  
Approx. 11.9" x 8.5" x 5.3" (302 x 215 x 134 mm)  
Weight: Approx. 4.7 lbs (1.7 kg)

### Sub-woofer

#### (Powered Speaker, ASX-DWM-4500W)

##### Amplifier

##### Front Amplifier

**Continuous minimum sine wave RMS power output per channel into 4 ohms at 1kHz with no more than 10% total harmonic distortion (with Center/Sub-woofer amplifier off) ..... 100 Watts**

##### Center Amplifier

**Continuous minimum sine wave RMS power output into 4 ohms at 1kHz with no more than 10% total harmonic distortion (with Front/Sub-woofer amplifier off) ..... 100 Watts**

##### Sub-woofer Amplifier

**Continuous minimum sine wave RMS power output into 4 ohms at 100Hz with no more than 10% total harmonic distortion (with Front/Center amplifier off) ..... 100 Watts**

### Inputs/Outputs

SYSTEM: System cable terminal  
AUX (L/R): 1 V/47 kΩ  
S-VIDEO OUT:  
Y: 1.0 Vp-p (75 Ω)                      C: 0.286 Vp-p (75 Ω)  
VIDEO OUT: 1.0 Vp-p (75 Ω)  
COMPONENT VIDEO OUT:  
Y: 1.0 Vp-p (75 Ω)                      P<sub>B</sub>, P<sub>R</sub>: 0.7 Vp-p (75 Ω)  
SPEAKERS:  
FRONT (L/R): 4 Ω                      CENTER: 4 Ω  
REAR OUT: Assistant speaker cable output jack

### Transmitter

Built-in type, 914.1 MHz ~ 915.3 MHz, 4ch selectable

### Subwoofer

Unit used (non-magnetic shield):  
5.1" (13 cm) diameter, Cone type  
Maximum power handling capacity: 110 W (peak)  
Nominal impedance: 4 Ω

### General

Power requirements: AC 120 V, 60 Hz  
Power consumption: 76 W  
Dimensions (W x H x D):  
Approx. 6.1" x 1.8" x 16" (154 x 415 x 407 mm)  
Weight: Approx. 20.5 lbs (9.3 kg)

### Front Speaker (DWM-4500S)

Unit used (magnetic shield):  
3.1" (8 cm) diameter, Cone type, Full range  
Maximum power handling capacity: 100 W (peak)  
Nominal impedance: 4 Ω  
Dimensions (W x H x D):  
Approx. 3.8" x 8.5" x 3.7" (96 x 216 x 95 mm)  
Weight: Approx. 2.9 lbs (1.3 kg) (per speaker)

### Center Speaker (DWM-4500C)

Unit used (magnetic shield):  
3.1" (8 cm) diameter, Cone type x 2  
1" (2.5 cm) diameter, Tweeter x 1  
Maximum power handling capacity: 100 W (peak)  
Nominal impedance: 4 Ω  
Dimensions (W x H x D):  
Approx. 10.7" X 3.9" X 3.1" (272 X 98 X 78 mm)  
Weight: Approx. 2.9 lbs (1.3 kg)

### Rear Speaker

#### (Powered Speaker, ASX-DWM-4500R)

##### Amplifier

##### Surround Amplifier

**Continuous minimum sine wave RMS power output per channel into 4 ohms at 1kHz with no more than 10% total harmonic distortion ..... 50 Watts**

Unit used (non-magnetic shield):  
3.1" (8 cm) diameter, Cone type x 2  
Maximum power handling capacity: 60 W (peak)  
Nominal impedance: 4 Ω

### Input/Output

REAR IN: Assistant speaker cable input jack  
EXTERNAL SPEAKERS (L/R): 4 Ω

### Receiver

Built-in type, 914.1 MHz ~ 915.3 MHz, 4ch selectable

### General

Power requirements: AC 120 V, 60 Hz  
Power consumption: 30 W  
Dimensions (W x H x D):  
Approx. 18.9" x 4.7" x 7.6" (480 x 120 x 193 mm)  
Weight: Approx. 10.6 lbs (4.8 kg)

### IMPORTANT INFORMATION

Because its products are subject to continuous improvement, Sanyo reserves the right to modify product designs and specifications without notice and without incurring any obligation.





For assistance in obtaining repairs and operational information, please contact the following Toll Free Number:

**DIAL TOLL FREE: 1-800-813-3435**

**Weekdays: 7:30 AM - 4:00 PM Central Time**

Also, you may write to SANYO Manufacturing Corporation, 3333 Sanyo Road, Forrest City, Arkansas 72335.

## Limited Warranty

**LABOR 1 YEAR**

**PARTS 1 YEAR**

**CARRY-IN ONLY**

THIS WARRANTY IS VALID ONLY ON SANYO PRODUCTS PURCHASED FROM A WAL-MART STORE AND USED IN THE UNITED STATES OF AMERICA, EXCLUDING HAWAII AND ALL U.S. TERRITORIES AND PROTECTORATES. THIS WARRANTY APPLIES ONLY TO THE ORIGINAL RETAIL PURCHASER AND DOES NOT APPLY TO PRODUCTS USED FOR ANY INDUSTRIAL, PROFESSIONAL OR COMMERCIAL PURPOSE.

Subject to the OBLIGATIONS and EXCLUSIONS below, SANYO Manufacturing Corporation ("SANYO") warrants this SANYO product against defects in materials and workmanship for the periods of LABOR and PARTS specified above. SANYO will repair or replace (at its option) the product and any of its parts which fail to conform to this warranty with new or refurbished products or parts. The warranty period commences on the date the product was first purchased at retail from a Wal-Mart Store.

### OBLIGATIONS

In order to obtain warranty service, the product must be delivered to and picked up from a Wal-Mart Store at the original retail purchaser's expense. The original dated bill of sale, or sales slip from a Wal-Mart Store must be submitted to a Wal-Mart Store at the time warranty service is requested.

### EXCLUSIONS

1. This warranty does not cover (A) the adjustment of customer-operated controls as explained in the appropriate model's instruction manual, or (B) the repair of any product whose serial number has been altered, defaced or removed.
2. This warranty shall not apply to the cabinet or cosmetic parts, broken or damaged video heads, batteries or routine maintenance.
3. This warranty does not apply to uncrating, setup, installation, removal of the product for repair or reinstallation of the product after repair.
4. This warranty does not apply to repairs or replacements necessitated by any cause beyond the control of SANYO including, but not limited to, any malfunction, defect or failure caused by or resulting from unauthorized service or parts, improper maintenance, operation contrary to furnished instructions, shipping or transit accidents, modification or repair by user or any third party, abuse, misuse, neglect, accident, incorrect line voltage, fire, flood or other Acts of God, or normal wear and tear.

The foregoing is in lieu of all other express warranties and SANYO does not assume or authorize any party to assume for it any other obligation or liability.

THE DURATION OF ANY WARRANTIES WHICH MAY BE IMPLIED BY LAW (INCLUDING THE WARRANTIES OF MERCHANTABILITY AND FITNESS) IS LIMITED TO THE TERM OF THIS WARRANTY. IN NO EVENT SHALL SANYO OR THE MANUFACTURER OF THE PRODUCT BE LIABLE FOR SPECIAL, INCIDENTAL OR CONSEQUENTIAL DAMAGES ARISING FROM OWNERSHIP OR USE OF THIS PRODUCT, OR FOR ANY DELAY IN THE PERFORMANCE OF ITS OBLIGATIONS UNDER THIS WARRANTY DUE TO CAUSES BEYOND ITS CONTROL.

SOME STATES DO NOT ALLOW LIMITATIONS ON HOW LONG AN IMPLIED WARRANTY LASTS AND/OR DO NOT ALLOW THE EXCLUSION OR LIMITATION OF CONSEQUENTIAL DAMAGES, SO THE ABOVE LIMITATIONS AND EXCLUSIONS MAY NOT APPLY TO YOU.

THIS WARRANTY GIVES YOU SPECIAL LEGAL RIGHTS. YOU MAY HAVE OTHER RIGHTS, WHICH VARY FROM STATE TO STATE. R03/12/18 (M)

For your protection in the event of theft or loss of this product, please keep the following information with a sales receipt in a safe place.

**Model No.** \_\_\_\_\_ **Serial No.** \_\_\_\_\_ **Date of Purchase** \_\_\_\_\_

**Purchase Price** \_\_\_\_\_ **Where Purchased** \_\_\_\_\_

**SANYO**

SANYO Manufacturing Corporation

**SANYO**

**SANYO Electric Co., Ltd.**  
Printed in China

