

Wireless test report – 345842-3TRFWL

Applicant:

LEGO System A/S

Product name:

Bluetooth Low Energy Transceiver

Model:

HUB NO.4

FCC ID:

NPI 28738

ISED Registration number:

3072A-28738

Specifications:

◆ **FCC 47 CFR Part 15 Subpart C, §15.247**

Operation in the 902–928 MHz, 2400–2483.5 MHz, and 5725–5850 MHz

◆ **RSS-247, Issue 2, Feb 2017, Section 5**

Digital Transmission Systems (DTSs), Frequency Hopping Systems (FHSs)
and Licence-Exempt Local Area Network (LE-LAN) Devices

5) Standard specifications for frequency hopping systems and digital transmission systems operating in the
bands 902–928 MHz, 2400–2483.5 MHz and 5725–5850 MHz

Date of issue: **August 24, 2018**

Test engineer(s): **Andrey Adelberg, Senior Wireless/EMC Specialist**

Signature:



Reviewed by: **Kevin Rose, Wireless/EMC Specialist**

Signature:

Test location(s)

Company name	Nemko Canada Inc.	
Address	303 River Road	292 Labrosse Avenue
City	Ottawa	Pointe-Claire
Province	Ontario	Quebec
Postal code	K1V 1H2	H9R 5L8
Country	Canada	Canada
Telephone	+1 613 737 9680	+1 514 694 2684
Facsimile	+1 613 737 9691	+1 514 694 3528
Toll free	+1 800 563 6336	
Website	www.nemko.com	www.nemko.com
Site number	FCC: CA2040; ISED: 2040A-4 (3 m SAC)	FCC: CA2041; ISED: 2040G-5 (3 m SAC)

Limits of responsibility

Note that the results contained in this report relate only to the items tested and were obtained in the period between the date of initial receipt of samples and the date of issue of the report.

This test report has been completed in accordance with the requirements of ISO/IEC 17025. All results contain in this report are within Nemko Canada's ISO/IEC 17025 accreditation.

Copyright notification

Nemko Canada Inc. authorizes the applicant to reproduce this report provided it is reproduced in its entirety and for use by the company's employees only. Any use which a third party makes of this report, or any reliance on or decisions to be made based on it, are the responsibility of such third parties. Nemko Canada Inc. accepts no responsibility for damages, if any, suffered by any third party as a result of decisions made or actions based on this report.
 © Nemko Canada Inc.

Table of contents

Table of contents	3
Section 1. Report summary	4
1.1 Applicant and manufacturer	4
1.2 Test specifications	4
1.3 Test methods	4
1.4 Statement of compliance	4
1.5 Exclusions	4
1.6 Test report revision history	4
Section 2. Summary of test results	5
2.1 FCC Part 15 Subpart C, general requirements test results	5
2.2 FCC Part 15 Subpart C, intentional radiators test results for digital transmission systems (DTS)	5
2.3 ISED RSS-Gen, Issue 4, test results	6
2.4 ISED RSS-247, Issue 2, test results for digital transmission systems (DTS)	6
Section 3. Equipment under test (EUT) details	7
3.1 Sample information	7
3.2 EUT information	7
3.3 Technical information	7
3.4 Product description and theory of operation	7
3.5 EUT exercise details	7
3.6 EUT setup diagrams	8
Section 4. Engineering considerations	9
4.1 Modifications incorporated in the EUT	9
4.2 Technical judgment	9
4.3 Deviations from laboratory tests procedures	9
Section 5. Test conditions	10
5.1 Atmospheric conditions	10
5.2 Power supply range	10
Section 6. Measurement uncertainty	11
6.1 Uncertainty of measurement	11
Section 7. Test equipment	12
7.1 Test equipment list	12
Section 8. Testing data	13
8.1 FCC 15.31(e) Variation of power source	13
8.2 FCC 15.31(m) and RSS-Gen 6.8 Number of frequencies	14
8.3 FCC 15.203 Antenna requirement	15
8.4 FCC 15.247(a)(2) and RSS-247 5.2(a) Minimum 6 dB bandwidth for DTS systems	16
8.5 FCC 15.247(b) and RSS-247 5.4 (d) Transmitter output power and e.i.r.p. requirements for DTS in 2 GHz	19
8.6 FCC 15.247(d) and RSS-247 5.5 Spurious (out-of-band) unwanted emissions	22
8.7 FCC 15.247(e) and RSS-247 5.2(b) Power spectral density for digitally modulated devices	31
Section 9. Block diagrams of test set-ups	33
9.1 Radiated emissions set-up for frequencies below 1 GHz	33
9.2 Radiated emissions set-up for frequencies above 1 GHz	33
9.3 Antenna port set-up	34

Section 1. Report summary

1.1 Applicant and manufacturer

Company name	LEGO System A/S
Address	Åstvej 1
City	Billund
Province/State	N/A
Postal/Zip code	7190
Country	Denmark

1.2 Test specifications

FCC 47 CFR Part 15, Subpart C, Clause 15.247	Operation in the 902–928 MHz, 2400–2483.5 MHz, and 5725–585 MHz
RSS-247, Issue 2, Feb 2017, Section 5	Digital Transmission Systems (DTSs), Frequency Hopping Systems (FHSs) and Licence-Exempt Local Area Network (LE-LAN) Devices

1.3 Test methods

558074 D01 DTS Meas Guidance v04 (April 5, 2017)	Guidance for Performing Compliance Measurements on Digital Transmission Systems (DTS) Operating Under §15.247
ANSI C63.10 v2013	American National Standard of Procedures for Compliance Testing of Unlicensed Wireless Devices

1.4 Statement of compliance

In the configuration tested, the EUT was found compliant.

Testing was performed against all relevant requirements of the test standard except as noted in section 1.5 below. Results obtained indicate that the product under test complies in full with the requirements tested. The test results relate only to the items tested.

See “Summary of test results” for full details.

1.5 Exclusions

None

1.6 Test report revision history

Revision #	Date of issue	Details of changes made to test report
TRF	August 24, 2018	Original report issued

Section 2. Summary of test results

2.1 FCC Part 15 Subpart C, general requirements test results

Table 2.1-1: FCC general requirements results

Part	Test description	Verdict
§15.207(a)	Conducted limits	Not applicable
§15.31(e)	Variation of power source	Pass
§15.31(m)	Number of tested frequencies	Pass
§15.203	Antenna requirement	Pass

Notes: EUT is a battery-operated equipment, the testing was performed using fresh batteries.

2.2 FCC Part 15 Subpart C, intentional radiators test results for digital transmission systems (DTS)

Table 2.2-1: FCC 15.247 results for DTS

Part	Test description	Verdict
§15.247(a)(2)	Minimum 6 dB bandwidth	Pass
§15.247(b)(3)	Maximum peak output power in the 902–928 MHz, 2400–2483.5 MHz, and 5725–5850 MHz bands	Pass
§15.247(c)(1)	Fixed point-to-point operation with directional antenna gains greater than 6 dBi	Not applicable
§15.247(c)(2)	Transmitters operating in the 2400–2483.5 MHz band that emit multiple directional beams	Not applicable
§15.247(d)	Spurious emissions	Pass
§15.247(e)	Power spectral density	Pass
§15.247(f)	Time of occupancy for hybrid systems	Not applicable

2.3 ISED RSS-Gen, Issue 4, test results

Table 2.3-1: RSS-Gen results

Part	Test description	Verdict
7.1.2	Receiver radiated emission limits ¹	Not applicable
7.1.3	Receiver conducted emission limits ¹	Not applicable
6.8	Number of frequencies	Pass
8.8	Power Line Conducted Emissions Limits for Licence-Exempt Radio Apparatus	Not applicable ²

Notes: ¹ According to sections 5.2 and 5.3 of RSS-Gen, Issue 4 the EUT does not have a stand-alone receiver neither scanner receiver, therefore exempt from receiver requirements.

² EUT is a battery-operated equipment, the testing was performed using fresh batteries.

2.4 ISED RSS-247, Issue 2, test results for digital transmission systems (DTS)

Table 2.4-1: RSS-247 results for DTS

Part	Test description	Verdict
5.2 (a)	Minimum 6 dB bandwidth	Pass
5.2 (b)	Maximum power spectral density	Pass
5.3	Hybrid Systems	
5.3 (a)	Digital modulation turned off	Not applicable
5.3 (b)	Frequency hopping turned off	Not applicable
5.4	Transmitter output power and e.i.r.p. requirements	
5.4 (d)	Systems employing digital modulation techniques	Pass
5.4 (e)	Point-to-point systems in 2400–2483.5 MHz and 5725–5850 MHz band	Not applicable
5.4 (f)	Transmitters which operate in the 2400–2483.5 MHz band with multiple directional beams	Not applicable
5.5	Unwanted emissions	Pass

Notes: None

Section 3. Equipment under test (EUT) details

3.1 Sample information

Receipt date	June 25, 2018
Nemko sample ID number	1

3.2 EUT information

Product name	Bluetooth Low Energy Transceiver
Model	HUB NO.4
Serial number	N/A

3.3 Technical information

Applicant IC company number	3072A
IC UPN number	28738
All used IC test site(s) Reg. number	2040A-4
RSS number and Issue number	RSS-247 Issue 2, Feb 2017
Frequency band	2400–2483.5 MHz
Frequency Min (MHz)	2402
Frequency Max (MHz)	2480
RF power Min (W)	N/A
RF power Max (W), Conducted	0.000817 (–0.88 dBm)
Field strength, Units @ distance	N/A
Measured BW (kHz) (99 %)	1048
Calculated BW (kHz), as per TRC-43	N/A
Type of modulation	GFSK
Emission classification (F1D, G1D, D1D)	F1D
Transmitter spurious, dB μ V/m @ 3 m	48.72 (average) at 2483.5 MHz
Power requirements	9 V _{DC} from 6 × ‘AAA’ type of batteries
Antenna information	Integral antenna with +2.1 dBi gain

3.4 Product description and theory of operation

The device tested is a system with a central HUB which controls a motor and a LED. The system functions with a dedicated remote connection to the central HUB, or by a remote device (iOS, Android or similar) running a dedicated app connected via BLE.

3.5 EUT exercise details

EUT was programmed to transmit continuously by pressing the button desired amount of times. For conducted measurements EUT was modified by the applicant with the 50 Ohm RF connector.

3.6 EUT setup diagrams

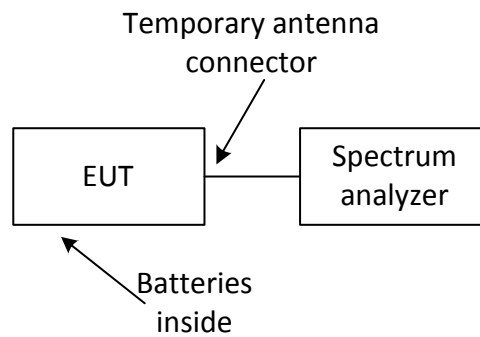

Figure 3.6-1: Setup diagram for antenna port measurements

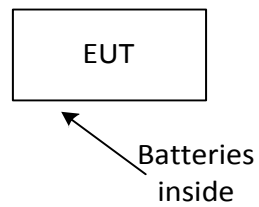

Figure 3.6-2: Setup diagram for radiated measurements

Section 4. Engineering considerations

4.1 Modifications incorporated in the EUT

There were no modifications performed to the EUT during this assessment.

4.2 Technical judgment

None

4.3 Deviations from laboratory tests procedures

No deviations were made from laboratory procedures.

Section 5. Test conditions

5.1 Atmospheric conditions

Temperature	15–30 °C
Relative humidity	20–75 %
Air pressure	860–1060 mbar

When it is impracticable to carry out tests under these conditions, a note to this effect stating the ambient temperature and relative humidity during the tests shall be recorded and stated.

5.2 Power supply range

The normal test voltage for equipment to be connected to the mains shall be the nominal mains voltage. For the purpose of the present document, the nominal voltage shall be the declared voltage, or any of the declared voltages $\pm 5\%$, for which the equipment was designed.

Section 6. Measurement uncertainty

6.1 Uncertainty of measurement

UKAS Lab 34 and TIA-603-B have been used as guidance for measurement uncertainty reasonable estimations with regards to previous experience and validation of data. Nemko Canada, Inc. follows these test methods in order to satisfy ISO/IEC 17025 requirements for estimation of uncertainty of measurement for wireless products.

Measurement uncertainty budgets for the tests are detailed below. Measurement uncertainty calculations assume a coverage factor of $K = 2$ with 95% certainty.

Table 6.1-1: Measurement uncertainty

Test name	Measurement uncertainty, dB
All antenna port measurements	0.55
Conducted spurious emissions	1.13
Radiated spurious emissions	3.78
AC power line conducted emissions	3.55

Section 7. Test equipment

7.1 Test equipment list

Table 7.1-1: Equipment list

Equipment	Manufacturer	Model no.	Asset no.	Cal cycle	Next cal.
3 m EMI test chamber	TDK	SAC-3	FA002047	1 year	Dec. 09/18
Flush mount turntable	Sunol	FM2022	FA002082	—	NCR
Controller	Sunol	SC104V	FA002060	—	NCR
Antenna mast	Sunol	TLT2	FA002061	—	NCR
Receiver/spectrum analyzer	Rohde & Schwarz	ESU 26	FA002043	1 year	March 26/19
Spectrum analyzer	Rohde & Schwarz	FSU	FA001877	1 year	July 18/18
Horn with Preamp (1–18 GHz)	ETS-Lindgren	3117	FA002840	1 year	Dec. 07/18
Horn antenna (18–40 GHz)	EMCO	3116	FA001847	1 year	June 27/18
Pre-amplifier (18–26 GHz)	Narda	BBS-1826N612	FA001550	—	VOU

Note: NCR - no calibration required, VOU - verify on use

Section 8. Testing data

8.1 FCC 15.31(e) Variation of power source

8.1.1 Definitions and limits

For intentional radiators, measurements of the variation of the input power or the radiated signal level of the fundamental frequency component of the emission, as appropriate, shall be performed with the supply voltage varied between 85% and 115% of the nominal rated supply voltage. For battery operated equipment, the equipment tests shall be performed using a new battery.

8.1.2 Test date

Start date June 25, 2018

8.1.3 Observations, settings and special notes

None

8.1.4 Test data

EUT Power requirements: AC DC Battery
If EUT is an AC or a DC powered, was the noticeable output power variation observed? YES NO N/A
If EUT is battery operated, was the testing performed using fresh batteries? YES NO N/A
If EUT is rechargeable battery operated, was the testing performed using fully charged batteries? YES NO N/A

8.2 FCC 15.31(m) and RSS-Gen 6.8 Number of frequencies

8.2.1 Definitions and limits

FCC:

Measurements on intentional radiators or receivers shall be performed and, if required, reported for each band in which the device can be operated with the device operating at the number of frequencies in each band specified in the following table.

ISED:

Except where otherwise specified, measurements shall be performed for each frequency band of operation for which the radio apparatus is to be certified, with the device operating at the frequencies in each band of operation shown in table below. The frequencies selected for measurements shall be reported in the test report.

Table 8.2-1: Frequency Range of Operation

Frequency Range Over Which the Device Operates (in each Band)	Number of Measurement Frequencies Required	Location of Measurement Frequency in Band of Operation
1 MHz or less	1	Center (middle of the band)
1–10 MHz	2	1 near high end, 1 near low end
Greater than 10 MHz	3	1 near high end, 1 near center and 1 near low end

8.2.2 Test date

Start date June 25, 2018

8.2.3 Observations, settings and special notes

None

8.2.4 Test data

Table 8.2-2: Test channels selection

Start of Frequency range, MHz	End of Frequency range, MHz	Frequency range bandwidth, MHz	Low channel, MHz	Mid channel, MHz	High channel, MHz
2400	2483.5	83.5	2402	2440	2480

8.3 FCC 15.203 Antenna requirement

8.3.1 Definitions and limits

An intentional radiator shall be designed to ensure that no antenna other than that furnished by the responsible party shall be used with the device. The use of a permanently attached antenna or of an antenna that uses a unique coupling to the intentional radiator shall be considered sufficient to comply with the provisions of this section. The manufacturer may design the unit so that a broken antenna can be replaced by the user, but the use of a standard antenna jack or electrical connector is prohibited. This requirement does not apply to intentional radiators that must be professionally installed, such as perimeter protection systems and some field disturbance sensors, or to other intentional radiators which, in accordance with §15.31(d), must be measured at the installation site. However, the installer shall be responsible for ensuring that the proper antenna is employed so that the limits in this part are not exceeded.

8.3.2 Test date

Start date June 25, 2018

8.3.3 Observations, settings and special notes

None

8.3.4 Test data

Must the EUT be professionally installed? YES NO
Does the EUT have detachable antenna(s)? YES NO
If detachable, is the antenna connector(s) non-standard? YES NO N/A

8.4 FCC 15.247(a)(2) and RSS-247 5.2(a) Minimum 6 dB bandwidth for DTS systems

8.4.1 Definitions and limits

FCC:

Systems using digital modulation techniques may operate in the 902–928 MHz, 2400–2483.5 MHz, and 5725–5850 MHz bands. The minimum 6 dB bandwidth shall be at least 500 kHz.

ISED:

The minimum 6 dB bandwidth shall be 500 kHz.

8.4.1 Test date

Start date June 25, 2018

8.4.2 Observations, settings and special notes

Spectrum analyser settings:

Resolution bandwidth	100 kHz
Video bandwidth	$\geq 3 \times \text{RBW}$
Frequency span	2 MHz
Detector mode	Peak
Trace mode	Max Hold

8.4.3 Test data

Table 8.4-1: 6 dB bandwidth results

Frequency, MHz	6 dB bandwidth, kHz	Minimum limit, kHz	Margin, kHz
2402	705.13	500.00	205.13
2440	717.95	500.00	217.95
2480	705.13	500.00	205.13

Table 8.4-2: 99 % bandwidth results

Frequency, MHz	99 % bandwidth, MHz
2402	1.048
2440	1.054
2480	1.058

Note: Occupied Bandwidth (99%) is measured according to RSS-GEN Issue 4, clause 6.6. This value is reported for information only.

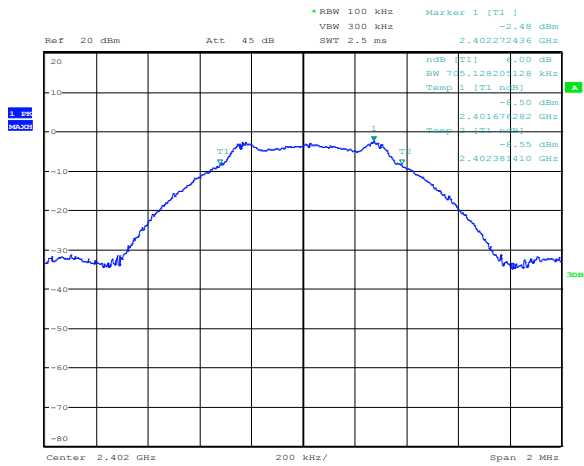

Date: 28 JUN.2018 13:12:43

Figure 8.4-1: 6 dB bandwidth on low channel

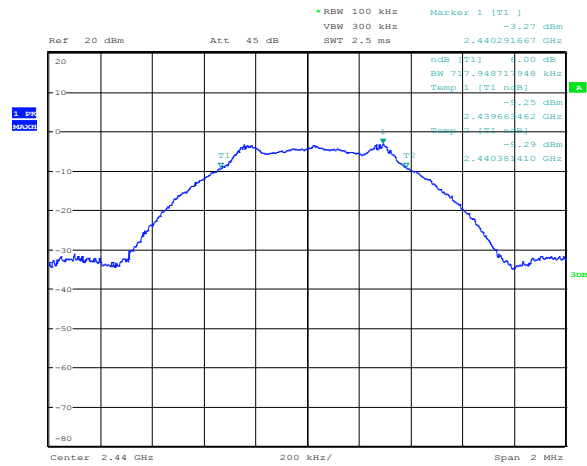

Date: 28 JUN.2018 13:13:06

Figure 8.4-2: 6 dB bandwidth on mid channel

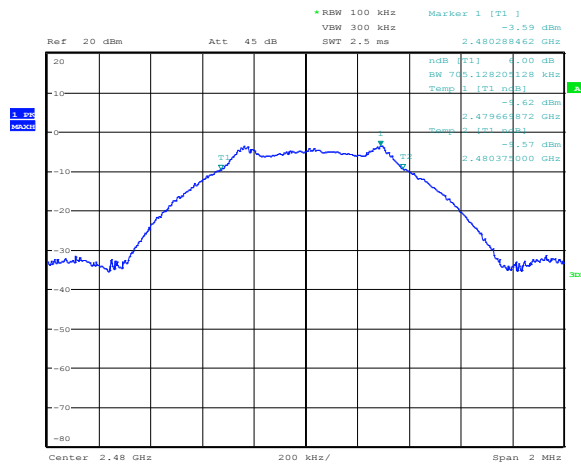

Date: 28 JUN.2018 13:13:26

Figure 8.4-3: 6 dB bandwidth on high channel

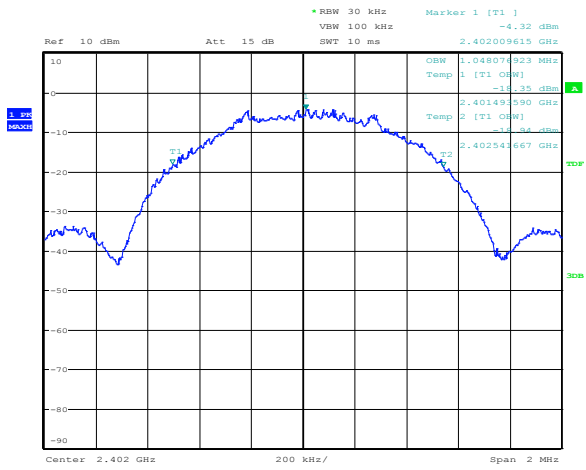

Date: 25.JUN.2018 15:43:38

Figure 8.4-4: 99 % bandwidth on low channel

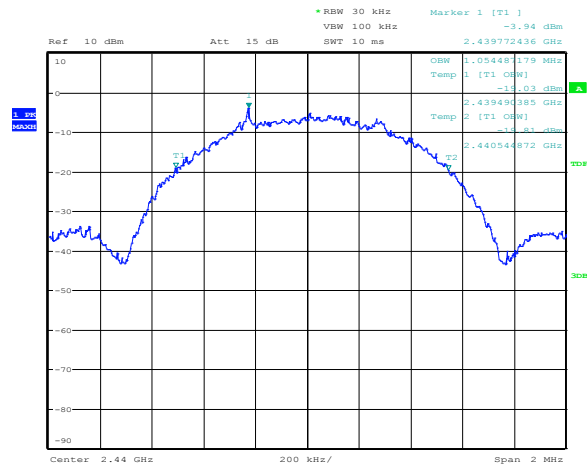

Date: 25.JUN.2018 15:44:25

Figure 8.4-5: 99 % bandwidth on mid channel

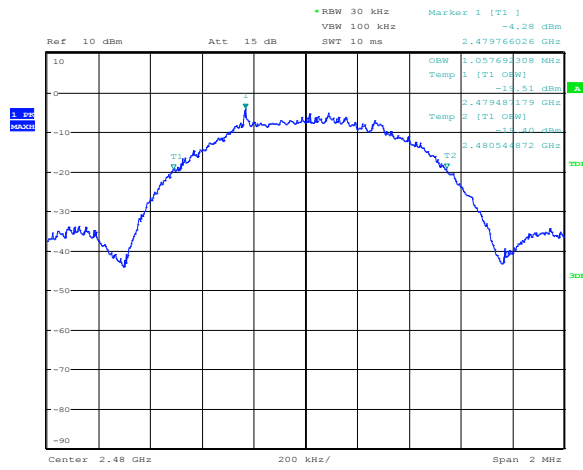

Date: 25.JUN.2018 15:46:22

Figure 8.4-6: 99 % bandwidth on high channel

8.5 FCC 15.247(b) and RSS-247 5.4 (d) Transmitter output power and e.i.r.p. requirements for DTS in 2 GHz

8.5.1 Definitions and limits

FCC:

- (b) The maximum peak conducted output power of the intentional radiator shall not exceed the following:
- (3) For systems using digital modulation in the 2400–2483.5 MHz band: 1 W (30 dBm). As an alternative to a peak power measurement, compliance with the one Watt limit can be based on a measurement of the maximum conducted output power. Maximum Conducted Output Power is defined as the total transmit power delivered to all antennas and antenna elements averaged across all symbols in the signaling alphabet when the transmitter is operating at its maximum power control level. Power must be summed across all antennas and antenna elements. The average must not include any time intervals during which the transmitter is off or is transmitting at a reduced power level. If multiple modes of operation are possible (e.g., alternative modulation methods), the maximum conducted output power is the highest total transmit power occurring in any mode.
 - (4) The conducted output power limit specified in paragraph (b) of this section is based on the use of antennas with directional gains that do not exceed 6 dBi. Except as shown in paragraph (c) of this section, if transmitting antennas of directional gain greater than 6 dBi are used, the conducted output power from the intentional radiator shall be reduced below the stated values in paragraphs (b)(1), (b)(2), and (b)(3) of this section, as appropriate, by the amount in dB that the directional gain of the antenna exceeds 6 dBi.
- (c) Operation with directional antenna gains greater than 6 dBi.
- (1) Fixed point-to-point operation:
- (i) Systems operating in the 2400–2483.5 MHz band that are used exclusively for fixed, point-to-point operations may employ transmitting antennas with directional gain greater than 6 dBi provided the maximum conducted output power of the intentional radiator is reduced by 1 dB for every 3 dB that the directional gain of the antenna exceeds 6 dBi.
 - (iii) Fixed, point-to-point operation, as used in paragraphs (c)(1)(i) and (c)(1)(ii) of this section, excludes the use of point-to-multipoint systems, omnidirectional applications, and multiple co-located intentional radiators transmitting the same information. The operator of the spread spectrum or digitally modulated intentional radiator or, if the equipment is professionally installed, the installer is responsible for ensuring that the system is used exclusively for fixed, point-to-point operations. The instruction manual furnished with the intentional radiator shall contain language in the installation instructions informing the operator and the installer of this responsibility.
- (2) In addition to the provisions in paragraphs (b)(1), (b)(3), (b)(4) and (c)(1)(i) of this section, transmitters operating in the 2400–2483.5 MHz band that emit multiple directional beams, simultaneously or sequentially, for the purpose of directing signals to individual receivers or to groups of receivers provided the emissions comply with the following:
- (i) Different information must be transmitted to each receiver.
 - (ii) If the transmitter employs an antenna system that emits multiple directional beams but does not do emit multiple directional beams simultaneously, the total output power conducted to the array or arrays that comprise the device, i.e., the sum of the power supplied to all antennas, antenna elements, staves, etc. and summed across all carriers or frequency channels, shall not exceed the limit specified in paragraph (b)(1) or (b)(3) of this section, as applicable. However, the total conducted output power shall be reduced by 1 dB below the specified limits for each 3 dB that the directional gain of the antenna/antenna array exceeds 6 dBi. The directional antenna gain shall be computed as follows:
 - (A) The directional gain shall be calculated as the sum of 10 log (number of array elements or staves) plus the directional gain of the element or stave having the highest gain.
 - (B) A lower value for the directional gain than that calculated in paragraph (c)(2)(ii)(A) of this section will be accepted if sufficient evidence is presented, e.g., due to shading of the array or coherence loss in the beamforming.
 - (iii) If a transmitter employs an antenna that operates simultaneously on multiple directional beams using the same or different frequency channels, the power supplied to each emission beam is subject to the power limit specified in paragraph (c)(2)(ii) of this section. If transmitted beams overlap, the power shall be reduced to ensure that their aggregate power does not exceed the limit specified in paragraph (c)(2)(ii) of this section. In addition, the aggregate power transmitted simultaneously on all beams shall not exceed the limit specified in paragraph (c)(2)(ii) of this section by more than 8 dB.
 - (iv) Transmitters that emit a single directional beam shall operate under the provisions of paragraph (c)(1) of this section.



ISED:

d. For DTSs employing digital modulation techniques operating in the 2400–2483.5 MHz band, the maximum peak conducted output power shall not exceed 1 W. The e.i.r.p. shall not exceed 4 W, except as provided in section 5.4(e).

As an alternative to a peak power measurement, compliance can be based on a measurement of the maximum conducted output power. The maximum conducted output power is the total transmit power delivered to all antennas and antenna elements, averaged across all symbols in the signalling alphabet when the transmitter is operating at its maximum power control level. Power must be summed across all antennas and antenna elements. The average must not include any time intervals during which the transmitter is off or transmitting at a reduced power level. If multiple modes of operation are implemented, the maximum conducted output power is the highest total transmit power occurring in any mode.

e. Fixed point-to-point systems in the 2400–2483.5 MHz band are permitted to have an e.i.r.p. higher than 4 W provided that the higher e.i.r.p. is achieved by employing higher gain directional antennas and not higher transmitter output powers. Point-to-multipoint systems, omnidirectional applications and multiple co-located transmitters transmitting the same information are prohibited from exceeding an e.i.r.p. of 4 W.

f. Transmitters operating in the band 2400–2483.5 MHz, may employ antenna systems that emit multiple directional beams simultaneously or sequentially, for the purpose of directing signals to individual receivers or to groups of receivers, provided that the emissions comply with the following:

i Different information must be transmitted to each receiver.

ii If the transmitter employs an antenna system that emits multiple directional beams, but does not emit multiple directional beams simultaneously, the total output power conducted to the array or arrays that comprise the device (i.e. the sum of the power supplied to all antennas, antenna elements, staves, etc., and summed across all carriers or frequency channels) shall not exceed the applicable output power limit specified in sections 5.4(b) and 5.4(d). However, the total conducted output power shall be reduced by 1 dB below the specified limits for each 3 dB that the directional gain of the antenna/antenna array exceeds 6 dBi. The directional antenna gain shall be computed as the sum of 10 log (number of array elements or staves) plus the directional gain of the element or stave having the highest gain.

iii If a transmitter employs an antenna that operates simultaneously on multiple directional beams using the same or different frequency channels, the power supplied to each emission beam is subject to the applicable power limit specified in sections 5.4(b) and 5.4(d). If transmitted beams overlap, the power shall be reduced to ensure that their aggregate power does not exceed the applicable limit specified in sections 5.4(b) and 5.4(d). In addition, the aggregate power transmitted simultaneously on all beams shall not exceed the applicable limit specified in sections 5.4(b) and 5.4(d) by more than 8 dB.

iv Transmitters that transmit a single directional beam shall operate under the provisions of sections 5.4(b), 5.4(d) and 5.4(e).

8.5.1 Test date

Start date June 25, 2018

8.5.2 Observations, settings and special notes

The test was performed according to DTS guidelines using Peak method

8.5.3 Test data

Table 8.5-1: Output power measurements results

Frequency, MHz	Conducted output power, dBm		Margin, dB	Antenna gain, dBi	EIRP, dBm	EIRP limit, dBm	EIRP margin, dB
	Measured	Limit					
2402	-0.88	30.00	30.88	2.10	1.22	36.00	34.78
2440	-1.70	30.00	31.70	2.10	0.40	36.00	35.60
2480	-1.96	30.00	31.96	2.10	0.14	36.00	35.86

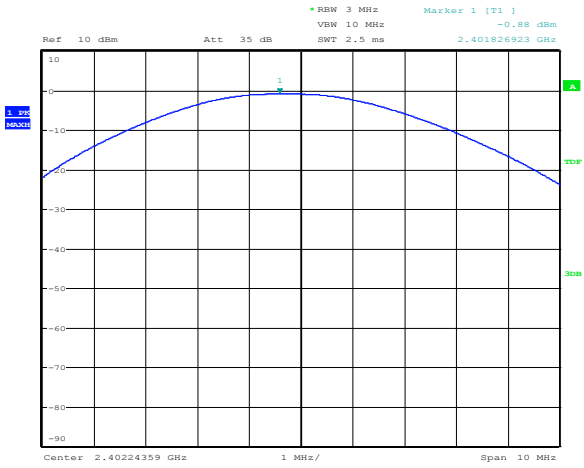

Date: 25.JUN.2018 15:38:55

Figure 8.5-1: Output power on low channel

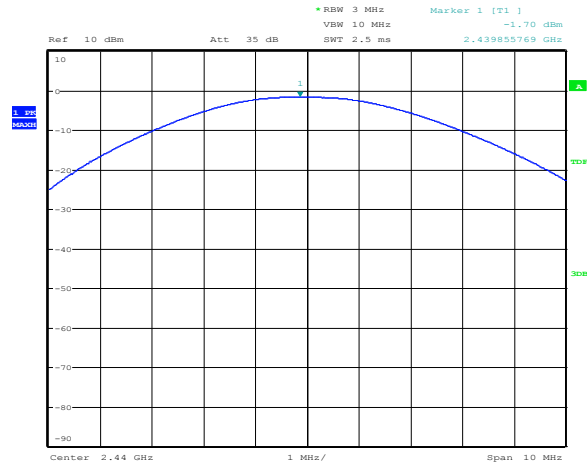

Date: 25.JUN.2018 15:40:00

Figure 8.5-2: Output power on mid channel

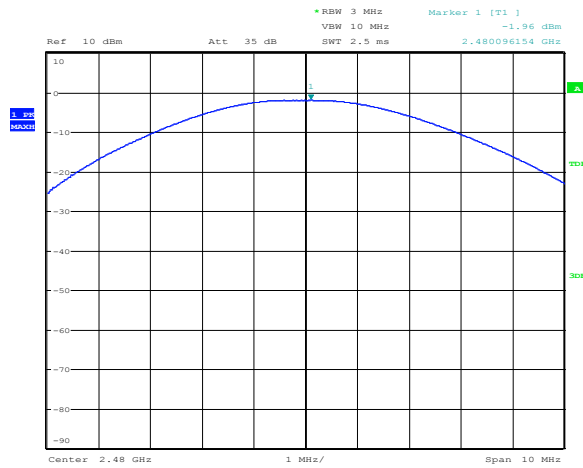

Date: 25.JUN.2018 15:40:38

Figure 8.5-3: Output power on high channel

8.6 FCC 15.247(d) and RSS-247 5.5 Spurious (out-of-band) unwanted emissions

8.6.1 Definitions and limits

FCC:

In any 100 kHz bandwidth outside the frequency band in which the spread spectrum or digitally modulated intentional radiator is operating, the radio frequency power that is produced by the intentional radiator shall be at least 20 dB below that in the 100 kHz bandwidth within the band that contains the highest level of the desired power, based on either an RF conducted or a radiated measurement, provided the transmitter demonstrates compliance with the peak conducted power limits. If the transmitter complies with the conducted power limits based on the use of RMS averaging over a time interval, as permitted under paragraph (b)(3) of this section, the attenuation required under this paragraph shall be 30 dB instead of 20 dB. Attenuation below the general limits specified in §15.209(a) is not required. In addition, radiated emissions which fall in the restricted bands, as defined in §15.205(a), must also comply with the radiated emission limits specified in §15.209(a) (see §15.205(c)).

ISED:

In any 100 kHz bandwidth outside the frequency band in which the spread spectrum or digitally modulated device is operating, the RF power that is produced shall be at least 20 dB below that in the 100 kHz bandwidth within the band that contains the highest level of the desired power, based on either an RF conducted or a radiated measurement, provided that the transmitter demonstrates compliance with the peak conducted power limits. If the transmitter complies with the conducted power limits based on the use of root-mean-square averaging over a time interval, as permitted under section 5.4(d), the attenuation required shall be 30 dB instead of 20 dB. Attenuation below the general field strength limits specified in RSS-Gen is not required.

Table 8.6-1: FCC §15.209 and RSS-Gen – Radiated emission limits

Frequency, MHz	Field strength of emissions		Measurement distance, m
	µV/m	dBµV/m	
0.009–0.490	2400/F	$67.6 - 20 \times \log_{10}(F)$	300
0.490–1.705	24000/F	$87.6 - 20 \times \log_{10}(F)$	30
1.705–30.0	30	29.5	30
30–88	100	40.0	3
88–216	150	43.5	3
216–960	200	46.0	3
above 960	500	54.0	3

Notes: In the emission table above, the tighter limit applies at the band edges.

For frequencies above 1 GHz the limit on peak RF emissions is 20 dB above the maximum permitted average emission limit applicable to the equipment under test

Table 8.6-2: ISED restricted frequency bands

MHz	MHz	MHz	GHz
0.090–0.110	12.51975–12.52025	399.9–410	5.35–5.46
2.1735–2.1905	12.57675–12.57725	608–614	7.25–7.75
3.020–3.026	13.36–13.41	960–1427	8.025–8.5
4.125–4.128	16.42–16.423	1435–1626.5	9.0–9.2
4.17725–4.17775	16.69475–16.69525	1645.5–1646.5	9.3–9.5
4.20725–4.20775	16.80425–16.80475	1660–1710	10.6–12.7
5.677–5.683	25.5–25.67	1718.8–1722.2	13.25–13.4
6.215–6.218	37.5–38.25	2200–2300	14.47–14.5
6.26775–6.26825	73–74.6	2310–2390	15.35–16.2
6.31175–6.31225	74.8–75.2	2655–2900	17.7–21.4
8.291–8.294	108–138	3260–3267	22.01–23.12
8.362–8.366	156.52475–156.52525	3332–3339	23.6–24.0
8.37625–8.38675	156.7–156.9	3345.8–3358	31.2–31.8
8.41425–8.41475	240–285	3500–4400	36.43–36.5
12.29–12.293	322–335.4	4500–5150	Above 38.6

Note: Certain frequency bands listed in Table 8.6-2 and above 38.6 GHz are designated for low-power licence-exempt applications. These frequency bands and the requirements that apply to the devices are set out in this Standard

Table 8.6-3: FCC restricted frequency bands

MHz	MHz	MHz	GHz
0.090–0.110	16.42–16.423	399.9–410	4.5–5.15
0.495–0.505	16.69475–16.69525	608–614	5.35–5.46
2.1735–2.1905	16.80425–16.80475	960–1240	7.25–7.75
4.125–4.128	25.5–25.67	1300–1427	8.025–8.5
4.17725–4.17775	37.5–38.25	1435–1626.5	9.0–9.2
4.20725–4.20775	73–74.6	1645.5–1646.5	9.3–9.5
6.215–6.218	74.8–75.2	1660–1710	10.6–12.7
6.26775–6.26825	108–121.94	1718.8–1722.2	13.25–13.4
6.31175–6.31225	123–138	2200–2300	14.47–14.5
8.291–8.294	149.9–150.05	2310–2390	15.35–16.2
8.362–8.366	156.52475–156.52525	2483.5–2500	17.7–21.4
8.37625–8.38675	156.7–156.9	2690–2900	22.01–23.12
8.41425–8.41475	162.0125–167.17	3260–3267	23.6–24.0
12.29–12.293	167.72–173.2	3332–3339	31.2–31.8
12.51975–12.52025	240–285	3345.8–3358	36.43–36.5
12.57675–12.57725	322–335.4	3600–4400	Above 38.6
13.36–13.41			

8.6.1 Test date

Start date June 25, 2018

8.6.2 Observations, settings and special notes

The spectrum was searched from 30 MHz to the 10th harmonic.
 Radiated measurements were performed at a distance of 3 m.
 Since fundamental power was tested using peak method, the conducted spurious emissions limit is -20 dBc/100 kHz

Spectrum analyser settings for radiated measurements within restricted bands below 1 GHz:

Resolution bandwidth:	100 kHz
Video bandwidth:	300 kHz
Detector mode:	Peak
Trace mode:	Max Hold

Spectrum analyser settings for peak radiated measurements within restricted bands above 1 GHz:

Resolution bandwidth:	1 MHz
Video bandwidth:	3 MHz
Detector mode:	Peak
Trace mode:	Max Hold

Spectrum analyser settings for conducted spurious emissions measurements:

Resolution bandwidth:	100 kHz
Video bandwidth:	300 kHz
Detector mode:	Peak
Trace mode:	Max Hold

8.6.4 Test data

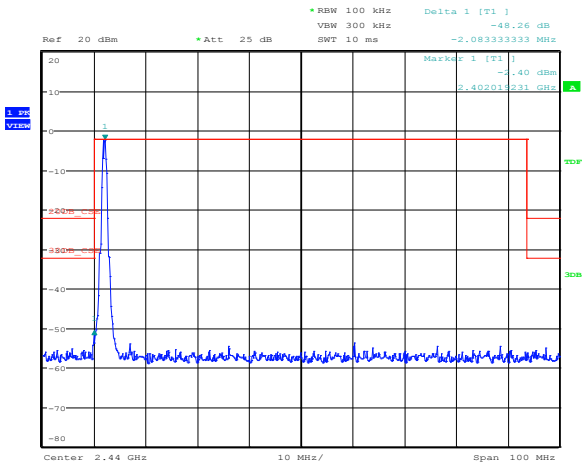

Date: 25.JUN.2018 15:54:06

Figure 8.6-1: Conducted spurious emissions outside restricted bands at the lower band edge (2400 MHz), on low channel

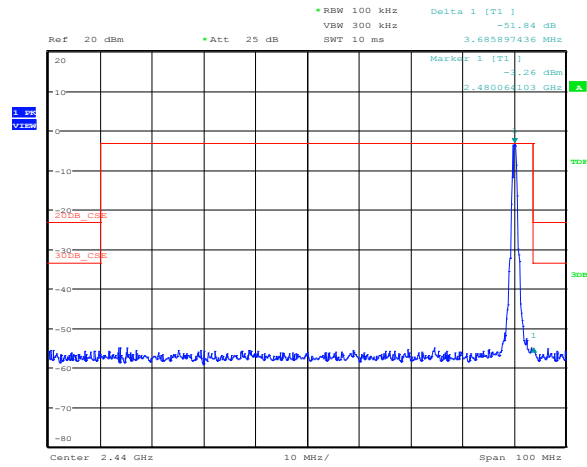

Date: 25.JUN.2018 15:53:12

Figure 8.6-2: Conducted spurious emissions outside restricted bands at the upper band edge (2483.5 MHz), on high channel

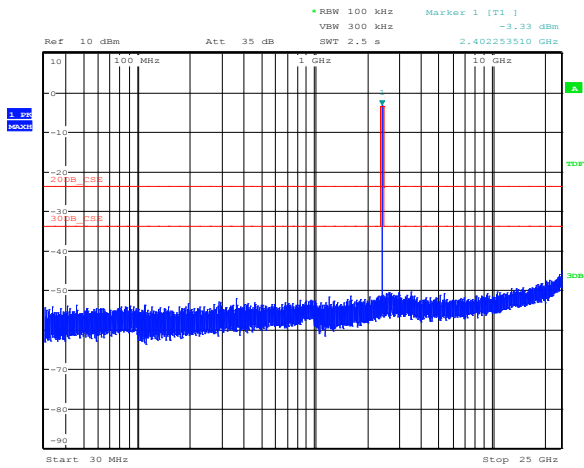

Date: 25 JUN.2018 16:04:01

Figure 8.6-3: Conducted spurious emissions outside restricted bands on low channel

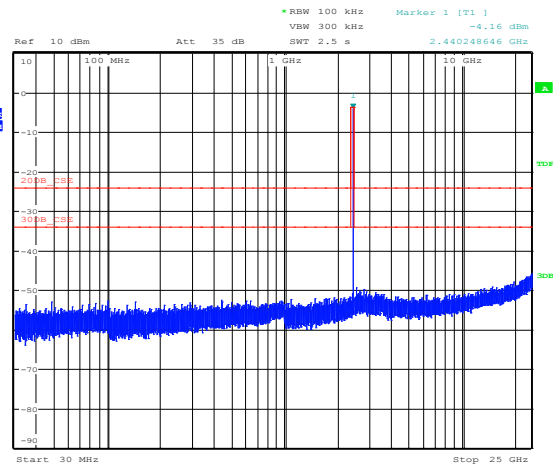

Date: 25 JUN.2018 16:04:58

Figure 8.6-4: Conducted spurious emissions outside restricted bands on mid channel

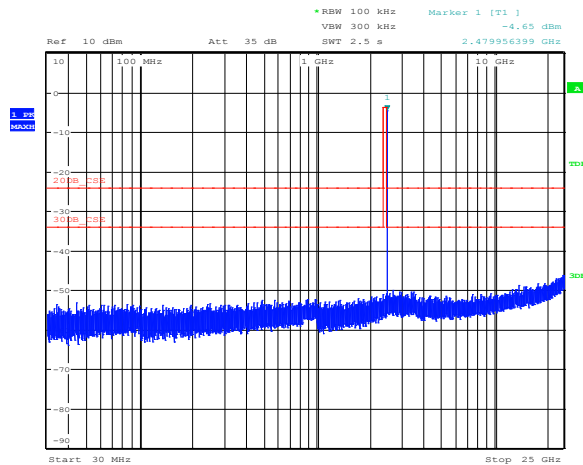

Date: 25 JUN.2018 16:05:46

Figure 8.6-5: Conducted spurious emissions outside restricted bands on high channel

On the plots below limit line is named Taiwan LP0002 restricted bands limit. For FCC and ISED the limit is the same.

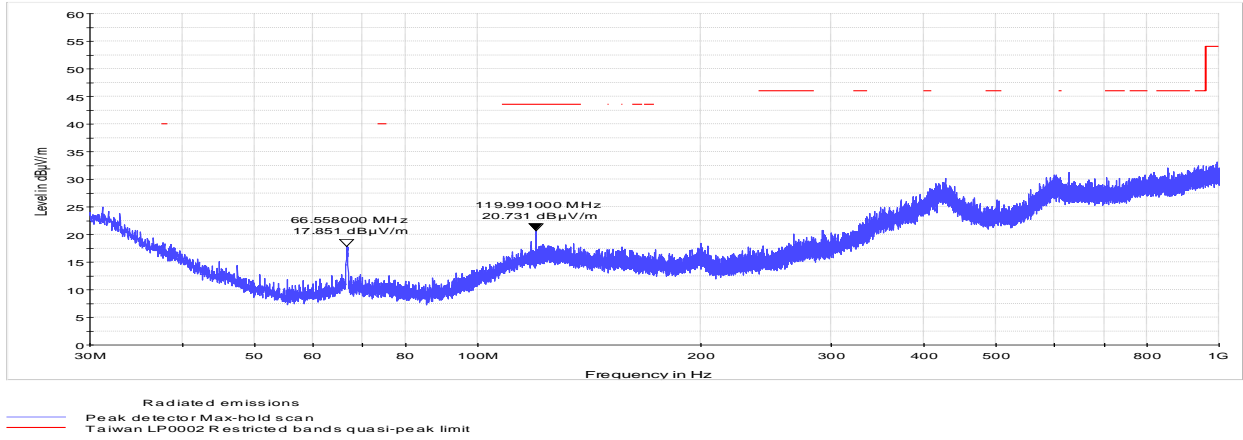

Figure 8.6-6: Radiated spurious emissions within restricted bands on low channel below 1 GHz

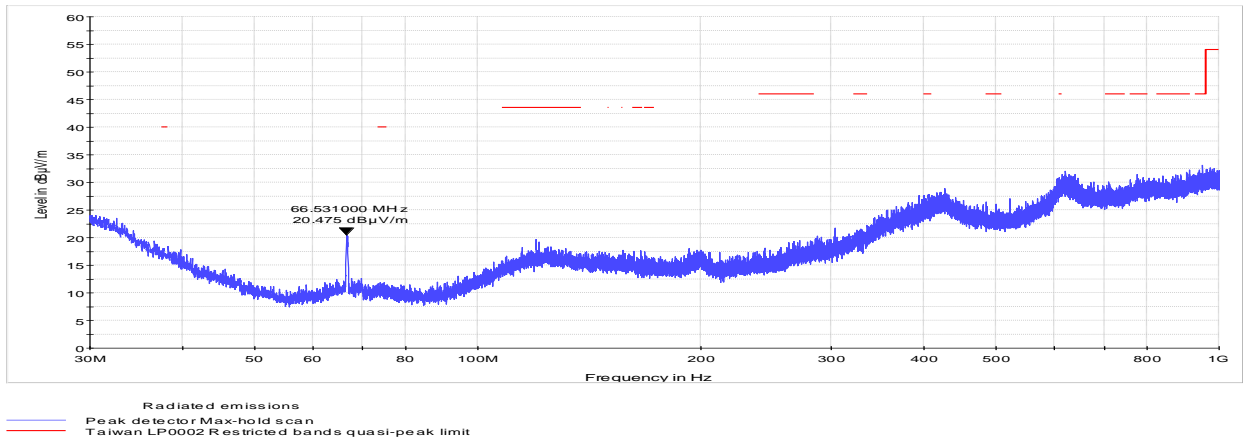

Figure 8.6-7: Radiated spurious emissions within restricted bands on mid channel below 1 GHz

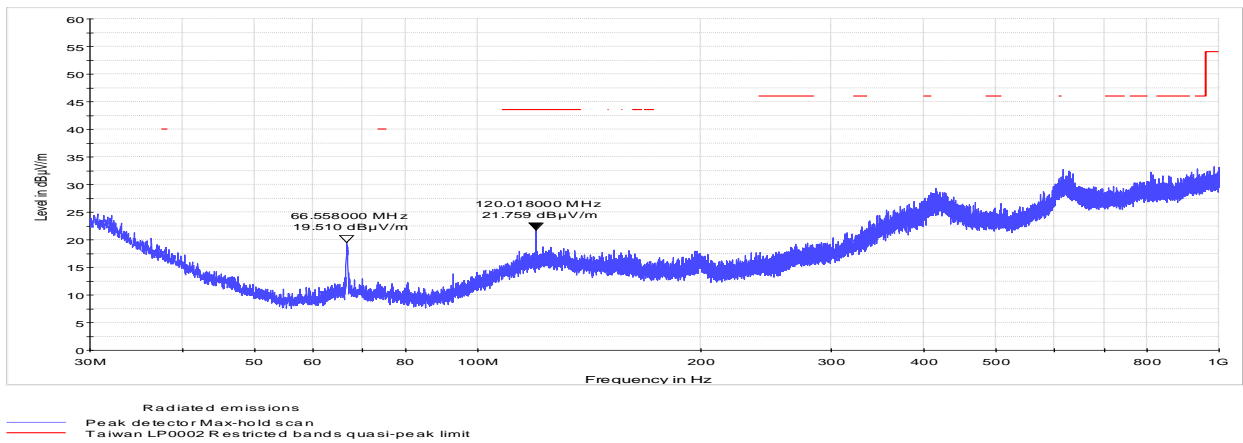

Figure 8.6-8: Radiated spurious emissions within restricted bands on high channel below 1 GHz

On the plots below limit lines are named Taiwan LP0002 restricted bands limit. For FCC and ISED the limits are the same.

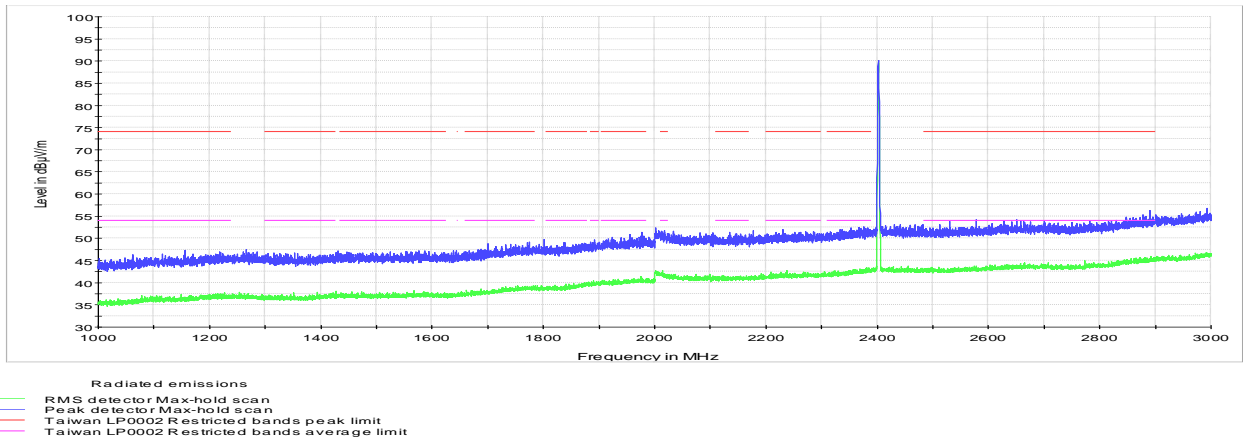

Figure 8.6-9: Radiated spurious emissions within restricted bands on low channel between 1 and 3 GHz

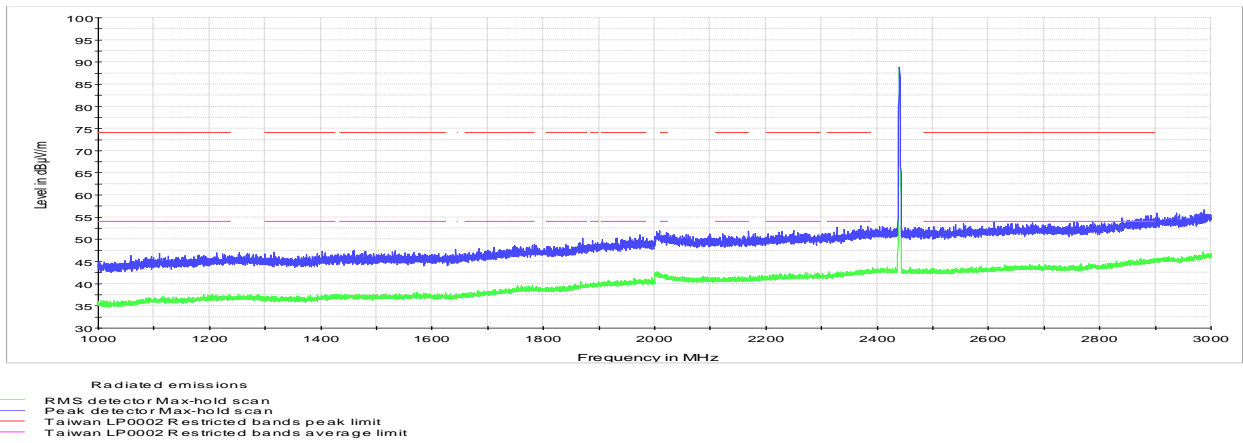

Figure 8.6-10: Radiated spurious emissions within restricted bands on mid channel between 1 and 3 GHz

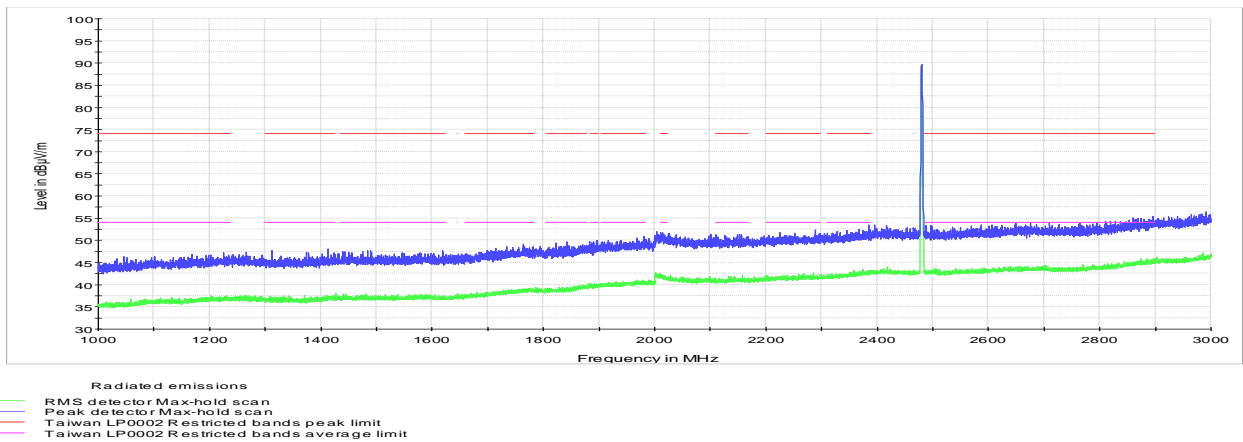

Figure 8.6-11: Radiated spurious emissions within restricted bands on high channel between 1 and 3 GHz

On the plots below limit lines are named Taiwan LP0002 restricted bands limit. For FCC and ISED the limits are the same.

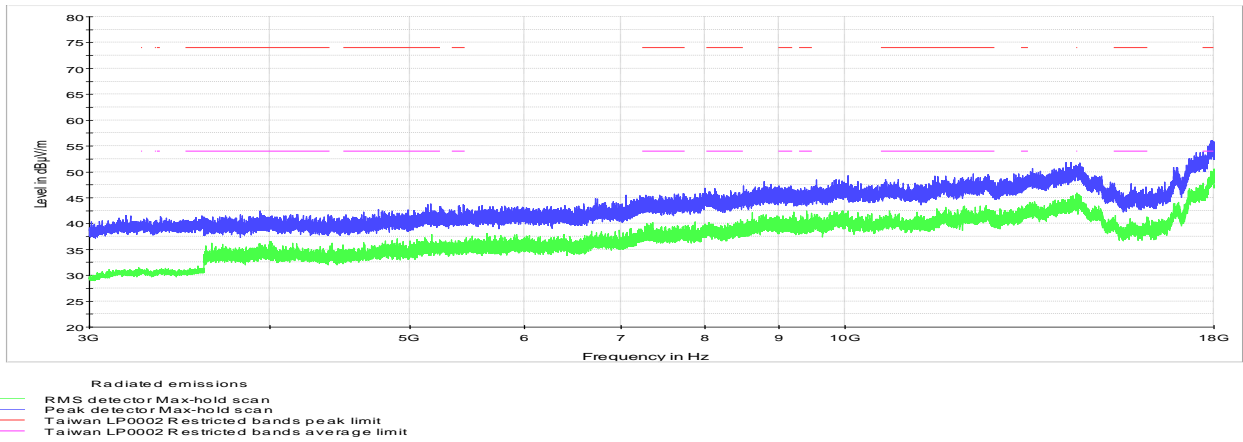

Figure 8.6-12: Radiated spurious emissions within restricted bands on low channel between 3 and 18 GHz

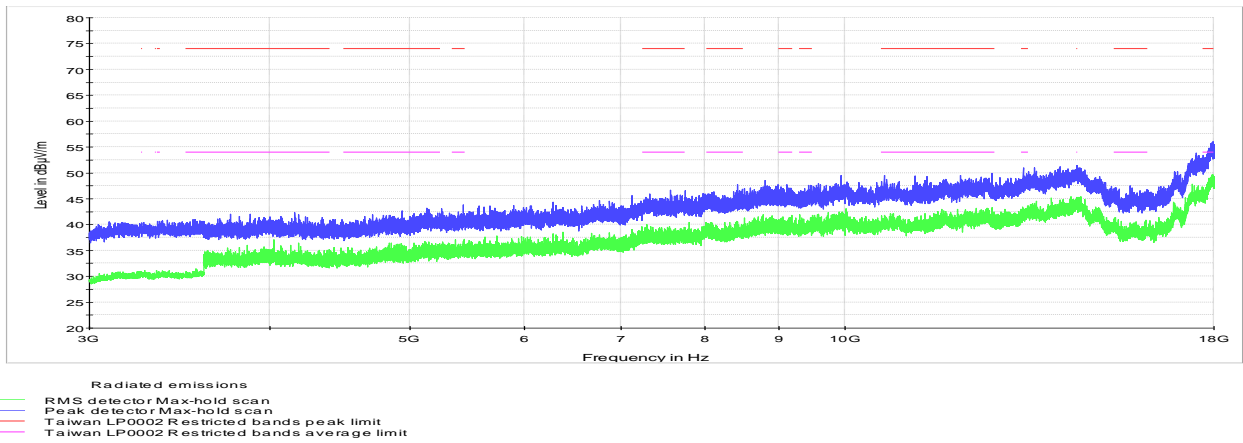

Figure 8.6-13: Radiated spurious emissions within restricted bands on mid channel between 3 and 18 GHz

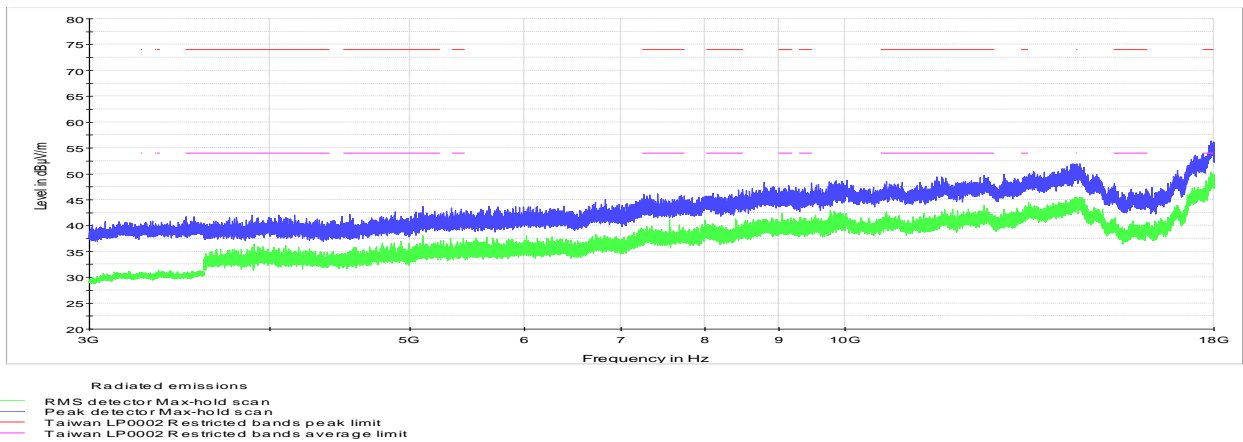

Figure 8.6-14: Radiated spurious emissions within restricted bands on high channel between 3 and 18 GHz

On the plots below limit lines are named Taiwan LP0002 restricted bands limit. For FCC and ISED the limits are the same.

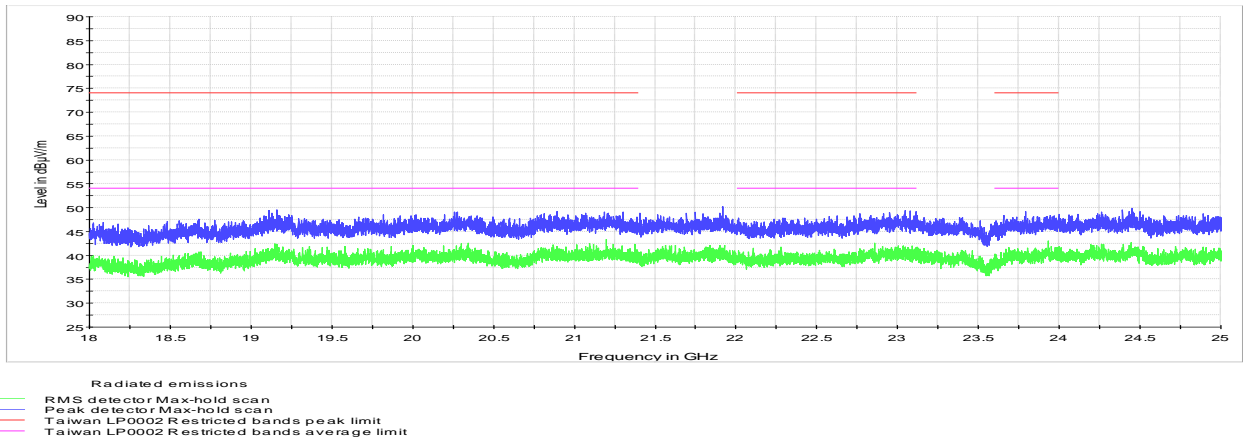

Figure 8.6-15: Radiated spurious emissions within restricted bands on low channel between 18 and 25 GHz

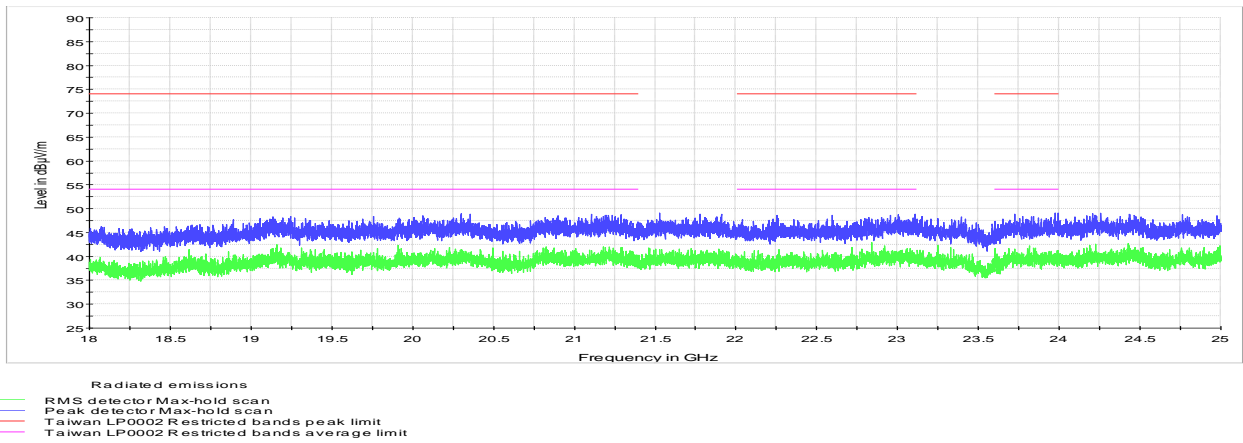

Figure 8.6-16: Radiated spurious emissions within restricted bands on mid channel between 18 and 25 GHz

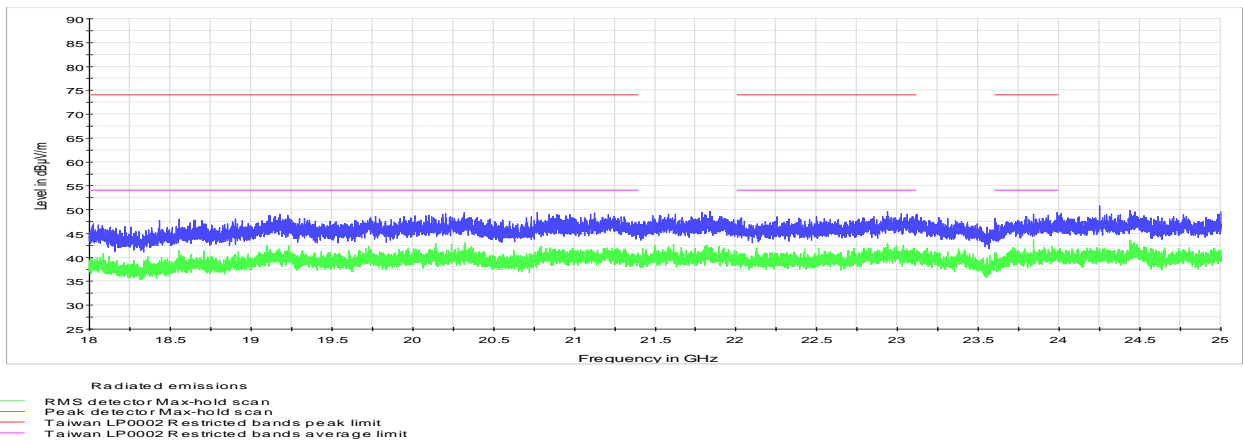

Figure 8.6-17: Radiated spurious emissions within restricted bands on high channel between 18 and 25 GHz

On the plots below limit lines are named Taiwan LP0002 restricted bands limit. For FCC and ISED the limits are the same.

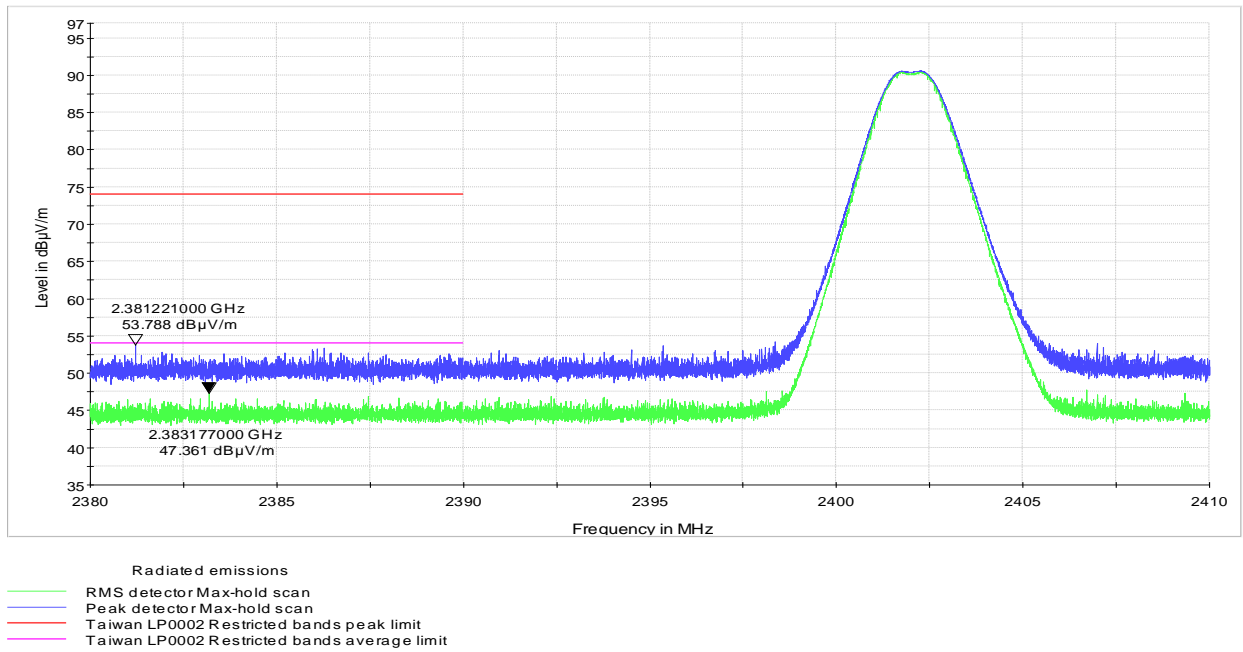

Figure 8.6-18: Radiated spurious emissions within restricted bands at the lower band edge

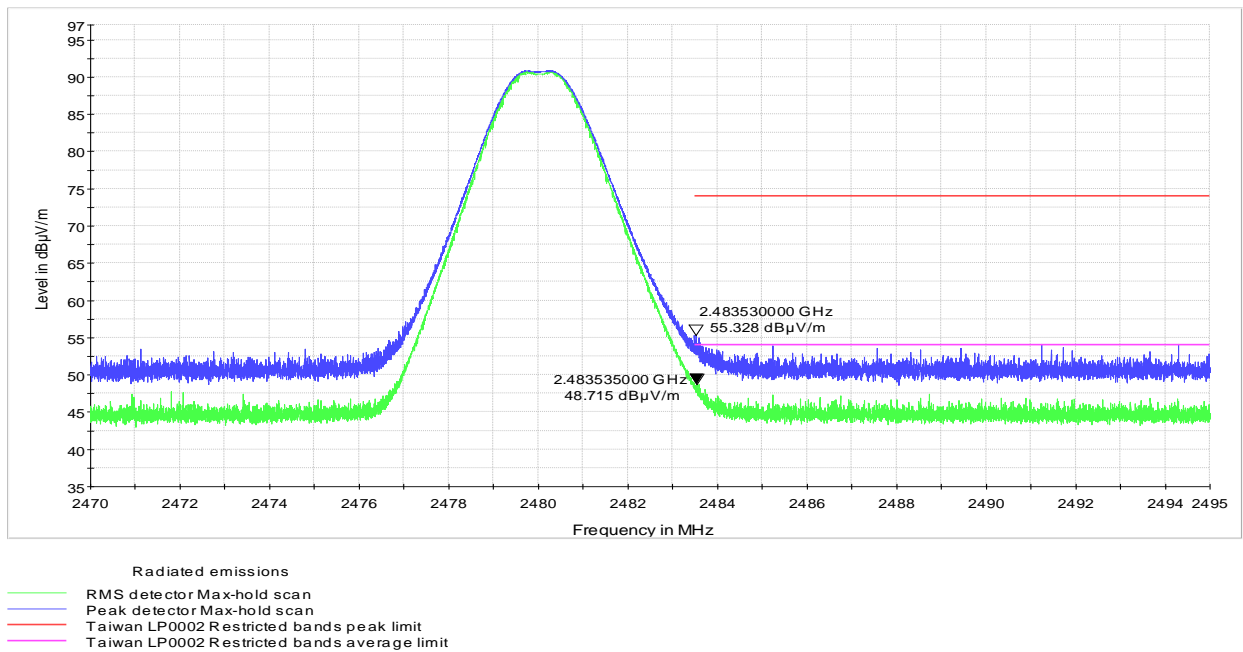

Figure 8.6-19: Radiated spurious emissions within restricted bands at the upper band edge

8.7 FCC 15.247(e) and RSS-247 5.2(b) Power spectral density for digitally modulated devices

8.7.1 Definitions and limits

FCC:

For digitally modulated systems, the power spectral density conducted from the intentional radiator to the antenna shall not be greater than 8 dBm in any 3 kHz band during any time interval of continuous transmission. This power spectral density shall be determined in accordance with the provisions of paragraph (b) of this section. The same method of determining the conducted output power shall be used to determine the power spectral density.

ISED:

The transmitter power spectral density conducted from the transmitter to the antenna shall not be greater than 8 dBm in any 3 kHz band during any time interval of continuous transmission. This power spectral density shall be determined in accordance with the provisions of section 5.4(d), (i.e. the power spectral density shall be determined using the same method as is used to determine the conducted output power).

8.7.1 Test date

Start date June 25, 2018

8.7.2 Observations, settings and special notes

The test was performed using peak power density method. Spectrum analyser settings:

Resolution bandwidth:	3 kHz
Video bandwidth:	$\geq 3 \times \text{RBW}$
Frequency span:	2 MHz
Detector mode:	Peak
Trace mode:	Max-hold

8.7.3 Test data

Table 8.7-1: PSD measurements results

Frequency, MHz	PSD, dBm/3 kHz	PSD limit, dBm/3 kHz	Margin, dB
2402	-12.44	8.00	20.44
2440	-11.96	8.00	19.96
2480	-13.20	8.00	21.20

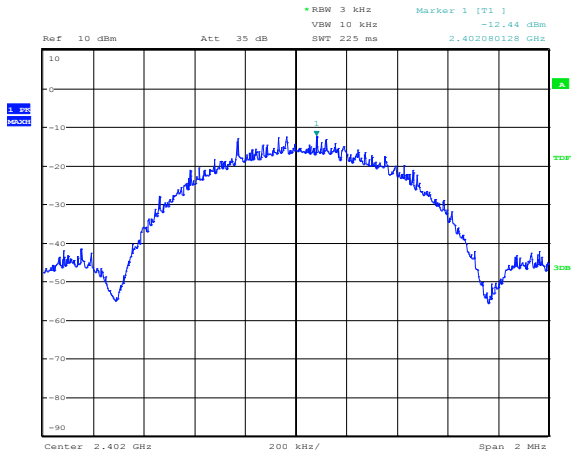

Date: 25.JUN.2018 15:48:53

Figure 8.7-1: PSD sample plot on low channel

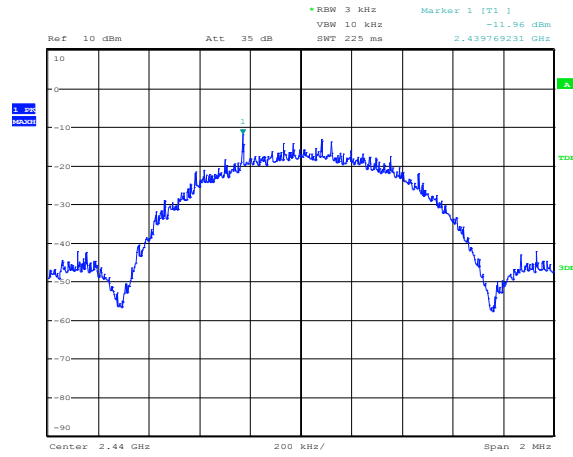

Date: 25.JUN.2018 15:49:28

Figure 8.7-2: PSD sample plot on mid channel

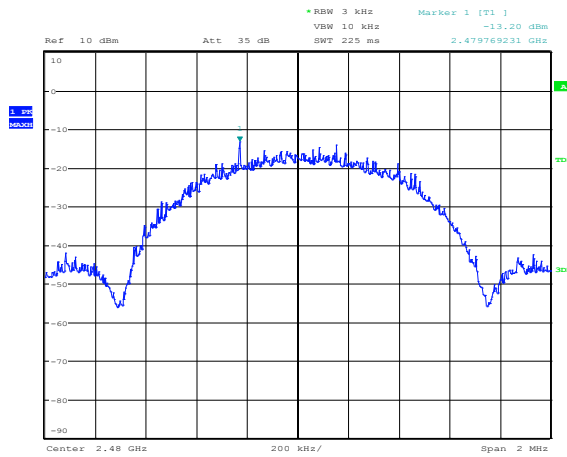

Date: 25.JUN.2018 15:50:06

Figure 8.7-3: PSD sample plot on high channel

Section 9. Block diagrams of test set-ups

9.1 Radiated emissions set-up for frequencies below 1 GHz

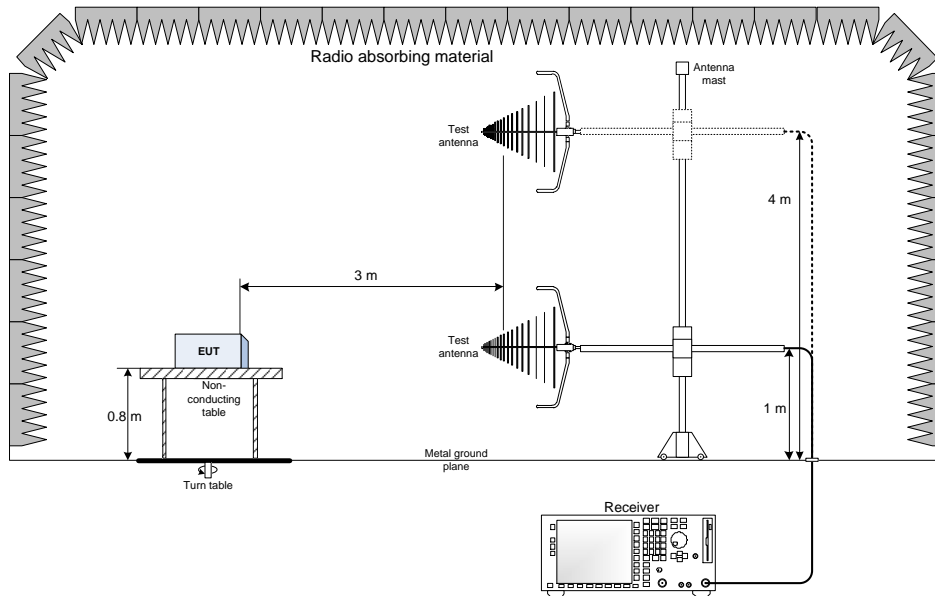

9.2 Radiated emissions set-up for frequencies above 1 GHz

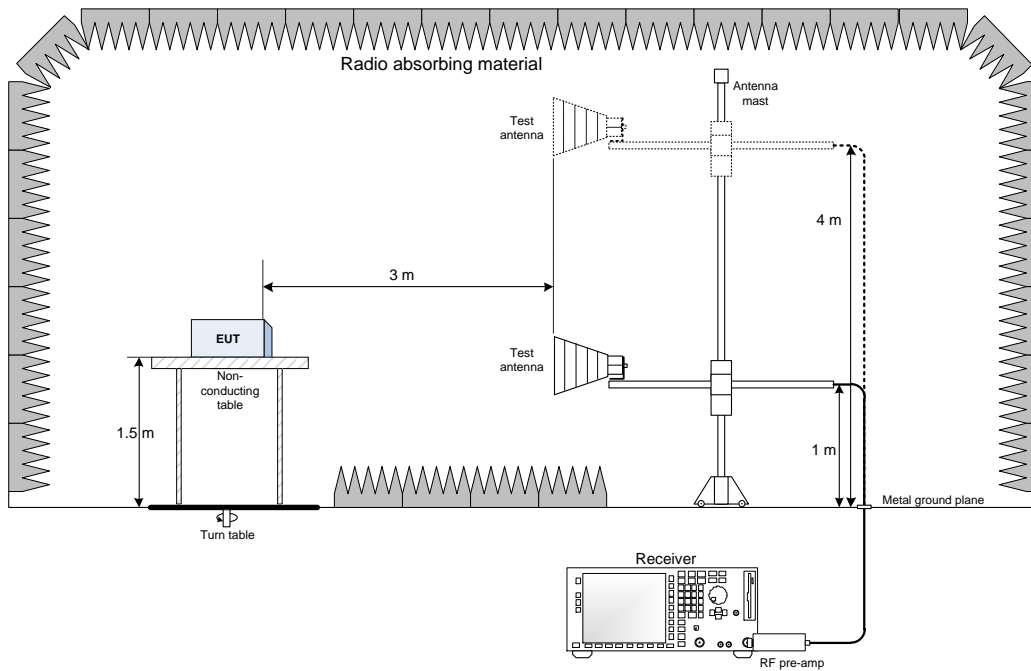

9.3 Antenna port set-up

