



Test Report Summary

FCC CFR 47, Part 27

Wireless Communications Service

Manufacturer: ADC Telecommunications

Name of Equipment: Spectrum 700Path 1/700Path 2 RFIC MIMO SRAU

Model Number(s): SPT-S1-7070-1-MIMO

Manufacturer's Address: 1187 Park Place
Shakopee, MN 55739

Test Report Number: MN110902_700P1_700P2 RFIC MIMO SRAU

Test Date(s): 17 August, 2011 (Intertek)
25 May, 2011 (ADC)
20 June, 2011 (ADC)
26, 29, & 30 August, 2011 (ADC)

According to testing performed at Intertek, the above-mentioned unit is in accordance with the applicable electromagnetic compatibility (EMC) portions of the requirements defined in FCC Part 27.

It is the manufacturer's responsibility to assure that additional production units of this model are manufactured with identical electrical and mechanical characteristics. Any modifications necessary for compliance made during testing on the above mentioned date(s) must be implemented in all production units for compliance to be maintained.

All testing was done in accordance with the Federal Communications Commission's CFR 47 Part 27. The EUT fulfills the requirements of the Federal Communications Commission's CFR 47 Part 27.

Date: 2 September, 2011

Location: Intertek Testing Services (INTERTEK)
7250 Hudson Blvd., Suite 100
Oakdale, MN 55128
Phone: (651) 730-1188
Fax: (651) 730-1282

ADC Telecommunications
1187 Park Place
Shakopee, MN 55379
Phone: (952) 403-8340
Fax: (952) 403-8858

Testing Conducted by (ADC):
And Report Written by:

Joshua J. Wittman
Compliance Engineer



1.0 TABLE OF CONTENTS

1.0	Table of Contents	3
2.0	Revision Description	4
3.0	Documentation	4
3.1	Test Regulations	4
3.2	Test Operation Mode	5
3.3	Configuration of the Device Under Test:	5
3.4	Product Options:	5
3.5	EUT Specifications and Requirements:	5
3.6	Cables:	5
3.7	Power Requirements:	5
3.8	Typical Installation and/or Operating Environment:	5
3.9	Other Special Requirements:	5
3.10	EUT Software:	5
3.11	EUT System Components	6
3.12	Support Equipment.....	6
3.13	Deviations from Standard:.....	6
3.14	General Remarks:	6
3.15	Summary:.....	6
4.0	Test Set-Up Drawings and Photos	7
4.1	Test Set-up Photo, Radiated Emissions.....	7
4.2	Test Set-up Drawings	9
5.0	Test Results	11
5.1.1	27.50 RF Power Limits.....	11
5.1.2	27.54 Frequency Stability	12
5.1.3	27.53 Emission Limitations	13
6.0	Test Equipment	14
7.0	Appendix A	15
7.1	Conducted Emission Limits Test	16
7.2	Conducted Output Power Test.....	69
7.3	Frequency Stability Test.....	72
7.4	Intermodulation Test	74
7.5	Occupied Bandwidth Modulation Test	129
8.0	Appendix B	148
9.0	Appendix C	150



2.0 REVISION DESCRIPTION

Rev	Total Pages	Date	Description
A	151	2 September, 2011	Original Release

3.0 DOCUMENTATION

3.1 Test Regulations

- 27.50 Power limits
- 27.53 Emission limits
- 27.54 Frequency stability

The emissions tests were performed according to the following regulations:

- FCC Part 22
- FCC Part 24
- FCC Part 27**
- FCC Part 90
- IC RSS-131 Issue 2

Environmental Conditions in the lab:

ADC

Temperature: 24° C
Relative Humidity: 21%
Atmospheric Pressure: 98.8 kPa

Intertek

15-35° C
30-60%
86-106 kPa

Power Supply Utilized:

Power Supply System : 1 phase, 60 Hz, 120 VAC

3.2 Test Operation Mode

- Standby
- Test Program
- Practice Operation

■ Max composite in and out

3.3 Configuration of the Device Under Test:

Normal Operation – 700 – 728 to 756 MHz (728 to 746 MHz (Lower ABC) 746 to 756 MHz (Upper C))

3.4 Product Options:

None

3.5 EUT Specifications and Requirements:

Length: 11.50"
Width: 9.00"
Height: 3.50"
Weight: 7.49 pounds

3.6 Cables:

Cable Type	Length	From	To
RF	> 3M	Ancillary Equip	EUT
RF	< 3M	EUT	50 Ohm Load
Power (2)	< 3M	Power	Input Power (Ancillary)
Coax (75 Ohm)	> 3M	Ancillary Equip	EUT

3.7 Power Requirements:

Voltage: 54 VDC

3.8 Typical Installation and/or Operating Environment:

Indoor. System is typically employed as an indoor repeater/booster.

3.9 Other Special Requirements:

None

3.10 EUT Software:

Revision Level: Version V.6 or greater
Description: Internet Explorer

3.11 EUT System Components

Description	Model #	Serial #	FCC ID #
Prism Host Unit	FWP-0000HUII	None	
Spectrum DRU	SPT-0000DRUII	None	
Spectrum IFEU	742735-0	None	
Spectrum Power Supply	LTPCPR1U3C-Z-527		
Remote Access Unit	<u>SPT-S1-7070-1-MIMO</u>	None	

3.12 Support Equipment

Description	Manufacturer	Model #	FCC ID #
Power Meter	HP	437B	
Signal Generator	Agilent	8648C	

3.13 Deviations from Standard:

Modifications required to pass:

As indicated on the data sheet(s)

■ **None**

Test Specification Deviations; Additions to or Exclusions from:

As indicated in the Test Plan

■ **None**

3.14 General Remarks:

None.

3.15 Summary:

The requirements according to the technical regulations are

■ **met**

not Met

The equipment under test does

■ **fulfill the general approval requirements mentioned in Section 3.1.**

not fulfill the general approval requirements mentioned in Section 3.1.

4.0 TEST SET-UP DRAWINGS AND PHOTOS

[Table of Contents: Section 1.0](#)

4.1 Test Set-up Photo, Radiated Emissions



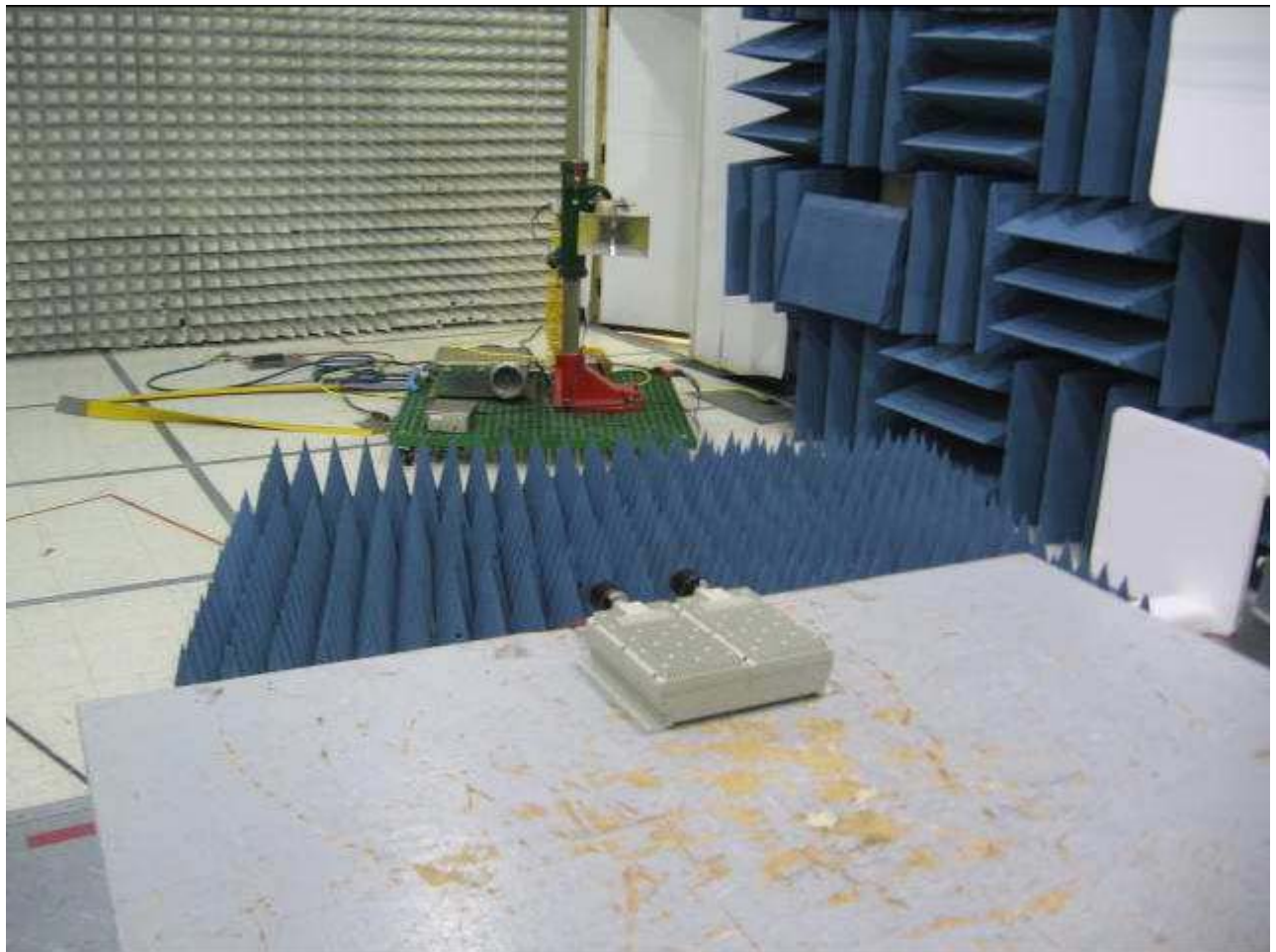

4.2 Test Set-up Drawings

Conducted and Radiated Emission Limits Test

Conducted Output Power Test

Inter-Modulation Test

Occupied Bandwidth Modulation Test

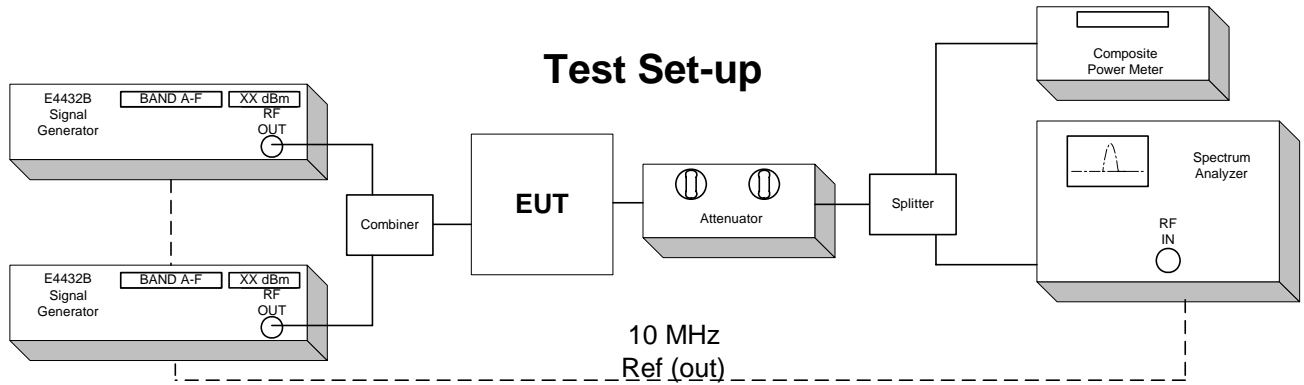

Frequency Tolerance Test

The Host, DRU, and IFEU EUT are specified for indoor use with temperature range of 0° to +50° C, and were tested within their range.

The Remote Access Unit EUT is specified for indoor use with temperature range of -25° to +50° C, and was tested with its range.

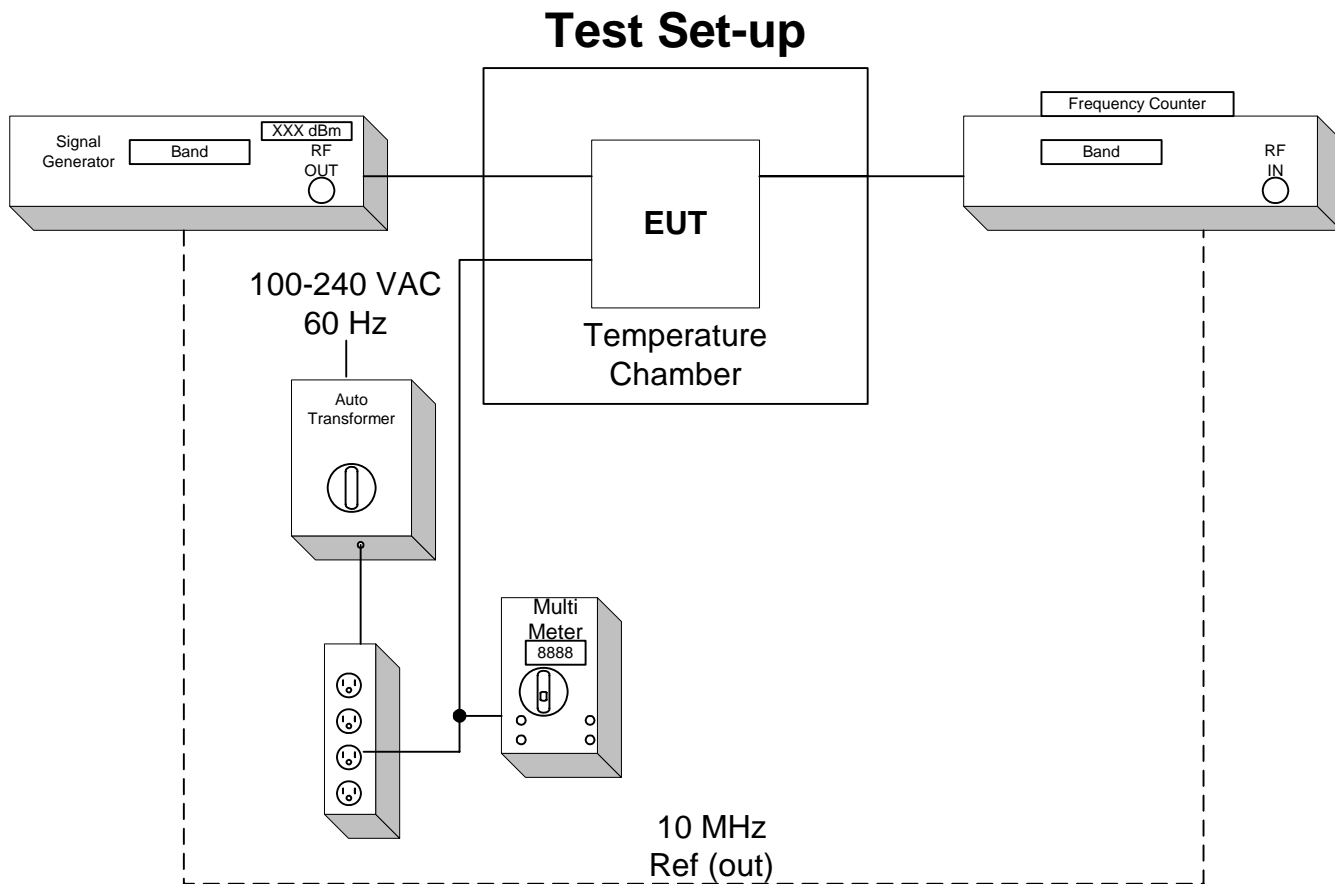

5.0 TEST RESULTS

5.1.1 27.50 RF Power Limits

Test Summary:

- The requirements are: **■ MET** □ NOT MET
- Minimum margin of compliance is 17.29 dB at 737.0 MHz(LTE 1.4 MHz)(LowerABC)(Path1)
- Minimum margin of compliance is 17.95 dB at 737.0 MHz(LTE 3 MHz)(LowerABC)(Path1)
- Minimum margin of compliance is 17.99 dB at 737.0 MHz(LTE 5 MHz)(LowerABC)(Path1)
- Minimum margin of compliance is 17.02 dB at 737.0 MHz(LTE 10 MHz)(LowerABC)(Path1)
- Minimum margin of compliance is 16.73 dB at 735.5 MHz(LTE 15 MHz)(LowerABC)(Path1)
- Minimum margin of compliance is 16.85 dB at 746.7 MHz(LTE 1.4 MHz)(UpperC)(Path1)
- Minimum margin of compliance is 17.01 dB at 747.5 MHz(LTE 3 MHz)(UpperC)(Path1)
- Minimum margin of compliance is 17.21 dB at 748.5 MHz(LTE 5 MHz)(UpperC)(Path1)
- Minimum margin of compliance is 16.44 dB at 751 MHz(LTE 10 MHz)(UpperC)(Path1)
- Minimum margin of compliance is 16.55 dB at 737.0 MHz(LTE 1.4 MHz)(LowerABC)(Path2)
- Minimum margin of compliance is 17.86 dB at 737.0 MHz(LTE 3 MHz)(LowerABC)(Path2)
- Minimum margin of compliance is 16.44 dB at 737.0 MHz(LTE 5 MHz)(LowerABC)(Path2)
- Minimum margin of compliance is 16.41 dB at 737.0 MHz(LTE 10 MHz)(LowerABC)(Path2)
- Minimum margin of compliance is 16.10 dB at 735.5 MHz(LTE 15 MHz)(LowerABC)(Path2)
- Minimum margin of compliance is 16.56 dB at 751.0 MHz(LTE 1.4 MHz)(UpperC)(Path2)
- Minimum margin of compliance is 17.18 dB at 751.0 MHz(LTE 3 MHz)(UpperC)(Path2)
- Minimum margin of compliance is 16.32 dB at 753.5 MHz(LTE 5 MHz)(UpperC)(Path2)
- Minimum margin of compliance is 16.04 dB at 751.0 MHz(LTE 10 MHz)(UpperC)(Path2)

Test Location:

- INTERTEK (Oakdale, MN)
- **ADC facility (Shakopee, MN)**

Test Distance:

- 3 Meters
- 10 Meters

■ Conducted measurement

Test Equipment (ADC):

1, 2, 6, 7, 12

Test Limit:

100 Watts or 50 dBm Limit

Test Data:

[Conducted Output Power; Section 7.2](#)

[Table of Contents; Section 1.0](#)

Test Engineer: Joshua J. Wittman

Date: 25 May, 2011

26, 29, & 30 August, 2011

5.1.2 27.54 Frequency Stability

Test Summary:

- The requirements are: **MET** NOT MET
- The fundamental emission stays within the limit.
- Frequency measured over a temperature range of –25 to 50° C and an input voltage range of 100 to 240 VAC.

Test Location:

- INTERTEK (Oakdale, MN)
- ADC facility (Shakopee, MN)**

Test Equipment (ADC):

3, 4, 5, 6, 9,11,12

Test Limit:

The frequency stability shall be sufficient to ensure that the fundamental emission stays within the authorized frequency block.

Test Data:

[Frequency Stability; Section 7.3](#)

[Table of Contents; Section 1.0](#)

Test Engineer: Joshua J. Wittman

Date: 25 May, 2011

Date: 26 August, 2011

5.1.3 27.53 Emission Limitations

Test Summary:

- The requirements are: **MET** NOT MET
- Out of band emissions were less than -13 dBm.
- Outside the emission bandwidth of the carrier, all emissions are attenuated at least 26 dB below the transmitter power.

Test Location:

- INTERTEK (Oakdale, MN)
- ADC facility (Shakopee, MN)**

Test Equipment (ADC):

1, 2, 6, 7, 12, 13

Test Limit:

Out of band emissions:

Attenuated below the transmitting power (P) by a factor of at least $43 + 10\log(P)$ dB, or -13 dBm.

Outside of the carrier emissions bandwidth:

26 dB below the transmitter power

Test Data:

[Conducted Emissions; Section 7.1](#)

[Intermodulation; Section 7.4](#)

[Occupied Bandwidth; Section 7.5](#)

Radiated Emissions; ([Appendix B](#))

Test Engineer: Joshua J. Wittman

Date: 14, 15, 20 June, 2011 & 26, 30, Aug, 2011

Date: 25 May, 2011 & 29 August, 2011

Date: 25 May, 2011 & 26 August, 2011

[Table of Contents; Section 1.0](#)

6.0 TEST EQUIPMENT

[Table of Contents: Section 1.0](#)

Number	Description	Manufacturer	Model	ADC TELECOMMUNICATIONS Serial Number	Cal Due	Used
1	Spectrum Analyzer	HP	8563E	MC27690	12-15-11	<input checked="" type="checkbox"/>
2	Power Meter	HP	437B	MC54002	5-18-12	<input checked="" type="checkbox"/>
3	Multimeter	Fluke	79	MC16178	9-30-11	<input checked="" type="checkbox"/>
4	Frequency Counter	HP	5347A	MC27569	6-30-12	<input checked="" type="checkbox"/>
5	Temperature Chamber	ESPEC	PSL-4G	MC10075	8-30-11	<input checked="" type="checkbox"/>
6	Signal Generator	Aeroflex	3413	MC57343	11-9-12	<input checked="" type="checkbox"/>
7	Signal Generator	Aeroflex	3413	MC57947	9-30-11	<input checked="" type="checkbox"/>
8	Variable Auto Transformer	Staco	1520CT	MC44655	CNR	<input checked="" type="checkbox"/>
9	Digital Barometer	Fisher Scientific	02-403	MC50719	1-20-12	<input checked="" type="checkbox"/>
10	Attenuator	Aeroflex	49-30-33	N/A	CNR	<input checked="" type="checkbox"/>
11	Attenuator	Aeroflex	86-30-12	N/A	CNR	<input checked="" type="checkbox"/>
12	RF Power Sensor	Agilent	8481A	MC27649	6-30-12	<input checked="" type="checkbox"/>
13	Spectrum Analyzer	Rhode & Schwarz	FSQ-8	MC54251	4-20-12	<input checked="" type="checkbox"/>

Equipment with a Calibration Not Required (CNR) listing is verified and compensated for with NIST traceable calibrated equipment.

7.0

APPENDIX A

Conducted Emissions Test Data

[Table of Contents: Section 1.0](#)

Test Engineer: Joshua J. Wittman

7.1 Conducted Emission Limits Test

[Table of Contents: Section 1.0](#)

[Back to Emission Limits: Section 5.1.3](#)

The out of band emissions were measured directly from the EUT antenna output in the TX path using a spectrum analyzer from 30 MHz to the 10th harmonic of the highest carrier frequency. Test signals used are LTE 1.4 MHz, 3 MHz, 5MHz, 10MHz, & 15MHz Channel Bandwidths. The different signals were input one at a time to the EUT. In all cases, the out of band emissions were less than -13 dBm from the equation

$$(19\text{dBm} - [43 + 10\log(0.08\text{W})])$$

Band edge compliance is also demonstrated using a LTE 1.4 MHz, 3 MHz, 5MHz, 10MHz, & 15MHz Channel Bandwidths signal at the upper and lower limits of the band.

The Prism Host, Spectrum DRU, and Spectrum IFEU are Part 15 devices and have been tested and are compliant as such.

Industry practice has generally set the input signal power level. Test signal used was \approx -11 dBm input to Prism Host in the TX Path.

Industry practice has generally set the output signal power level.

Prism Host:	Spectrum DRU:	Spectrum IFEU	Remote Access Unit(RAU):
Range: 21 - 60 VDC	Range: 21 - 60 VDC	Range: 54 VDC	Range: 54 VDC
Tested @: 54 VDC	Tested @: 54 VDC	Tested @: 54 VDC	Tested @: 54 VDC

Application details for 2.1033(c)(10), and 2.1033(c)(13):

Final RF Amplifier Input DC Voltage and Current: 7.3V at 400mA

PLL creates all the Local Oscillators that convert signal to IF and RF signals. When PLL is unlocked the band is shut down, this is to avoid transmission of any incorrect frequency.

Internal to the electronics, the use of SAW filters provides for higher Q roll-off at band edges.

This equipment does not modulate the RF, so there is no modulation limiter. This equipment does not change the modulation of the RF or the occupied bandwidth of any channel. It transports the signal, as is, over TV (IF) coax cable. The RF input is not changed in the RF output.

This is a constant gain device, so the setup controls the output. There is an overdrive and overpower limit control that prevents excess power.

27.53(c)(3) On all frequencies between 763-775 MHz and 793-805 MHz, by a factor not less than $76 + 10 \log (P)$ dB in a 6.25 kHz band segment, for base and fixed stations;

27.53(c)(4) On all frequencies between 763-775 MHz and 793-805 MHz, by a factor not less than $65 + 10 \log (P)$ dB in a 6.25 kHz band segment, for mobile and portable stations;

27.53(c)(6) Compliance with the provisions of paragraphs (c)(3) and (c)(4) of this section is based on the use of measurement instrumentation such that the reading taken with any resolution bandwidth setting should be adjusted to indicate spectral energy in a 6.25 kHz segment.

27.53(f) For operations in the 746-763 MHz, 775-793 MHz, and 805-806 MHz bands, emissions in the band 1559-1610 MHz shall be limited to -70 dBW/MHz equivalent isotropically radiated power (EIRP) for wideband bandwidth. For the purpose of equipment authorization, a transmitter shall be tested with an antenna that is representative of the type that will be used with the equipment in normal operation.

LTE 10MHz Channel Bandwidth modulation was used on all plots regarding the above specifications regarding Part 27.53 (c) and (f).

Results:

Pass (See plots)

Conducted Emissions LTE 1.4 MHz Channel Bandwidth Spectrum 700 MHz Lower ABC Path 1
Center: 737 MHz Span: 5 MHz RBW/VBW: 100 kHz

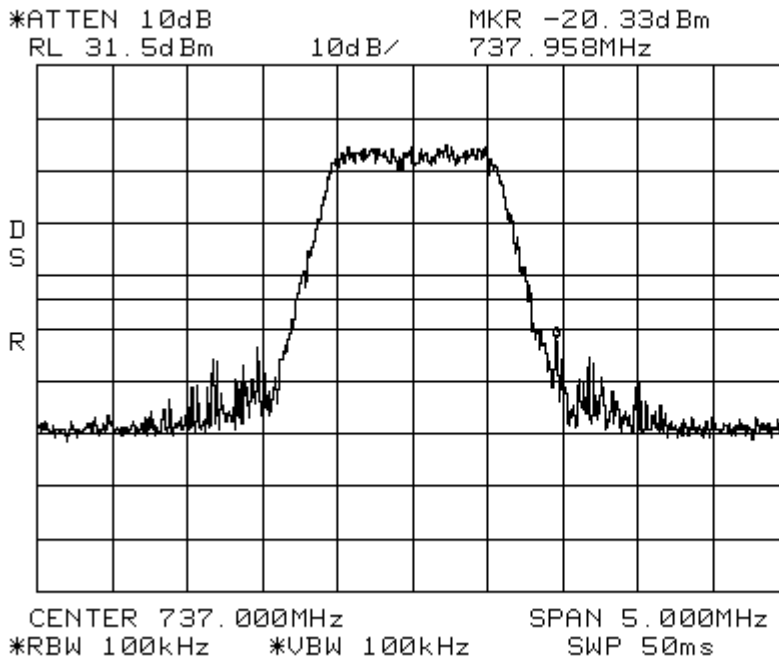

Conducted Emissions LTE 1.4 MHz Channel Bandwidth Spectrum 700 MHz Lower ABC Path 1
Span: 30 MHz to 1 GHz RBW/VBW: 300 kHz

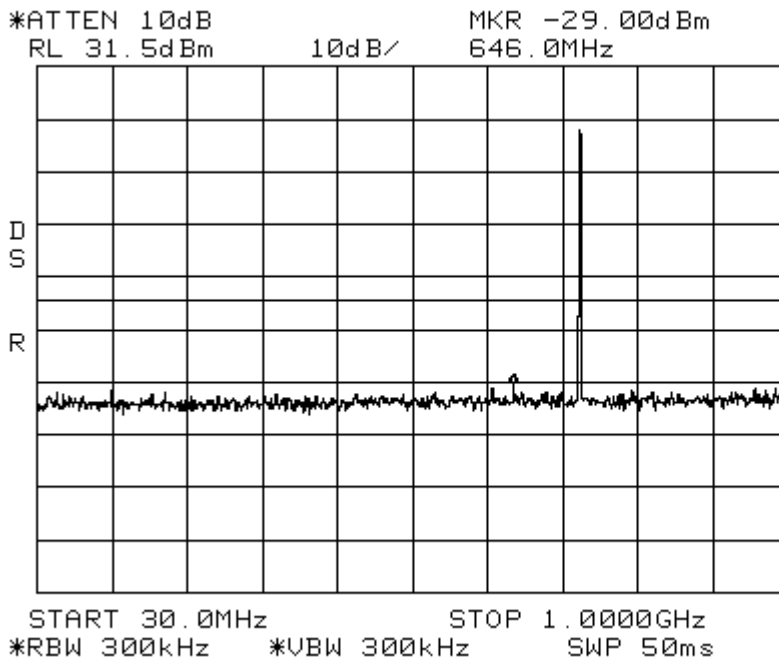

Conducted Emissions LTE 5 MHz Channel Bandwidth Spectrum 700 MHz Lower ABC Path 1
 Center: 737 MHz Span: 10 MHz RBW/VBW: 100 kHz
 *ATTEN 10dB MKR -26.83dBm
 RL 31.5dBm 10dB/ 734.37MHz

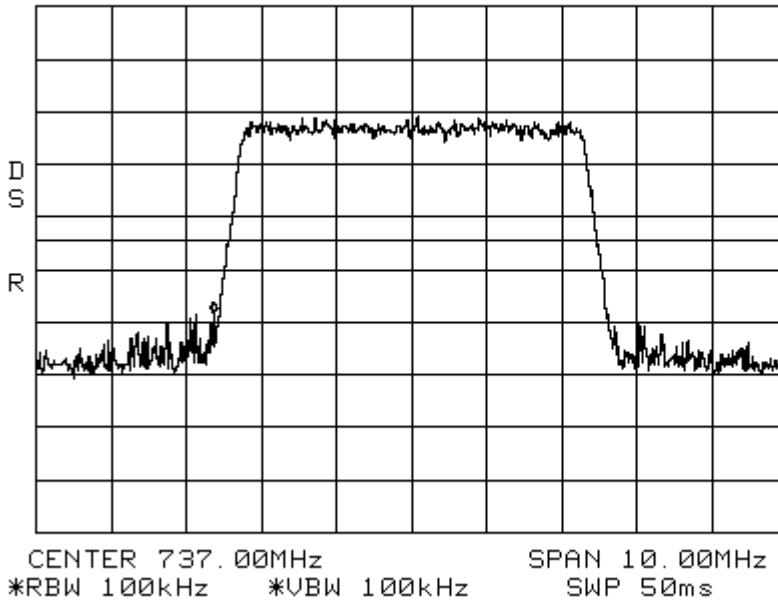

Conducted Emissions LTE 5 MHz Channel Bandwidth Spectrum 700 MHz Lower ABC Path 1
 Span: 30 MHz to 1 GHz RBW/VBW: 300 kHz

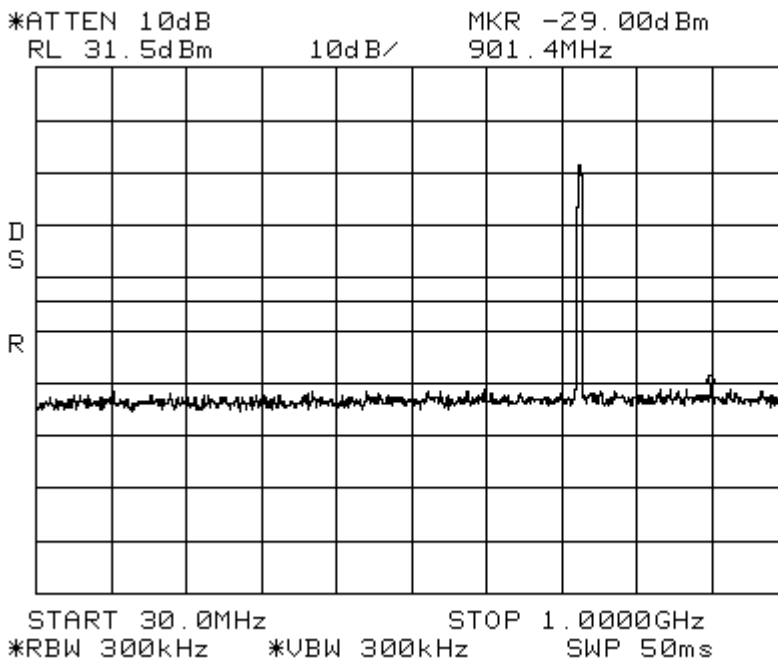

Conducted Emissions LTE 5 MHz Channel Bandwidth Spectrum 700 MHz Lower ABC Path 1
Span: 1 GHz to 10 GHz RBW/VBW: 1 MHz

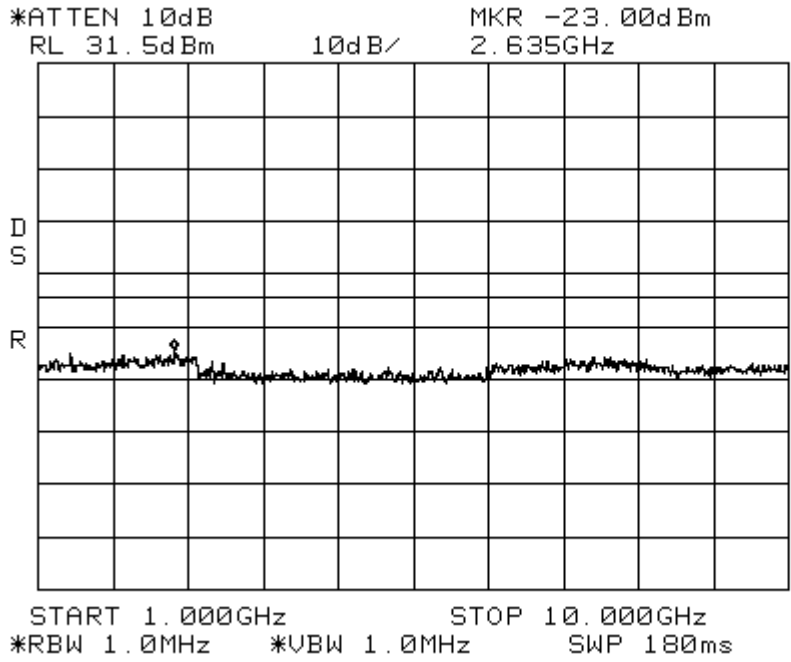

Conducted Emissions LTE 10 MHz Channel Bandwidth Spectrum 700 MHz Lower ABC Path 1
Center: 737 MHz Span: 20MHz RBW/VBW: 100 kHz

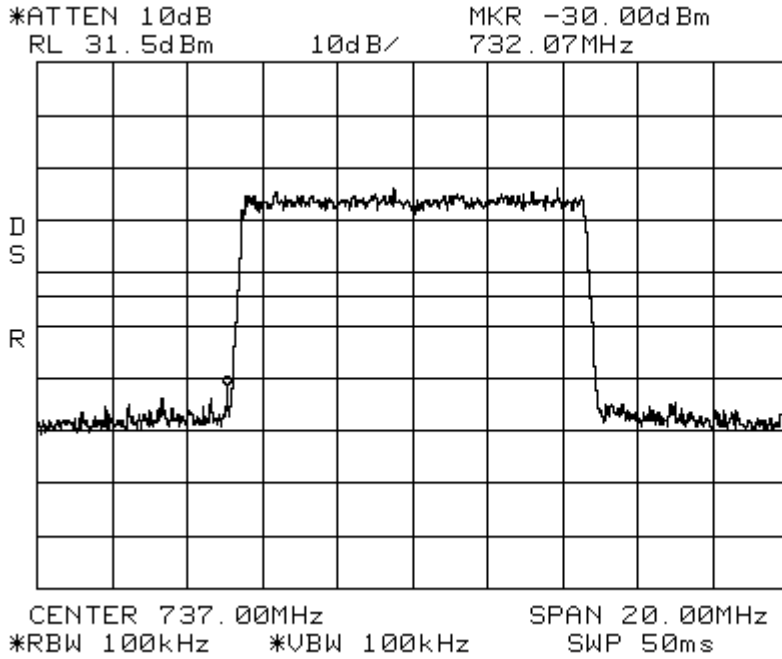

Conducted Emissions LTE 15 MHz Channel Bandwidth Spectrum 700 MHz Lower ABC Path 1
Center: 737 MHz Span: 50 MHz RBW/VBW: 100 kHz

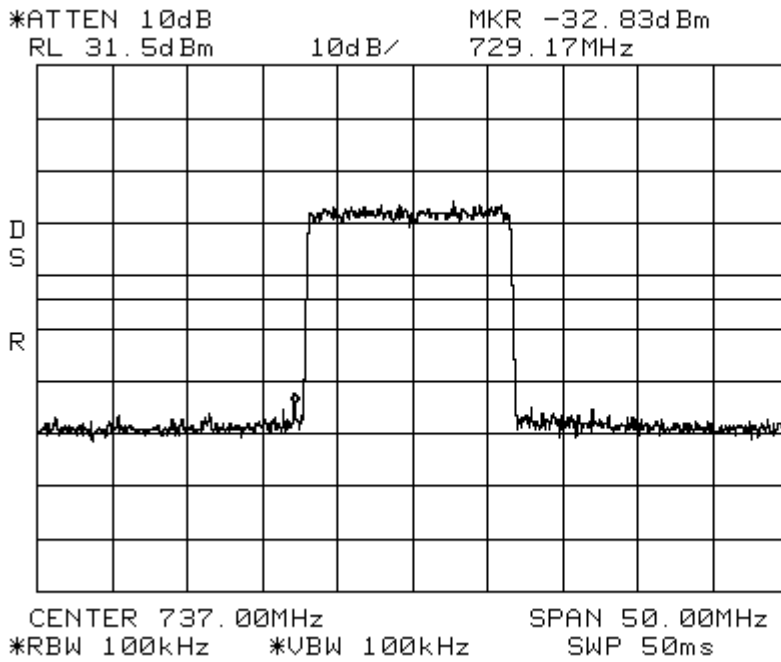

Conducted Emissions LTE 15 MHz Channel Bandwidth Spectrum 700 MHz Lower ABC Path 1
Span: 30 MHz to 1 GHz RBW/VBW: 300 kHz

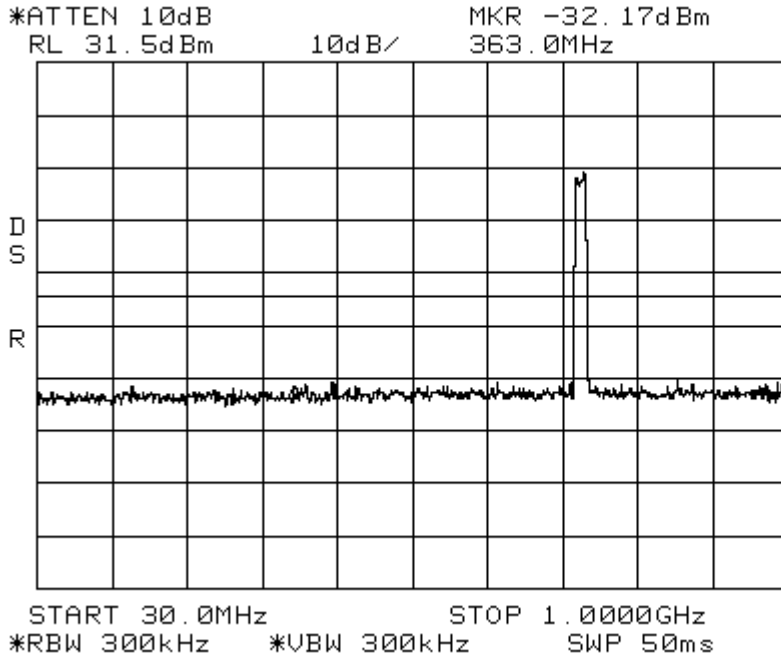

Conducted Emissions LTE 3 MHz Channel Bandwidth Spectrum 700 MHz Upper C Path 1
 Center: 751 MHz Span: 5 MHz RBW/VBW: 100 kHz
 *ATTEN 10dB MKR -28.83dBm
 RL 31.5dBm 10dB/ 748.717MHz

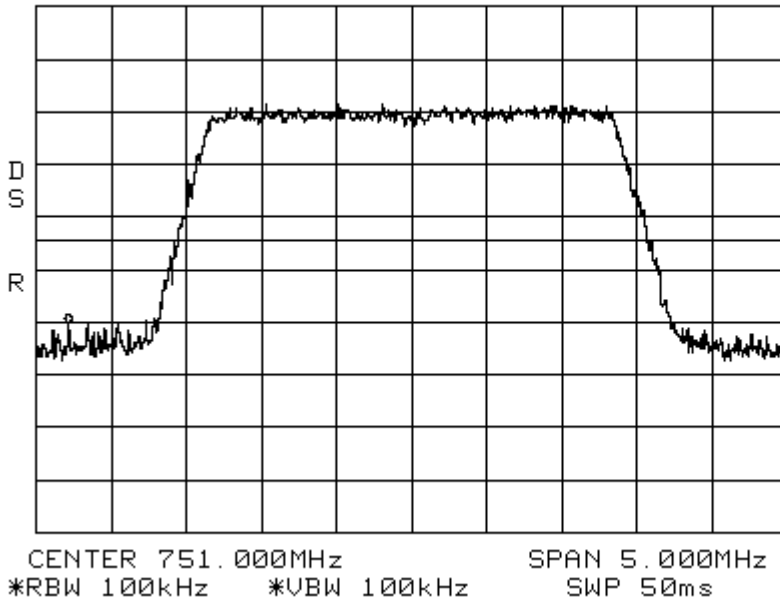

Conducted Emissions LTE 3 MHz Channel Bandwidth Spectrum 700 MHz Upper C Path 1
 Span: 30 MHz to 1 GHz RBW/VBW: 300 kHz

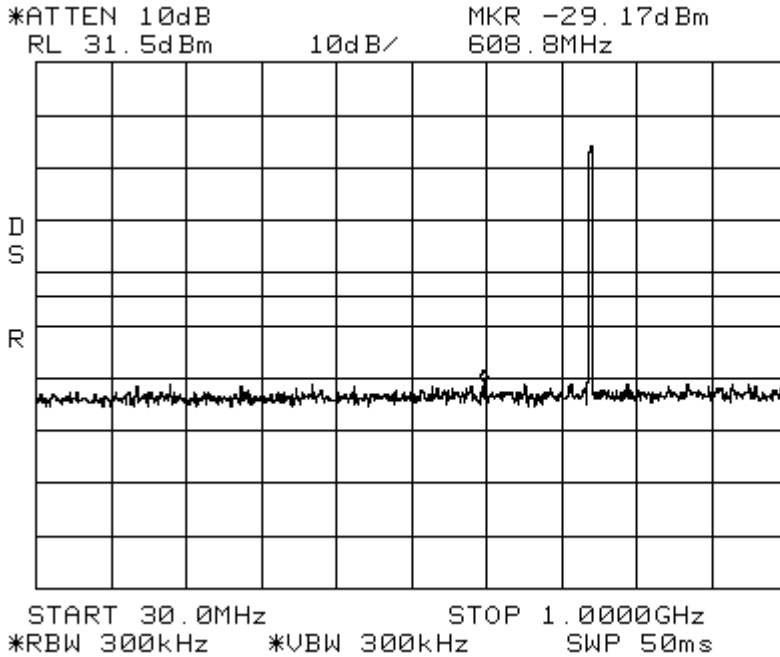

Conducted Emissions LTE 10 MHz Channel Bandwidth Spectrum 700 MHz Upper C Path 1
Center: 751 MHz Span: 20MHz RBW/VBW: 100 kHz

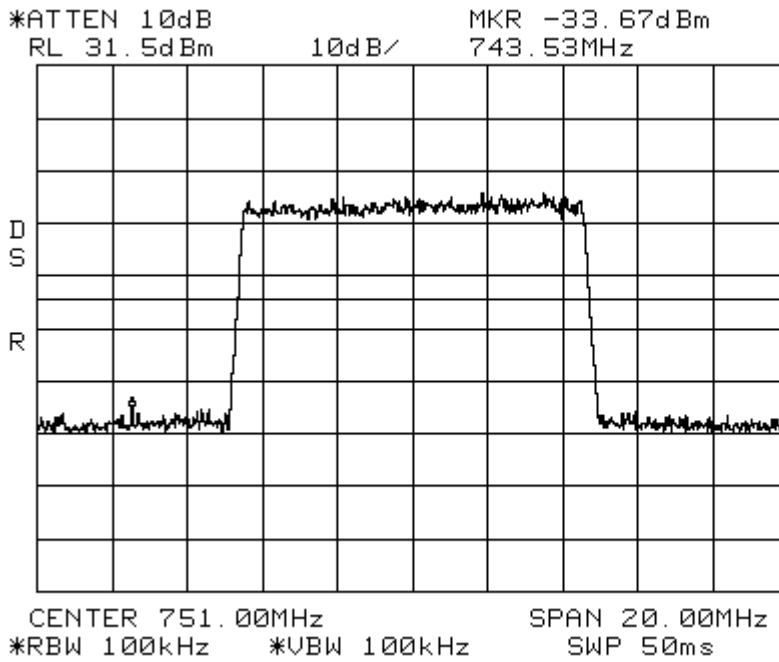

Conducted Emissions LTE 10 MHz Channel Bandwidth Spectrum 700 MHz Upper C Path 1
Span: 30 MHz to 1 GHz RBW/VBW: 300 kHz

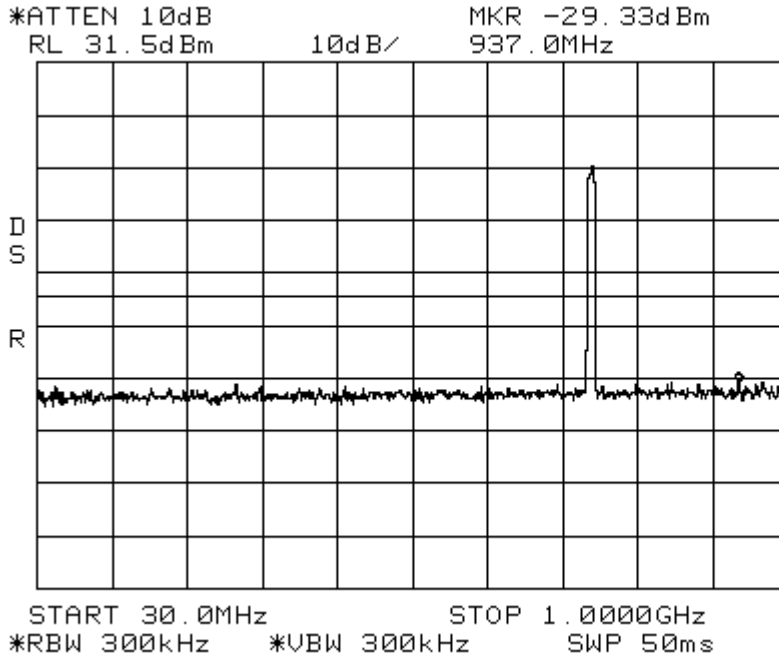

Conducted Emissions LTE 3 MHz Channel Bandwidth Spectrum 700 MHz Lower ABC Path 2
 Center: 737 MHz Span: 5 MHz RBW/VBW: 100 kHz
 ATTEN 10dB MKR -25.17dBm
 RL 41.0dBm 10dB/ 734.775MHz

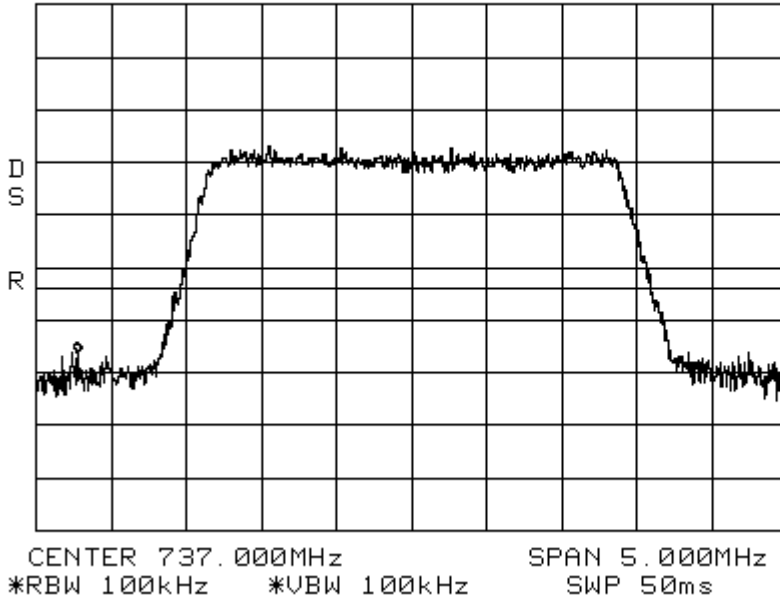

Conducted Emissions LTE 3 MHz Channel Bandwidth Spectrum 700 MHz Lower ABC Path 2
 Span: 30 MHz to 1 GHz RBW/VBW: 300 kHz

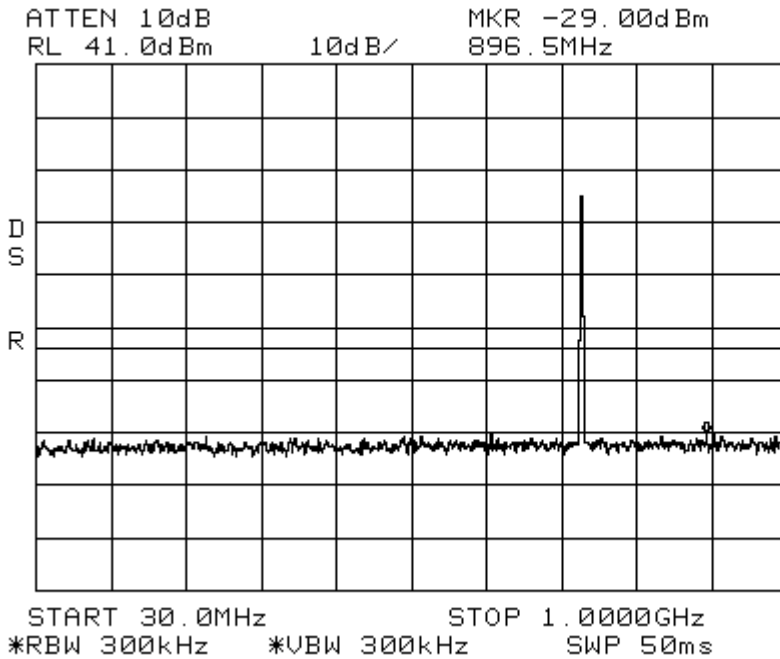

Conducted Emissions LTE 3 MHz Channel Bandwidth Spectrum 700 MHz Lower ABC Path 2
Span: 1 GHz to 10 GHz RBW/VBW: 1 MHz

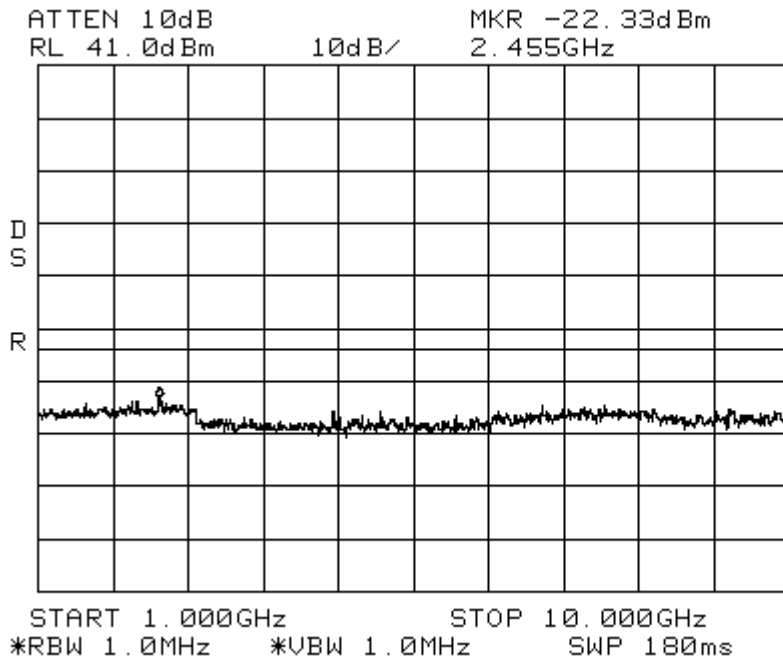

Conducted Emissions LTE 5 MHz Channel Bandwidth Spectrum 700 MHz Lower ABC Path 2
Center: 737 MHz Span: 10 MHz RBW/VBW: 100 kHz

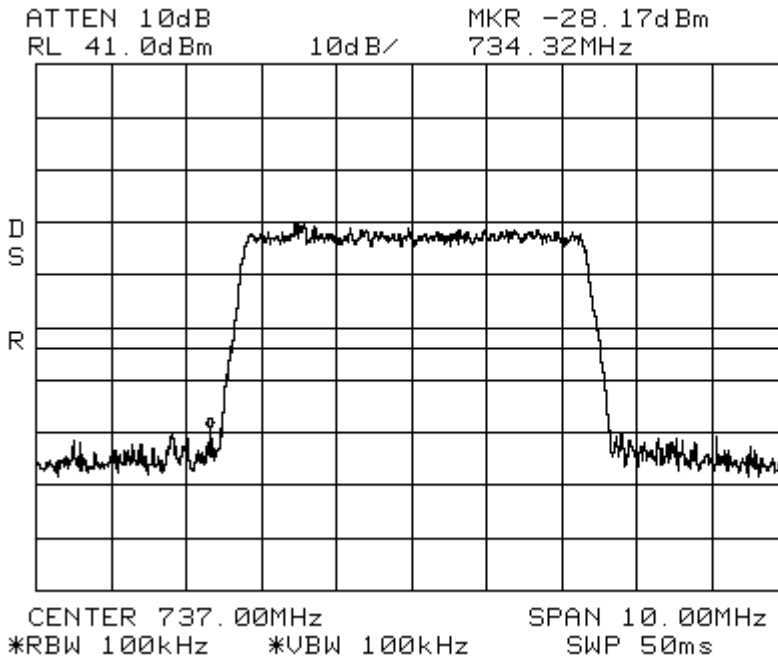

Conducted Emissions LTE 5 MHz Channel Bandwidth
Span: 30 MHz to 1 GHz

Spectrum 700 MHz Lower ABC Path 2
RBW/VBW: 300 kHz

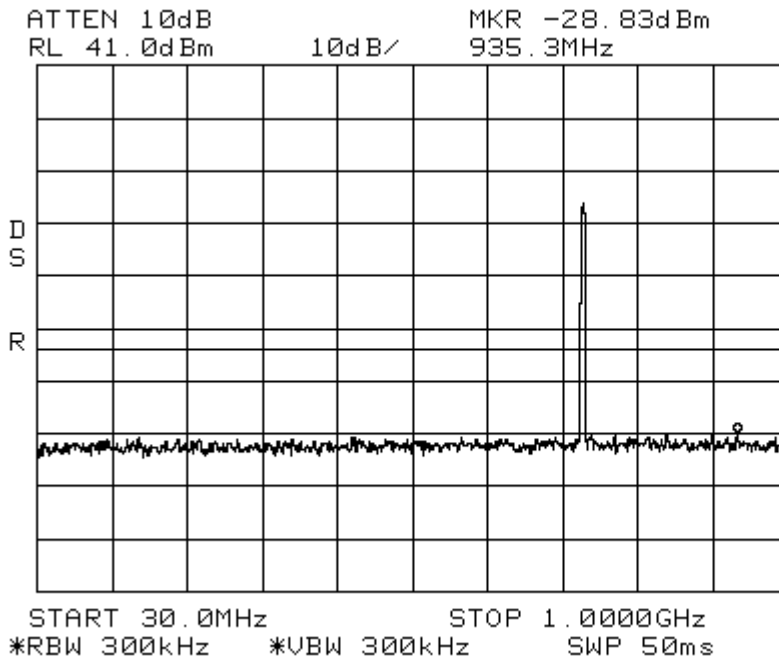

Conducted Emissions LTE 5 MHz Channel Bandwidth
Span: 1 GHz to 10 GHz

Spectrum 700 MHz Lower ABC Path 2
RBW/VBW: 1 MHz

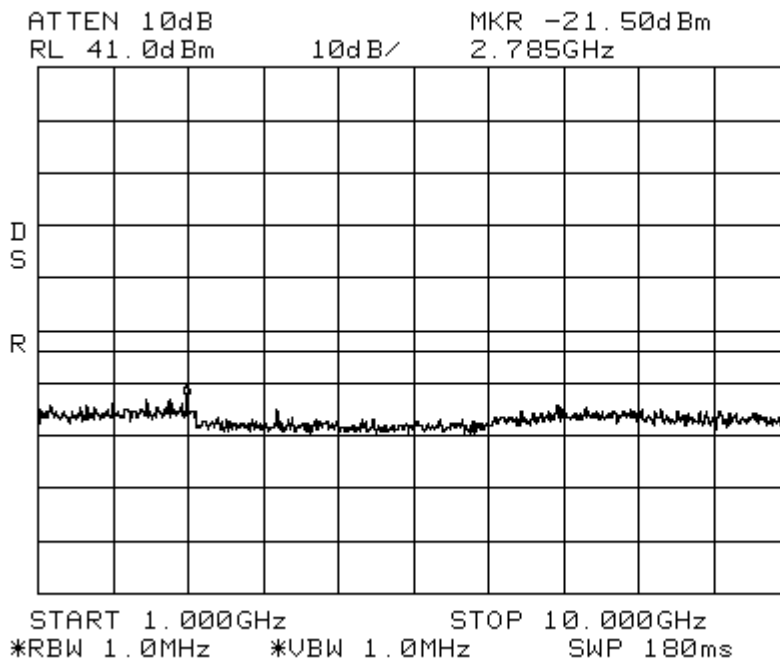

Conducted Emissions LTE 10 MHz Channel Bandwidth Spectrum 700 MHz Lower ABC Path 2
Center: 737 MHz Span: 20MHz RBW/VBW: 100 kHz

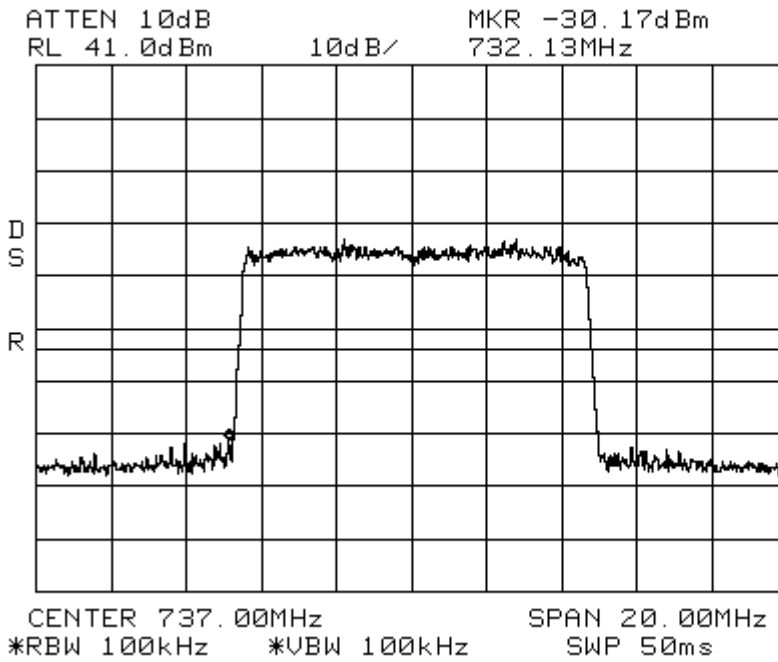

Conducted Emissions LTE 10 MHz Channel Bandwidth Spectrum 700 MHz Lower ABC Path 2
Span: 30 MHz to 1 GHz RBW/VBW: 300 kHz

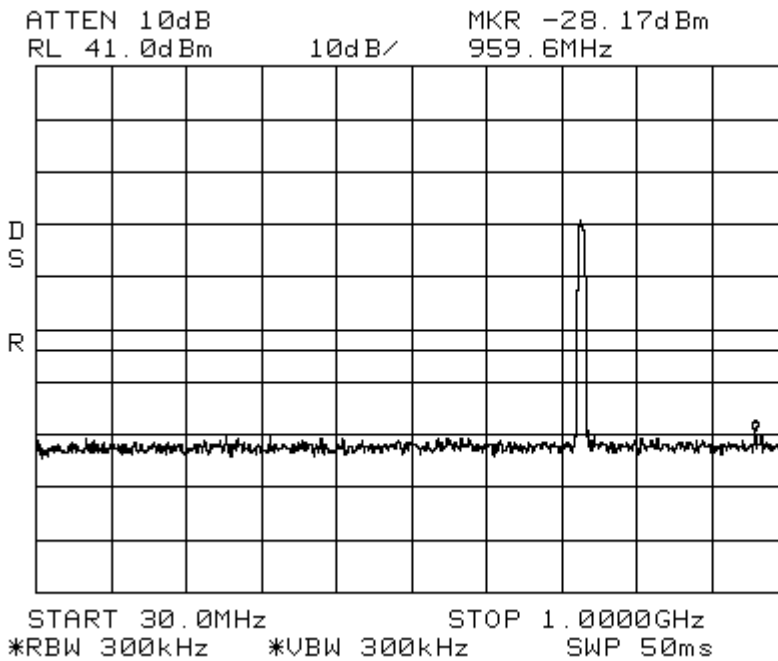

Conducted Emissions LTE 10 MHz Channel Bandwidth Spectrum 700 MHz Lower ABC Path 2
Span: 1 GHz to 10 GHz RBW/VBW: 1 MHz

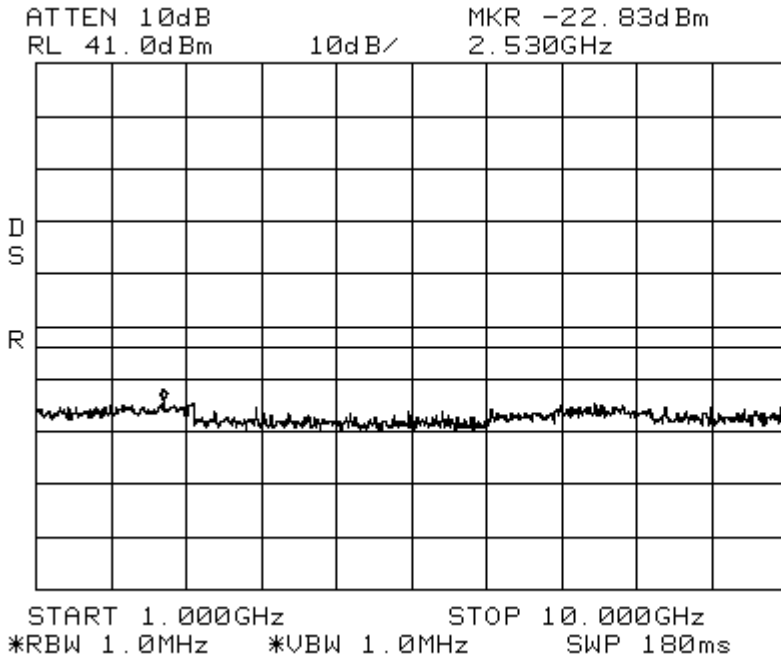

Conducted Emissions LTE 15 MHz Channel Bandwidth Spectrum 700 MHz Lower ABC Path 2
Center: 737 MHz Span: 50 MHz RBW/VBW: 100 kHz

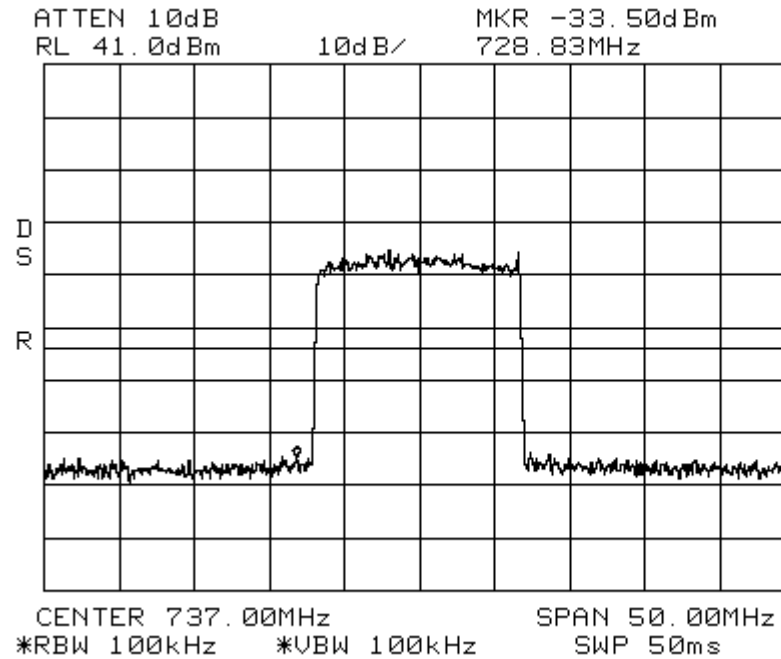

Conducted Emissions LTE 1.4 MHz Channel Bandwidth Spectrum 700 MHz Upper C Path 2
Center: 751 MHz Span: 5 MHz RBW/VBW: 100 kHz

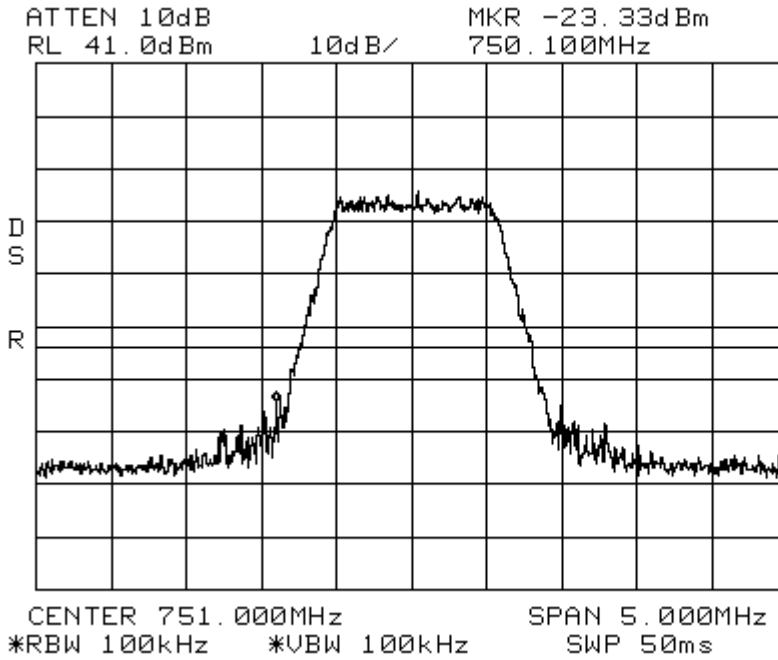

Conducted Emissions LTE 1.4 MHz Channel Bandwidth Spectrum 700 MHz Upper C Path 2
Span: 30 MHz to 1 GHz RBW/VBW: 300 kHz

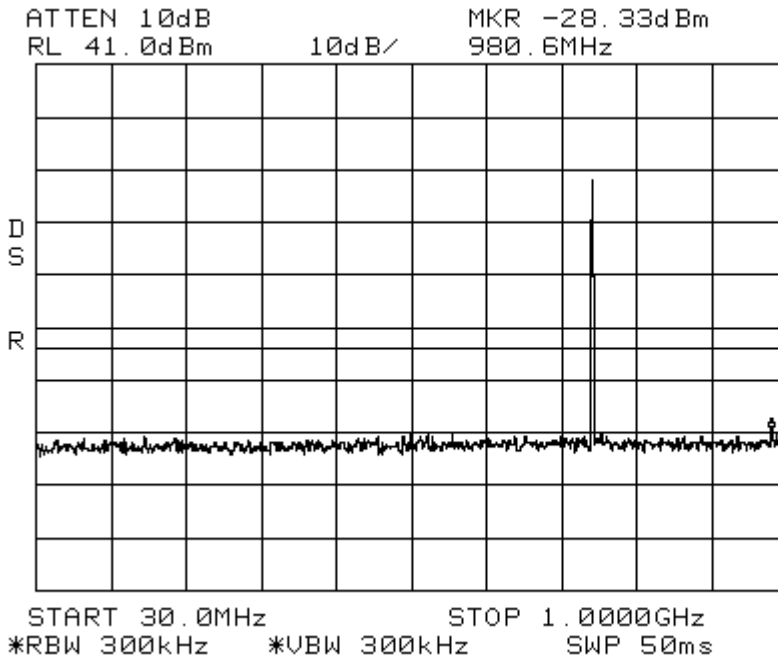

Conducted Emissions LTE 1.4 MHz Channel Bandwidth Spectrum 700 MHz Upper C Path 2
Span: 1 GHz to 10 GHz RBW/VBW: 1 MHz

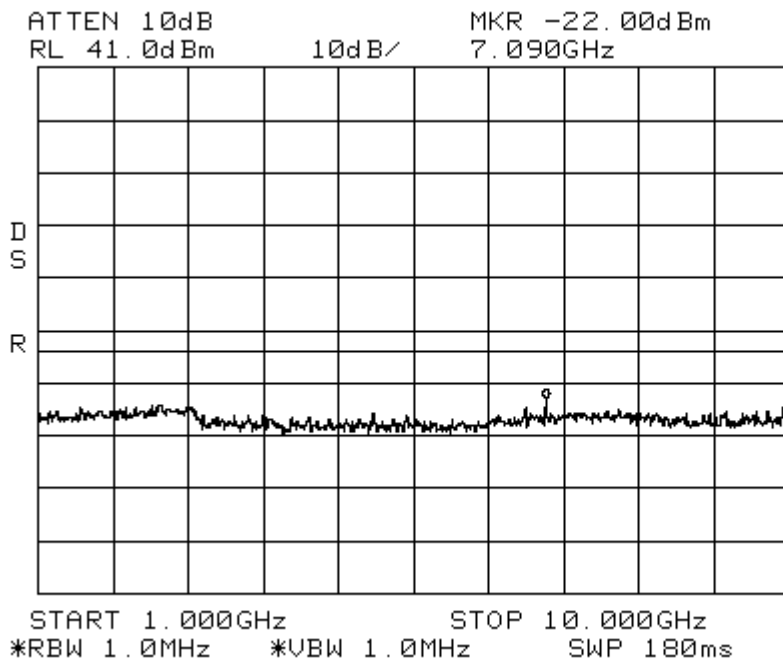

Conducted Emissions LTE 3 MHz Channel Bandwidth Spectrum 700 MHz Upper C Path 2
Center: 751 MHz Span: 5 MHz RBW/VBW: 100 kHz

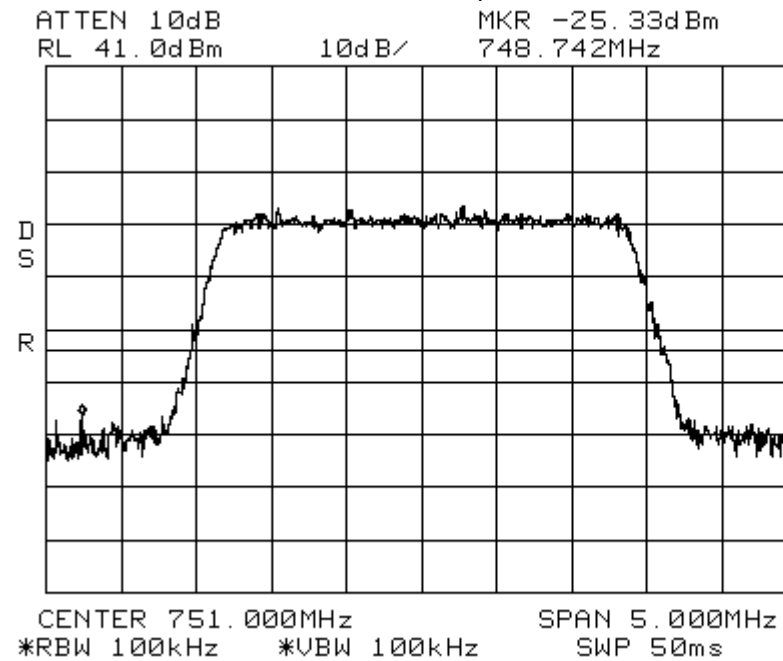

Conducted Emissions LTE 3 MHz Channel Bandwidth Spectrum 700 MHz Upper C Path 2
Span: 30 MHz to 1 GHz RBW/VBW: 300 kHz

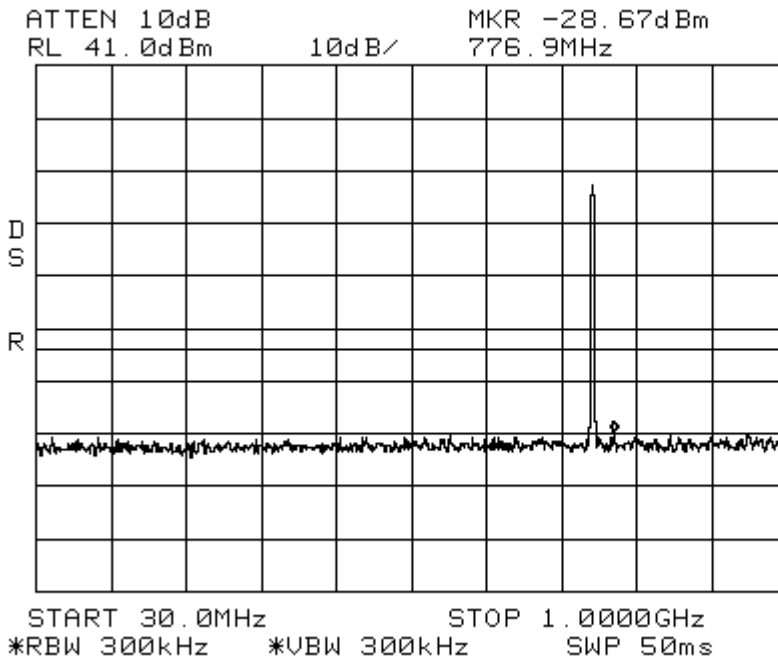

Conducted Emissions LTE 3 MHz Channel Bandwidth Spectrum 700 MHz Upper C Path 2
Span: 1 GHz to 10 GHz RBW/VBW: 1 MHz

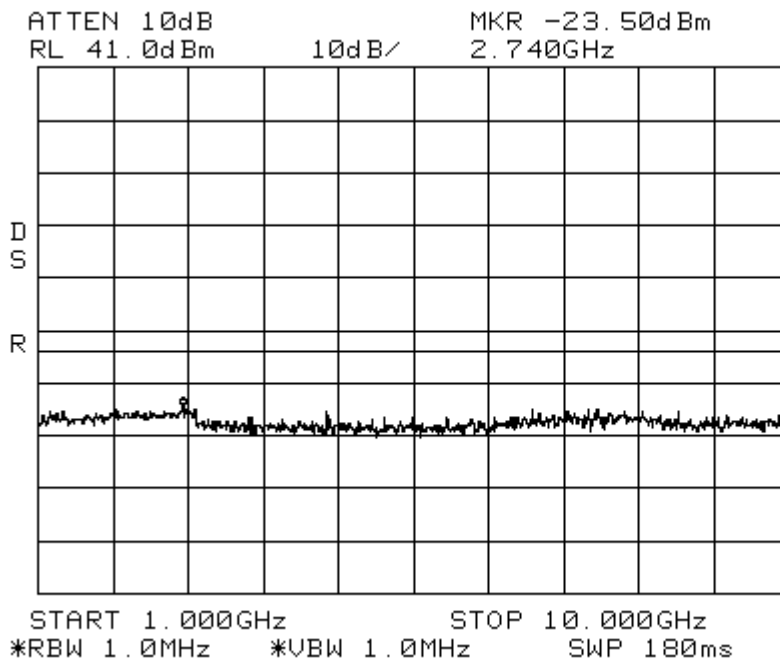

Conducted Emissions LTE 5 MHz Channel Bandwidth Spectrum 700 MHz Upper C Path 2

Center: 751 MHz Span: 10 MHz RBW/VBW: 100 kHz
ATTEN 10dB MKR -28.17dBm
RL 41.0dBm 10dB/ 748.38MHz

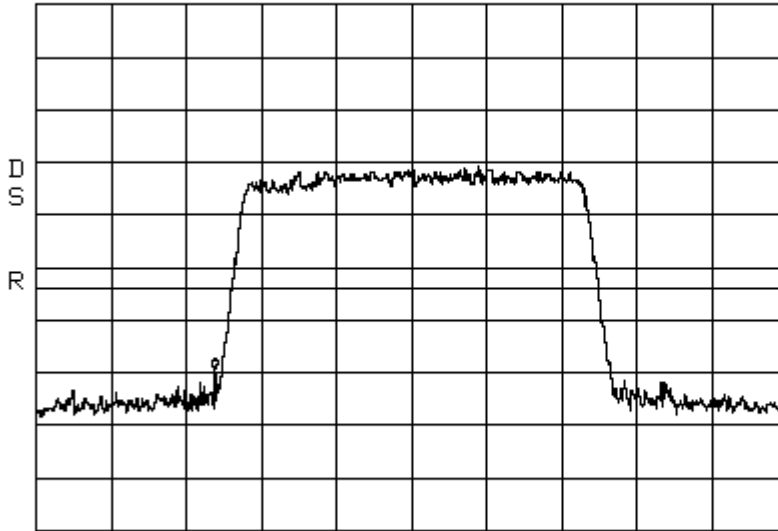

CENTER 751.00MHz SPAN 10.00MHz
*RBW 100kHz *VBW 100kHz SWP 50ms

Conducted Emissions LTE 5 MHz Channel Bandwidth Spectrum 700 MHz Upper C Path 2

Span: 30 MHz to 1 GHz RBW/VBW: 300 kHz

ATTEN 10dB MKR -28.67dBm
RL 41.0dBm 10dB/ 492.4MHz

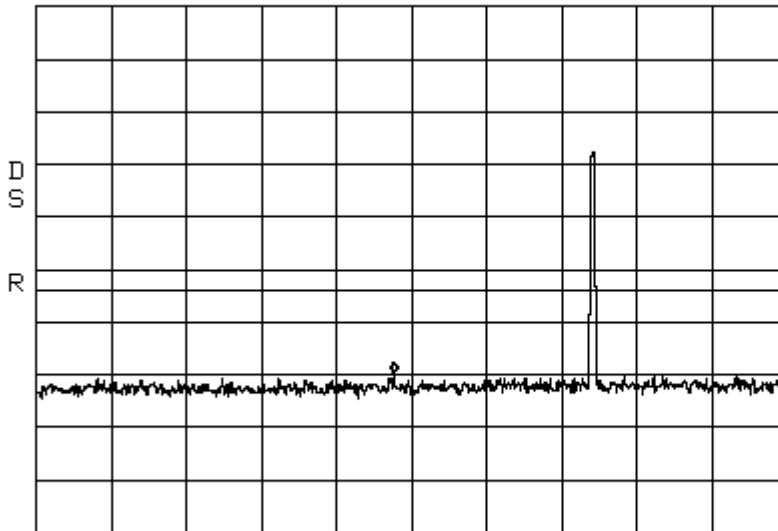

START 30.0MHz STOP 1.0000GHz
*RBW 300kHz *VBW 300kHz SWP 50ms

Conducted Emissions LTE 5 MHz Channel Bandwidth Spectrum 700 MHz Upper C Path 2
Span: 1 GHz to 10 GHz RBW/VBW: 1 MHz

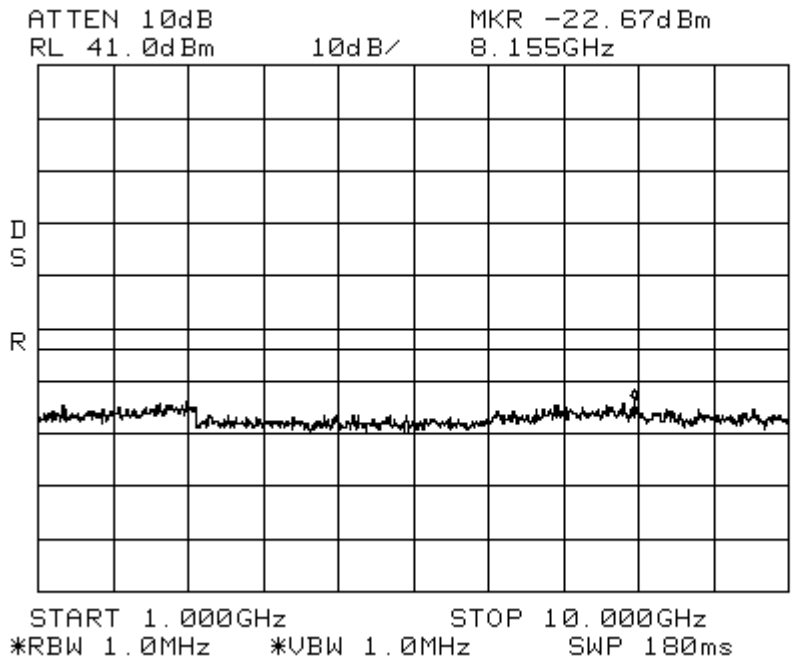

Conducted Emissions LTE 10 MHz Channel Bandwidth Spectrum 700 MHz Upper C Path 2
Center: 751 MHz Span: 20MHz RBW/VBW: 100 kHz

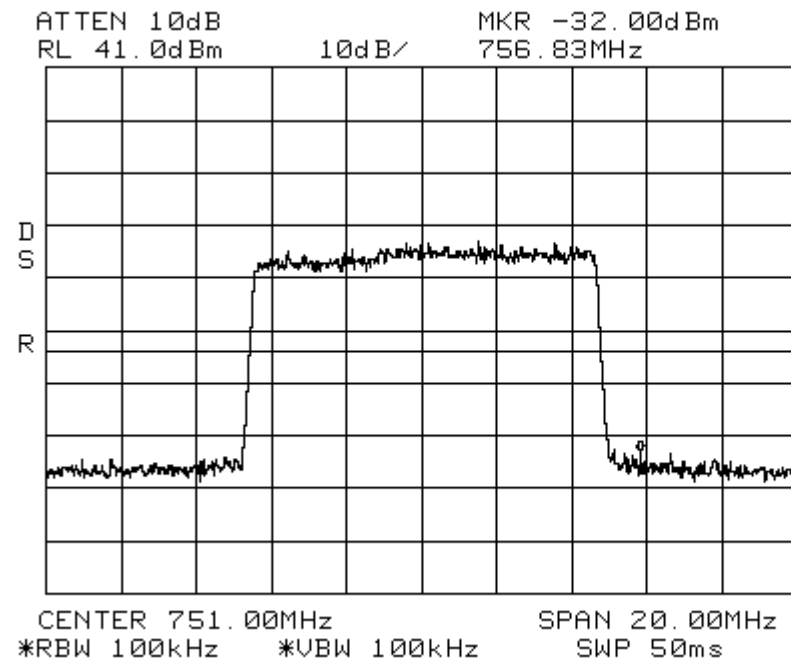

FCC 27.53 (c) Frequency Band 763 – 775 MHz (Path 1)



*RBW 6.25 kHz Marker 1 [T1]
*VBW 20 kHz -59.50 dBm
SWT 310 ms 764.653846154 MHz

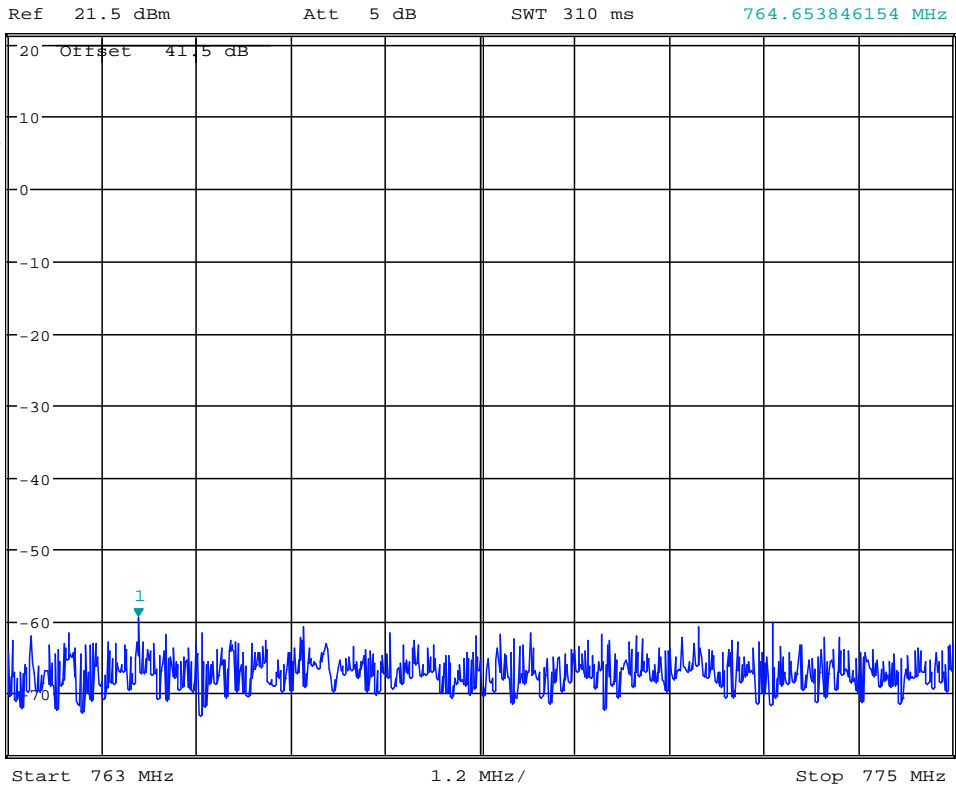

Date: 20.JUN.2011 11:24:56

FCC 27.53 (c) Frequency Band 793 – 805 MHz (Path 1)



*RBW 6.25 kHz Marker 1 [T1]
*VBW 20 kHz -60.49 dBm
SWT 310 ms 802.807692308 MHz

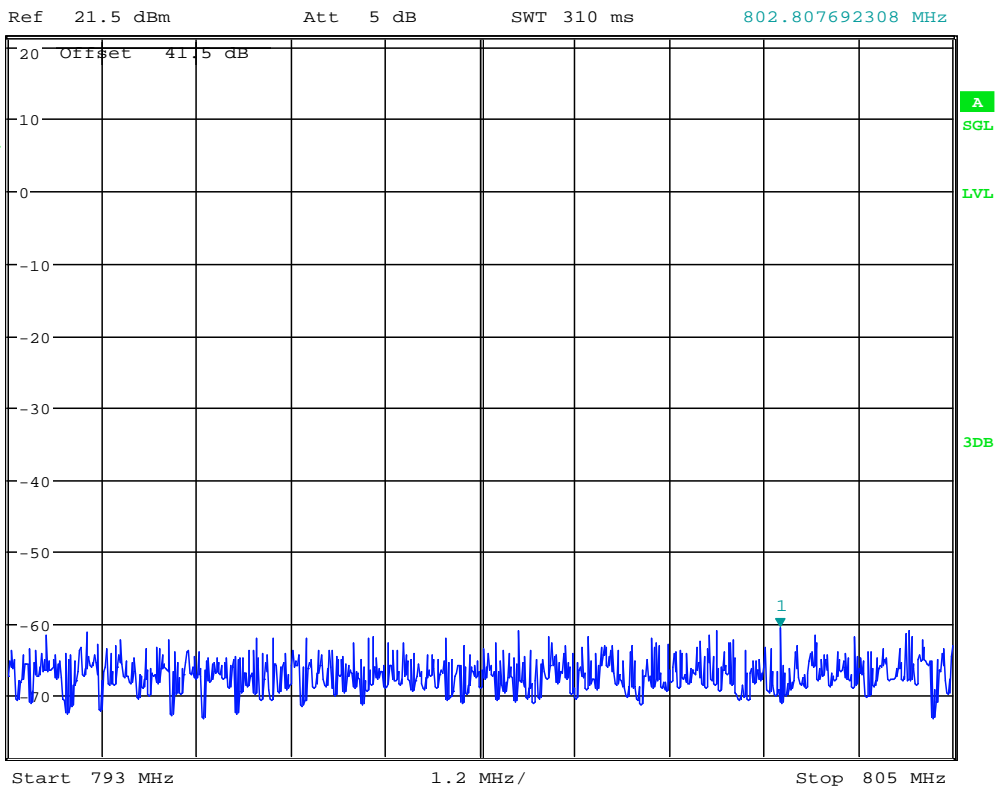

Date: 20.JUN.2011 11:23:50

FCC 27.53 (f) Frequency Band 1559 – 1610 MHz (Path 1)



*RBW 6.25 kHz Marker 1 [T1]
*VBW 20 kHz -58.15 dBm
SWT 1.35 s 1.592754808 GHz

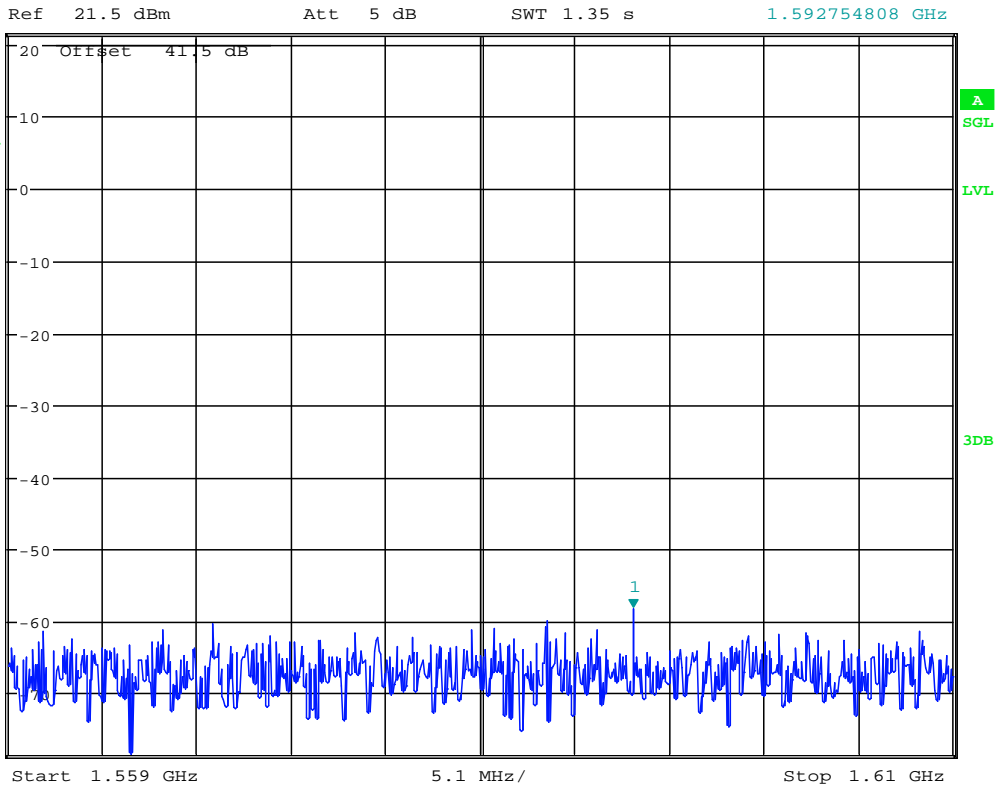

Date: 20.JUN.2011 11:26:39

Band_Edge LTE 1.4 MHz Channel Bandwidth Spectrum 700 Lower ABC MHz Path 2
Center: 728.7MHz Span: 2 MHz RBW: 3 kHz VBW: 10 kHz

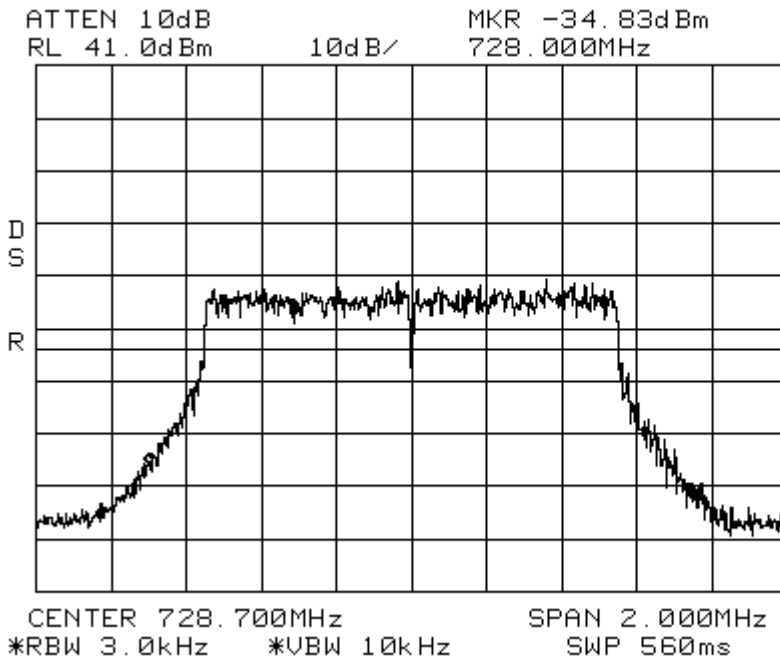

Band_Edge LTE 1.4 MHz Channel Bandwidth Spectrum 700 Lower ABC MHz Path 2
Center: 745.3 MHz Span: 2 MHz RBW: 3 kHz VBW: 10 kHz

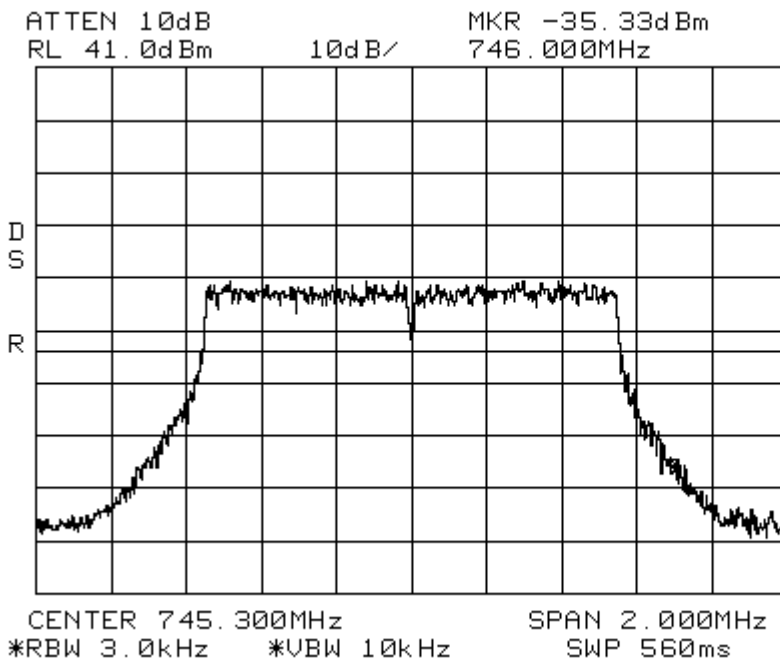

Band_Edge LTE 3 MHz Channel Bandwidth Spectrum 700 MHz Lower ABC Path 2
Center: 729.5 MHz Span: 5 MHz RBW: 30 kHz VBW: 100 kHz

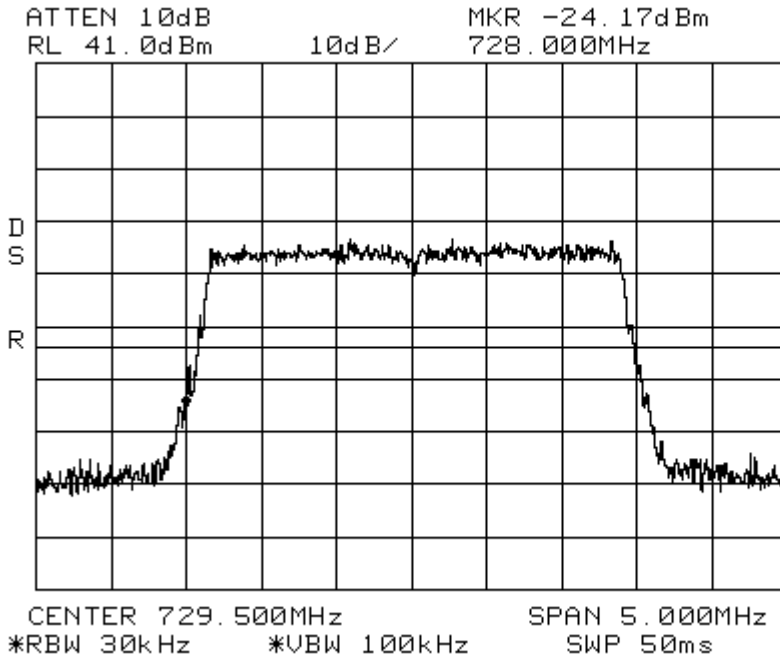

Band_Edge LTE 3MHz Channel Bandwidth Spectrum 700 MHz Lower ABC Path 2
Center: 744.5 MHz Span: 5 MHz RBW: 30 kHz VBW: 100 kHz

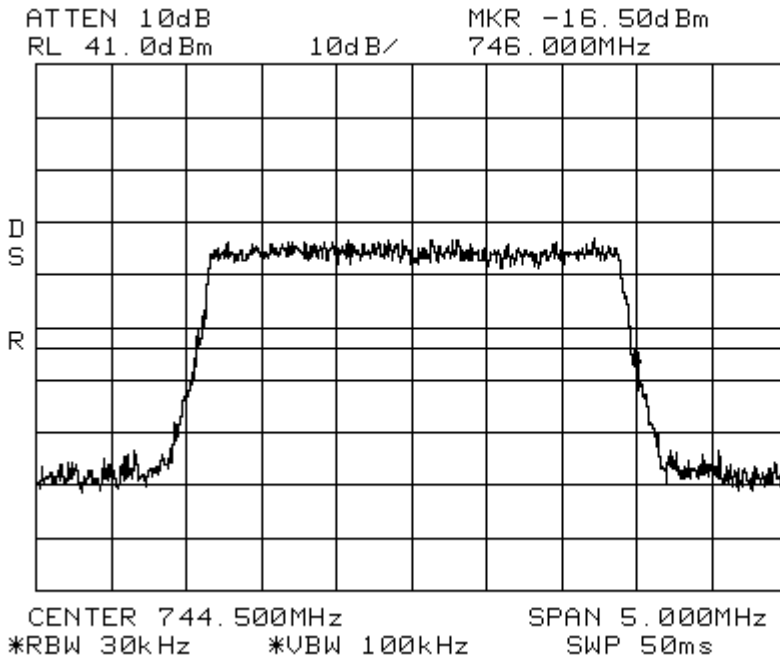

Band_Edge LTE 10 MHz Channel Bandwidth

Center: 733 MHz

Span: 15 MHz

Spectrum 700 MHz Lower ABC Path 1

RBW: 30 kHz VBW: 100 kHz

*ATTEN 10dB
RL 31.5dBm 10dB/ MKR -40.83dBm
728.00MHz

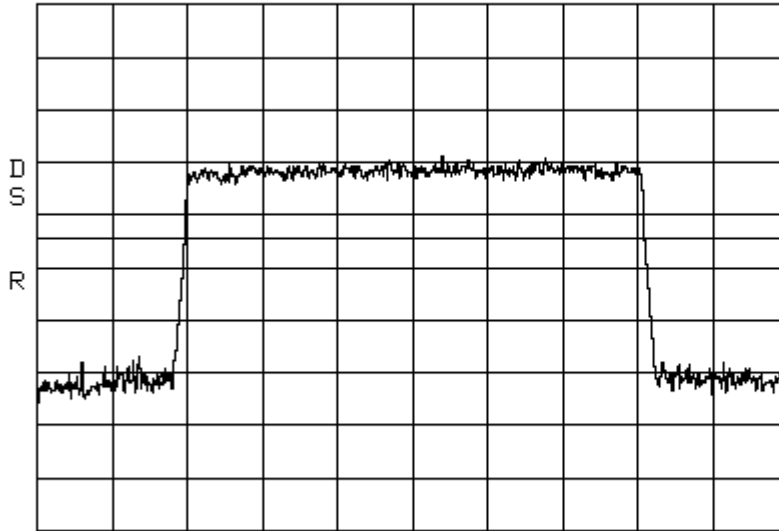

CENTER 733.00MHz SPAN 15.00MHz
*RBW 30kHz *VBW 100kHz SWP 50ms

Band_Edge LTE 10 MHz Channel Bandwidth

Center: 741 MHz

Span: 15 MHz

Spectrum 700 MHz Lower ABC Path 1

RBW: 30 kHz VBW: 100 kHz

*ATTEN 10dB
RL 31.5dBm 10dB/ MKR -39.50dBm
746.00MHz

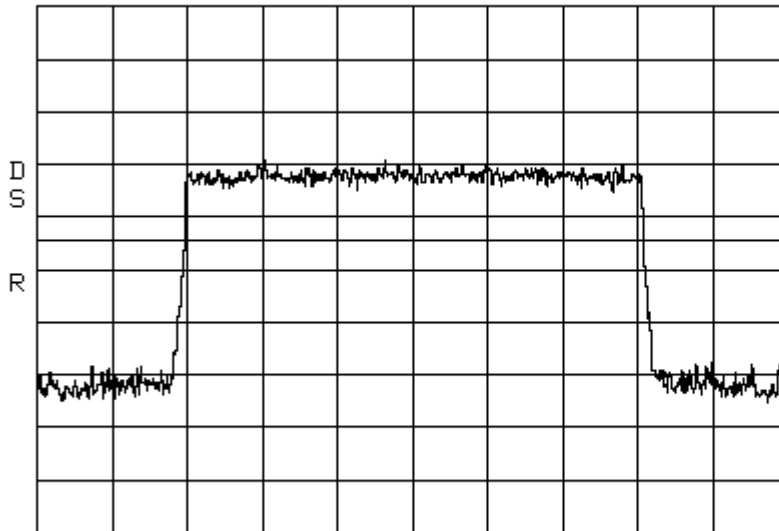

CENTER 741.00MHz SPAN 15.00MHz
*RBW 30kHz *VBW 100kHz SWP 50ms

Band_Edge LTE 10 MHz Channel Bandwidth Spectrum 700 MHz Lower ABC Path 2
Center: 733 MHz Span: 15 MHz RBW: 30 kHz VBW: 100 kHz
ATTEN 10dB MKR -39.50dBm
RL 41.0dBm 10dB/ 728.00MHz

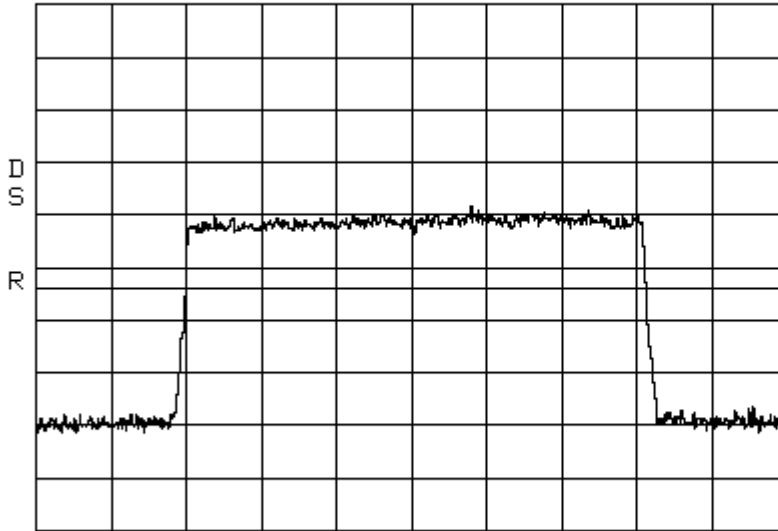

CENTER 733.00MHz SPAN 15.00MHz
*RBW 30kHz *VBW 100kHz SWP 50ms

Band_Edge LTE 10 MHz Channel Bandwidth Spectrum 700 MHz Lower ABC Path 2
Center: 741 MHz Span: 15 MHz RBW: 30 kHz VBW: 100 kHz

ATTEN 10dB MKR -40.33dBm
RL 41.0dBm 10dB/ 746.00MHz

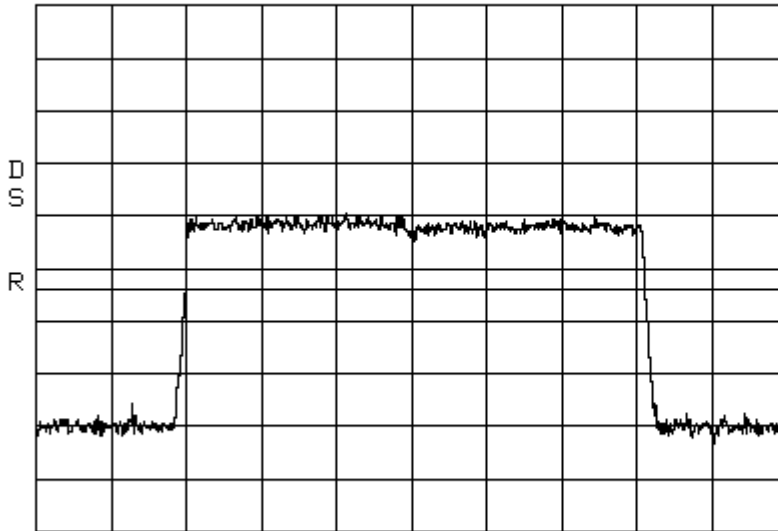

CENTER 741.00MHz SPAN 15.00MHz
*RBW 30kHz *VBW 100kHz SWP 50ms

Band_Edge LTE 15 MHz Channel Bandwidth

Spectrum 700 MHz Lower ABC Path 1

Center: 735.5 MHz Span: 17 MHz

RBW: 30 kHz VBW: 100 kHz

*ATTEN 10dB

MKR -41.67dBm

RL 31.5dBm

10dB/

727.99MHz

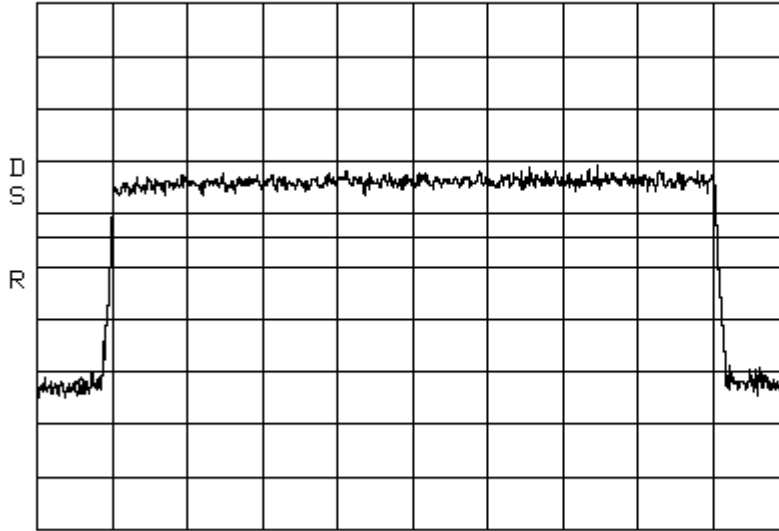

CENTER 735.50MHz

SPAN 17.00MHz

*RBW 30kHz

*VBW 100kHz

SWP 50ms

Band_Edge LTE 15 MHz Channel Bandwidth

Spectrum 700 MHz Lower ABC Path 1

Center: 738.5 MHz Span: 17 MHz

RBW: 30 kHz VBW: 100 kHz

*ATTEN 10dB

MKR -41.33dBm

RL 31.5dBm

10dB/

746.01MHz

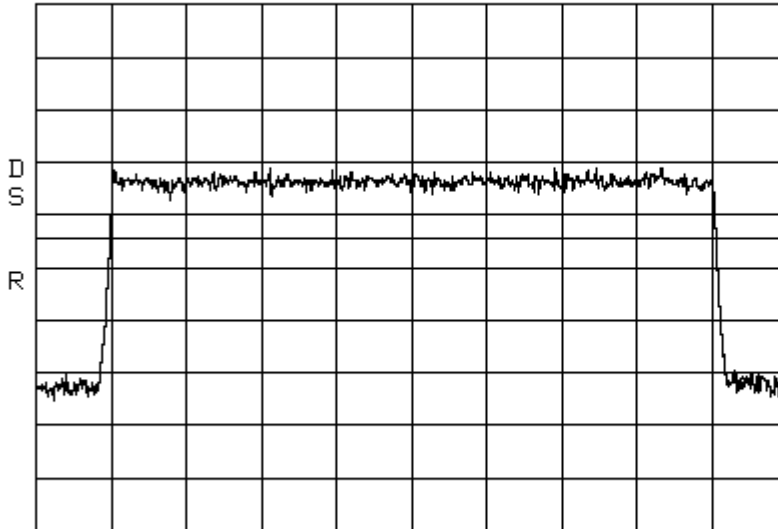

CENTER 738.50MHz

SPAN 17.00MHz

*RBW 30kHz

*VBW 100kHz

SWP 50ms

Band_Edge LTE 10 MHz Channel Bandwidth

Spectrum 700 MHz Upper C Path 1

Center: 751 MHz

Span: 15 MHz

RBW: 30 kHz VBW: 100 kHz

*ATTEN 10dB

MKR -42.17dBm

RL 31.5dBm

10dB/

746.00MHz

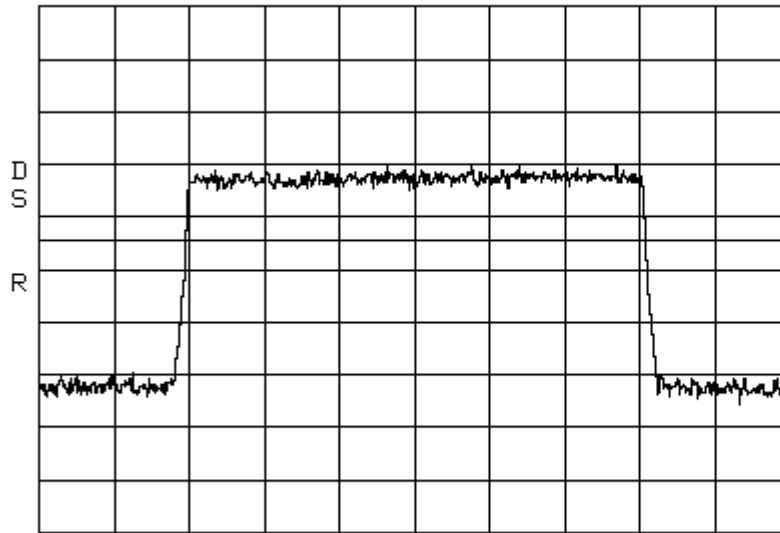

CENTER 751.00MHz

SPAN 15.00MHz

*RBW 30kHz

*VBW 100kHz

SWP 50ms

Band_Edge LTE 10 MHz Channel Bandwidth

Spectrum 700 MHz Upper C Path 1

Center: 751 MHz

Span: 15 MHz

RBW: 30 kHz VBW: 100 kHz

*ATTEN 10dB

MKR -41.33dBm

RL 31.5dBm

10dB/

756.00MHz

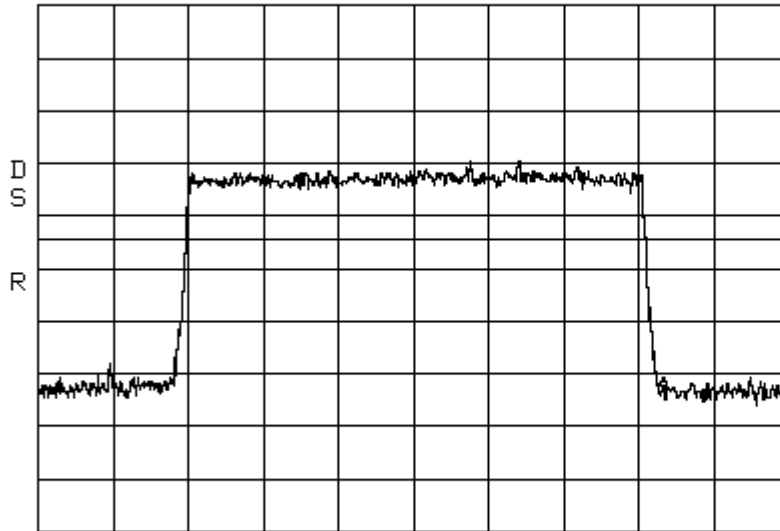

CENTER 751.00MHz

SPAN 15.00MHz

*RBW 30kHz

*VBW 100kHz

SWP 50ms

7.2 Conducted Output Power Test

[Table of Contents: Section 1.0](#)

[Back to Conducted Output Power: Section 5.1.1](#)

*Note: The EUT is a fixed repeater and not a base station.

This measurement was made as a direct conducted emission measurement. The output from the EUT antenna connector was connected to the power meter. The carrier output, below, was conducted using a single LTE 1.4 MHz, 3 MHz, 5MHz, 10MHz, & 15MHz Channel Bandwidths signal generator. The power meter level was offset to compensate for attenuators and cable loss between the EUT and the power meter.

A signal was used at the low, mid and high parts of the selected band.

700 Lower ABC Path 1

LTE 1.4 MHz Ch. BW 0.05357 Watts

Carrier Frequency	Carrier Output
728.70 MHz	<u>16.52</u> dBm
737.00 MHz	<u>17.29</u> dBm
745.30 MHz	<u>15.47</u> dBm

700 Lower ABC Path 1

LTE 3.0 MHz Ch. BW 0.06237 Watts

Carrier Frequency	Carrier Output
729.50 MHz	<u>17.23</u> dBm
737.00 MHz	<u>17.95</u> dBm
744.50 MHz	<u>16.30</u> dBm

700 Lower ABC Path 1

LTE 5.0 MHz Ch. BW 0.06295 Watts

Carrier Frequency	Carrier Output
730.50 MHz	<u>17.56</u> dBm
737.00 MHz	<u>17.99</u> dBm
743.50 MHz	<u>16.57</u> dBm

700 Lower ABC Path 1

LTE 10.0 MHz Ch. BW 0.05035 Watts

Carrier Frequency	Carrier Output
733.00 MHz	<u>16.80</u> dBm
737.00 MHz	<u>17.02</u> dBm
741.00 MHz	<u>15.33</u> dBm

700 Lower ABC Path 1

LTE 15.0 MHz Ch. BW 0.04709 Watts

Carrier Frequency	Carrier Output
735.50 MHz	<u>16.73</u> dBm
737.00 MHz	<u>16.00</u> dBm
738.5 MHz	<u>15.90</u> dBm

700 Upper C Path 1
LTE 1.4 MHz Ch. BW 0.04841 Watts

Carrier Frequency	Carrier Output
746.70 MHz	<u>16.85</u> dBm
751.00 MHz	<u>16.31</u> dBm
755.30 MHz	<u>16.29</u> dBm

700 Upper C Path 1
LTE 3.0 MHz Ch. BW 0.05023 Watts

Carrier Frequency	Carrier Output
747.50 MHz	<u>17.01</u> dBm
751.00 MHz	<u>16.42</u> dBm
754.50 MHz	<u>16.30</u> dBm

700 Upper C Path 1
LTE 5.0 MHz Ch. BW 0.05260 Watts

Carrier Frequency	Carrier Output
748.50 MHz	<u>17.21</u> dBm
751.00 MHz	<u>16.71</u> dBm
753.50 MHz	<u>16.55</u> dBm

700 Upper C Path 1
LTE 10.0 MHz Ch. BW 0.04405 Watts

Carrier Frequency	Carrier Output
751.00 MHz	<u>16.44</u> dBm

700 Lower ABC Path 2
LTE 1.4 MHz Ch. BW 0.04518 Watts

Carrier Frequency	Carrier Output
728.70 MHz	<u>15.93</u> dBm
737.00 MHz	<u>16.55</u> dBm
745.30 MHz	<u>15.89</u> dBm

700 Lower ABC Path 2
LTE 3.0 MHz Ch. BW 0.06109 Watts

Carrier Frequency	Carrier Output
729.50 MHz	<u>16.72</u> dBm
737.00 MHz	<u>17.86</u> dBm
744.50 MHz	<u>17.07</u> dBm

700 Lower ABC Path 2
LTE 5.0 MHz Ch. BW 0.04405 Watts

Carrier Frequency	Carrier Output
730.50 MHz	<u>16.05</u> dBm
737.00 MHz	<u>16.44</u> dBm
743.50 MHz	<u>15.45</u> dBm

700 Lower ABC Path 2
LTE 10.0 MHz Ch. BW 0.04375 Watts

Carrier Frequency	Carrier Output
733.00 MHz	<u>16.26</u> dBm
737.00 MHz	<u>16.41</u> dBm
741.00 MHz	<u>16.09</u> dBm

700 Lower ABC Path 2**LTE 15.0 MHz Ch. BW 0.04073 Watts**

Carrier Frequency	Carrier Output
735.50 MHz	<u>16.10</u> dBm
737.00 MHz	<u>16.05</u> dBm
738.5 MHz	<u>16.03</u> dBm

700 Upper C Path 2**LTE 1.4 MHz Ch. BW 0.04528 Watts**

Carrier Frequency	Carrier Output
746.70 MHz	<u>15.50</u> dBm
751.00 MHz	<u>16.56</u> dBm
755.30 MHz	<u>16.35</u> dBm

700 Upper C Path 2**LTE 3.0 MHz Ch. BW 0.05223 Watts**

Carrier Frequency	Carrier Output
747.50 MHz	<u>16.24</u> dBm
751.00 MHz	<u>17.18</u> dBm
754.50 MHz	<u>17.17</u> dBm

700 Upper C Path 2**LTE 5.0 MHz Ch. BW 0.04285 Watts**

Carrier Frequency	Carrier Output
748.50 MHz	<u>15.25</u> dBm
751.00 MHz	<u>16.25</u> dBm
753.50 MHz	<u>16.32</u> dBm

700 Upper C Path 2**LTE 10.0 MHz Ch. BW 0.04017Watts**

Carrier Frequency	Carrier Output
751.00 MHz	<u>16.04</u> dBm

7.3 Frequency Stability Test

[Table of Contents: Section 1.0](#)

[Back to Frequency Stability: Section 5.1.1](#)

Path 1

Host/DRU	IFEU	RAU	Carrier Frequency	Measured Frequency	Meets Requirements?
Input Voltage	Input Voltage	Input Voltage			
100 VAC	54VDC	54 VDC	728.200 MHz	728.200 MHz	Yes
170 VAC	54VDC	54 VDC	728.200 MHz	728.200 MHz	Yes
240 VAC	54VDC	54 VDC	728.200 MHz	728.200 MHz	Yes
100 VAC	54VDC	54 VDC	742.000 MHz	742.000 MHz	Yes
170 VAC	54VDC	54 VDC	742.000 MHz	742.000 MHz	Yes
240 VAC	54VDC	54 VDC	742.000 MHz	742.000 MHz	Yes
100 VAC	54VDC	54 VDC	755.800 MHz	755.800 MHz	Yes
170 VAC	54VDC	54 VDC	755.800 MHz	755.800 MHz	Yes
240 VAC	54VDC	54 VDC	755.800 MHz	755.800 MHz	Yes
Temperature			Carrier Frequency	Measured Frequency	Meets Requirements?
-25 Deg. C			728.200 MHz	728.200 MHz	Yes
-20 Deg. C			728.200 MHz	728.200 MHz	Yes
-10 Deg. C			728.200 MHz	728.200 MHz	Yes
0 Deg. C			728.200 MHz	728.200 MHz	Yes
10 Deg. C			728.200 MHz	728.200 MHz	Yes
20 Deg. C			728.200 MHz	728.200 MHz	Yes
30 Deg. C			728.200 MHz	728.200 MHz	Yes
40 Deg. C			728.200 MHz	728.200 MHz	Yes
45 Deg. C			728.200 MHz	728.200 MHz	Yes
50 Deg. C			728.200 MHz	728.200 MHz	Yes
-25 Deg. C			742.000 MHz	742.000 MHz	Yes
-20 Deg. C			742.000 MHz	742.000 MHz	Yes
-10 Deg. C			742.000 MHz	742.000 MHz	Yes
0 Deg. C			742.000 MHz	742.000 MHz	Yes
10 Deg. C			742.000 MHz	742.000 MHz	Yes
20 Deg. C			742.000 MHz	742.000 MHz	Yes
30 Deg. C			742.000 MHz	742.000 MHz	Yes
40 Deg. C			742.000 MHz	742.000 MHz	Yes
45 Deg. C			742.000 MHz	742.000 MHz	Yes
50 Deg. C			742.000 MHz	742.000 MHz	Yes
-25 Deg. C			755.800 MHz	755.800 MHz	Yes
-20 Deg. C			755.800 MHz	755.800 MHz	Yes
-10 Deg. C			755.800 MHz	755.800 MHz	Yes
0 Deg. C			755.800 MHz	755.800 MHz	Yes
10 Deg. C			755.800 MHz	755.800 MHz	Yes
20 Deg. C			755.800 MHz	755.800 MHz	Yes
30 Deg. C			755.800 MHz	755.800 MHz	Yes
40 Deg. C			755.800 MHz	755.800 MHz	Yes
45 Deg. C			755.800 MHz	755.800 MHz	Yes

50 Deg. C			755.800 MHz	755.800 MHz	Yes
-----------	--	--	-------------	-------------	-----

Path 2

Host/DRU	IFEU	RAU	Carrier Frequency	Measured Frequency	Meets Requirements?
Input Voltage	Input Voltage	Input Voltage			
100 VAC	54VDC	54 VDC	728.200 MHz	728.200 MHz	Yes
170 VAC	54VDC	54 VDC	728.200 MHz	728.200 MHz	Yes
240 VAC	54VDC	54 VDC	728.200 MHz	728.200 MHz	Yes
100 VAC	54VDC	54 VDC	742.000 MHz	742.000 MHz	Yes
170 VAC	54VDC	54 VDC	742.000 MHz	742.000 MHz	Yes
240 VAC	54VDC	54 VDC	742.000 MHz	742.000 MHz	Yes
100 VAC	54VDC	54 VDC	755.800 MHz	755.800 MHz	Yes
170 VAC	54VDC	54 VDC	755.800 MHz	755.800 MHz	Yes
240 VAC	54VDC	54 VDC	755.800 MHz	755.800 MHz	Yes
Temperature			Carrier Frequency	Measured Frequency	Meets Requirements?
-25 Deg. C			728.200 MHz	728.200 MHz	Yes
-20 Deg. C			728.200 MHz	728.200 MHz	Yes
-10 Deg. C			728.200 MHz	728.200 MHz	Yes
0 Deg. C			728.200 MHz	728.200 MHz	Yes
10 Deg. C			728.200 MHz	728.200 MHz	Yes
20 Deg. C			728.200 MHz	728.200 MHz	Yes
30 Deg. C			728.200 MHz	728.200 MHz	Yes
40 Deg. C			728.200 MHz	728.200 MHz	Yes
45 Deg. C			728.200 MHz	728.200 MHz	Yes
50 Deg. C			728.200 MHz	728.200 MHz	Yes
-25 Deg. C			742.000 MHz	742.000 MHz	Yes
-20 Deg. C			742.000 MHz	742.000 MHz	Yes
-10 Deg. C			742.000 MHz	742.000 MHz	Yes
0 Deg. C			742.000 MHz	742.000 MHz	Yes
10 Deg. C			742.000 MHz	742.000 MHz	Yes
20 Deg. C			742.000 MHz	742.000 MHz	Yes
30 Deg. C			742.000 MHz	742.000 MHz	Yes
40 Deg. C			742.000 MHz	742.000 MHz	Yes
45 Deg. C			742.000 MHz	742.000 MHz	Yes
50 Deg. C			742.000 MHz	742.000 MHz	Yes
-25 Deg. C			755.800 MHz	755.800 MHz	Yes
-20 Deg. C			755.800 MHz	755.800 MHz	Yes
-10 Deg. C			755.800 MHz	755.800 MHz	Yes
0 Deg. C			755.800 MHz	755.800 MHz	Yes
10 Deg. C			755.800 MHz	755.800 MHz	Yes
20 Deg. C			755.800 MHz	755.800 MHz	Yes
30 Deg. C			755.800 MHz	755.800 MHz	Yes
40 Deg. C			755.800 MHz	755.800 MHz	Yes
45 Deg. C			755.800 MHz	755.800 MHz	Yes
50 Deg. C			755.800 MHz	755.800 MHz	Yes

7.4 Intermodulation Test

[Table of Contents; Section 1.0](#)

[Back to Emission Limits; Section 5.1.3](#)

The inter-modulation products test was performed for the EUT. Three tests were performed with the modulation type. Test 1 was with 2 signals input to the EUT at lower end channels. Test 2 was with 2 signals input to the EUT at upper end channels. Test 3 was with 2 signals input to the EUT at upper and lower end channels. The modulation types tested were LTE 1.4 MHz, 3 MHz, 5MHz, 10MHz, & 15MHz Channel Bandwidths. An investigation was made from 30 MHz to the 10th Harmonic of the highest fundamental frequency (~20 GHz). The following plots show the results.

Results:

(See Plots)

Intermodulation LTE 1.4 MHz Channel Bandwidth_Low Spectrum 700 MHz Lower ABC Path 1
Center: 737 MHz Span: 35 MHz RBW/VBW: 100 kHz

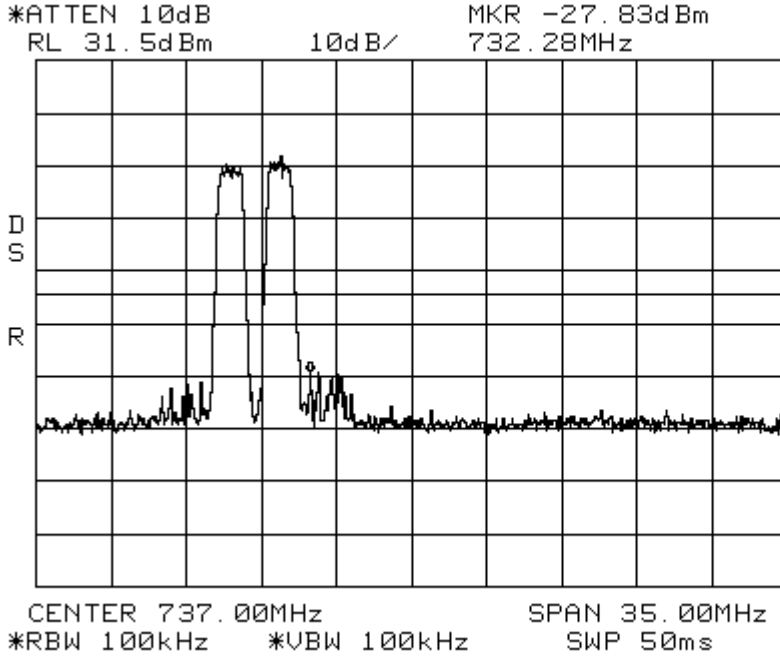

Intermodulation LTE 1.4 MHz Channel Bandwidth_Low Spectrum 700 MHz Lower ABC Path 1
Span: 30 MHz to 1 GHz RBW/VBW: 300 kHz

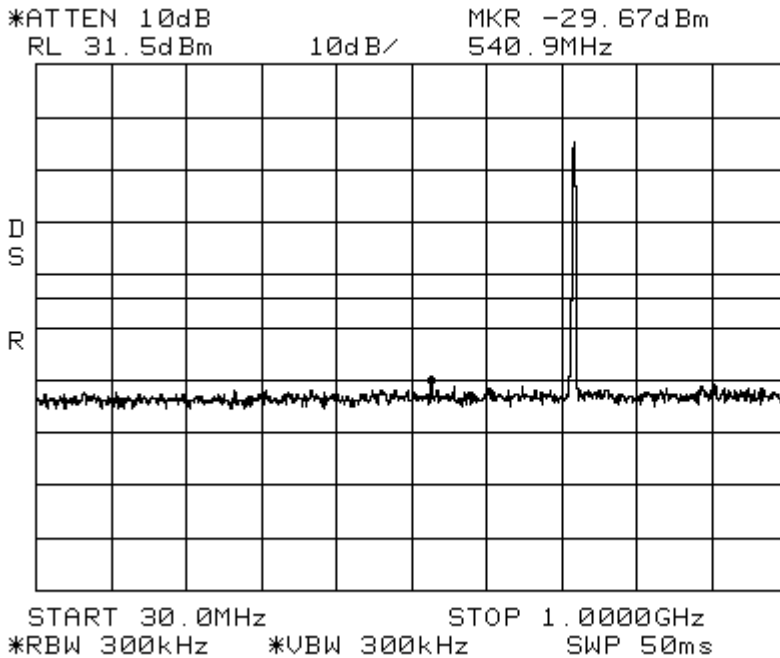

Intermodulation LTE 1.4 MHz Channel Bandwidth _High Spectrum 700 MHz Lower ABC Path 1
Span: 30 MHz to 1 GHz RBW/VBW: 300 kHz

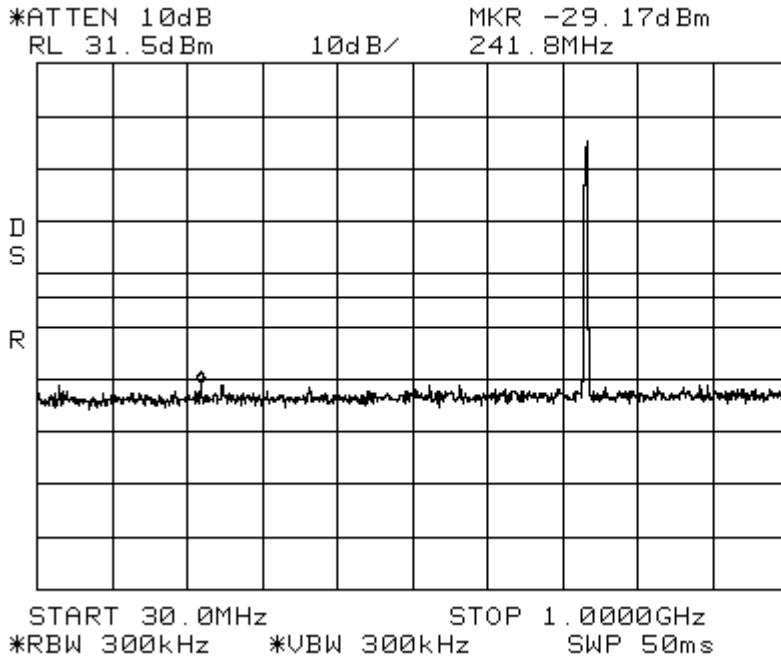

Intermodulation LTE 1.4 MHz Channel Bandwidth _High Spectrum 700 MHz Lower ABC Path 1
Span: 1 GHz to 10 GHz RBW/VBW: 1 MHz

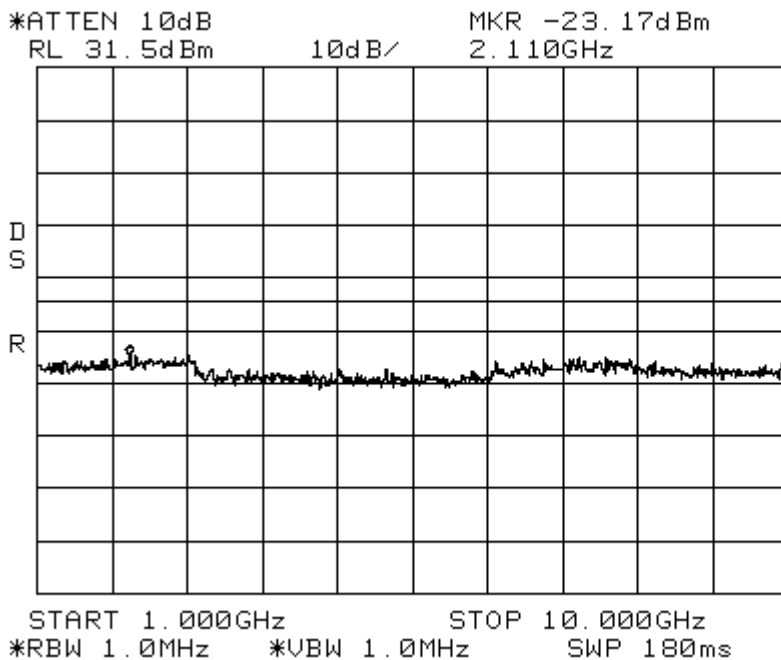

Intermodulation LTE 1.4 MHz Channel Bandwidth _Apart Spectrum 700 MHz Lower ABC Path 1

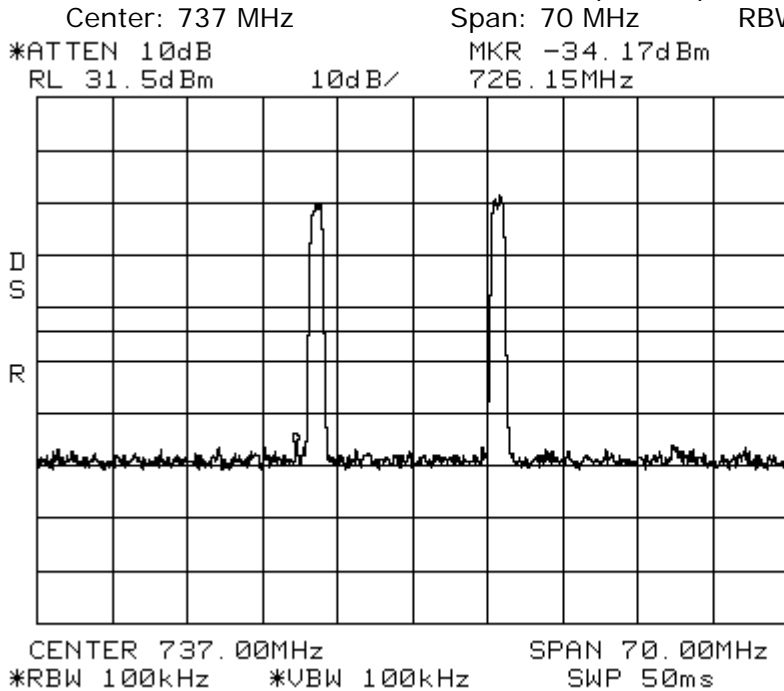

Intermodulation LTE 1.4 MHz Channel Bandwidth _Apart Spectrum 700 MHz Lower ABC Path 1
Span: 30 MHz to 1 GHz RBW/VBW: 300 kHz

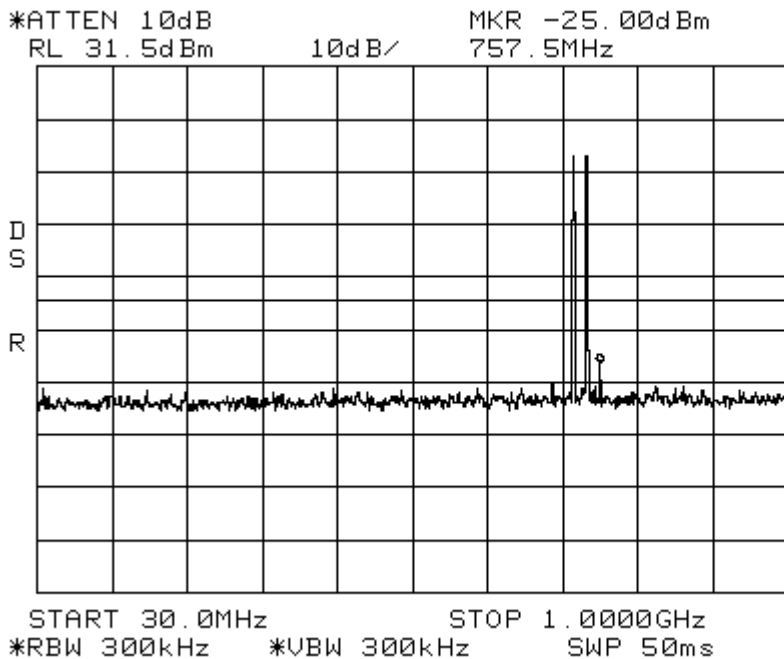

Intermodulation LTE 1.4 MHz Channel Bandwidth _Apart Spectrum 700 MHz Lower ABC Path 1

Span: 1 GHz to 10 GHz RBW/VBW: 1 MHz

*ATTEN 10dB MKR -22.67dBm
RL 31.5dBm 10dB/ 7.495GHz

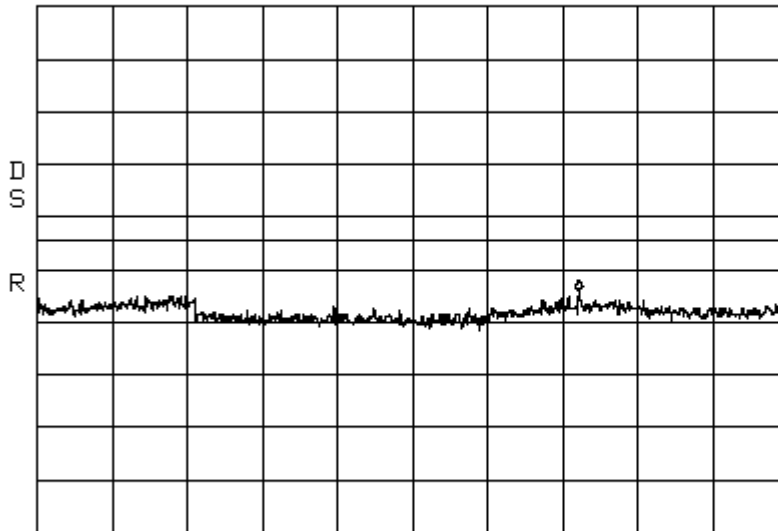

START 1.000GHz STOP 10.000GHz
*RBW 1.0MHz *VBW 1.0MHz SWP 180ms

Intermodulation LTE 3 MHz Channel Bandwidth_Low Spectrum 700 MHz Lower ABC Path 1

Center: 737 MHz Span: 35 MHz RBW/VBW: 100 kHz

*ATTEN 10dB MKR -29.83dBm
RL 31.5dBm 10dB/ 736.65MHz

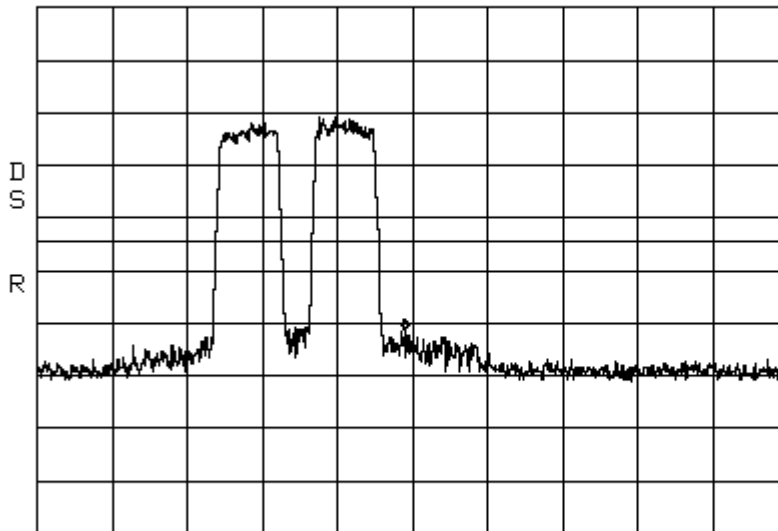

CENTER 737.00MHz SPAN 35.00MHz
*RBW 100kHz *VBW 100kHz SWP 50ms

Intermodulation LTE 3MHz Channel Bandwidth _Low Spectrum 700 MHz Lower ABC Path 1
Span: 30 MHz to 1 GHz RBW/VBW: 300 kHz

*ATTEN 10dB MKR -29.17dBm
RL 31.5dBm 10dB/ 946.7MHz

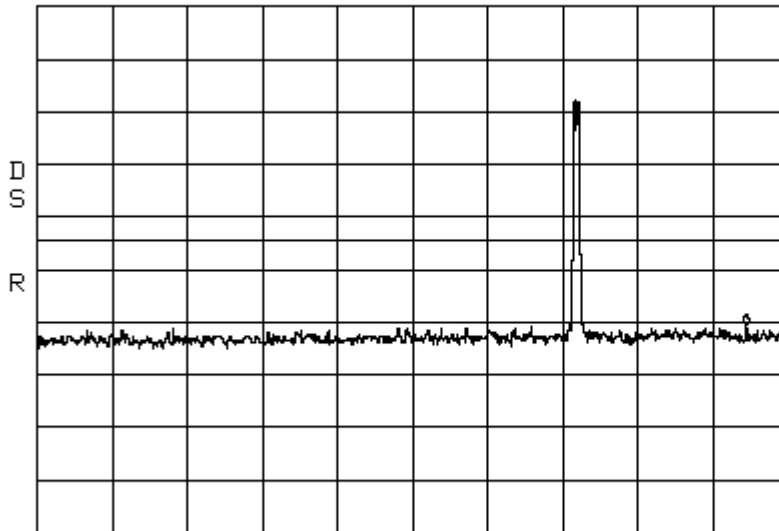

START 30.0MHz STOP 1.0000GHz
*RBW 300kHz *VBW 300kHz SWP 50ms

Intermodulation LTE 3 MHz Channel Bandwidth _Low Spectrum 700 MHz Lower ABC Path 1
Span: 1 GHz to 10 GHz RBW/VBW: 1 MHz

*ATTEN 10dB MKR -23.33dBm
RL 31.5dBm 10dB/ 2.725GHz

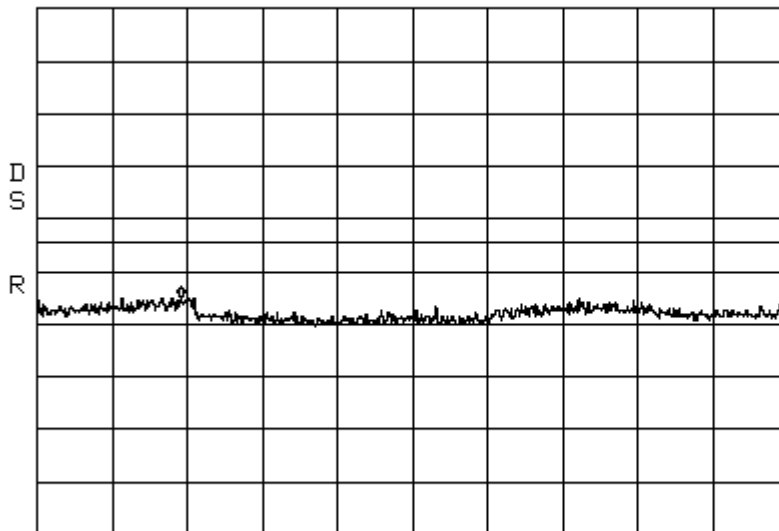

START 1.000GHz STOP 10.000GHz
*RBW 1.0MHz *VBW 1.0MHz SWP 180ms

Intermodulation LTE 3 MHz Channel Bandwidth _High Spectrum 700 MHz Lower ABC Path 1

Center: 737 MHz Span: 35 MHz RBW/VBW: 100 kHz
*ATTEN 10dB MKR -28.83dBm
RL 31.5dBm 10dB/ 748.08MHz

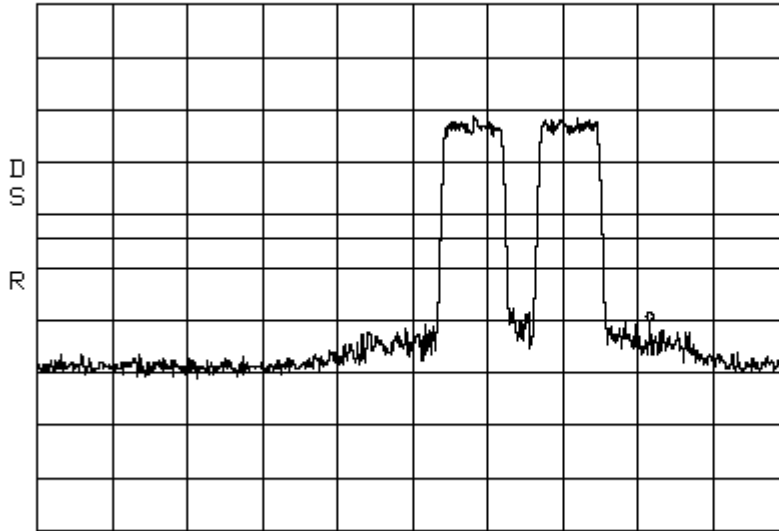

CENTER 737.00MHz SPAN 35.00MHz
*RBW 100kHz *VBW 100kHz SWP 50ms

Intermodulation LTE 3 MHz Channel Bandwidth _High Spectrum 700 MHz Lower ABC Path 1

Span: 30 MHz to 1 GHz RBW/VBW: 300 kHz

*ATTEN 10dB MKR -28.33dBm
RL 31.5dBm 10dB/ 838.3MHz

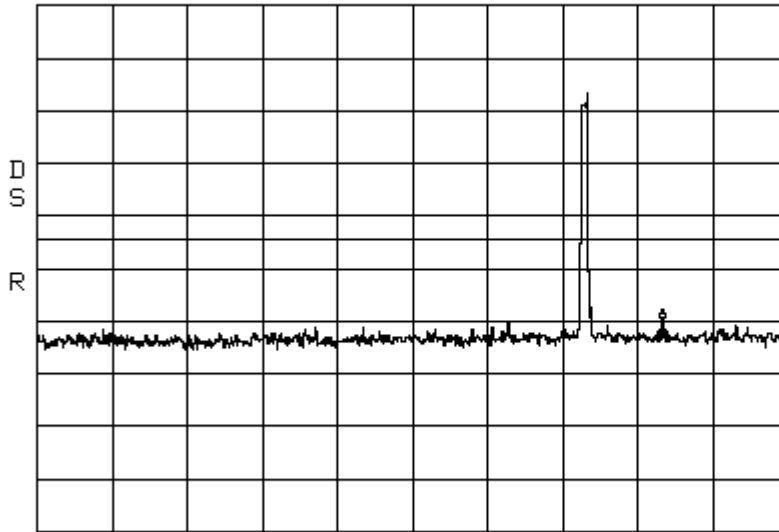

START 30.0MHz STOP 1.0000GHz
*RBW 300kHz *VBW 300kHz SWP 50ms

Intermodulation LTE 5 MHz Channel Bandwidth _Low Spectrum 700 MHz Lower ABC Path 1
Span: 1 GHz to 10 GHz RBW/VBW: 1 MHz

*ATTEN 10dB MKR -22.83dBm
RL 31.5dBm 10dB/ 1.945GHz

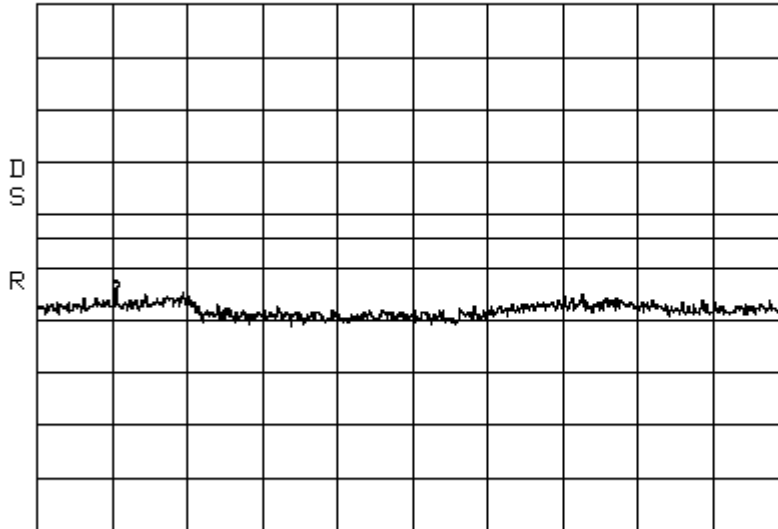

START 1.000GHz STOP 10.000GHz
*RBW 1.0MHz *VBW 1.0MHz SWP 180ms

Intermodulation LTE 5 MHz Channel Bandwidth_High Spectrum 700 MHz Lower ABC Path
1
Center: 737 MHz Span: 35 MHz RBW/VBW: 100 kHz

*ATTEN 10dB MKR -29.50dBm
RL 31.5dBm 10dB/ 733.97MHz

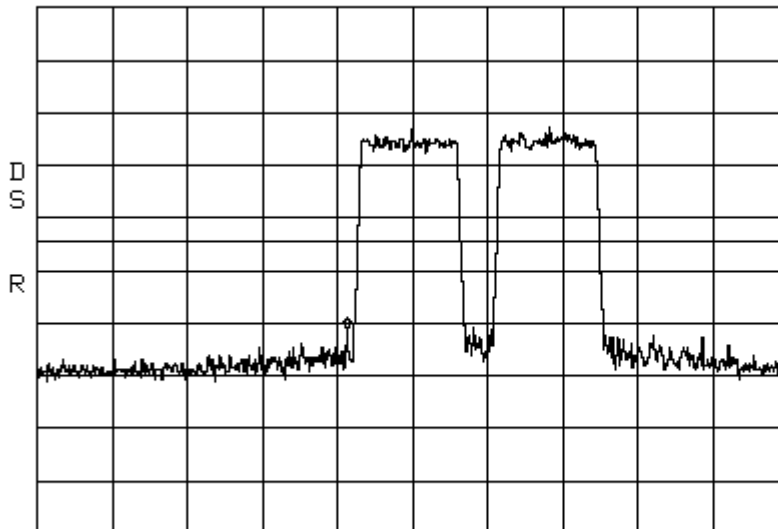

CENTER 737.00MHz SPAN 35.00MHz
*RBW 100kHz *VBW 100kHz SWP 50ms

Intermodulation LTE 5 MHz Channel Bandwidth _Apart Spectrum 700 MHz Lower ABC Path 1
Span: 1 GHz to 10 GHz RBW/VBW: 1 MHz

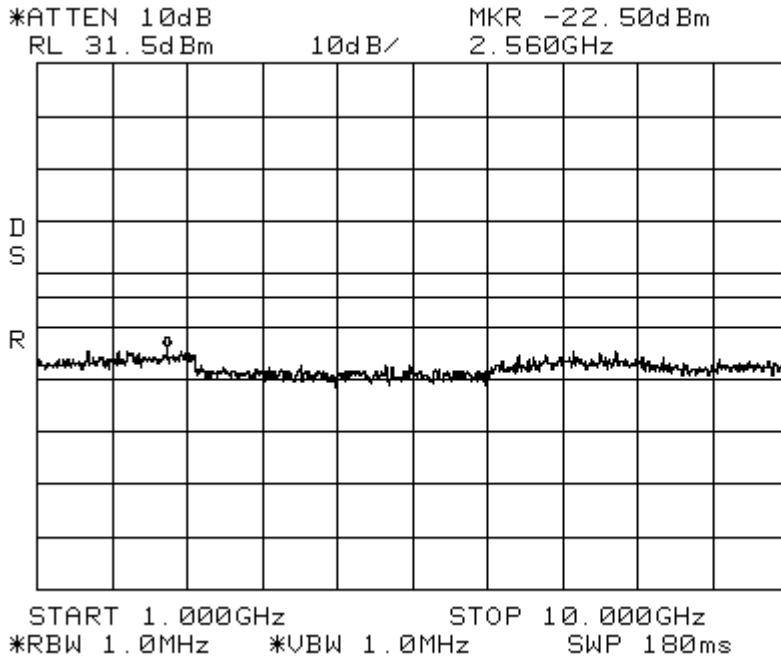

Intermodulation LTE 1.4 MHz Channel Bandwidth_Low Spectrum 700 MHz Lower ABC Path 2
Center: 737 MHz Span: 35 MHz RBW/VBW: 100 kHz

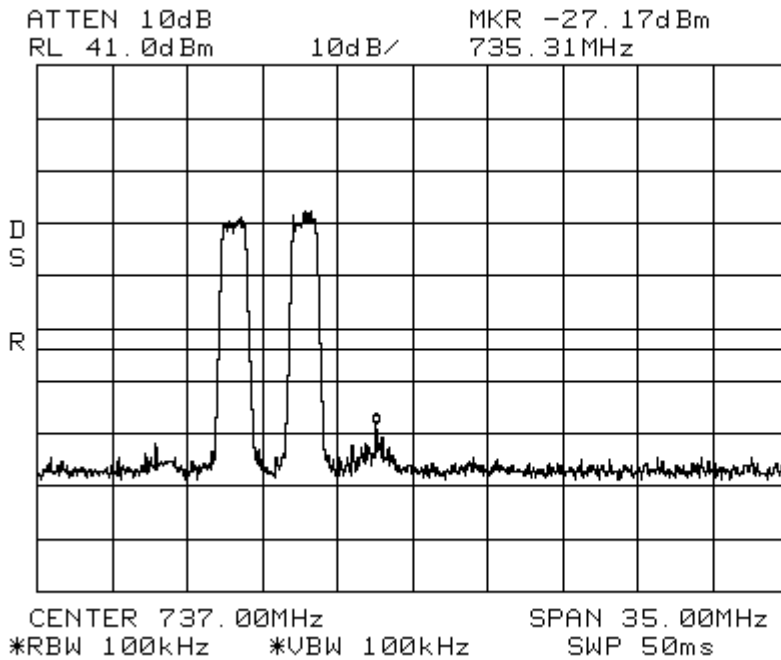

Intermodulation LTE 1.4 MHz Channel Bandwidth _Low Spectrum 700 MHz Lower ABC Path 2
Span: 30 MHz to 1 GHz RBW/VBW: 300 kHz

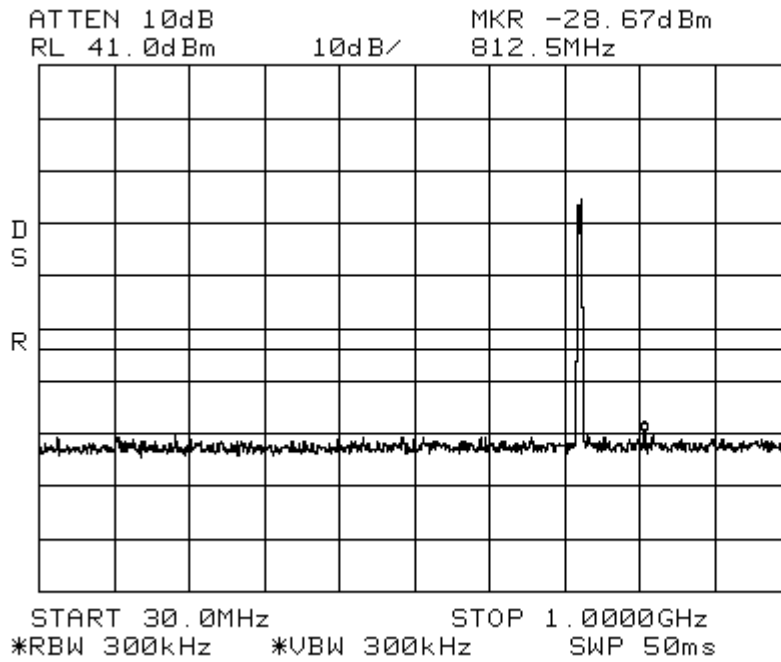

Intermodulation LTE 1.4 MHz Channel Bandwidth _Low Spectrum 700 MHz Lower ABC Path 2
Span: 1 GHz to 10 GHz RBW/VBW: 1 MHz

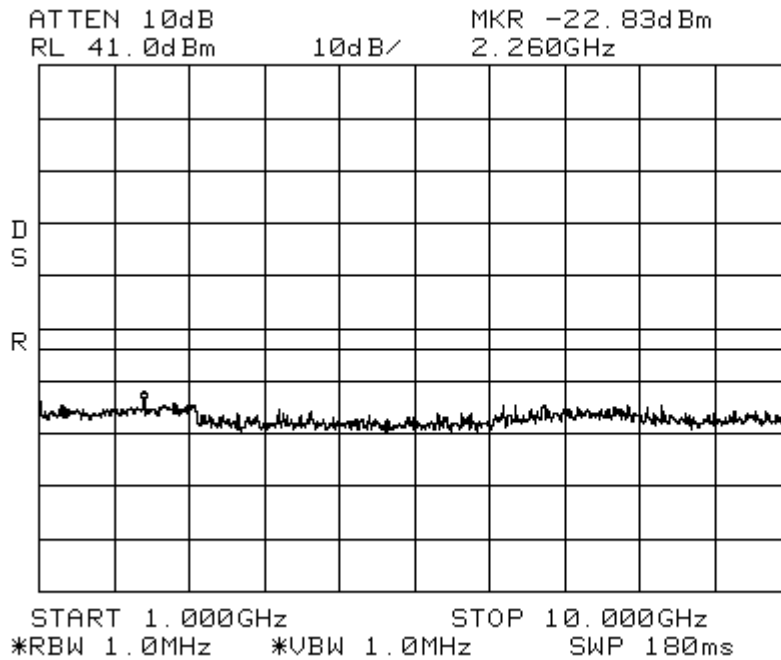

Intermodulation LTE 1.4 MHz Channel Bandwidth _High Spectrum 700 MHz Lower ABC Path 2

Center: 737 MHz Span: 35 MHz RBW/VBW: 100 kHz
ATTEN 10dB MKR -29.17dBm
RL 41.0dBm 10dB/ 738.34MHz

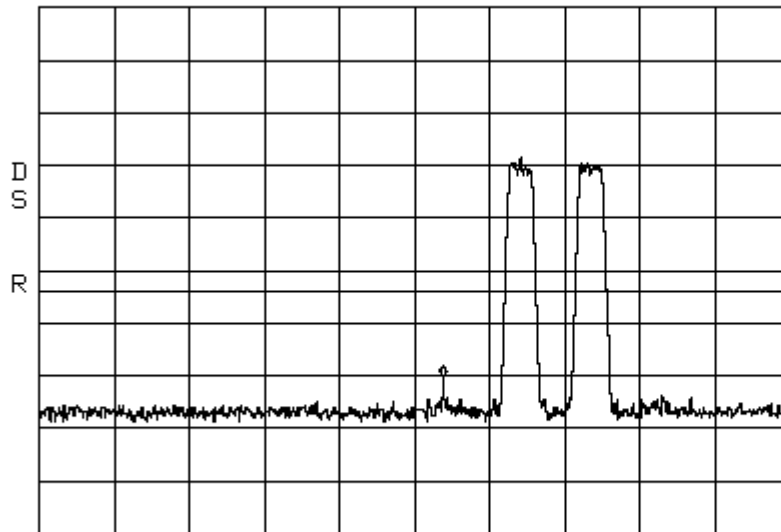

CENTER 737.00MHz SPAN 35.00MHz
*RBW 100kHz *VBW 100kHz SWP 50ms

Intermodulation LTE 1.4 MHz Channel Bandwidth _High Spectrum 700 MHz Lower ABC Path 2

Span: 30 MHz to 1 GHz RBW/VBW: 300 kHz
ATTEN 10dB MKR -28.83dBm
RL 41.0dBm 10dB/ 780.1MHz

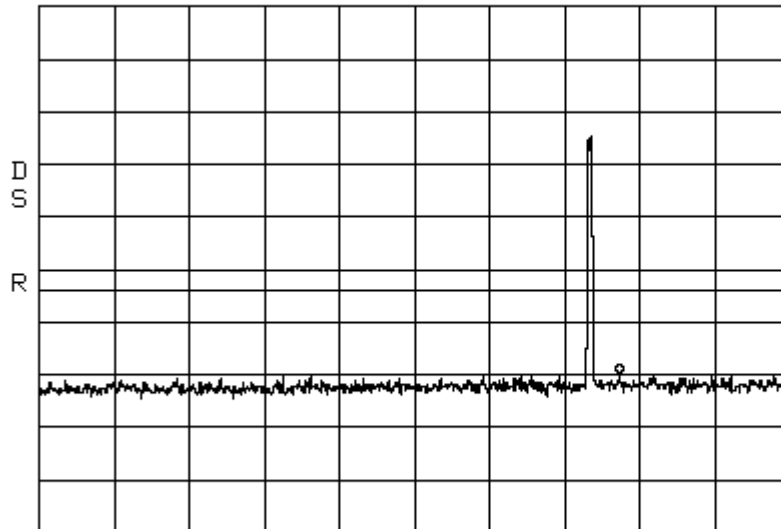

START 30.0MHz STOP 1.0000GHz
*RBW 300kHz *VBW 300kHz SWP 50ms

Intermodulation LTE 3 MHz Channel Bandwidth_Low Spectrum 700 MHz Lower ABC Path 2

Center: 737 MHz Span: 35 MHz RBW/VBW: 100 kHz
ATTEN 10dB MKR -31.67dBm
RL 41.0dBm 10dB/ 736.94MHz

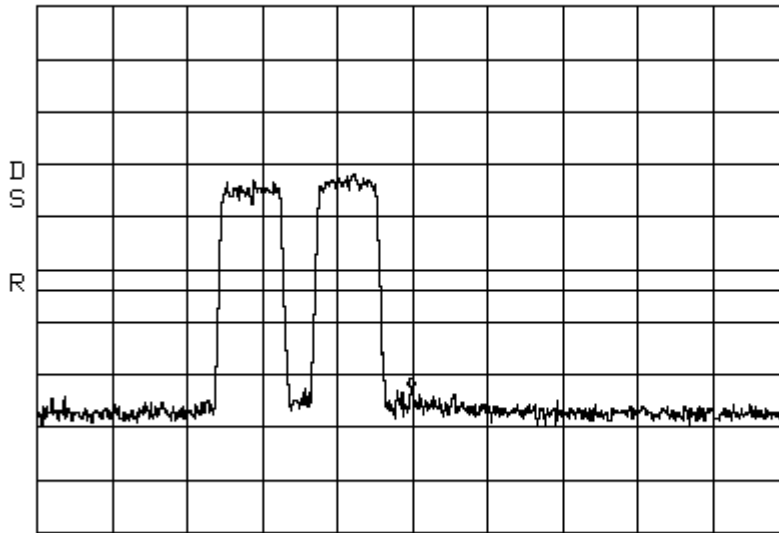

CENTER 737.00MHz SPAN 35.00MHz
*RBW 100kHz *VBW 100kHz SWP 50ms

Intermodulation LTE 3MHz Channel Bandwidth _Low Spectrum 700 MHz Lower ABC Path 2

Span: 30 MHz to 1 GHz RBW/VBW: 300 kHz
ATTEN 10dB MKR -28.83dBm
RL 41.0dBm 10dB/ 943.4MHz

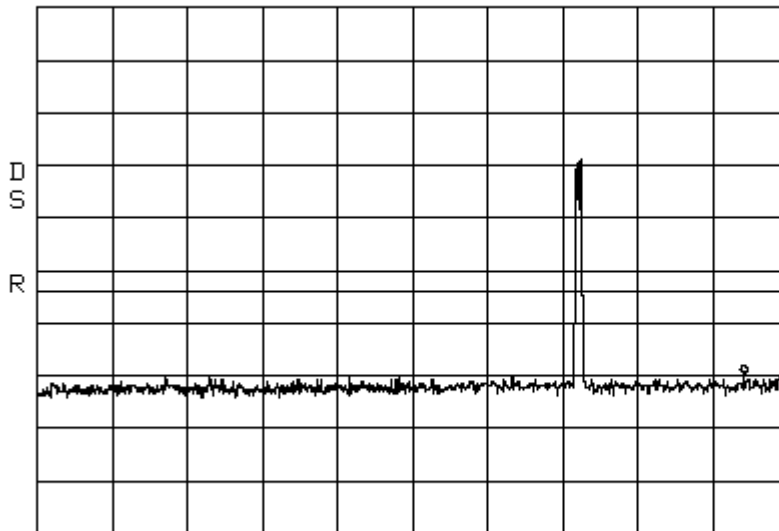

START 30.0MHz STOP 1.0000GHz
*RBW 300kHz *VBW 300kHz SWP 50ms

Intermodulation LTE 3 MHz Channel Bandwidth _Low Spectrum 700 MHz Lower ABC Path 2
Span: 1 GHz to 10 GHz RBW/VBW: 1 MHz

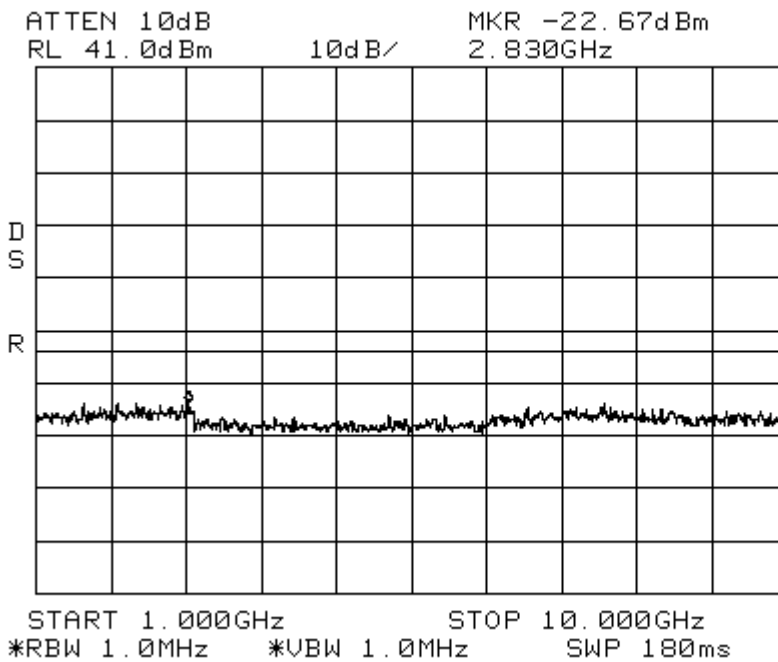

Intermodulation LTE 3 MHz Channel Bandwidth _High Spectrum 700 MHz Lower ABC Path 2
Center: 737 MHz Span: 35 MHz RBW/VBW: 100 kHz

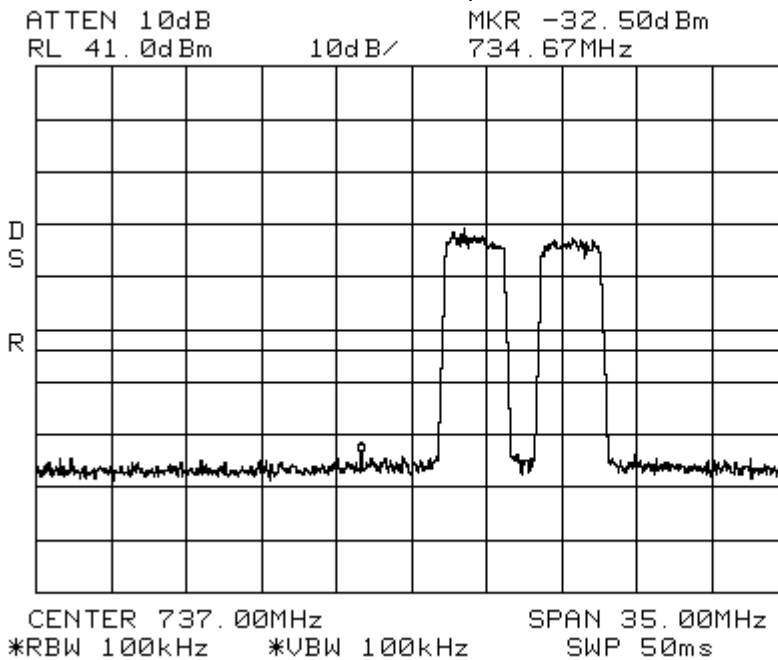

Intermodulation LTE 3 MHz Channel Bandwidth _High Spectrum 700 MHz Lower ABC Path 2
Span: 30 MHz to 1 GHz RBW/VBW: 300 kHz

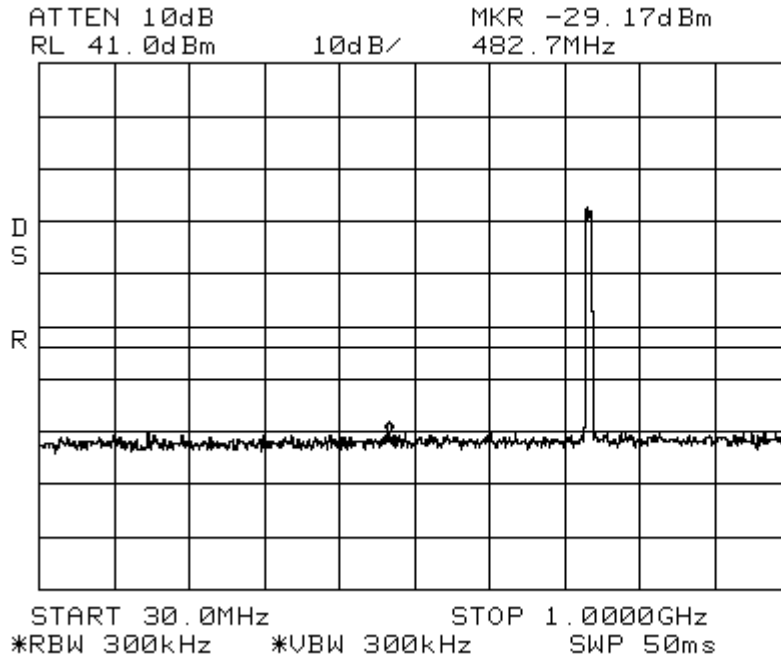

Intermodulation LTE 3 MHz Channel Bandwidth _High Spectrum 700 MHz Lower ABC Path 2
Span: 1 GHz to 10 GHz RBW/VBW: 1 MHz

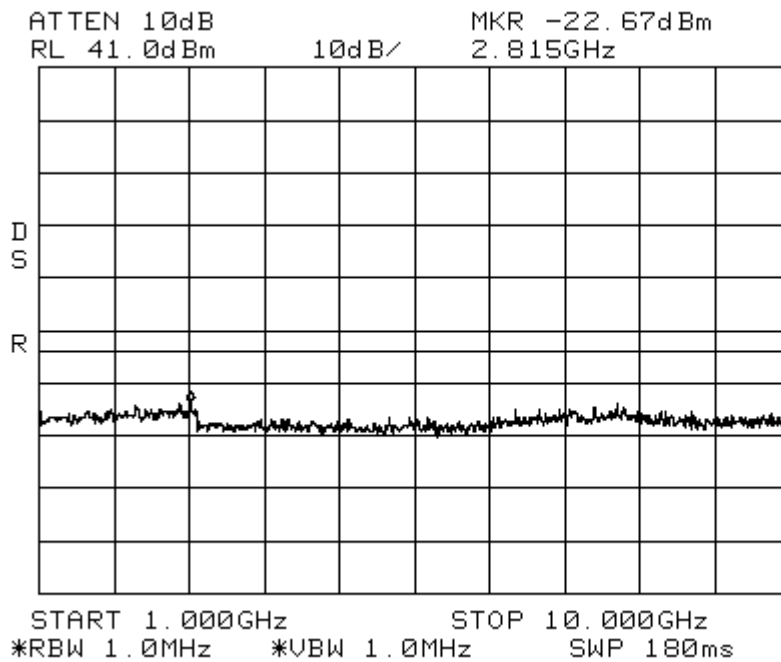

Intermodulation LTE 3 MHz Channel Bandwidth _Apart Spectrum 700 MHz Lower ABC Path 2
Center: 737 MHz Span: 70 MHz RBW/VBW: 100 kHz

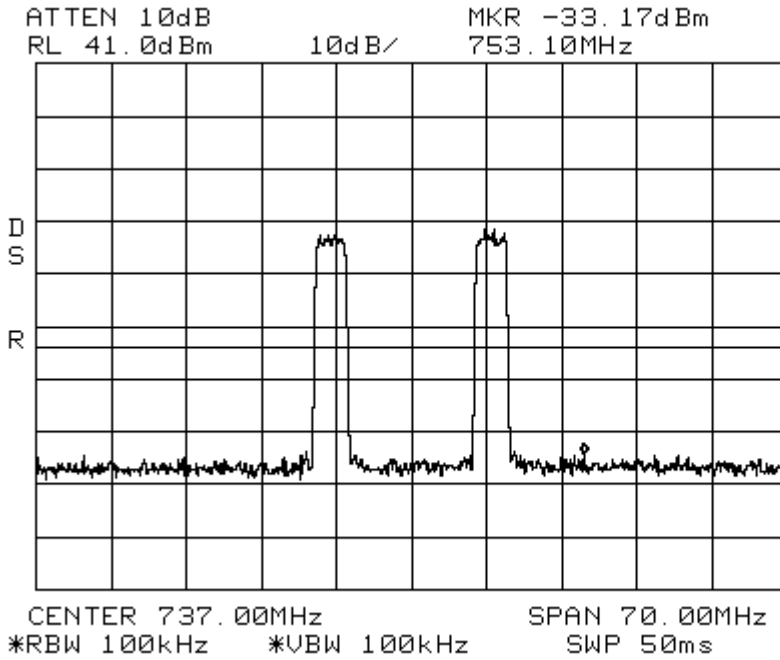

Intermodulation LTE 3 MHz Channel Bandwidth _Apart Spectrum 700 MHz Lower ABC Path 2
Span: 30 MHz to 1 GHz RBW/VBW: 300 kHz

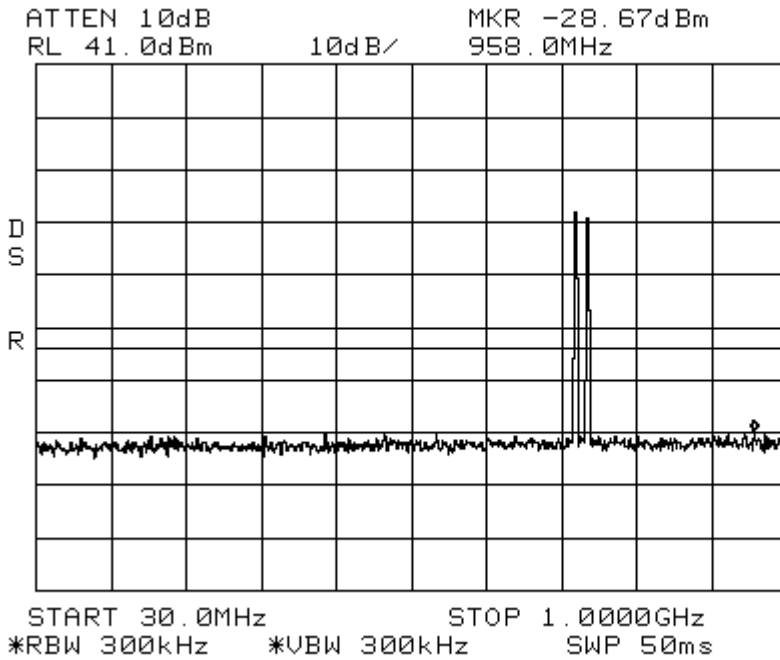

Intermodulation LTE 3 MHz Channel Bandwidth_Apart Spectrum 700 MHz Lower ABC Path 2
 Span: 1 GHz to 10 GHz RBW/VBW: 1 MHz

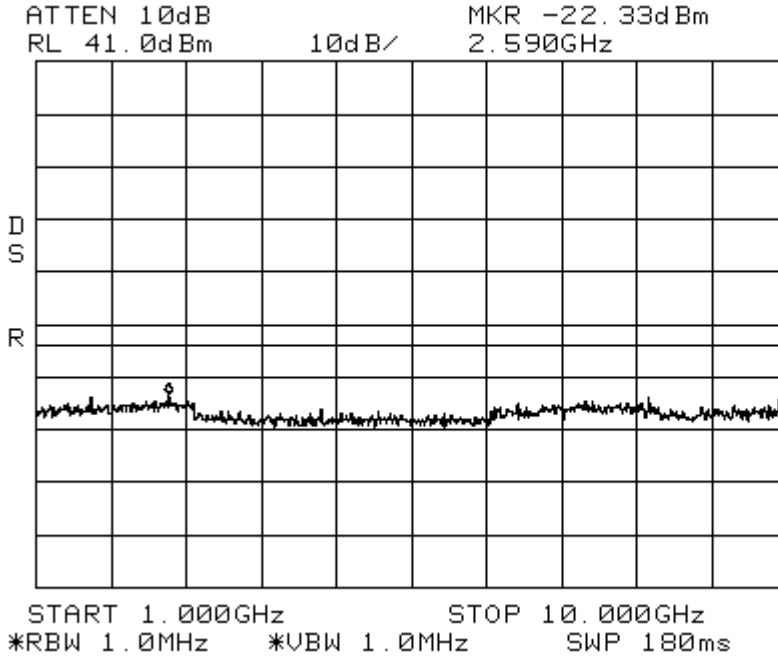

Intermodulation LTE 5 MHz Channel Bandwidth_Low Spectrum 700 MHz Lower ABC Path 2
 Center: 737 MHz Span: 35 MHz RBW/VBW: 100 kHz

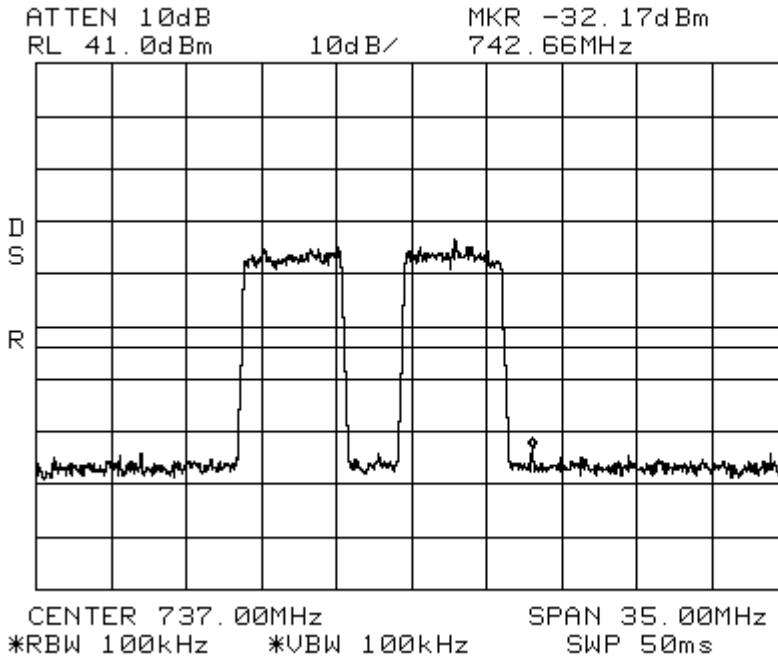

Intermodulation LTE 5 MHz Channel Bandwidth _Low Spectrum 700 MHz Lower ABC Path 2
Span: 30 MHz to 1 GHz RBW/VBW: 300 kHz

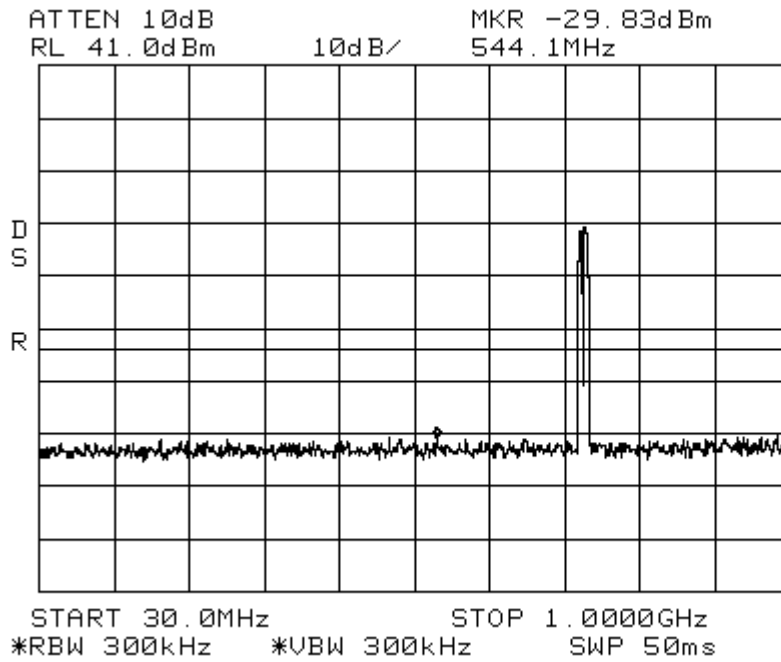

Intermodulation LTE 5 MHz Channel Bandwidth _Low Spectrum 700 MHz Lower ABC Path 2
Span: 1 GHz to 10 GHz RBW/VBW: 1 MHz

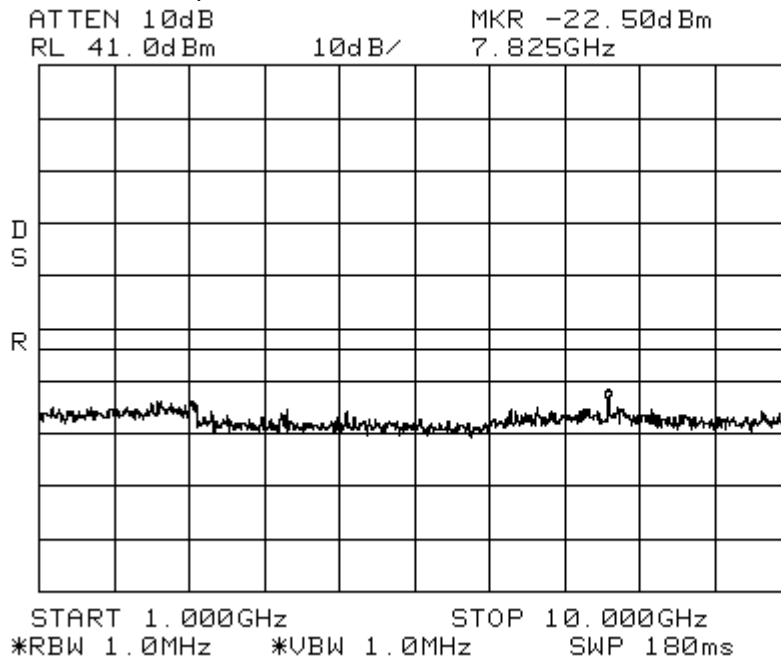

Intermodulation LTE 5 MHz Channel Bandwidth_High Spectrum 700 MHz Lower ABC Path 2
Center: 737 MHz Span: 35 MHz RBW/VBW: 100 kHz

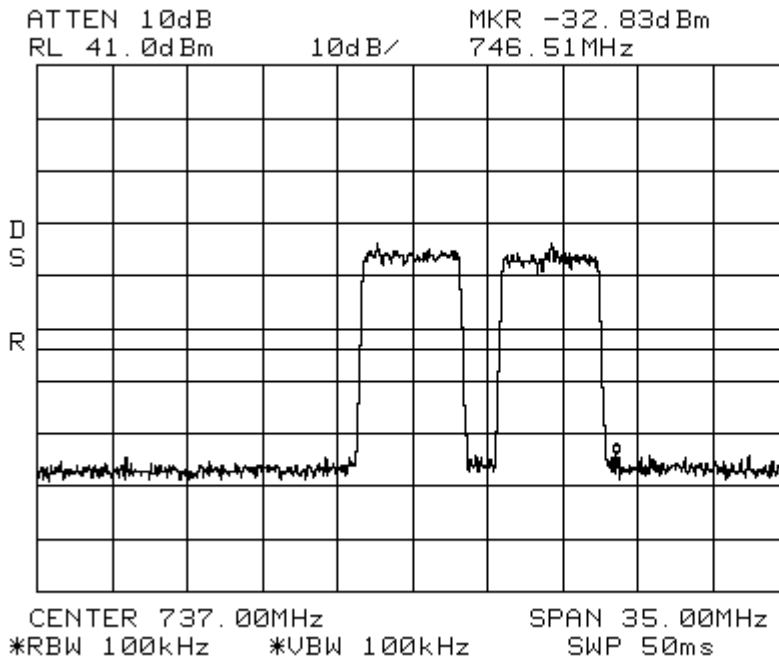

Intermodulation LTE 5 MHz Channel Bandwidth_High Spectrum 700 MHz Lower ABC Path 2
Span: 30 MHz to 1 GHz RBW/VBW: 300 kHz

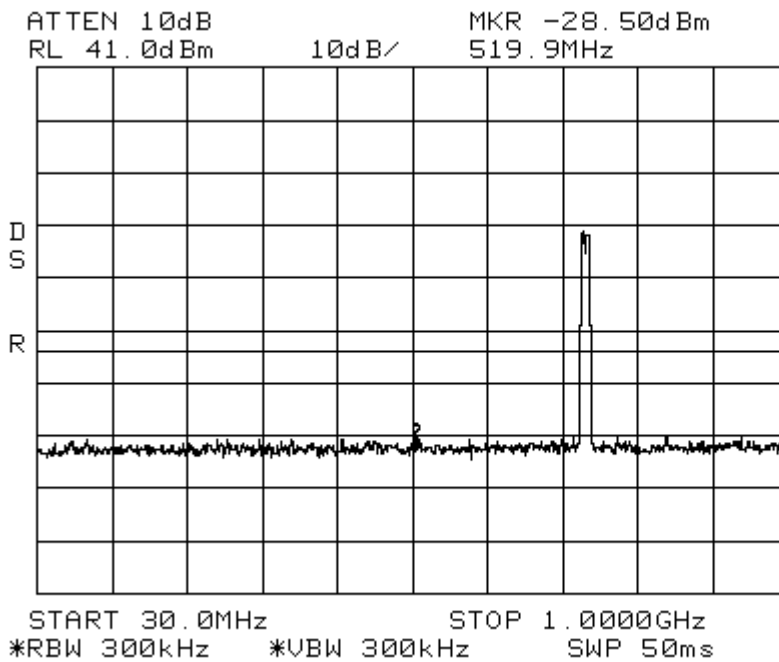

Intermodulation LTE 5 MHz Channel Bandwidth _High Spectrum 700 MHz Lower ABC Path 2
Span: 1 GHz to 10 GHz RBW/VBW: 1 MHz

ATTEN 10dB MKR -23.33dBm
RL 41.0dBm 10dB/ 7.375GHz

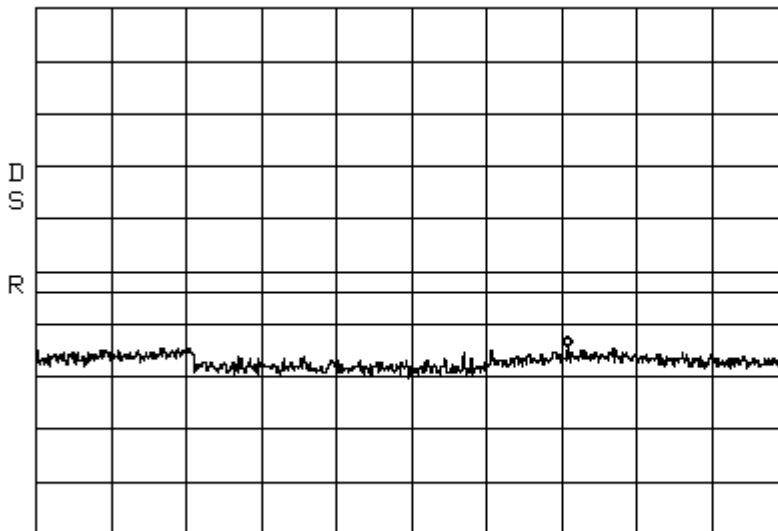

START 1.000GHz STOP 10.000GHz
*RBW 1.0MHz *VBW 1.0MHz SWP 180ms

Intermodulation LTE 5 MHz Channel Bandwidth **Apart** Spectrum 700 MHz Lower ABC Path 2
Center: 737 MHz Span: 35 MHz RBW/VBW: 100 kHz

ATTEN 10dB MKR -33.67dBm
RL 41.0dBm 10dB/ 722.53MHz

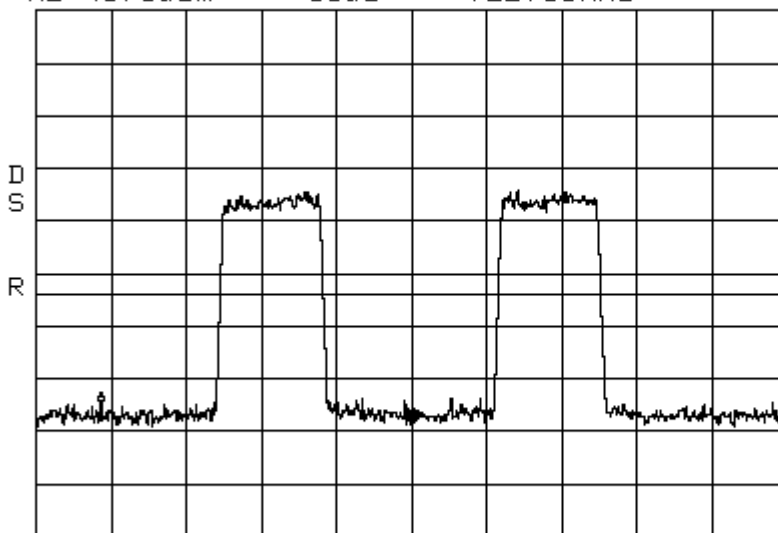

CENTER 737.00MHz SPAN 35.00MHz
*RBW 100kHz *VBW 100kHz SWP 50ms

Intermodulation LTE 5 MHz Channel Bandwidth _Apart Spectrum 700 MHz Lower ABC Path 2
Span: 30 MHz to 1 GHz RBW/VBW: 300 kHz

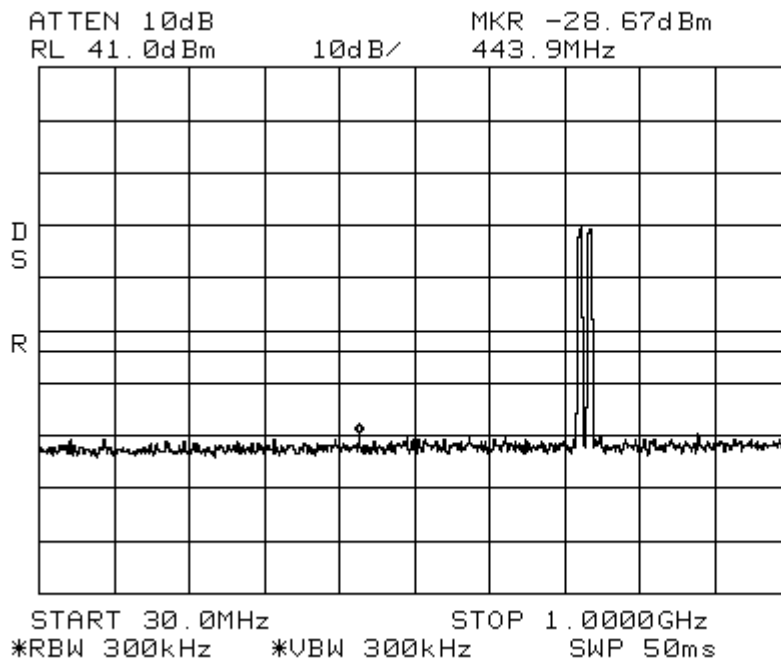

Intermodulation LTE 5 MHz Channel Bandwidth _Apart Spectrum 700 MHz Lower ABC Path 2
Span: 1 GHz to 10 GHz RBW/VBW: 1 MHz

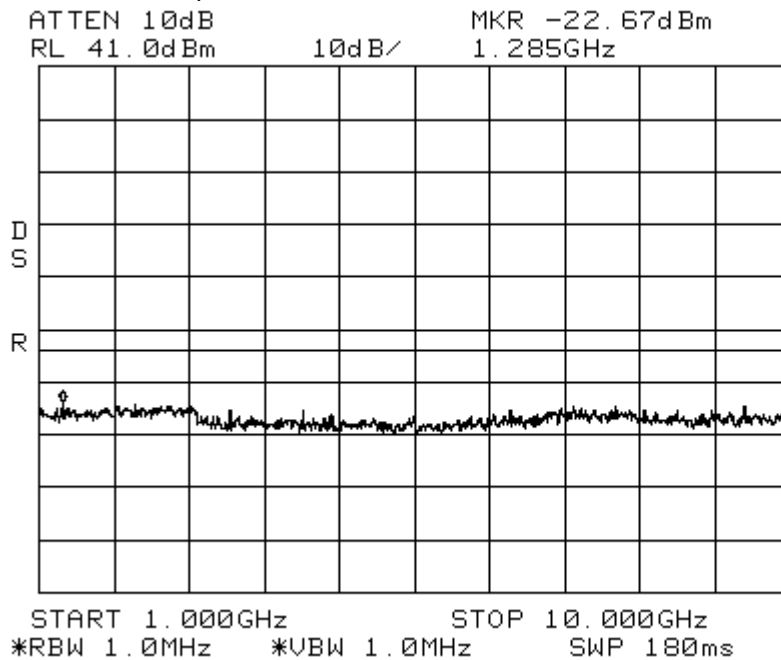

Intermodulation LTE 1.4 MHz Channel Bandwidth_Low Spectrum 700 MHz Upper C Path 1
 Center: 751 MHz Span: 35 MHz RBW/VBW: 100 kHz

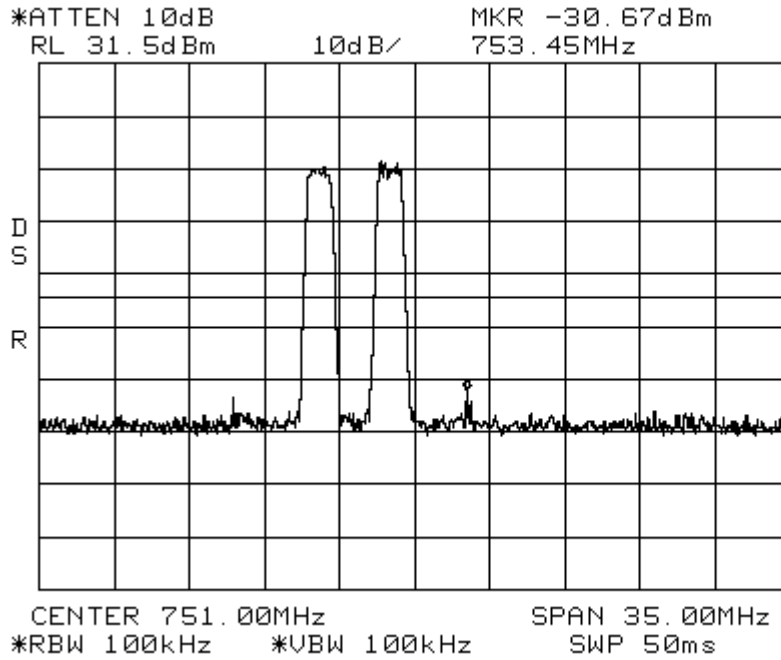

Intermodulation LTE 1.4 MHz Channel Bandwidth _Low Spectrum 700 MHz Upper C Path 1
 Span: 30 MHz to 1 GHz RBW/VBW: 300 kHz

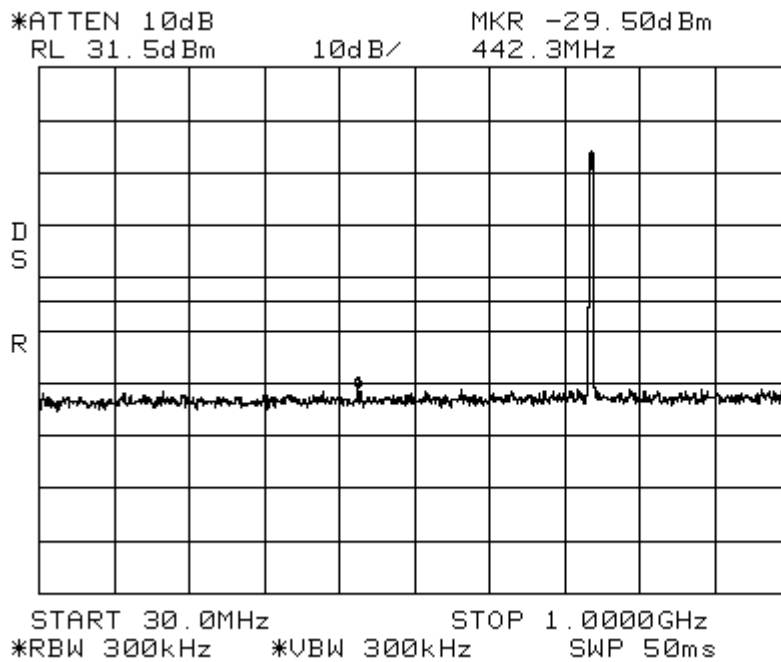

Intermodulation LTE 1.4 MHz Channel Bandwidth _High Spectrum 700 MHz Upper C Path 1
 Span: 30 MHz to 1 GHz RBW/VBW: 300 kHz

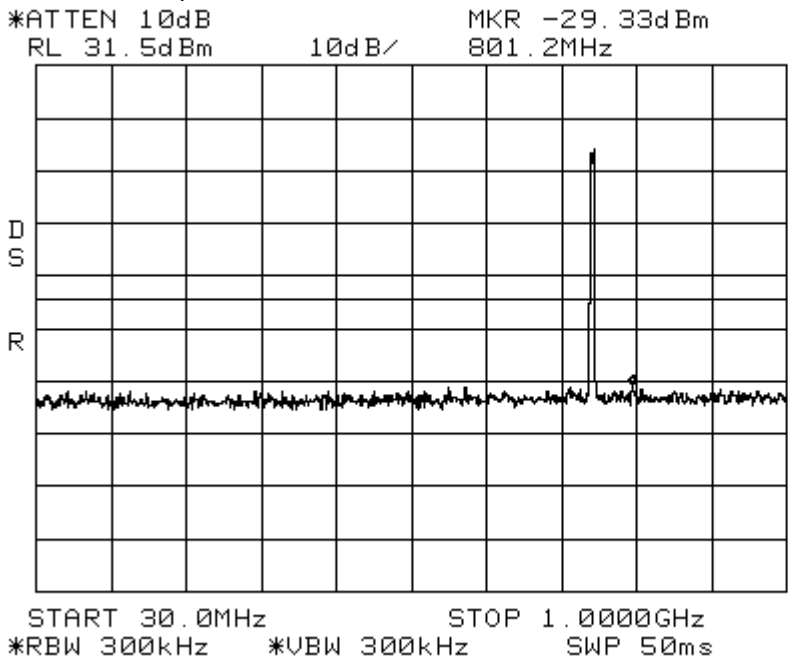

Intermodulation LTE 1.4 MHz Channel Bandwidth _High Spectrum 700 MHz Upper C Path 1
 Span: 1 GHz to 10 GHz RBW/VBW: 1 MHz

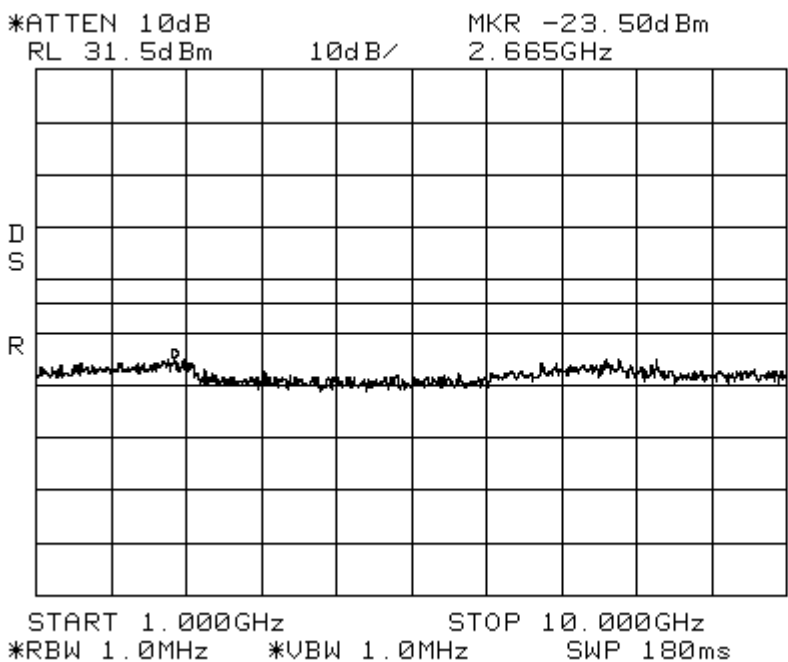

Intermodulation LTE 1.4 MHz Channel Bandwidth _Apart Spectrum 700 MHz Upper C Path 1

Center: 751 MHz Span: 70 MHz RBW/VBW: 100 kHz
*ATTEN 10dB MKR -30.33dBm
RL 31.5dBm 10dB/ 737.47MHz

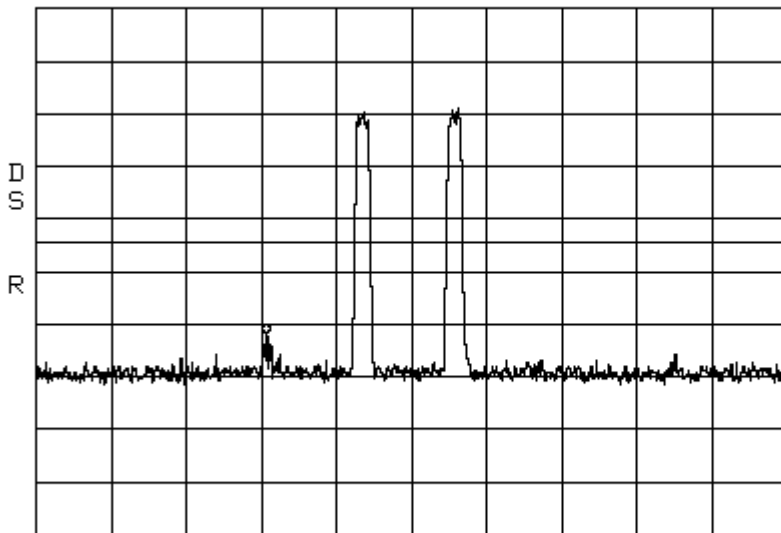

CENTER 751.00MHz SPAN 70.00MHz
*RBW 100kHz *VBW 100kHz SWP 50ms

Intermodulation LTE 1.4 MHz Channel Bandwidth _Apart Spectrum 700 MHz Upper C Path 1

Span: 30 MHz to 1 GHz RBW/VBW: 300 kHz

*ATTEN 10dB MKR -29.33dBm
RL 31.5dBm 10dB/ 626.6MHz

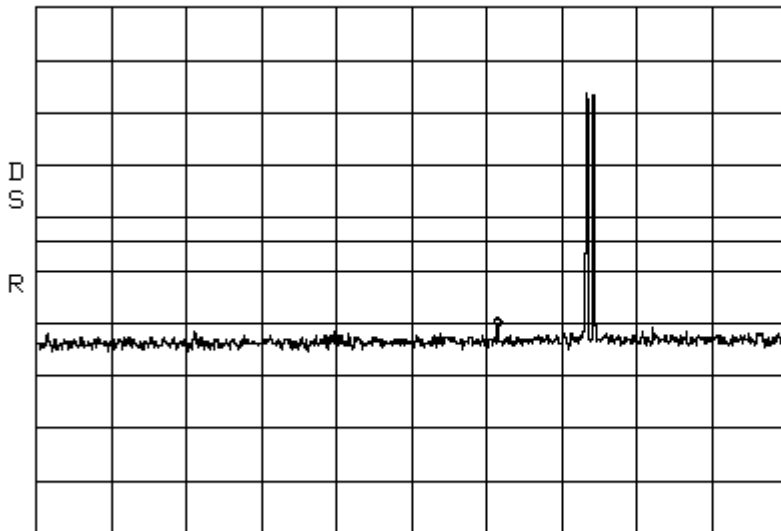

START 30.0MHz STOP 1.0000GHz
*RBW 300kHz *VBW 300kHz SWP 50ms

Intermodulation LTE 1.4 MHz Channel Bandwidth _Apart Spectrum 700 MHz Upper C Path 1
 Span: 1 GHz to 10 GHz RBW/VBW: 1 MHz

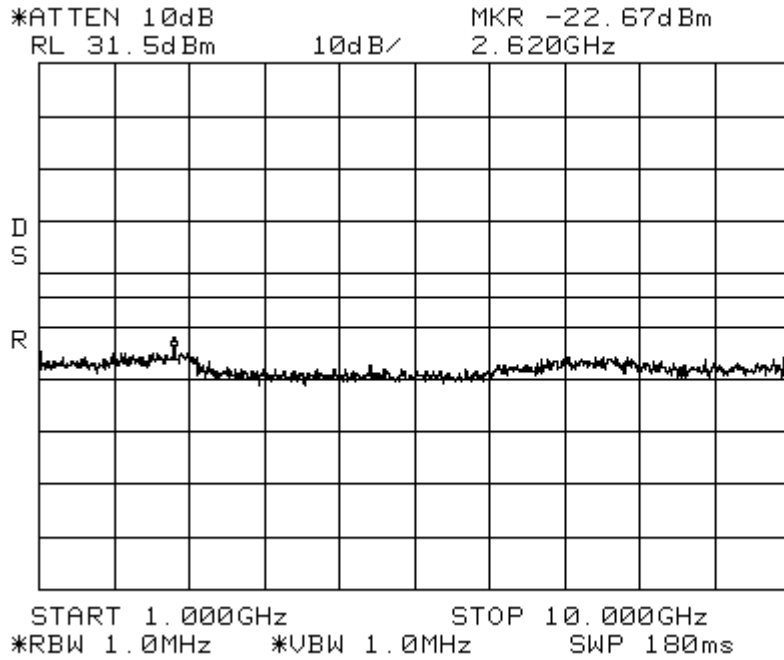

Intermodulation LTE 3 MHz Channel Bandwidth_Low Spectrum 700 MHz Upper C Path 1
 Center: 751 MHz Span: 35 MHz RBW/VBW: 100 kHz

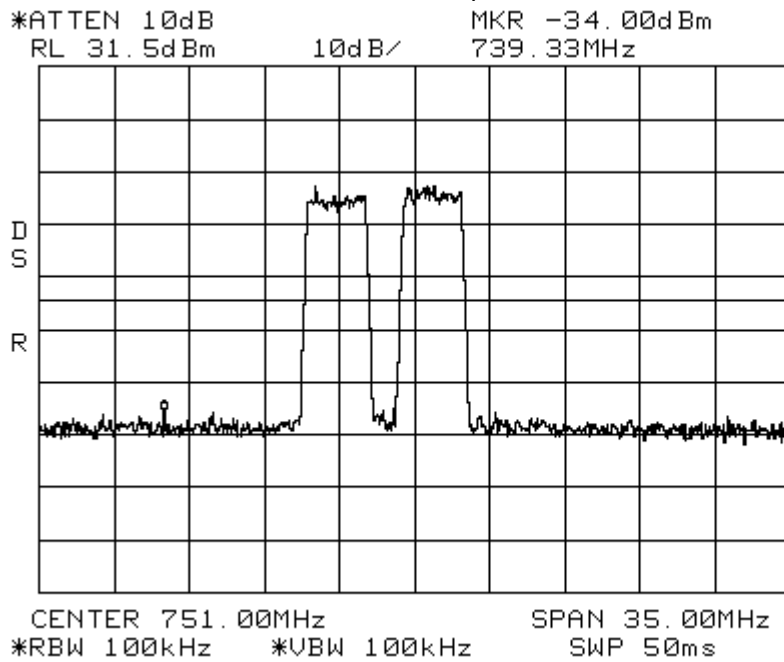

Intermodulation LTE 3MHz Channel Bandwidth _Low Spectrum 700 MHz Upper C Path 1
Span: 30 MHz to 1 GHz RBW/VBW: 300 kHz

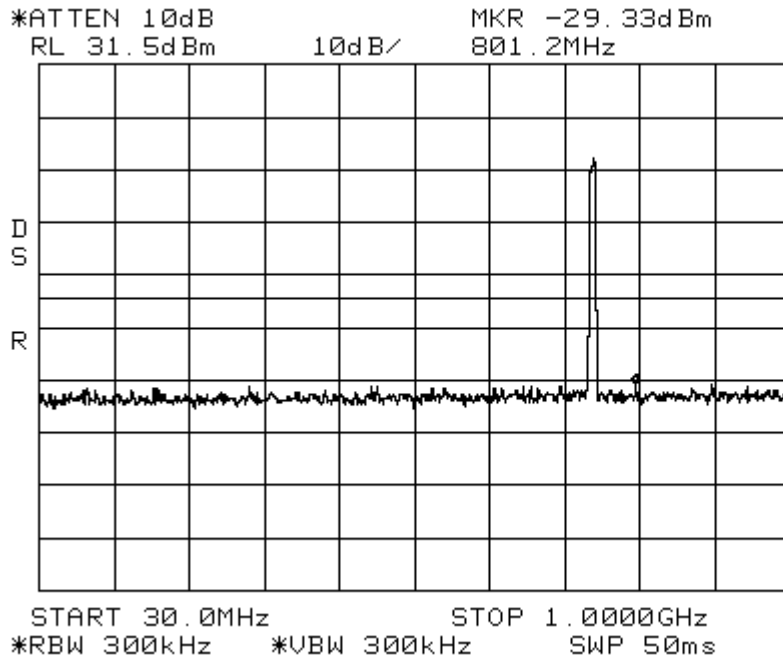

Intermodulation LTE 3 MHz Channel Bandwidth _Low Spectrum 700 MHz Upper C Path 1
Span: 1 GHz to 10 GHz RBW/VBW: 1 MHz

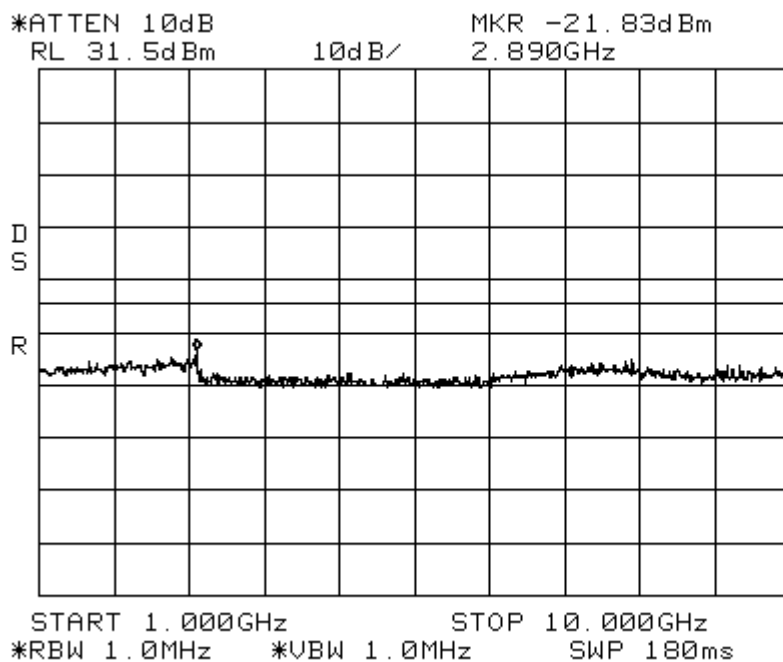

Intermodulation LTE 3 MHz Channel Bandwidth_High Spectrum 700 MHz Upper C Path 1

Center: 751 MHz

Span: 35 MHz

RBW/VBW: 100 kHz

*ATTEN 10dB

MKR -33.33dBm

RL 31.5dBm

10dB/

747.79MHz

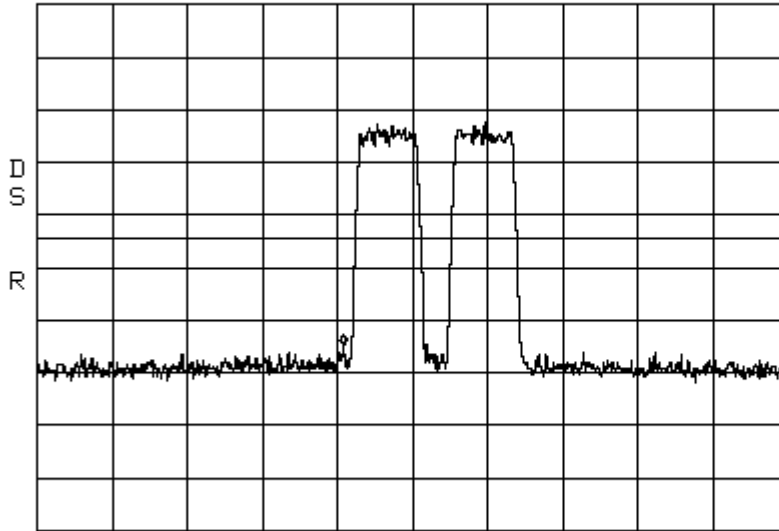

CENTER 751.00MHz

SPAN 35.00MHz

*RBW 100kHz

*VBW 100kHz

SWP 50ms

Intermodulation LTE 3 MHz Channel Bandwidth_High Spectrum 700 MHz Upper C Path 1

Span: 30 MHz to 1 GHz

RBW/VBW: 300 kHz

*ATTEN 10dB

MKR -28.83dBm

RL 31.5dBm

10dB/

993.5MHz

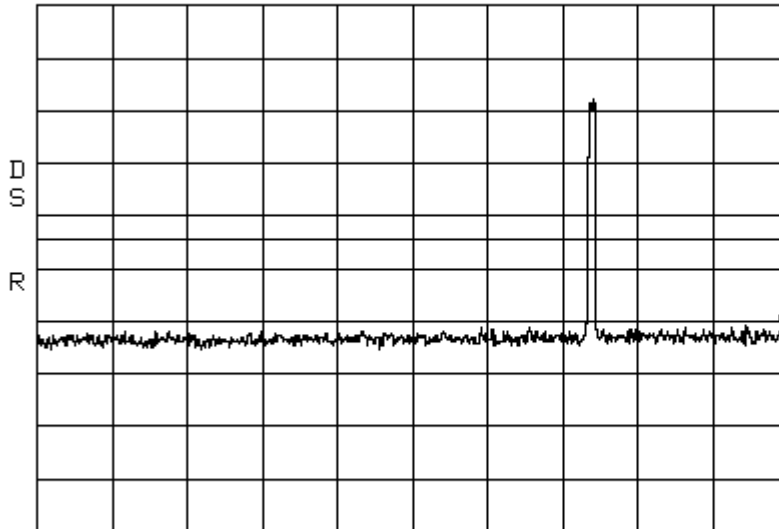

START 30.0MHz

STOP 1.0000GHz

*RBW 300kHz

*VBW 300kHz

SWP 50ms

Intermodulation LTE 3 MHz Channel Bandwidth _High Spectrum 700 MHz Upper C Path 1
Span: 1 GHz to 10 GHz RBW/VBW: 1 MHz

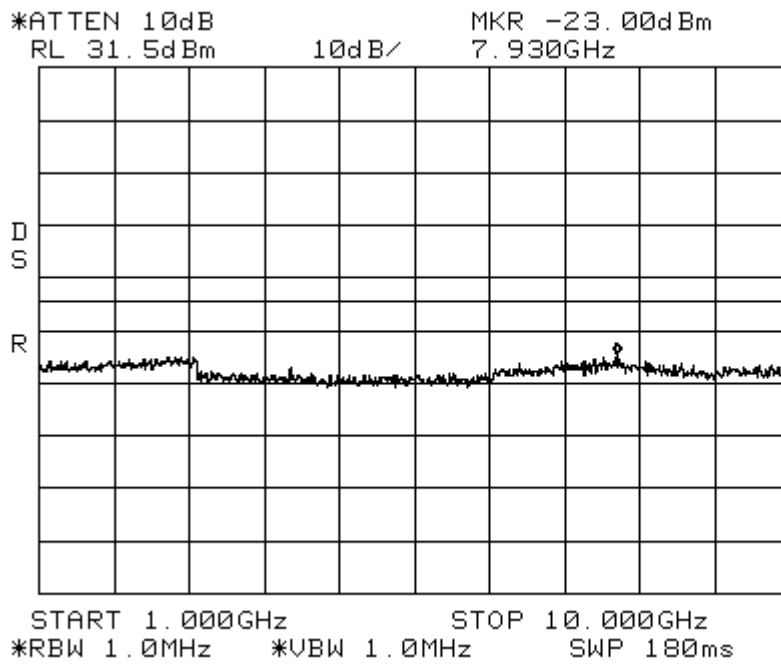

Intermodulation LTE 3 MHz Channel Bandwidth _Apart Spectrum 700 MHz Upper C Path 1
Center: 751 MHz Span: 70 MHz RBW/VBW: 100 kHz

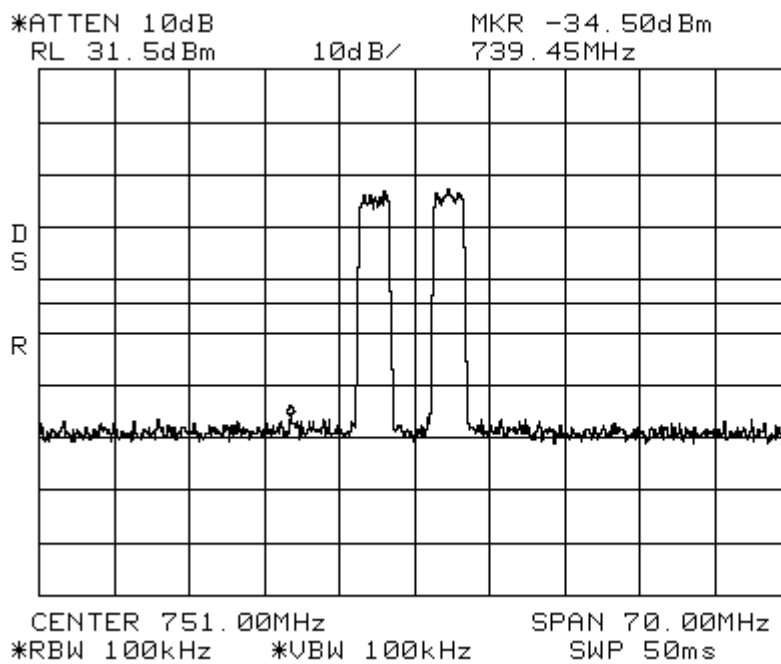

Intermodulation LTE 5 MHz Channel Bandwidth **Low** Spectrum 700 MHz Upper C Path 1
Center: 751 MHz Span: 35 MHz RBW/VBW: 100 kHz

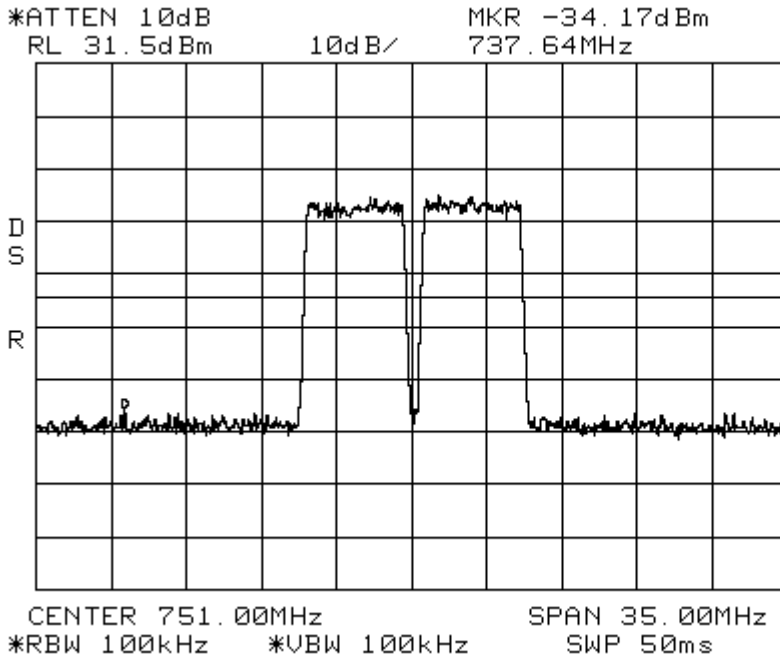

Intermodulation LTE 5 MHz Channel Bandwidth **Low** Spectrum 700 MHz Upper C Path 1
Span: 30 MHz to 1 GHz RBW/VBW: 300 kHz

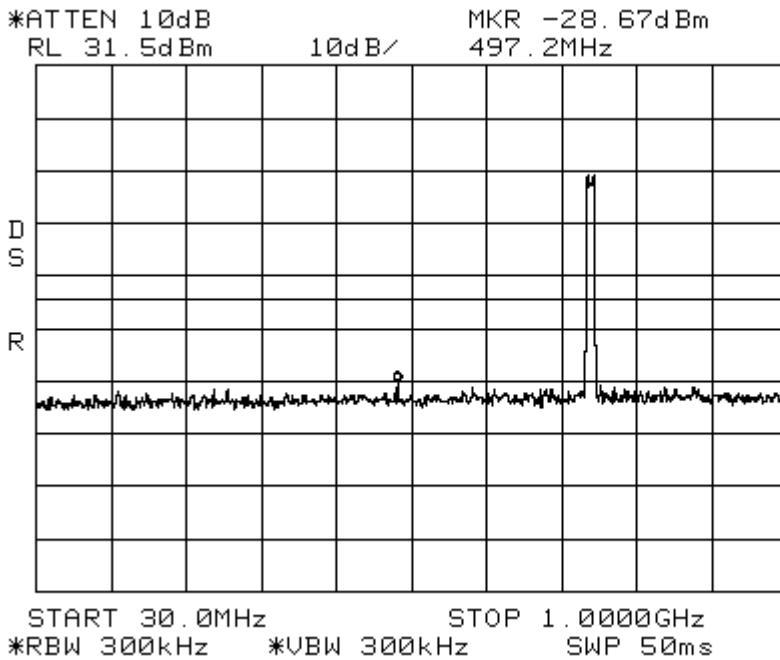

Intermodulation LTE 5 MHz Channel Bandwidth_Low Spectrum 700 MHz Upper C Path 1
Span: 1 GHz to 10 GHz RBW/VBW: 1 MHz

*ATTEN 10dB MKR -23.33dBm
RL 31.5dBm 10dB/ 7.405GHz

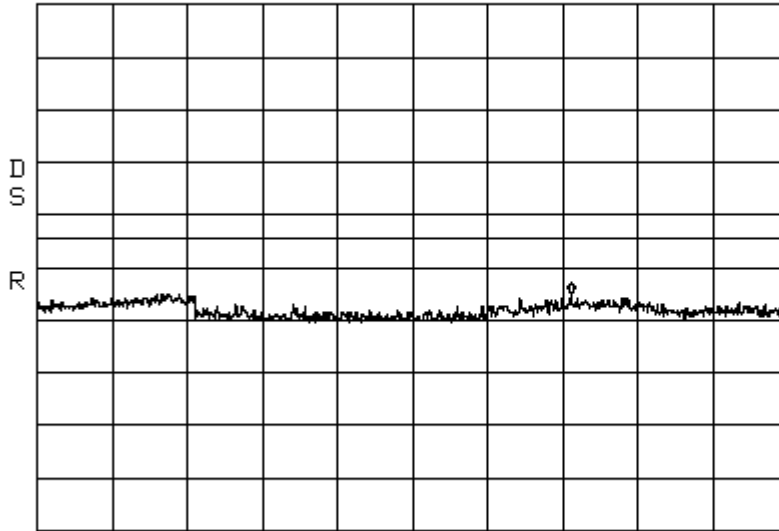

START 1.000GHz STOP 10.000GHz
*RBW 1.0MHz *VBW 1.0MHz SWP 180ms

Intermodulation LTE 5 MHz Channel Bandwidth_High Spectrum 700 MHz Upper C Path 1
Center: 751 MHz Span: 35 MHz RBW/VBW: 100 kHz

*ATTEN 10dB MKR -33.67dBm
RL 31.5dBm 10dB/ 744.06MHz

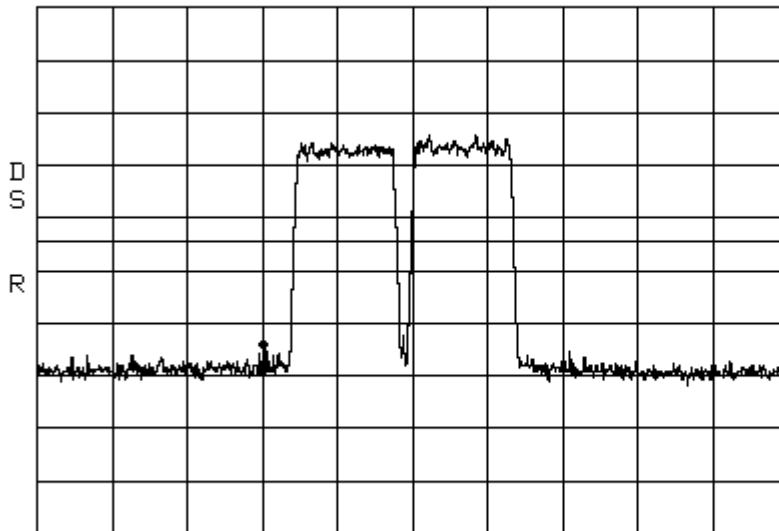

CENTER 751.00MHz SPAN 35.00MHz
*RBW 100kHz *VBW 100kHz SWP 50ms

Intermodulation LTE 5 MHz Channel Bandwidth_Apart Spectrum 700 MHz Upper C Path 1
Center: 751 MHz Span: 35 MHz RBW/VBW: 100 kHz

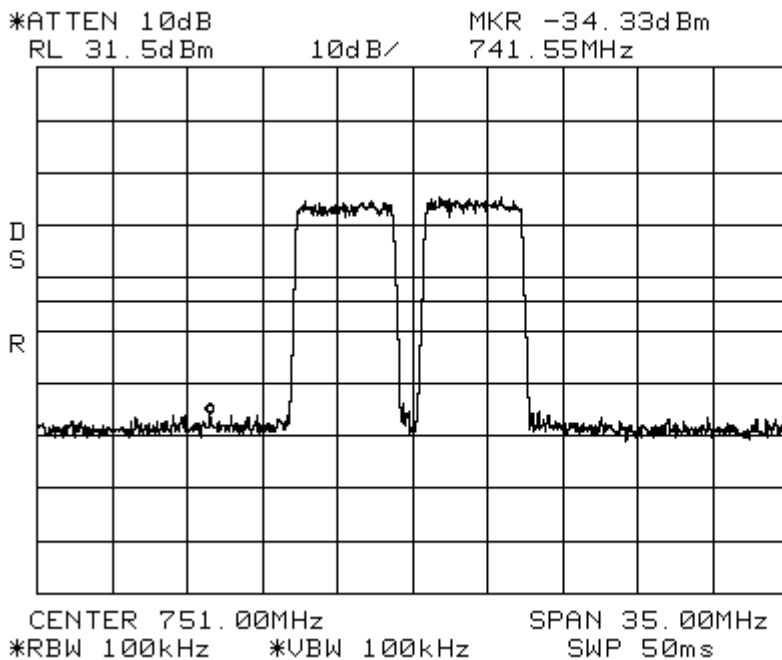

Intermodulation LTE 5 MHz Channel Bandwidth_Apart Spectrum 700 MHz Upper C Path 1
Span: 30 MHz to 1 GHz RBW/VBW: 300 kHz

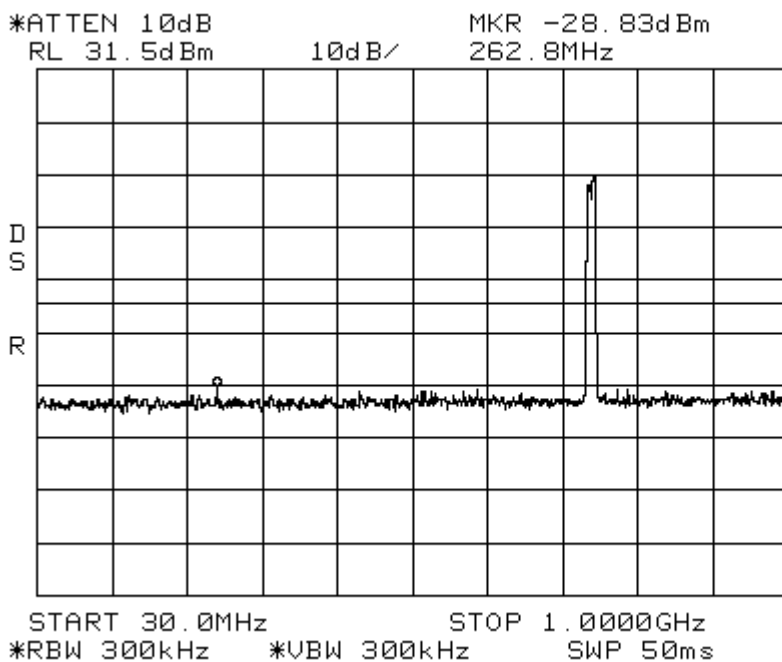

Intermodulation LTE 5 MHz Channel Bandwidth _Apart Spectrum 700 MHz Upper C Path 1
 Span: 1 GHz to 10 GHz RBW/VBW: 1 MHz

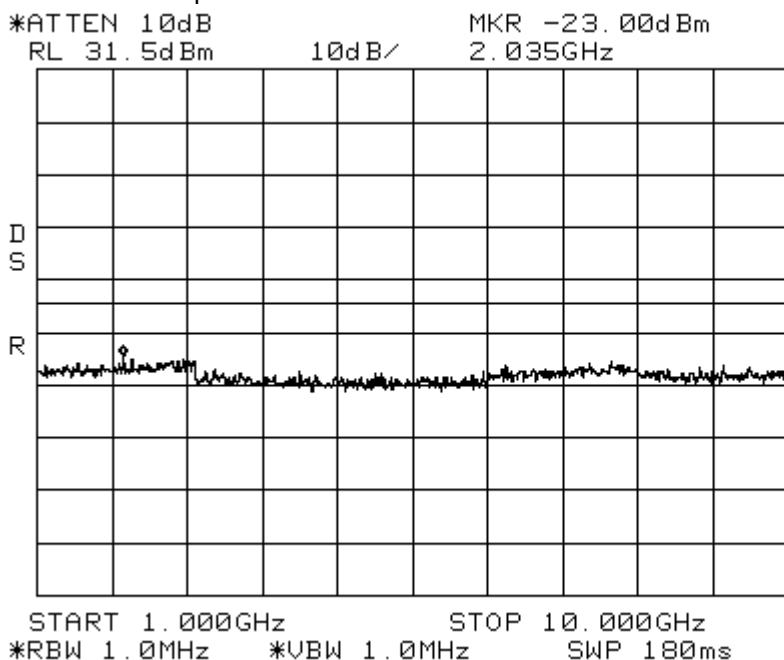

Intermodulation LTE 1.4 MHz Channel Bandwidth_Low Spectrum 700 MHz Upper C
 Path 2
 Center: 751 MHz Span: 35 MHz RBW/VBW: 100 kHz

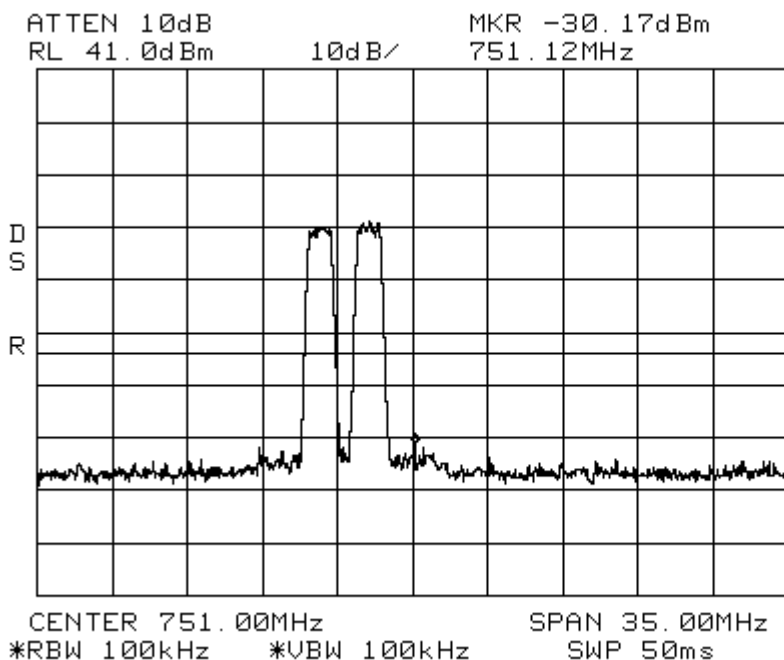

Intermodulation LTE 1.4 MHz Channel Bandwidth _High Spectrum 700 MHz Upper C Path 2

Center: 751 MHz Span: 35 MHz RBW/VBW: 100 kHz
ATTEN 10dB MKR -27.17dBm
RL 41.0dBm 10dB/ 750.94MHz

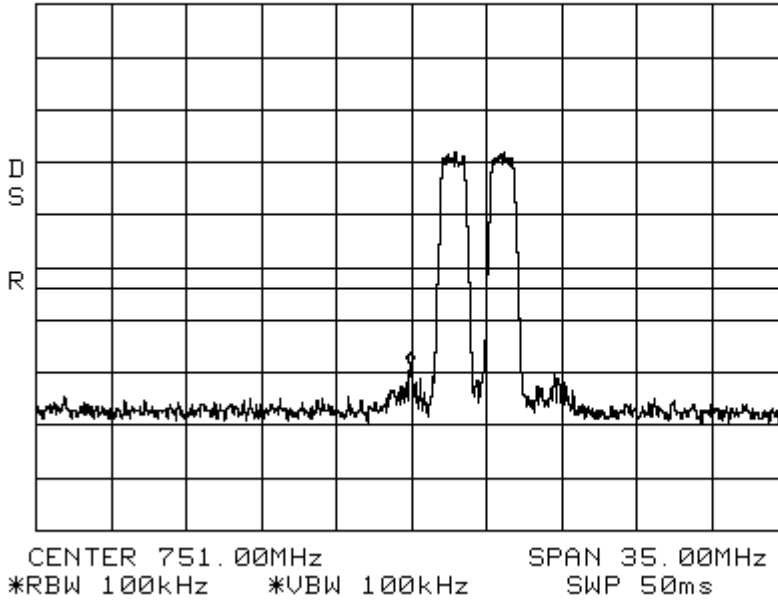

Intermodulation LTE 1.4 MHz Channel Bandwidth _High Spectrum 700 MHz Upper C Path 2

Span: 30 MHz to 1 GHz RBW/VBW: 300 kHz
ATTEN 10dB MKR -28.83dBm
RL 41.0dBm 10dB/ 846.4MHz

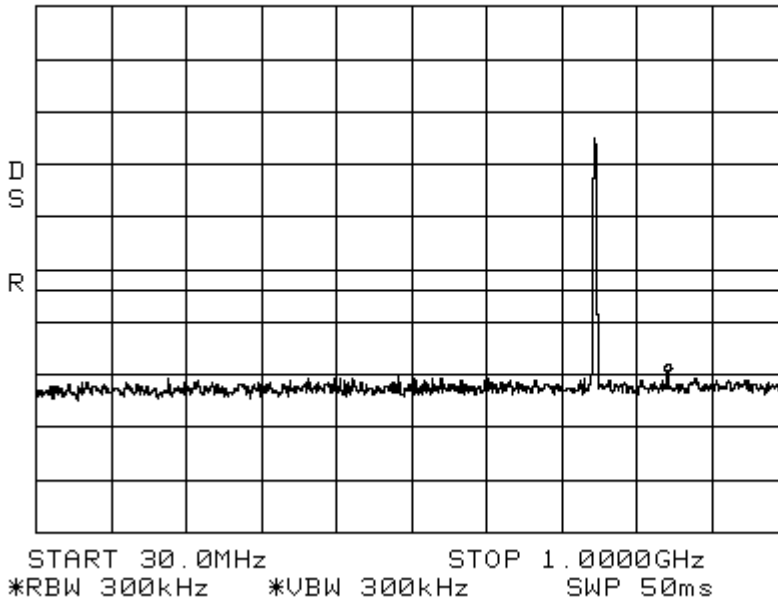

Intermodulation LTE 1.4 MHz Channel Bandwidth _High Spectrum 700 MHz Upper C Path 2
Span: 1 GHz to 10 GHz RBW/VBW: 1 MHz

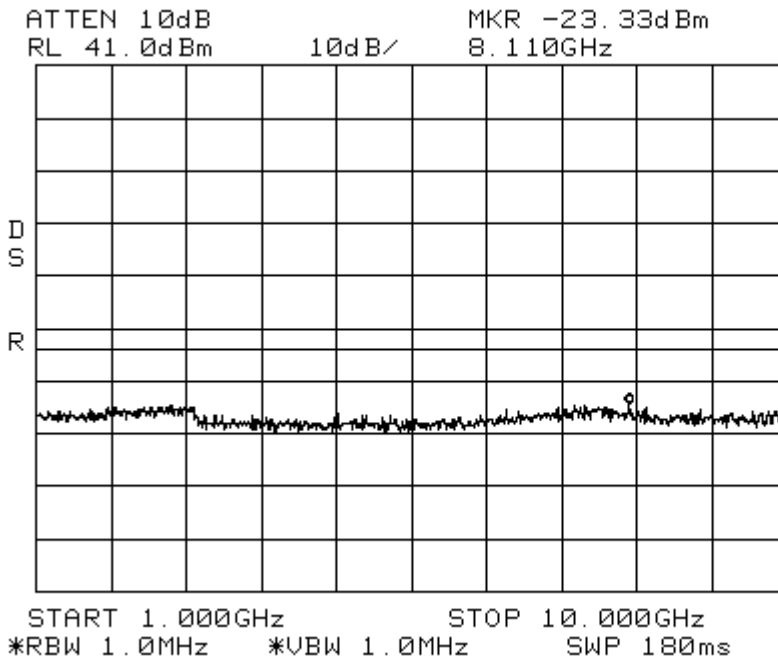

Intermodulation LTE 1.4 MHz Channel Bandwidth _Apart Spectrum 700 MHz Upper C Path 2
Center: 751 MHz Span: 70 MHz RBW/VBW: 100 kHz

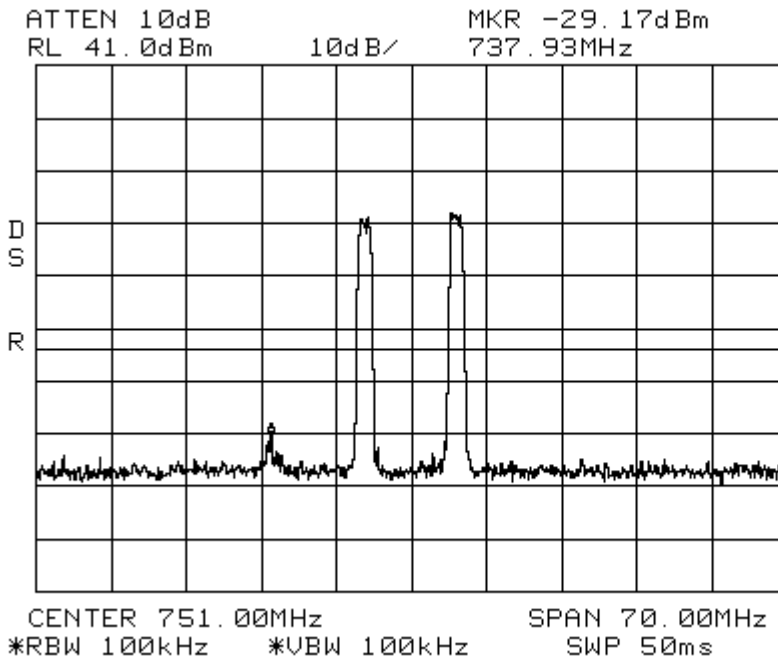

Intermodulation LTE 1.4 MHz Channel Bandwidth _Apart Spectrum 700 MHz Upper C Path 2
Span: 30 MHz to 1 GHz RBW/VBW: 300 kHz

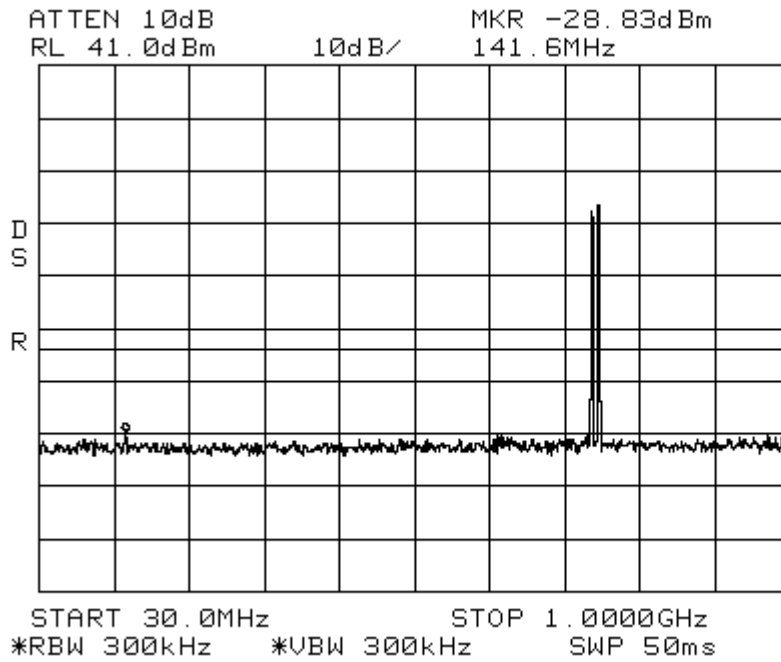

Intermodulation LTE 1.4 MHz Channel Bandwidth _Apart Spectrum 700 MHz Upper C Path 2
Span: 1 GHz to 10 GHz RBW/VBW: 1 MHz

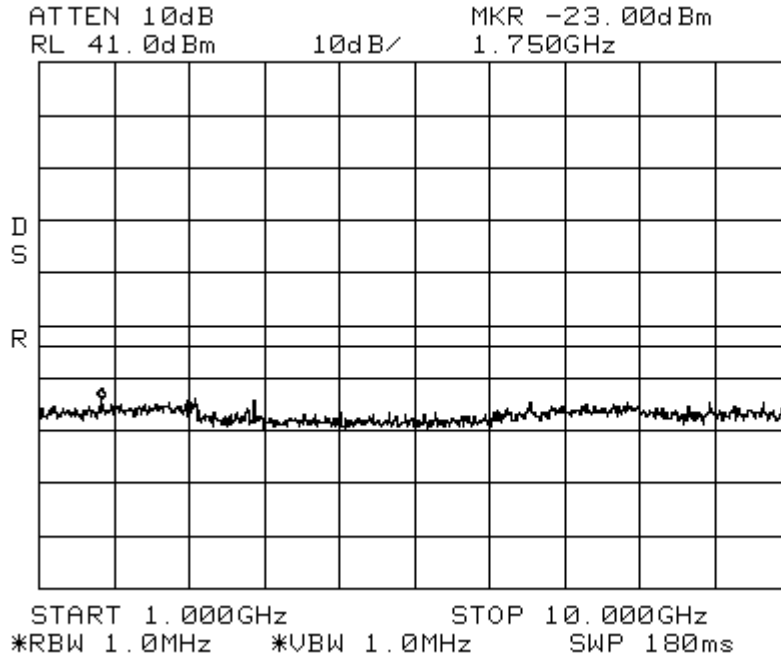

Intermodulation LTE 3 MHz Channel Bandwidth_Low Spectrum 700 MHz Upper C Path 2

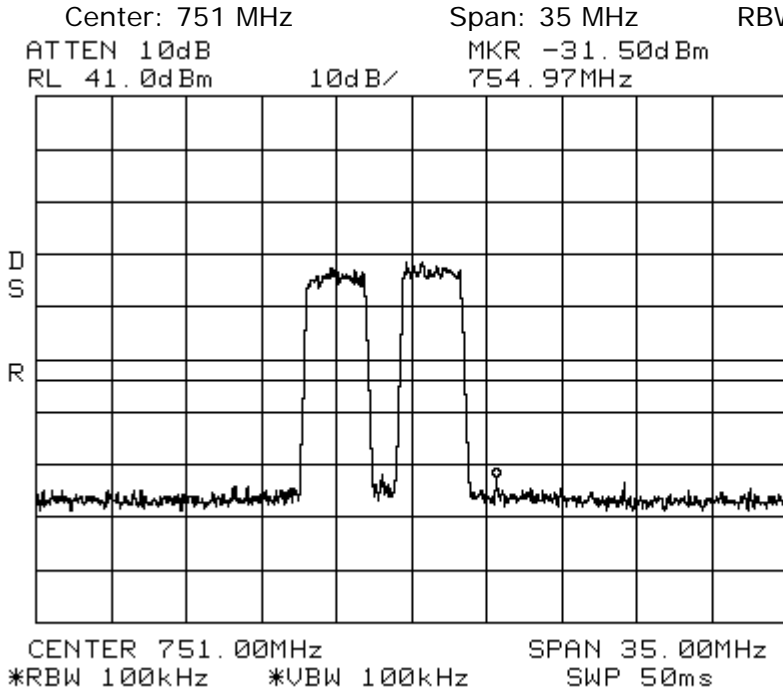

Intermodulation LTE 3MHz Channel Bandwidth_Low Spectrum 700 MHz Upper C Path 2

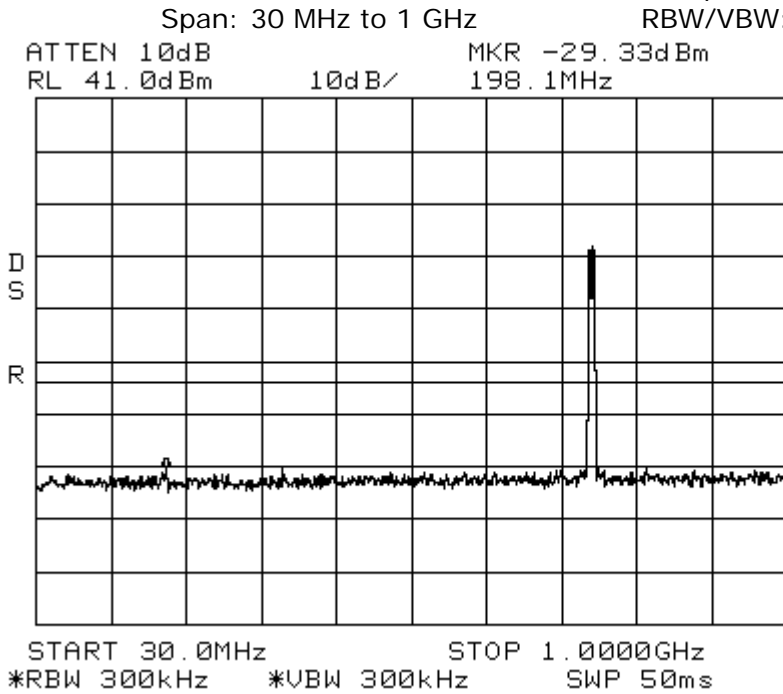

Intermodulation LTE 3 MHz Channel Bandwidth _Low Spectrum 700 MHz Upper C Path 2
Span: 1 GHz to 10 GHz RBW/VBW: 1 MHz

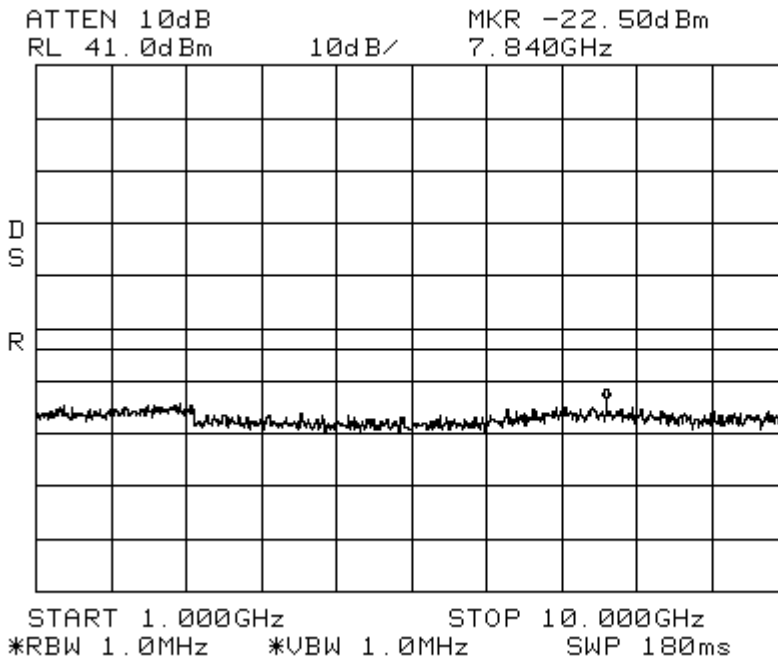

Intermodulation LTE 3 MHz Channel Bandwidth _High Spectrum 700 MHz Upper C Path 2
Center: 751 MHz Span: 35 MHz RBW/VBW: 100 kHz

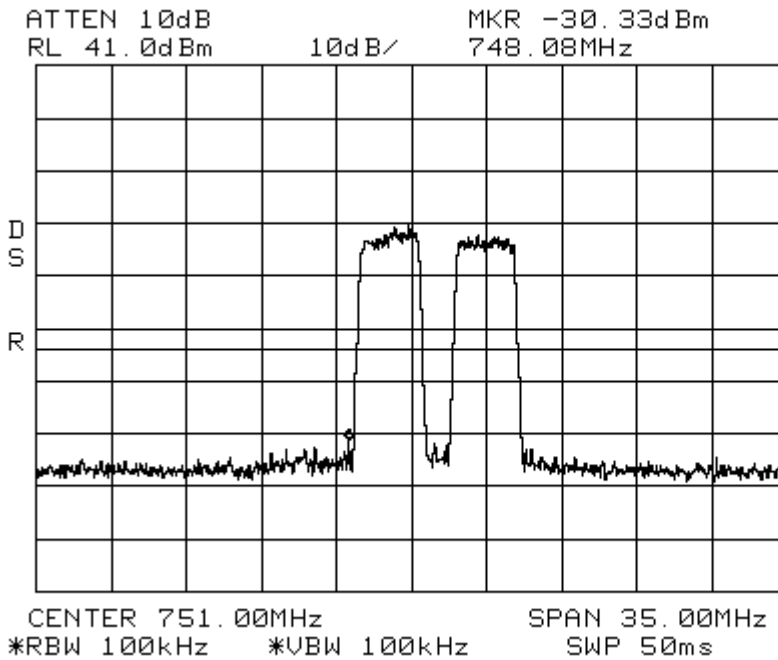

Intermodulation LTE 3 MHz Channel Bandwidth _Apart Spectrum 700 MHz Upper C Path 2
Center: 751 MHz Span: 70 MHz RBW/VBW: 100 kHz

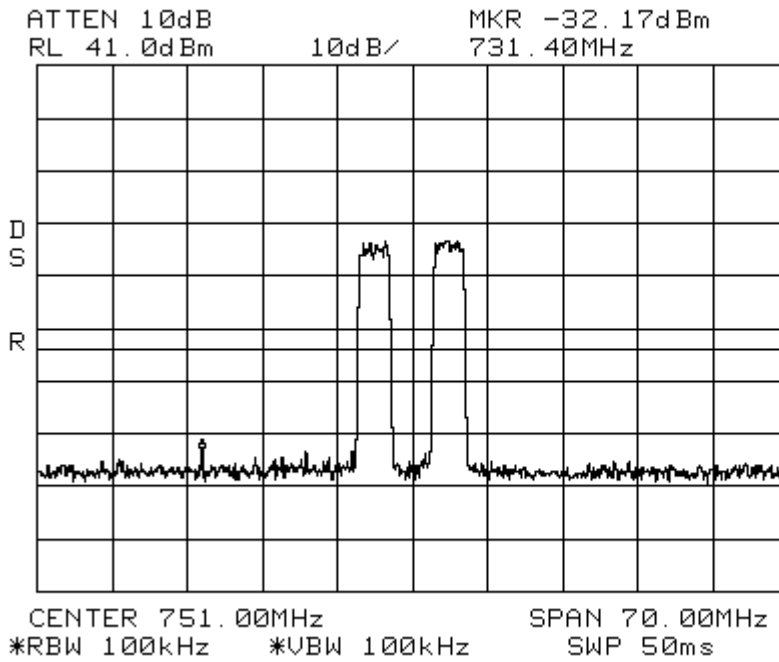

Intermodulation LTE 3 MHz Channel Bandwidth _Apart Spectrum 700 MHz Upper C Path 2
Span: 30 MHz to 1 GHz RBW/VBW: 300 kHz

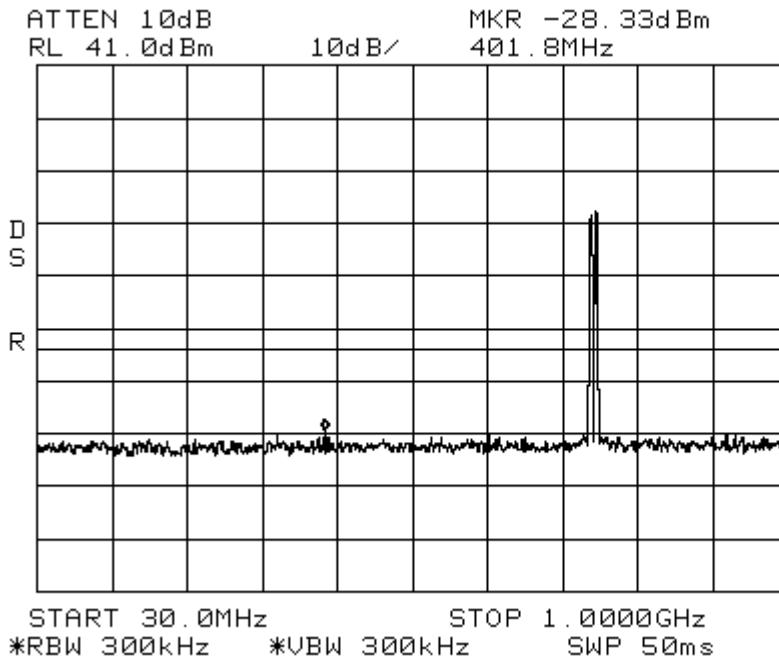

Intermodulation LTE 3 MHz Channel Bandwidth _Apart Spectrum 700 MHz Upper C Path 2
Span: 1 GHz to 10 GHz RBW/VBW: 1 MHz

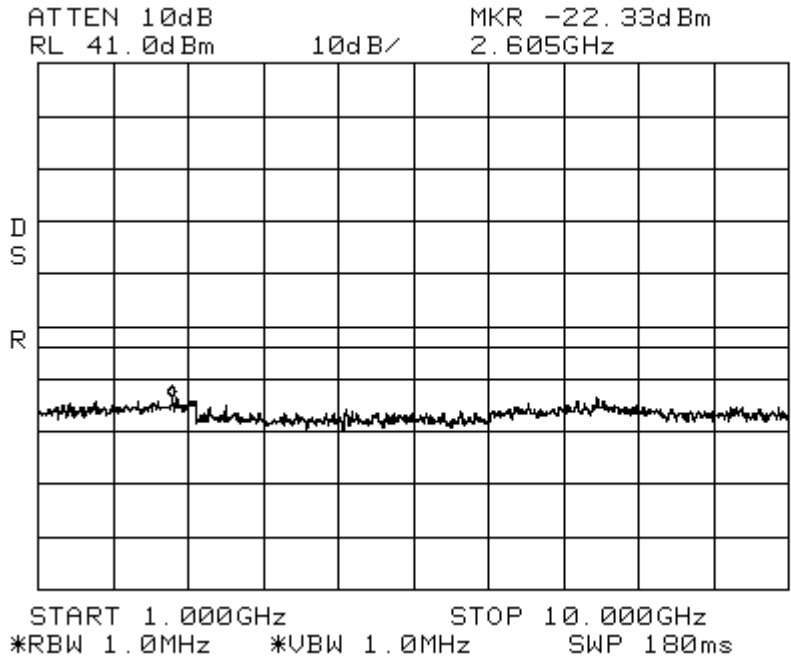

Intermodulation LTE 5 MHz Channel Bandwidth_Low Spectrum 700 MHz Upper C Path 2
Center: 751 MHz Span: 35 MHz RBW/VBW: 100 kHz

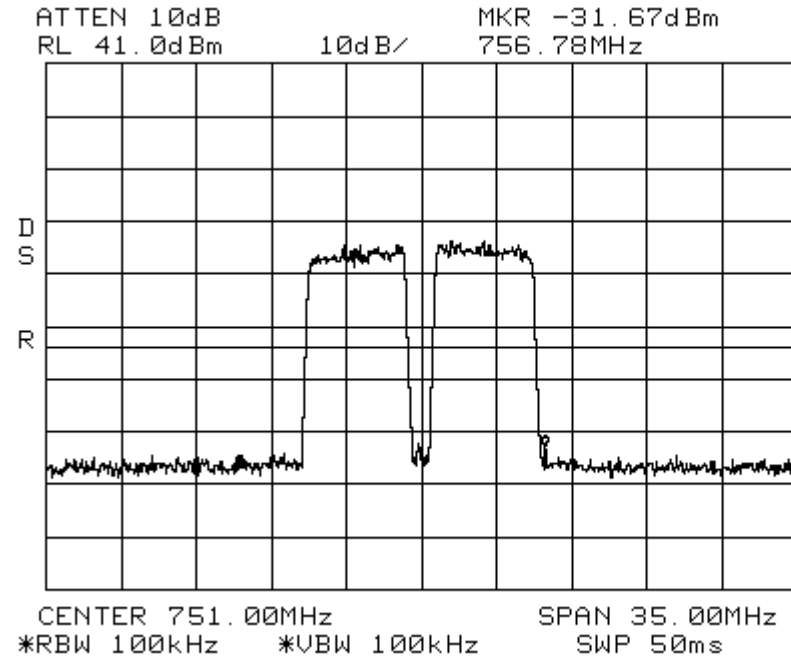

Intermodulation LTE 5 MHz Channel Bandwidth _Low Spectrum 700 MHz Upper C Path 2
Span: 30 MHz to 1 GHz RBW/VBW: 300 kHz

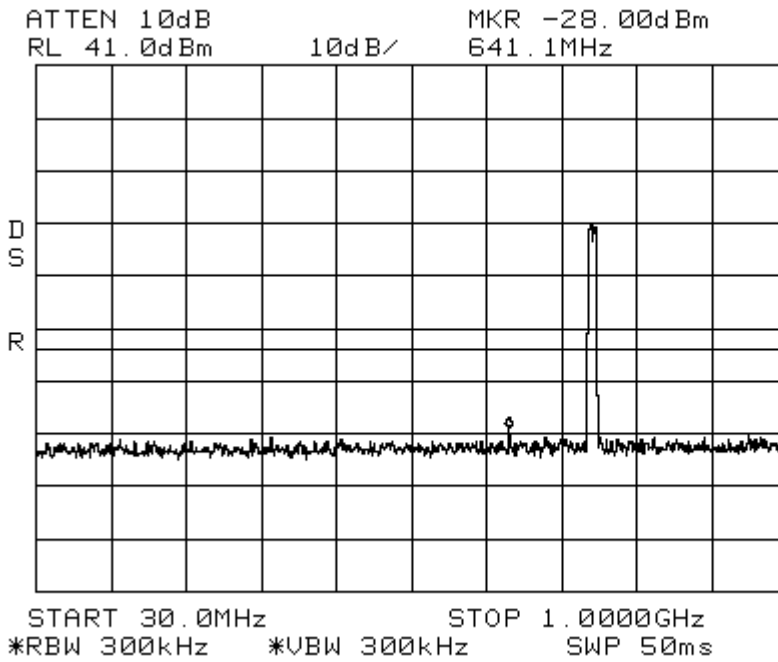

Intermodulation LTE 5 MHz Channel Bandwidth _Low Spectrum 700 MHz Upper C Path 2
Span: 1 GHz to 10 GHz RBW/VBW: 1 MHz

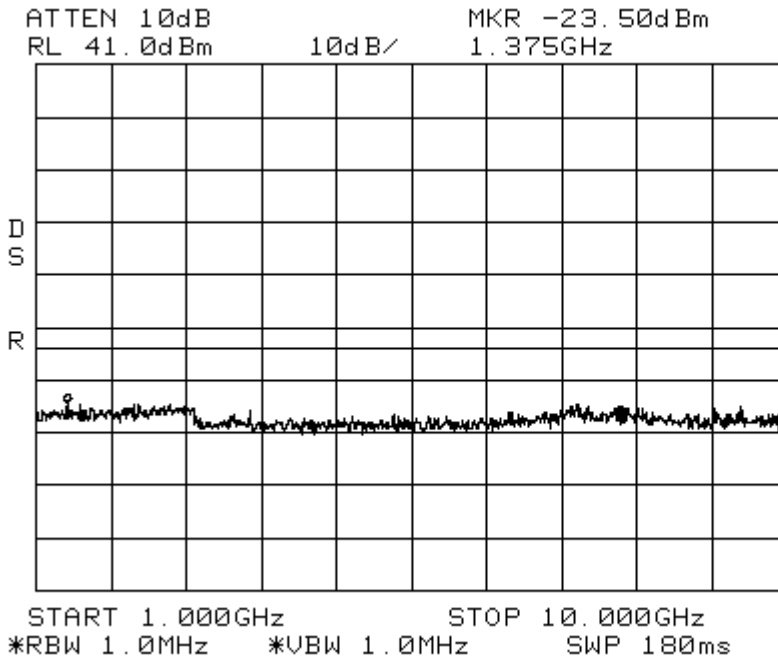

Intermodulation LTE 5 MHz Channel Bandwidth_High Spectrum 700 MHz Upper C Path 2
Center: 751 MHz Span: 35 MHz RBW/VBW: 100 kHz

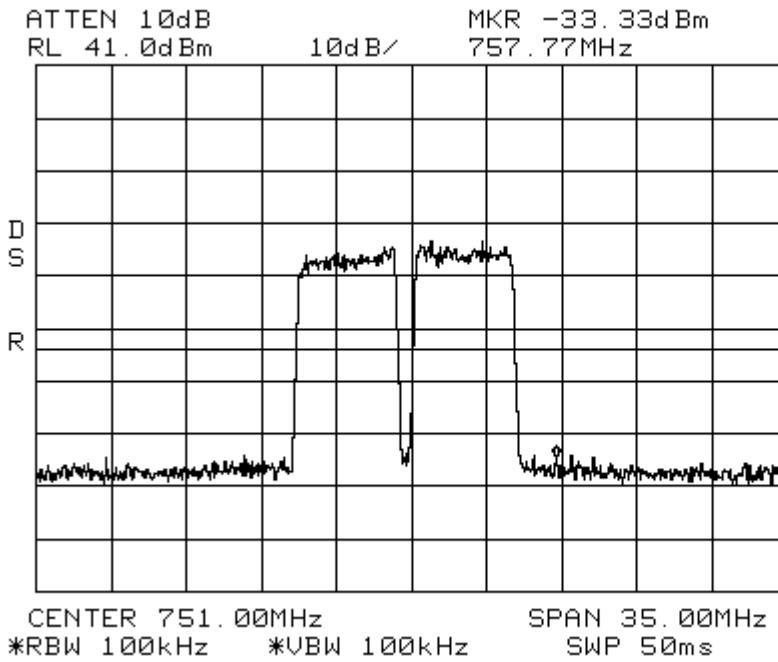

Intermodulation LTE 5 MHz Channel Bandwidth _High Spectrum 700 MHz Upper C Path 2
Span: 30 MHz to 1 GHz RBW/VBW: 300 kHz

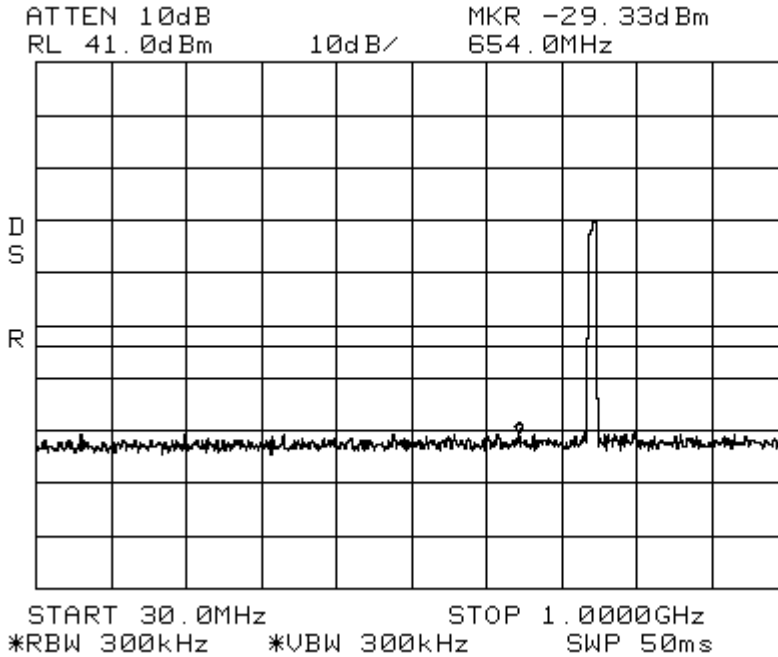

Intermodulation LTE 5 MHz Channel Bandwidth_High Spectrum 700 MHz Upper C Path 2

Span: 1 GHz to 10 GHz

RBW/VBW: 1 MHz

ATTEN 10dB MKR -22.83dBm
RL 41.0dBm 10dB/ 1.825GHz

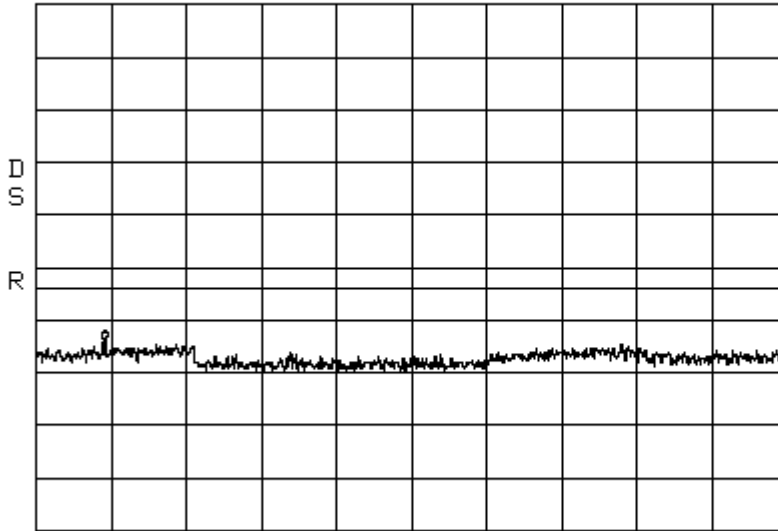

START 1.000GHz STOP 10.000GHz
*RBW 1.0MHz *VBW 1.0MHz SWP 180ms

Intermodulation LTE 5 MHz Channel Bandwidth_Apart Spectrum 700 MHz Upper C Path 2

Center: 751 MHz

Span: 35 MHz

RBW/VBW: 100 kHz

ATTEN 10dB MKR -31.33dBm
RL 41.0dBm 10dB/ 744.93MHz

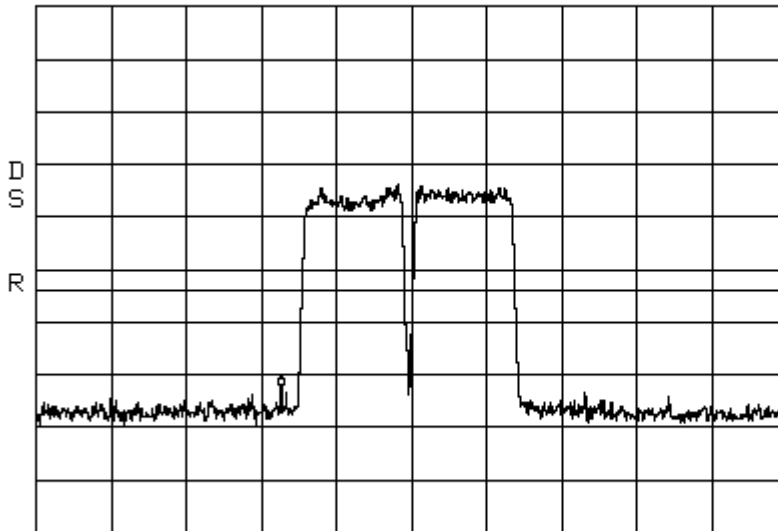

CENTER 751.00MHz SPAN 35.00MHz
*RBW 100kHz *VBW 100kHz SWP 50ms

Intermodulation LTE 5 MHz Channel Bandwidth _Apart Spectrum 700 MHz Upper C Path 2
Span: 30 MHz to 1 GHz RBW/VBW: 300 kHz

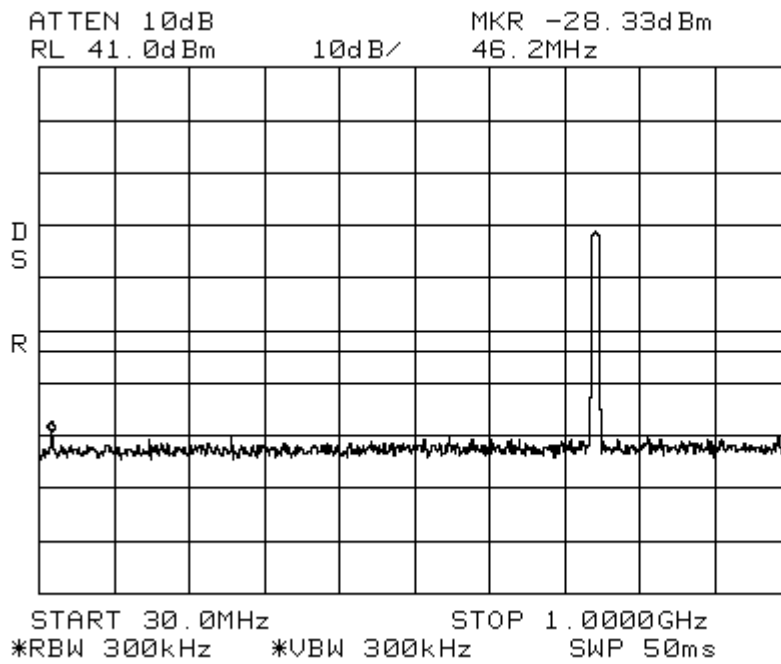

Intermodulation LTE 5 MHz Channel Bandwidth _Apart Spectrum 700 MHz Upper C Path 2
Span: 1 GHz to 10 GHz RBW/VBW: 1 MHz

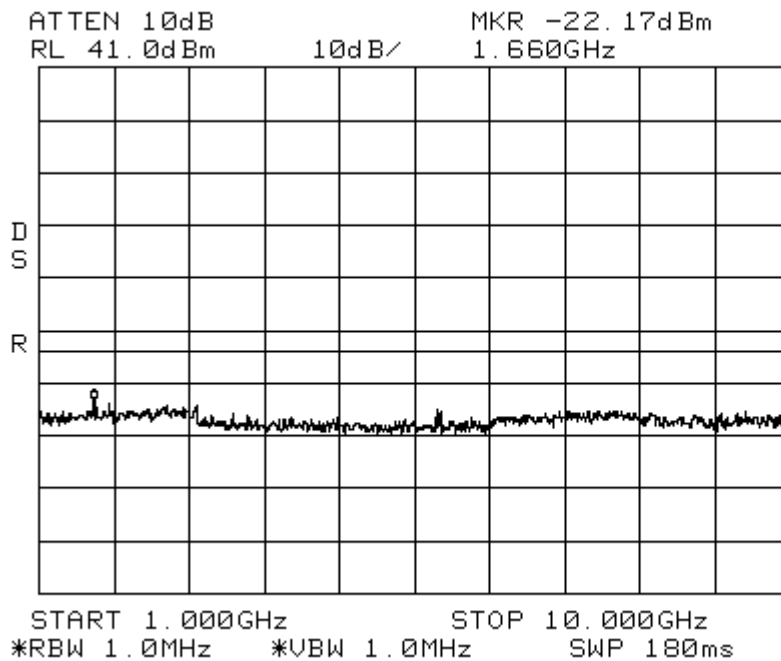

7.5 Occupied Bandwidth Modulation Test

[Table of Contents: Section 1.0](#)

[Back to Emission Limits: Section 5.1.3](#)

An input/output Occupied Bandwidth test was done with modulation types: LTE 1.4 MHz, 3 MHz, 5MHz, 10MHz, & 15MHz Channel Bandwidths. The purpose was to determine the amount of distortion added to different types of modulation schemes by the EUT. The following plots show input signals vs. output signals.

The resolution bandwidth is reduced to 1% of the estimated emission bandwidth and the video bandwidth is set to 3 times the resolution bandwidth. The markers are moved to the -20 dB points (from the previously established center frequency level) on either side of center frequency.

Results:

Pass (see plots)

Occupied Bandwidth LTE 1.4 MHz Channel Bandwidth_Signal_In Spectrum 700 MHz Lower ABC
Path 1

Span: 1.50 MHz RBW: 30 kHz VBW: 100 kHz
*ATTEN 10dB ΔMKR -.17dB
RL 31.5dBm 10dB/ 1.240MHz

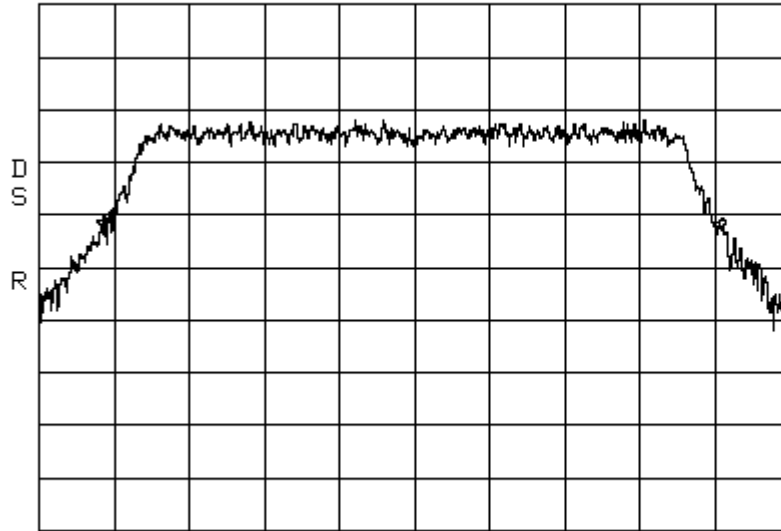

CENTER 737.000MHz SPAN 1.500MHz
*RBW 30kHz *VBW 100kHz *SWP 51ms

Occupied Bandwidth LTE 1.4 MHz Channel Bandwidth_Signal_Out Spectrum 700 MHz Lower ABC
Path 1

Span: 1.50 MHz RBW: 30 kHz VBW: 100 kHz

*ATTEN 10dB ΔMKR 0dB
RL 31.5dBm 10dB/ 1.220MHz

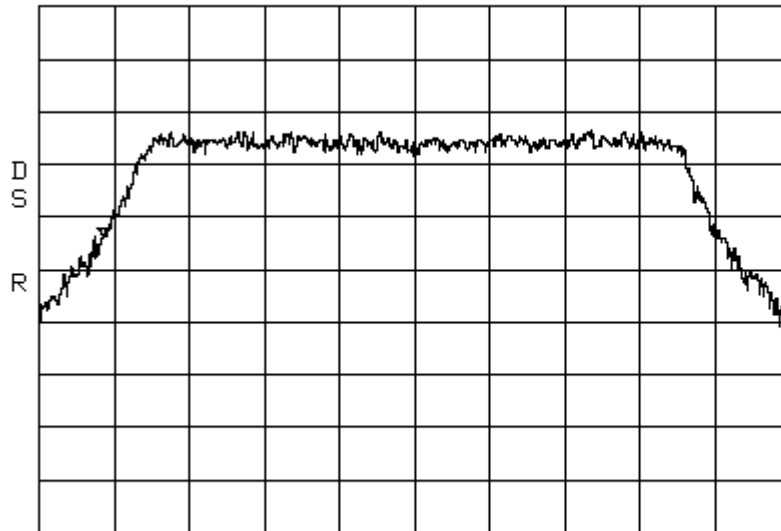

CENTER 737.000MHz SPAN 1.500MHz
*RBW 30kHz *VBW 100kHz SWP 50ms

Occupied Bandwidth LTE 3 MHz Channel Bandwidth_Signal_In Spectrum 700 MHz Lower ABC

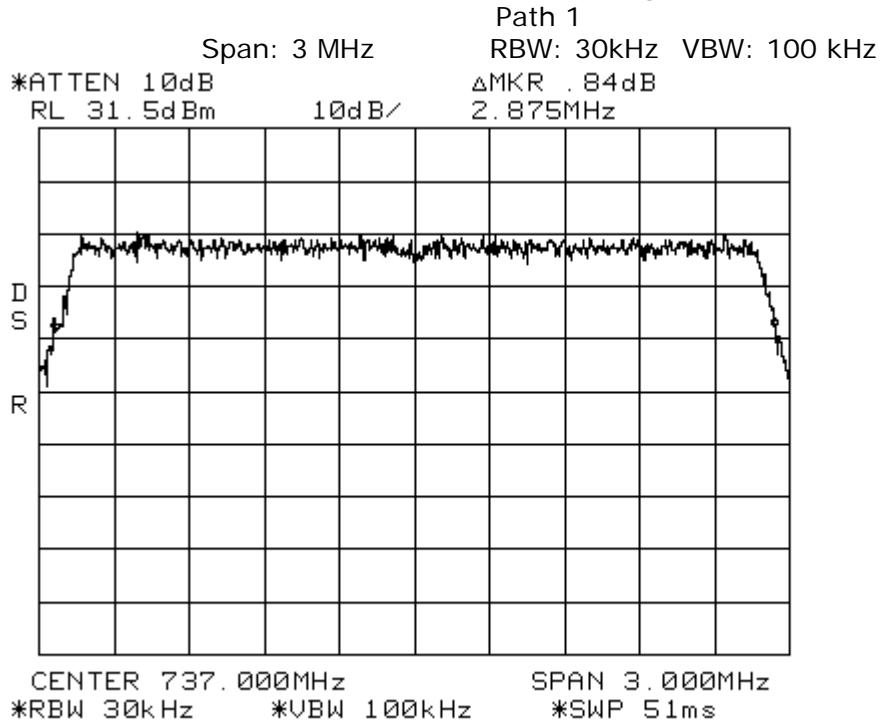

Occupied Bandwidth LTE 3 MHz Channel Bandwidth_Signal_Out Spectrum 700 MHz Lower ABC

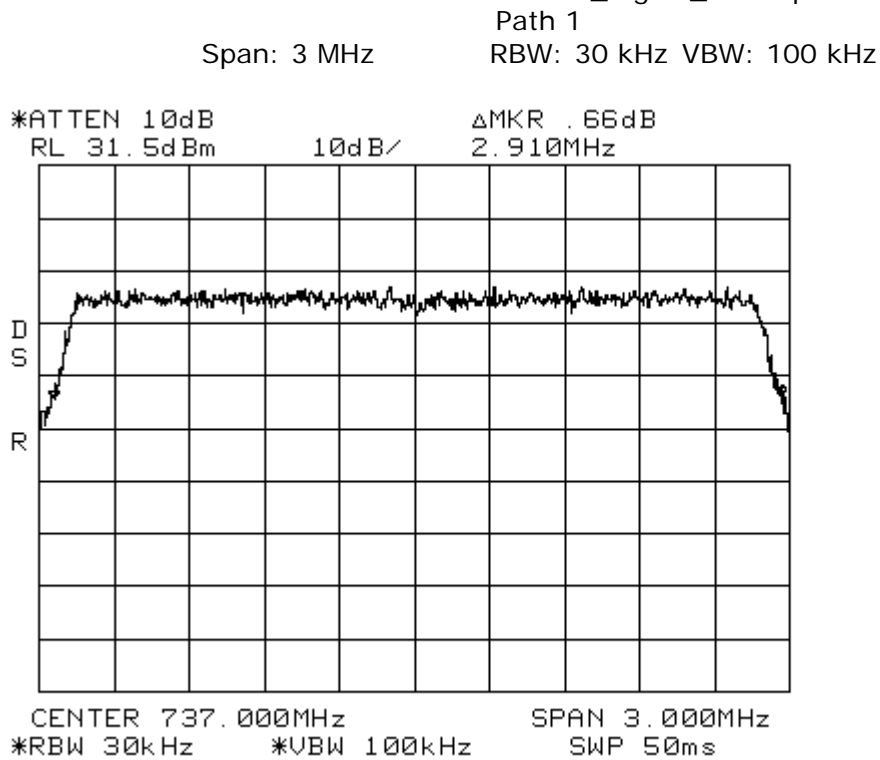

Occupied Bandwidth LTE 5 MHz Channel Bandwidth_Signal_In Spectrum 700 MHz Lower ABC

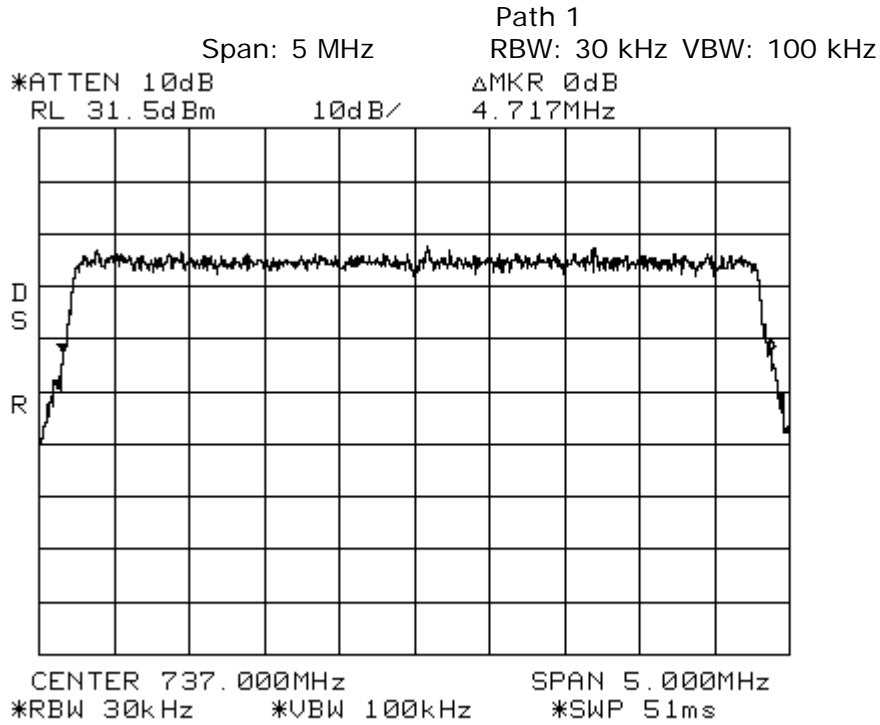

Occupied Bandwidth LTE 5 MHz Channel Bandwidth_Signal_Out Spectrum 700 MHz Lower ABC

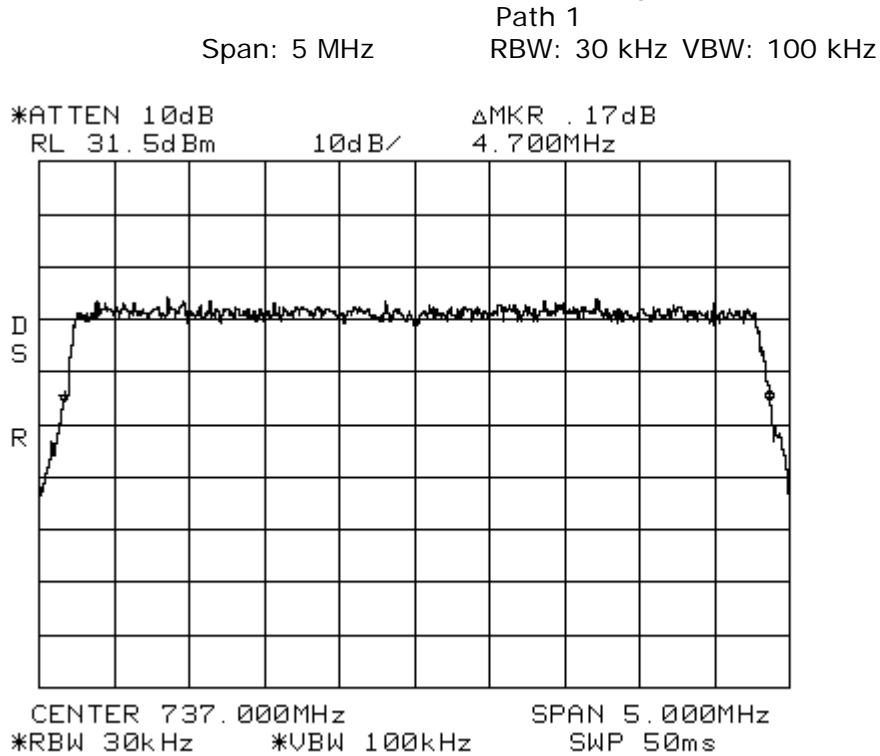

Occupied Bandwidth LTE 10 MHz Channel Bandwidth_Signal_In Spectrum 700 MHz Lower ABC

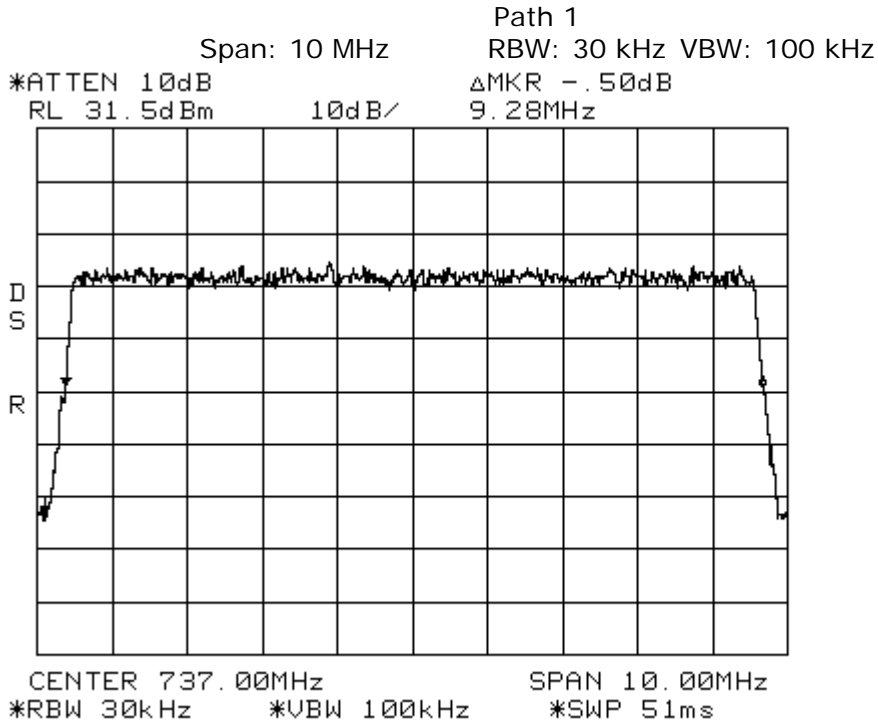

Occupied Bandwidth LTE 10 MHz Channel Bandwidth_Signal_Out Spectrum 700 MHz Lower ABC

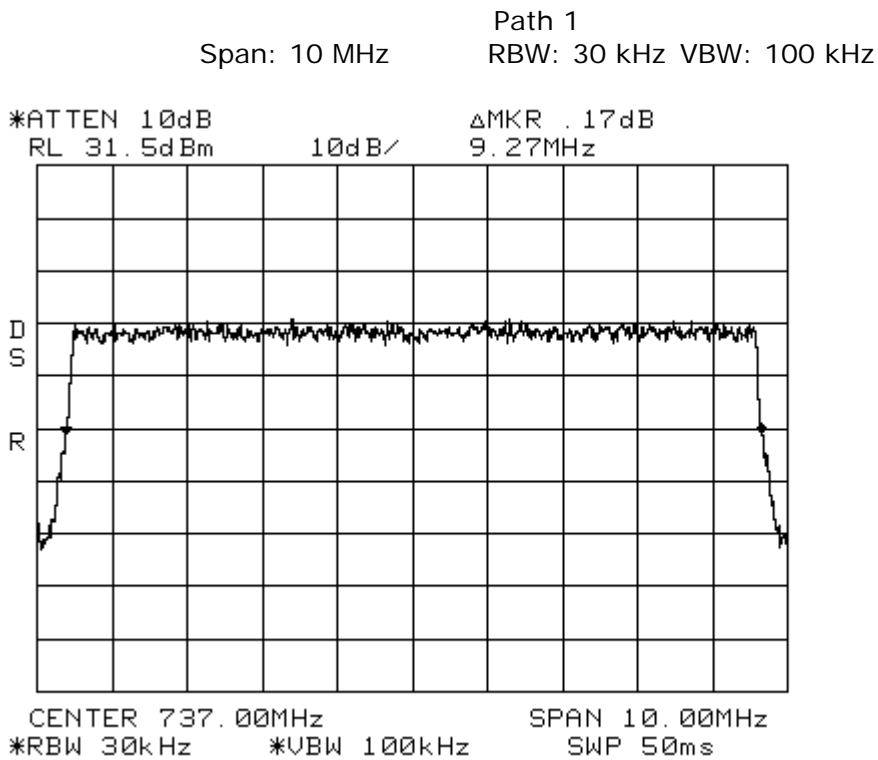

Occupied Bandwidth LTE 15 MHz Channel Bandwidth_Signal_In Spectrum 700 MHz Lower ABC
Path 1
Span: 15 MHz RBW: 30 kHz VBW: 100 kHz

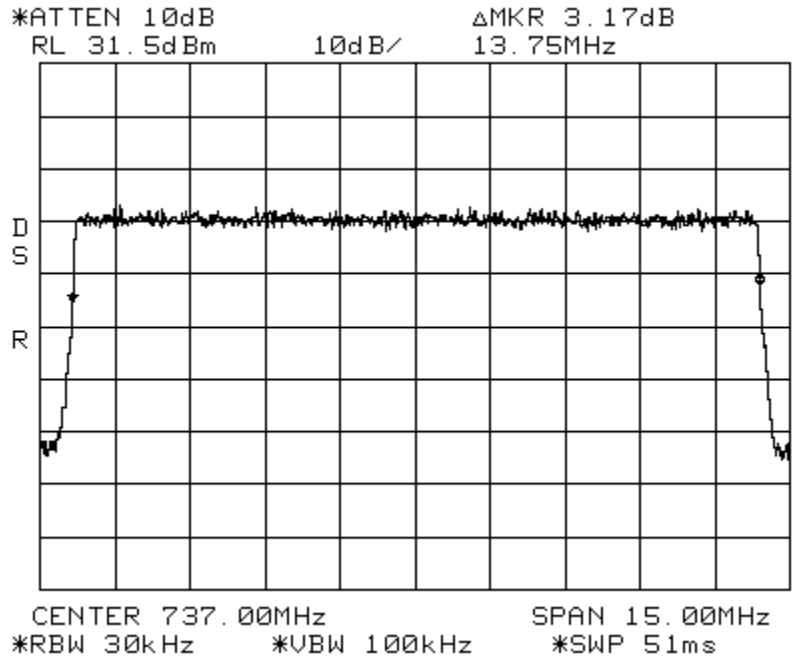

Occupied Bandwidth LTE 15 MHz Channel Bandwidth_Signal_Out Spectrum 700 MHz Lower
ABC
Path 1
Span: 15 MHz RBW: 30 kHz VBW: 100 kHz

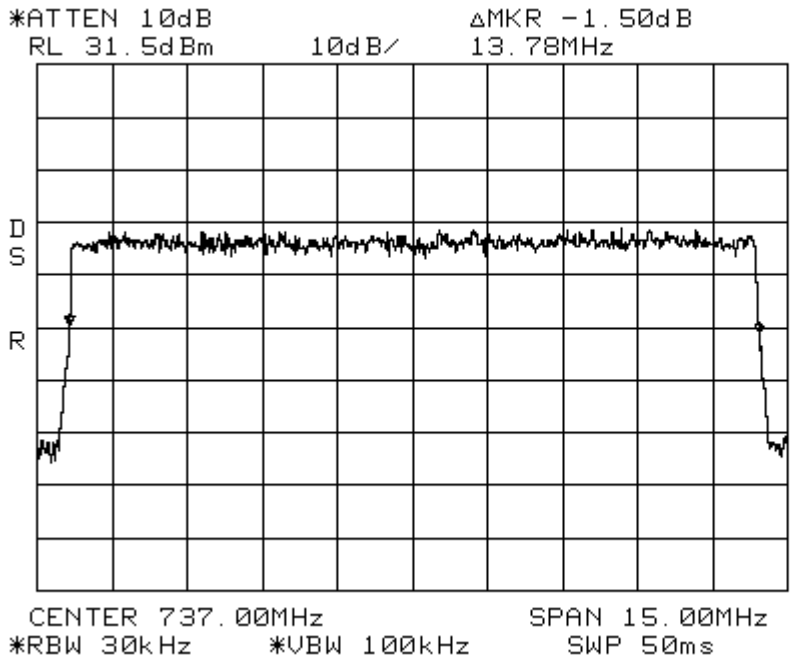

Occupied Bandwidth LTE 1.4 MHz Channel Bandwidth_Signal_In Spectrum 700 MHz Lower ABC
Path 2

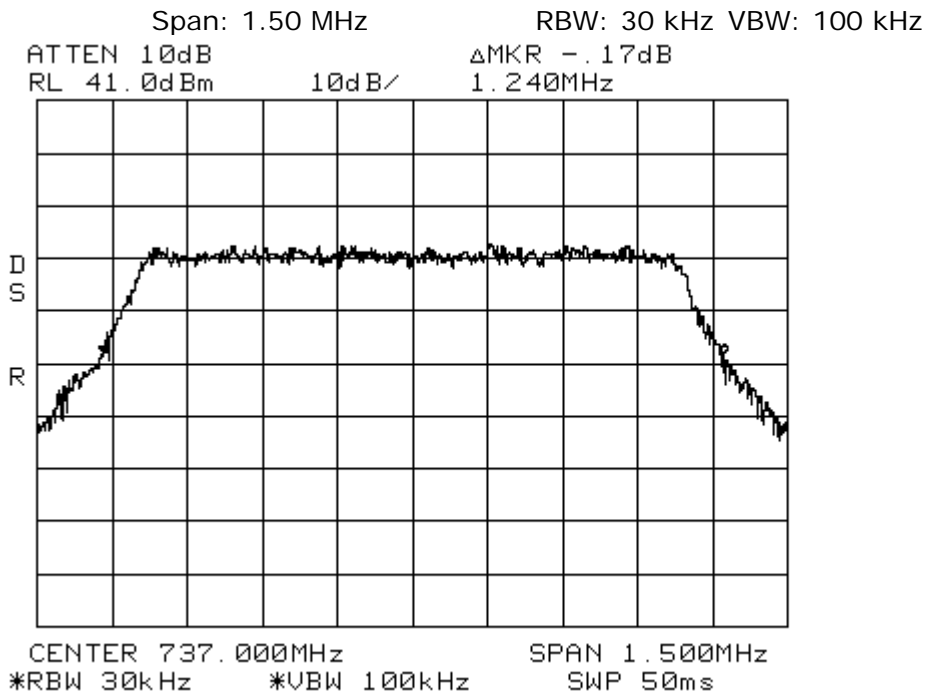

Occupied Bandwidth LTE 1.4 MHz Channel Bandwidth_Signal_Out Spectrum 700 MHz Lower
ABC Path 2

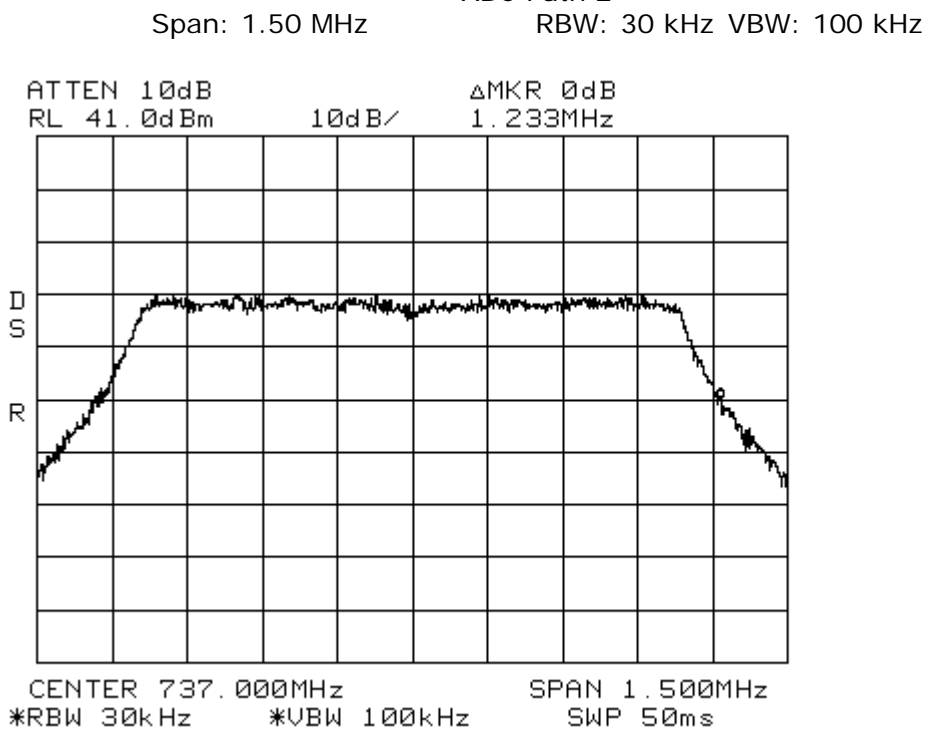

Occupied Bandwidth LTE 3 MHz Channel Bandwidth_Signal_In Spectrum 700 MHz Lower ABC

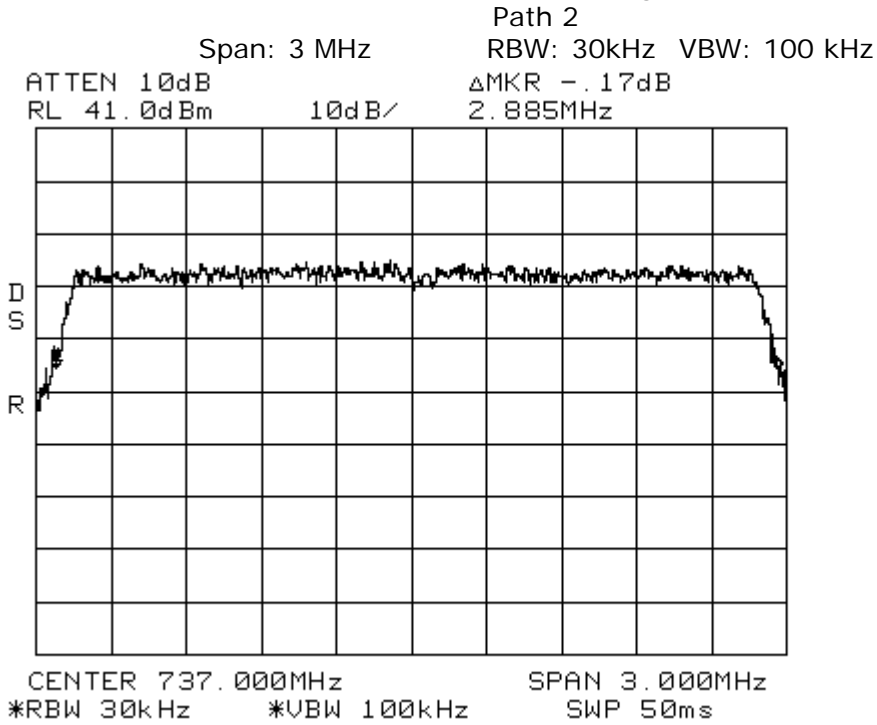

Occupied Bandwidth LTE 3 MHz Channel Bandwidth_Signal_Out Spectrum 700 MHz Lower ABC

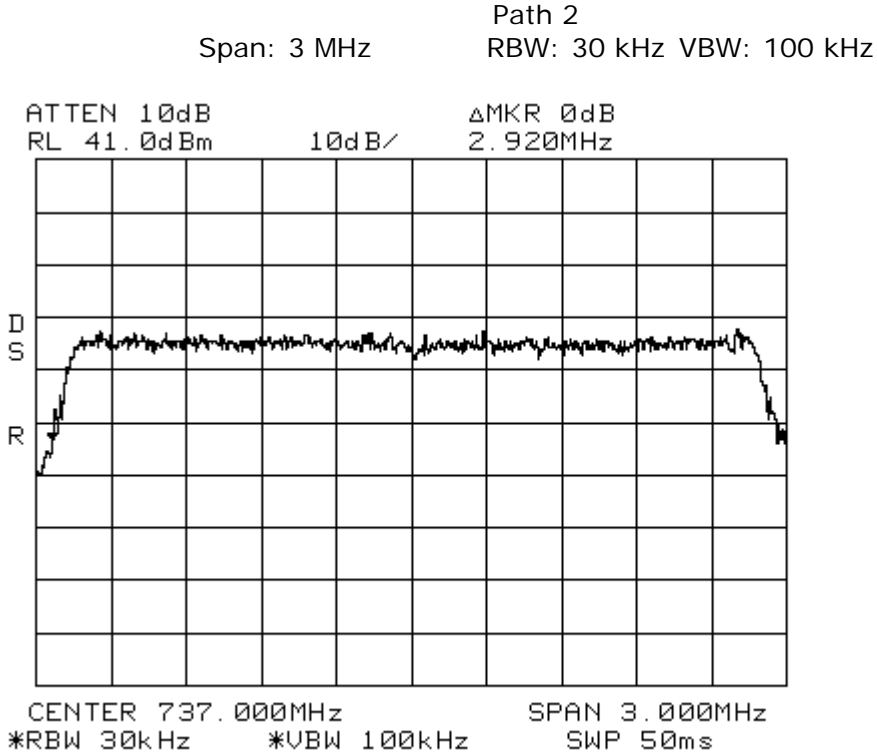

Occupied Bandwidth LTE 5 MHz Channel Bandwidth_Signal_In Spectrum 700 MHz Lower ABC

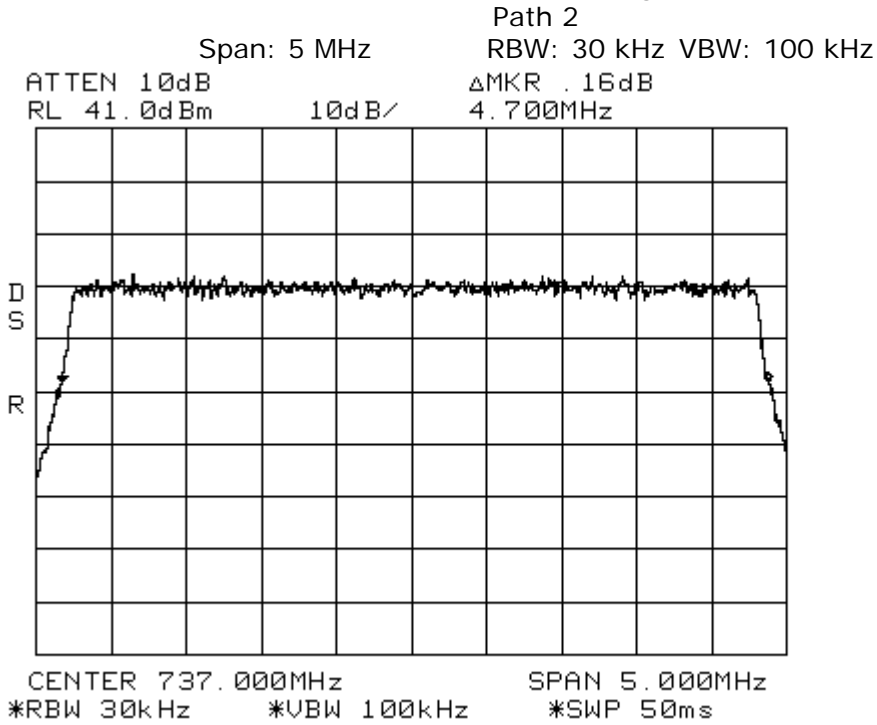

Occupied Bandwidth LTE 5 MHz Channel Bandwidth_Signal_Out Spectrum 700 MHz Lower ABC

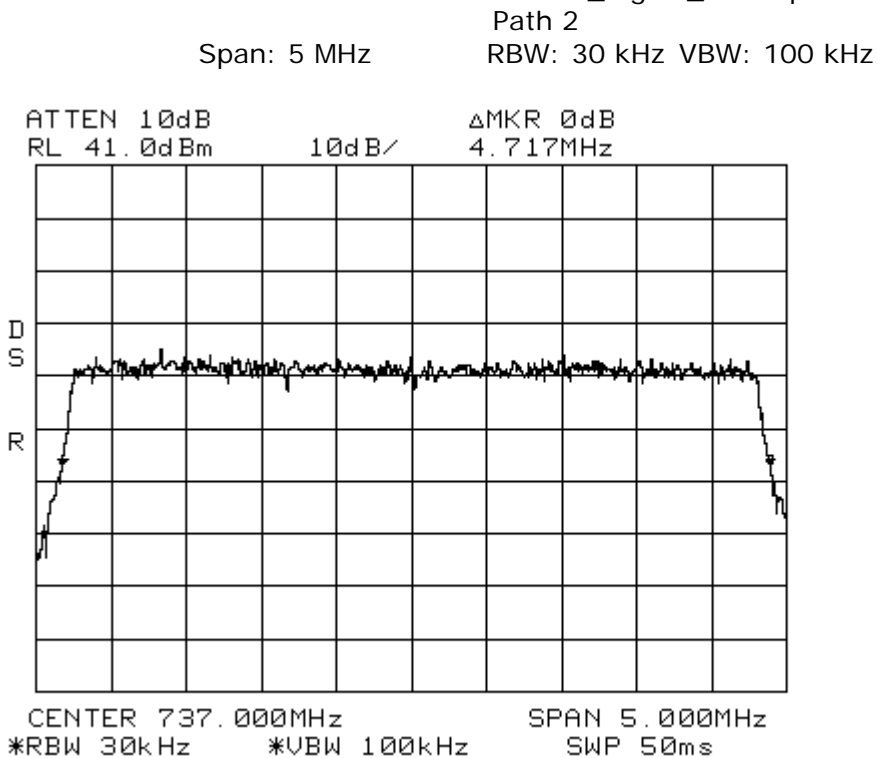

Occupied Bandwidth LTE 10 MHz Channel Bandwidth_Signal_In Spectrum 700 MHz Lower ABC

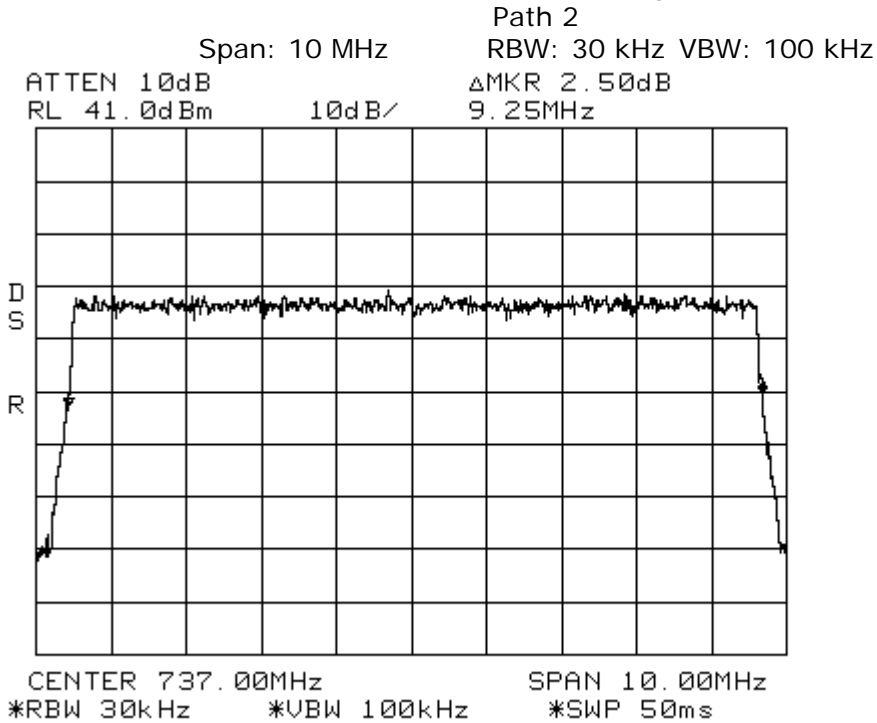

Occupied Bandwidth LTE 10 MHz Channel Bandwidth_Signal_Out Spectrum 700 MHz Lower ABC Path 2

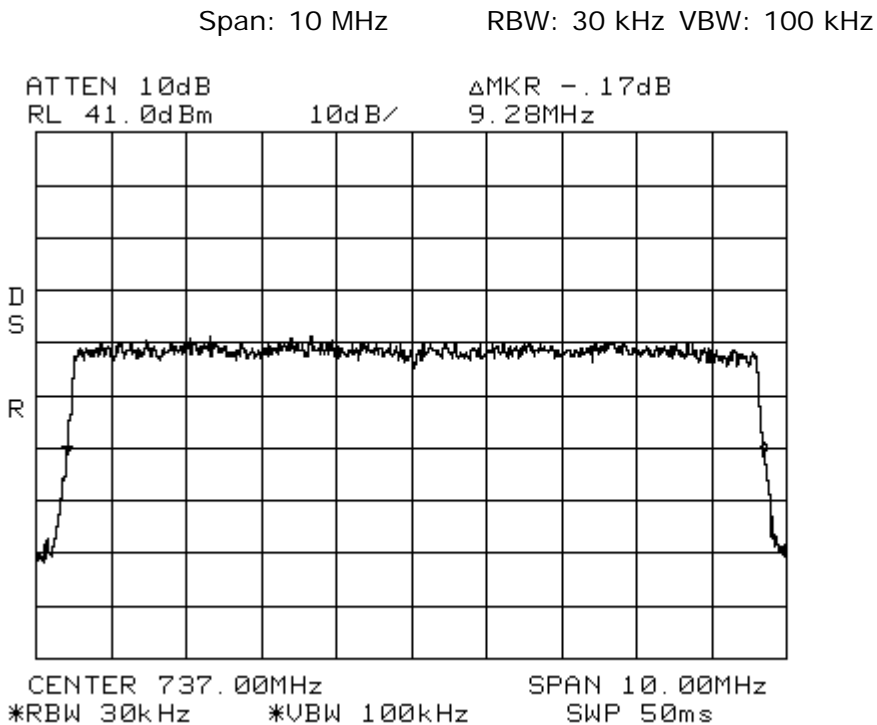

Occupied Bandwidth LTE 15 MHz Channel Bandwidth_Signal_In Spectrum 700 MHz Lower ABC
Path 2
Span: 15 MHz RBW: 30 kHz VBW: 100 kHz

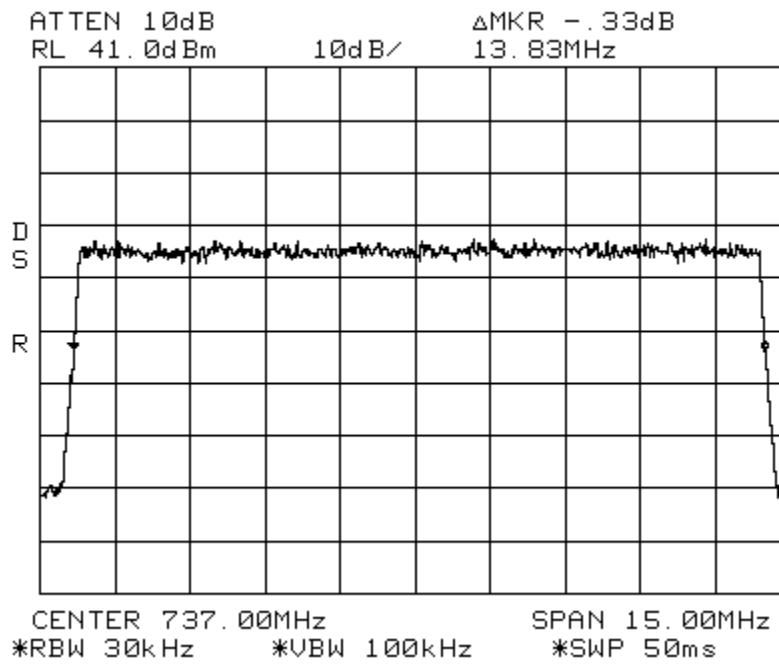

Occupied Bandwidth LTE 15 MHz Channel Bandwidth_Signal_Out Spectrum 700 MHz Lower
ABC Path 2
Span: 15 MHz RBW: 30 kHz VBW: 100 kHz

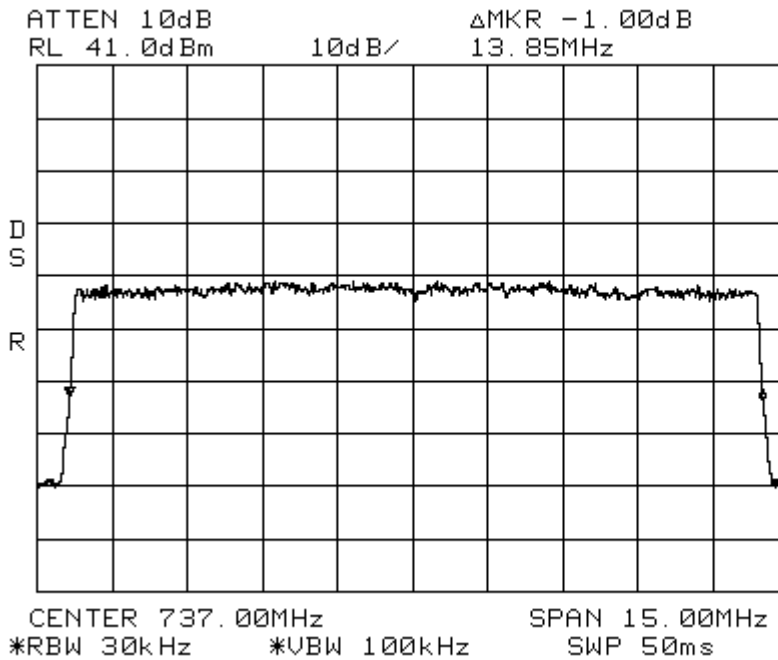

Occupied Bandwidth LTE 1.4 MHz Channel Bandwidth_Signal_InSpectrum 700 MHz Upper C
Path 1

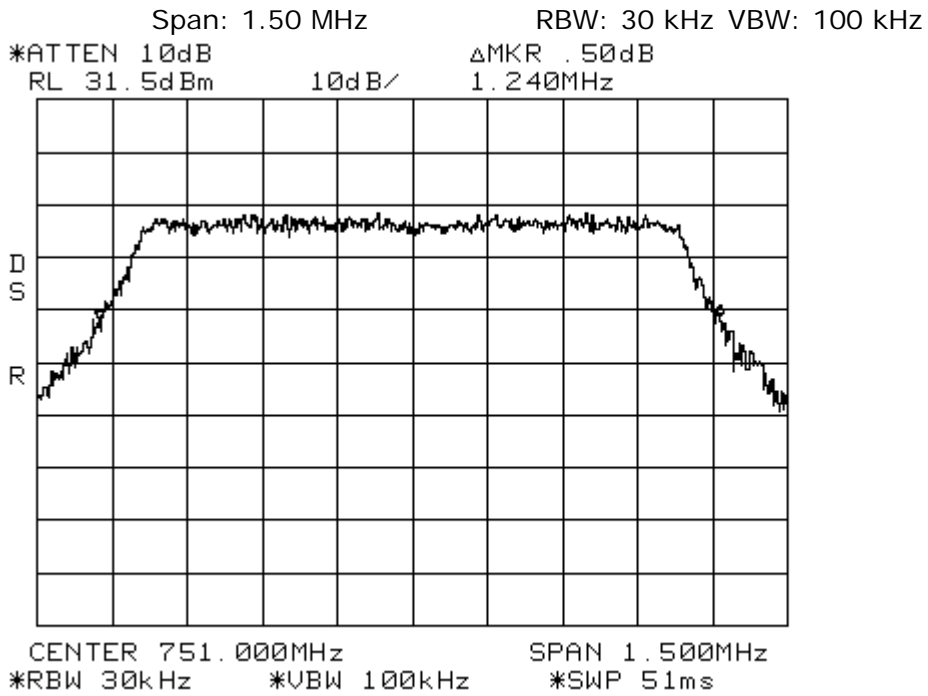

Occupied Bandwidth LTE 1.4 MHz Channel Bandwidth_Signal_Out Spectrum 700 MHz Upper C
Path 1

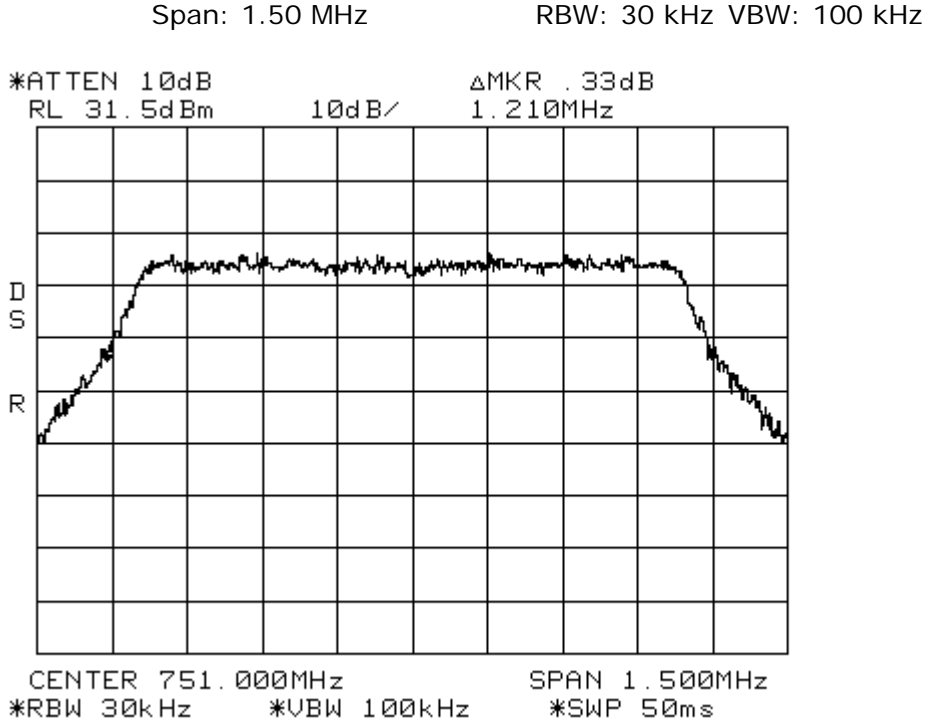

Occupied Bandwidth LTE 3 MHz Channel Bandwidth_Signal_In Spectrum 700 MHz Upper C

Path 1
Span: 3 MHz RBW: 30kHz VBW: 100 kHz
*ATTEN 10dB ΔMKR .33dB
RL 31.5dBm 10dB/ 2.915MHz

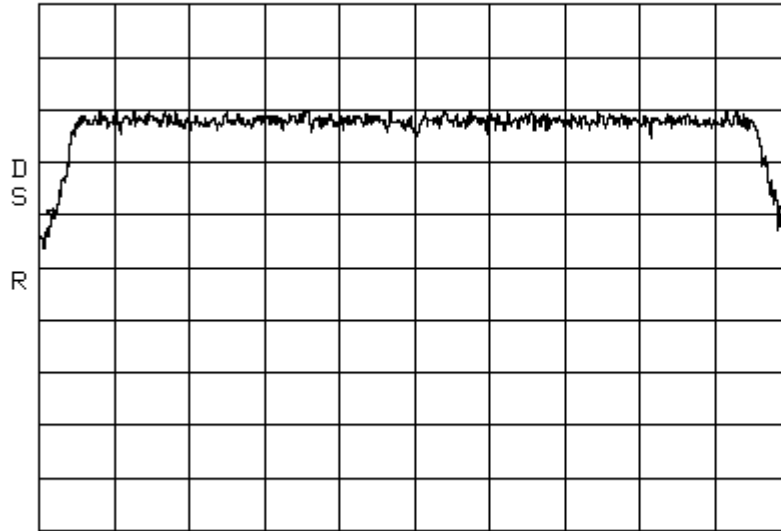

CENTER 751.000MHz SPAN 3.000MHz
*RBW 30kHz *VBW 100kHz *SWP 51ms

Occupied Bandwidth LTE 3 MHz Channel Bandwidth_Signal_Out Spectrum 700 MHz Upper C

Path 1
Span: 3 MHz RBW: 30 kHz VBW: 100 kHz
*ATTEN 10dB ΔMKR 1.00dB
RL 31.5dBm 10dB/ 2.885MHz

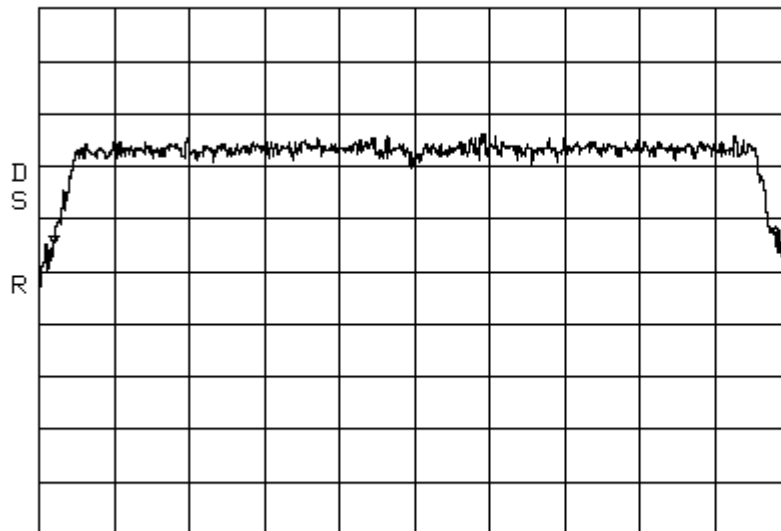

CENTER 751.000MHz SPAN 3.000MHz
*RBW 30kHz *VBW 100kHz *SWP 50ms

Occupied Bandwidth LTE 5 MHz Channel Bandwidth_Signal_In Spectrum 700 MHz Upper C
Path 1

Span: 5 MHz RBW: 30 kHz VBW: 100 kHz
*ATTEN 10dB Δ MKR -.17dB
RL 31.5dBm 10dB/ 4.667MHz

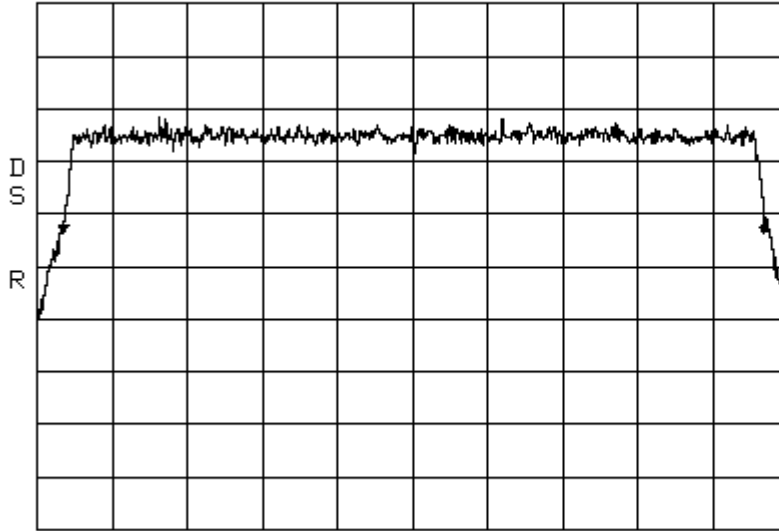

CENTER 751.000MHz SPAN 5.000MHz
*RBW 30kHz *VBW 100kHz *SWP 51ms

Occupied Bandwidth LTE 5 MHz Channel Bandwidth_Signal_Out Spectrum 700 MHz Upper C
Path 1

Span: 5 MHz RBW: 30 kHz VBW: 100 kHz

*ATTEN 10dB Δ MKR .50dB
RL 31.5dBm 10dB/ 4.700MHz

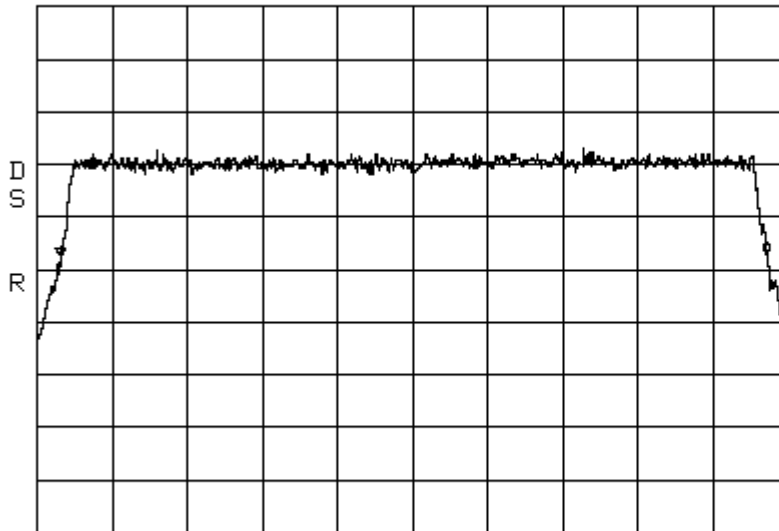

CENTER 751.000MHz SPAN 5.000MHz
*RBW 30kHz *VBW 100kHz *SWP 50ms

Occupied Bandwidth LTE 10 MHz Channel Bandwidth_Signal_In Spectrum 700 MHz Upper C

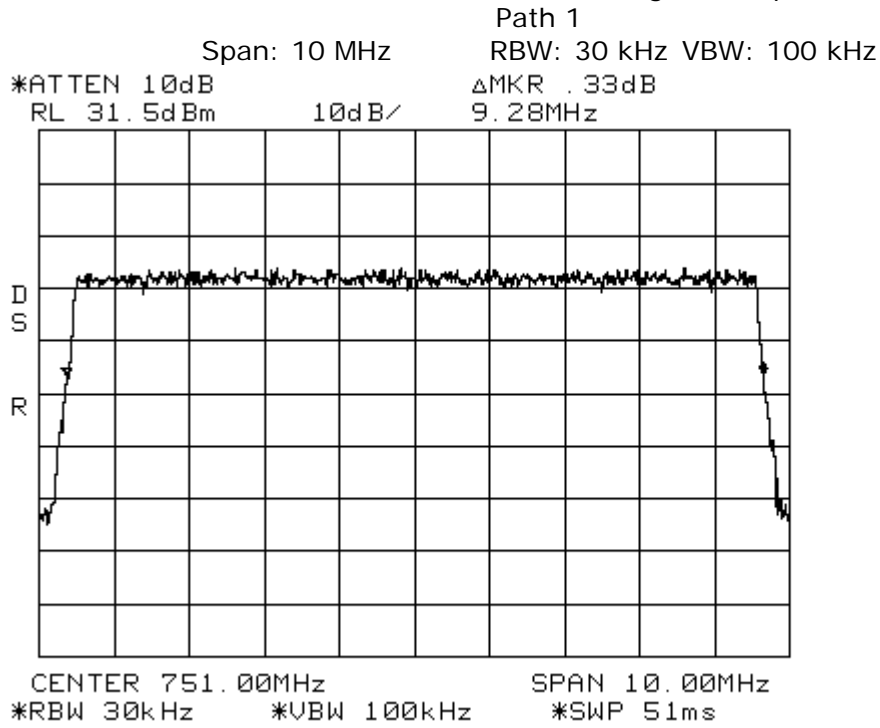

Occupied Bandwidth LTE 10 MHz Channel Bandwidth _Signal_Out Spectrum 700 MHz Upper C

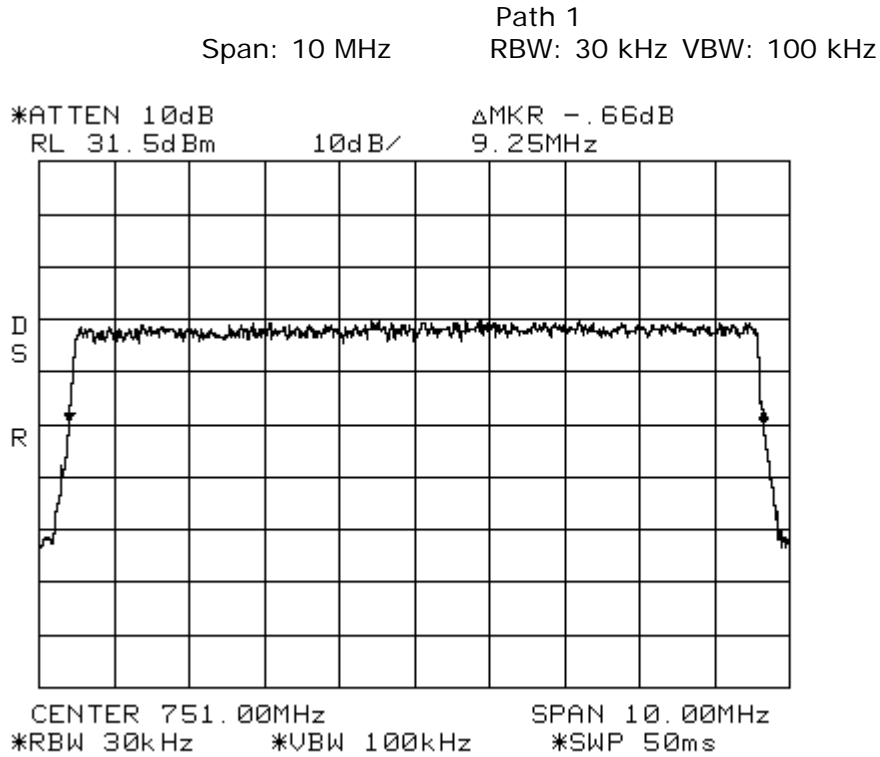

Occupied Bandwidth LTE 1.4 MHz Channel Bandwidth_Signal_In Spectrum 700 MHz Upper C Path 2

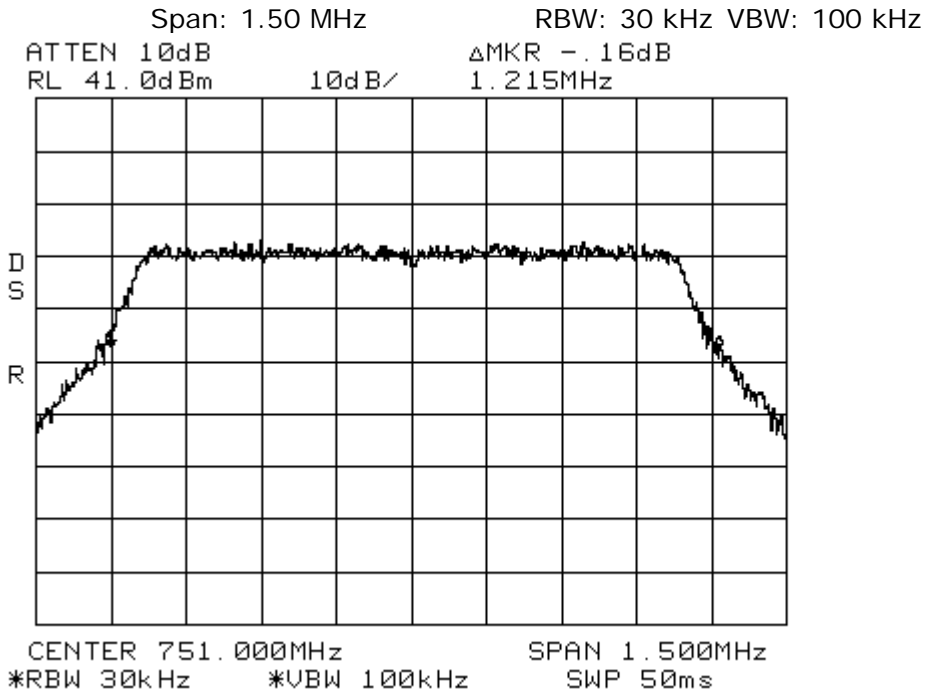

Occupied Bandwidth LTE 1.4 MHz Channel Bandwidth_Signal_Out Spectrum 700 MHz Upper C Path 2

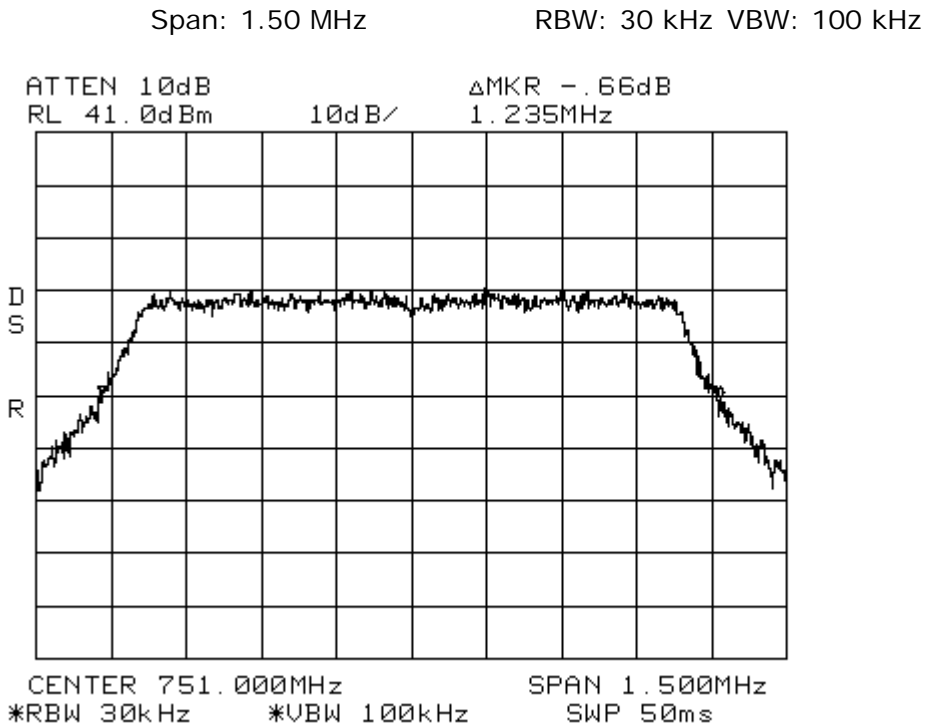

Occupied Bandwidth LTE 3 MHz Channel Bandwidth_Signal_In Spectrum 700 MHz Upper C

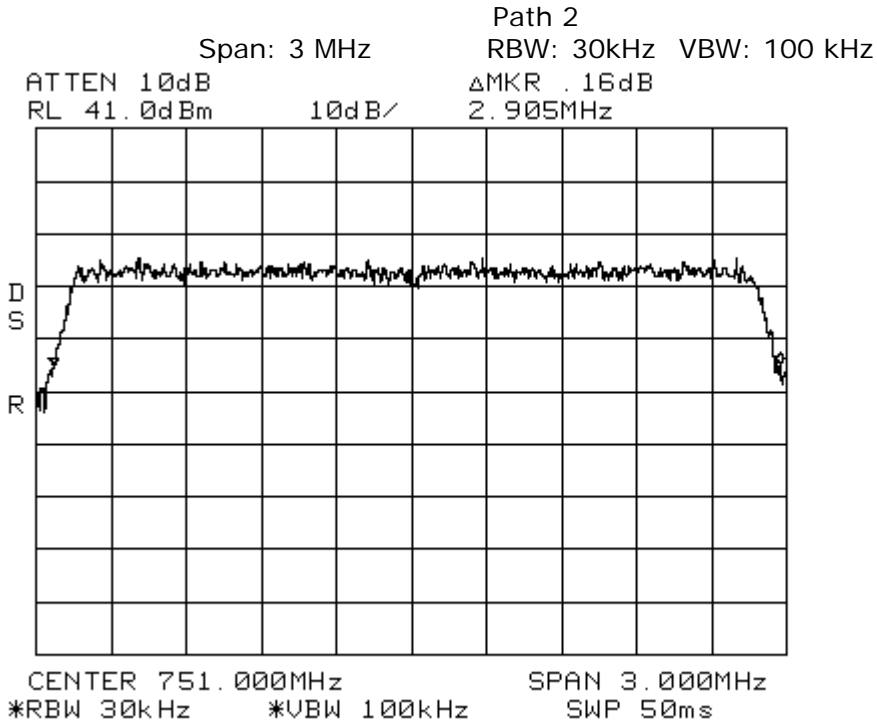

Occupied Bandwidth LTE 3 MHz Channel Bandwidth_Signal_Out Spectrum 700 MHz Upper C

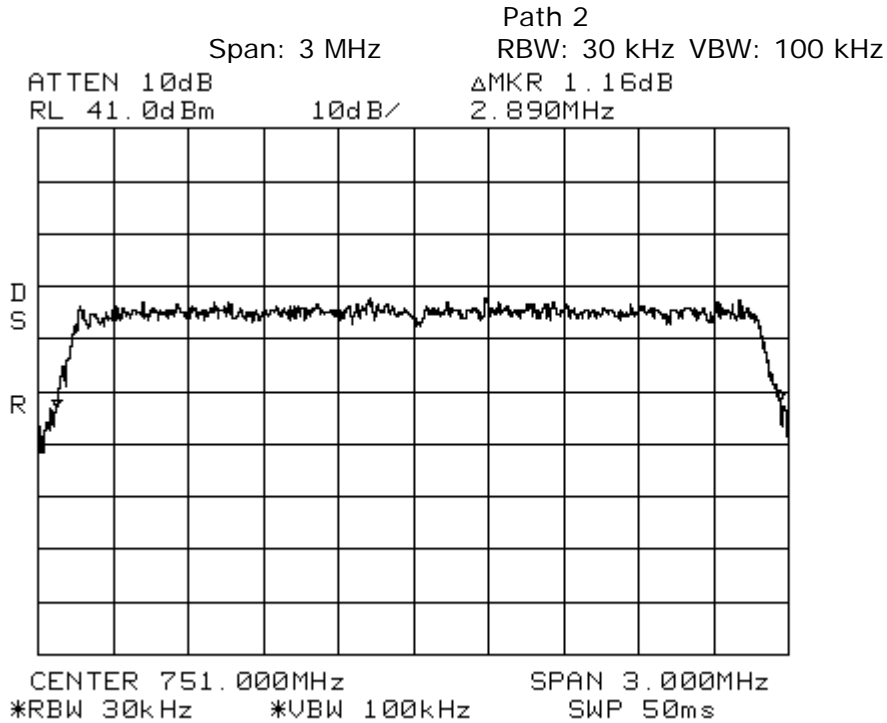

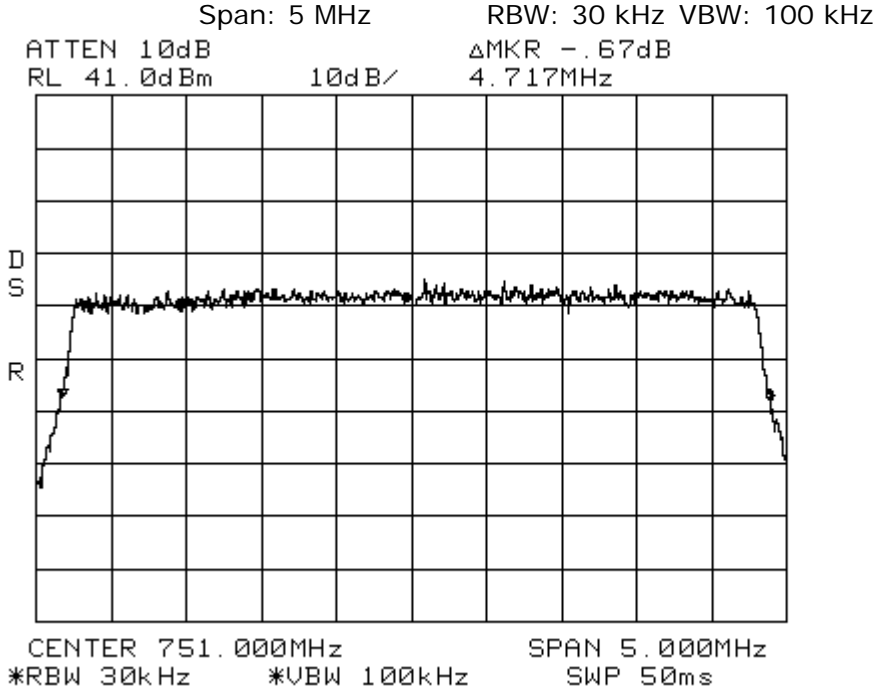
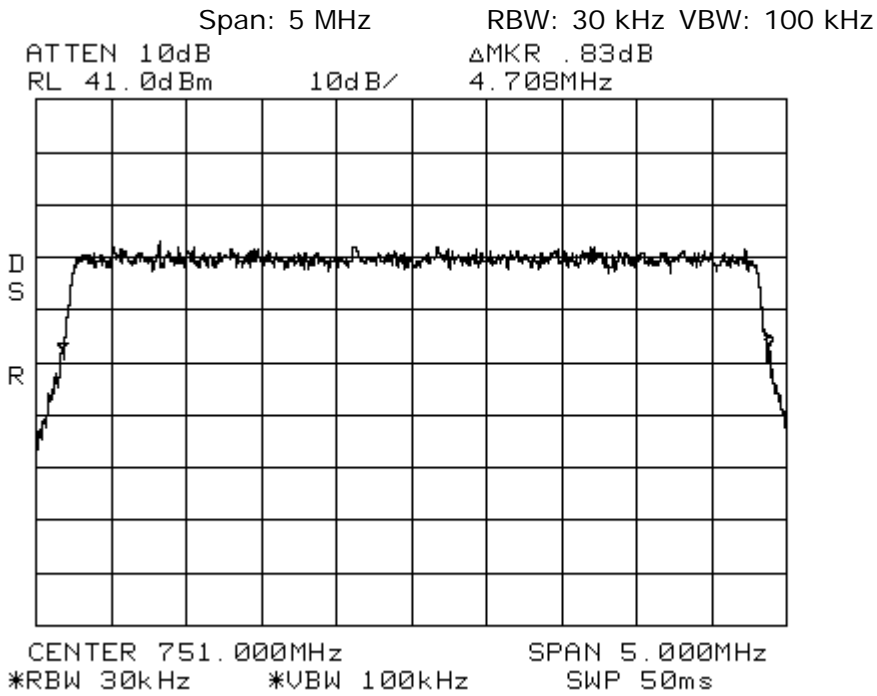

Occupied Bandwidth LTE 10 MHz Channel Bandwidth_Signal_In Spectrum 700 MHz Upper C
Path 2

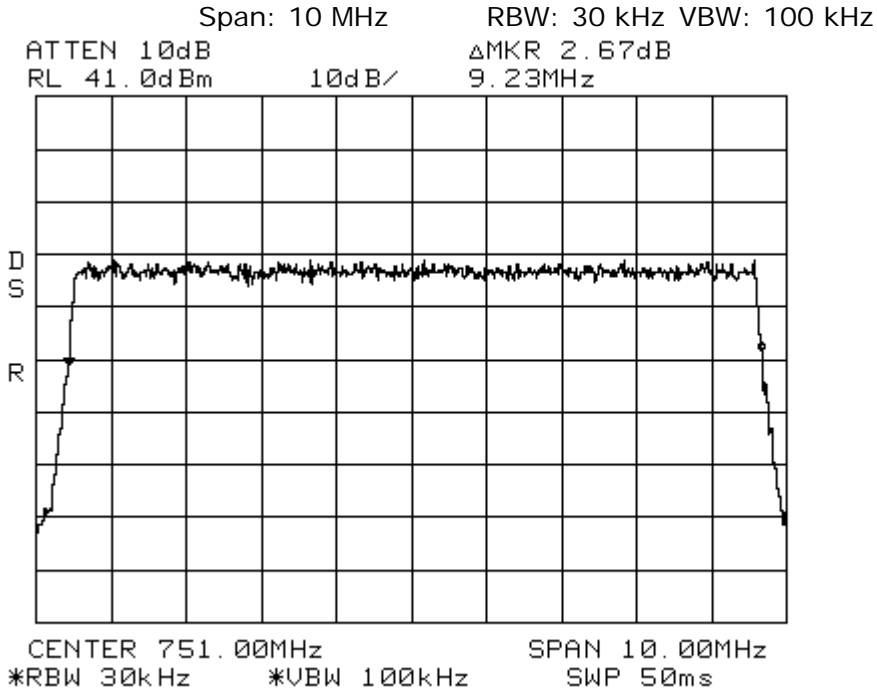

Occupied Bandwidth LTE 10 MHz Channel Bandwidth _Signal_Out Spectrum 700 MHz Upper C
Path 2

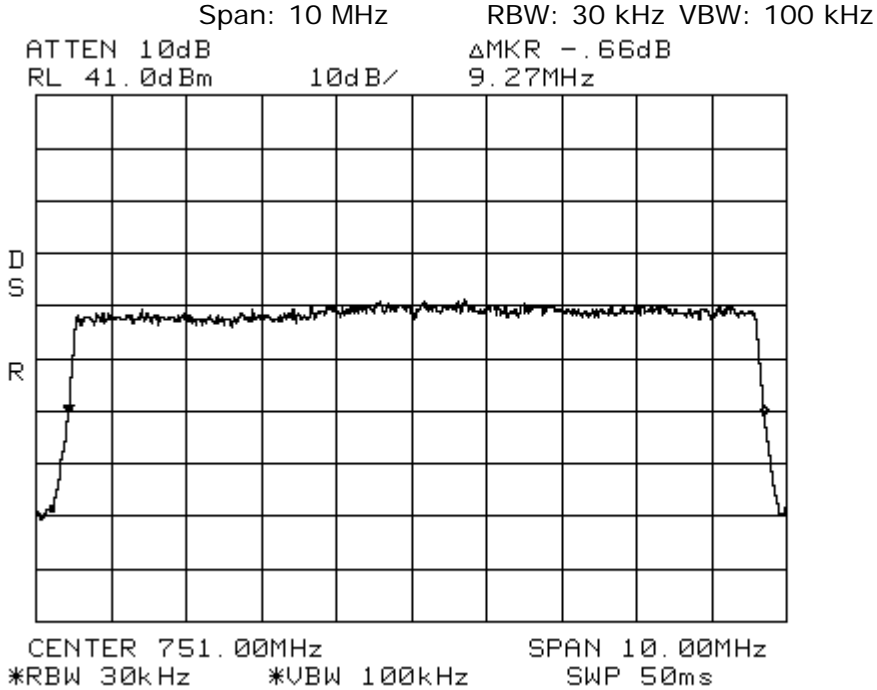

8.0

APPENDIX B

Measurement Protocol

[Table of Contents: Section 1.0](#)

[Back to Emission Limits: Section 5.1.3](#)

Measurement Protocol

Environmental conditions of the lab, (ADC)

Temperature: 24° C

Relative Humidity: 21 %

Atmospheric Pressure: 98.8 kPa

Test Methodology:

Emission testing is performed according to the procedures in ANSI C63.4-2003.

Measurement Uncertainty

The test system for conducted emissions is defined as the signal generator(s), the power meter, the spectrum analyzer and the coaxial cable. The equipment comprising the test systems is calibrated prior to testing the EUT.

Justification

The Equipment Under Test (EUT) is configured in a typical user arrangement in accordance with the manufacturer's instructions. A cable is connected to each available port and either terminated with a peripheral into its characteristic impedance or left un-terminated. When appropriate, the cables are manually manipulated with respect to each other to obtain maximum emissions from the unit.

Radiated Emissions

The final level, in dBuV/m, equals the reading from the spectrum analyzer (Level dBuV), adding the antenna correction factor and cable loss factor (Factor dB) to it, and subtracting the preamp gain (and duty cycle correction factor, if applicable). This result then has the limit subtracted from it to provide the Delta, which gives the tabular data as shown in the data sheets in Appendix B.

Example:

FREQ (MHz)	LEVEL (dBuV)	CABLE/ANT/PREAMP (dB) (dB/m) (dB)	FINAL (dBuV/m)	POL/HGT/AZ (m) (deg)	DELTA1
60.80	42.5Qp +	1.2 + 10.9 - 25.5 =	29.1	V 1.0 0.0	-10.9

Substitution Method

A cabinet (or enclosure) radiated emission scan was also made, at Intertek, with the EUT's antenna replaced with a termination to demonstrate case radiation compliance to the -13 dBm requirement. Radiated emissions from the EUT are measured in the frequency range of 30 to 20,000 MHz using a spectrum analyzer and appropriate broadband linearly polarized antennas. Table top equipment is placed on a 1.0 X 1.5 meter non-conducting table 80 centimeters above the ground plane. Floor standing equipment is placed directly on the turntable/ground plane. Interface cables that are closer than 40 centimeters to the ground plane are bundled in the center in a serpentine fashion so they are at least 40 centimeters from the ground plane. Cables to simulators/testers (if used in this test) are routed through the center of the table and to a screen room located outside the test area. The antenna is positioned 3 meters horizontally from the EUT. To locate maximum emissions from the test sample the antenna is varied in height from 1 to 4 meters, measurement scans are made with both horizontal and vertical antenna polarizations and the EUT are rotated 360 degrees. The field strength levels were measured per ANSI C63.4. The EUT is then replaced with a tuned dipole antenna (below 1GHz) or horn antenna (above 1 GHz). The substitute antenna was placed in the same polarization as the test antenna. A signal generator was used to generate a signal level that matched the highest level measured from the EUT. The signal generator level minus the cable loss from the signal generator to the substitute antenna plus the substitute antenna gain equals the spurious power level.

Test Equipment

All measurement instrumentation is traceable to the National Institute of Standards and Technology and is calibrated according to internal procedure.

Radiated Emissions Test Data

[Table of Contents: Section 1.0](#)

Document Name: 100488883MIN-001

Test Engineer: Richard Blonigen

Date: August 23, 2011

Test Procedure:

Test measurements were made in accordance with ANSI C63.4-2003, Standard Methods of Measurement of Radio Noise Emissions from Low-Voltage Electrical and Electronics Equipment in the Range of 9 kHz to 40 GHz.

Test Site Location:

The test site is a 3 meter Semi-Anechoic Chamber, constructed by Panashield™ Inc. and located inside the building at 7250 Hudson Blvd. Suite 100, Oakdale, MN 55128.

Test Site Description:

The 3 meter Semi-Anechoic Chamber is constructed of Panabolt™ modular RF shielding and self-supported with structural steel designed for the local seismic zone rating. The chamber has the nominal size of 20' wide x 29' long x 18' high. All walls and ceiling of the chamber are treated with FFG-1000 Ferrite Grid absorber which was developed specifically to meet international requirements for EMC anechoic chambers for emissions and immunity measurements. To meet high frequency testing white HY-35 hybrid absorber is mounted on the ferrites in specular regions of the chamber.

The chamber has a 2 meter diameter ANSI test volume area and meets the requirements of ANSI C63.4 (1992), EN55022, and FCC Part 15 standards for testing at a 3 meter path length.

FCC Registration Number: 0007355381

IC Registration Number: 4359A