



# Test Report Summary

## FCC CFR 47, Part 24

### Subpart E Broadband PCS

## FCC CFR 47, Part 27

### Wireless Communications Service

**Manufacturer:** ADC Telecommunications

**Name of Equipment:** Spectrum AWS Path 1/PCS Path1 MRAU

**Model Number(s):** SPT-M1-AWS19-11

**Manufacturer's Address:** 1187 Park Place  
Shakopee, MN 55739

**Test Report Number:** MN110725\_AWSP1\_PCSP1\_MRAU

**Test Date(s):** 18 July, 2011 (Intertek)  
20 July, 2011 (ADC)

According to testing performed at Intertek, the above-mentioned unit is in accordance with the applicable electromagnetic compatibility (EMC) portions of the requirements defined in FCC Part 24 and 27.

It is the manufacturer's responsibility to assure that additional production units of this model are manufactured with identical electrical and mechanical characteristics. Any modifications necessary for compliance made during testing on the above mentioned date(s) must be implemented in all production units for compliance to be maintained.

All testing was done in accordance with the Federal Communications Commission's CFR 47 Part 24 and 27. The EUT fulfills the requirements of the Federal Communications Commission's CFR 47 Part 24 and 27.

Date: 25 June, 2011

Location: Intertek Testing Services (INTERTEK)  
7250 Hudson Blvd., Suite 100  
Oakdale, MN 55128  
Phone: (651) 730-1188  
Fax: (651) 730-1282

ADC Telecommunications  
1187 Park Place  
Shakopee, MN 55379  
Phone: (952) 403-8340  
Fax: (952) 403-8858

Testing Conducted by (ADC):  
And Report Written by:

Joshua J. Wittman  
Compliance Engineer





## 1.0 TABLE OF CONTENTS

1.0	Table of Contents .....	3
2.0	Revision Description .....	4
3.0	Documentation .....	4
3.1	Test Regulations .....	4
3.2	Test Operation Mode .....	5
3.3	Configuration of the Device Under Test: .....	5
3.4	Product Options: .....	5
3.5	EUT Specifications and Requirements: .....	5
3.6	Cables: .....	5
3.7	Power Requirements: .....	5
3.8	Typical Installation and/or Operating Environment: .....	5
3.9	Other Special Requirements: .....	5
3.10	EUT Software: .....	5
3.11	EUT System Components .....	6
3.12	Support Equipment .....	6
3.13	Deviations from Standard: .....	6
3.14	General Remarks: .....	6
3.15	Summary: .....	6
4.0	Test Set-Up Drawings and Photos .....	7
4.1	Test Set-up Photo, Radiated Emissions .....	7
4.2	Test Set-up Photo, Radiated Emissions .....	9
4.3	Test Set-up Drawings .....	11
5.0	Test Results .....	13
5.1.1	27.50 RF Power Limits .....	13
5.1.2	27.54 Frequency Stability .....	14
5.1.3	27.53 Emission Limitations .....	15
6.0	Test Equipment .....	16
7.0	Appendix A .....	17
7.1	Conducted Emission Limits Test .....	18
7.2	Conducted Output Power Test .....	32
7.3	Frequency Stability Test .....	33
7.4	Intermodulation Test .....	35
7.5	Occupied Bandwidth Modulation Test .....	60
8.0	Appendix B .....	66
9.0	Appendix C .....	68



## 2.0 REVISION DESCRIPTION

Rev	Total Pages	Date	Description
A	68	25 June, 2011	Original Release

## 3.0 DOCUMENTATION

### 3.1 Test Regulations

- 27.50 Power limits
- 27.53 Emission limits
- 27.54 Frequency stability

The emissions tests were performed according to the following regulations:

- FCC Part 22
- FCC Part 24**
- FCC Part 27**
- FCC Part 90
- IC RSS-131 Issue 2

#### Environmental Conditions in the lab:

##### **ADC**

Temperature: 24° C  
Relative Humidity: 21%  
Atmospheric Pressure: 98.8 kPa

##### **Intertek**

15-35° C  
30-60%  
86-106 kPa

#### Power Supply Utilized:

Power Supply System : 1 phase, 60 Hz, 120 VAC

### 3.2 Test Operation Mode

- Standby
- Test Program
- Practice Operation

#### ■ Max composite in and out

### 3.3 Configuration of the Device Under Test:

Normal Operation – PCS – 1930 to 1990 MHz

Normal Operation – AWS – 2110 to 2155 MHz

### 3.4 Product Options:

None

### 3.5 EUT Specifications and Requirements:

Length: 11.50"

Width: 9.00"

Height: 3.50"

Weight: 7.49 pounds

### 3.6 Cables:

Cable Type	Length	From	To
RF	> 3M	Ancillary Equip	EUT
RF	< 3M	EUT	50 Ohm Load
Power (2)	< 3M	Power	Input Power (Ancillary)
Coax (75 Ohm)	> 3M	Ancillary Equip	EUT

### 3.7 Power Requirements:

Voltage: 54 VDC

### 3.8 Typical Installation and/or Operating Environment:

Indoor. System is typically employed as an indoor repeater.

### 3.9 Other Special Requirements:

None

### 3.10 EUT Software:

Revision Level: Version V.6 or greater

Description: Internet Explorer

### 3.11 EUT System Components

Description	Model #	Serial #	FCC ID #
Prism Host Unit	FWP-0000HUII	None	
Spectrum DRU	SPT-0000DRUII	None	
Spectrum IFEU	742735-0	None	
Spectrum Power Supply	LTPCPR1U3C-Z-527		
Remote Access Unit	SPT-M1-AWS19-11	None	

### 3.12 Support Equipment

Description	Manufacturer	Model #	FCC ID #
Power Meter	HP	437B	
Signal Generator	Agilent	8648C	

### 3.13 Deviations from Standard:

Modifications required to pass:

As indicated on the data sheet(s)

■ **None**

Test Specification Deviations; Additions to or Exclusions from:

As indicated in the Test Plan

■ **None**

### 3.14 General Remarks:

None.

### 3.15 Summary:

The requirements according to the technical regulations are

■ **met**

not Met

The equipment under test does

■ **fulfill the general approval requirements mentioned in Section 3.1.**

not fulfill the general approval requirements mentioned in Section 3.1.

## 4.0 TEST SET-UP DRAWINGS AND PHOTOS

[Table of Contents: Section 1.0](#)

### 4.1 Test Set-up Photo, Radiated Emissions

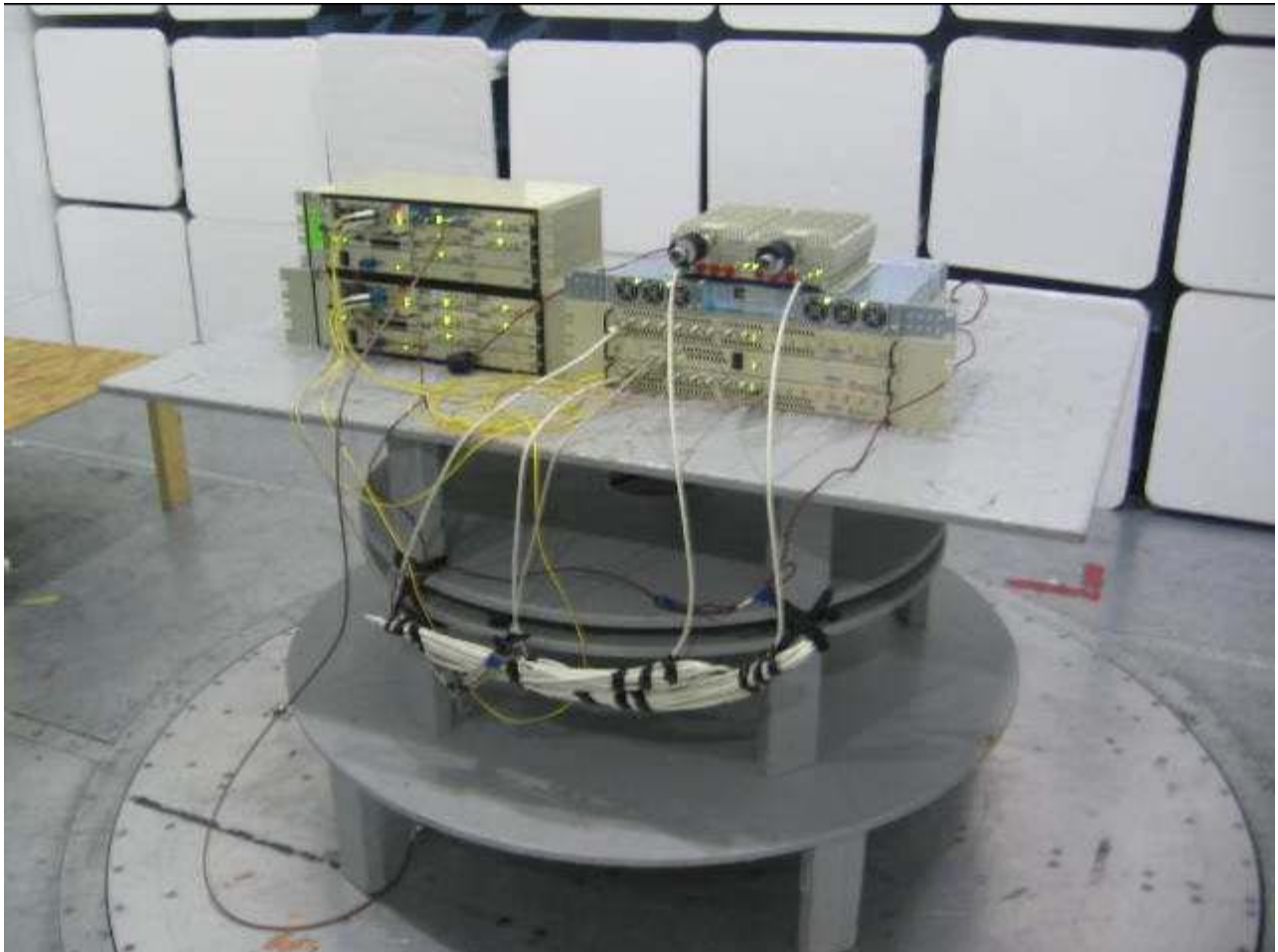

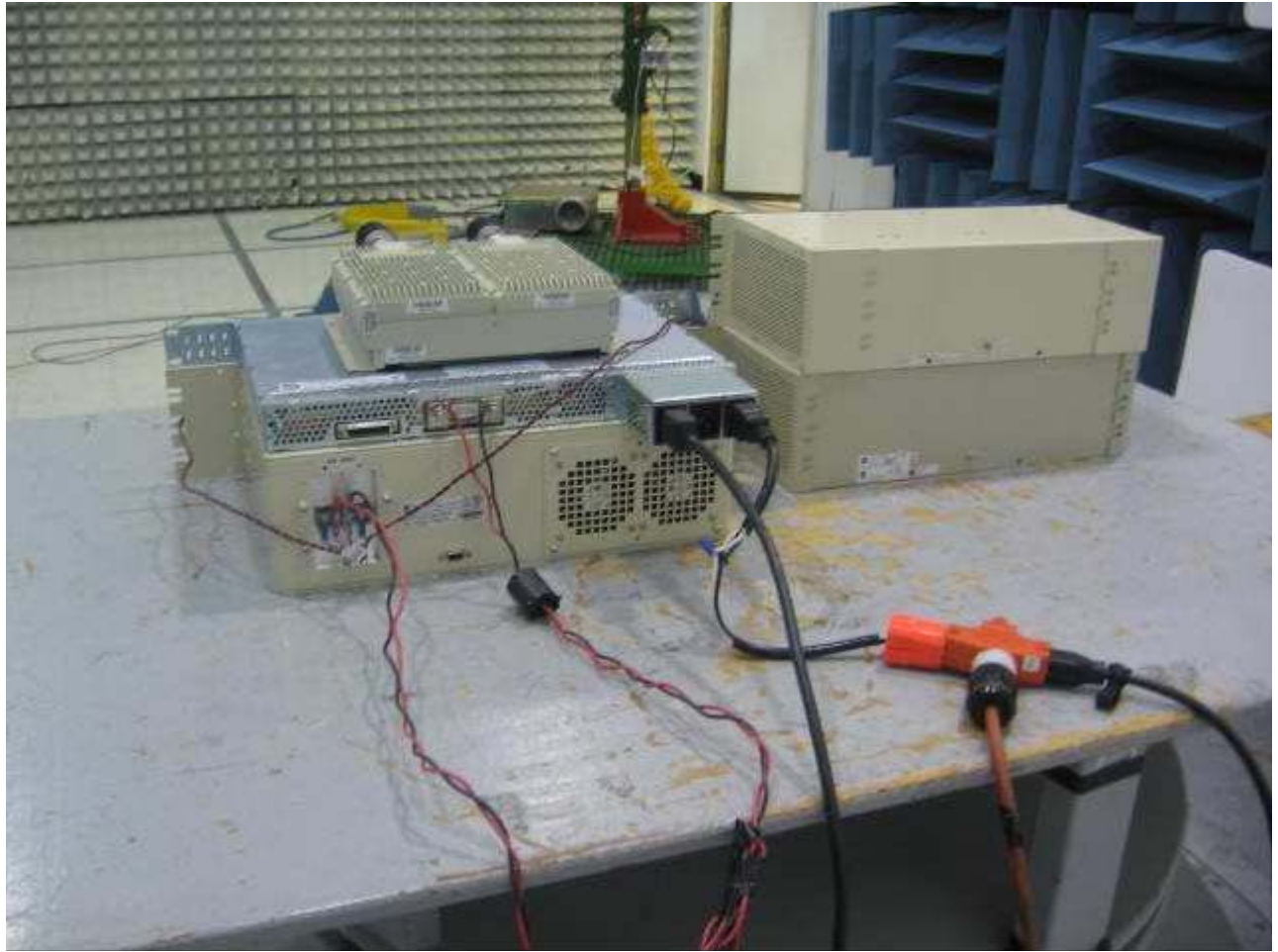



## 4.2 Test Set-up Photo, Radiated Emissions





### 4.3 Test Set-up Drawings

## Conducted and Radiated Emission Limits Test

### Conducted Output Power Test

### Inter-Modulation Test

### Occupied Bandwidth Modulation Test

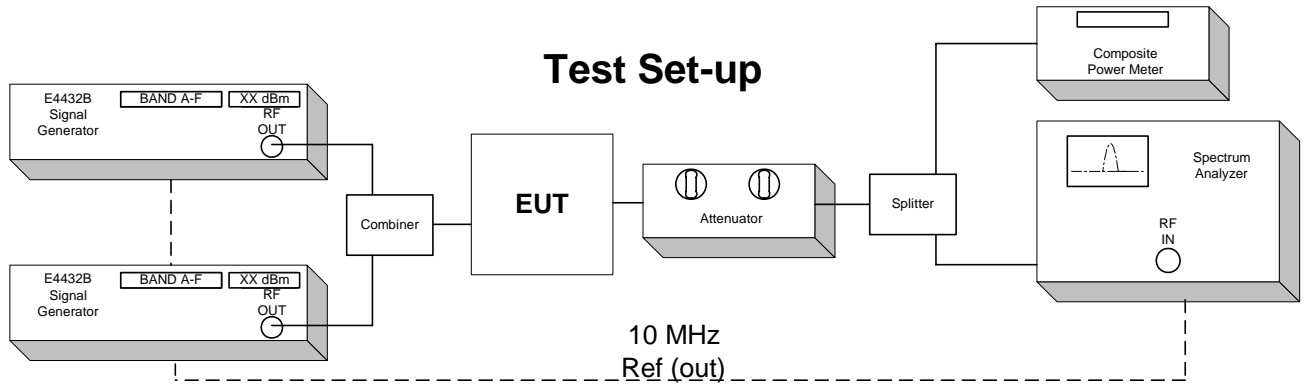

# Frequency Tolerance Test

The Host, DRU, and IFEU EUT are specified for indoor use with temperature range of 0° to +50° C, and were tested within their range.

The Remote Access Unit EUT is specified for indoor use with temperature range of -25° to +50° C, and was tested with its range.

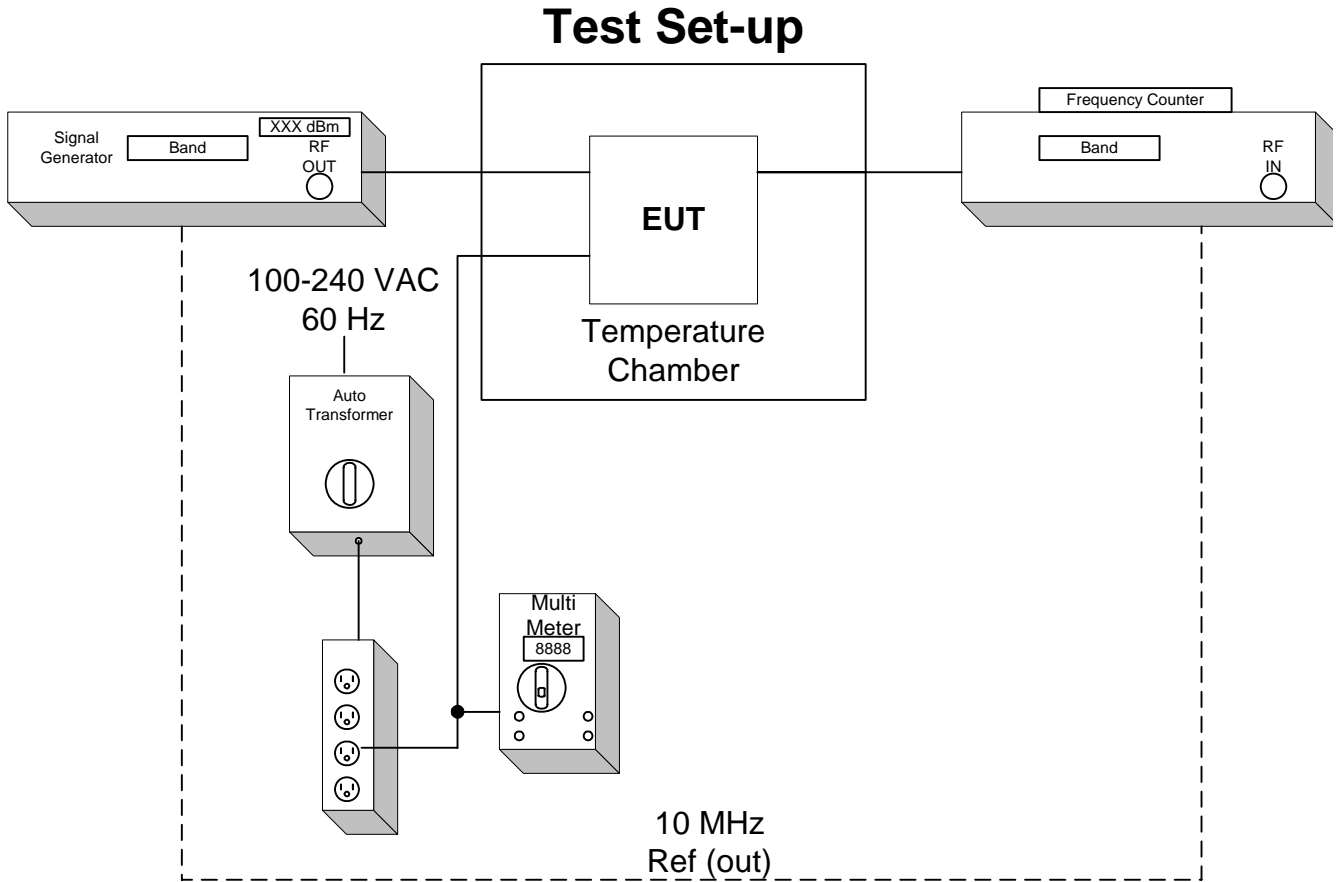

## 5.0 TEST RESULTS

### 5.1.1 27.50 RF Power Limits

#### Test Summary:

- The requirements are:  **MET**  NOT MET
- Minimum margin of compliance is 23.69 dB at 1960 MHz (CDMA)
- Minimum margin of compliance is 25.76 dB at 1960 MHz (GSM)
- Minimum margin of compliance is 25.35 dB at 1960 MHz (EDGE)
- Minimum margin of compliance is 18.95 dB at 1960 MHz (W-CDMA)
- Minimum margin of compliance is 16.33 dB at 2112.5 MHz (W-CDMA)

#### Test Location:

- INTERTEK (Oakdale, MN)
- ADC facility (Shakopee, MN)**

#### Test Distance:

- 3 Meters
- 10 Meters
- Conducted measurement**

#### Test Equipment (ADC):

1, 2, 6, 7, 12

#### Test Limit:

100 Watts or 50 dBm Limit

#### Test Data:

[Conducted Output Power; Section 7.2](#)

[Table of Contents; Section 1.0](#)

**Test Engineer:** Joshua J. Wittman

**Date:** 20 July, 2011

## 5.1.2 27.54 Frequency Stability

### Test Summary:

- The requirements are:             **MET**                             NOT MET
- The fundamental emission stays within the limit.
- Frequency measured over a temperature range of –25 to 50° C and an input voltage range of 100 to 240 VAC.

### Test Location:

- INTERTEK (Oakdale, MN)
- ADC facility (Shakopee, MN)**

### Test Equipment (ADC):

3, 4, 5, 6, 9,11,12

### Test Limit:

The frequency stability shall be sufficient to ensure that the fundamental emission stays within the authorized frequency block.

### Test Data:

[Frequency Stability; Section 7.3](#)

[Table of Contents; Section 1.0](#)

**Test Engineer:** Joshua J. Wittman

**Date:** 20 July, 2011

### 5.1.3 27.53 Emission Limitations

#### Test Summary:

- The requirements are:             **MET**                             NOT MET
- Out of band emissions were less than  $-13$  dBm.
- Outside the emission bandwidth of the carrier, all emissions are attenuated at least 26 dB below the transmitter power.

#### Test Location:

- INTERTEK (Oakdale, MN)
- ADC facility (Shakopee, MN)**

#### Test Equipment (ADC):

1, 2, 6, 7, 12

#### Test Limit:

Out of band emissions:

Attenuated below the transmitting power (P) by a factor of at least  $43 + 10\log(P)$  dB, or  $-13$  dBm.

Outside of the carrier emissions bandwidth:

26 dB below the transmitter power

#### Test Data:

[Conducted Emissions; Section 7.1](#)

[Intermodulation; Section 7.4](#)

[Occupied Bandwidth; Section 7.5](#)

Radiated Emissions; ([Appendix B](#))

[Table of Contents; Section 1.0](#)

**Test Engineer:** Joshua J. Wittman

**Date:** 20 July, 2011

## 6.0 TEST EQUIPMENT

[Table of Contents: Section 1.0](#)

Number	Description	Manufacturer	Model	ADC TELECOMMUNICATIONS Serial Number	Cal Due	Used
1	Spectrum Analyzer	HP	8563E	MC27690	12-15-11	<input checked="" type="checkbox"/>
2	Power Meter	HP	437B	MC27541	6-30-12	<input checked="" type="checkbox"/>
3	Multimeter	Fluke	79	MC18758	6-30-13	<input checked="" type="checkbox"/>
4	Frequency Counter	HP	5347A	MC27569	8-12-11	<input checked="" type="checkbox"/>
5	Temperature Chamber	ESPEC	PSL-4G	MC10075	8-30-11	<input checked="" type="checkbox"/>
6	Signal Generator	Aeroflex	3413	MC57343	11-9-12	<input checked="" type="checkbox"/>
7	Signal Generator	Aeroflex	3413	MC57947	9-30-11	<input checked="" type="checkbox"/>
8	Variable Auto Transformer	Staco	1520CT	MC44655	CNR	<input checked="" type="checkbox"/>
9	Digital Barometer	Fisher Scientific	02-403	MC50719	1-20-12	<input checked="" type="checkbox"/>
10	Attenuator	Aeroflex	49-30-33	N/A	CNR	<input checked="" type="checkbox"/>
11	Attenuator	Aeroflex	86-30-12	N/A	CNR	<input checked="" type="checkbox"/>
12	RF Power Sensor	HP	8482A	MC27542	8-12-11	<input checked="" type="checkbox"/>

Equipment with a Calibration Not Required (CNR) listing is verified and compensated for with NIST traceable calibrated equipment.



7.0

**APPENDIX A**

Conducted Emissions Test Data

[Table of Contents: Section 1.0](#)

**Test Engineer:** Joshua J. Wittman

## 7.1 Conducted Emission Limits Test

[Table of Contents: Section 1.0](#)

[Back to Emission Limits: Section 5.1.3](#)

The out of band emissions were measured directly from the EUT antenna output in the TX path using a spectrum analyzer from 30 MHz to the 10<sup>th</sup> harmonic of the highest carrier frequency. Test signals used are CDMA, GSM, EDGE, & WCDMA. The different signals were input one at a time to the EUT. In all cases, the out of band emissions were less than -13 dBm from the equation

$$(19\text{dBm} - [43 + 10\log(0.08\text{W})])$$

Band edge compliance is also demonstrated using a CDMA, GSM, EDGE, & WCDMA signal at the upper and lower limits of the band.

The Prism Host, Spectrum DRU, and Spectrum IFEU are Part 15 devices and have been tested and are compliant as such.

Industry practice has generally set the input signal power level. Test signal used was  $\approx$  -11 dBm input to Prism Host in the TX Path.

Industry practice has generally set the output signal power level.

Prism Host:	Spectrum DRU:	Spectrum IFEU	Remote Access Unit(RAU):
Range: 21 - 60 VDC	Range: 21 - 60 VDC	Range: 54 VDC	Range: 54 VDC
Tested @: 54 VDC	Tested @: 54 VDC	Tested @: 54 VDC	Tested @: 54 VDC

Application details for 2.1033(c)(10), and 2.1033(c)(13):

Final RF Amplifier Input DC Voltage and Current: 7.3V at 400mA

PLL creates all the Local Oscillators that convert signal to IF and RF signals. When PLL is unlocked the band is shut down, this is to avoid transmission of any incorrect frequency.

Internal to the electronics, the use of SAW filters provides for higher Q roll-off at band edges.

This equipment does not modulate the RF, so there is no modulation limiter. This equipment does not change the modulation of the RF or the occupied bandwidth of any channel. It transports the signal, as is, over TV (IF) coax cable. The RF input is not changed in the RF output.

This is a constant gain device, so the setup controls the output. There is an overdrive and overpower limit control that prevents excess power.

Results:

Pass (See plots)

Conducted Emissions      WCDMA      Spectrum AWS Path 1  
 Center: 2132.5 MHz      Span: 10 MHz      RBW/VBW: 100 kHz  
 ATTEN 10dB      MKR -32.17dBm  
 RL 41.5dBm      10dB/      2.13538GHz

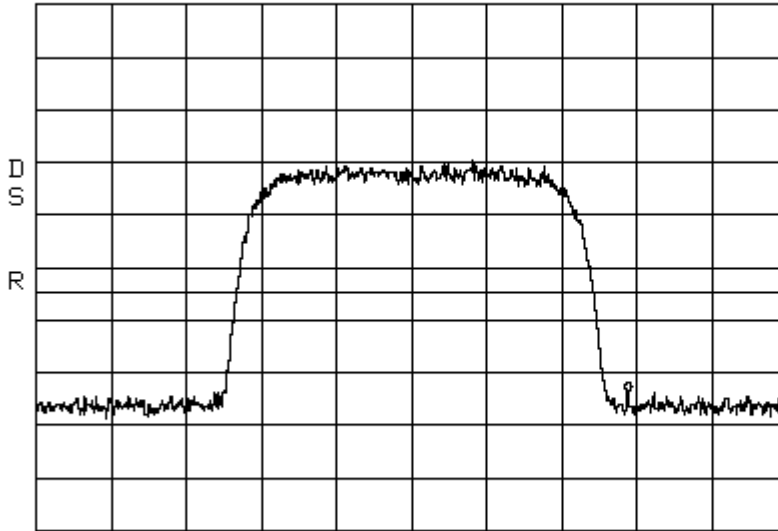

CENTER 2.13250GHz      SPAN 10.00MHz  
 \*RBW 100kHz      VBW 100kHz      SWP 50ms

Conducted Emissions      WCDMA      Spectrum AWS Path 1  
 Span: 30 MHz to 1 GHz      RBW/VBW: 300 kHz

ATTEN 10dB      MKR -28.00dBm  
 RL 41.5dBm      10dB/      894.9MHz

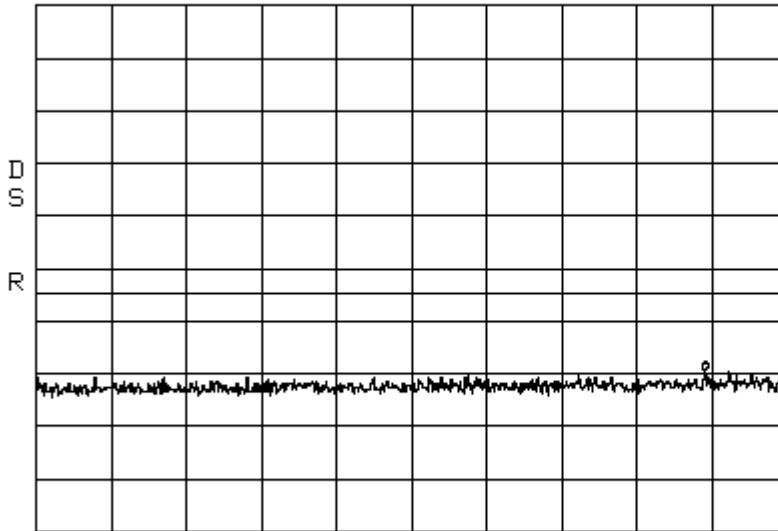

START 30.0MHz      STOP 1.0000GHz  
 \*RBW 300kHz      VBW 300kHz      SWP 50ms

Conducted Emissions WCDMA Spectrum AWS Path 1  
Span: 1 GHz to 10 GHz RBW/VBW: 1 MHz

ATTEN 10dB MKR -22.50dBm  
RL 41.5dBm 10dB/ 2.755GHz

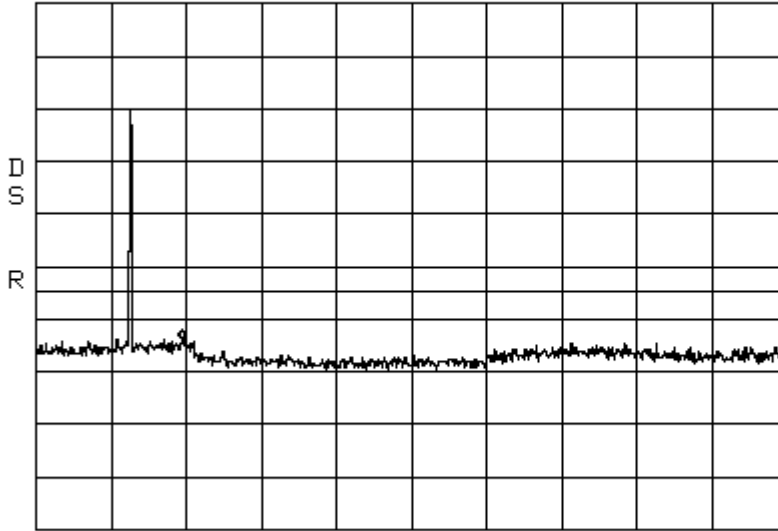

START 1.000GHz STOP 10.000GHz  
\*RBW 1.0MHz VBW 1.0MHz SWP 180ms

Conducted Emissions WCDMA Spectrum AWS Path 1  
Span: 10 GHz to 22 GHz RBW/VBW: 1 MHz

ATTEN 10dB MKR -20.50dBm  
RL 41.5dBm 10dB/ 16.54GHz

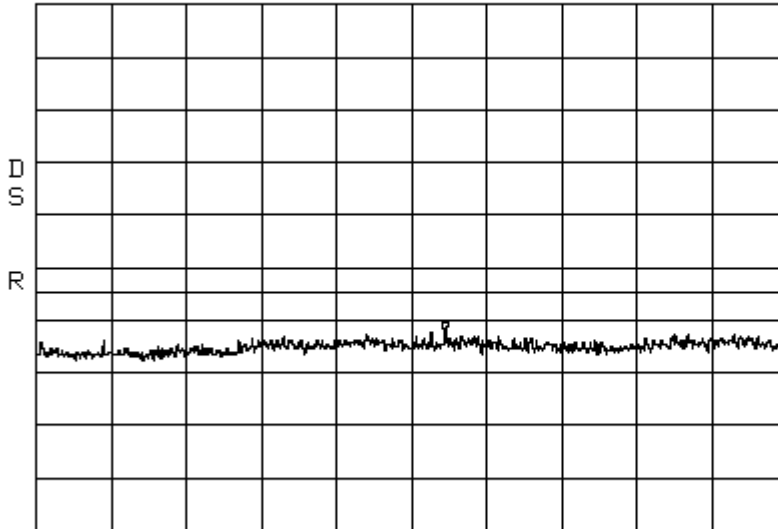

START 10.000GHz STOP 22.000GHz  
\*RBW 1.0MHz VBW 1.0MHz SWP 240ms



Conducted Emissions  
Span: 1 GHz to 20 GHz

CDMA

Spectrum PCS Path 1  
RBW/VBW: 1 MHz

\*ATTEN 10dB  
RL 41.5dBm 10dB/  
MKR -21.00dBm  
2.36GHz

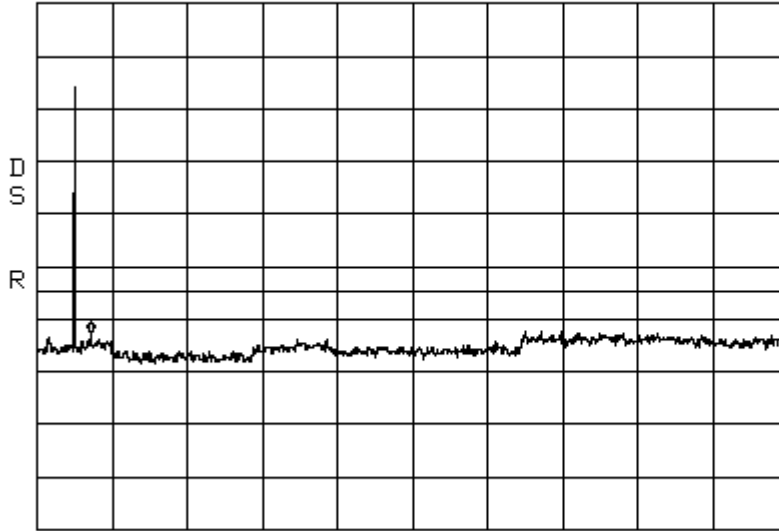

START 1.00GHz STOP 20.00GHz  
\*RBW 1.0MHz \*VBW 1.0MHz SWP 380ms

Conducted Emissions  
Center: 1960 MHz

EDGE  
Span: 5 MHz

Spectrum PCS Path 1  
RBW/VBW: 100 kHz

\*ATTEN 10dB  
RL 41.5dBm 10dB/  
MKR -32.17dBm  
1.957592GHz

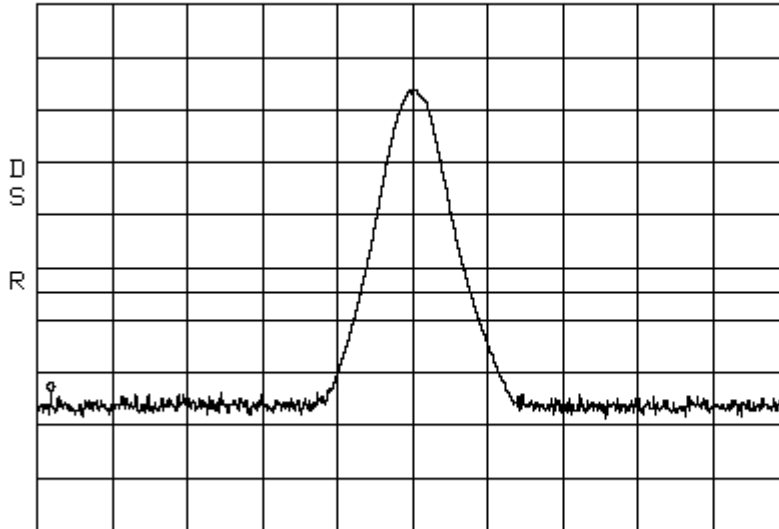

CENTER 1.960000GHz SPAN 5.000MHz  
\*RBW 100kHz \*VBW 100kHz SWP 50ms

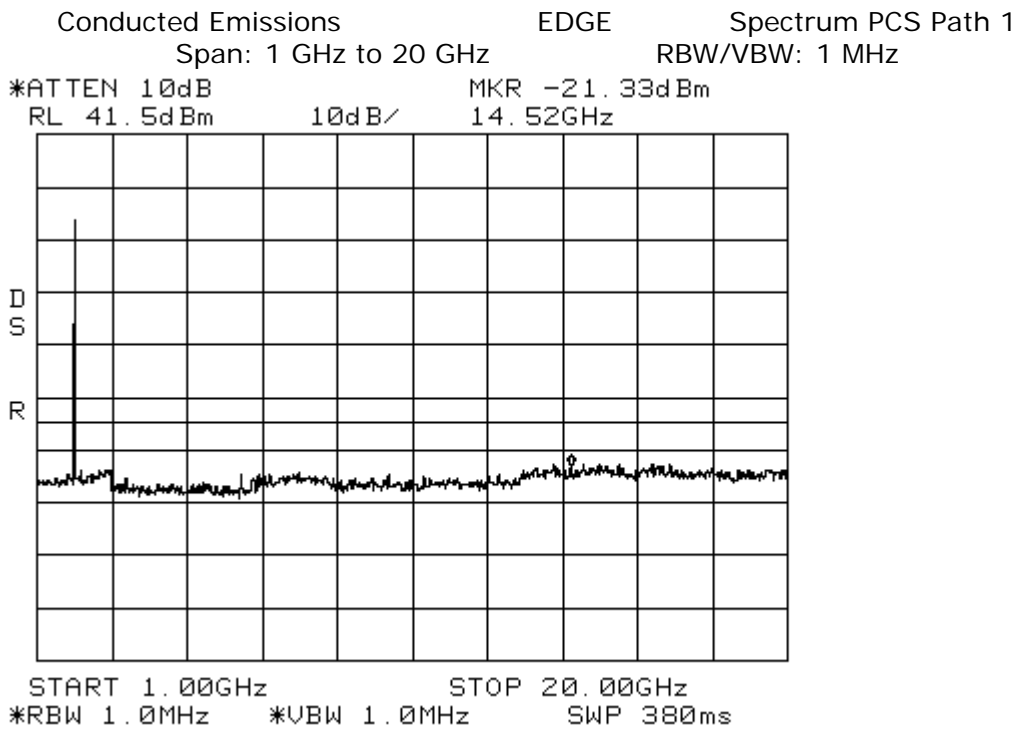
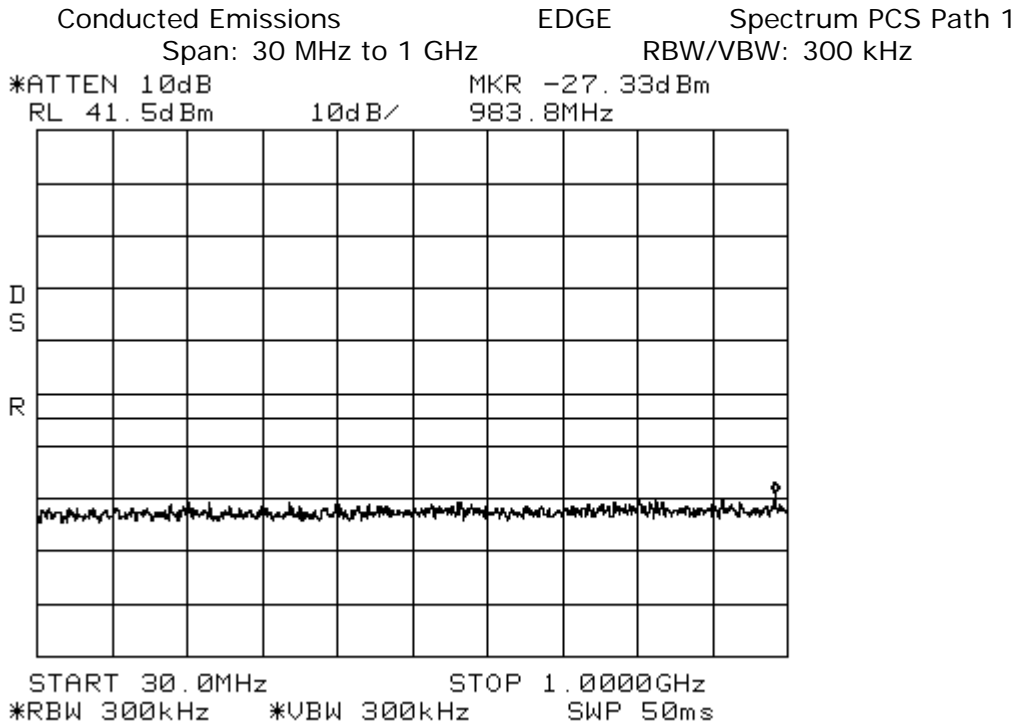

Conducted Emissions  
Center: 1960 MHz

GSM  
Span: 5 MHz

Spectrum PCS Path 1  
RBW/VBW: 100 kHz

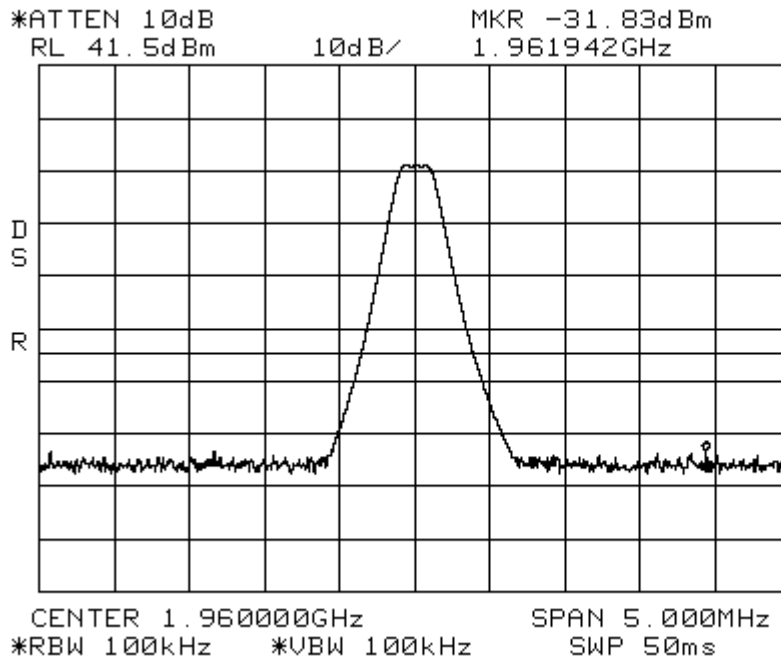

Conducted Emissions  
Span: 30 MHz to 1 GHz

GSM

Spectrum PCS Path 1  
RBW/VBW: 300 kHz

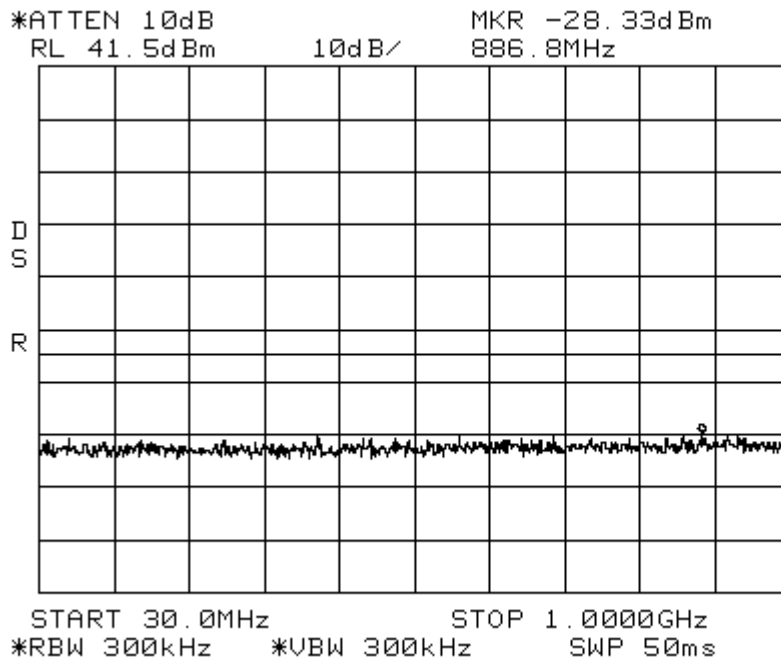





Conducted Emissions

WCDMA

Spectrum PCS Path 1

Span: 30 MHz to 1 GHz

RBW/VBW: 300 kHz

\*ATTEN 10dB

MKR -28.33dBm

RL 41.5dBm

10dB/

599.1MHz

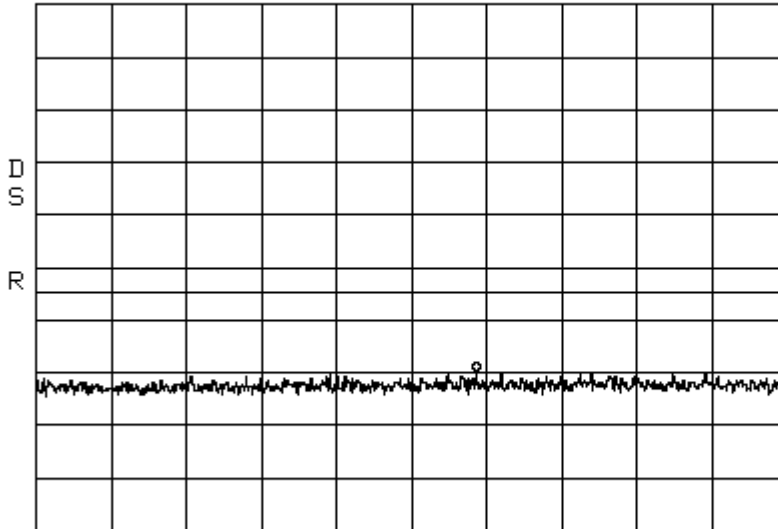

START 30.0MHz

STOP 1.0000GHz

\*RBW 300kHz

\*VBW 300kHz

SWP 50ms

Conducted Emissions

WCDMA

Spectrum PCS Path 1

Span: 1 GHz to 20 GHz

RBW/VBW: 1 MHz

\*ATTEN 10dB

MKR -21.00dBm

RL 41.5dBm

10dB/

16.36GHz

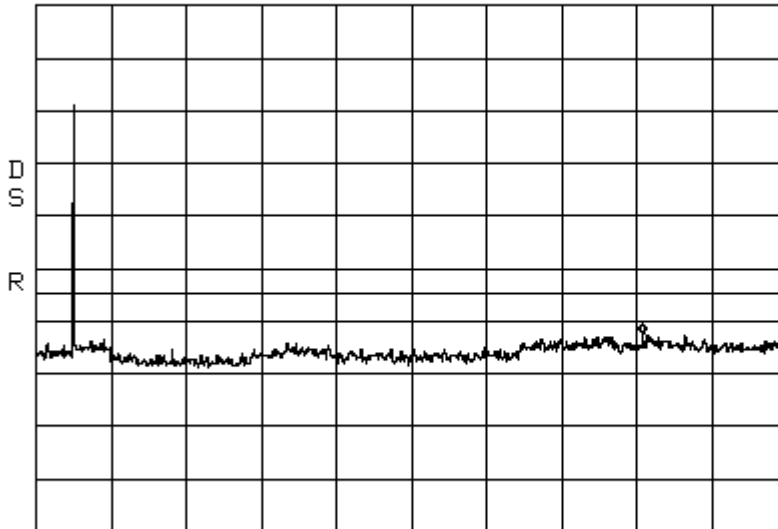

START 1.00GHz

STOP 20.00GHz

\*RBW 1.0MHz

\*VBW 1.0MHz

SWP 380ms

Band\_Edge                      CDMA                      Spectrum PCS Path 1  
Center: 1930.75 MHz              Span: 2 MHz                      RBW: 10 kHz VBW: 10 kHz

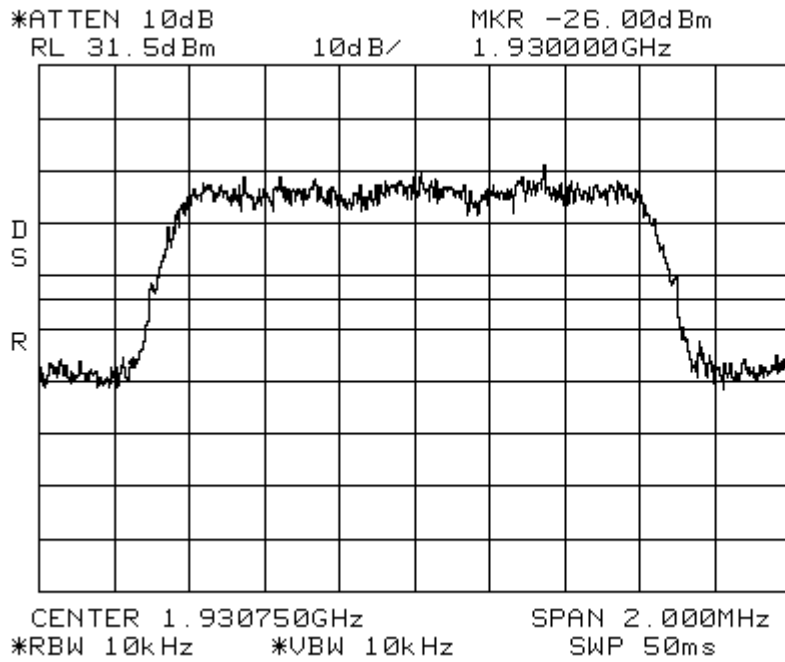

Band\_Edge                      CDMA                      Spectrum PCS Path 1  
Center: 1989.25 MHz              Span: 2 MHz                      RBW: 10 kHz VBW: 10 kHz

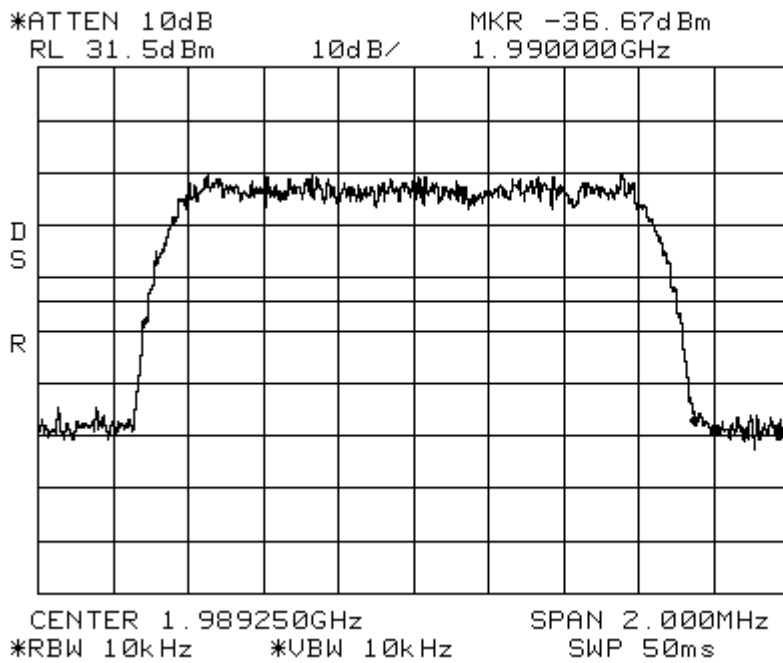

Band\_Edge                      EDGE                      Spectrum PCS Path 1  
Center: 1930.2 MHz Span: 500 kHz                      RBW: 3 kHz    VBW: 10 kHz  
\*ATTEN 10dB                      MKR -27.83dBm  
RL 31.5dBm                      10dB/                      1.9300000GHz

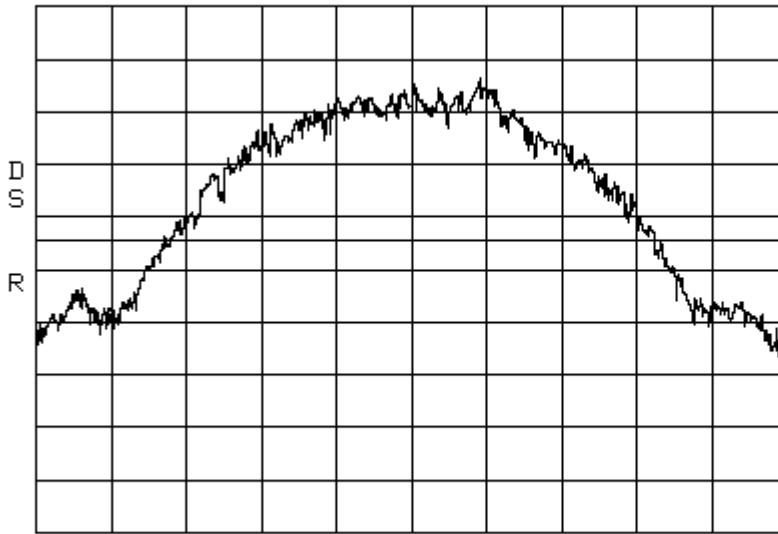

CENTER 1.9302000GHz                      SPAN 500.0kHz  
\*RBW 3.0kHz                      \*VBW 10kHz                      SWP 140ms

Band\_Edge                      EDGE                      Spectrum PCS Path 1  
Center: 1989.8 MHz Span: 500 kHz                      RBW: 3 kHz    VBW: 10 kHz  
\*ATTEN 10dB                      MKR -28.17dBm  
RL 31.5dBm                      10dB/                      1.9900000GHz

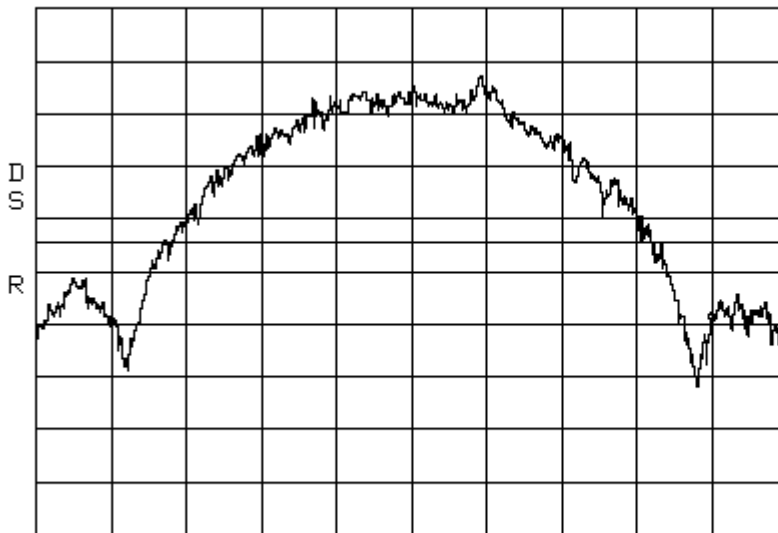

CENTER 1.9898000GHz                      SPAN 500.0kHz  
\*RBW 3.0kHz                      \*VBW 10kHz                      SWP 140ms

Band\_Edge GSM Spectrum PCS Path 1  
Center: 1930.2 MHz Span: 500 kHz RBW: 3 kHz VBW: 10 kHz

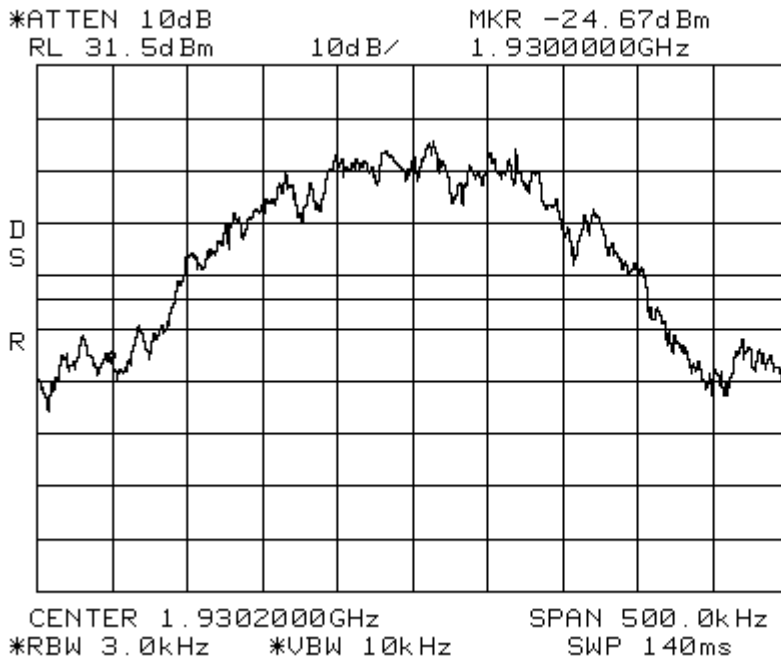

Band\_Edge GSM Spectrum PCS Path 1  
Center: 1989.8 MHz Span: 500 kHz RBW: 3 kHz VBW: 10 kHz

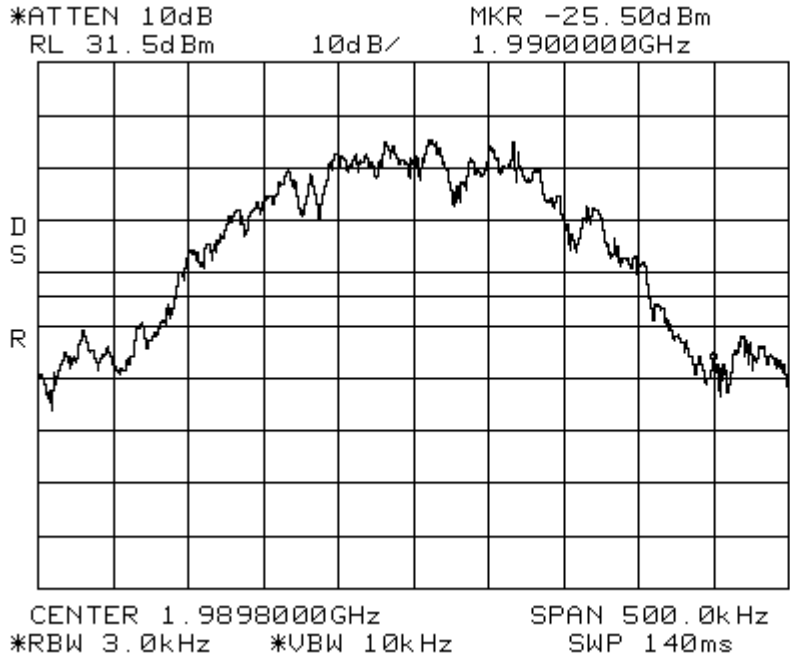

Band\_Edge WCDMA  
Center: 1932.5 MHz Span: 5 MHz

Spectrum PCS Path 1  
RBW: 10 kHz VBW: 10 kHz

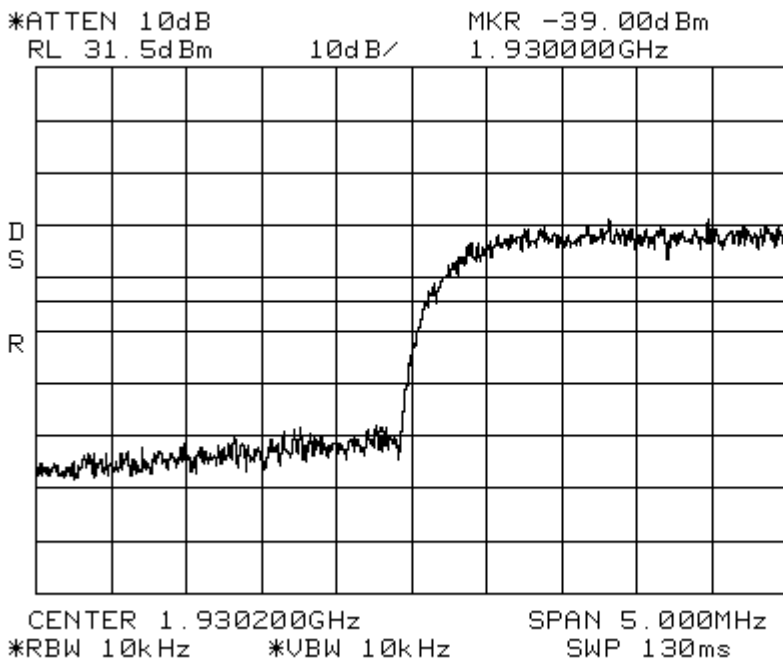

Band\_Edge WCDMA  
Center: 1987.5 MHz Span: 5 MHz

Spectrum PCS Path 1  
RBW: 10 kHz VBW: 10 kHz

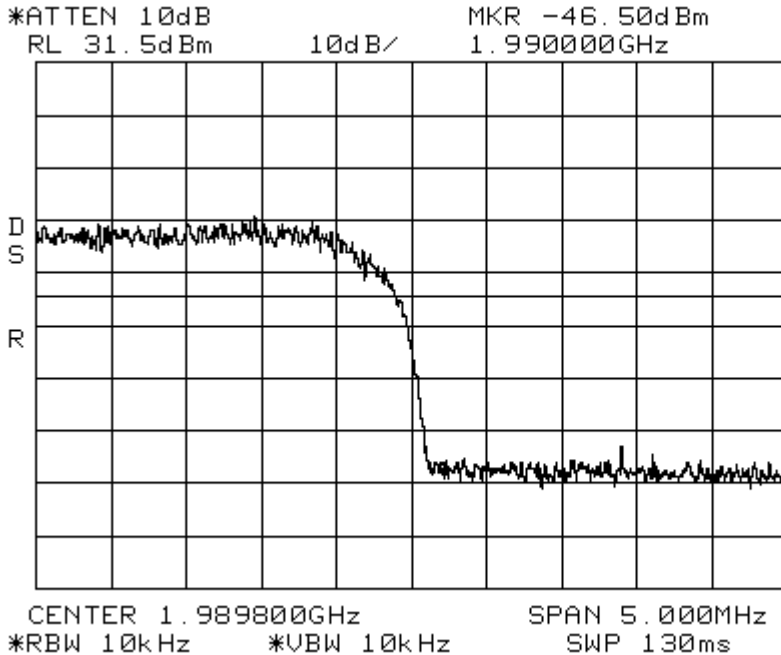

Band\_Edge WCDMA Spectrum AWS Path 1  
Center: 2112.5 MHz Span: 6 MHz RBW: 10 kHz VBW: 10 kHz

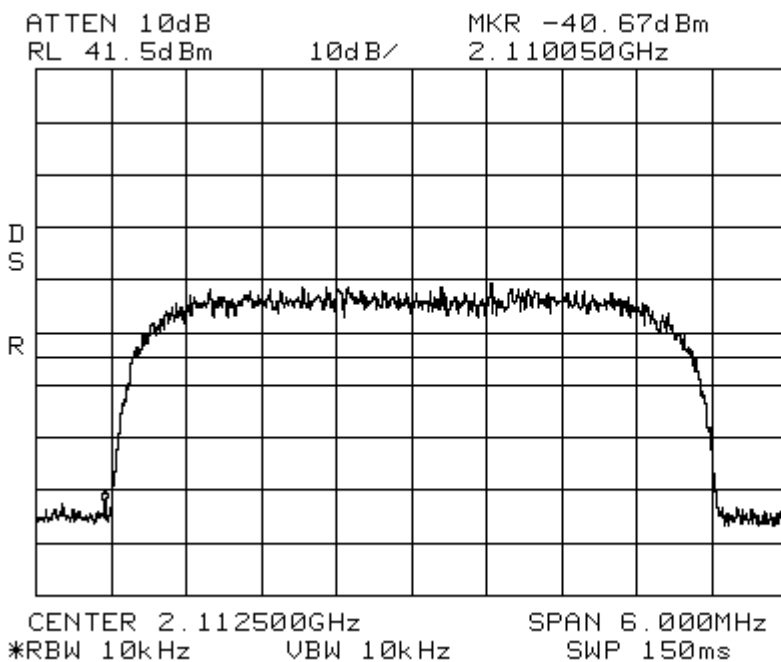

Band\_Edge WCDMA Spectrum AWS Path 1  
Center: 2152.5 MHz Span: 6 MHz RBW: 10 kHz VBW: 10 kHz

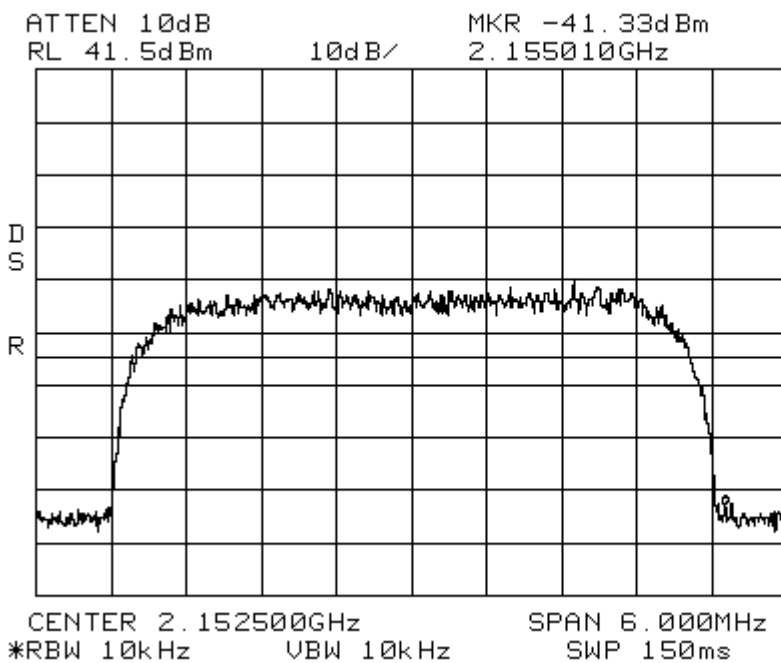

## 7.2 Conducted Output Power Test

[Table of Contents: Section 1.0](#)

[Back to Conducted Output Power: Section 5.1.1](#)

\*Note: The EUT is a fixed repeater and not a base station.

This measurement was made as a direct conducted emission measurement. The output from the EUT antenna connector was connected to the power meter. The carrier output, below, was conducted using a single CDMA, GSM, EDGE, & WCDMA signal generator. The power meter level was offset to compensate for attenuators and cable loss between the EUT and the power meter.

A signal was used at the low, mid and high parts of the selected band.

### PCS Path1

#### **CDMA** 0.2338 Watts

Carrier Frequency	Carrier Output
1930.8 MHz	<u>21.70</u> dBm
1960.0 MHz	<u>23.69</u> dBm
1989.2 MHz	<u>21.98</u> dBm

### PCS Path1

#### **GSM** 0.3767 Watts

Carrier Frequency	Carrier Output
1930.2 MHz	<u>23.94</u> dBm
1960.0 MHz	<u>25.76</u> dBm
1989.8 MHz	<u>24.80</u> dBm

### PCS Path1

#### **EDGE** 0.3427 Watts

Carrier Frequency	Carrier Output
1930.2 MHz	<u>23.59</u> dBm
1960.0 MHz	<u>25.35</u> dBm
1989.8 MHz	<u>24.22</u> dBm

### PCS Path1

#### **WCDMA** 0.0785 Watts

Carrier Frequency	Carrier Output
1932.5 MHz	<u>17.53</u> dBm
1960.0 MHz	<u>18.95</u> dBm
1987.5 MHz	<u>16.69</u> dBm

### AWS Path 1

#### **WCDMA** 0.04295 Watts

Carrier Frequency	Carrier Output
2112.5 MHz	<u>16.33</u> dBm
2132.5 MHz	<u>15.80</u> dBm
2152.5 MHz	<u>15.77</u> dBm



### 7.3 Frequency Stability Test

[Table of Contents: Section 1.0](#)

[Back to Frequency Stability: Section 5.1.1](#)

Host/DRU	IFEU	RAU			
Input Voltage	Input Voltage	Input Voltage	Carrier Frequency	Measured Frequency	Meets Requirements?
100 VAC	54VDC	54 VDC	2110.200 MHz	2110.200 MHz	Yes
170 VAC	54VDC	54 VDC	2110.200 MHz	2110.200 MHz	Yes
240 VAC	54VDC	54 VDC	2110.200 MHz	2110.200 MHz	Yes
100 VAC	54VDC	54 VDC	2132.500 MHz	2132.500 MHz	Yes
170 VAC	54VDC	54 VDC	2132.500 MHz	2132.500 MHz	Yes
240 VAC	54VDC	54 VDC	2132.500 MHz	2132.500 MHz	Yes
100 VAC	54VDC	54 VDC	2154.800 MHz	2154.800 MHz	Yes
170 VAC	54VDC	54 VDC	2154.800 MHz	2154.800 MHz	Yes
240 VAC	54VDC	54 VDC	2154.800 MHz	2154.800 MHz	Yes
Temperature			Carrier Frequency	Measured Frequency	Meets Requirements?
-25 Deg. C			2110.200 MHz	2110.200 MHz	Yes
-20 Deg. C			2110.200 MHz	2110.200 MHz	Yes
-10 Deg. C			2110.200 MHz	2110.200 MHz	Yes
0 Deg. C			2110.200 MHz	2110.200 MHz	Yes
10 Deg. C			2110.200 MHz	2110.200 MHz	Yes
20 Deg. C			2110.200 MHz	2110.200 MHz	Yes
30 Deg. C			2110.200 MHz	2110.200 MHz	Yes
40 Deg. C			2110.200 MHz	2110.200 MHz	Yes
45 Deg. C			2110.200 MHz	2110.200 MHz	Yes
50 Deg. C			2110.200 MHz	2110.200 MHz	Yes
-25 Deg. C			2132.500 MHz	2132.500 MHz	Yes
-20 Deg. C			2132.500 MHz	2132.500 MHz	Yes
-10 Deg. C			2132.500 MHz	2132.500 MHz	Yes
0 Deg. C			2132.500 MHz	2132.500 MHz	Yes
10 Deg. C			2132.500 MHz	2132.500 MHz	Yes
20 Deg. C			2132.500 MHz	2132.500 MHz	Yes
30 Deg. C			2132.500 MHz	2132.500 MHz	Yes
40 Deg. C			2132.500 MHz	2132.500 MHz	Yes
45 Deg. C			2132.500 MHz	2132.500 MHz	Yes
50 Deg. C			2132.500 MHz	2132.500 MHz	Yes
-25 Deg. C			2154.800 MHz	2154.800 MHz	Yes
-20 Deg. C			2154.800 MHz	2154.800 MHz	Yes
-10 Deg. C			2154.800 MHz	2154.800 MHz	Yes
0 Deg. C			2154.800 MHz	2154.800 MHz	Yes
10 Deg. C			2154.800 MHz	2154.800 MHz	Yes
20 Deg. C			2154.800 MHz	2154.800 MHz	Yes
30 Deg. C			2154.800 MHz	2154.800 MHz	Yes
40 Deg. C			2154.800 MHz	2154.800 MHz	Yes
45 Deg. C			2154.800 MHz	2154.800 MHz	Yes
50 Deg. C			2154.800 MHz	2154.800 MHz	Yes

Host/DRU	IFEU	RAU			
Input Voltage	Input Voltage	Input Voltage	Carrier Frequency	Measured Frequency	Meets Requirements?
100 VAC	54VDC	54 VDC	1930.200 MHz	1930.200 MHz	Yes
170 VAC	54VDC	54 VDC	1930.200 MHz	1930.200 MHz	Yes
240 VAC	54VDC	54 VDC	1930.200 MHz	1930.200 MHz	Yes
100 VAC	54VDC	54 VDC	1960.000 MHz	1960.000 MHz	Yes
170 VAC	54VDC	54 VDC	1960.000 MHz	1960.000 MHz	Yes
240 VAC	54VDC	54 VDC	1960.000 MHz	1960.000 MHz	Yes
100 VAC	54VDC	54 VDC	1989.800 MHz	1989.800 MHz	Yes
170 VAC	54VDC	54 VDC	1989.800 MHz	1989.800 MHz	Yes
240 VAC	54VDC	54 VDC	1989.800 MHz	1989.800 MHz	Yes
Temperature			Carrier Frequency	Measured Frequency	Meets Requirements?
-25 Deg. C			1930.200 MHz	1930.200 MHz	Yes
-20 Deg. C			1930.200 MHz	1930.200 MHz	Yes
-10 Deg. C			1930.200 MHz	1930.200 MHz	Yes
0 Deg. C			1930.200 MHz	1930.200 MHz	Yes
10 Deg. C			1930.200 MHz	1930.200 MHz	Yes
20 Deg. C			1930.200 MHz	1930.200 MHz	Yes
30 Deg. C			1930.200 MHz	1930.200 MHz	Yes
40 Deg. C			1930.200 MHz	1930.200 MHz	Yes
45 Deg. C			1930.200 MHz	1930.200 MHz	Yes
50 Deg. C			1930.200 MHz	1930.200 MHz	Yes
-25 Deg. C			1960.000 MHz	1960.000 MHz	Yes
-20 Deg. C			1960.000 MHz	1960.000 MHz	Yes
-10 Deg. C			1960.000 MHz	1960.000 MHz	Yes
0 Deg. C			1960.000 MHz	1960.000 MHz	Yes
10 Deg. C			1960.000 MHz	1960.000 MHz	Yes
20 Deg. C			1960.000 MHz	1960.000 MHz	Yes
30 Deg. C			1960.000 MHz	1960.000 MHz	Yes
40 Deg. C			1960.000 MHz	1960.000 MHz	Yes
45 Deg. C			1960.000 MHz	1960.000 MHz	Yes
50 Deg. C			1960.000 MHz	1960.000 MHz	Yes
-25 Deg. C			1989.800 MHz	1989.800 MHz	Yes
-20 Deg. C			1989.800 MHz	1989.800 MHz	Yes
-10 Deg. C			1989.800 MHz	1989.800 MHz	Yes
0 Deg. C			1989.800 MHz	1989.800 MHz	Yes
10 Deg. C			1989.800 MHz	1989.800 MHz	Yes
20 Deg. C			1989.800 MHz	1989.800 MHz	Yes
30 Deg. C			1989.800 MHz	1989.800 MHz	Yes
40 Deg. C			1989.800 MHz	1989.800 MHz	Yes
45 Deg. C			1989.800 MHz	1989.800 MHz	Yes
50 Deg. C			1989.800 MHz	1989.800 MHz	Yes

## 7.4 Intermodulation Test

[Table of Contents: Section 1.0](#)

[Back to Emission Limits: Section 5.1.3](#)

The inter-modulation products test was performed for the EUT. Three tests were performed with the modulation type. Test 1 was with 2 signals input to the EUT at lower end channels. Test 2 was with 2 signals input to the EUT at upper end channels. Test 3 was with 2 signals input to the EUT at upper and lower end channels. The modulation types tested were CDMA, GSM, EDGE, & WCDMA. An investigation was made from 30 MHz to the 10<sup>th</sup> Harmonic of the highest fundamental frequency (~20 GHz). The following plots show the results.

Results:  
(See Plots)

Intermodulation                      CDMA\_Low                      Spectrum PCS Path 1  
 Center: 1960 MHz                      Span: 90 MHz                      RBW/VBW: 100 kHz  
 \*ATTEN 10dB                      MKR -22.67dBm  
 RL 41.5dBm                      10dB/                      1.93750GHz

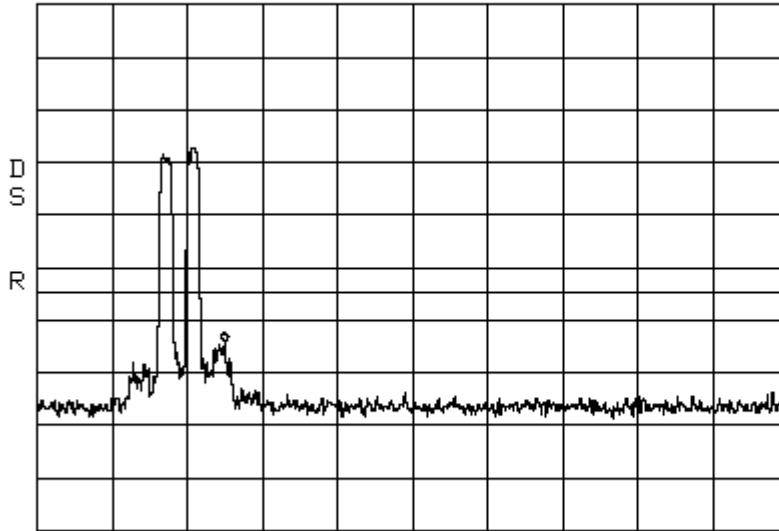

CENTER 1.96000GHz                      SPAN 90.00MHz  
 \*RBW 100kHz                      \*VBW 100kHz                      SWP 50ms

Intermodulation                      CDMA\_Low                      Spectrum PCS Path 1  
 Span: 30 MHz to 1 GHz                      RBW/VBW: 300 kHz  
 \*ATTEN 10dB                      MKR -28.33dBm  
 RL 41.5dBm                      10dB/                      72.0MHz

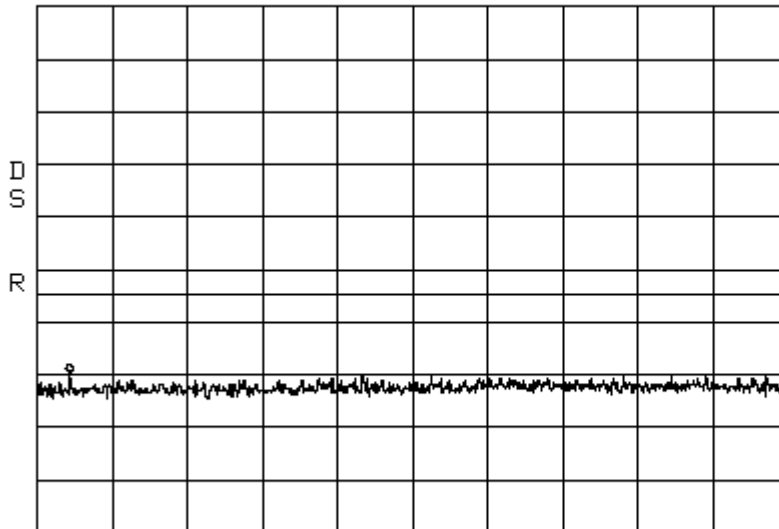

START 30.0MHz                      STOP 1.00000GHz  
 \*RBW 300kHz                      \*VBW 300kHz                      SWP 50ms

Intermodulation                      CDMA\_Low                      Spectrum PCS Path 1  
Span: 1 GHz to 20 GHz                      RBW/VBW: 1 MHz

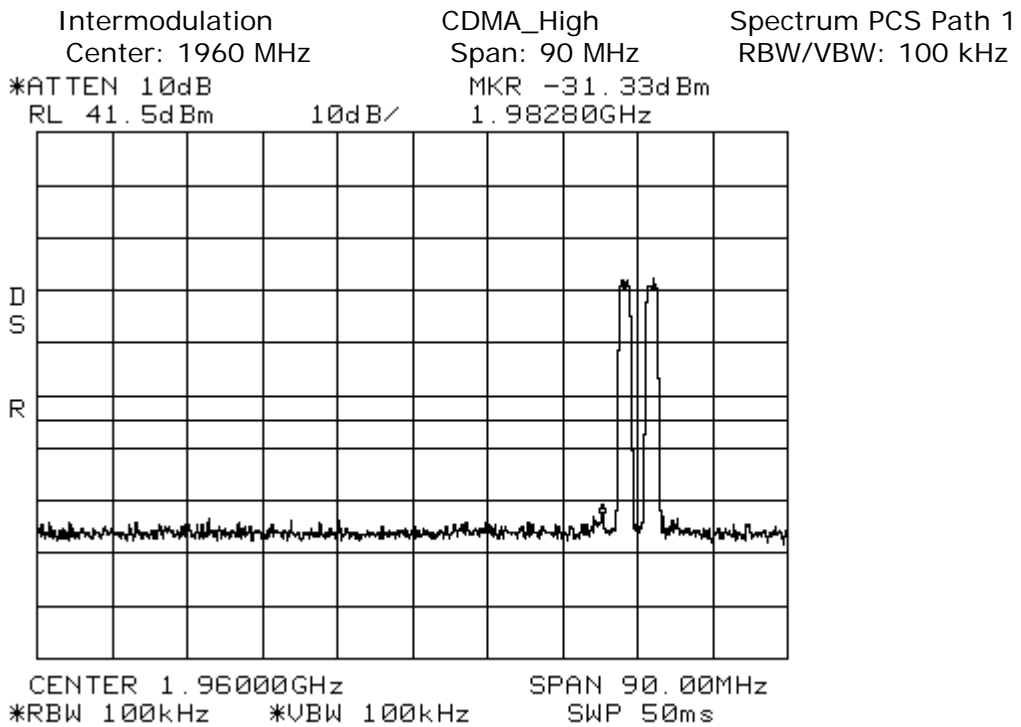
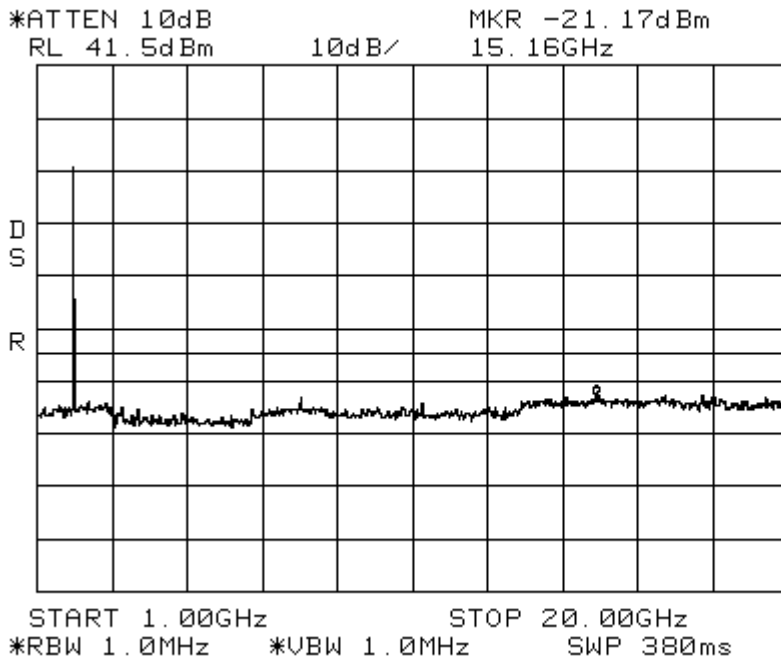

Intermodulation CDMA\_High Spectrum PCS Path 1  
Span: 30 MHz to 1 GHz RBW/VBW: 300 kHz

\*ATTEN 10dB MKR -28.50dBm  
RL 41.5dBm 10dB/ 712.2MHz

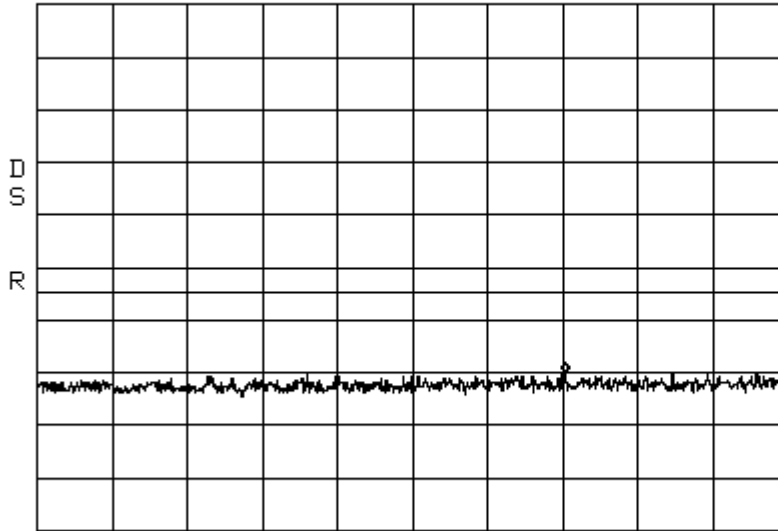

START 30.0MHz STOP 1.0000GHz  
\*RBW 300kHz \*VBW 300kHz SWP 50ms

Intermodulation CDMA\_High Spectrum PCS Path 1  
Span: 1 GHz to 20 GHz RBW/VBW: 1 MHz

\*ATTEN 10dB MKR -20.83dBm  
RL 41.5dBm 10dB/ 16.87GHz

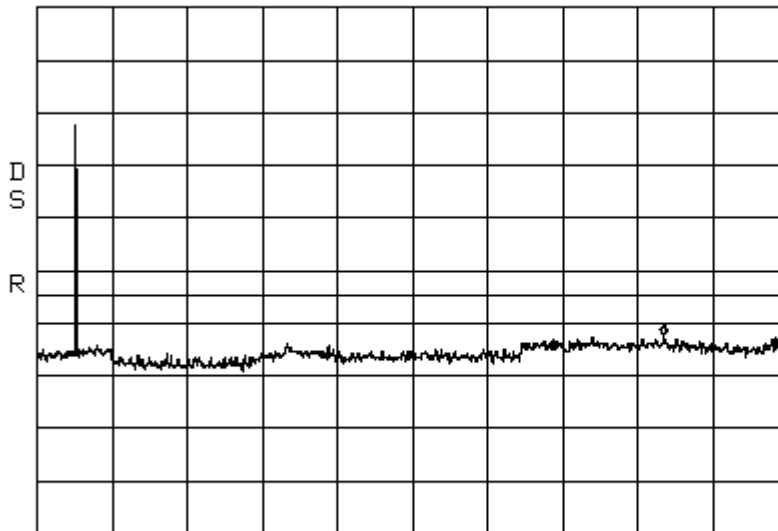

START 1.00GHz STOP 20.00GHz  
\*RBW 1.0MHz \*VBW 1.0MHz SWP 380ms

Intermodulation                      CDMA\_Apart                      Spectrum PCS Path 1  
Center: 1960 MHz                      Span: 175 MHz                      RBW/VBW: 100 kHz  
\*ATTEN 10dB                      MKR -32.17dBm  
RL 41.5dBm                      10dB/                      1.8970GHz

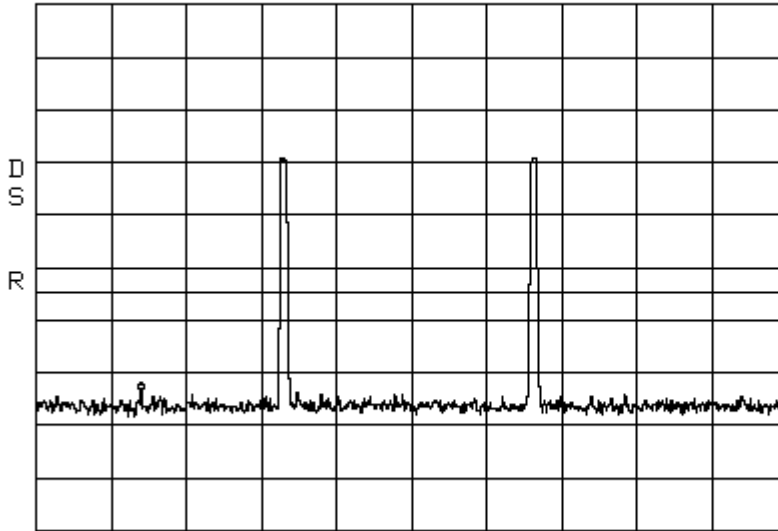

CENTER 1.9600GHz                      SPAN 175.0MHz  
\*RBW 100kHz                      \*VBW 100kHz                      SWP 50ms

Intermodulation                      CDMA\_Apart                      Spectrum PCS Path 1  
Span: 30 MHz to 1 GHz                      RBW/VBW: 300 kHz

\*ATTEN 10dB                      MKR -28.17dBm  
RL 41.5dBm                      10dB/                      980.6MHz

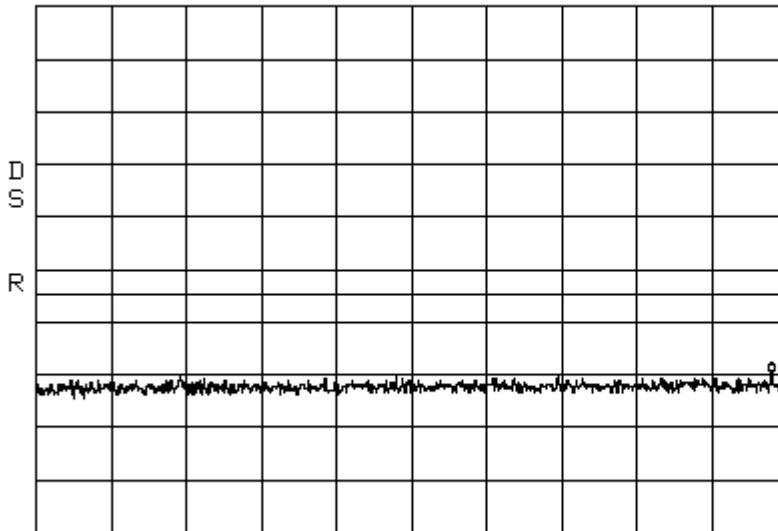

START 30.0MHz                      STOP 1.0000GHz  
\*RBW 300kHz                      \*VBW 300kHz                      SWP 50ms

Intermodulation

CDMA\_Apart

Spectrum PCS Path 1

Span: 1 GHz to 20 GHz

RBW/VBW: 1 MHz

\*ATTEN 10dB  
RL 41.5dBm

10dB/

MKR -20.83dBm  
15.16GHz

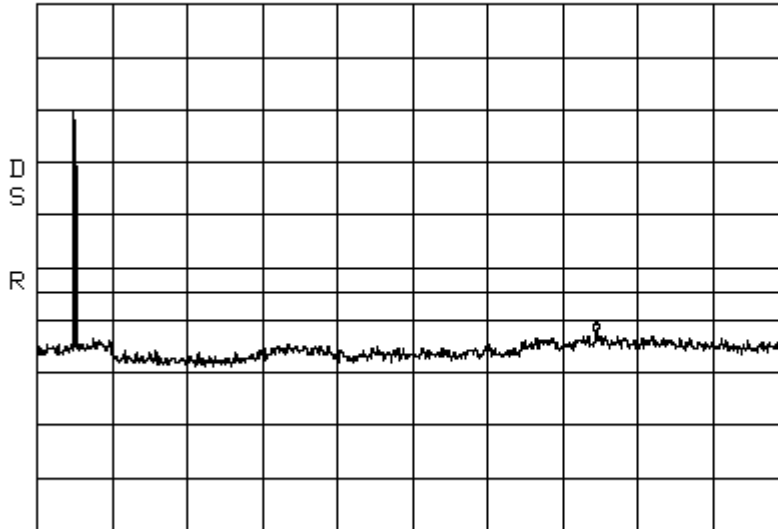

START 1.00GHz STOP 20.00GHz  
\*RBW 1.0MHz \*VBW 1.0MHz SWP 300ms

Intermodulation

EDGE\_Low

Spectrum PCS Path 1

Center: 1960 MHz

Span: 70 MHz

RBW/VBW: 100 kHz

\*ATTEN 10dB  
RL 41.5dBm

10dB/

MKR -18.33dBm  
1.93352GHz

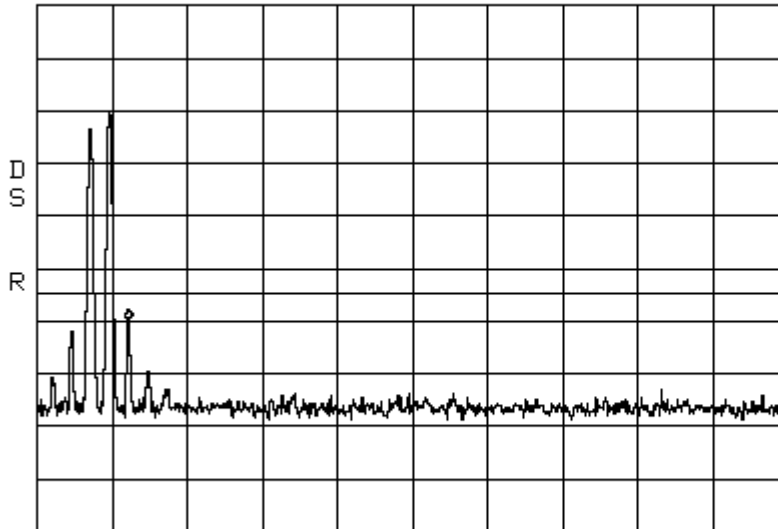

CENTER 1.96000GHz SPAN 70.00MHz  
\*RBW 100kHz \*VBW 100kHz SWP 50ms





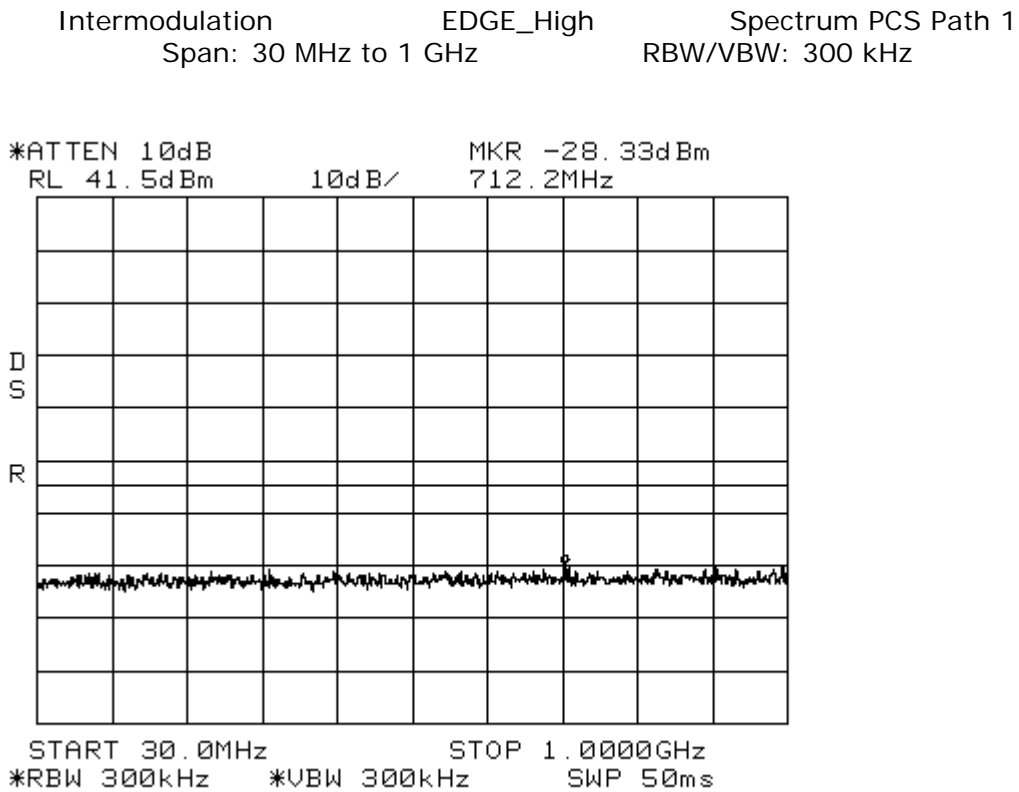
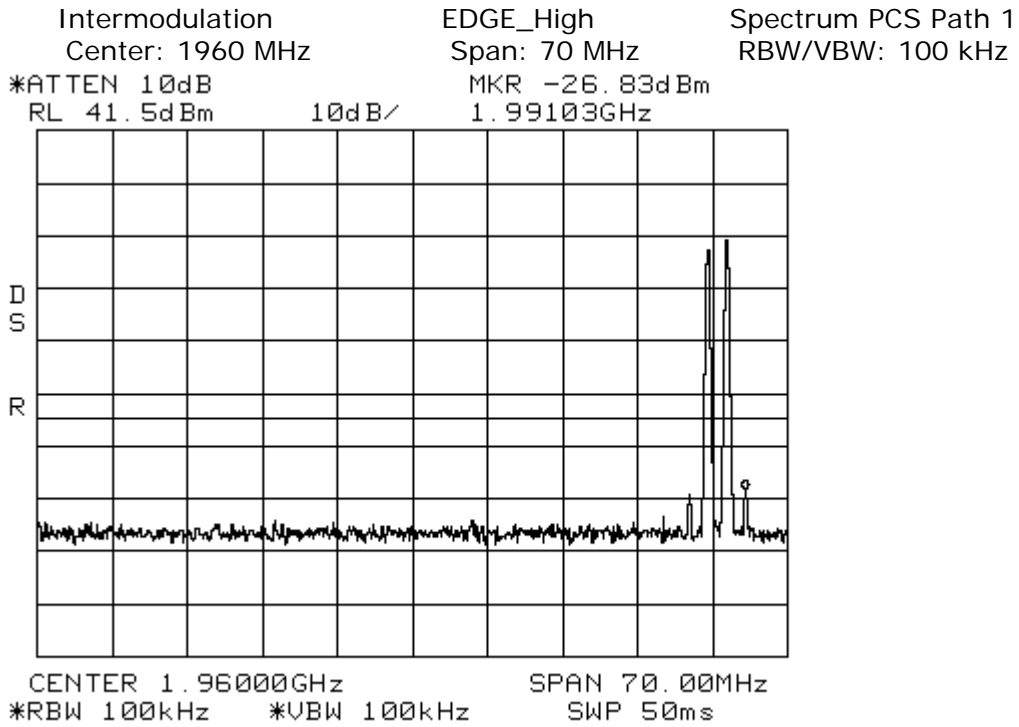

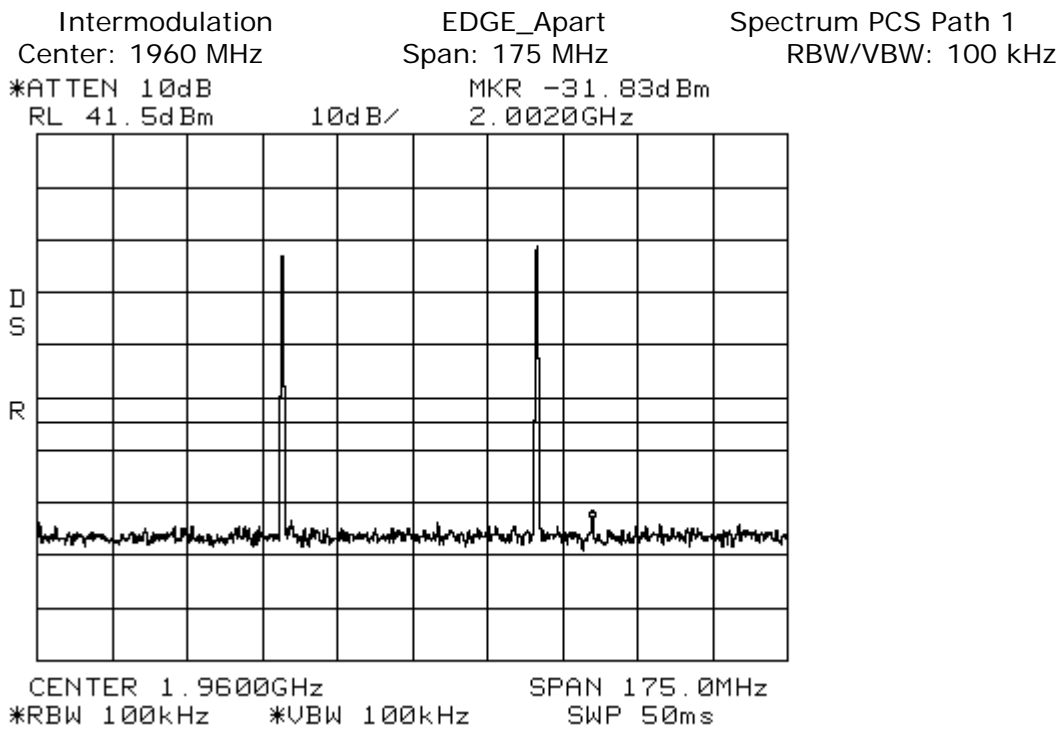
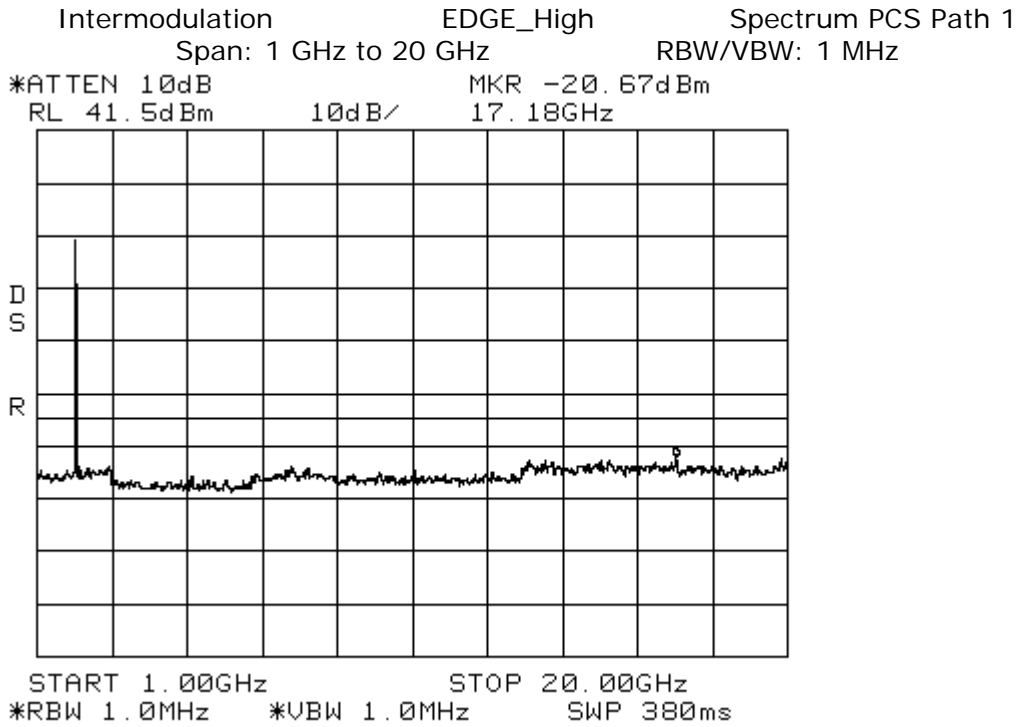



Intermodulation                      GSM\_Low                      Spectrum PCS Path 1  
 Center: 1960 MHz                      Span: 70 MHz                      RBW/VBW: 100 kHz  
 \*ATTEN 10dB                      MKR -27.17dBm  
 RL 41.5dBm                      10dB/                      1.93352GHz

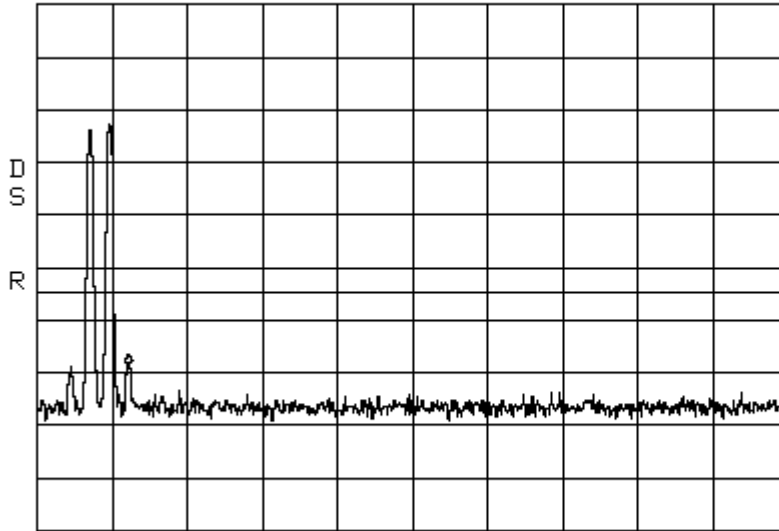

CENTER 1.96000GHz                      SPAN 70.00MHz  
 \*RBW 100kHz                      \*VBW 100kHz                      SWP 50ms

Intermodulation                      GSM\_Low                      Spectrum PCS Path 1  
 Span: 30 MHz to 1 GHz                      RBW/VBW: 300 kHz

\*ATTEN 10dB                      MKR -27.67dBm  
 RL 41.5dBm                      10dB/                      912.7MHz

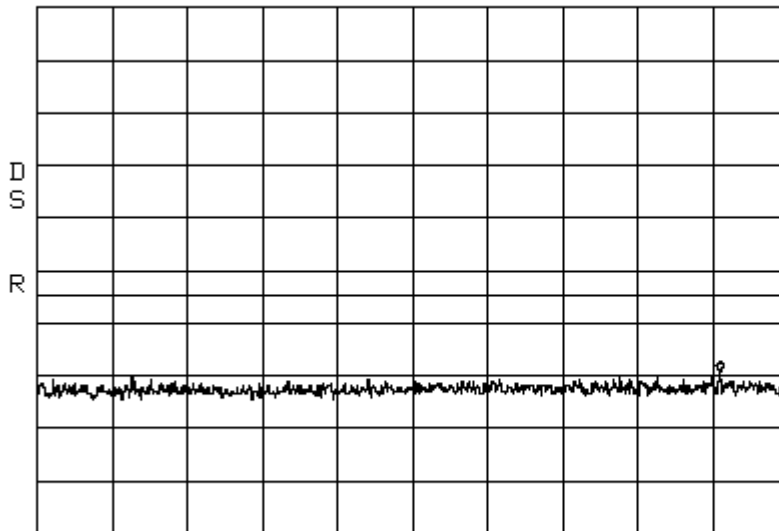

START 30.0MHz                      STOP 1.0000GHz  
 \*RBW 300kHz                      \*VBW 300kHz                      SWP 50ms

Intermodulation

GSM\_Low

Spectrum PCS Path 1

Span: 1 GHz to 20 GHz

RBW/VBW: 1 MHz

\*ATTEN 10dB  
RL 41.5dBm

10dB/

MKR -21.83dBm  
2.87GHz

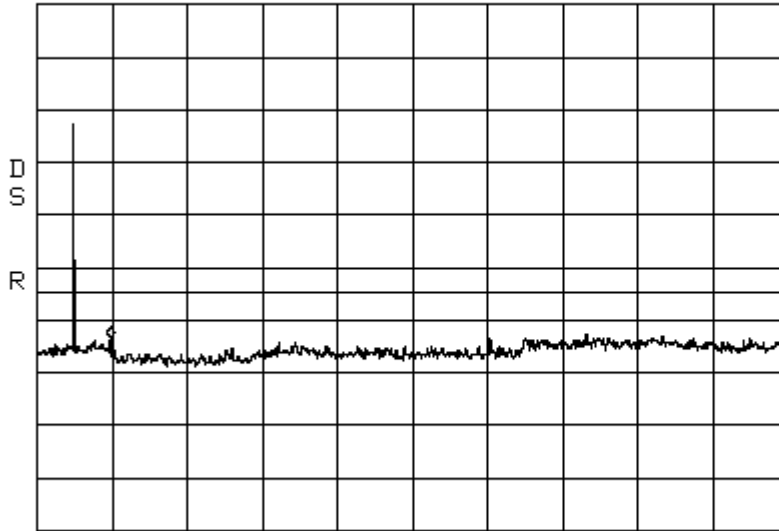

START 1.00GHz STOP 20.00GHz  
\*RBW 1.0MHz \*VBW 1.0MHz SWP 380ms

Intermodulation

GSM\_High

Spectrum PCS Path 1

Center: 1960 MHz

Span: 70 MHz

RBW/VBW: 100 kHz

\*ATTEN 10dB  
RL 41.5dBm

10dB/

MKR -29.50dBm  
1.98217GHz

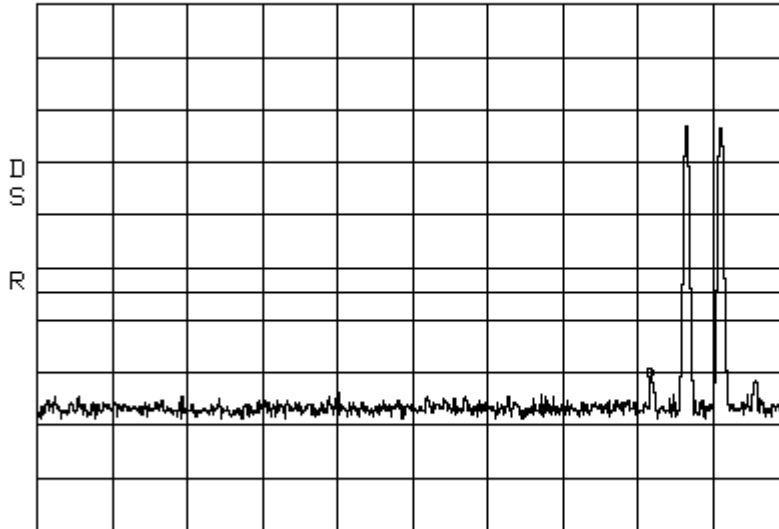

CENTER 1.96000GHz SPAN 70.00MHz  
\*RBW 100kHz \*VBW 100kHz SWP 50ms

Intermodulation

GSM\_High

Spectrum PCS Path 1

Span: 30 MHz to 1 GHz

RBW/VBW: 300 kHz

\*ATTEN 10dB

RL 41.5dBm

10dB/

MKR -27.17dBm

933.7MHz

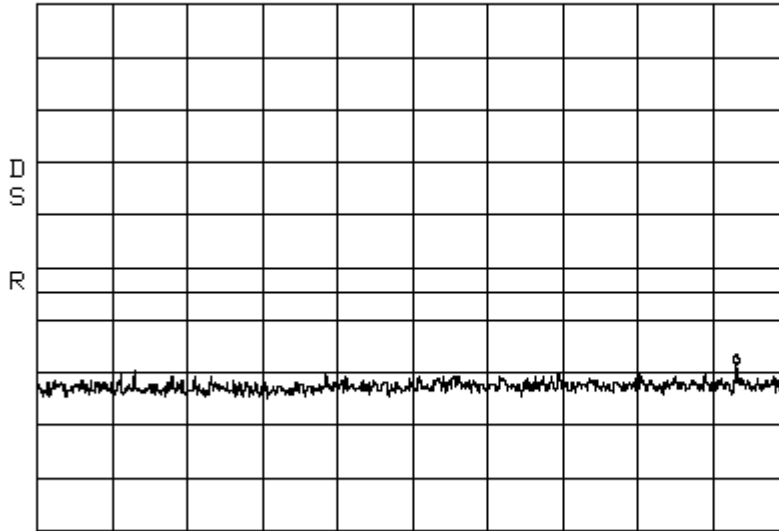

START 30.0MHz

STOP 1.0000GHz

\*RBW 300kHz

\*VBW 300kHz

SWP 50ms

Intermodulation

GSM\_High

Spectrum PCS Path 1

Span: 1 GHz to 20 GHz

RBW/VBW: 1 MHz

\*ATTEN 10dB

RL 41.5dBm

10dB/

MKR -20.00dBm

16.52GHz

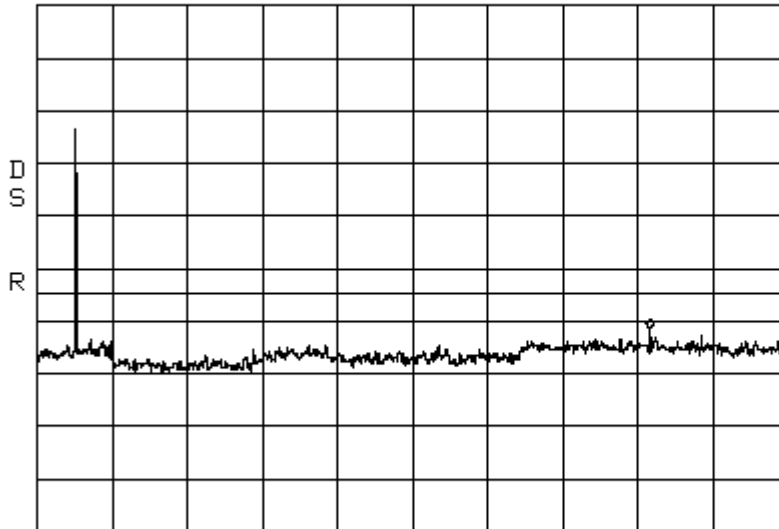

START 1.00GHz

STOP 20.00GHz

\*RBW 1.0MHz

\*VBW 1.0MHz

SWP 380ms





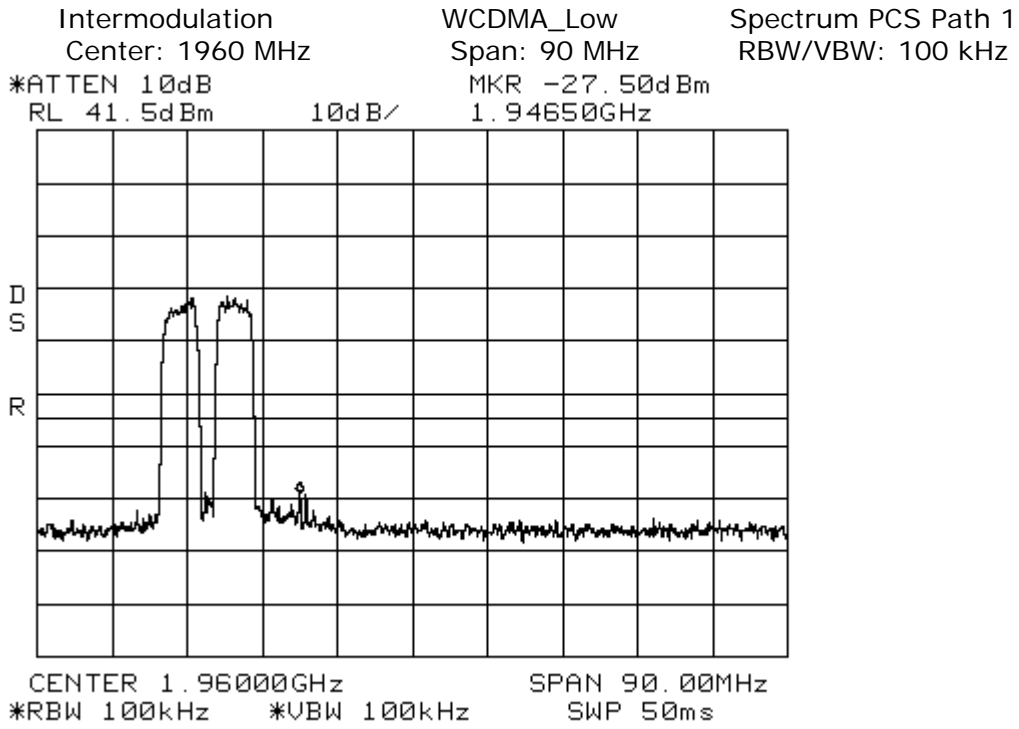
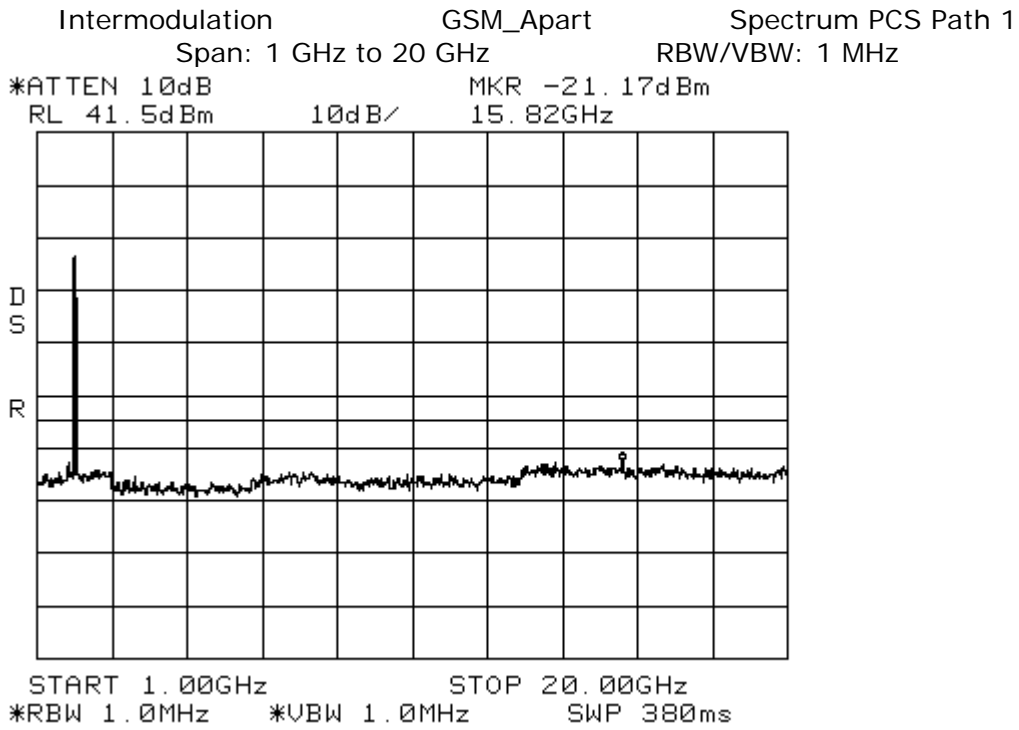





Intermodulation

WCDMA\_High

Spectrum PCS Path 1

Span: 1 GHz to 20 GHz

RBW/VBW: 1 MHz

\*ATTEN 10dB

MKR -21.00dBm

RL 41.5dBm

10dB/

13.48GHz

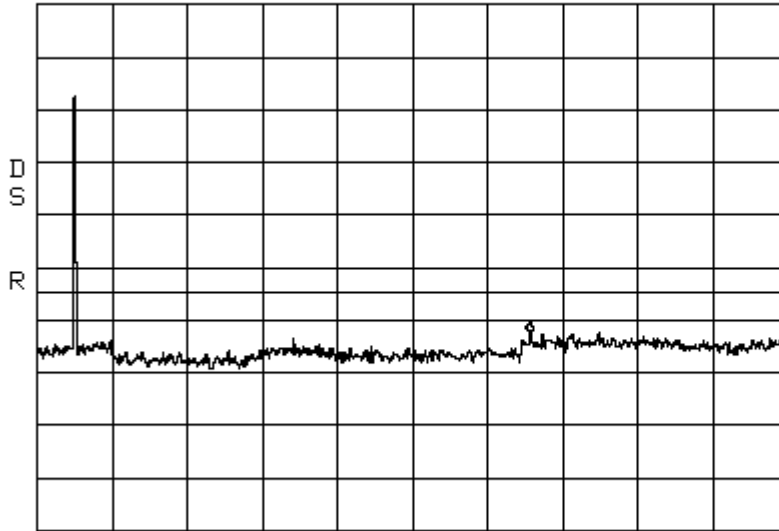

START 1.00GHz

STOP 20.00GHz

\*RBW 1.0MHz

\*VBW 1.0MHz

SWP 380ms

Intermodulation

WCDMA\_Apart

Spectrum PCS Path 1

Center: 1960 MHz

Span: 175 MHz

RBW/VBW: 100 kHz

\*ATTEN 10dB

MKR -32.67dBm

RL 41.5dBm

10dB/

1.8766GHz

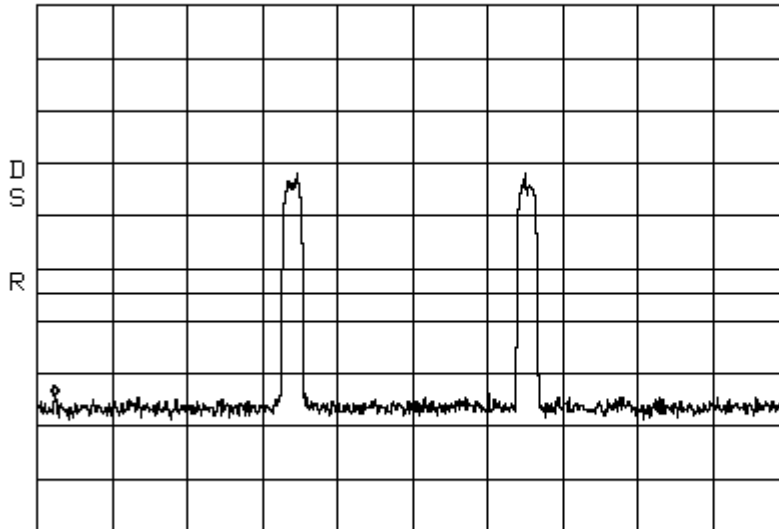

CENTER 1.9600GHz

SPAN 175.0MHz

\*RBW 100kHz

\*VBW 100kHz

SWP 50ms

Intermodulation

WCDMA\_Apart

Spectrum PCS Path 1

Span: 30 MHz to 1 GHz

RBW/VBW: 300 kHz

\*ATTEN 10dB  
RL 41.5dBm

10dB/

MKR -28.33dBm  
144.8MHz

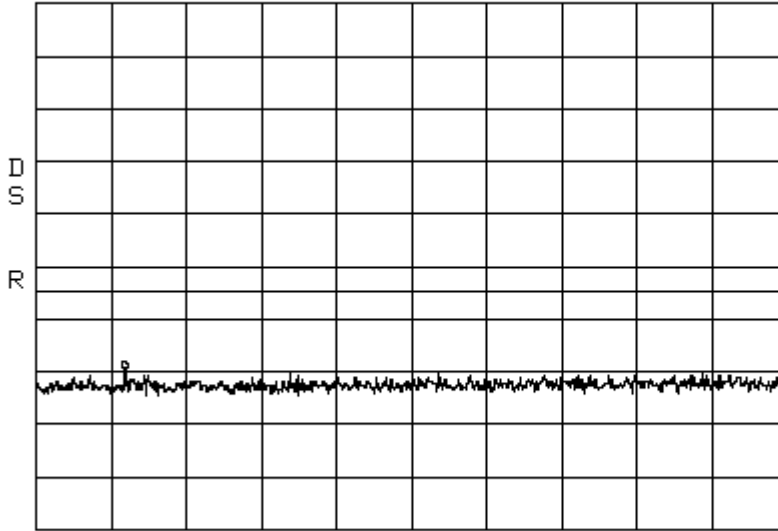

START 30.0MHz STOP 1.0000GHz  
\*RBW 300kHz \*VBW 300kHz SWP 50ms

Intermodulation

WCDMA\_Apart

Spectrum PCS Path 1

Span: 1 GHz to 20 GHz

RBW/VBW: 1 MHz

\*ATTEN 10dB  
RL 41.5dBm

10dB/

MKR -21.17dBm  
14.14GHz

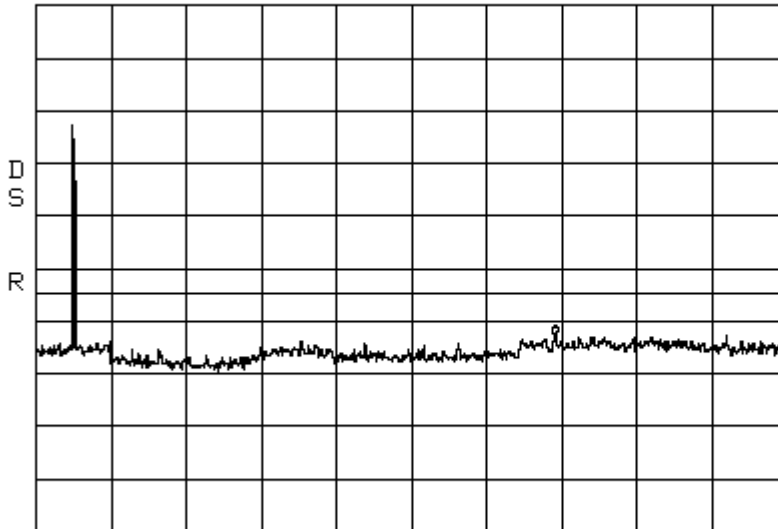

START 1.00GHz STOP 20.00GHz  
\*RBW 1.0MHz \*VBW 1.0MHz SWP 380ms

Intermodulation  
Center: 2132.5 MHz

WCDMA\_Low  
Span: 70 MHz

Spectrum AWS Path 1  
RBW/VBW: 100 kHz

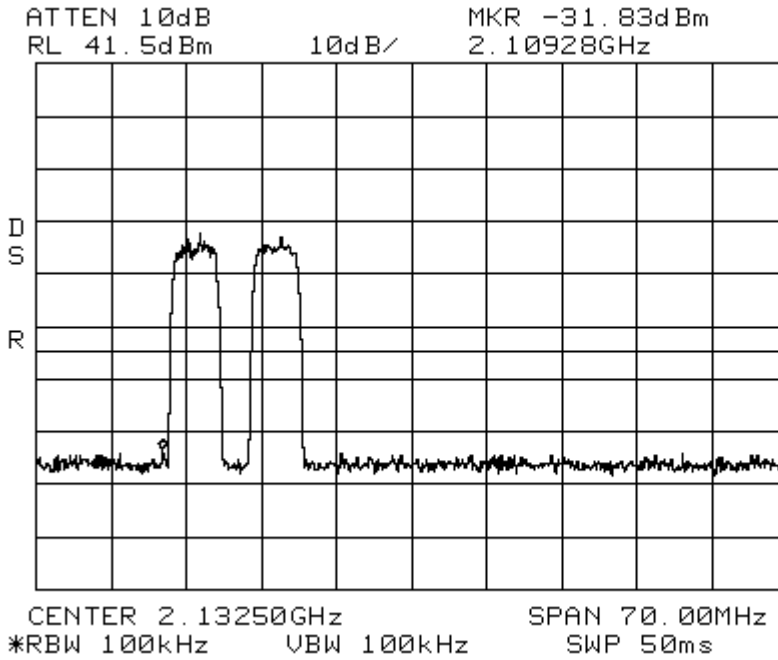

Intermodulation  
Span: 30 MHz to 1 GHz

WCDMA\_Low

Spectrum AWS Path 1  
RBW/VBW: 300 kHz

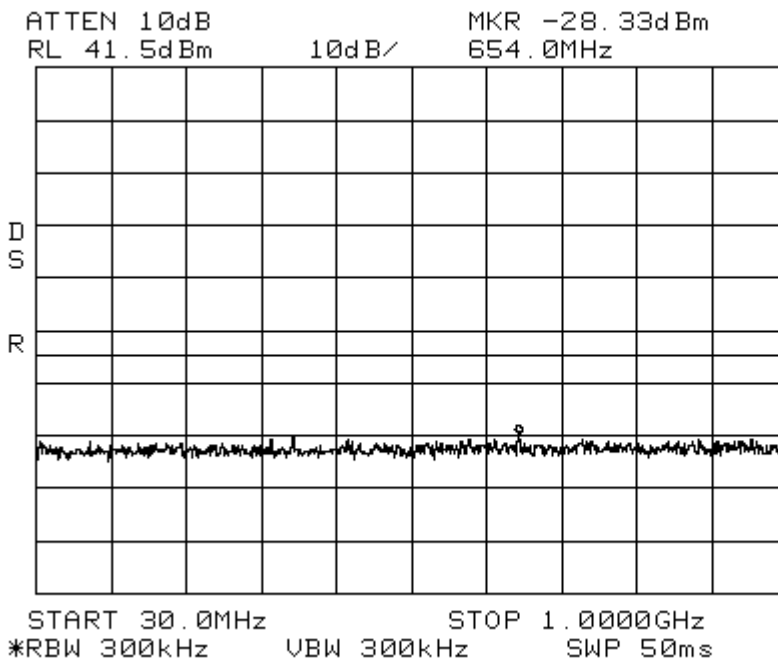

Intermodulation WCDMA\_Low Spectrum AWS Path 1  
Span: 1 GHz to 10 GHz RBW/VBW: 1 MHz

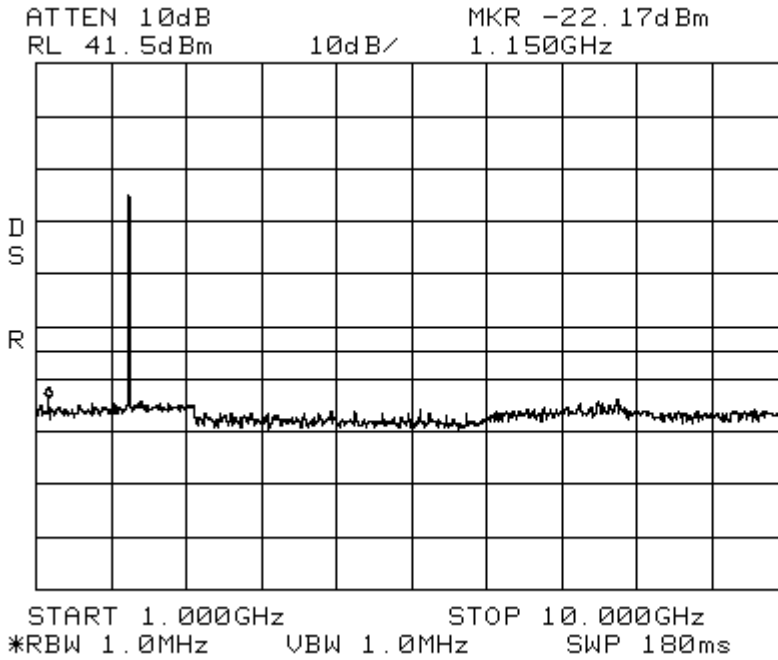

Intermodulation WCDMA\_Low Spectrum AWS Path 1  
Span: 10 GHz to 22 GHz RBW/VBW: 1 MHz

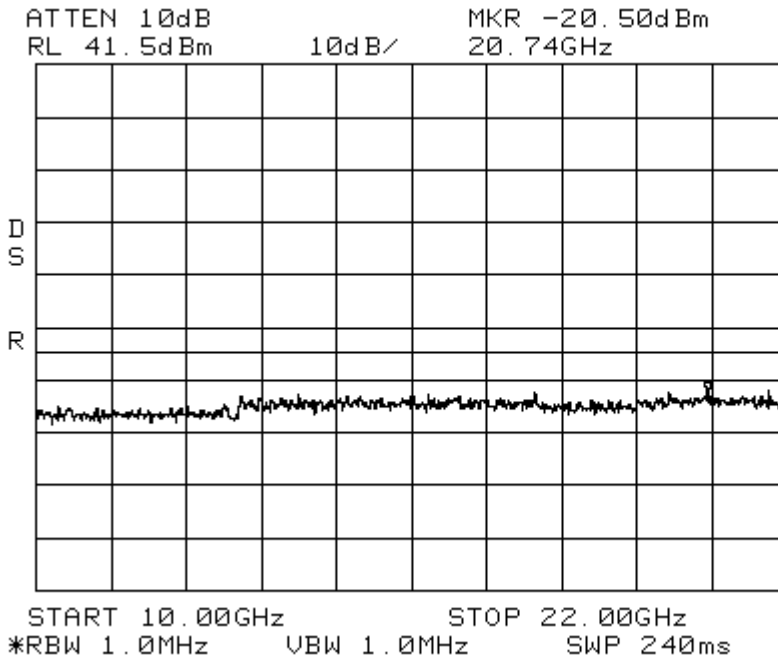





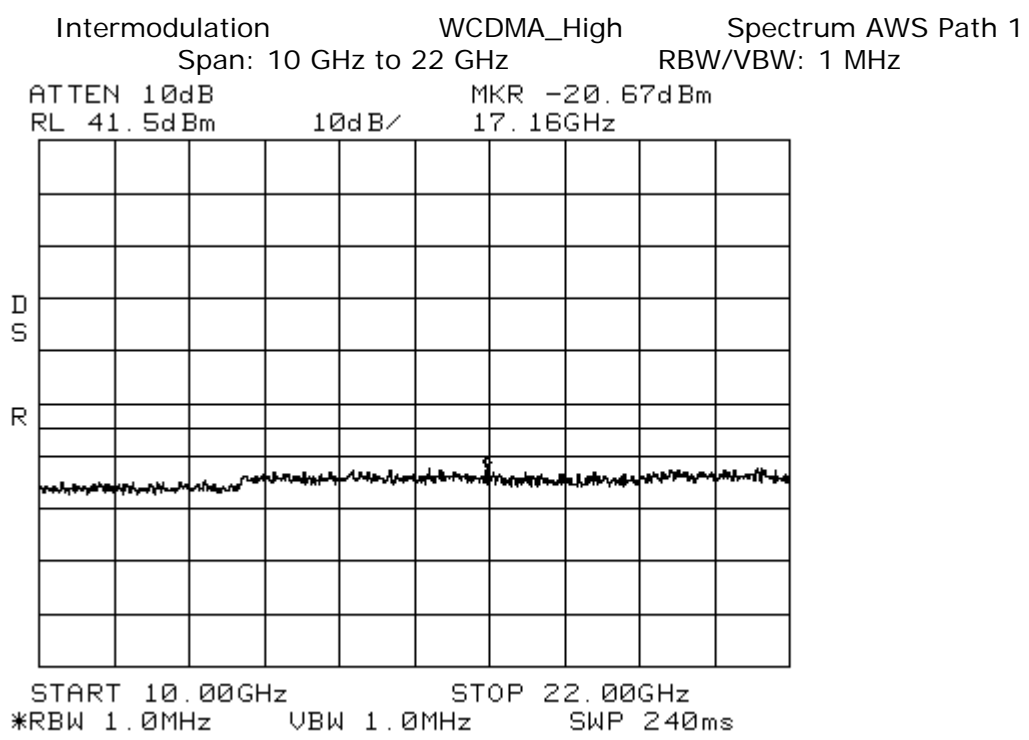
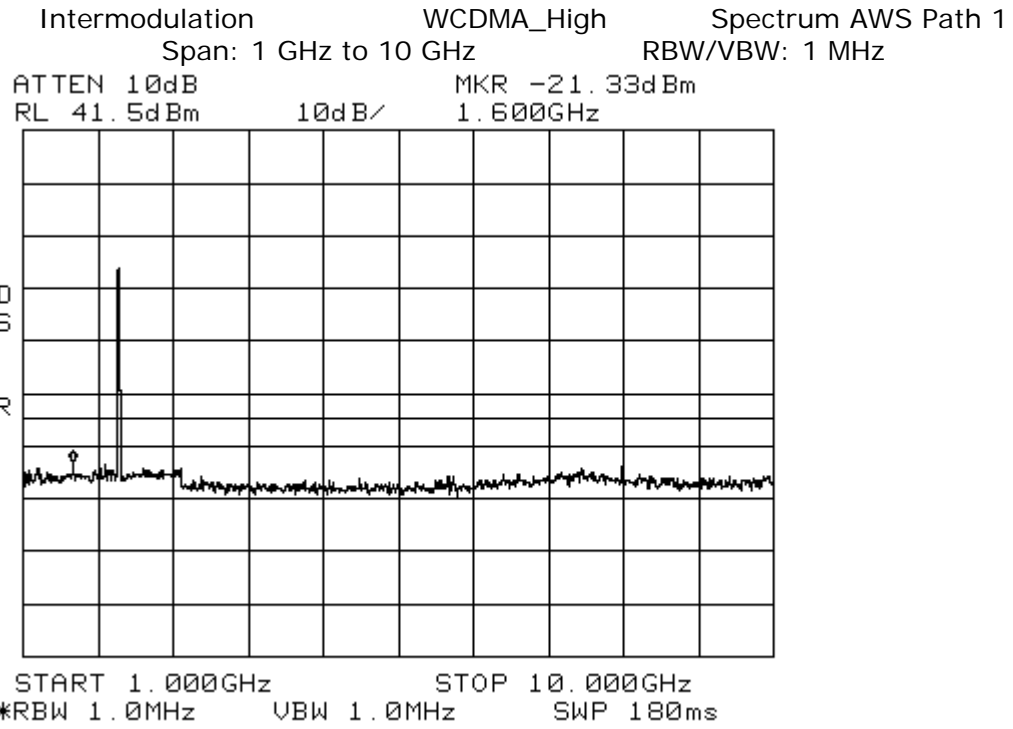

Intermodulation  
Center: 2132.5 MHz  
ATTEN 10dB  
RL 41.5dBm

WCDMA\_Apart  
Span: 175 MHz  
10dB/  
2.1039GHz

Spectrum AWS Path 1  
RBW/VBW: 100 kHz

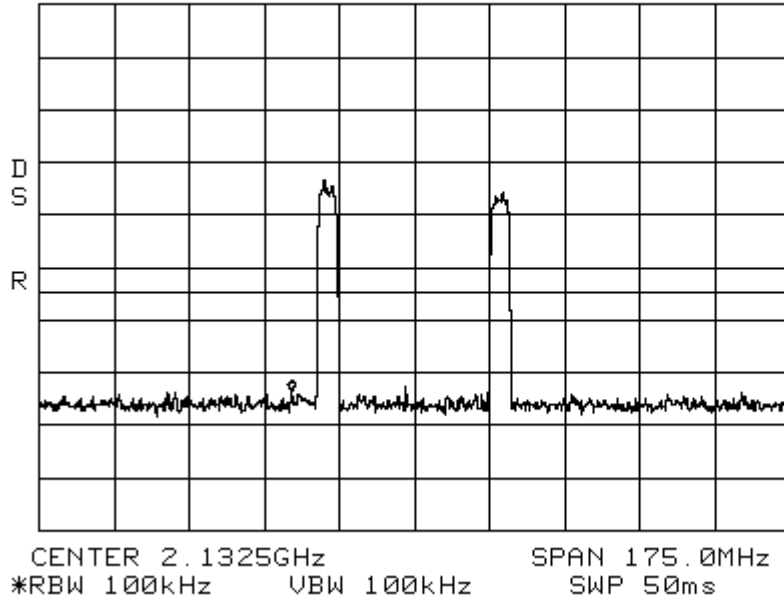

Intermodulation WCDMA\_Apart  
Span: 30 MHz to 1 GHz

Spectrum AWS Path 1  
RBW/VBW: 300 kHz

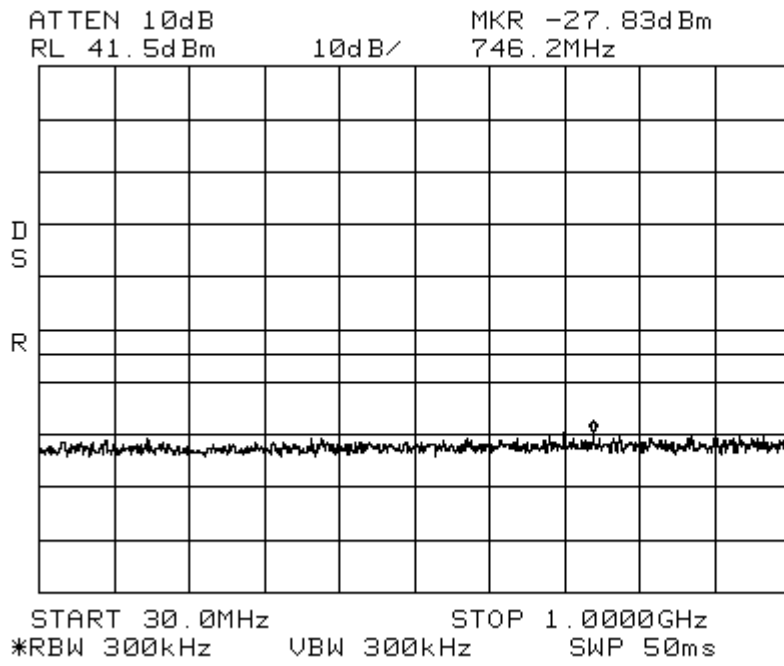

Intermodulation WCDMA\_Apart Spectrum AWS Path 1

Span: 1 GHz to 10 GHz RBW/VBW: 1 MHz

ATTEN 10dB MKR -21.17dBm  
RL 41.5dBm 10dB/ 2.605GHz

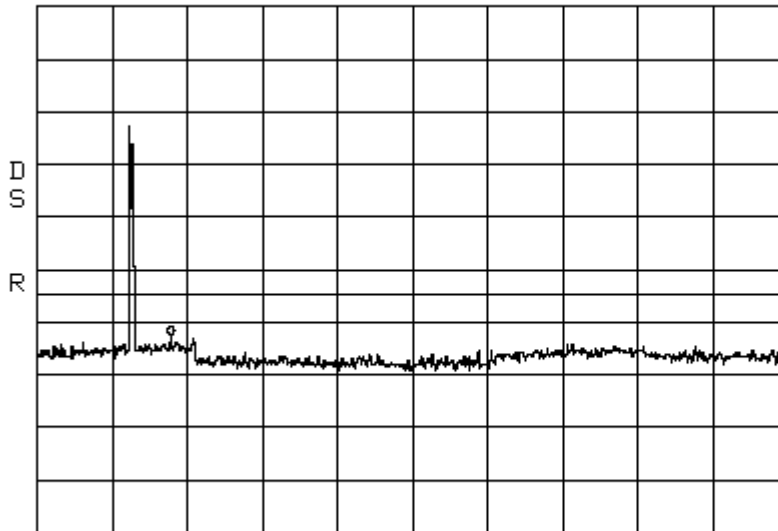

START 1.000GHz STOP 10.000GHz  
\*RBW 1.0MHz VBW 1.0MHz SWP 180ms

Intermodulation WCDMA\_Apart Spectrum AWS Path 1

Span: 10 GHz to 22 GHz RBW/VBW: 1 MHz

ATTEN 10dB MKR -20.00dBm  
RL 41.5dBm 10dB/ 20.40GHz

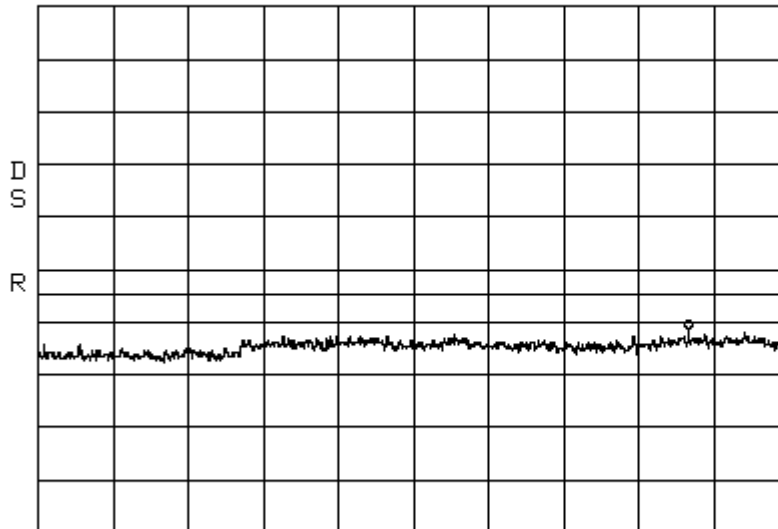

START 10.00GHz STOP 22.00GHz  
\*RBW 1.0MHz VBW 1.0MHz SWP 240ms

## 7.5 Occupied Bandwidth Modulation Test

[Table of Contents: Section 1.0](#)

[Back to Emission Limits: Section 5.1.3](#)

An input/output Occupied Bandwidth test was done with modulation types: CDMA, GSM, EDGE, & WCDMA. The purpose was to determine the amount of distortion added to different types of modulation schemes by the EUT. The following plots show input signals vs. output signals.

The resolution bandwidth is reduced to 1% of the estimated emission bandwidth and the video bandwidth is set to 3 times the resolution bandwidth. The markers are moved to the -20 dB points (from the previously established center frequency level) on either side of center frequency.

### **Results:**

Pass (see plots)

Occupied Bandwidth      CDMA\_Signal\_In      Spectrum PCS Path 1  
Span: 1.5 MHz      RBW: 30 kHz VBW: 100 kHz  
\*ATTEN 10dB      ΔMKR .33dB  
RL 41.5dBm      10dB/      1.393MHz

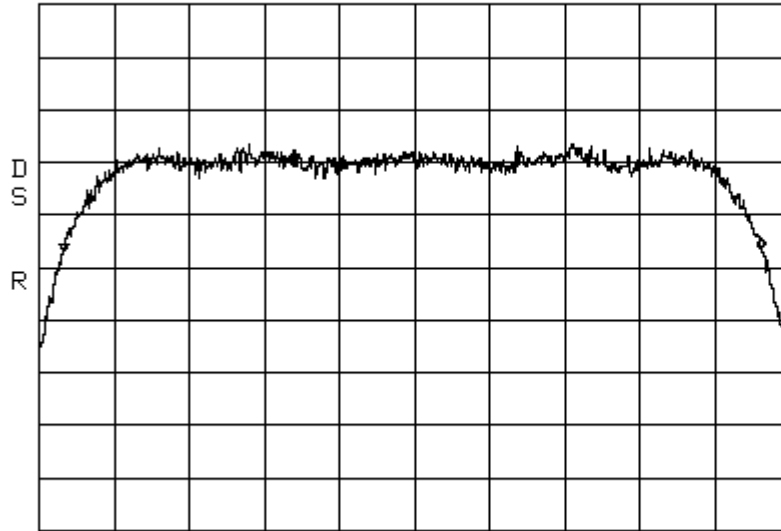

CENTER 1.960000GHz      SPAN 1.500MHz  
\*RBW 30kHz      \*VBW 100kHz      \*SWP 52ms

Occupied Bandwidth      CDMA\_Signal\_Out      Spectrum PCS Path 1  
Span: 1.5 MHz      RBW: 30 kHz VBW: 100 kHz

\*ATTEN 10dB      ΔMKR -.84dB  
RL 41.5dBm      10dB/      1.395MHz

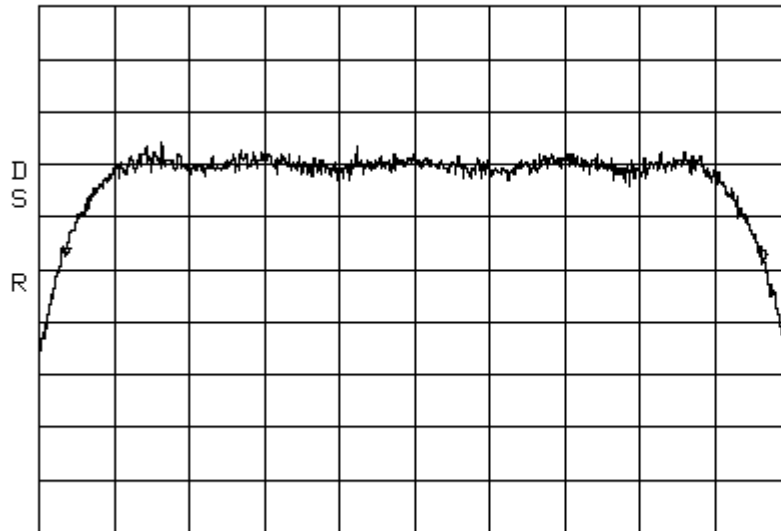

CENTER 1.960000GHz      SPAN 1.500MHz  
\*RBW 30kHz      \*VBW 100kHz      SWP 50ms

Occupied Bandwidth  
Span: 350 kHz

EDGE\_Signal\_In  
RBW: 3 kHz

Spectrum PCS Path 1  
VBW: 10 kHz

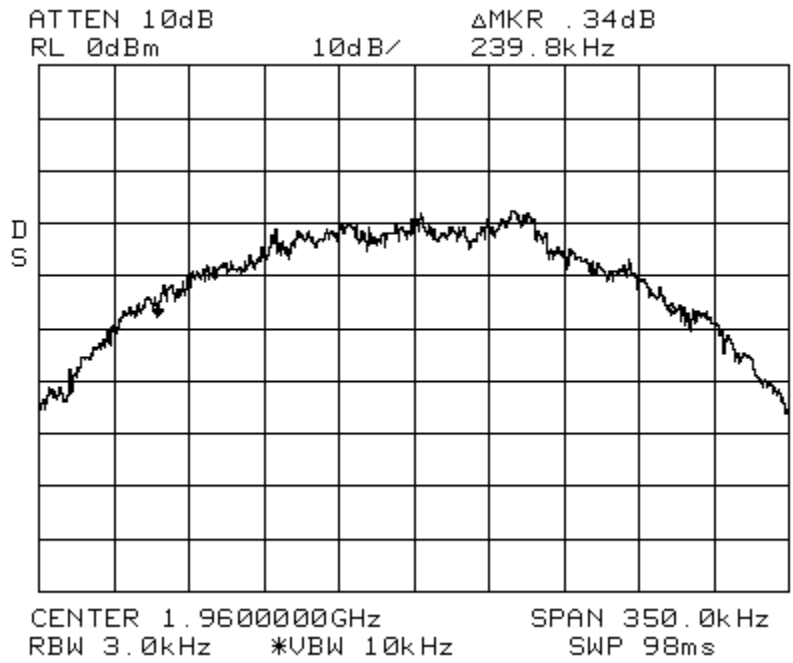

Occupied Bandwidth  
Span: 350 kHz

EDGE\_Signal\_Out  
RBW: 3 kHz

Spectrum PCS Path 1  
VBW: 10 kHz

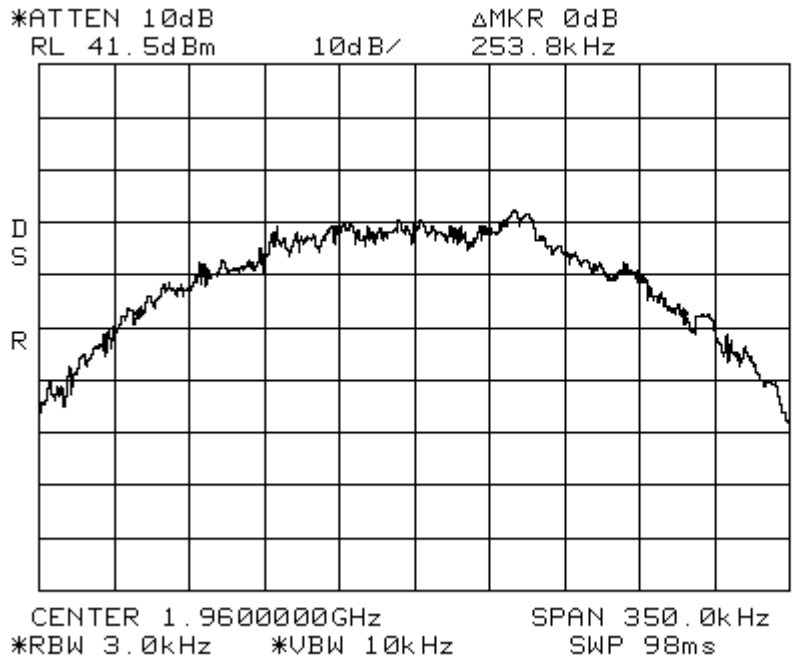

Occupied Bandwidth GSM\_Signal\_In Spectrum PCS Path 1  
Span: 350 kHz RBW: 3 kHz VBW: 10 kHz  
ATTEN 10dB ΔMKR 0dB  
RL 0dBm 10dB/ 266.0kHz

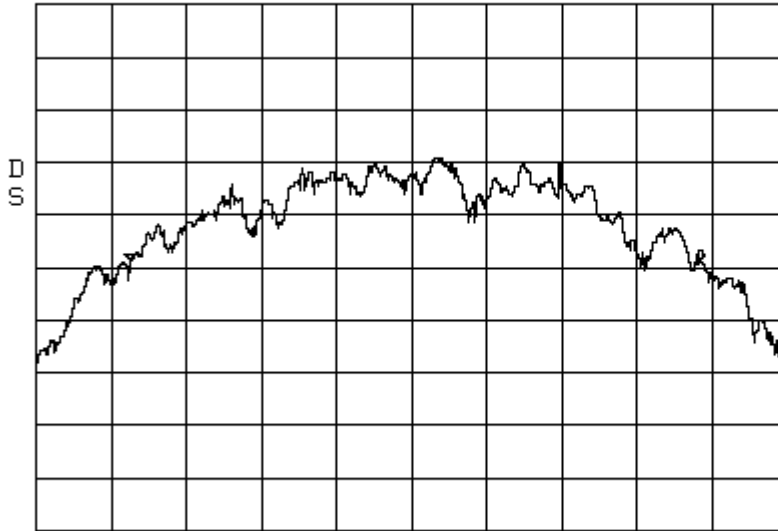

CENTER 1.9600000GHz SPAN 350.0kHz  
RBW 3.0kHz \*VBW 10kHz SWP 98ms

Occupied Bandwidth GSM\_Signal\_Out Spectrum PCS Path 1  
Span: 350 kHz RBW: 3 kHz VBW: 10 kHz

\*ATTEN 10dB ΔMKR 0dB  
RL 41.5dBm 10dB/ 260.8kHz

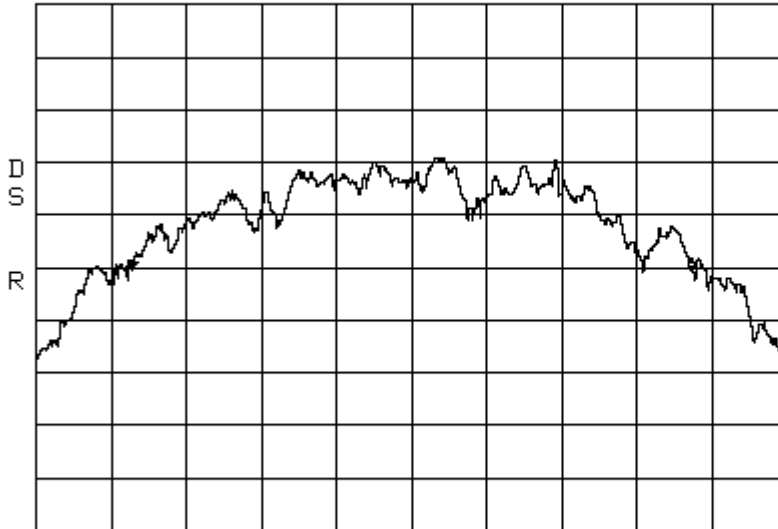

CENTER 1.9600000GHz SPAN 350.0kHz  
\*RBW 3.0kHz \*VBW 10kHz SWP 98ms





Occupied Bandwidth WCDMA\_Signal\_In Spectrum AWS Path 1

Span: 4.8 MHz RBW: 30 kHz VBW: 100 kHz

ATTEN 10dB  $\Delta$ MKR 0dB  
RL 41.5dBm 10dB/ 4.583MHz

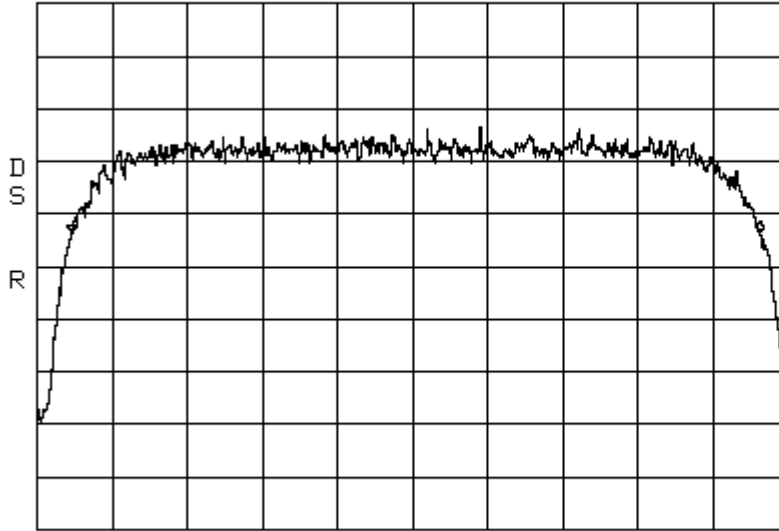

CENTER 2.132500GHz SPAN 5.000MHz  
\*RBW 30kHz \*VBW 100kHz SWP 50ms

Occupied Bandwidth WCDMA\_Signal\_Out Spectrum AWS Path 1

Span: 4.8 MHz RBW: 30 kHz VBW: 100 kHz

ATTEN 10dB  $\Delta$ MKR 0dB  
RL 41.5dBm 10dB/ 4.633MHz

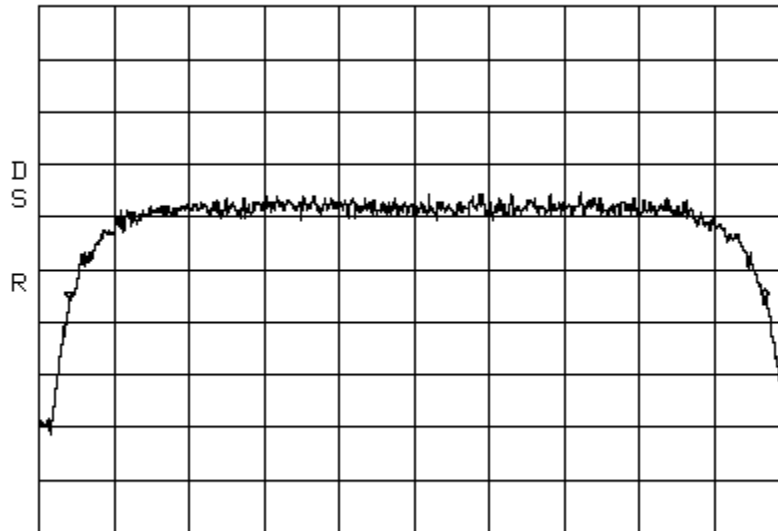

CENTER 2.132500GHz SPAN 5.000MHz  
\*RBW 30kHz \*VBW 100kHz SWP 50ms

8.0

## APPENDIX B

Measurement Protocol

[Table of Contents; Section 1.0](#)

[Back to Emission Limits; Section 5.1.3](#)

# Measurement Protocol

## Environmental conditions of the lab, (ADC)

Temperature: 24° C

Relative Humidity: 21 %

Atmospheric Pressure: 98.8 kPa

## **Test Methodology:**

Emission testing is performed according to the procedures in ANSI C63.4-2003.

## **Measurement Uncertainty**

The test system for conducted emissions is defined as the signal generator(s), the power meter, the spectrum analyzer and the coaxial cable. The equipment comprising the test systems is calibrated prior to testing the EUT.

## **Justification**

The Equipment Under Test (EUT) is configured in a typical user arrangement in accordance with the manufacturer's instructions. A cable is connected to each available port and either terminated with a peripheral into its characteristic impedance or left un-terminated. When appropriate, the cables are manually manipulated with respect to each other to obtain maximum emissions from the unit.

## **Radiated Emissions**

The final level, in dBuV/m, equals the reading from the spectrum analyzer (Level dBuV), adding the antenna correction factor and cable loss factor (Factor dB) to it, and subtracting the preamp gain (and duty cycle correction factor, if applicable). This result then has the limit subtracted from it to provide the Delta, which gives the tabular data as shown in the data sheets in Appendix B.

Example:

FREQ (MHz)	LEVEL (dBuV)	CABLE/ANT/PREAMP (dB) (dB/m) (dB)	FINAL (dBuV/m)	POL/HGT/AZ (m) (deg)	DELTA1
60.80	42.5Qp +	1.2 + 10.9 - 25.5 =	29.1	V 1.0 0.0	-10.9

## **Substitution Method**

A cabinet (or enclosure) radiated emission scan was also made, at Intertek, with the EUT's antenna replaced with a termination to demonstrate case radiation compliance to the -13 dBm requirement. Radiated emissions from the EUT are measured in the frequency range of 30 to 20,000 MHz using a spectrum analyzer and appropriate broadband linearly polarized antennas. Table top equipment is placed on a 1.0 X 1.5 meter non-conducting table 80 centimeters above the ground plane. Floor standing equipment is placed directly on the turntable/ground plane. Interface cables that are closer than 40 centimeters to the ground plane are bundled in the center in a serpentine fashion so they are at least 40 centimeters from the ground plane. Cables to simulators/testers (if used in this test) are routed through the center of the table and to a screen room located outside the test area. The antenna is positioned 3 meters horizontally from the EUT. To locate maximum emissions from the test sample the antenna is varied in height from 1 to 4 meters, measurement scans are made with both horizontal and vertical antenna polarizations and the EUT are rotated 360 degrees. The field strength levels were measured per ANSI C63.4. The EUT is then replaced with a tuned dipole antenna (below 1GHz) or horn antenna (above 1 GHz). The substitute antenna was placed in the same polarization as the test antenna. A signal generator was used to generate a signal level that matched the highest level measured from the EUT. The signal generator level minus the cable loss from the signal generator to the substitute antenna plus the substitute antenna gain equals the spurious power level.

## **Test Equipment**

All measurement instrumentation is traceable to the National Institute of Standards and Technology and is calibrated according to internal procedure.

## 9.0

## APPENDIX C

### Radiated Emissions Test Data

[Table of Contents: Section 1.0](#)

Document Name: 100454919MIN-001

**Test Engineer:** Richard Blonigen

**Date:** July 20, 2011

**Test Procedure:**

Test measurements were made in accordance with ANSI C63.4-2003, Standard Methods of Measurement of Radio Noise Emissions from Low-Voltage Electrical and Electronics Equipment in the Range of 9 kHz to 40 GHz.

**Test Site Location:**

The test site is a 3 meter Semi-Anechoic Chamber, constructed by Panashield™ Inc. and located inside the building at 7250 Hudson Blvd. Suite 100, Oakdale, MN 55128.

**Test Site Description:**

The 3 meter Semi-Anechoic Chamber is constructed of Panabolt™ modular RF shielding and self-supported with structural steel designed for the local seismic zone rating. The chamber has the nominal size of 20' wide x 29' long x 18' high. All walls and ceiling of the chamber are treated with FFG-1000 Ferrite Grid absorber which was developed specifically to meet international requirements for EMC anechoic chambers for emissions and immunity measurements. To meet high frequency testing white HY-35 hybrid absorber is mounted on the ferrites in specular regions of the chamber.

The chamber has a 2 meter diameter ANSI test volume area and meets the requirements of ANSI C63.4 (1992), EN55022, and FCC Part 15 standards for testing at a 3 meter path length.

FCC Registration Number: 0007355381

IC Registration Number: 4359A