

## FCC Test Report (2.4GHz WLAN)

**Report No.:** RFBEMI-WTW-P21080520

**FCC ID:** NOIKBN778K

**Test Model:** N778K

**Received Date:** 2021/8/11

**Test Date:** 2021/10/5 ~ 2021/10/30

**Issued Date:** 2021/11/18

**Applicant:** NETRONIX, INC.

**Address:** No 945, Boai St, Jubei City, Hsinchu, 30265 Taiwan

**Issued By:** Bureau Veritas Consumer Products Services (H.K.) Ltd., Taoyuan Branch  
Lin Kou Laboratories

**Lab Address:** No. 47-2, 14th Ling, Chia Pau Vil., Lin Kou Dist., New Taipei City, Taiwan

**FCC Registration /  
Designation Number:** 198487 / TW2021



This report is for your exclusive use. Any copying or replication of this report to or for any other person or entity, or use of our name or trademark, is permitted only with our prior written permission. This report sets forth our findings solely with respect to the test samples identified herein. The results set forth in this report are not indicative or representative of the quality or characteristics of the lot from which a test sample was taken or any similar or identical product unless specifically and expressly noted. Our report includes all of the tests requested by you and the results thereof based upon the information that you provided to us. You have 60 days from date of issuance of this report to notify us of any material error or omission caused by our negligence, provided, however, that such notice shall be in writing and shall specifically address the issue you wish to raise. A failure to raise such issue within the prescribed time shall constitute your unqualified acceptance of the completeness of this report, the tests conducted and the correctness of the report contents. Unless specific mention, the uncertainty of measurement has been explicitly taken into account to declare the compliance or non-compliance to the specification.

## Table of Contents

<b>Release Control Record</b> .....	<b>4</b>
<b>1 Certificate of Conformity</b> .....	<b>5</b>
<b>2 Summary of Test Results</b> .....	<b>6</b>
2.1 Measurement Uncertainty.....	6
2.2 Modification Record.....	6
<b>3 General Information</b> .....	<b>7</b>
3.1 General Description of EUT.....	7
3.2 Description of Test Modes.....	8
3.2.1 Test Mode Applicability and Tested Channel Detail.....	9
3.3 Duty Cycle of Test Signal.....	11
3.4 Description of Support Units.....	12
3.4.1 Configuration of System under Test.....	12
3.5 General Description of Applied Standards and References.....	13
<b>4 Test Types and Results</b> .....	<b>14</b>
4.1 Radiated Emission and Bandedge Measurement.....	14
4.1.1 Limits of Radiated Emission and Bandedge Measurement.....	14
4.1.2 Test Instruments.....	15
4.1.3 Test Procedures.....	16
4.1.4 Deviation from Test Standard.....	16
4.1.5 Test Setup.....	17
4.1.6 EUT Operating Conditions.....	18
4.1.7 Test Results.....	19
4.2 Conducted Emission Measurement.....	30
4.2.1 Limits of Conducted Emission Measurement.....	30
4.2.2 Test Instruments.....	30
4.2.3 Test Procedures.....	31
4.2.4 Deviation from Test Standard.....	31
4.2.5 Test Setup.....	31
4.2.6 EUT Operating Conditions.....	31
4.2.7 Test Results.....	32
4.3 6dB Bandwidth Measurement.....	36
4.3.1 Limits of 6dB Bandwidth Measurement.....	36
4.3.2 Test Setup.....	36
4.3.3 Test Instruments.....	36
4.3.4 Test Procedure.....	36
4.3.5 Deviation from Test Standard.....	36
4.3.6 EUT Operating Conditions.....	36
4.3.7 Test Result.....	37
4.4 Conducted Output Power Measurement.....	39
4.4.1 Limits of Conducted Output Power Measurement.....	39
4.4.2 Test Setup.....	39
4.4.3 Test Instruments.....	39
4.4.4 Test Procedures.....	39
4.4.5 Deviation from Test Standard.....	39
4.4.6 EUT Operating Conditions.....	39
4.4.7 Test Results.....	40
4.5 Power Spectral Density Measurement.....	42
4.5.1 Limits of Power Spectral Density Measurement.....	42
4.5.2 Test Setup.....	42
4.5.3 Test Instruments.....	42
4.5.4 Test Procedure.....	42
4.5.5 Deviation from Test Standard.....	42

4.5.6 EUT Operating Condition .....	42
4.5.7 Test Results .....	43
4.6 Conducted Out of Band Emission Measurement .....	45
4.6.1 Limits of Conducted Out of Band Emission Measurement.....	45
4.6.2 Test Setup.....	45
4.6.3 Test Instruments .....	45
4.6.4 Test Procedure .....	45
4.6.5 Deviation from Test Standard .....	45
4.6.6 EUT Operating Condition .....	45
4.6.7 Test Results .....	45
<b>5 Pictures of Test Arrangements.....</b>	<b>49</b>
<b>Annex A- Band Edge Measurement .....</b>	<b>50</b>
<b>Appendix – Information of the Testing Laboratories .....</b>	<b>53</b>



### Release Control Record

Issue No.	Description	Date Issued
RFBEMI-WTW-P21080520	Original release.	2021/11/18

## 1 Certificate of Conformity

**Product:** Electronic Display Device

**Brand:** Rakuten kobo

**Test Model:** N778K

**Sample Status:** Engineering sample

**Applicant:** NETRONIX, INC.

**Test Date:** 2021/10/5 ~ 2021/10/30

**Standards:** 47 CFR FCC Part 15, Subpart C (Section 15.247)  
ANSI C63.10: 2013

The above equipment has been tested by **Bureau Veritas Consumer Products Services (H.K.) Ltd., Taoyuan Branch**, and found compliance with the requirement of the above standards. The test record, data evaluation & Equipment Under Test (EUT) configurations represented herein are true and accurate accounts of the measurements of the sample's RF characteristics under the conditions specified in this report.

**Prepared by :**



**Date:**

2021/11/18

Jessica Cheng / Senior Specialist

**Approved by :**



**Date:**

2021/11/18

Jeremy Lin / Project Engineer

## 2 Summary of Test Results

47 CFR FCC Part 15, Subpart C (Section 15.247)			
FCC Clause	Test Item	Result	Remarks
15.207	AC Power Conducted Emission	Pass	Meet the requirement of limit. Minimum passing margin is -19.80dB at 0.79200MHz.
15.205 / 15.209 / 15.247(d)	Radiated Emissions and Band Edge Measurement	Pass	Meet the requirement of limit. Minimum passing margin is -0.79dB at 2483.50MHz.
15.247(d)	Antenna Port Emission	Pass	Meet the requirement of limit.
15.247(a)(2)	6dB bandwidth	Pass	Meet the requirement of limit.
15.247(b)	Conducted power	Pass	Meet the requirement of limit.
15.247(e)	Power Spectral Density	Pass	Meet the requirement of limit.
15.203	Antenna Requirement	Pass	No antenna connector is used.

Note:

- Determining compliance based on the results of the compliance measurement, not taking into account measurement instrumentation uncertainty.
- For 2.4GHz band compliance with rule 15.247(d) of the band-edge items, the test plots were recorded in Annex A. Test Procedures refer to report 4.1.3.

### 2.1 Measurement Uncertainty

Where relevant, the following measurement uncertainty levels have been estimated for tests performed on the EUT as specified in CISPR 16-4-2:

Measurement	Frequency	Expanded Uncertainty (k=2) ( $\pm$ )
Conducted Emissions at mains ports	150kHz ~ 30MHz	3.00 dB
Conducted Emissions	9kHz ~ 40GHz	2.63 dB
Radiated Emissions up to 1 GHz	9kHz ~ 30MHz	2.38 dB
	30MHz ~ 1GHz	5.70 dB
Radiated Emissions above 1 GHz	Above 1GHz	5.21 dB

### 2.2 Modification Record

There were no modifications required for compliance.

### 3 General Information

#### 3.1 General Description of EUT

Product	Electronic Display Device
Brand	Rakuten kobo
Test Model	N778K
Status of EUT	Engineering sample
Power Supply Rating	3.7Vdc from Battery or 5Vdc from USB interface
Modulation Type	CCK, DQPSK, DBPSK for DSSS 64QAM, 16QAM, QPSK, BPSK for OFDM
Modulation Technology	DSSS, OFDM
Transfer Rate	802.11b: 11/5.5/2/1Mbps 802.11g: 54/48/36/24/18/12/9/6Mbps 802.11n: up to 72.2Mbps
Operating Frequency	2412MHz ~ 2462MHz
Number of Channel	802.11b, 802.11g, 802.11n (HT20): 11
Output Power	158.855mW
Antenna Type	Refer to note as below
Antenna Connector	Refer to note as below
Accessory Device	N/A
Data Cable Supplied	Shielded USB cable (1.0m)

Note:

1. There are WLAN and Bluetooth technologies used for the EUT.
2. Simultaneously transmission condition.

Condition	Technology	
1	WLAN (2.4GHz)	Bluetooth
2	WLAN (5GHz)	Bluetooth

Note: The emission of the simultaneous operation has been evaluated and no non-compliances was found

3. Two eMMCs provided to the EUT, please refer to the following table:

No.	Model	Remark
1	EMMC32G-TX29-GA8A	1st source eMMC
2	MKEMF032GZ1E-C	2nd source eMMC

Note: From the above eMMCs the worst case was found in **No. 1**. Therefore only the test data of the mode was recorded in this report.

4. The following antennas were provided to the EUT.

Brand	Model	Gain (dBi)	Frequency range	Antenna Type	Antenna Connector
INPAQ	ACM3-3216-P1-CC-S	0.6	2.4~2.4835GHz	Chip	None
INPAQ	ACM3-3216-P1-CC-S	2	5.15~5.85GHz	Chip	None

5. The above Antenna information is declared by manufacturer and for more detailed features description, please refer to the manufacturer's specifications, the laboratory shall not be held responsible.

6. The EUT was pre-tested under the following modes:

Pre-test Mode	Test Condition
A	Battery mode,
B	USB Adapter mode
C	Notebook mode
D	<b>USB Adapter mode with Leather Sheath</b>

Note: From the above mode, the worst case was found in **Mode D**. Therefore only the test data of the mode was recorded in this report.

7. The EUT incorporates a SISO function.

2.4GHz Band		
Modulation Mode	TX & RX Configuration	
802.11b	1TX	1RX
802.11g	1TX	1RX
802.11n (HT20)	1TX	1RX

8. The above EUT information is declared by manufacturer and for more detailed features description, please refer to the manufacturer's specifications or user's manual.

### 3.2 Description of Test Modes

11 channels are provided for 802.11b, 802.11g and 802.11n (HT20):

Channel	Frequency	Channel	Frequency
1	2412MHz	7	2442MHz
2	2417MHz	8	2447MHz
3	2422MHz	9	2452MHz
4	2427MHz	10	2457MHz
5	2432MHz	11	2462MHz
6	2437MHz		



### 3.2.1 Test Mode Applicability and Tested Channel Detail

EUT Configure Mode	Applicable To				Description
	RE≥1G	RE<1G	PLC	APCM	
A	√	√	√	√	USB Adapter mode with Leather Sheath
B	-	-	√	-	Notebook mode with Leather Sheath

Where **RE≥1G**: Radiated Emission above 1GHz & Bandedge Measurement **RE<1G**: Radiated Emission below 1GHz  
**PLC**: Power Line Conducted Emission **APCM**: Antenna Port Conducted Measurement

**NOTE**: The EUT had been pre-tested on the positioned of each 3 axis. The worst case was found when positioned on **X-plane**.

#### **Radiated Emission Test (Above 1GHz):**

Pre-Scan has been conducted to determine the worst-case mode from all possible combinations between available modulations, data rates and antenna ports (if EUT with antenna diversity architecture).

Following channel(s) was (were) selected for the final test as listed below.

EUT Configure Mode	Mode	Available Channel	Tested Channel	Modulation Technology	Modulation Type	Data Rate (Mbps)
A	802.11b	1 to 11	1, 6, 11	DSSS	DBPSK	1
A	802.11g	1 to 11	1, 6, 11	OFDM	BPSK	6
A	802.11n (HT20)	1 to 11	1, 6, 11	OFDM	BPSK	6.5

#### **Radiated Emission Test (Below 1GHz):**

Pre-Scan has been conducted to determine the worst-case mode from all possible combinations between available modulations, data rates and antenna ports (if EUT with antenna diversity architecture).

Following channel(s) was (were) selected for the final test as listed below.

EUT Configure Mode	Mode	Available Channel	Tested Channel	Modulation Technology	Modulation Type	Data Rate (Mbps)
A	802.11n (HT20)	1 to 11	6	OFDM	BPSK	6.5

#### **Power Line Conducted Emission Test:**

Pre-Scan has been conducted to determine the worst-case mode from all possible combinations between available modulations, data rates and antenna ports (if EUT with antenna diversity architecture).

Following channel(s) was (were) selected for the final test as listed below.

EUT Configure Mode	Mode	Available Channel	Tested Channel	Modulation Technology	Modulation Type	Data Rate (Mbps)
A & B	802.11n (HT20)	1 to 11	6	OFDM	BPSK	6.5

**Antenna Port Conducted Measurement:**

- This item includes all test value of each mode, but only includes spectrum plot of worst value of each mode.
- Pre-Scan has been conducted to determine the worst-case mode from all possible combinations between available modulations, data rates and antenna ports (if EUT with antenna diversity architecture).
- Following channel(s) was (were) selected for the final test as listed below.

EUT Configure Mode	Mode	Available Channel	Tested Channel	Modulation Technology	Modulation Type	Data Rate (Mbps)
A	802.11b	1 to 11	1, 6, 11	DSSS	DBPSK	1
A	802.11g	1 to 11	1, 6, 11	OFDM	BPSK	6
A	802.11n (HT20)	1 to 11	1, 6, 11	OFDM	BPSK	6.5

**Test Condition:**

Applicable To	EUT Configure Mode	Environmental Conditions	Input Power	Tested By
RE≥1G	A	23deg. C, 53%RH	120Vac, 60Hz (Adapter)	Jed Wu
RE<1G	A	30deg. C, 75%RH	120Vac, 60Hz (Adapter)	Ian Chang
PLC	A	25deg. C, 75%RH	120Vac, 60Hz (Adapter)	Starltaly Wu
	B	25deg. C, 75%RH	120Vac, 60Hz (Notebook)	Starltaly Wu
APCM	A	25deg. C, 76%RH	120Vac, 60Hz (Adapter)	Pirar Hsieh

### 3.3 Duty Cycle of Test Signal

If duty cycle of test signal is  $\geq 98\%$ , duty factor is not required.

If duty cycle of test signal is  $< 98\%$ , duty factor shall be considered.

**802.11b:** Duty cycle = 12.51 ms / 12.72 ms = 0.983

**802.11g:** Duty cycle = 2.085 ms / 2.37 ms = 0.88, Duty factor =  $10 * \log(1/0.88) = 0.56$  dB

**802.11n (HT20):** Duty cycle = 1.935 ms / 2.025 ms = 0.956, Duty factor =  $10 * \log(1/0.956) = 0.20$  dB



### 3.4 Description of Support Units

The EUT has been tested as an independent unit together with other necessary accessories or support units. The following support units or accessories were used to form a representative test configuration during the tests.

ID	Product	Brand	Model No.	Serial No.	FCC ID	Remarks
A.	Notebook PC	Lenove	81LG	PF1NF9V2	N/A	Provided by Lab
B.	Adapter	Apple	A1385	N/A	N/A	Provided by Lab
C.	Leather Sheath	Rakuten kobo	N/A	N/A	N/A	Supplied by applicant

ID	Cable Descriptions	Qty.	Length (m)	Shielding (Yes/No)	Cores (Qty.)	Remarks
1.	USB Type-C cable	1	1	Y	0	Supplied by applicant

#### 3.4.1 Configuration of System under Test

##### Mode A

Powered from Adapter with Leather Sheath

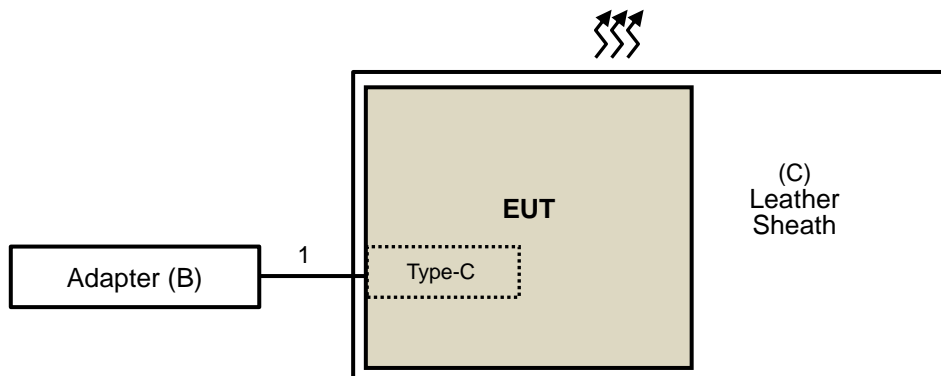

##### Mode B

Powered from Notebook with Leather Sheath

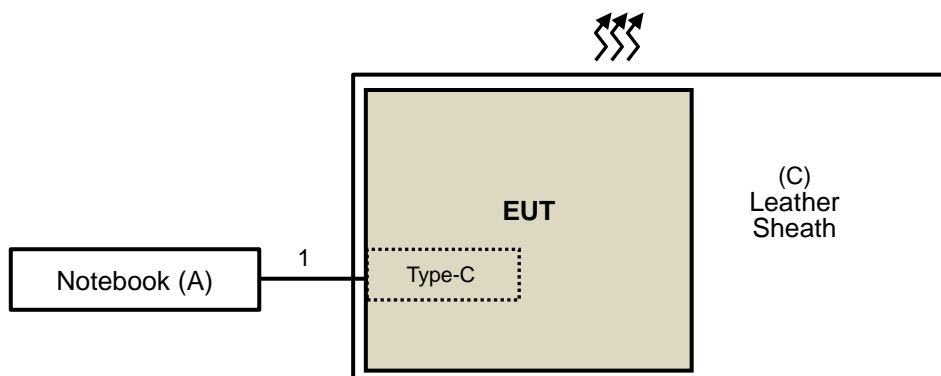

### 3.5 General Description of Applied Standards and References

The EUT is a RF Product. According to the specifications of the manufacturer, it must comply with the requirements of the following standards and references:

**Test standard:**

**FCC Part 15, Subpart C (15.247)**

**ANSI C63.10-2013**

All test items have been performed and recorded as per the above standards.

**References Test Guidance:**

**KDB 558074 D01 15.247 Meas Guidance v05r02**

All test items have been performed as a reference to the above KDB test guidance.

## 4 Test Types and Results

### 4.1 Radiated Emission and Bandedge Measurement

#### 4.1.1 Limits of Radiated Emission and Bandedge Measurement

Radiated emissions which fall in the restricted bands must comply with the radiated emission limits specified as below table. Other emissions shall be at least 20dB below the highest level of the desired power:

Frequencies (MHz)	Field Strength (microvolts/meter)	Measurement Distance (meters)
0.009 ~ 0.490	2400/F(kHz)	300
0.490 ~ 1.705	24000/F(kHz)	30
1.705 ~ 30.0	30	30
30 ~ 88	100	3
88 ~ 216	150	3
216 ~ 960	200	3
Above 960	500	3

**NOTE:**

1. The lower limit shall apply at the transition frequencies.
2. Emission level (dBuV/m) = 20 log Emission level (uV/m).
3. For frequencies above 1000MHz, the field strength limits are based on average detector, however, the peak field strength of any emission shall not exceed the maximum permitted average limits, specified above by more than 20dB under any condition of modulation.

#### 4.1.2 Test Instruments

Description & Manufacturer	Model no.	Serial No.	Calibrated Date	Calibrated Until
Test Receiver Agilent	N9038A	MY51210129	2021/3/12	2022/3/11
Software BVADT	ADT_Radiated_V8.7.08	NA	NA	NA
Software BVADT	ADT_RF Test Software V6.6.5.4	NA	NA	NA
Auto Control System(Antenna Tower, Table, Controller) ADT	SC100+AT100+TT100	0306	NA	NA
Pre_Amplifier EMCI	EMC001340	980269	2021/6/29	2022/6/28
LOOP ANTENNA EMCI	LPA600	270	2021/9/2	2023/9/1
RF Coaxial Cable Pacific	8D-FB	Cable-CH6-02	2021/7/13	2022/7/12
Pre_Amplifier HP	8447D	2432A03504	2021/2/18	2022/2/17
Bi-log Broadband Antenna Schwarzbeck	VULB9168	139	2020/11/6	2021/11/5
Attenuator Mini-Circuits	UNAT-5+	PAD-CH6-01	2021/7/13	2022/7/12
RF Coaxial Cable Pacific	8D-FB	Cable-CH6-02	2021/7/13	2022/7/12
Antenna(Horn) EMCO	3115	00028257	2020/11/22	2021/11/21
Test Receiver Agilent	N9038A	MY51210129	2021/3/12	2022/3/11
Pre-amplifier HP	8449B	3008A01201	2021/2/19	2022/2/18
RF Coaxial Cable NEAT BAR PROER SUHNER	SF-102	Cable-CH6-01	2021/7/8	2022/7/7
Highpass filter Wainwright Instruments	WHK 3.1/18G-10SS	SN 8	2021/5/28	2022/5/27
Fix tool for Boresight	BAF-01	5	NA	NA
Pre_Amplifier MITEQ	AMF-6F-260400-33-8P	892164	2021/2/19	2022/2/18
Antenna(Horn) Schwarzbeck	BBHA-9170	BBHA9170190	2020/11/22	2021/11/21
Spectrum Analyzer R&S	FSV40	101544	2021/5/24	2022/5/23
RF Coaxial Cable WOKEN	WC01	Cable-CH10-03	2021/7/8	2022/7/7
RF Coaxial Cable Rosnol	K1K50-UP0279-K1K50-3000	Cable-CH10(3m)-04	2021/7/8	2022/7/7
Highpass filter SUHNER	11SH10-7000/T18000-O/OP	SN 4	2021/5/28	2022/5/27

- NOTE:**
1. The calibration interval of the above test instruments is 12/24 months. And the calibrations are traceable to NML/ROC and NIST/USA.
  2. The horn antenna and HP preamplifier (model: 8449B) are used only for the measurement of emission frequency above 1GHz if tested.
  3. The test was performed in LK - 966 chamber 1.
  4. Tested Date: 2021/10/5 ~ 2021/10/7

#### 4.1.3 Test Procedures

##### **For Radiated emission below 30MHz**

- a. The EUT was placed on the top of a rotating table 0.8 meters above the ground at a 3 meter chamber room. The table was rotated 360 degrees to determine the position of the highest radiation.
- b. The EUT was set 3 meters away from the interference-receiving antenna, which was mounted on the top of a variable-height antenna tower.
- c. Parallel, perpendicular, and ground-parallel orientations of the antenna are set to make the measurement.
- d. For each suspected emission, the EUT was arranged to its worst case and the rotatable table was turned from 0 degrees to 360 degrees to find the maximum reading.
- e. The test-receiver system was set to Quasi-Peak Detect Function and Specified Bandwidth with Maximum Hold Mode.

##### **NOTE:**

1. The resolution bandwidth and video bandwidth of test receiver/spectrum analyzer is 9kHz at frequency below 30MHz.

##### **For Radiated emission above 30MHz**

- a. The EUT was placed on the top of a rotating table 0.8 meters (for 30MHz ~ 1GHz) / 1.5 meters (for above 1GHz) above the ground at 3 meter chamber room for test. The table was rotated 360 degrees to determine the position of the highest radiation.
- b. The EUT was set 3 meters away from the interference-receiving antenna, which was mounted on the top of a variable-height antenna tower.
- c. The height of antenna is varied from one meter to four meters above the ground to determine the maximum value of the field strength. Both horizontal and vertical polarizations of the antenna are set to make the measurement.
- d. For each suspected emission, the EUT was arranged to its worst case and then the antenna was tuned to heights from 1 meter to 4 meters and the rotatable table was turned from 0 degrees to 360 degrees to find the maximum reading.
- e. The test-receiver system was set to quasi-peak detect function and specified bandwidth with maximum hold mode when the test frequency is below 1 GHz.
- f. The test-receiver system was set to peak and average detects function and specified bandwidth with maximum hold mode when the test frequency is above 1 GHz. If the peak reading value also meets average limit, measurement with the average detector is unnecessary.

##### **Note:**

1. The resolution bandwidth and video bandwidth of test receiver/spectrum analyzer is 120kHz for Quasi-peak detection (QP) at frequency below 1GHz.
2. The resolution bandwidth of test receiver/spectrum analyzer is 1 MHz and the video bandwidth is 3 MHz for Peak detection (PK) at frequency above 1GHz.
3. The resolution bandwidth of test receiver/spectrum analyzer is 1MHz and the video bandwidth is  $\geq 1/T$  (Duty cycle < 98%) or 10Hz (Duty cycle  $\geq 98\%$ ) for Average detection (AV) at frequency above 1GHz.  
(802.11b: RBW = 1MHz, VBW = 10Hz; 802.11g: RBW = 1MHz, VBW = 510Hz;  
802.11n (HT20): RBW = 1MHz, VBW = 560Hz)
4. All modes of operation were investigated and the worst-case emissions are reported.

#### 4.1.4 Deviation from Test Standard

No deviation.



#### 4.1.5 Test Setup

##### For Radiated emission below 30MHz

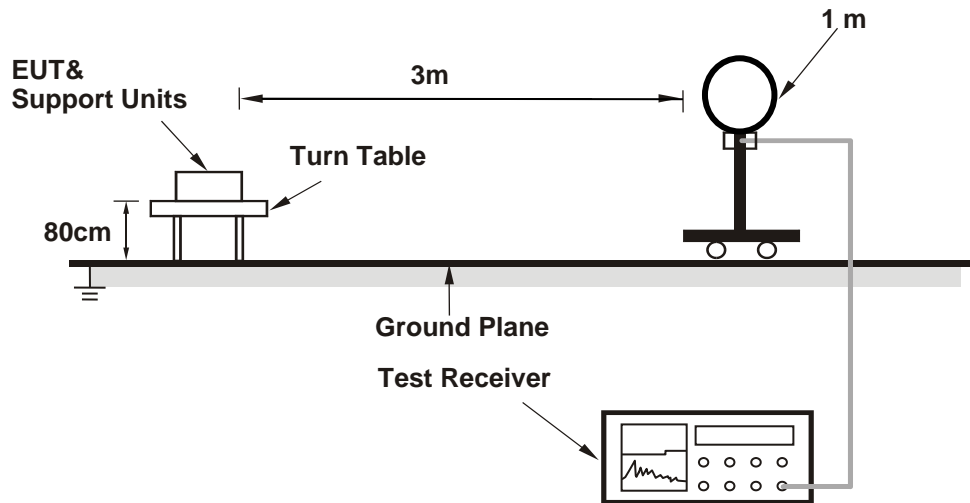

##### For Radiated emission 30MHz to 1GHz

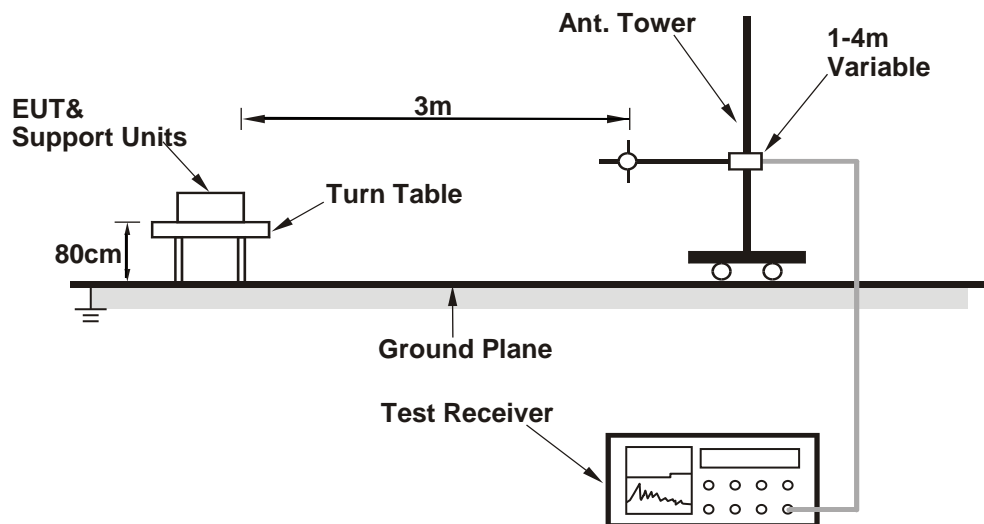

**For Radiated emission above 1GHz**

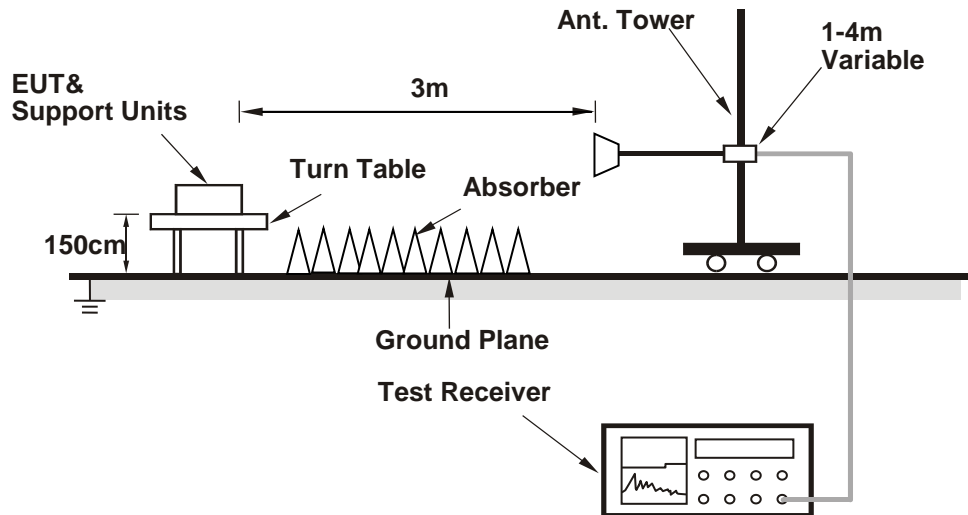

For the actual test configuration, please refer to the attached file (Test Setup Photo).

**4.1.6 EUT Operating Conditions**

- a. Connected the EUT to Adapter.
- b. Set the EUT under transmission condition continuously at specific channel frequency continuously.

#### 4.1.7 Test Results

##### Mode A

##### ABOVE 1GHz DATA

<b>RF Mode</b>	TX 802.11b	<b>Channel</b>	CH 1 : 2412 MHz
<b>Frequency Range</b>	1GHz ~ 25GHz	<b>Detector Function</b>	Peak (PK) Average (AV)

Antenna Polarity & Test Distance : Horizontal at 3 m								
No	Frequency (MHz)	Emission Level (dBuV/m)	Limit (dBuV/m)	Margin (dB)	Antenna Height (m)	Table Angle (Degree)	Raw Value (dBuV)	Correction Factor (dB/m)
1	2390.00	56.72 PK	74.00	-17.28	1.24 H	280	59.00	-2.28
2	2390.00	49.64 AV	54.00	-4.36	1.24 H	280	51.92	-2.28
3	*2412.00	109.45 PK			1.24 H	280	111.64	-2.19
4	*2412.00	107.48 AV			1.24 H	280	109.67	-2.19
5	4824.00	50.06 PK	74.00	-23.94	1.90 H	223	44.40	5.66
6	4824.00	43.96 AV	54.00	-10.04	1.90 H	223	38.30	5.66
Antenna Polarity & Test Distance : Vertical at 3 m								
No	Frequency (MHz)	Emission Level (dBuV/m)	Limit (dBuV/m)	Margin (dB)	Antenna Height (m)	Table Angle (Degree)	Raw Value (dBuV)	Correction Factor (dB/m)
1	2390.00	55.23 PK	74.00	-18.77	3.28 V	6	57.51	-2.28
2	2390.00	46.75 AV	54.00	-7.25	3.28 V	6	49.03	-2.28
3	*2412.00	107.70 PK			3.28 V	6	109.89	-2.19
4	*2412.00	105.70 AV			3.28 V	6	107.89	-2.19
5	4824.00	50.22 PK	74.00	-23.78	1.50 V	240	44.56	5.66
6	4824.00	43.05 AV	54.00	-10.95	1.50 V	240	37.39	5.66

##### Remarks:

1. Emission Level(dBuV/m) = Raw Value(dBuV) + Correction Factor(dB/m)
2. Correction Factor(dB/m) = Antenna Factor(dB/m) + Cable Factor(dB) – Pre-Amplifier Factor(dB)
3. Margin value = Emission Level – Limit value
4. The other emission levels were very low against the limit.
5. " \* ": Fundamental frequency.

<b>RF Mode</b>	TX 802.11b	<b>Channel</b>	CH 6 : 2437 MHz
<b>Frequency Range</b>	1GHz ~ 25GHz	<b>Detector Function</b>	Peak (PK) Average (AV)

**Antenna Polarity & Test Distance : Horizontal at 3 m**

No	Frequency (MHz)	Emission Level (dBuV/m)	Limit (dBuV/m)	Margin (dB)	Antenna Height (m)	Table Angle (Degree)	Raw Value (dBuV)	Correction Factor (dB/m)
1	*2437.00	113.17 PK			1.23 H	259	115.32	-2.15
2	*2437.00	111.15 AV			1.23 H	259	113.30	-2.15
3	4874.00	53.65 PK	74.00	-20.35	2.79 H	293	47.96	5.69
4	4874.00	49.86 AV	54.00	-4.14	2.79 H	293	44.17	5.69

**Antenna Polarity & Test Distance : Vertical at 3 m**

No	Frequency (MHz)	Emission Level (dBuV/m)	Limit (dBuV/m)	Margin (dB)	Antenna Height (m)	Table Angle (Degree)	Raw Value (dBuV)	Correction Factor (dB/m)
1	*2437.00	110.31 PK			4.00 V	21	112.46	-2.15
2	*2437.00	108.35 AV			4.00 V	21	110.50	-2.15
3	4874.00	52.37 PK	74.00	-21.63	1.27 V	152	46.68	5.69
4	4874.00	48.10 AV	54.00	-5.90	1.27 V	152	42.41	5.69

**Remarks:**

1. Emission Level(dBuV/m) = Raw Value(dBuV) + Correction Factor(dB/m)
2. Correction Factor(dB/m) = Antenna Factor(dB/m) + Cable Factor(dB) – Pre-Amplifier Factor(dB)
3. Margin value = Emission Level – Limit value
4. The other emission levels were very low against the limit.
5. " \* ": Fundamental frequency.

<b>RF Mode</b>	TX 802.11b	<b>Channel</b>	CH 11 : 2462 MHz
<b>Frequency Range</b>	1GHz ~ 25GHz	<b>Detector Function</b>	Peak (PK) Average (AV)

**Antenna Polarity & Test Distance : Horizontal at 3 m**

No	Frequency (MHz)	Emission Level (dBuV/m)	Limit (dBuV/m)	Margin (dB)	Antenna Height (m)	Table Angle (Degree)	Raw Value (dBuV)	Correction Factor (dB/m)
1	*2462.00	109.53 PK			1.21 H	275	111.59	-2.06
2	*2462.00	107.56 AV			1.21 H	275	109.62	-2.06
3	2483.50	57.87 PK	74.00	-16.13	1.21 H	275	59.81	-1.94
4	2483.50	50.60 AV	54.00	-3.40	1.21 H	275	52.54	-1.94
5	4924.00	47.61 PK	74.00	-26.39	2.06 H	226	41.84	5.77
6	4924.00	38.46 AV	54.00	-15.54	2.06 H	226	32.69	5.77

**Antenna Polarity & Test Distance : Vertical at 3 m**

No	Frequency (MHz)	Emission Level (dBuV/m)	Limit (dBuV/m)	Margin (dB)	Antenna Height (m)	Table Angle (Degree)	Raw Value (dBuV)	Correction Factor (dB/m)
1	*2462.00	106.19 PK			2.93 V	49	108.25	-2.06
2	*2462.00	104.27 AV			2.93 V	49	106.33	-2.06
3	2483.50	55.29 PK	74.00	-18.71	2.93 V	49	57.23	-1.94
4	2483.50	46.71 AV	54.00	-7.29	2.93 V	49	48.65	-1.94
5	4924.00	48.31 PK	74.00	-25.69	1.79 V	28	42.54	5.77
6	4924.00	39.95 AV	54.00	-14.05	1.79 V	28	34.18	5.77

**Remarks:**

1. Emission Level(dBuV/m) = Raw Value(dBuV) + Correction Factor(dB/m)
2. Correction Factor(dB/m) = Antenna Factor(dB/m) + Cable Factor(dB) – Pre-Amplifier Factor(dB)
3. Margin value = Emission Level – Limit value
4. The other emission levels were very low against the limit.
5. " \* ": Fundamental frequency.

<b>RF Mode</b>	TX 802.11g	<b>Channel</b>	CH 1 : 2412 MHz
<b>Frequency Range</b>	1GHz ~ 25GHz	<b>Detector Function</b>	Peak (PK) Average (AV)

**Antenna Polarity & Test Distance : Horizontal at 3 m**

No	Frequency (MHz)	Emission Level (dBuV/m)	Limit (dBuV/m)	Margin (dB)	Antenna Height (m)	Table Angle (Degree)	Raw Value (dBuV)	Correction Factor (dB/m)
1	2390.00	71.17 PK	74.00	-2.83	1.13 H	333	73.45	-2.28
2	2390.00	51.53 AV	54.00	-2.47	1.13 H	333	53.81	-2.28
3	*2412.00	109.30 PK			1.13 H	333	111.49	-2.19
4	*2412.00	102.06 AV			1.13 H	333	104.25	-2.19
5	4824.00	45.81 PK	74.00	-28.19	2.11 H	235	40.15	5.66
6	4824.00	34.31 AV	54.00	-19.69	2.11 H	235	28.65	5.66

**Antenna Polarity & Test Distance : Vertical at 3 m**

No	Frequency (MHz)	Emission Level (dBuV/m)	Limit (dBuV/m)	Margin (dB)	Antenna Height (m)	Table Angle (Degree)	Raw Value (dBuV)	Correction Factor (dB/m)
1	2390.00	62.57 PK	74.00	-11.43	3.69 V	200	64.85	-2.28
2	2390.00	43.44 AV	54.00	-10.56	3.69 V	200	45.72	-2.28
3	*2412.00	103.20 PK			3.69 V	200	105.39	-2.19
4	*2412.00	96.16 AV			3.69 V	200	98.35	-2.19
5	4824.00	45.29 PK	74.00	-28.71	1.82 V	38	39.63	5.66
6	4824.00	34.89 AV	54.00	-19.11	1.82 V	38	29.23	5.66

**Remarks:**

1. Emission Level(dBuV/m) = Raw Value(dBuV) + Correction Factor(dB/m)
2. Correction Factor(dB/m) = Antenna Factor(dB/m) + Cable Factor(dB) – Pre-Amplifier Factor(dB)
3. Margin value = Emission Level – Limit value
4. The other emission levels were very low against the limit.
5. " \* ": Fundamental frequency.

<b>RF Mode</b>	TX 802.11g	<b>Channel</b>	CH 6 : 2437 MHz
<b>Frequency Range</b>	1GHz ~ 25GHz	<b>Detector Function</b>	Peak (PK) Average (AV)

Antenna Polarity & Test Distance : Horizontal at 3 m								
No	Frequency (MHz)	Emission Level (dBuV/m)	Limit (dBuV/m)	Margin (dB)	Antenna Height (m)	Table Angle (Degree)	Raw Value (dBuV)	Correction Factor (dB/m)
1	2390.00	63.33 PK	74.00	-10.67	1.23 H	260	65.61	-2.28
2	2390.00	51.83 AV	54.00	-2.17	1.23 H	260	54.11	-2.28
3	*2437.00	115.63 PK			1.23 H	260	117.78	-2.15
4	*2437.00	108.30 AV			1.23 H	260	110.45	-2.15
5	2483.50	65.67 PK	74.00	-8.33	1.23 H	260	67.61	-1.94
6	2483.50	52.08 AV	54.00	-1.92	1.23 H	260	54.02	-1.94
7	4874.00	54.14 PK	74.00	-19.86	3.08 H	295	48.45	5.69
8	4874.00	42.85 AV	54.00	-11.15	3.08 H	295	37.16	5.69

Antenna Polarity & Test Distance : Vertical at 3 m								
No	Frequency (MHz)	Emission Level (dBuV/m)	Limit (dBuV/m)	Margin (dB)	Antenna Height (m)	Table Angle (Degree)	Raw Value (dBuV)	Correction Factor (dB/m)
1	2390.00	62.35 PK	74.00	-11.65	2.93 V	132	64.63	-2.28
2	2390.00	51.62 AV	54.00	-2.38	2.93 V	132	53.90	-2.28
3	*2437.00	113.51 PK			2.93 V	132	115.66	-2.15
4	*2437.00	106.22 AV			2.93 V	132	108.37	-2.15
5	2483.50	63.88 PK	74.00	-10.12	2.93 V	132	65.82	-1.94
6	2483.50	50.28 AV	54.00	-3.72	2.93 V	132	52.22	-1.94
7	4874.00	47.99 PK	74.00	-26.01	1.76 V	41	42.30	5.69
8	4874.00	35.88 AV	54.00	-18.12	1.76 V	41	30.19	5.69

**Remarks:**

1. Emission Level(dBuV/m) = Raw Value(dBuV) + Correction Factor(dB/m)
2. Correction Factor(dB/m) = Antenna Factor(dB/m) + Cable Factor(dB) – Pre-Amplifier Factor(dB)
3. Margin value = Emission Level – Limit value
4. The other emission levels were very low against the limit.
5. " \* ": Fundamental frequency.

<b>RF Mode</b>	TX 802.11g	<b>Channel</b>	CH 11 : 2462 MHz
<b>Frequency Range</b>	1GHz ~ 25GHz	<b>Detector Function</b>	Peak (PK) Average (AV)

**Antenna Polarity & Test Distance : Horizontal at 3 m**

No	Frequency (MHz)	Emission Level (dBuV/m)	Limit (dBuV/m)	Margin (dB)	Antenna Height (m)	Table Angle (Degree)	Raw Value (dBuV)	Correction Factor (dB/m)
1	*2462.00	110.48 PK			1.22 H	277	112.54	-2.06
2	*2462.00	103.28 AV			1.22 H	277	105.34	-2.06
3	2483.50	68.15 PK	74.00	-5.85	1.22 H	277	70.09	-1.94
4	2483.50	51.05 AV	54.00	-2.95	1.22 H	277	52.99	-1.94
5	4924.00	45.64 PK	74.00	-28.36	2.85 H	261	39.87	5.77
6	4924.00	35.25 AV	54.00	-18.75	2.85 H	261	29.48	5.77

**Antenna Polarity & Test Distance : Vertical at 3 m**

No	Frequency (MHz)	Emission Level (dBuV/m)	Limit (dBuV/m)	Margin (dB)	Antenna Height (m)	Table Angle (Degree)	Raw Value (dBuV)	Correction Factor (dB/m)
1	*2462.00	105.47 PK			2.93 V	147	107.53	-2.06
2	*2462.00	98.40 AV			2.93 V	147	100.46	-2.06
3	2483.50	62.68 PK	74.00	-11.32	2.93 V	147	64.62	-1.94
4	2483.50	46.20 AV	54.00	-7.80	2.93 V	147	48.14	-1.94
5	4924.00	45.60 PK	74.00	-28.40	1.84 V	37	39.83	5.77
6	4924.00	35.41 AV	54.00	-18.59	1.84 V	37	29.64	5.77

**Remarks:**

1. Emission Level(dBuV/m) = Raw Value(dBuV) + Correction Factor(dB/m)
2. Correction Factor(dB/m) = Antenna Factor(dB/m) + Cable Factor(dB) – Pre-Amplifier Factor(dB)
3. Margin value = Emission Level – Limit value
4. The other emission levels were very low against the limit.
5. " \* ": Fundamental frequency.



<b>RF Mode</b>	TX 802.11n (HT20)	<b>Channel</b>	CH 1 : 2412 MHz
<b>Frequency Range</b>	1GHz ~ 25GHz	<b>Detector Function</b>	Peak (PK) Average (AV)

**Antenna Polarity & Test Distance : Horizontal at 3 m**

No	Frequency (MHz)	Emission Level (dBuV/m)	Limit (dBuV/m)	Margin (dB)	Antenna Height (m)	Table Angle (Degree)	Raw Value (dBuV)	Correction Factor (dB/m)
1	2390.00	68.98 PK	74.00	-5.02	1.44 H	332	71.26	-2.28
2	2390.00	51.16 AV	54.00	-2.84	1.44 H	332	53.44	-2.28
3	*2412.00	110.64 PK			1.44 H	332	112.83	-2.19
4	*2412.00	103.08 AV			1.44 H	332	105.27	-2.19
5	4824.00	45.78 PK	74.00	-28.22	2.91 H	275	40.12	5.66
6	4824.00	34.57 AV	54.00	-19.43	2.91 H	275	28.91	5.66

**Antenna Polarity & Test Distance : Vertical at 3 m**

No	Frequency (MHz)	Emission Level (dBuV/m)	Limit (dBuV/m)	Margin (dB)	Antenna Height (m)	Table Angle (Degree)	Raw Value (dBuV)	Correction Factor (dB/m)
1	2390.00	60.30 PK	74.00	-13.70	2.33 V	277	62.58	-2.28
2	2390.00	43.70 AV	54.00	-10.30	2.33 V	277	45.98	-2.28
3	*2412.00	102.17 PK			2.33 V	277	104.36	-2.19
4	*2412.00	94.83 AV			2.33 V	277	97.02	-2.19
5	4824.00	45.94 PK	74.00	-28.06	1.79 V	39	40.28	5.66
6	4824.00	34.56 AV	54.00	-19.44	1.79 V	39	28.90	5.66

**Remarks:**

1. Emission Level(dBuV/m) = Raw Value(dBuV) + Correction Factor(dB/m)
2. Correction Factor(dB/m) = Antenna Factor(dB/m) + Cable Factor(dB) – Pre-Amplifier Factor(dB)
3. Margin value = Emission Level – Limit value
4. The other emission levels were very low against the limit.
5. " \* ": Fundamental frequency.

<b>RF Mode</b>	TX 802.11n (HT20)	<b>Channel</b>	CH 6 : 2437 MHz
<b>Frequency Range</b>	1GHz ~ 25GHz	<b>Detector Function</b>	Peak (PK) Average (AV)

Antenna Polarity & Test Distance : Horizontal at 3 m								
No	Frequency (MHz)	Emission Level (dBuV/m)	Limit (dBuV/m)	Margin (dB)	Antenna Height (m)	Table Angle (Degree)	Raw Value (dBuV)	Correction Factor (dB/m)
1	2390.00	65.86 PK	74.00	-8.14	1.39 H	259	68.14	-2.28
2	2390.00	52.80 AV	54.00	-1.20	1.39 H	259	55.08	-2.28
3	*2437.00	116.04 PK			1.39 H	259	118.19	-2.15
4	*2437.00	107.79 AV			1.39 H	259	109.94	-2.15
5	2483.50	68.07 PK	74.00	-5.93	1.39 H	259	70.01	-1.94
6	2483.50	53.11 AV	54.00	-0.89	1.39 H	259	55.05	-1.94
7	4874.00	50.33 PK	74.00	-23.67	2.92 H	294	44.64	5.69
8	4874.00	38.58 AV	54.00	-15.42	2.92 H	294	32.89	5.69

Antenna Polarity & Test Distance : Vertical at 3 m								
No	Frequency (MHz)	Emission Level (dBuV/m)	Limit (dBuV/m)	Margin (dB)	Antenna Height (m)	Table Angle (Degree)	Raw Value (dBuV)	Correction Factor (dB/m)
1	2390.00	58.22 PK	74.00	-15.78	3.19 V	200	60.50	-2.28
2	2390.00	46.34 AV	54.00	-7.66	3.19 V	200	48.62	-2.28
3	*2437.00	109.18 PK			3.19 V	200	111.33	-2.15
4	*2437.00	100.79 AV			3.19 V	200	102.94	-2.15
5	2483.50	55.16 PK	74.00	-18.84	3.19 V	200	57.10	-1.94
6	2483.50	43.31 AV	54.00	-10.69	3.19 V	200	45.25	-1.94
7	4874.00	47.21 PK	74.00	-26.79	1.84 V	43	41.52	5.69
8	4874.00	36.57 AV	54.00	-17.43	1.84 V	43	30.88	5.69

**Remarks:**

1. Emission Level(dBuV/m) = Raw Value(dBuV) + Correction Factor(dB/m)
2. Correction Factor(dB/m) = Antenna Factor(dB/m) + Cable Factor(dB) – Pre-Amplifier Factor(dB)
3. Margin value = Emission Level – Limit value
4. The other emission levels were very low against the limit.
5. " \* ": Fundamental frequency.

<b>RF Mode</b>	TX 802.11n (HT20)	<b>Channel</b>	CH 11 : 2462 MHz
<b>Frequency Range</b>	1GHz ~ 25GHz	<b>Detector Function</b>	Peak (PK) Average (AV)

**Antenna Polarity & Test Distance : Horizontal at 3 m**

No	Frequency (MHz)	Emission Level (dBuV/m)	Limit (dBuV/m)	Margin (dB)	Antenna Height (m)	Table Angle (Degree)	Raw Value (dBuV)	Correction Factor (dB/m)
1	*2462.00	112.52 PK			1.22 H	278	114.58	-2.06
2	*2462.00	103.92 AV			1.22 H	278	105.98	-2.06
3	2483.50	71.50 PK	74.00	-2.50	1.22 H	278	73.44	-1.94
<b>4</b>	<b>2483.50</b>	<b>53.21 AV</b>	<b>54.00</b>	<b>-0.79</b>	<b>1.22 H</b>	<b>278</b>	<b>55.15</b>	<b>-1.94</b>
5	4924.00	45.63 PK	74.00	-28.37	2.88 H	295	39.86	5.77
6	4924.00	35.06 AV	54.00	-18.94	2.88 H	295	29.29	5.77

**Antenna Polarity & Test Distance : Vertical at 3 m**

No	Frequency (MHz)	Emission Level (dBuV/m)	Limit (dBuV/m)	Margin (dB)	Antenna Height (m)	Table Angle (Degree)	Raw Value (dBuV)	Correction Factor (dB/m)
1	*2462.00	105.25 PK			4.00 V	202	107.31	-2.06
2	*2462.00	96.70 AV			4.00 V	202	98.76	-2.06
3	2483.50	63.14 PK	74.00	-10.86	4.00 V	202	65.08	-1.94
4	2483.50	43.26 AV	54.00	-10.74	4.00 V	202	45.20	-1.94
5	4924.00	45.82 PK	74.00	-28.18	1.82 V	41	40.05	5.77
6	4924.00	35.24 AV	54.00	-18.76	1.82 V	41	29.47	5.77

**Remarks:**

1. Emission Level(dBuV/m) = Raw Value(dBuV) + Correction Factor(dB/m)
2. Correction Factor(dB/m) = Antenna Factor(dB/m) + Cable Factor(dB) – Pre-Amplifier Factor(dB)
3. Margin value = Emission Level – Limit value
4. The other emission levels were very low against the limit.
5. " \* ": Fundamental frequency.

**Mode A**

**BELOW 1GHz WORST-CASE DATA**

<b>RF Mode</b>	TX 802.11n (HT20)	<b>Channel</b>	CH 6 : 2437 MHz
<b>Frequency Range</b>	9kHz ~ 1GHz	<b>Detector Function</b>	Quasi-Peak (QP)

Antenna Polarity & Test Distance : Horizontal at 3 m								
No	Frequency (MHz)	Emission Level (dBuV/m)	Limit (dBuV/m)	Margin (dB)	Antenna Height (m)	Table Angle (Degree)	Raw Value (dBuV)	Correction Factor (dB/m)
1	89.17	28.82 QP	43.50	-14.68	2.04 H	199	41.15	-12.33
2	204.60	31.52 QP	43.50	-11.98	2.48 H	156	40.19	-8.67
3	368.53	28.39 QP	46.00	-17.61	2.83 H	121	31.02	-2.63
4	450.98	29.20 QP	46.00	-16.80	3.07 H	98	30.02	-0.82
5	614.91	38.09 QP	46.00	-7.91	3.41 H	64	35.44	2.65
6	786.60	32.66 QP	46.00	-13.34	3.62 H	43	26.64	6.02

**Remarks:**

1. Emission Level(dBuV/m) = Raw Value(dBuV) + Correction Factor(dB/m)
2. Correction Factor(dB/m) = Antenna Factor(dB/m) + Cable Factor(dB) – Pre-Amplifier Factor(dB)
3. Margin value = Emission Level – Limit value
4. The other emission levels were very low against the limit of frequency range 30MHz~1000MHz.
5. The emission levels were very low against the limit of frequency range 9kHz~30MHz: the amplitude of spurious emissions attenuated more than 20 dB below the permissible value to be report.

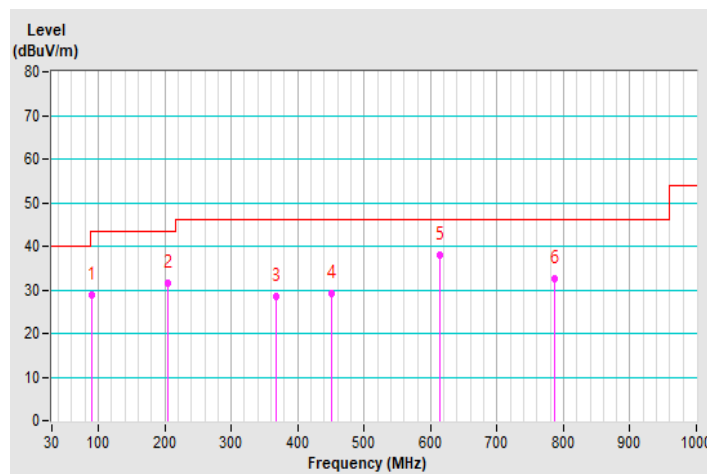

<b>RF Mode</b>	TX 802.11n (HT20)	<b>Channel</b>	CH 6 : 2437 MHz
<b>Frequency Range</b>	9kHz ~ 1GHz	<b>Detector Function</b>	Quasi-Peak (QP)

Antenna Polarity & Test Distance : Vertical at 3 m								
No	Frequency (MHz)	Emission Level (dBuV/m)	Limit (dBuV/m)	Margin (dB)	Antenna Height (m)	Table Angle (Degree)	Raw Value (dBuV)	Correction Factor (dB/m)
1	82.38	31.64 QP	40.00	-8.36	2.95 V	181	43.44	-11.80
2	143.49	26.61 QP	43.50	-16.89	3.17 V	159	33.21	-6.60
3	287.05	26.27 QP	46.00	-19.73	2.70 V	206	30.76	-4.49
4	368.53	26.90 QP	46.00	-19.10	2.46 V	229	29.53	-2.63
5	500.45	28.56 QP	46.00	-17.44	2.18 V	257	28.54	0.02
6	622.67	30.46 QP	46.00	-15.54	1.89 V	286	27.59	2.87

**Remarks:**

1. Emission Level(dBuV/m) = Raw Value(dBuV) + Correction Factor(dB/m)
2. Correction Factor(dB/m) = Antenna Factor(dB/m) + Cable Factor(dB) – Pre-Amplifier Factor(dB)
3. Margin value = Emission Level – Limit value
4. The other emission levels were very low against the limit of frequency range 30MHz~1000MHz.
5. The emission levels were very low against the limit of frequency range 9kHz~30MHz: the amplitude of spurious emissions attenuated more than 20 dB below the permissible value to be report.

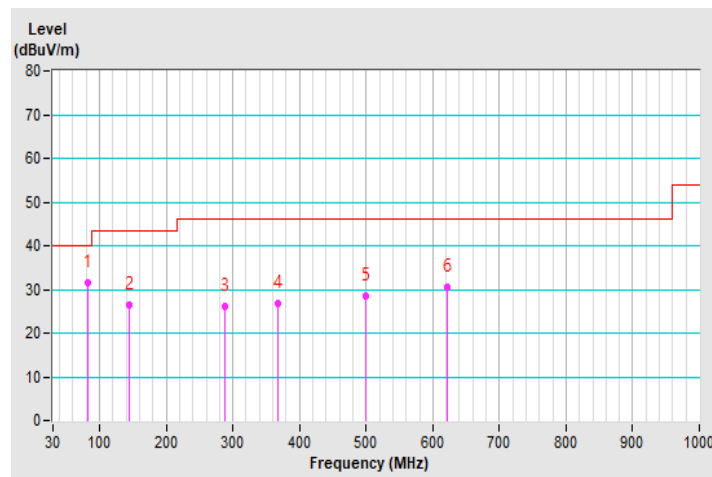

## 4.2 Conducted Emission Measurement

### 4.2.1 Limits of Conducted Emission Measurement

Frequency (MHz)	Conducted Limit (dBuV)	
	Quasi-peak	Average
0.15 - 0.5	66 - 56	56 - 46
0.50 - 5.0	56	46
5.0 - 30.0	60	50

- Note: 1. The lower limit shall apply at the transition frequencies.  
 2. The limit decreases in line with the logarithm of the frequency in the range of 0.15 to 0.50MHz.

### 4.2.2 Test Instruments

Description & Manufacturer	Model no.	Serial No.	Calibrated Date	Calibrated Until
Test Receiver ESR3 R&S	ESR3	102412	2021/1/29	2022/1/28
LISN SCHWARZBECK	NSLK 8128	8128-244	2020/11/19	2021/11/18
LISN SCHWARZBECK	NNLK8129	8129229	2021/5/20	2022/5/19
DC LISN SCHWARZBECK	NNLK 8121	8121-808	2021/4/18	2022/4/17
LISN SCHWARZBECK	NNLK 8121	8121-731	2021/4/28	2022/4/27
LISN R&S	ENV216	101196	2021/4/26	2022/4/25
LISN R&S	ESH3-Z5	100220	2020/12/1	2021/11/30
LISN R&S	ESH3-Z6	844950/018	2021/7/25	2022/7/24
DC LISN R&S	ESH3-Z6	100219	2021/7/25	2022/7/24
High Voltage Probe Schwarzbeck	TK9420	00982	2021/1/8	2022/1/7
RF Coaxial Cable Commate	5D-FB	Cable-CO5-01	2021/1/29	2022/1/28
Attenuator STI	STI02-2200-10	NO.4	2021/9/3	2022/9/2
50 Ohms Terminator LYNICS	0900510	E1-01-305	2021/2/17	2022/2/16
Isolation Transformer Erika Fiedler	D-65396	017	2021/9/9	2022/9/8
Software BVADT	Cond_V7.3.7.4	NA	NA	NA

- Note: 1. The calibration interval of the above test instruments is 12 months and the calibrations are traceable to NML/ROC and NIST/USA.  
 2. The test was performed in Linkou Conduction05  
 3. The VCCI Site Registration No. C-11093.  
 4. Tested Date: 2021/10/9

#### 4.2.3 Test Procedures

- a. The EUT was placed 0.4 meters from the conducting wall of the shielded room with EUT being connected to the power mains through a line impedance stabilization network (LISN). Other support units were connected to the power mains through another LISN. The two LISNs provide 50 ohm/ 50uH of coupling impedance for the measuring instrument.
- b. Both lines of the power mains connected to the EUT were checked for maximum conducted interference.
- c. The frequency range from 150kHz to 30MHz was searched. Emission levels under (Limit - 20dB) was not recorded.

**NOTE:** The resolution bandwidth and video bandwidth of test receiver is 9kHz for quasi-peak detection (QP) and average detection (AV) at frequency 0.15MHz-30MHz.

#### 4.2.4 Deviation from Test Standard

No deviation.

#### 4.2.5 Test Setup

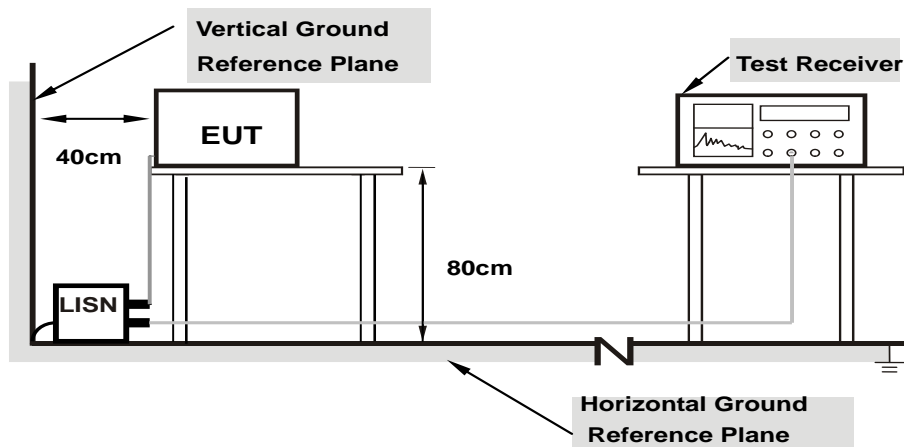

**Note: 1.Support units were connected to second LISN.**

For the actual test configuration, please refer to the attached file (Test Setup Photo).

#### 4.2.6 EUT Operating Conditions

- a. Connected the EUT to Notebook PC or Adapter.
- b. Set the EUT under transmission condition continuously at specific channel frequency continuously.

#### 4.2.7 Test Results

##### Mode A

<b>RF Mode</b>	TX 802.11n (HT20)	<b>Channel</b>	CH 6 : 2437 MHz
<b>Frequency Range</b>	150kHz ~ 30MHz	<b>Detector Function &amp; Resolution Bandwidth</b>	Quasi-Peak (QP) / Average (AV), 9kHz

Phase Of Power : Line (L)										
No	Frequency (MHz)	Correction Factor (dB)	Reading Value (dBuV)		Emission Level (dBuV)		Limit (dBuV)		Margin (dB)	
			Q.P.	AV.	Q.P.	AV.	Q.P.	AV.	Q.P.	AV.
1	0.16600	9.89	34.96	17.79	44.85	27.68	65.16	55.16	-20.31	-27.48
2	0.24164	9.89	30.72	12.90	40.61	22.79	62.04	52.04	-21.43	-29.25
3	0.55997	9.93	21.40	4.85	31.33	14.78	56.00	46.00	-24.67	-31.22
<b>4</b>	<b>0.79200</b>	<b>9.96</b>	<b>26.24</b>	<b>13.73</b>	<b>36.20</b>	<b>23.69</b>	<b>56.00</b>	<b>46.00</b>	<b>-19.80</b>	<b>-22.31</b>
5	4.97200	10.18	19.02	12.03	29.20	22.21	56.00	46.00	-26.80	-23.79
6	9.76400	10.37	18.35	11.82	28.72	22.19	60.00	50.00	-31.28	-27.81

##### Remarks:

1. Q.P. and AV. are abbreviations of quasi-peak and average individually.
2. The emission levels of other frequencies were very low against the limit.
3. Margin value = Emission level – Limit value
4. Correction factor = Insertion loss + Cable loss
5. Emission Level = Correction Factor + Reading Value

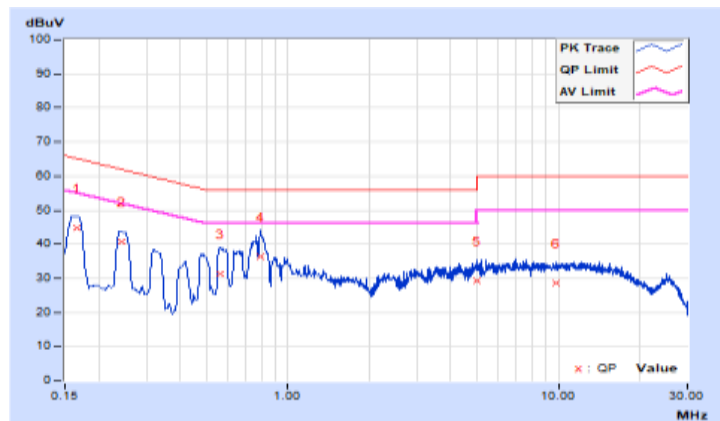



<b>RF Mode</b>	TX 802.11n (HT20)	<b>Channel</b>	CH 6 : 2437 MHz
<b>Frequency Range</b>	150kHz ~ 30MHz	<b>Detector Function &amp; Resolution Bandwidth</b>	Quasi-Peak (QP) / Average (AV), 9kHz

Phase Of Power : Neutral (N)										
No	Frequency (MHz)	Correction Factor (dB)	Reading Value (dBuV)		Emission Level (dBuV)		Limit (dBuV)		Margin (dB)	
			Q.P.	AV.	Q.P.	AV.	Q.P.	AV.	Q.P.	AV.
1	0.16105	9.91	34.00	17.84	43.91	27.75	65.41	55.41	-21.50	-27.66
2	0.32600	9.92	26.21	11.57	36.13	21.49	59.55	49.55	-23.42	-28.06
3	0.72800	9.96	25.87	15.03	35.83	24.99	56.00	46.00	-20.17	-21.01
4	2.21600	10.06	15.87	9.12	25.93	19.18	56.00	46.00	-30.07	-26.82
5	5.81200	10.22	16.26	9.39	26.48	19.61	60.00	50.00	-33.52	-30.39
6	9.69200	10.37	15.37	9.28	25.74	19.65	60.00	50.00	-34.26	-30.35

**Remarks:**

1. Q.P. and AV. are abbreviations of quasi-peak and average individually.
2. The emission levels of other frequencies were very low against the limit.
3. Margin value = Emission level – Limit value
4. Correction factor = Insertion loss + Cable loss
5. Emission Level = Correction Factor + Reading Value

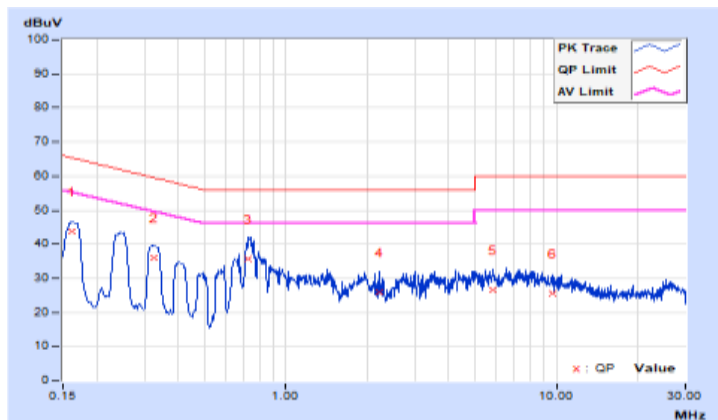

**Mode B**

<b>RF Mode</b>	TX 802.11n (HT20)	<b>Channel</b>	CH 6 : 2437 MHz
<b>Frequency Range</b>	150kHz ~ 30MHz	<b>Detector Function &amp; Resolution Bandwidth</b>	Quasi-Peak (QP) / Average (AV), 9kHz

Phase Of Power : Line (L)										
No	Frequency (MHz)	Correction Factor (dB)	Reading Value (dBuV)		Emission Level (dBuV)		Limit (dBuV)		Margin (dB)	
			Q.P.	AV.	Q.P.	AV.	Q.P.	AV.	Q.P.	AV.
1	0.32200	9.90	19.54	7.62	29.44	17.52	59.66	49.66	-30.22	-32.14
2	0.38200	9.91	15.14	1.93	25.05	11.84	58.24	48.24	-33.19	-36.40
3	0.62400	9.94	10.59	3.60	20.53	13.54	56.00	46.00	-35.47	-32.46
4	3.81600	10.13	24.10	15.75	34.23	25.88	56.00	46.00	-21.77	-20.12
5	5.09600	10.18	19.35	10.03	29.53	20.21	60.00	50.00	-30.47	-29.79
6	7.94400	10.30	22.21	11.25	32.51	21.55	60.00	50.00	-27.49	-28.45

**Remarks:**

1. Q.P. and AV. are abbreviations of quasi-peak and average individually.
2. The emission levels of other frequencies were very low against the limit.
3. Margin value = Emission level – Limit value
4. Correction factor = Insertion loss + Cable loss
5. Emission Level = Correction Factor + Reading Value

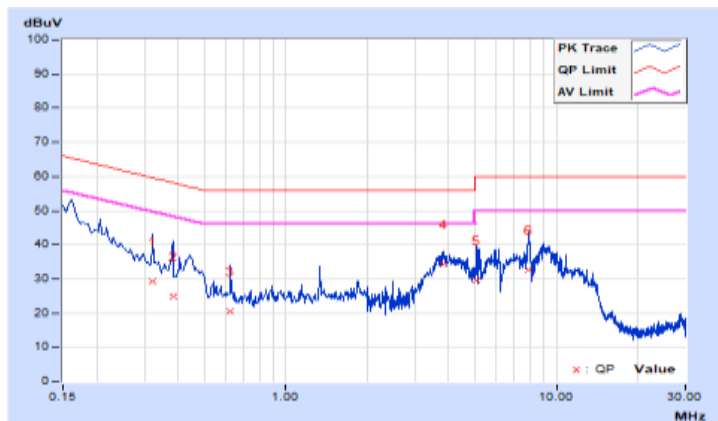

<b>RF Mode</b>	TX 802.11n (HT20)	<b>Channel</b>	CH 6 : 2437 MHz
<b>Frequency Range</b>	150kHz ~ 30MHz	<b>Detector Function &amp; Resolution Bandwidth</b>	Quasi-Peak (QP) / Average (AV), 9kHz

Phase Of Power : Neutral (N)										
No	Frequency (MHz)	Correction Factor (dB)	Reading Value (dBuV)		Emission Level (dBuV)		Limit (dBuV)		Margin (dB)	
			Q.P.	AV.	Q.P.	AV.	Q.P.	AV.	Q.P.	AV.
1	0.20200	9.91	28.30	13.71	38.21	23.62	63.53	53.53	-25.32	-29.91
2	0.31800	9.92	17.98	5.08	27.90	15.00	59.76	49.76	-31.86	-34.76
3	0.44600	9.93	19.76	12.31	29.69	22.24	56.95	46.95	-27.26	-24.71
4	1.69200	10.03	12.97	5.98	23.00	16.01	56.00	46.00	-33.00	-29.99
5	3.84800	10.14	24.33	15.23	34.47	25.37	56.00	46.00	-21.53	-20.63
6	7.68800	10.29	22.77	13.02	33.06	23.31	60.00	50.00	-26.94	-26.69

**Remarks:**

1. Q.P. and AV. are abbreviations of quasi-peak and average individually.
2. The emission levels of other frequencies were very low against the limit.
3. Margin value = Emission level – Limit value
4. Correction factor = Insertion loss + Cable loss
5. Emission Level = Correction Factor + Reading Value

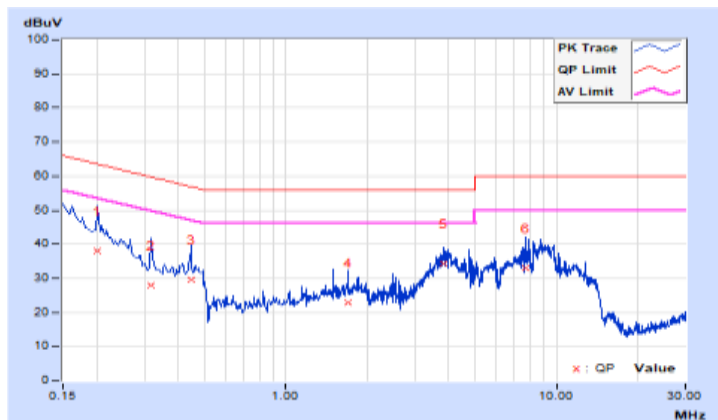

### 4.3 6dB Bandwidth Measurement

#### 4.3.1 Limits of 6dB Bandwidth Measurement

The minimum of 6dB Bandwidth Measurement is 0.5 MHz.

#### 4.3.2 Test Setup

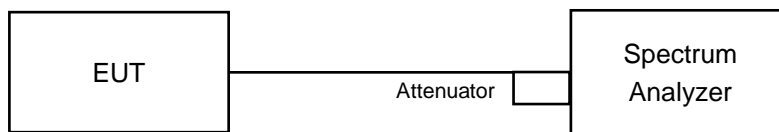

#### 4.3.3 Test Instruments

Description & Manufacturer	Model no.	Serial No.	Calibrated Date	Calibrated Until
Spectrum Analyzer R&S	FSV40	101042	2021/9/9	2022/9/8

- NOTE:**
1. The calibration interval of the above test instruments is 12 months. And the calibrations are traceable to NML/ROC and NIST/USA.
  2. The test was performed in LK - Oven
  3. Tested Date: 2021/10/30

#### 4.3.4 Test Procedure

- a. Set resolution bandwidth (RBW) = 100kHz
- b. Set the video bandwidth (VBW)  $\geq 3 \times$  RBW, Detector = Peak.
- c. Trace mode = max hold.
- d. Sweep = auto couple.
- e. Measure the maximum width of the emission that is constrained by the frequencies associated with the two amplitude points (upper and lower) that are attenuated by 6 dB relative to the maximum level measured in the fundamental emission

#### 4.3.5 Deviation from Test Standard

No deviation.

#### 4.3.6 EUT Operating Conditions

The software provided by client to enable the EUT under transmission condition continuously at lowest, middle and highest channel frequencies individually.

#### 4.3.7 Test Result

##### Mode A

##### 802.11b

Channel	Frequency (MHz)	6dB Bandwidth (MHz)	Minimum Limit (MHz)	Pass / Fail
1	2412	8.13	0.5	Pass
6	2437	8.13	0.5	Pass
11	2462	8.56	0.5	Pass

##### 802.11g

Channel	Frequency (MHz)	6dB Bandwidth (MHz)	Minimum Limit (MHz)	Pass / Fail
1	2412	15.52	0.5	Pass
6	2437	16.36	0.5	Pass
11	2462	15.58	0.5	Pass

##### 802.11n (HT20)

Channel	Frequency (MHz)	6dB Bandwidth (MHz)	Minimum Limit (MHz)	Pass / Fail
1	2412	15.67	0.5	Pass
6	2437	17.38	0.5	Pass
11	2462	15.27	0.5	Pass

Spectrum Plot of Worst Value

802.11b

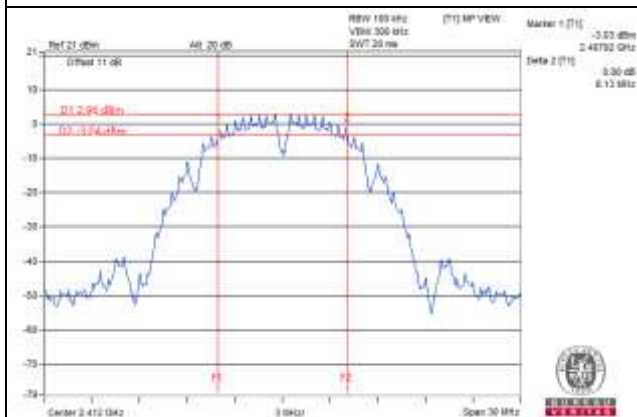

802.11g

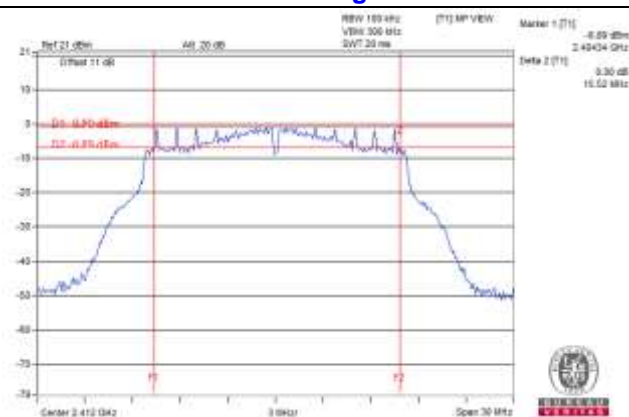

802.11n (HT20)

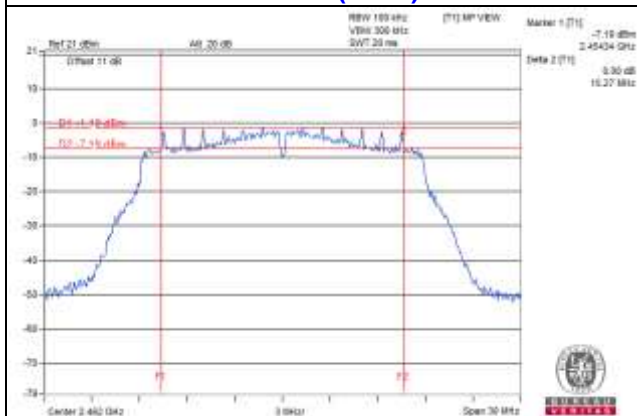

#### 4.4 Conducted Output Power Measurement

##### 4.4.1 Limits of Conducted Output Power Measurement

For systems using digital modulation in the 2400–2483.5 MHz bands: 1 Watt (30dBm)

##### 4.4.2 Test Setup

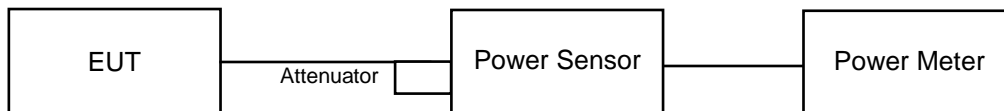

##### 4.4.3 Test Instruments

Description & Manufacturer	Model no.	Serial No.	Calibrated Date	Calibrated Until
Pulse Power Sensor Anritsu	MA2411B	0738404	2021/4/15	2022/4/14
Peak Power meter Anritsu	ML2495A	0842014	2021/4/15	2022/4/14

- NOTE:**
1. The calibration interval of the above test instruments is 12 months. And the calibrations are traceable to NML/ROC and NIST/USA.
  2. The test was performed in LK - Oven
  3. Tested Date: 2021/10/30

##### 4.4.4 Test Procedures

A peak power sensor was used on the output port of the EUT. A power meter was used to read the response of the peak power sensor. Record the power level.

Average power sensor was used to perform output power measurement, trigger and gating function of wide band power meter is enabled to measure max output power of TX on burst. Duty factor is not added to measured value.

##### 4.4.5 Deviation from Test Standard

No deviation.

##### 4.4.6 EUT Operating Conditions

Same as Item 4.3.6.

#### 4.4.7 Test Results

##### Mode A

##### FOR PEAK POWER

##### 802.11b

Channel	Frequency (MHz)	Peak Power (mW)	Peak Power (dBm)	Limit (dBm)	Pass / Fail
1	2412	30.903	14.90	30	Pass
6	2437	31.696	15.01	30	Pass
11	2462	30.69	14.87	30	Pass

##### 802.11g

Channel	Frequency (MHz)	Peak Power (mW)	Peak Power (dBm)	Limit (dBm)	Pass / Fail
1	2412	148.252	21.71	30	Pass
6	2437	<b>158.855</b>	22.01	30	Pass
11	2462	154.17	21.88	30	Pass

##### 802.11n (HT20)

Channel	Frequency (MHz)	Peak Power (mW)	Peak Power (dBm)	Limit (dBm)	Pass / Fail
1	2412	93.972	19.73	30	Pass
6	2437	93.756	19.72	30	Pass
11	2462	91.411	19.61	30	Pass



**Mode A**

**FOR AVERAGE POWER**

**802.11b**

Channel	Frequency (MHz)	Avg. Power (mW)	Avg. Power (dBm)
1	2412	15.136	11.80
6	2437	15.488	11.90
11	2462	15.136	11.80

**802.11g**

Channel	Frequency (MHz)	Avg. Power (mW)	Avg. Power (dBm)
1	2412	14.125	11.50
6	2437	14.791	11.70
11	2462	14.454	11.60

**802.11n (HT20)**

Channel	Frequency (MHz)	Avg. Power (mW)	Avg. Power (dBm)
1	2412	13.804	11.40
6	2437	13.804	11.40
11	2462	13.49	11.30

## 4.5 Power Spectral Density Measurement

### 4.5.1 Limits of Power Spectral Density Measurement

The Maximum of Power Spectral Density Measurement is 8dBm in any 3 kHz.

### 4.5.2 Test Setup

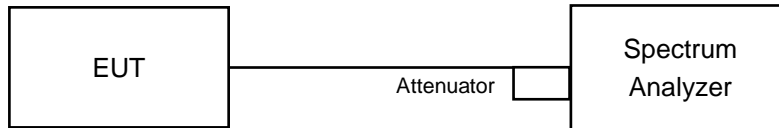

### 4.5.3 Test Instruments

Refer to section 4.3.3 to get information of above instrument.

### 4.5.4 Test Procedure

- a. Set analyzer center frequency to DTS channel center frequency.
- b. Set the span to 1.5 times the DTS bandwidth.
- c. Set the RBW to:  $3 \text{ kHz} \leq \text{RBW} \leq 100 \text{ kHz}$ .
- d. Set the VBW  $\geq 3 \times \text{RBW}$ .
- e. Detector = peak.
- f. Sweep time = auto couple.
- g. Trace mode = max hold.
- h. Allow trace to fully stabilize.
- i. Use the peak marker function to determine the maximum amplitude level within the RBW.

### 4.5.5 Deviation from Test Standard

No deviation.

### 4.5.6 EUT Operating Condition

Same as Item 4.3.6

#### 4.5.7 Test Results

##### Mode A

##### 802.11b

Channel	Freq. (MHz)	PSD (dBm/3kHz)	PSD Limit (dBm/3kHz)	Pass /Fail
1	2412	-8.88	8.00	Pass
6	2437	-8.8	8.00	Pass
11	2462	-9.6	8.00	Pass

##### 802.11g

Channel	Freq. (MHz)	PSD (dBm/3kHz)	PSD Limit (dBm/3kHz)	Pass /Fail
1	2412	-11.83	8.00	Pass
6	2437	-12.66	8.00	Pass
11	2462	-12.58	8.00	Pass

##### 802.11n (HT20)

Channel	Freq. (MHz)	PSD (dBm/3kHz)	PSD Limit (dBm/3kHz)	Pass /Fail
1	2412	-12.02	8.00	Pass
6	2437	-13.04	8.00	Pass
11	2462	-12.76	8.00	Pass

Spectrum Plot of Worst Value

802.11b

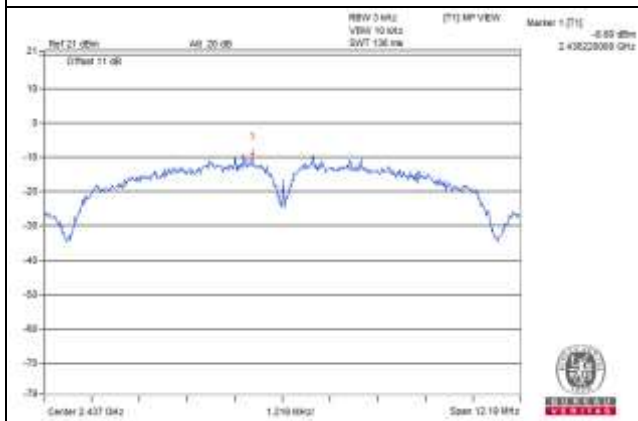

802.11g

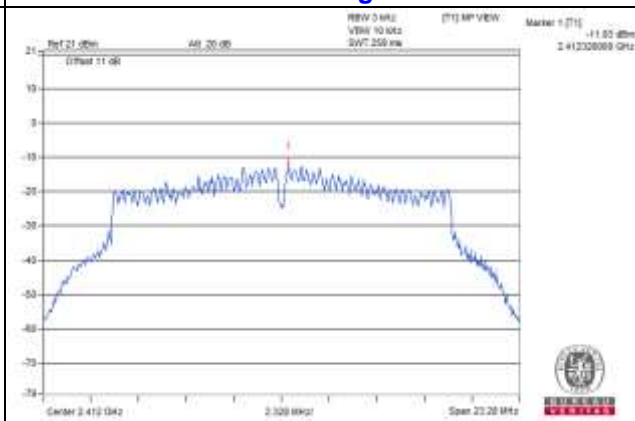

802.11n (HT20)

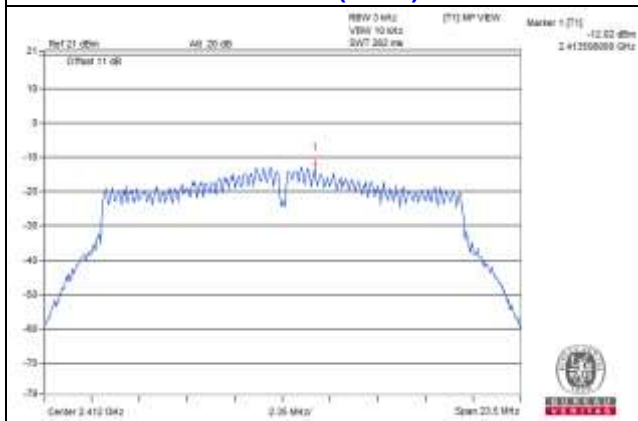

## 4.6 Conducted Out of Band Emission Measurement

### 4.6.1 Limits of Conducted Out of Band Emission Measurement

Below 20dB of the highest emission level of operating band (in 100kHz Resolution Bandwidth).

### 4.6.2 Test Setup

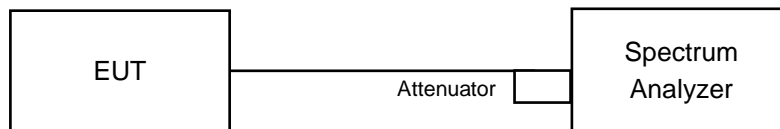

### 4.6.3 Test Instruments

Refer to section 4.3.3 to get information of above instrument.

### 4.6.4 Test Procedure

#### MEASUREMENT PROCEDURE REF

1. Set the RBW = 100 kHz.
2. Set the VBW  $\geq$  300 kHz.
3. Detector = peak.
4. Sweep time = auto couple.
5. Trace mode = max hold.
6. Allow trace to fully stabilize.
7. Use the peak marker function to determine the maximum power level in any 100 kHz band segment within the fundamental EBW.

#### MEASUREMENT PROCEDURE OOB

1. Set RBW = 100 kHz.
2. Set VBW  $\geq$  300 kHz.
3. Detector = peak.
4. Sweep = auto couple.
5. Trace Mode = max hold.
6. Allow trace to fully stabilize.
7. Use the peak marker function to determine the maximum amplitude level.

### 4.6.5 Deviation from Test Standard

No deviation.

### 4.6.6 EUT Operating Condition

Same as Item 4.3.6

### 4.6.7 Test Results

The spectrum plots are attached on the following pages. D1 line indicates the highest level, and D2 line indicates the 20dB offset below D1. It shows compliance with the requirement.

Mode A  
802.11b

CH 1

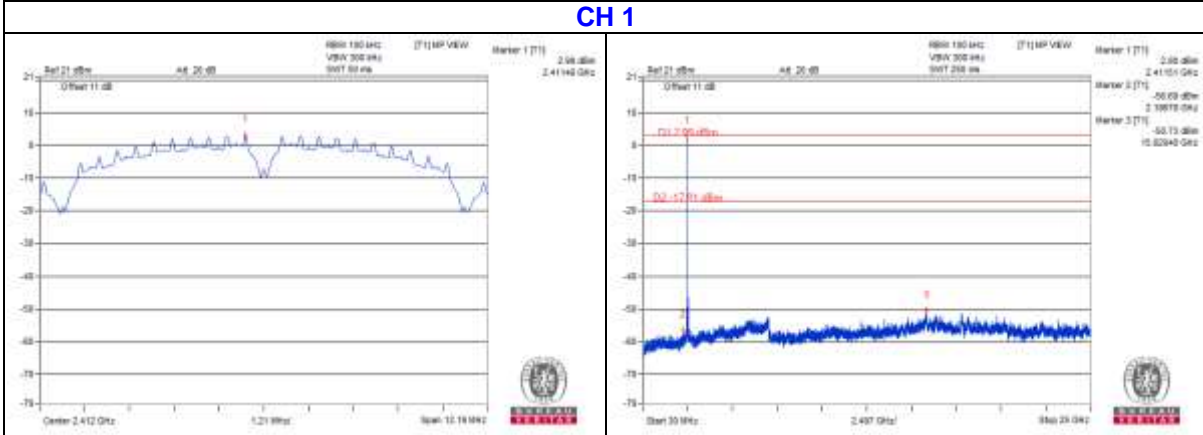

CH 6

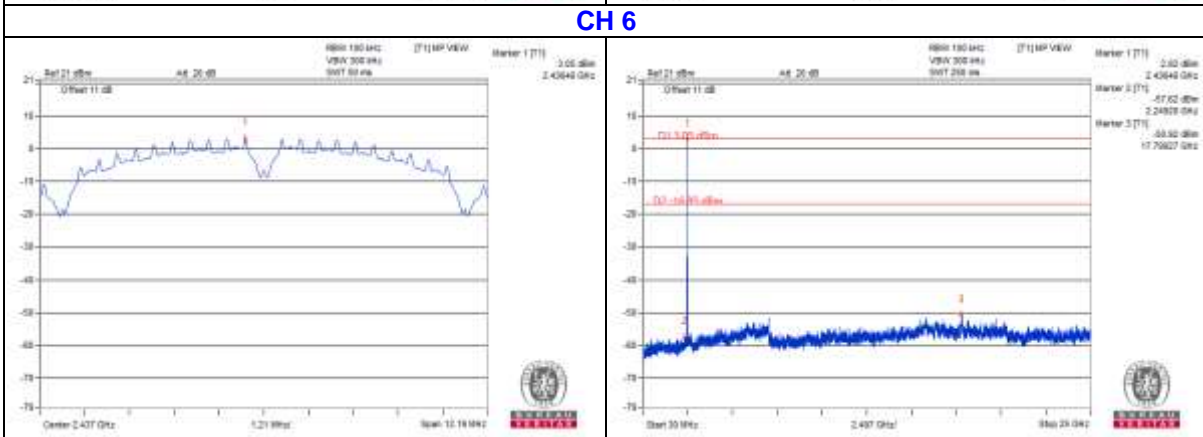

CH 11

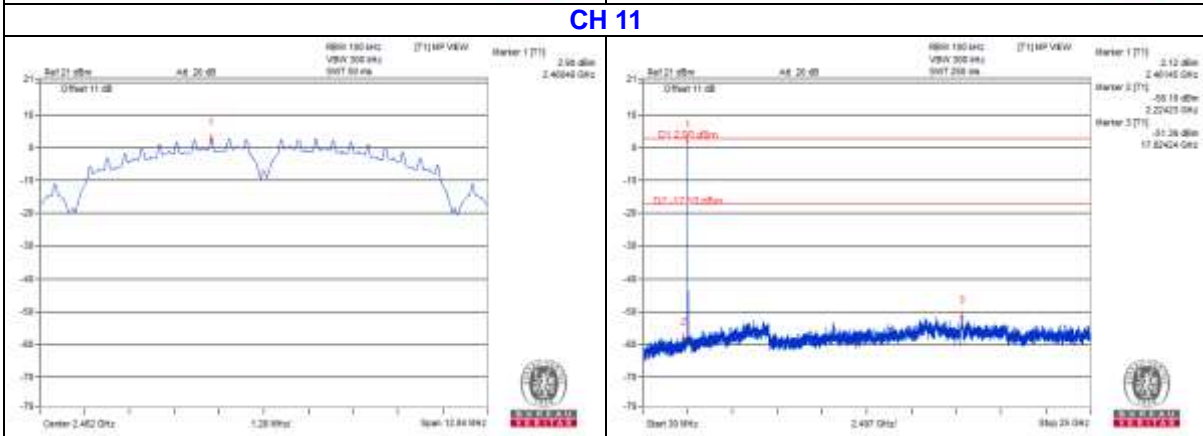

CH 1 Band edge

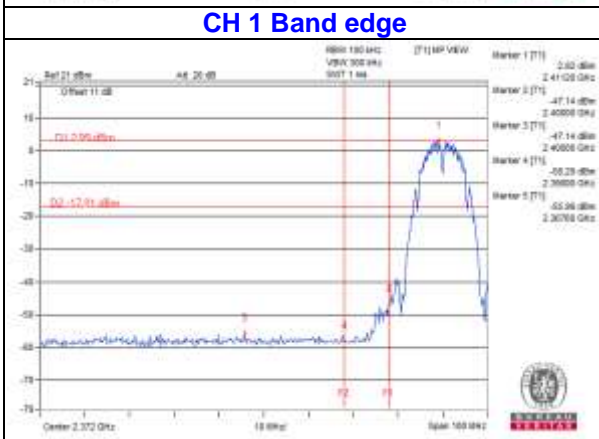

CH 11 Band edge

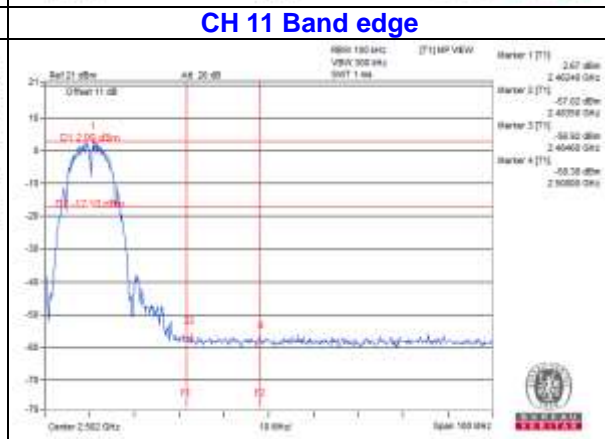

802.11g

**CH 1**

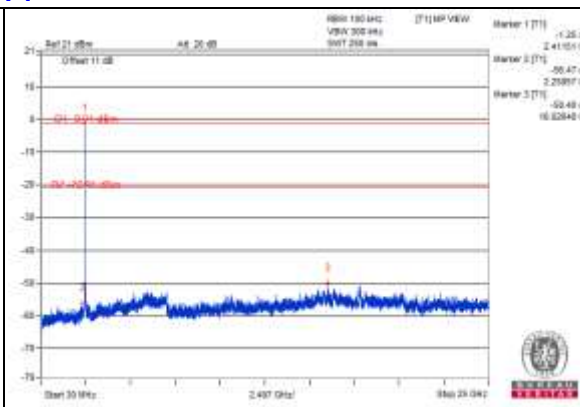
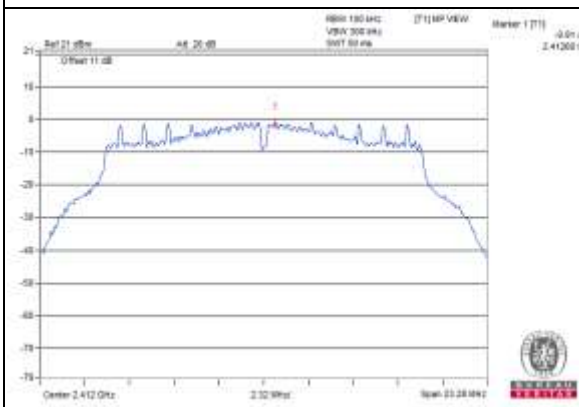

**CH 6**

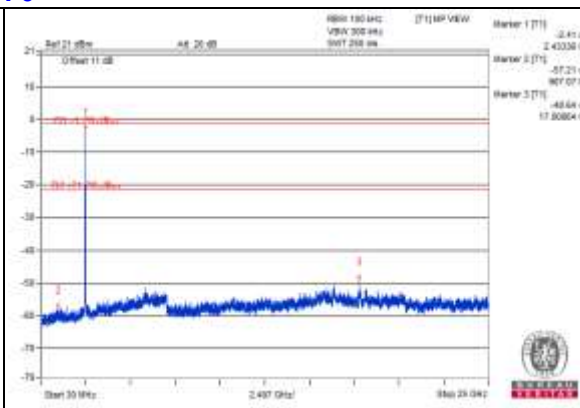
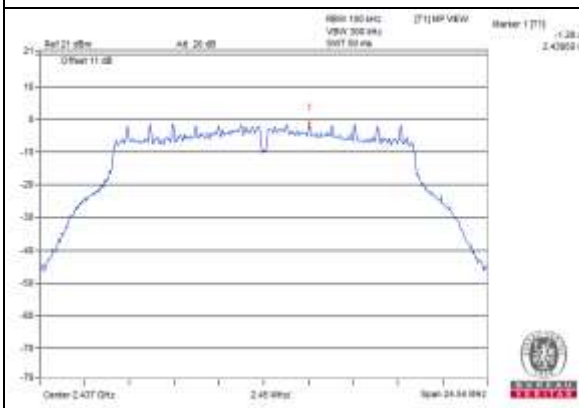

**CH 11**

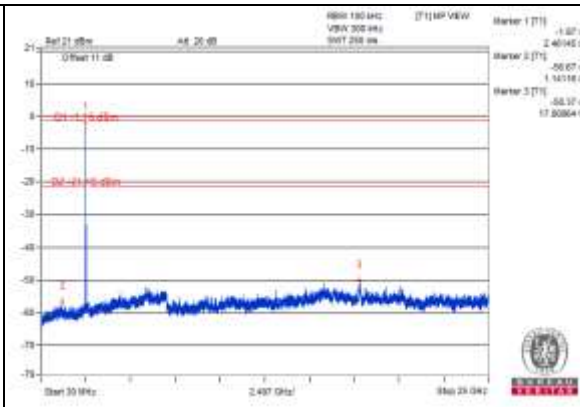
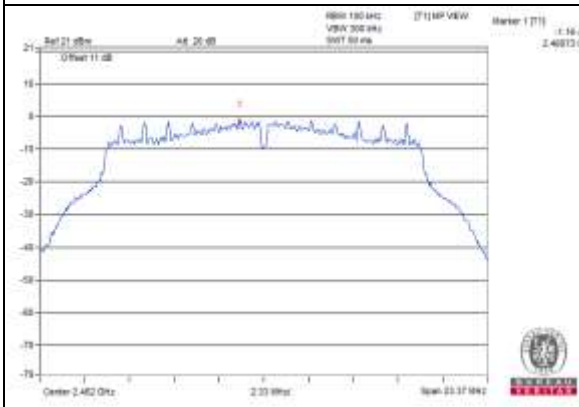

**CH 1 Band edge**

**CH 11 Band edge**

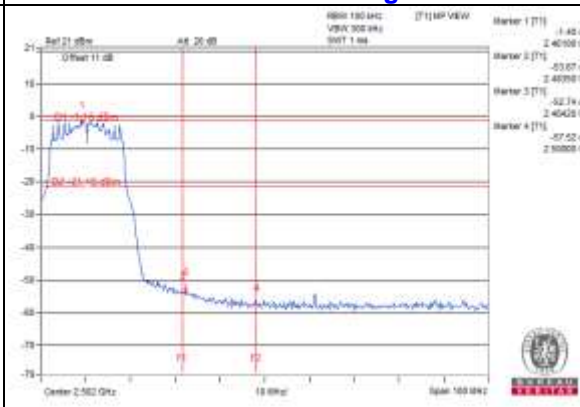
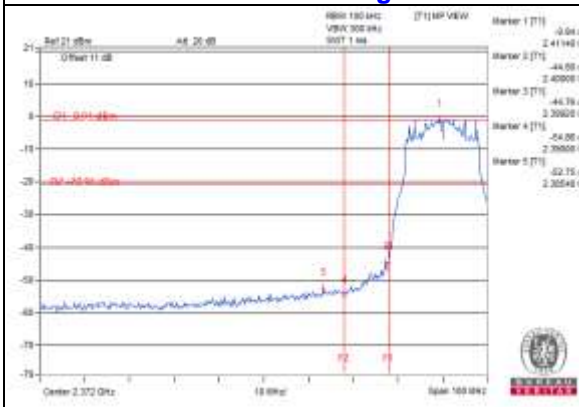

802.11n (HT20)

CH 1

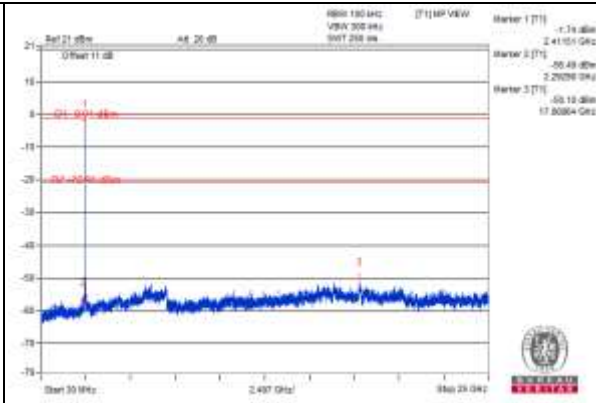
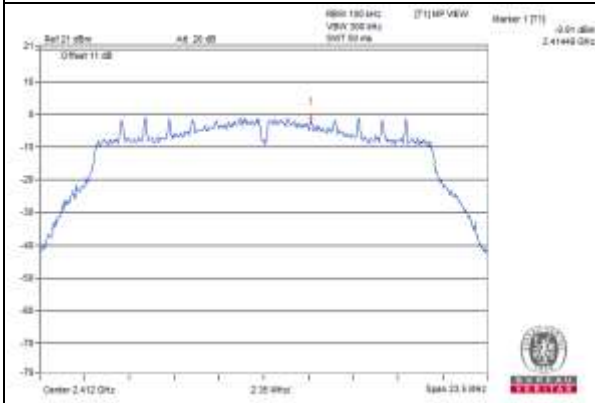

CH 6

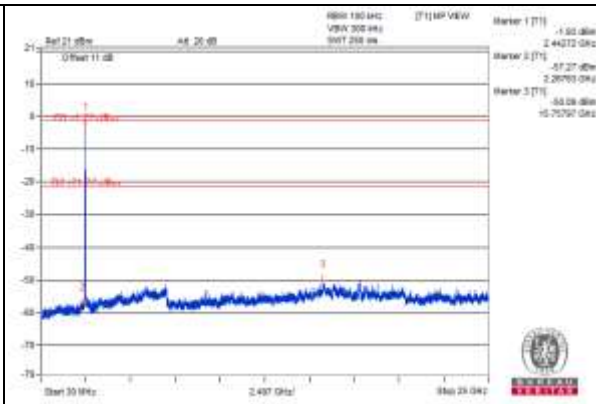
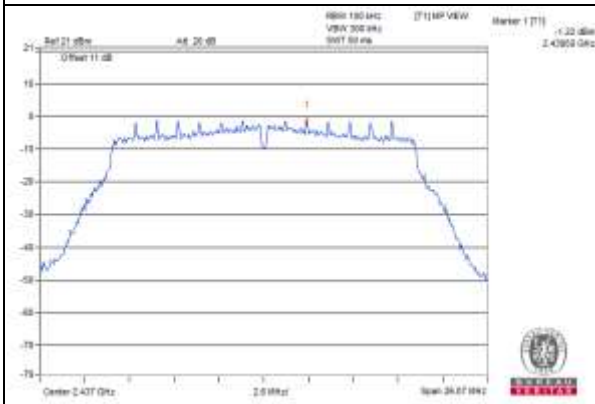

CH 11

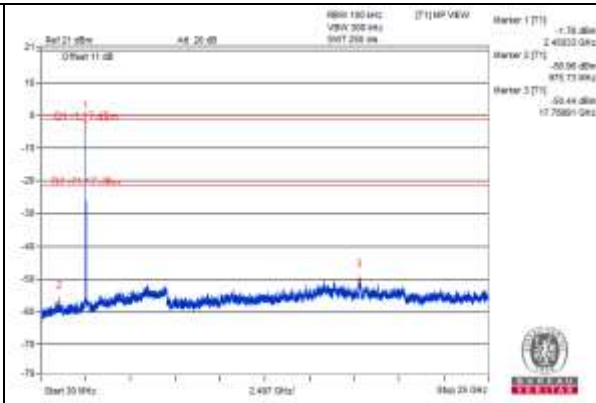
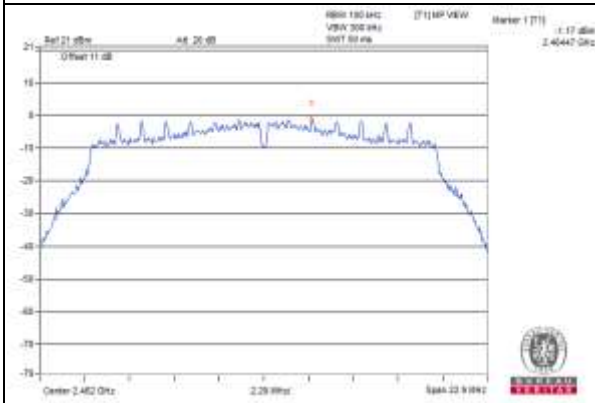

CH 1 Band edge

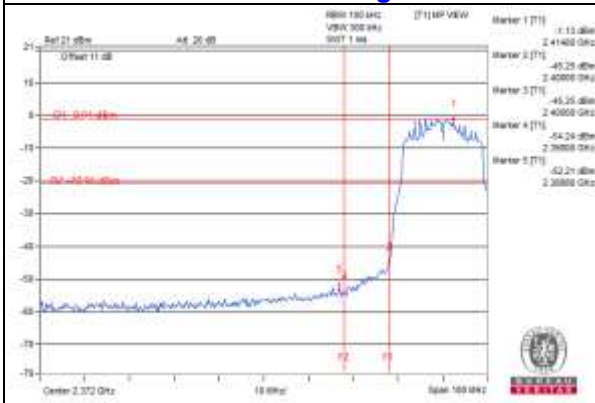

CH 11 Band edge

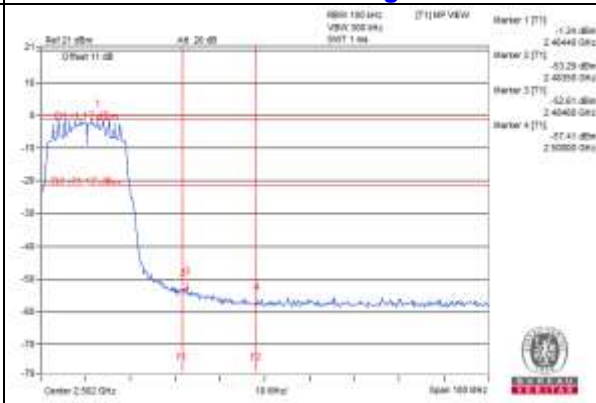



## 5 Pictures of Test Arrangements

Please refer to the attached file (Test Setup Photo).

### Annex A- Band Edge Measurement

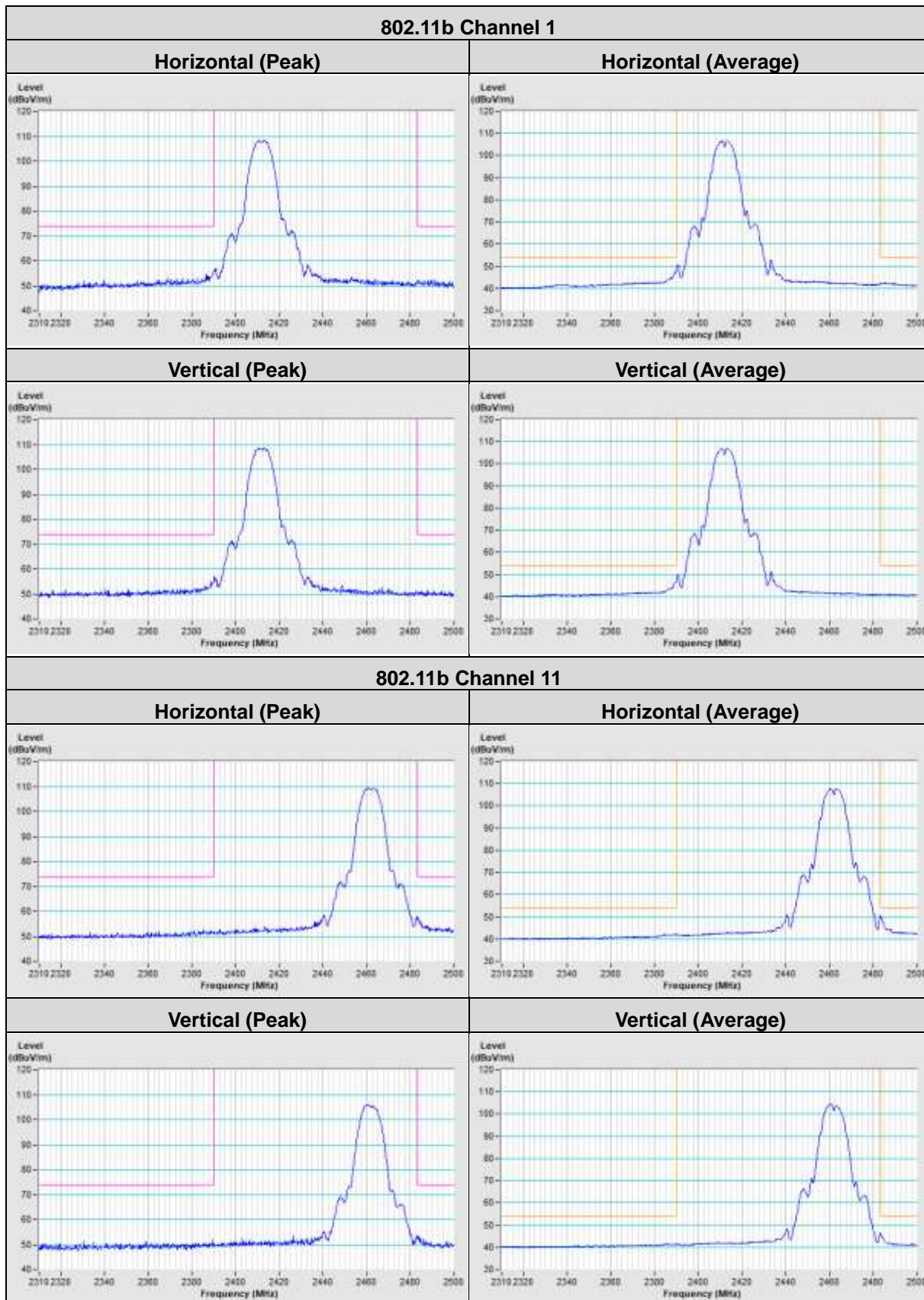

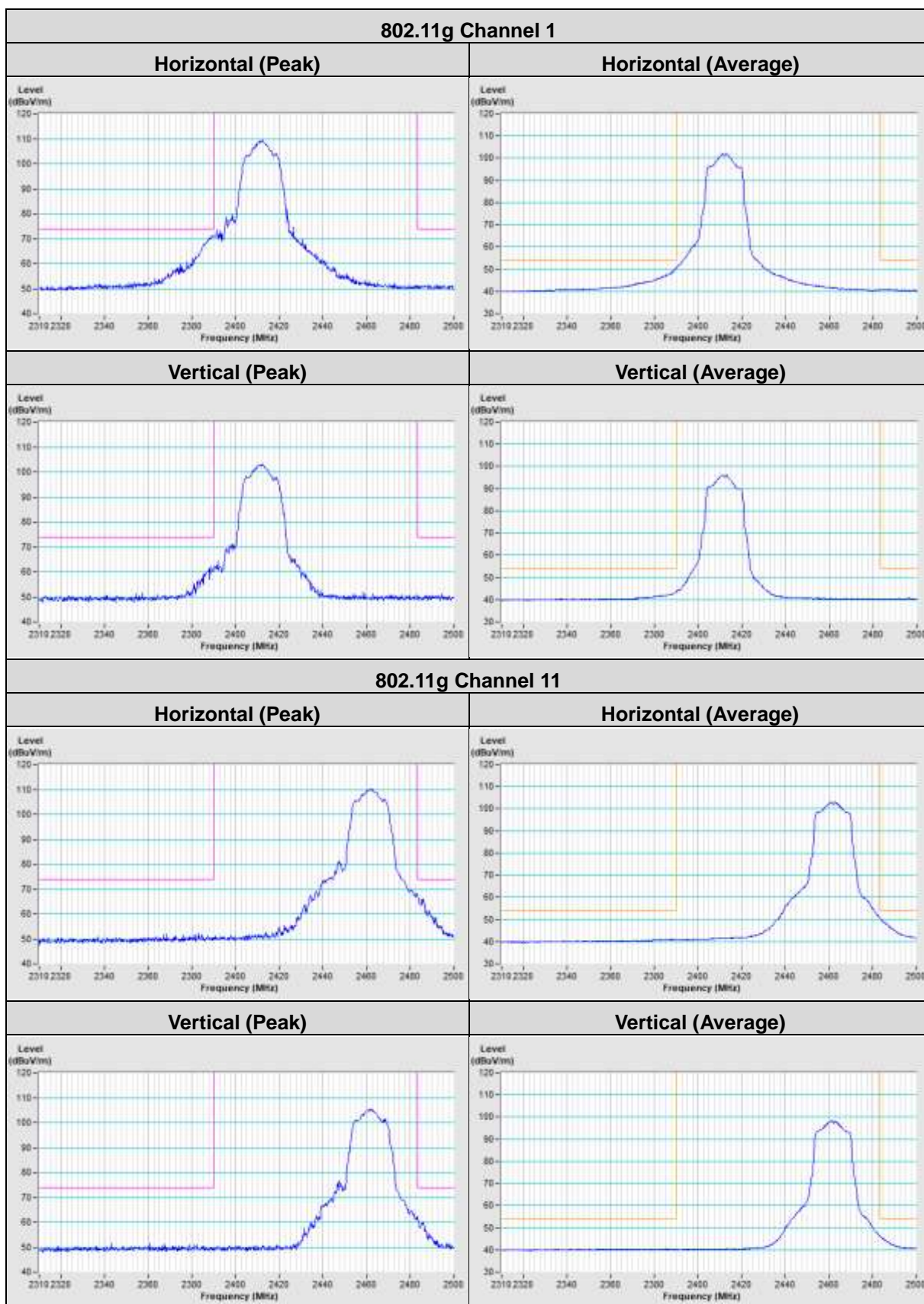

**802.11n (HT20) Channel 1**

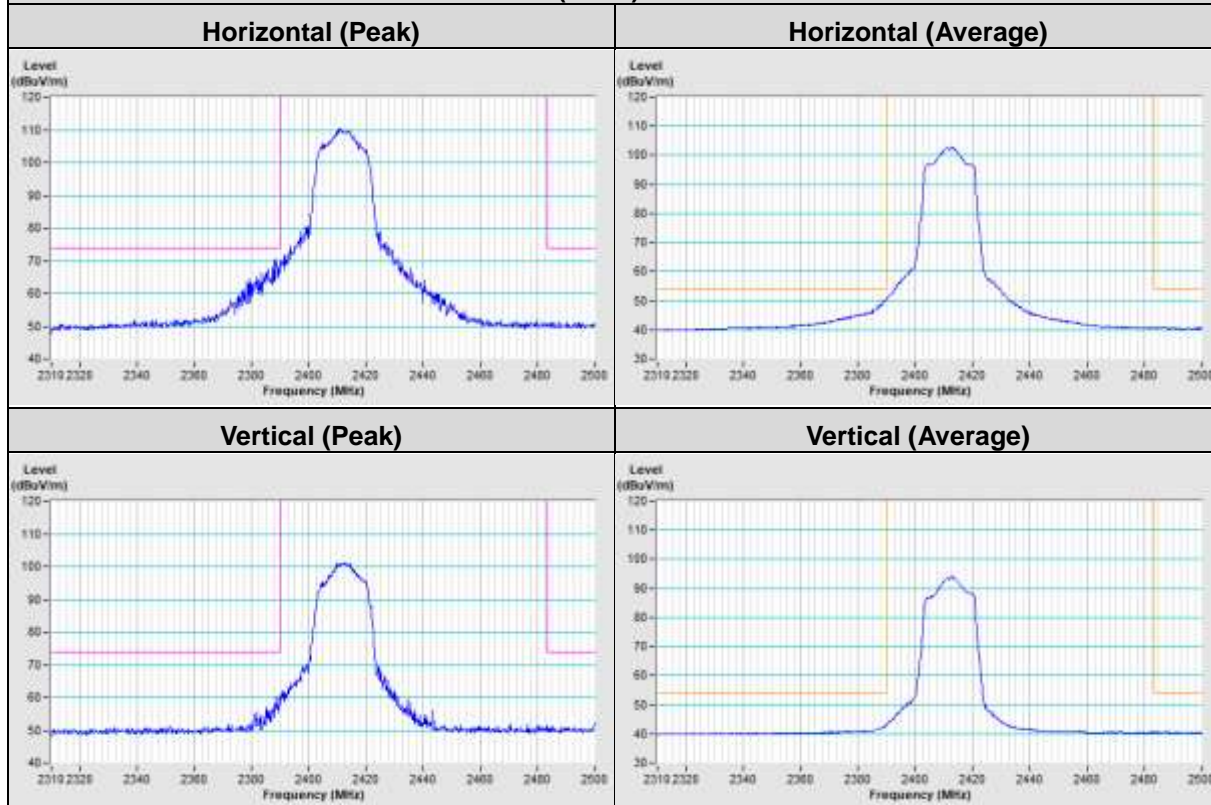

**802.11n (HT20) Channel 11**

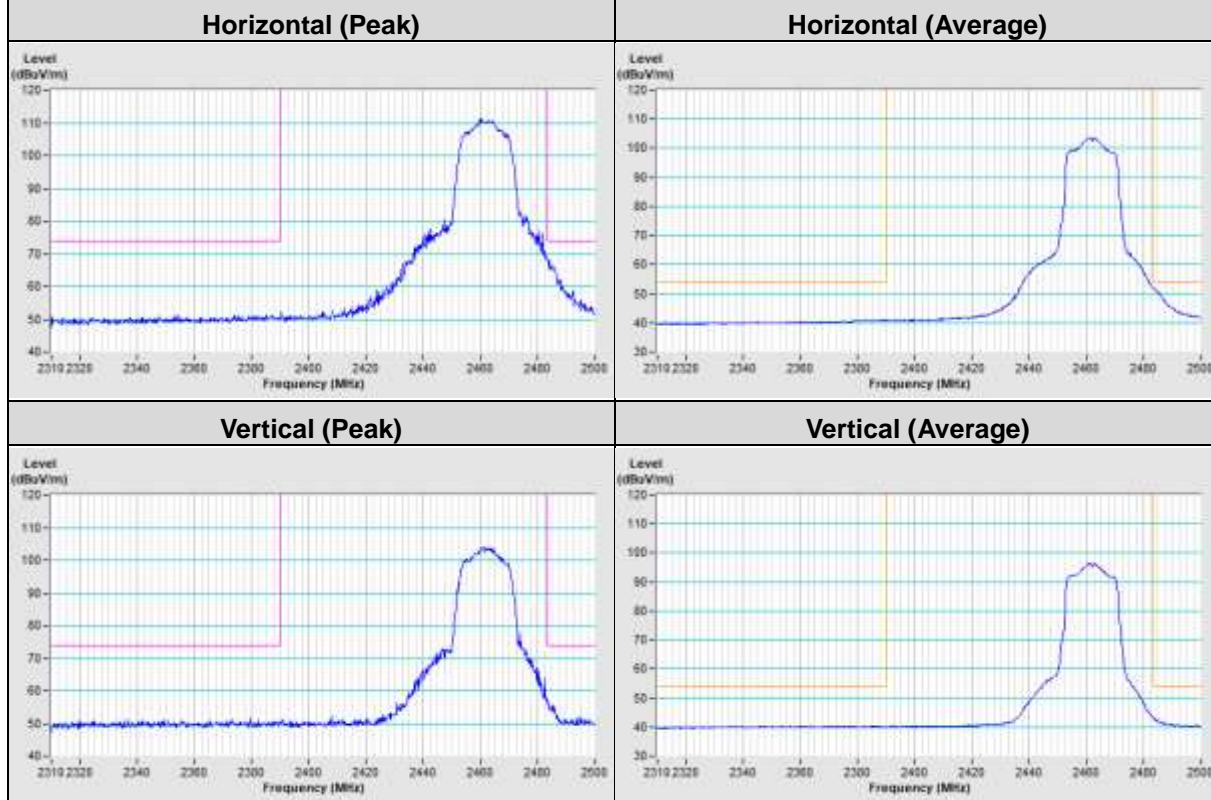

## Appendix – Information of the Testing Laboratories

We, Bureau Veritas Consumer Products Services (H.K.) Ltd., Taoyuan Branch, were founded in 1988 to provide our best service in EMC, Radio, Telecom and Safety consultation. Our laboratories are FCC recognized accredited test firms and accredited according to ISO/IEC 17025.

If you have any comments, please feel free to contact us at the following:

**Lin Kou EMC/RF Lab**

Tel: 886-2-26052180

Fax: 886-2-26051924

**Hsin Chu EMC/RF/Telecom Lab**

Tel: 886-3-6668565

Fax: 886-3-6668323

**Hwa Ya EMC/RF/Safety Lab**

Tel: 886-3-3183232

Fax: 886-3-3270892

**Email:** [service.adt@tw.bureauveritas.com](mailto:service.adt@tw.bureauveritas.com)

**Web Site:** [www.bureauveritas-adt.com](http://www.bureauveritas-adt.com)

The address and road map of all our labs can be found in our web site also.

--- END ---