

**Exhibit 4      RF Power Output: 2.983 (d)-3, 2.983 (d) -4, 2.985 (a)**

The Active Antenna complies with the maximum EIRP limit of 1640 Watts as specified in 47 CFR 24.232. The EIRP of the Active Antenna is determined by the sum of combined output power of the internal transmit amplifiers and the gain of the radiating array. This exhibit provides measurements of: the combined output power of the amplifiers as measured in the laboratory, the gain of the radiating array, and field measurements of the total, combined EIRP

Each set of data includes a block diagram of the test set up, list of test equipment, description of the test sequence, and test data. Specific items included in Exhibit 4 are listed following.

**Included Items**

1. RF power Output at the Combined Amplifier Power Reference Point - 2.983(d)-3
2. Range measurement of radiating elements
3. Active Antenna RF power output - field measurements

**4-1 RF Power Output at the Combined Amplifier Power Reference Point - 2.983(d)-3**

The Active Antenna contains five amplifier channels, each of which is connected to an antenna subarray of four radiating elements. To measure the combined RF output power, the antenna elements are removed and a passive test combiner of known loss is used to sum the output of the five amplifiers into a single output.

The unit was measured in a temperature chamber and RF output data was collected at three temperatures, -35 °C, +25 °C, and + 55 °C. For each test, the input port of the Active Antenna is driven with an unmodulated signal source at +20.5 dBm (100 mW) power input which allows the sum of the power amplifiers to reach full rated power of 40 dBm (10 W) total.

The test diagram is shown in Figure 4-1 and the list of test equipment is provided at the end of this exhibit.

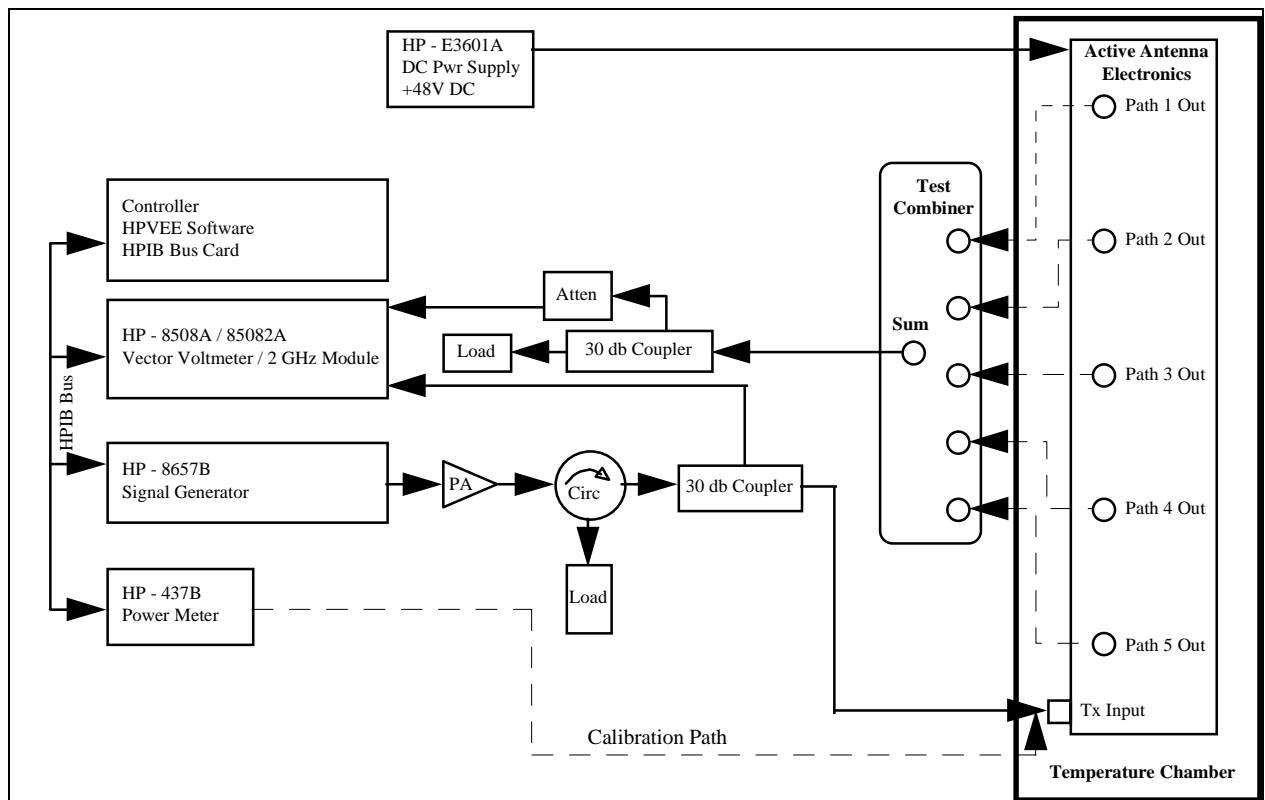

**Figure 4-1 Test Configuration for RF Power Output Sum Path Measurements**

**Test Data:**

Measured RF power out is shown in Figure 4-2 and Table 4-1. The data shows the power to be within acceptable tolerances over the frequency band and operational temperature range.

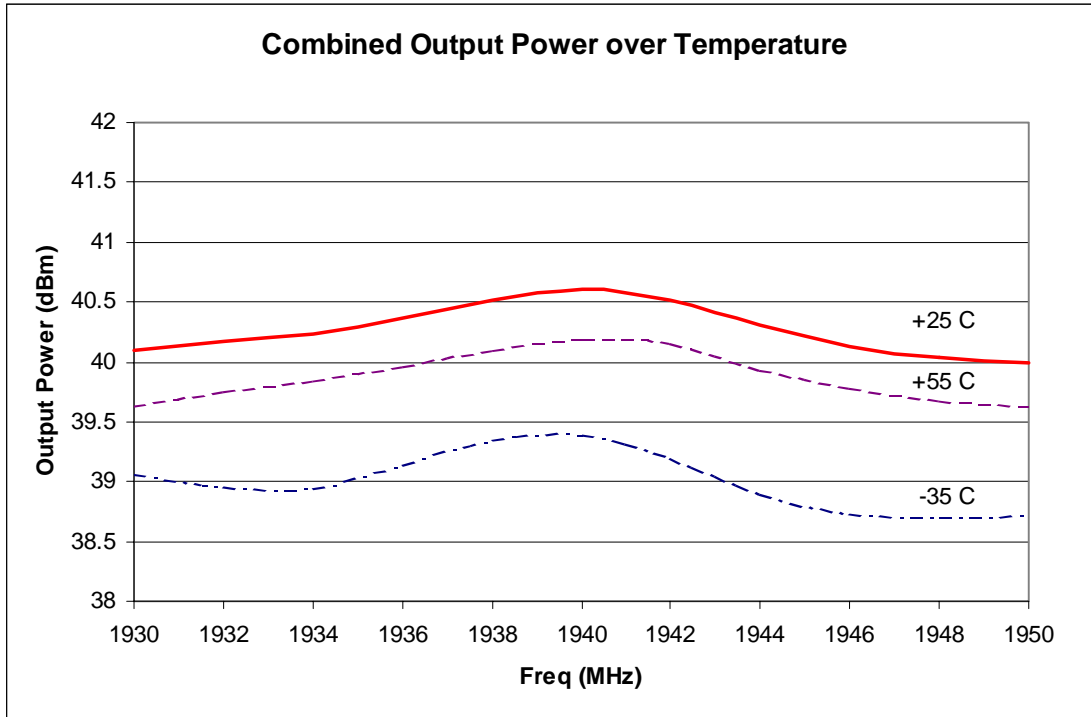

Figure 4-2 RF Power Output

Frequency (MHz)	Temperature C	Power Output (dBm)
1930	-35 ° C	39.1
1930	+25 ° C	40.1
1930	+55 ° C	39.6
1940	-35 ° C	39.4
1940	+25 ° C	40.6
1940	+55 ° C	40.2
1950	-35 ° C	38.7
1950	+25 ° C	40.0
1950	+55 ° C	39.6

Table 4-1 RF Power Output

**4-3 Range measurement of the radiating elements**

The radiating elements for the Active Antenna are aperture coupled patch arrays with a nominal 3 dB horizontal beamwidth of 65 degrees and a peak gain of 21 dBi. Figure 4-3 shows the measured field pattern of the aperture. Figures 4-4 shows a far field measurement of the isotropic gain of the transmit aperture. The gain of the transmit array is within the production limits discussed in section 2-983(d)-4 of this report, i.e. 21 +/- 0.5 dB.

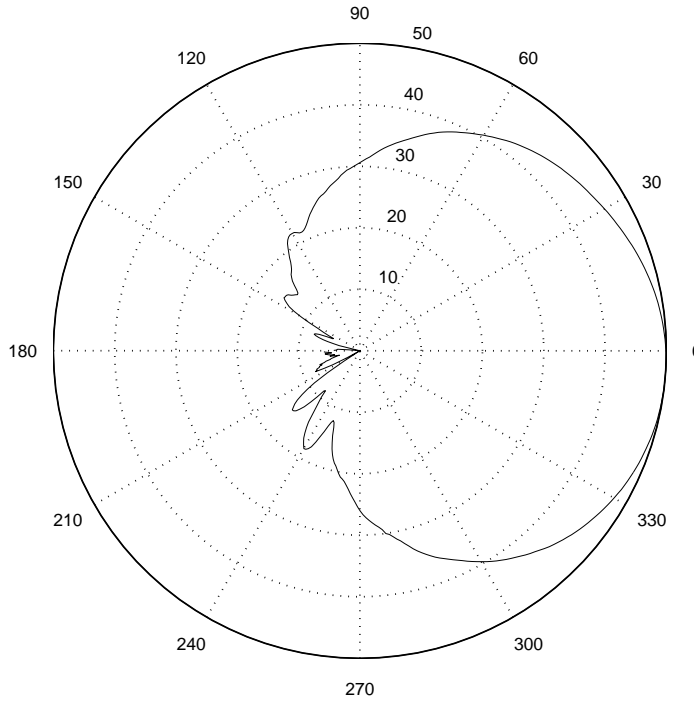

**Figure 4-3- Measured Horizontal Radiation Pattern of the Active Antenna Aperture**

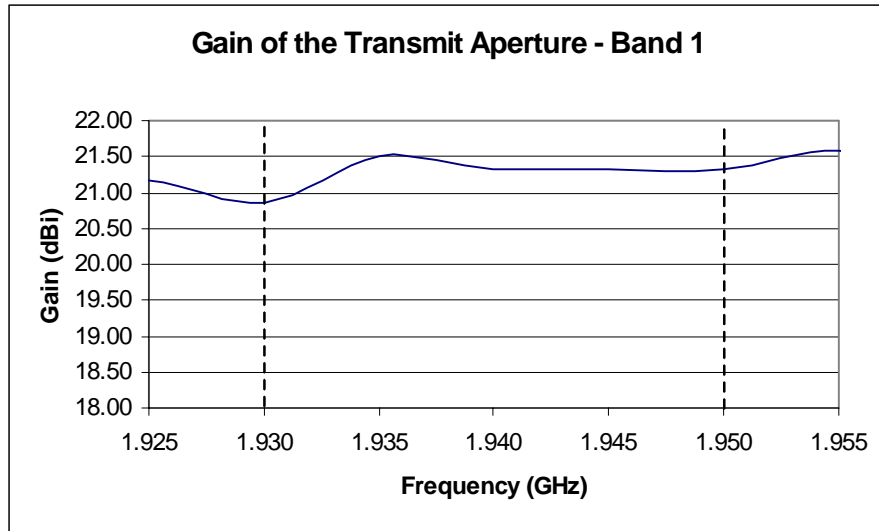

**Figure 4-4 Measured Gain of the Band 1 Transmit Antenn**

**4-3 Active Antenna EIRP measurements**

The sum of the RF output power (+40 dBm) and the isotropic antenna gain (21 dBi), provides the total EIRP of 61 dBm. To confirm this measurement, the EIRP of the complete system was measured on a far field antenna range.

To measure EIRP, the antennas are mounted on a 100' antenna test tower with the receiving equipment located on a similar tower, 400' downrange. Reflection fences are used to minimize ground reflections.

First, a signal source is configured to deliver a fixed power between 20.5 and 32.5 dBm into a reference antenna with a known gain. The received signal strength is then measured downrange at 5 MHz increments across the appropriate sub-band.

The reference antenna is then replaced with the Active Antenna. The Active Antenna is commanded to calibrate the input drive level and the internal attenuator settings are noted. The new received signal strength is then recorded at each frequency. From this, the EIRP of the Active Antenna is calculated by adding the difference in received power levels and the internal attenuator settings to the gain of the reference antenna.

The test unit was configured with a set of filters for each of the three bands. Results for these measurements are given in Figures 4-5, 4-6, and 4-7.

The average EIRP and the variation over frequency will be somewhat different than the calculated value using the individual components. This is due to VSWR interactions between the elements' feed network and the amplifier/filter output. However, the results for all three bands are in compliance with the +62 dB (1640 W) limit on EIRP as shown in Figures 4-5, 6, and 7.

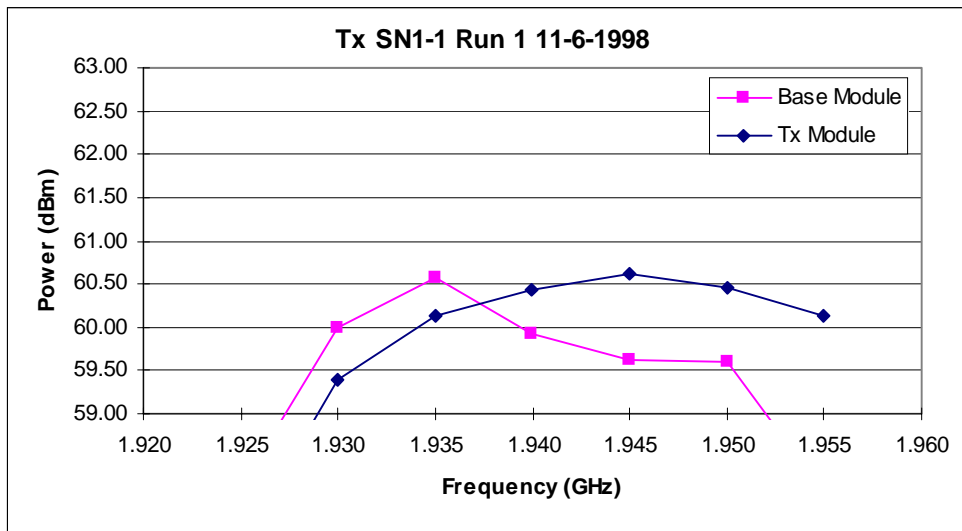

**Figure 4-5 – EIRP of the Band 1 Active Antenna (A and D Blocks)**

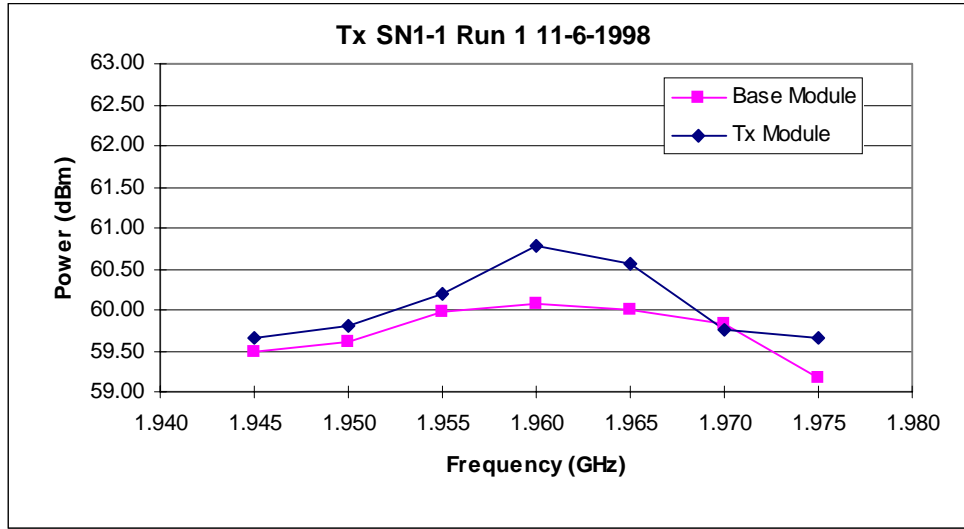

Figure 4-6 – EIRP of the Band 2 Active Antenna (B and E Blocks)

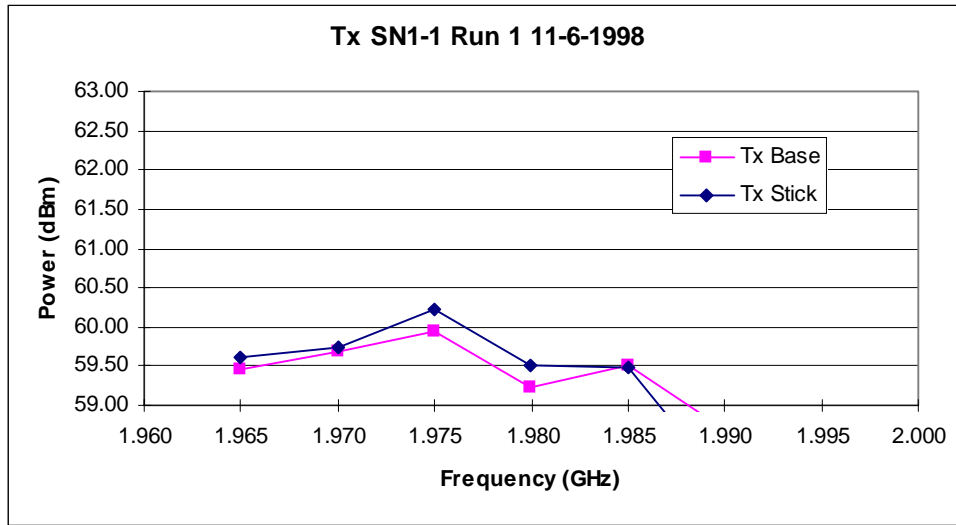

Figure 4-7 – EIRP of the Band 3 Active Antenna (C and F Blocks)

**Test Equipment List for RF Power Testing**

<b>Mfg. / Model #</b>	<b>Qty</b>	<b>Description</b>	<b>Calibration Date</b>	<b>Serial Number</b>
Gateway P5-133	1	133 MHz PC w/ HPVVE & HPIB	No Cal Req	None
HP-8508A	1	Vector Voltmeter	22 Dec 98	1209612
HP-85082A	1	2 GHz Vector Voltmeter Input Module	22 Dec 98	1292439
HP-4432A	1	Synthesized Signal Generator	10 Jan 99	1284429
HP-6274B	1	DC Power Supply	NCR	1145586
HP-EPM-441A	1	Power Meter	11 May 99	1289194
Mini Circuits 15542	1	Power Amplifier	No Cal Req	N/A
Trak 20B1601	1	Circulator	No Cal Req	N/A
Narda 4012C-30	2	Coupler, 30 dB	No Cal Req	N/A