CONTENTS

USER SECURITY INFORMATION	2
UNPACKING AND CONFIGURATION CHECK.....	3
Standard Accessories List.....	3
PREPARATION	4
Charging instructions	4
Loading/unloading lithium battery	4
Charging step.....	5
Fixed antenna	5
Fixed belt clip	5
GETTING STARTED	6
Main Function.....	6
Panel Description.....	7
LCD Display	8
Long key/Short key setting.....	9
Basic Mode of Walkie Talkie	10
BASIC OPERATION	11
Power switch/adjust the volume.....	11
frequency/channel switch.....	11
Transmit/Receive	11
MENU SETTINGS	12
Menu usage	12
Menu list.....	12
CTCSS / DCS.....	17
CTCSS List	17
DCS List.....	17
ADVANCED OPERATION	18
DTMF Signaling	18
2-Tone & 5-Tone Signaling.....	18
Digital anti-cracking.....	19
Digital service.....	19
Team up quickly	21
Frequency Measure	22

USER SECURITY INFORMATION

This walkie-talkie is a product with excellent design and advanced technology. The following suggestions will help you fulfill your warranty obligations and understand and recognize the safety of using your radio.

- Please keep the walkie-talkie and all its parts and accessories out of the reach of children.
- Please do not try to disassemble the walkie-talkie, as the handling of the walkie-talkie by non-professionals may cause damage.
- Please use the battery pack and charger provided by our company to avoid damage to the walkie-talkie.
- Please use the antenna provided by our company to avoid shortening the communication distance.
- Please do not expose the radio to the sun for a long time, or place it in an overheated place.
- Please do not place the radio in a dusty or damp place.
- Please do not use strong chemicals, cleaning agents or strong detergents to clean the walkie-talkie.
- Please do not transmit when the antenna is not installed.
- If you find that the walkie-talkie emits peculiar smell or smoke, please turn off the power of the walkie-talkie immediately and contact the dealer.

UNPACKING AND CONFIGURATION CHECK

Please carefully remove the walkie-talkie from the box. We recommend that you check the box for the items listed in the table below before discarding the packing material. If any items are lost or damaged during transportation, please confirm with the dealer.

■ Standard Accessories List

Item	No.
Radio	1
Antenna	1
8.4V Li-ion battery	1
Charger cup	1
Adaptor	1
Belt Clip	1
Manual	1

PREPARATION

■ Charging instructions

To charge the Li-ion battery pack, note:

- The battery pack is not charged at the factory, please charge it before use. After the purchase or long-term storage (more than two months), charging the battery pack for the first time does not allow the battery pack to reach its saturated usage capacity. After repeated charging and discharging two or three times, the normal charging effect and battery energy can be achieved.
- Turn off the power of the radio with the lithium battery before charging. If you use a radio that is charging, it will prevent the battery from charging properly.
- After the correct charging, if the usage time does not increase, it means that the battery pack has reached the end of its life. Please replace it with a new one.

Note:

- *Do not recharge the battery pack if it is already fully charged. Doing so may cause the life of the battery pack to shorten or the battery pack may be damaged.*
- *After Recharging the battery pack, disconnect it from the charger.*
- *Do not short the battery terminals or discard the batteries in a fire.*

■ Loading/unloading lithium battery

1. To install the lithium battery, align the battery pack with the corresponding position on the aluminum frame on the back of the walkie-talkie, then push the battery in and pull the battery pack at the end of the battery until you hear voice “kaka”.
2. When you want to unload the battery pack, please turn off the walkie-talkie first. First press the battery release button on the tail of the walkie-talkie. Push the battery back at the same time. Take the battery out in the direction.

■ Charging step

Put the charger plug into the mains 110-220V power socket first, and the charger green light.

Insert the battery pack or the transceiver with the battery pack into the charger card slot.

The red light of the charger flashes to start charging; after the full charge, the green light is on and the charging is over.

■ Fixed antenna

Hold the antenna base and screw the antenna clockwise into the connector, until transceiver is tight.

NOTE: *Please do not use the antenna as a handle. Hang the key-chain or external speaker microphone on the antenna. This will damage the antenna and reduce the performance of the transceiver.*

■ Fixed belt clip

Lock the screws in the hole of back radio.

GETTING STARTED

■ Main Function

- FM radio: 87-108MHz
- Air band 108-136MHz RX only
- 136-174MHz & 400-480MHz
- Dual band, Dual band display, dual band standby, dual band
- Double PTT
- 2 × 250 channels
- A/B channel group functions operate independently
- CTCSS/DCS
- Scrambler
- Compander
- SOS
- Noise canceling function
- VOX Function

■ Panel Description

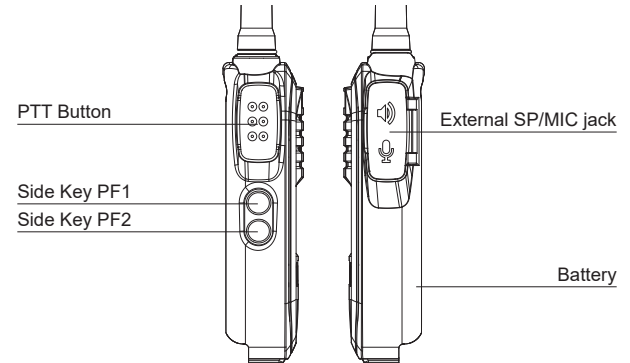
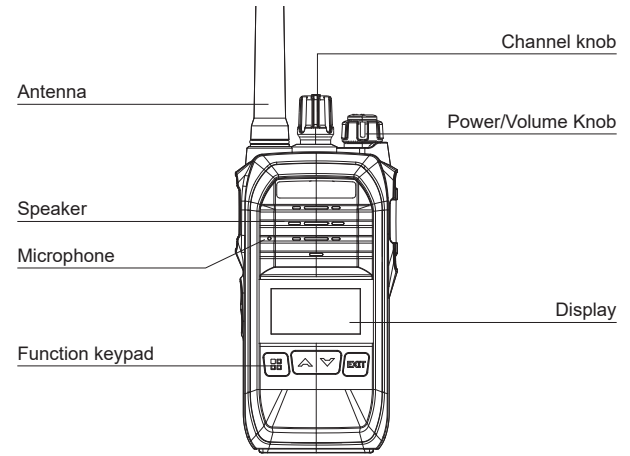

■ LCD Display



Channel Information			
H/L	High/Low Power	W/N	Wide/Narrow Band
CT/DT	CTCSS/DCS code	V	VOX
S	Scrambler	C	Compander
000	Local machine code, default 000	R	Reverse Frequency
+/-	Positive and negative frequency direction		
D0	The group to which the machine belongs, the default group is 0		
0000	Bluetooth function		
Basic parameters			
	Battery indicator		

■ Long key/Short key setting

Users can set the side buttons 2/3 as different functions of long press or short press according to their needs.

Note: You can set the long key time through the programming software, and the default is 2.0 seconds. If you press these programmed keys for longer than the set long key time, it is a long key; otherwise, it is a short key.

No.	Setting item	Function description
0	close	The key function is not defined, and the key is invalid
1	Squelch Off	Press the key programmed as the squelch cancel function to open the noise squelch; press the key again to exit this function.
3	VOX	VOX function key. The launch operation can be started by speaking, and the sound can be transmitted without pressing the PTT key. Stop talking, and the firing stops.
4	Adjust Power	Switch the transmit power of the walkie-talkie to switch between high and low power.
5	Scan	Scan function keys. Through this key, scan one by one according to the channel numbers in the scan queue. Scanning is a listening method to hear the calls of all channels.
6	Roger	Turn on/off the beep when the transmission ends
7	Screen show	Turn on/off screen display
8	Bat Power	Broadcast current high/medium/low battery
9	Alarm	When handling an emergency or calling for help when you are trapped, press the button programmed as the alarm function to emit a piercing alarm sound. To stop the alarm sound, press the PTT button.
10	Scramble	The scrambling frequency can be chosen arbitrarily for encrypted calls
11	Send 1750Hz	Send 1750Hz audio
12	Dial list	List of dial-up DTMF or 2-tone & 5-tone signaling
13	Bluetooth Switch	Open/Close Bluetooth function

No.	Setting item	Function description
14	Pairing Mode	Enter/Cancel Bluetooth pairing mode
15	Recording playback	Users record audio during a call to listen back to or archive it later
16	Weather forecast	Built-in receiver to obtain data from specialized weather channels (such as NOAA Weather Radio)

■ Basic Mode of Walkie Talkie

◇ VFO mode (frequency mode)

Press the [EXIT] key to switch options.

In this mode, you can press the [▲]/[▼] key to change the frequency of use.

◇ MR mode (frequency channel mode)

Press the [EXIT] key to switch options.

In this mode, you can press the [▲]/[▼] key to change the channel number (frequency and related data stored).

You must program at least one memory channel, otherwise you cannot enter this mode.

◇ CH mode (channel mode)

Press the [EXIT] key to switch options.

In this mode, you can press the [▲]/[▼] key to change the channel number (frequency and related data stored).

You must program at least one memory channel, otherwise you cannot enter this mode.

BASIC OPERATION

■ Power switch/adjust the volume

Rotate power switch clockwise then power on; Rotate power switch counterclockwise then power off when you hear a “click”; Rotate clockwise to increase the volume, On the contrary decrease.

■ frequency/channel switch

Press [▲]/[▼] key to select frequency and channel;







■ Transmit/Receive

Press the PTT button to transmit, then press and hold the PTT button and speak into the microphone; release the PTT button to receive;

MENU SETTINGS

■ Menu usage

The menu contains the settings of various software functions of the walkie-talkie. You can change the settings in the menu to meet your needs.

1. Press [] key to enter the menu system.
2. Press the []/[] key to select the menu item to be used.
3. Press [] key to enter menu setting.
4. You can press the []/[] key to select the content of the setting, and then press the [] key to complete the setting and return to the menu system.
5. Press [EXIT] key to exit the menu system and return to the original working mode.
 - If there is no operation for more than 10 seconds, the walkie-talkie will automatically return to the original working mode.

■ Menu list

No.	Display Characters	Secondary Menu Display Character	Secondary Menu Setting Instructions
0	FM Radio	Close/Open	Turn radio on/off
1	Power	Low Power/High Power	Low Power/High Power selection
2	Beep	Close/Open	Close/Open Beep
3	Scan	/	Scanning starts, if not in frequency mode, at least 2 channels are required to start scanning
4	VOX	Close/Open	Close/Open VOX
5	TOT	Close	Time to timer function is off;
		15s/.../270s	If the device transmission exceeds the time, will automatically turn off

No.	Display Characters	Secondary Menu Display Character	Secondary Menu Setting Instructions
6	SQL	0...9	Adjust between 0-10 levels, the level is high, the squelch is deeper.
7	Band Set	Narrow/Wide	Narrow band show"N"; wideband show"W"
8	Backlight	Close	Turn off the backlight
		Open	Turn on the backlight
		Auto 5s...Auto 60s	Set backlight timeout
9	VOX Level	Close/1/.../10	Set the voice control gain threshold
10	Scramble	Close/Open	Close/open scrambler function;
11	Compand	Close/Open	Close/open compander function;
12	Key Lock Mode	Manual	Manually lock the keyboard
		Auto 5S...Auto 30s	Lock the keyboard after setting the time, without saving the locked state
		Automatically save in 5 seconds/.../30 seconds	Lock the keyboard after setting the time and save the lock status
13	Dec-CTDCS	OFF /.../CTC-254.1	Press the [EXIT] key to select: Off, CTCSS, DCS Normal, DCS Inverted;
		DCS-D023N/.../DCS-D754I	
14	Enc-CTDCS	OFF/CTC-67.0/.../CTC-254.1	Press the [EXIT] key to toggle DCS polarity; Press the [▲] / [▼] keys to choose your desired group;
		DCS-D023N/.../DCS-D754I	
15	Step	0.05KHz/.../500K	Select from 0.05KHz to 500KHz

No.	Display Characters	Secondary Menu Display Character	Secondary Menu Setting Instructions
16	Sft	None	The transmit frequency is equal to the receive frequency;
		"-"	"The transmit frequency is equal to the current frequency minus the offset frequency;
		"+"	The transmit frequency is equal to the current frequency plus the offset frequency
17	Offset Freq	0.000-450.000MHz	The frequency difference between transmit and receive;
18	Rev Freq	Close/Open	Close/open Reverse frequency function
19	Power On Tone	Close/Tone1...Tone7	Select startup sound;
20	Scan Add/Del	Delete/Add	Delete/Add scan channels
21	Roger	Close/Open	Turn off/turn on end tone;
22	Boot Screen	Picture	Display startup image;
		Voltage	Show voltage measurement;
		Information	Show the configured information;
23	Wait Light	Close/ Open	Turn off/Turn on standby light;
24	Language	English/Chinese	Select display interface language;
25	Voice Sort	Close/Chinese/English	Select voice prompt language;
26	Channels Name	Close/open	Close/open channel name display;
27	Save Mode	Close	Close Save Mode
		1:1/1:2...1:5	1-1: Less power-saving, 1-5: More power-saving, but with longer standby delay;

No.	Display Characters	Secondary Menu Display Character	Secondary Menu Setting Instructions
28	Channels Save	/	Press [▲] / [▼] keys to select channel number. Press the menu key to confirm and save;
29	Channels Del	/	Press [▲] / [▼] keys to select channel number. Press the menu key to confirm and delete;
30	Work Mode	VFO Mode	Display VFO frequency mode of Group A
		CH-VFO Mode	Display the channel number and frequency mode of Group A;
		Channel Mode	Display the channel mode of CH-*** in Group A;
31	Bluetooth Switch	Close/Open	Close/Open Bluetooth function
32	BT SPK Gain	0,1,2,...63	
33	BTMIC Gain	0,1,...15	
34	Signal Type	None	Audio signaling usually uses audio signals of different frequencies and durations
		DTMF	
		2Tone/5Tone	
35	PTT ID Set	Close	PTT ID settings can be performed
		BOT	
		EOT	
		BOTH	
36	ANI	Close/Open	Close/open ANI.
37	PF2 Short	Close/ Squelch Off... CH Group	Set the short-press function for Side Key 2;
38	PF2 Long	Close/ Squelch Off... CH Group	Set the long-press function for Side Key 2;

No.	Display Characters	Secondary Menu Display Character	Secondary Menu Setting Instructions
39	PF3 Short	Close/ Squelch Off... CH Group	Set the short-press function for Side Key 3;
40	PF3 Long	Close/ Squelch Off... CH Group	Set the long-press function for Side Key 3;
41	Radio Name	/	Choose the device's name, pre-set the user name in the programming software;
42	Device Info	/	Display version information and last programming time;
43	Embedded information	/	
44	Reset	Config Reset	Configure mode parameters and restore full frequency to factory settings;
		Clear Channel	Delete all stored channels;
		Factory Preset	Restore to the parameters of the last programming;

CTCSS / DCS

Sometimes you may only receive calls from a specific person. CTCSS/DCS allows you not to receive call signals from other people using the same frequency. You can choose from the commonly used 50 sets of CTCSS and 105 sets of DCS

■ CTCSS List

CTCSS							
67.0	85.4	107.2	136.5	165.5	186.2	210.7	254.1
69.3	88.5	110.9	141.3	167.9	189.9	218.1	
71.9	91.5	114.8	146.2	171.3	192.8	225.7	
74.4	94.8	118.8	151.4	173.8	196.6	229.1	
77.0	97.4	123.0	156.7	177.3	199.5	233.6	
79.7	100.0	127.3	159.8	179.9	203.5	241.8	
82.5	103.5	131.8	162.2	183.5	206.5	250.3	

■ DCS List

DCS									
023	065	132	205	255	331	413	465	612	723
025	071	134	212	261	332	423	466	624	731
026	072	143	223	263	343	431	503	627	732
031	073	145	225	265	346	432	506	631	734
032	074	152	226	266	351	445	516	632	743
036	114	155	243	271	356	446	523	645	754
043	115	156	244	274	364	452	526	654	
047	116	162	245	306	365	454	532	662	
051	122	165	246	311	371	455	546	664	
053	125	172	251	315	411	462	565	703	
054	131	174	252	325	412	464	606	712	

ADVANCED OPERATION

■ DTMF Signaling

DTMF(Dual Tone Multi Frequency), Dual-tone multi-frequency is composed of a high-frequency group and a low-frequency group. The high-frequency and low-frequency groups each contain 4 frequencies. A high-frequency signal and a low-frequency signal are superimposed to form a combined signal, which represents a number. DTMF signaling has 16 codes. DTMF signaling can be used to selectively call the corresponding intercom.

◇ Select DTMF as the signaling type in the channel information

Signal Type	Signal Dec	Signal Enc	PTT ID
DTMF	16	16	Off
DTMF	16	16	Off

◇ Configure encoding, decoding and dialing lists in the DTMF service to meet customer needs.

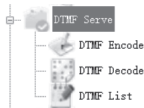

■ 2-Tone & 5-Tone Signaling

The 2-tone & 5-tone function encodes and decodes audio based on multiple different frequencies, allowing users to trigger operations and implement selective calls by sending specific 2-tone & 5-tone encodings. This is useful in situations where rapid response, coordination and emergency communications are required, such as alerts, dispatch and emergency response.

◇ Select 2-tone & 5-tone signaling as the signaling type in the channel information.

Signal Type	Signal Dec	Signal Enc	PTT ID
2-Tone&5-Tone	16	16	Off
2-Tone&5-Tone	16	16	Off

◇ Configure encoding, decoding and dialing lists in 2-tone & 5-tone services to meet customer needs.



■ Digital anti-cracking

Using the digital anti-cracking function, the anti-cracking function can be realized to avoid receiving illegal signals.

◇ Digital mode selection enabled in channel info

Power	V/M	Scan	BCL	Yes	Scramble	Str Freq	Compand	Degree	Random	Hop FFD	CR Mode	Dig Serv
High	Wide	Yes	Off	No	No		No	Off	No	Disable		Yes
High	Wide	Yes	Off	No	No		No	Off	No	Disable		Yes
High	Wide	Yes	Off	No	No		No	Off	No	Disable		Yes
High	Wide	Yes	Off	No	No		No	Off	No	Disable		Yes

In the basic configuration → configuration, set the digital encoding, and enable the digital mode at the same time.

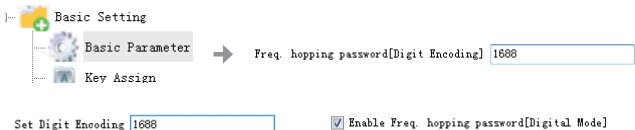

- Only the same digital code can communicate with each other, the range is 1 -- 49999, the default value is 1688.

■ Digital service

Using the digital service function, the alias display function of the walkie-talkie can be realized, and the target walkie-talkie can display the name of the originator of the call.

◇ Digital service selection in channel information

CR	Index	Hop FFD	CR Name	Dig Serve	Signal Type	Signal Dec	Signal Enc	PTT ID	Speaker Name
1-A	No	Disable		Yes	None	16	16	00E	QT/NOT
2-A	No	Disable		Yes	None	16	16	00E	QT/NOT
3-A	No	Disable		Yes	None	16	16	00E	QT/NOT
4-A	No	Disable		Yes	None	16	16	00E	QT/NOT
5-A									

In Digital Configuration, tick Enable Digital Services and Display Speaker Name.

Enable Digit Serve

Display Speaker Name

Radio Group 00—Group 0 Group 0

Radio Name T-360 UV

Radio ID 000—T-360 UV 000

Speech Encryption[1000-8999] 4321

Group Name	
No.	Group Name
▶ Group 0	Group 0
Group 1	Group 1
Group 2	Group 2
Group 3	Group 3
Group 4	Group 4
Group 5	Group 5
Group 6	Group 6
Group 7	Group 7
Group 8	Group 8
Group 9	Group 9
Privileged	Priority G

User Name	
No.	User Name
▶ User 0	T-360 UV
User 1	User 1
User 2	User 2
User 3	User 3
User 4	User 4
User 5	User 5
User 6	User 6
User 7	User 7
User 8	User 8
User 9	User 9
User 10	User 10

- The group this machine belongs to: Only those who are set to the same group can talk to each other.
- Local name: After setting, the receiving party can display the name of the calling party.
- Voice encryption password: you can set 0001--8999, only the same password can be used for intercom.

■ Team up quickly

When a user initiates team transmission on the walkie-talkie and other users enter the fast team receiver, multiple walkie-talkie devices can be quickly synchronized on one channel, which brings great convenience when multiple people travel in teams.

◇ Quickly team up

Receiver

1. Enter the menu "Team R".
2. Press [] key to enter team receiving, and the interface will display "quick team receiving".

Transmitter

1. Enter the menu "Team T".
2. Press the [] key to enter the team launch, and the interface will display "Quick Team Initiator".
3. At this point, it will enter the communication mode of fast team formation, and the process will take about 2 minutes.

After the communication is completed, the transmitter will exit the transmitting state, and the receiver will restart. At this time, the members of the same group can talk to each other.

■ Frequency Measure

This radio has the function of frequency measurement and decoding, which can be used to quickly communicate with other walkie-talkies.

◇ Frequency Measure Function Operation Method

1. Enter the menu “frequency measure “
2. Press the [] key to enter, and the screen will display “Measuring frequency”
3. Press and hold the PTT key of the radio under test to transmit, and then approach the radio
4. When the frequency measurement is completed, it will broadcast the success of the frequency measurement. At this time, the screen will display the frequency and store it in the channel.
5. You can press the [▲]/[▼] key to switch channels and enter the next frequency measurement.
6. Press [EXIT] key to exit the frequency measurement function and return to the original working mode.

This device complies with part 15 of the FCC Rules. Operation is subject to the following two conditions:

- (1) This device may not cause harmful interference, and
- (2) this device must accept any interference including received interference that may cause undesired operation.

The grantee is not responsible for any changes or modifications not expressly approved by the party responsible for compliance. Such modifications could void the user's authority to operate the equipment.

Replacement of any transmitter component (crystal, semiconductor, etc.) not authorized by the FCC equipment authorization for this radio could violate FCC rules.

WARNING: MODIFICATION OF THIS DEVICE TO RECEIVE CELLULAR RADIOTELEPHONE SERVICE SIGNALS IS PROHIBITED UNDER FCC RULES AND FEDERAL LAW.

Note: This equipment has been tested and found to comply with the limits for a Class B digital device, pursuant to part 15 of the FCC Rules. These limits are designed to provide reasonable protection against harmful interference in a residential installation.

This equipment generates, uses, and can radiate radio frequency energy and, if not installed and used in accordance with the instructions, may cause harmful interference to radio communications. However, there is no guarantee that interference will not occur in a particular installation.

If this equipment does cause harmful interference to radio or television reception, which can be determined by turning the equipment off and on, the user is encouraged to try to correct the interference by one or more of the following measures:

- Reorient or relocate the receiving antenna.
- Increase the separation between the equipment and receiver.
- Connect the equipment into an outlet on a circuit different from that to which the receiver is connected.
- Consult the dealer or an experienced radio/TV technician for help.

This radio complies with IEEE and ICNIRP exposure limits for occupational/controlled RF exposure environment at operating duty factors of up to 50% and is authorized by the FCC for Occupational Use Only. An appropriate warning label is affixed to all units. In order to comply with RF exposure requirements, a minimum distance of 2.5cm must be maintained when held-to-face, and body-worn operations are restricted to the approved original accessories (belt clip), a minimum distance of 0 cm. Do not use this device when antenna shows obvious damages.