

FCC Test Report

Report No.: RF170706C19-1

FCC ID: NM8X2-HT

Test Model: X2-HT

Received Date: Jul. 06, 2017

Test Date: Jul. 19, 2017 ~ Aug. 28, 2017

Issued Date: Sep. 20, 2017

Applicant: HTC Corporation

Address: No.23 Xinghua Road, Taoyuan District, Taoyuan City 330, Taiwan

Issued By: Bureau Veritas Consumer Products Services (H.K.) Ltd., Taoyuan Branch

Lab Address: No. 47-2, 14th Ling, Chia Pau Vil., Lin Kou Dist., New Taipei City, Taiwan
(R.O.C)

Test Location (1): No. 19, Hwa Ya 2nd Rd, Wen Hwa Tsuen, Kwei Shan Hsiang, Taoyuan
Hsien 333, Taiwan, R.O.C.

Test Location (2): No.215, Sec. 3, Beixin Rd., Xindian Dist., New Taipei City 231, Taiwan,
R.O.C



This report is for your exclusive use. Any copying or replication of this report to or for any other person or entity, or use of our name or trademark, is permitted only with our prior written permission. This report sets forth our findings solely with respect to the test samples identified herein. The results set forth in this report are not indicative or representative of the quality or characteristics of the lot from which a test sample was taken or any similar or identical product unless specifically and expressly noted. Our report includes all of the tests requested by you and the results thereof based upon the information that you provided to us. You have 60 days from date of issuance of this report to notify us of any material error or omission caused by our negligence, provided, however, that such notice shall be in writing and shall specifically address the issue you wish to raise. A failure to raise such issue within the prescribed time shall constitute your unqualified acceptance of the completeness of this report, the tests conducted and the correctness of the report contents. Unless specifically mentioned, the uncertainty of measurement has been explicitly taken into account to declare the compliance or non-compliance to the specification.

Table of Contents

| | |
|--|-----------|
| Release Control Record | 4 |
| 1 Certificate of Conformity | 5 |
| 2 Summary of Test Results | 6 |
| 2.1 Measurement Uncertainty | 6 |
| 2.2 Modification Record | 6 |
| 3 General Information | 7 |
| 3.1 General Description of EUT | 7 |
| 3.2 Description of Test Modes | 8 |
| 3.2.1 Test Mode Applicability and Tested Channel Detail | 9 |
| 3.3 Duty Cycle of Test Signal | 11 |
| 3.4 Description of Support Units | 12 |
| 3.4.1 Configuration of System under Test | 12 |
| 3.5 General Description of Applied Standards | 12 |
| 4 Test Types and Results | 13 |
| 4.1 Radiated Emission and Bandedge Measurement | 13 |
| 4.1.1 Limits of Radiated Emission and Bandedge Measurement | 13 |
| 4.1.2 Test Instruments | 14 |
| 4.1.3 Test Procedures | 15 |
| 4.1.4 Deviation from Test Standard | 15 |
| 4.1.5 Test Set Up | 16 |
| 4.1.6 EUT Operating Conditions | 16 |
| 4.1.7 Test Results | 17 |
| 4.2 Conducted Emission Measurement | 29 |
| 4.2.1 Limits of Conducted Emission Measurement | 29 |
| 4.2.2 Test Instruments | 29 |
| 4.2.3 Test Procedures | 29 |
| 4.2.4 Deviation from Test Standard | 29 |
| 4.2.5 TEST SETUP | 30 |
| 4.2.6 EUT Operating Conditions | 30 |
| 4.2.7 Test Results | 31 |
| 4.3 6 dB Bandwidth Measurement | 39 |
| 4.3.1 Limits of 6 dB Bandwidth Measurement | 39 |
| 4.3.2 Test Setup | 39 |
| 4.3.3 Test Instruments | 39 |
| 4.3.4 Test Procedure | 39 |
| 4.3.5 Deviation from Test Standard | 39 |
| 4.3.6 EUT Operating Conditions | 39 |
| 4.3.7 Test Result | 40 |
| 4.4 Occupied Bandwidth Measurement | 42 |
| 4.4.1 Test SetUp | 42 |
| 4.4.2 Test Instruments | 42 |
| 4.4.3 Test Procedure | 42 |
| 4.4.4 Deviation From Test Standard | 42 |
| 4.4.5 EUT Operating Conditions | 42 |
| 4.4.6 Test Results | 43 |
| 4.5 Conducted Output Power Measurement | 45 |
| 4.5.1 Limits of Conducted Output Power Measurement | 45 |
| 4.5.2 Test Setup | 45 |
| 4.5.3 Test Instruments | 45 |
| 4.5.4 Test Procedures | 45 |
| 4.5.5 Deviation from Test Standard | 45 |
| 4.5.6 EUT Operating Conditions | 45 |
| 4.5.7 Test Results | 46 |

| | | |
|----------|---|-----------|
| 4.6 | Power Spectral Density Measurement | 47 |
| 4.6.1 | Limits of Power Spectral Density Measurement..... | 47 |
| 4.6.2 | Test Setup..... | 47 |
| 4.6.3 | Test Instruments | 47 |
| 4.6.4 | Test Procedure | 47 |
| 4.6.5 | Deviation from Test Standard | 47 |
| 4.6.6 | EUT Operating Condition | 47 |
| 4.6.7 | Test Results | 48 |
| 4.7 | Conducted Out of Band Emission Measurement | 50 |
| 4.7.1 | Limits of Conducted Out of Band Emission Measurement..... | 50 |
| 4.7.2 | Test Setup..... | 50 |
| 4.7.3 | Test Instruments | 50 |
| 4.7.4 | Test Procedure | 50 |
| 4.7.5 | Deviation from Test Standard | 50 |
| 4.7.6 | EUT Operating Condition | 50 |
| 4.7.7 | TEST RESULTS | 51 |
| 5 | Pictures of Test Arrangements..... | 55 |
| | Appendix – Information on the Testing Laboratories | 56 |

Release Control Record

| Issue No. | Description | Date Issued |
|---------------|------------------|---------------|
| RF170706C19-1 | Original Release | Sep. 20, 2017 |

1 Certificate of Conformity

Product: Smartphone
Brand: HTC
Test Model: X2-HT
Sample Status: Production Unit
Applicant: HTC Corporation
Test Date: Jul. 19, 2017 ~ Aug. 28, 2017
Standards: 47 CFR FCC Part 15, Subpart C (Section 15.247)
ANSI C63.10:2013

The above equipment has been tested by **Bureau Veritas Consumer Products Services (H.K.) Ltd., Taoyuan Branch**, and found compliance with the requirement of the above standards. The test record, data evaluation & Equipment Under Test (EUT) configurations represented herein are true and accurate accounts of the measurements of the sample's EMC characteristics under the conditions specified in this report.

Prepared by :  , **Date:** Sep. 20, 2017
Ivonne Wu / Supervisor

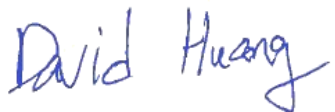
Approved by :  , **Date:** Sep. 20, 2017
David Huang / Project Engineer

2 Summary of Test Results

| 47 CFR FCC Part 15, Subpart C (Section 15.247) | | | |
|--|--------------------------------|--------|--|
| FCC Clause | Test Item | Result | Remarks |
| 15.207 | AC Power Conducted Emission | Pass | Meet the requirement of limit. Minimum passing margin is -10.90 dB at 13.48310 MHz. |
| 15.205 & 209 | Radiated Emissions | Pass | Meet the requirement of limit. Minimum passing margin is -12.72 dB at 2496.44 MHz. |
| 15.247(d) | Band Edge Measurement | Pass | Meet the requirement of limit. |
| 15.247(d) | Antenna Port Emission | Pass | Meet the requirement of limit. |
| 15.247(a)(2) | 6 dB Bandwidth | Pass | Meet the requirement of limit. |
| --- | Occupied Bandwidth Measurement | Pass | Reference only |
| 15.247(b) | Conducted power | Pass | Meet the requirement of limit. |
| 15.247(e) | Power Spectral Density | Pass | Meet the requirement of limit. |
| 15.203 | Antenna Requirement | Pass | No antenna connector is used. |

2.1 Measurement Uncertainty

Where relevant, the following measurement uncertainty levels have been estimated for tests performed on the EUT:

The listed uncertainties are the worst case uncertainty for the entire range of measurement. Please note that the uncertainty values are provided for informational purposes only and are not used in determining the PASS/FAIL results.

| Measurement | Frequency | Expanded Uncertainty (k=2) (\pm) |
|------------------------------------|--------------------|--------------------------------------|
| Conducted Emissions at mains ports | 150 kHz ~ 30 MHz | 2.44 dB |
| Radiated Emissions up to 1 GHz | 30 MHz ~ 200 MHz | 2.0153 dB |
| | 200 MHz ~ 1000 MHz | 2.0224 dB |
| Radiated Emissions above 1 GHz | 1 GHz ~ 18 GHz | 1.0121 dB |
| | 18 GHz ~ 40 GHz | 1.1508 dB |

2.2 Modification Record

There were no modifications required for compliance.

3 General Information

3.1 General Description of EUT

| | |
|----------------------------|---|
| Product | Smartphone |
| Brand | HTC |
| Test Model | X2-HT |
| Status of EUT | Production Unit |
| Power Supply Rating | 5 Vdc or 9 Vdc or 12 Vdc (adapter) 3.85 Vdc (Li-ion battery) |
| Modulation Type | GFSK |
| Transfer Rate | LE 4.0: 1 Mbps LE 5.0: 2 Mbps |
| Operating Frequency | 2402 ~ 2480 MHz |
| Number of Channel | 40 |
| Output Power | LE 4.0: 2.642 Mw LE 5.0: 2.805 mW |
| Antenna Type | PIFA antenna with -2.1 dBi gain |
| Antenna Connector | N/A |
| Accessory Device | Refer to Note as below |
| Data Cable Supplied | Refer to Note as below |

Note:

1. There're 2 configurations for the EUT listed as below.
 Main Sample: EUT + Battery 1
 2nd Sample: EUT + Battery 2
 ✧ Only the worst test data was presented in the report.
2. The EUT's accessories list refers to Ext. Pho.
3. The above EUT information is declared by manufacturer and for more detailed features description, please refer to the manufacturer's specifications or User's Manual.

3.2 Description of Test Modes

40 channels are provided to this EUT:

| Channel | Freq. (MHz) | Channel | Freq. (MHz) | Channel | Freq. (MHz) | Channel | Freq. (MHz) |
|---------|-------------|---------|-------------|---------|-------------|---------|-------------|
| 0 | 2402 | 10 | 2422 | 20 | 2442 | 30 | 2462 |
| 1 | 2404 | 11 | 2424 | 21 | 2444 | 31 | 2464 |
| 2 | 2406 | 12 | 2426 | 22 | 2446 | 32 | 2466 |
| 3 | 2408 | 13 | 2428 | 23 | 2448 | 33 | 2468 |
| 4 | 2410 | 14 | 2430 | 24 | 2450 | 34 | 2470 |
| 5 | 2412 | 15 | 2432 | 25 | 2452 | 35 | 2472 |
| 6 | 2414 | 16 | 2434 | 26 | 2454 | 36 | 2474 |
| 7 | 2416 | 17 | 2436 | 27 | 2456 | 37 | 2476 |
| 8 | 2418 | 18 | 2438 | 28 | 2458 | 38 | 2478 |
| 9 | 2420 | 19 | 2440 | 29 | 2460 | 39 | 2480 |

3.2.1 Test Mode Applicability and Tested Channel Detail

<LE 4.0>

| EUT Configure Mode | Applicable To | | | | Description |
|--------------------|---------------|-------|-----|------|------------------------|
| | RE≥1G | RE<1G | PLC | APCM | |
| A | √ | √ | √ | √ | Main Sample |
| B | √ | √ | √ | - | 2 nd Sample |

Where **RE≥1G**: Radiated Emission above 1 GHz **RE<1G**: Radiated Emission below 1 GHz
PLC: Power Line Conducted Emission **APCM**: Antenna Port Conducted Measurement

Note: The EUT had been pre-tested on the positioned of each 3 axis. The worst case was found when positioned on **Y-plane**.

Note: "-" means no effect.

Radiated Emission Test (Above 1 GHz):

- Pre-Scan has been conducted to determine the worst-case mode from all possible combinations between available modulations, data rates and antenna ports (if EUT with antenna diversity architecture).
- Following channel(s) was (were) selected for the final test as listed below.

| EUT Configure Mode | Available Channel | Tested Channel | Modulation Type | Data Rate (Mbps) |
|--------------------|-------------------|----------------|-----------------|------------------|
| A | 0 to 39 | 0, 19, 39 | GFSK | 1 |
| B | 0 to 39 | 39 | GFSK | 1 |

Radiated Emission Test (Below 1 GHz):

- Pre-Scan has been conducted to determine the worst-case mode from all possible combinations between available modulations, data rates and antenna ports (if EUT with antenna diversity architecture).
- Following channel(s) was (were) selected for the final test as listed below.

| EUT Configure Mode | Available Channel | Tested Channel | Modulation Type | Data Rate (Mbps) |
|--------------------|-------------------|----------------|-----------------|------------------|
| A, B | 0 to 39 | 39 | GFSK | 1 |

Power Line Conducted Emission Test:

- Pre-Scan has been conducted to determine the worst-case mode from all possible combinations between available modulations, data rates and antenna ports (if EUT with antenna diversity architecture).
- Following channel(s) was (were) selected for the final test as listed below.

| EUT Configure Mode | Available Channel | Tested Channel | Modulation Type | Data Rate (Mbps) |
|--------------------|-------------------|----------------|-----------------|------------------|
| A, B | 0 to 39 | 39 | GFSK | 1 |

Antenna Port Conducted Measurement:

- This item includes all test value of each mode, but only includes spectrum plot of worst value of each mode.
- Pre-Scan has been conducted to determine the worst-case mode from all possible combinations between available modulations, data rates and antenna ports (if EUT with antenna diversity architecture).
- Following channel(s) was (were) selected for the final test as listed below.

| EUT Configure Mode | Available Channel | Tested Channel | Modulation Type | Data Rate (Mbps) |
|--------------------|-------------------|----------------|-----------------|------------------|
| A | 0 to 39 | 0, 19, 39 | GFSK | 1 |

<LE 5.0>

| EUT Configure Mode | Applicable To | | | | Description |
|--------------------|---------------|-------|-----|------|------------------------|
| | RE≥1G | RE<1G | PLC | APCM | |
| A | √ | √ | √ | √ | Main Sample |
| B | √ | √ | √ | - | 2 nd Sample |

Where **RE≥1G**: Radiated Emission above 1 GHz **RE<1G**: Radiated Emission below 1 GHz
PLC: Power Line Conducted Emission **APCM**: Antenna Port Conducted Measurement

Note: The EUT had been pre-tested on the positioned of each 3 axis. The worst case was found when positioned on **Y-plane**.
Note: "-" means no effect.

Radiated Emission Test (Above 1 GHz):

- Pre-Scan has been conducted to determine the worst-case mode from all possible combinations between available modulations, data rates and antenna ports (if EUT with antenna diversity architecture).
- Following channel(s) was (were) selected for the final test as listed below.

| EUT Configure Mode | Available Channel | Tested Channel | Modulation Type | Data Rate (Mbps) |
|--------------------|-------------------|----------------|-----------------|------------------|
| A | 0 to 39 | 0, 19, 39 | GFSK | 1 |
| B | 0 to 39 | 19 | GFSK | 1 |

Radiated Emission Test (Below 1 GHz):

- Pre-Scan has been conducted to determine the worst-case mode from all possible combinations between available modulations, data rates and antenna ports (if EUT with antenna diversity architecture).
- Following channel(s) was (were) selected for the final test as listed below.

| EUT Configure Mode | Available Channel | Tested Channel | Modulation Type | Data Rate (Mbps) |
|--------------------|-------------------|----------------|-----------------|------------------|
| A, B | 0 to 39 | 19 | GFSK | 1 |

Power Line Conducted Emission Test:

- Pre-Scan has been conducted to determine the worst-case mode from all possible combinations between available modulations, data rates and antenna ports (if EUT with antenna diversity architecture).
- Following channel(s) was (were) selected for the final test as listed below.

| EUT Configure Mode | Available Channel | Tested Channel | Modulation Type | Data Rate (Mbps) |
|--------------------|-------------------|----------------|-----------------|------------------|
| A, B | 0 to 39 | 19 | GFSK | 1 |

Antenna Port Conducted Measurement:

- This item includes all test value of each mode, but only includes spectrum plot of worst value of each mode.
- Pre-Scan has been conducted to determine the worst-case mode from all possible combinations between available modulations, data rates and antenna ports (if EUT with antenna diversity architecture).
- Following channel(s) was (were) selected for the final test as listed below.

| EUT Configure Mode | Available Channel | Tested Channel | Modulation Type | Data Rate (Mbps) |
|--------------------|-------------------|----------------|-----------------|------------------|
| A | 0 to 39 | 0, 19, 39 | GFSK | 1 |

Test Condition:

| Applicable To | Environmental Conditions | Input Power | Tested by |
|---------------|--------------------------|----------------|------------------------|
| RE≥1G | 25 deg. C, 65 % RH | 120 Vac, 60 Hz | Harry Hsueh & Karl Lee |
| RE<1G | 25 deg. C, 65 % RH | 120 Vac, 60 Hz | Harry Hsueh & Karl Lee |
| PLC | 25 deg. C, 65 % RH | 120 Vac, 60 Hz | Getaz Yang |
| APCM | 25 deg. C, 65 % RH | 3.85 Vdc | Anson Lin |

3.3 Duty Cycle of Test Signal

<LE 4.0>

Duty cycle of test signal is < 98 %

Duty cycle = $394.23/629.81 = 0.626$, Duty factor = $10 * \log(1/0.626) = 2.03$

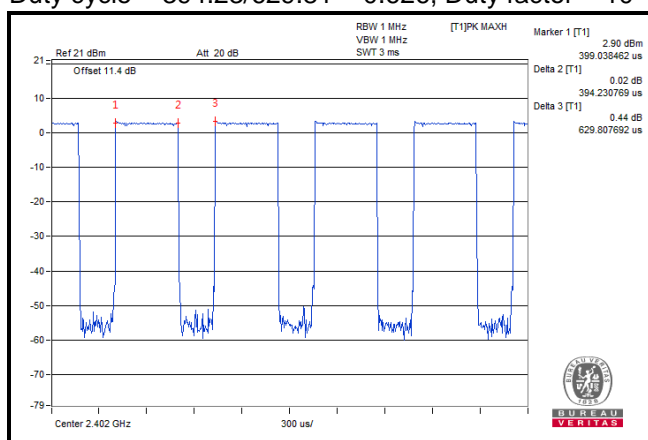

<LE 5.0>

Duty cycle of test signal is < 98 %

Duty cycle = $205.13/628.21 = 0.327$, Duty factor = $10 * \log(1/0.327) = 4.85$

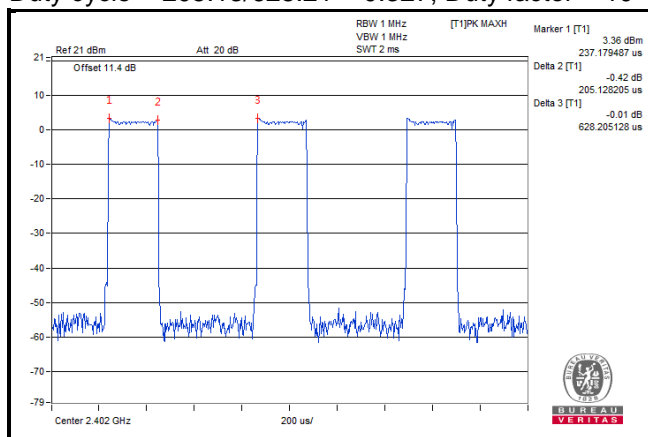

3.4 Description of Support Units

The EUT has been tested as an independent unit together with other necessary accessories or support units.

3.4.1 Configuration of System under Test

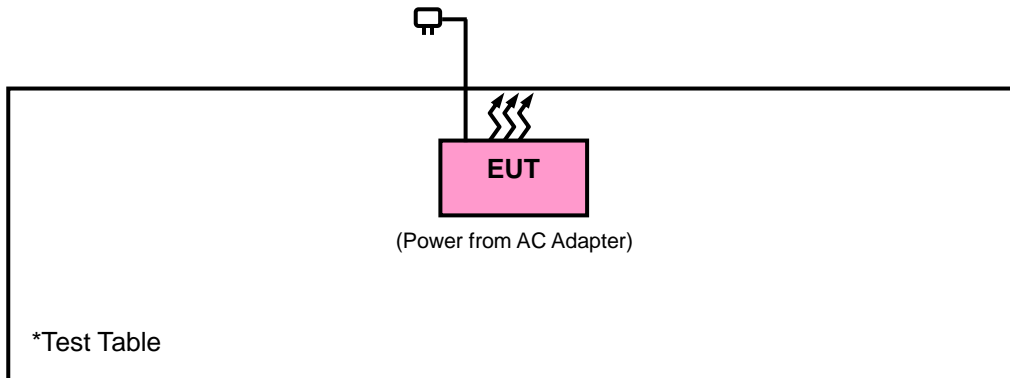

3.5 General Description of Applied Standards

The EUT is a RF Product. According to the specifications of the manufacturer, it must comply with the requirements of the following standards:

FCC Part 15, Subpart C (15.247)

558074 D01 DTS Meas Guidance v04

ANSI C63.10-2013

All test items have been performed and recorded as per the above standards.

Note: The EUT has been verified to comply with the requirements of FCC Part 15, Subpart B, Class B (DoC).
The test report has been issued separately.

4 Test Types and Results

4.1 Radiated Emission and Bandedge Measurement

4.1.1 Limits of Radiated Emission and Bandedge Measurement

Radiated emissions which fall in the restricted bands must comply with the radiated emission limits specified as below table. Other emissions shall be at least 20 dB below the highest level of the desired power:

| Frequencies (MHz) | Field Strength (microvolts/meter) | Measurement Distance (meters) |
|-------------------|-----------------------------------|-------------------------------|
| 0.009 ~ 0.490 | 2400/F (kHz) | 300 |
| 0.490 ~ 1.705 | 24000/F (kHz) | 30 |
| 1.705 ~ 30.0 | 30 | 30 |
| 30 ~ 88 | 100 | 3 |
| 88 ~ 216 | 150 | 3 |
| 216 ~ 960 | 200 | 3 |
| Above 960 | 500 | 3 |

Note:

1. The lower limit shall apply at the transition frequencies.
2. Emission level (dBuV/m) = 20 log Emission level (uV/m).
3. For frequencies above 1000 MHz, the field strength limits are based on average detector, however, the peak field strength of any emission shall not exceed the maximum permitted average limits, specified above by more than 20 dB under any condition of modulation.

4.1.2 Test Instruments

| Description & Manufacturer | Model No. | Serial No. | Date of Calibration | Due Date of Calibration |
|--|-----------------|---|---------------------|-------------------------|
| Test Receiver Agilent Technologies | N9038A | MY52260177 | Jul. 05, 2017 | Jul. 04, 2018 |
| Spectrum Analyzer ROHDE & SCHWARZ | FSU43 | 101261 | Dec. 13, 2016 | Dec. 12, 2017 |
| BILOG Antenna SCHWARZBECK | VULB9168 | 9168-472 | Dec. 16, 2016 | Dec. 15, 2017 |
| HORN Antenna ETS-Lindgren | 3117 | 00143293 | Dec. 29, 2016 | Dec. 28, 2017 |
| HORN Antenna SCHWARZBECK | BBHA 9170 | 9170-480 | Dec. 14, 2016 | Dec. 13, 2017 |
| Fixed Attenuator Mini-Circuits | BW-N10W5+ | NA | Jul. 07, 2017 | Jul. 06, 2018 |
| Bluetooth Tester | CBT | 100980 | Jun. 28, 2017 | Jun. 27, 2019 |
| Loop Antenna | HLA 6121 | 45745 | May 19, 2017 | May 18, 2018 |
| Preamplifier Agilent | 310N | 187226 | Jun. 23, 2017 | Jun. 22, 2018 |
| Preamplifier Agilent | 83017A | MY39501357 | Jun. 23, 2017 | Jun. 22, 2018 |
| Power Meter Anritsu | ML2495A | 1232002 | Sep. 08, 2016 | Sep. 07, 2017 |
| Power Sensor Anritsu | MA2411B | 1207325 | Sep. 08, 2016 | Sep. 07, 2017 |
| RF signal cable ETS-LINDGREN | 5D-FB | Cable-CH1-01(R FC-SMS-100-SM S-120+RFC-SMS -100-SMS-400) | Jun. 23, 2017 | Jun. 22, 2018 |
| RF signal cable ETS-LINDGREN | 8D-FB | Cable-CH1-02(R FC-SMS-100-SM S-24) | Jun. 23, 2017 | Jun. 22, 2018 |
| Software BV ADT | E3 8.130425b | NA | NA | NA |
| Antenna Tower MF | NA | NA | NA | NA |
| Turn Table MF | NA | NA | NA | NA |
| Antenna Tower & Turn Table Controller MF | MF-7802 | NA | NA | NA |

- Note: 1. The calibration interval of the above test instruments is 12 months and the calibrations are traceable to NML/ROC and NIST/USA.
2. The test was performed in HsinTien Chamber 1.
3. The horn antenna and preamplifier (model: 83017A) are used only for the measurement of emission frequency above 1GHz if tested.
4. The FCC Designation Number is TW0011. The number will be varied with the Lab location and scope as attached.
5. The IC Site Registration No. is IC7450I-1.

4.1.3 Test Procedures

- a. The EUT was placed on the top of a rotating table 0.8 meters (for below 1 GHz) / 1.5 meters (for above 1 GHz) above the ground at 3 meter chamber room for test. The table was rotated 360 degrees to determine the position of the highest radiation.
- b. The EUT was set 3 meters away from the interference-receiving antenna, which was mounted on the top of a variable-height antenna tower.
- c. The height of antenna is varied from one meter to four meters above the ground to determine the maximum value of the field strength. Both horizontal and vertical polarizations of the antenna are set to make the measurement.
- d. For each suspected emission, the EUT was arranged to its worst case and then the antenna was tuned to heights from 1 meter to 4 meters and the rotatable table was turned from 0 degrees to 360 degrees to find the maximum reading.
- e. The test-receiver system was set to quasi-peak detect function and specified bandwidth with maximum hold mode when the test frequency is below 1 GHz.
- f. The test-receiver system was set to peak and average detected function and specified bandwidth with maximum hold mode when the test frequency is above 1 GHz. If the peak reading value also meets average limit, measurement with the average detector is unnecessary.

Note:

1. The resolution bandwidth and video bandwidth of test receiver/spectrum analyzer is 120 kHz & 360 kHz for Quasi-peak detection (QP) at frequency below 1 GHz.
2. The resolution bandwidth of test receiver/spectrum analyzer is 1 MHz and the video bandwidth is 3 MHz for Peak detection (PK) at frequency above 1 GHz.
3. The resolution bandwidth of test receiver/spectrum analyzer is 1 MHz and the video bandwidth is 1/T for Average (Duty cycle < 98 %) detection at frequency above 1 GHz.
4. The resolution bandwidth of test receiver/spectrum analyzer is 1 MHz and the video bandwidth is 10 Hz (Duty cycle ≥ 98 %) for Average detection (AV) at frequency above 1 GHz.
5. All modes of operation were investigated and the worst-case emissions are reported.

4.1.4 Deviation from Test Standard

No deviation.

4.1.5 Test Set Up

<Frequency Range below 1 GHz>

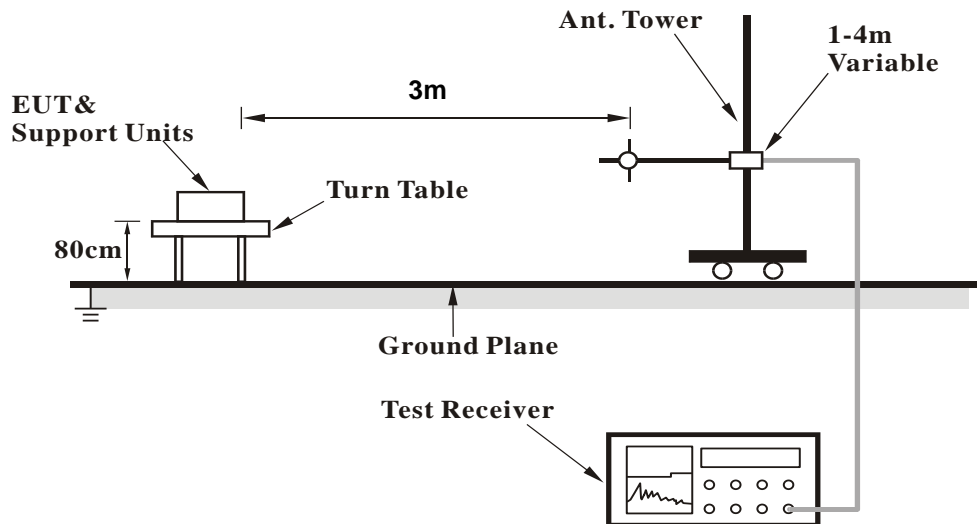

<Frequency Range above 1 GHz>

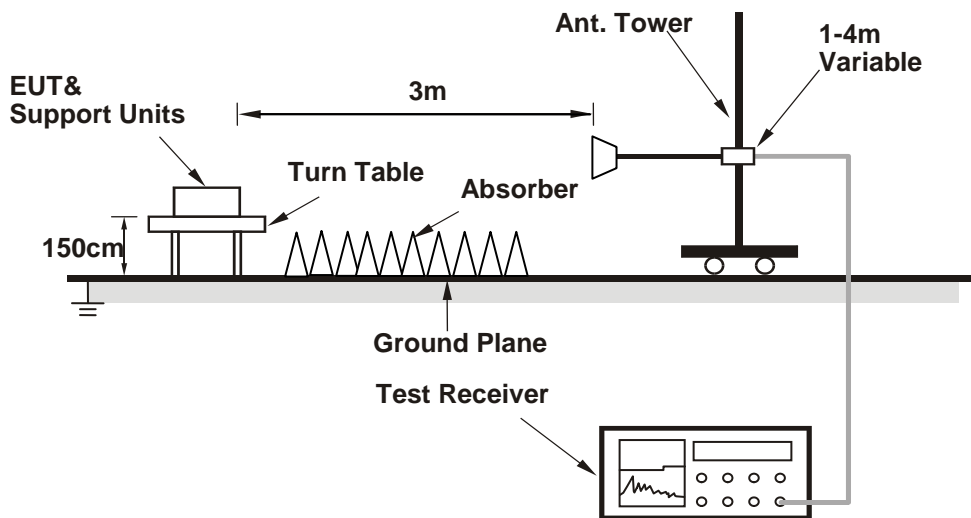

For the actual test configuration, please refer to the attached file (Test Setup Photo).

4.1.6 EUT Operating Conditions

- Placed the EUT on the testing table.
- Set the EUT under transmission condition continuously at specific channel frequency.

4.1.7 Test Results

<LE 4.0>

ABOVE 1 GHz DATA :

Mode A

| EUT Test Condition | | Measurement Detail | |
|--------------------------|--------------------|--------------------|---------------------------|
| Channel | Channel 0 | Frequency Range | 1 GHz ~ 25 GHz |
| Input Power | 120 Vac, 60 Hz | Detector Function | Peak (PK) Average (AV) |
| Environmental Conditions | 25 deg. C, 65 % RH | Tested By | Harry Hsueh & Karl Lee |

| Antennal Polarity & Test Distance: Horizontal at 3 m | | | | | | | | | | |
|--|-------------------------|-------------------|----------------|-------------|-----------------------|-----------------|--------------------|---------------------|----------------------|---------|
| Frequency (MHz) | Emission Level (dBuV/m) | Read Level (dBuV) | Limit (dBuV/m) | Margin (dB) | Antenna Factor (dB/m) | Cable Loss (dB) | Preamp Factor (dB) | Antenna Height (cm) | Table Angle (Degree) | Remark |
| 2382.81 | 40.62 | 38.93 | 54 | -13.38 | 31.78 | 5.4 | 35.49 | 169 | 189 | Average |
| 2382.81 | 51.44 | 49.75 | 74 | -22.56 | 31.78 | 5.4 | 35.49 | 169 | 189 | Peak |
| 2402 | 93.52 | 91.79 | | | 31.8 | 5.4 | 35.47 | 169 | 189 | Average |
| 2402 | 95.25 | 93.52 | | | 31.8 | 5.4 | 35.47 | 169 | 189 | Peak |
| 4804 | 38.62 | 30.53 | 54 | -15.38 | 33.96 | 8.25 | 34.12 | 163 | 225 | Average |
| 4804 | 47.49 | 39.4 | 74 | -26.51 | 33.96 | 8.25 | 34.12 | 163 | 225 | Peak |
| Antennal Polarity & Test Distance: Vertical at 3 m | | | | | | | | | | |
| Frequency (MHz) | Emission Level (dBuV/m) | Read Level (dBuV) | Limit (dBuV/m) | Margin (dB) | Antenna Factor (dB/m) | Cable Loss (dB) | Preamp Factor (dB) | Antenna Height (cm) | Table Angle (Degree) | Remark |
| 2385.6 | 40.53 | 38.82 | 54 | -13.47 | 31.8 | 5.4 | 35.49 | 100 | 230 | Average |
| 2385.6 | 51.55 | 49.84 | 74 | -22.45 | 31.8 | 5.4 | 35.49 | 100 | 230 | Peak |
| 2402 | 93.45 | 91.72 | | | 31.8 | 5.4 | 35.47 | 100 | 230 | Average |
| 2402 | 95.89 | 94.16 | | | 31.8 | 5.4 | 35.47 | 100 | 230 | Peak |
| 4804 | 38.93 | 30.84 | 54 | -15.07 | 33.96 | 8.25 | 34.12 | 121 | 184 | Average |
| 4804 | 48.19 | 40.1 | 74 | -25.81 | 33.96 | 8.25 | 34.12 | 121 | 184 | Peak |

Remarks:

- Emission Level = Read Level + Antenna Factor + Cable Loss - Preamp Factor
Margin value = Emission level – Limit value
- 2402 MHz: Fundamental frequency.

| EUT Test Condition | | Measurement Detail | |
|--------------------------|--------------------|--------------------|---------------------------|
| Channel | Channel 19 | Frequency Range | 1 GHz ~ 25 GHz |
| Input Power | 120 Vac, 60 Hz | Detector Function | Peak (PK) Average (AV) |
| Environmental Conditions | 25 deg. C, 65 % RH | Tested By | Harry Hsueh & Karl Lee |

| Antennal Polarity & Test Distance: Horizontal at 3 m | | | | | | | | | | |
|--|-------------------------|-------------------|----------------|-------------|-----------------------|-----------------|--------------------|---------------------|----------------------|---------|
| Frequency (MHz) | Emission Level (dBuV/m) | Read Level (dBuV) | Limit (dBuV/m) | Margin (dB) | Antenna Factor (dB/m) | Cable Loss (dB) | Preamp Factor (dB) | Antenna Height (cm) | Table Angle (Degree) | Remark |
| 2386.68 | 40.54 | 38.83 | 54 | -13.46 | 31.8 | 5.4 | 35.49 | 165 | 189 | Average |
| 2386.68 | 53.43 | 51.72 | 74 | -20.57 | 31.8 | 5.4 | 35.49 | 165 | 189 | Peak |
| 2440 | 92.97 | 91.12 | | | 31.85 | 5.46 | 35.46 | 165 | 189 | Average |
| 2440 | 95.8 | 93.95 | | | 31.85 | 5.46 | 35.46 | 165 | 189 | Peak |
| 2496.92 | 41.13 | 39.11 | 54 | -12.87 | 31.9 | 5.53 | 35.41 | 165 | 189 | Average |
| 2496.92 | 52.98 | 50.96 | 74 | -21.02 | 31.9 | 5.53 | 35.41 | 165 | 189 | Peak |

| Antennal Polarity & Test Distance: Vertical at 3 m | | | | | | | | | | |
|--|-------------------------|-------------------|----------------|-------------|-----------------------|-----------------|--------------------|---------------------|----------------------|---------|
| Frequency (MHz) | Emission Level (dBuV/m) | Read Level (dBuV) | Limit (dBuV/m) | Margin (dB) | Antenna Factor (dB/m) | Cable Loss (dB) | Preamp Factor (dB) | Antenna Height (cm) | Table Angle (Degree) | Remark |
| 2389.65 | 40.71 | 39 | 54 | -13.29 | 31.8 | 5.4 | 35.49 | 100 | 230 | Average |
| 2389.65 | 51.82 | 50.11 | 74 | -22.18 | 31.8 | 5.4 | 35.49 | 100 | 230 | Peak |
| 2440 | 93.89 | 92.04 | | | 31.85 | 5.46 | 35.46 | 100 | 230 | Average |
| 2440 | 96.06 | 94.21 | | | 31.85 | 5.46 | 35.46 | 100 | 230 | Peak |
| 2491.24 | 41.06 | 39.05 | 54 | -12.94 | 31.9 | 5.53 | 35.42 | 100 | 230 | Average |
| 2491.24 | 53.15 | 51.14 | 74 | -20.85 | 31.9 | 5.53 | 35.42 | 100 | 230 | Peak |

Remarks:

- Emission Level = Read Level + Antenna Factor + Cable Loss - Preamp Factor
Margin value = Emission level – Limit value
- 2440 MHz: Fundamental frequency.

| EUT Test Condition | | Measurement Detail | |
|--------------------------|--------------------|--------------------|---------------------------|
| Channel | Channel 39 | Frequency Range | 1 GHz ~ 25 GHz |
| Input Power | 120 Vac, 60 Hz | Detector Function | Peak (PK) Average (AV) |
| Environmental Conditions | 25 deg. C, 65 % RH | Tested By | Harry Hsueh & Karl Lee |

| Antennal Polarity & Test Distance: Horizontal at 3 m | | | | | | | | | | |
|--|-------------------------|-------------------|----------------|-------------|-----------------------|-----------------|--------------------|---------------------|----------------------|---------|
| Frequency (MHz) | Emission Level (dBuV/m) | Read Level (dBuV) | Limit (dBuV/m) | Margin (dB) | Antenna Factor (dB/m) | Cable Loss (dB) | Preamp Factor (dB) | Antenna Height (cm) | Table Angle (Degree) | Remark |
| 2480 | 91.91 | 89.95 | | | 31.88 | 5.5 | 35.42 | 165 | 189 | Average |
| 2480 | 95.09 | 93.13 | | | 31.88 | 5.5 | 35.42 | 165 | 189 | Peak |
| 2496.44 | 41.28 | 39.26 | 54 | -12.72 | 31.9 | 5.53 | 35.41 | 165 | 189 | Average |
| 2496.44 | 52.26 | 50.24 | 74 | -21.74 | 31.9 | 5.53 | 35.41 | 165 | 189 | Peak |
| 4960 | 38.76 | 30.49 | 54 | -15.24 | 33.99 | 8.29 | 34.01 | 175 | 92 | Average |
| 4960 | 48 | 39.73 | 74 | -26 | 33.99 | 8.29 | 34.01 | 175 | 92 | Peak |
| Antennal Polarity & Test Distance: Vertical at 3 m | | | | | | | | | | |
| Frequency (MHz) | Emission Level (dBuV/m) | Read Level (dBuV) | Limit (dBuV/m) | Margin (dB) | Antenna Factor (dB/m) | Cable Loss (dB) | Preamp Factor (dB) | Antenna Height (cm) | Table Angle (Degree) | Remark |
| 2480 | 90.59 | 88.63 | | | 31.88 | 5.5 | 35.42 | 110 | 190 | Average |
| 2480 | 94.12 | 92.16 | | | 31.88 | 5.5 | 35.42 | 110 | 190 | Peak |
| 2499.44 | 41.15 | 39.13 | 54 | -12.85 | 31.9 | 5.53 | 35.41 | 110 | 190 | Average |
| 2499.44 | 52.9 | 50.88 | 74 | -21.1 | 31.9 | 5.53 | 35.41 | 110 | 190 | Peak |
| 4960 | 39.25 | 30.98 | 54 | -14.75 | 33.99 | 8.29 | 34.01 | 136 | 125 | Average |
| 4960 | 48.43 | 40.16 | 74 | -25.57 | 33.99 | 8.29 | 34.01 | 136 | 125 | Peak |

Remarks:

- Emission Level = Read Level + Antenna Factor + Cable Loss - Preamp Factor
Margin value = Emission level – Limit value
- 2480 MHz: Fundamental frequency.

Mode B

| EUT Test Condition | | Measurement Detail | |
|--------------------------|--------------------|--------------------|---------------------------|
| Channel | Channel 39 | Frequency Range | 1 GHz ~ 25 GHz |
| Input Power | 120 Vac, 60 Hz | Detector Function | Peak (PK) Average (AV) |
| Environmental Conditions | 25 deg. C, 65 % RH | Tested By | Harry Hsueh & Karl Lee |

| Antennal Polarity & Test Distance: Horizontal at 3 m | | | | | | | | | | |
|--|-------------------------|-------------------|----------------|-------------|-----------------------|-----------------|--------------------|---------------------|----------------------|---------|
| Frequency (MHz) | Emission Level (dBuV/m) | Read Level (dBuV) | Limit (dBuV/m) | Margin (dB) | Antenna Factor (dB/m) | Cable Loss (dB) | Preamp Factor (dB) | Antenna Height (cm) | Table Angle (Degree) | Remark |
| 2480 | 91.76 | 89.8 | | | 31.88 | 5.5 | 35.42 | 158 | 162 | Average |
| 2480 | 94.96 | 93 | | | 31.88 | 5.5 | 35.42 | 158 | 162 | Peak |
| 2498.06 | 41.15 | 39.13 | 54 | -12.85 | 31.9 | 5.53 | 35.41 | 158 | 162 | Average |
| 2498.06 | 52.38 | 50.36 | 74 | -21.62 | 31.9 | 5.53 | 35.41 | 158 | 162 | Peak |
| 4960 | 38.65 | 30.38 | 54 | -15.35 | 33.99 | 8.29 | 34.01 | 195 | 324 | Average |
| 4960 | 48.16 | 39.89 | 74 | -25.84 | 33.99 | 8.29 | 34.01 | 195 | 324 | Peak |

| Antennal Polarity & Test Distance: Vertical at 3 m | | | | | | | | | | |
|--|-------------------------|-------------------|----------------|-------------|-----------------------|-----------------|--------------------|---------------------|----------------------|---------|
| Frequency (MHz) | Emission Level (dBuV/m) | Read Level (dBuV) | Limit (dBuV/m) | Margin (dB) | Antenna Factor (dB/m) | Cable Loss (dB) | Preamp Factor (dB) | Antenna Height (cm) | Table Angle (Degree) | Remark |
| 2480 | 90.42 | 88.46 | | | 31.88 | 5.5 | 35.42 | 134 | 222 | Average |
| 2480 | 94.28 | 92.32 | | | 31.88 | 5.5 | 35.42 | 134 | 222 | Peak |
| 2493.27 | 41.06 | 39.04 | 54 | -12.94 | 31.9 | 5.53 | 35.41 | 134 | 222 | Average |
| 2493.27 | 52.76 | 50.74 | 74 | -21.24 | 31.9 | 5.53 | 35.41 | 134 | 222 | Peak |
| 4960 | 38.94 | 30.67 | 54 | -15.06 | 33.99 | 8.29 | 34.01 | 185 | 49 | Average |
| 4960 | 48.26 | 39.99 | 74 | -25.74 | 33.99 | 8.29 | 34.01 | 185 | 49 | Peak |

Remarks:

- Emission Level = Read Level + Antenna Factor + Cable Loss - Preamp Factor
Margin value = Emission level – Limit value
- 2480 MHz: Fundamental frequency.

9 kHz ~ 30 MHz DATA:

The amplitude of spurious emissions attenuated more than 20 dB below the permissible value is not required to be report.

30 MHz ~ 1 GHz WORST-CASE DATA:

Mode A

| EUT Test Condition | | Measurement Detail | |
|--------------------------|--------------------|--------------------|------------------------------|
| Channel | Channel 39 | Frequency Range | 30 MHz ~ 1 GHz |
| Input Power | 120 Vac, 60 Hz | Detector Function | Peak (PK) Quasi-peak (QP) |
| Environmental Conditions | 25 deg. C, 65 % RH | Tested By | Harry Hsueh & Karl Lee |

| Antennal Polarity & Test Distance: Horizontal at 3 m | | | | | | | | | | |
|--|-------------------------|-------------------|----------------|-------------|-----------------------|-----------------|--------------------|---------------------|----------------------|--------|
| Frequency (MHz) | Emission Level (dBuV/m) | Read Level (dBuV) | Limit (dBuV/m) | Margin (dB) | Antenna Factor (dB/m) | Cable Loss (dB) | Preamp Factor (dB) | Antenna Height (cm) | Table Angle (Degree) | Remark |
| 41.07 | 11.45 | 29.35 | 40 | -28.55 | 13.59 | 0.74 | 32.23 | 126 | 194 | Peak |
| 124.5 | 14.25 | 35.44 | 43.5 | -29.25 | 9.67 | 1.38 | 32.24 | 176 | 144 | Peak |
| 221.97 | 19.56 | 38.7 | 46 | -26.44 | 11.42 | 1.65 | 32.21 | 135 | 128 | Peak |
| 437.9 | 14.17 | 28.44 | 46 | -31.83 | 15.4 | 2.49 | 32.16 | 190 | 137 | Peak |
| 641.6 | 17.51 | 28.36 | 46 | -28.49 | 18.32 | 2.99 | 32.16 | 100 | 126 | Peak |
| 772.5 | 19.59 | 28.38 | 46 | -26.41 | 20.05 | 3.27 | 32.11 | 174 | 324 | Peak |

| Antennal Polarity & Test Distance: Vertical at 3 m | | | | | | | | | | |
|--|-------------------------|-------------------|----------------|-------------|-----------------------|-----------------|--------------------|---------------------|----------------------|--------|
| Frequency (MHz) | Emission Level (dBuV/m) | Read Level (dBuV) | Limit (dBuV/m) | Margin (dB) | Antenna Factor (dB/m) | Cable Loss (dB) | Preamp Factor (dB) | Antenna Height (cm) | Table Angle (Degree) | Remark |
| 80.49 | 13.37 | 36.25 | 40 | -26.63 | 8.22 | 1.11 | 32.21 | 137 | 125 | Peak |
| 158.52 | 14.38 | 36.46 | 43.5 | -29.12 | 8.67 | 1.52 | 32.27 | 196 | 171 | Peak |
| 224.4 | 14.34 | 33.38 | 46 | -31.66 | 11.51 | 1.65 | 32.2 | 188 | 234 | Peak |
| 371.4 | 12.31 | 27.7 | 46 | -33.69 | 14.49 | 2.26 | 32.14 | 142 | 128 | Peak |
| 652.8 | 17.63 | 28.3 | 46 | -28.37 | 18.49 | 2.99 | 32.15 | 168 | 134 | Peak |
| 731.2 | 18.86 | 28.2 | 46 | -27.14 | 19.62 | 3.16 | 32.12 | 190 | 245 | Peak |

Remarks:

- Emission Level = Read Level + Antenna Factor + Cable Loss - Preamp Factor
Margin value = Emission level – Limit value

Mode B

| EUT Test Condition | | Measurement Detail | |
|--------------------------|--------------------|--------------------|------------------------------|
| Channel | Channel 39 | Frequency Range | 30 MHz ~ 1 GHz |
| Input Power | 120 Vac, 60 Hz | Detector Function | Peak (PK) Quasi-peak (QP) |
| Environmental Conditions | 25 deg. C, 65 % RH | Tested By | Harry Hsueh & Karl Lee |

| Antennal Polarity & Test Distance: Horizontal at 3 m | | | | | | | | | | |
|--|-------------------------|-------------------|----------------|-------------|-----------------------|-----------------|--------------------|---------------------|----------------------|--------|
| Frequency (MHz) | Emission Level (dBuV/m) | Read Level (dBuV) | Limit (dBuV/m) | Margin (dB) | Antenna Factor (dB/m) | Cable Loss (dB) | Preamp Factor (dB) | Antenna Height (cm) | Table Angle (Degree) | Remark |
| 35.67 | 9.93 | 29.07 | 40 | -30.07 | 12.35 | 0.74 | 32.23 | 152 | 129 | Peak |
| 109.92 | 12.96 | 31.9 | 43.5 | -30.54 | 12.03 | 1.28 | 32.25 | 121 | 64 | Peak |
| 234.39 | 16.07 | 34.46 | 46 | -29.93 | 11.92 | 1.85 | 32.16 | 190 | 342 | Peak |
| 503 | 15.73 | 28.8 | 46 | -30.27 | 16.4 | 2.63 | 32.1 | 148 | 275 | Peak |
| 811 | 20.25 | 28.43 | 46 | -25.75 | 20.5 | 3.32 | 32 | 160 | 134 | Peak |
| 897.1 | 21.5 | 28.07 | 46 | -24.5 | 21.44 | 3.49 | 31.5 | 158 | 124 | Peak |

| Antennal Polarity & Test Distance: Vertical at 3 m | | | | | | | | | | |
|--|-------------------------|-------------------|----------------|-------------|-----------------------|-----------------|--------------------|---------------------|----------------------|--------|
| Frequency (MHz) | Emission Level (dBuV/m) | Read Level (dBuV) | Limit (dBuV/m) | Margin (dB) | Antenna Factor (dB/m) | Cable Loss (dB) | Preamp Factor (dB) | Antenna Height (cm) | Table Angle (Degree) | Remark |
| 46.2 | 23.44 | 40.3 | 40 | -16.56 | 14.46 | 0.9 | 32.22 | 158 | 199 | Peak |
| 149.88 | 10.1 | 32.44 | 43.5 | -33.4 | 8.41 | 1.52 | 32.27 | 168 | 311 | Peak |
| 238.44 | 14.59 | 32.83 | 46 | -31.41 | 12.05 | 1.85 | 32.14 | 172 | 341 | Peak |
| 409.9 | 13.08 | 27.76 | 46 | -32.92 | 15.12 | 2.41 | 32.21 | 105 | 116 | Peak |
| 562.5 | 16.48 | 28.53 | 46 | -29.52 | 17.33 | 2.82 | 32.2 | 128 | 107 | Peak |
| 822.9 | 20.6 | 28.48 | 46 | -25.4 | 20.68 | 3.38 | 31.94 | 158 | 126 | Peak |

Remarks:

- Emission Level = Read Level + Antenna Factor + Cable Loss - Preamp Factor
Margin value = Emission level – Limit value

<LE 5.0>

ABOVE 1 GHz DATA :

Mode A

| EUT Test Condition | | Measurement Detail | |
|--------------------------|--------------------|--------------------|---------------------------|
| Channel | Channel 0 | Frequency Range | 1 GHz ~ 25 GHz |
| Input Power | 120 Vac, 60 Hz | Detector Function | Peak (PK) Average (AV) |
| Environmental Conditions | 25 deg. C, 65 % RH | Tested By | Harry Hsueh & Karl Lee |

| Antennal Polarity & Test Distance: Horizontal at 3 m | | | | | | | | | | |
|--|-------------------------|-------------------|----------------|-------------|-----------------------|-----------------|--------------------|---------------------|----------------------|---------|
| Frequency (MHz) | Emission Level (dBuV/m) | Read Level (dBuV) | Limit (dBuV/m) | Margin (dB) | Antenna Factor (dB/m) | Cable Loss (dB) | Preamp Factor (dB) | Antenna Height (cm) | Table Angle (Degree) | Remark |
| 2381.73 | 40.17 | 38.48 | 54 | -13.83 | 31.78 | 5.4 | 35.49 | 160 | 205 | Peak |
| 2381.73 | 50.67 | 48.98 | 74 | -23.33 | 31.78 | 5.4 | 35.49 | 160 | 205 | Peak |
| 2402 | 91.43 | 89.7 | | | 31.8 | 5.4 | 35.47 | 160 | 205 | Average |
| 2402 | 93.31 | 91.58 | | | 31.8 | 5.4 | 35.47 | 160 | 205 | Peak |
| 4804 | 38.22 | 30.13 | 54 | -15.78 | 33.96 | 8.25 | 34.12 | 164 | 224 | Average |
| 4804 | 47.37 | 39.28 | 74 | -26.63 | 33.96 | 8.25 | 34.12 | 164 | 224 | Peak |

| Antennal Polarity & Test Distance: Vertical at 3 m | | | | | | | | | | |
|--|-------------------------|-------------------|----------------|-------------|-----------------------|-----------------|--------------------|---------------------|----------------------|---------|
| Frequency (MHz) | Emission Level (dBuV/m) | Read Level (dBuV) | Limit (dBuV/m) | Margin (dB) | Antenna Factor (dB/m) | Cable Loss (dB) | Preamp Factor (dB) | Antenna Height (cm) | Table Angle (Degree) | Remark |
| 2382.72 | 40.04 | 38.35 | 54 | -13.96 | 31.78 | 5.4 | 35.49 | 102 | 219 | Peak |
| 2382.72 | 51.23 | 49.54 | 74 | -22.77 | 31.78 | 5.4 | 35.49 | 102 | 219 | Peak |
| 2402 | 92.51 | 90.78 | | | 31.8 | 5.4 | 35.47 | 102 | 219 | Average |
| 2402 | 94.68 | 92.95 | | | 31.8 | 5.4 | 35.47 | 102 | 219 | Peak |
| 4804 | 39.31 | 31.22 | 54 | -14.69 | 33.96 | 8.25 | 34.12 | 195 | 217 | Average |
| 4804 | 48.27 | 40.18 | 74 | -25.73 | 33.96 | 8.25 | 34.12 | 195 | 217 | Peak |

Remarks:

- Emission Level = Read Level + Antenna Factor + Cable Loss - Preamp Factor
Margin value = Emission level – Limit value
- 2402 MHz: Fundamental frequency.

| EUT Test Condition | | Measurement Detail | |
|--------------------------|--------------------|--------------------|---------------------------|
| Channel | Channel 19 | Frequency Range | 1 GHz ~ 25 GHz |
| Input Power | 120 Vac, 60 Hz | Detector Function | Peak (PK) Average (AV) |
| Environmental Conditions | 25 deg. C, 65 % RH | Tested By | Harry Hsueh & Karl Lee |

| Antennal Polarity & Test Distance: Horizontal at 3 m | | | | | | | | | | |
|--|-------------------------|-------------------|----------------|-------------|-----------------------|-----------------|--------------------|---------------------|----------------------|---------|
| Frequency (MHz) | Emission Level (dBuV/m) | Read Level (dBuV) | Limit (dBuV/m) | Margin (dB) | Antenna Factor (dB/m) | Cable Loss (dB) | Preamp Factor (dB) | Antenna Height (cm) | Table Angle (Degree) | Remark |
| 2377.23 | 39.98 | 38.32 | 54 | -14.02 | 31.78 | 5.37 | 35.49 | 160 | 205 | Peak |
| 2377.23 | 50.88 | 49.22 | 74 | -23.12 | 31.78 | 5.37 | 35.49 | 160 | 205 | Peak |
| 2440 | 91.89 | 90.04 | | | 31.85 | 5.46 | 35.46 | 160 | 205 | Average |
| 2440 | 94.57 | 92.72 | | | 31.85 | 5.46 | 35.46 | 160 | 205 | Peak |
| 2489.8 | 51.74 | 49.73 | 74 | -22.26 | 31.9 | 5.53 | 35.42 | 160 | 205 | Peak |
| 2489.8 | 40.66 | 38.65 | 54 | -13.34 | 31.9 | 5.53 | 35.42 | 160 | 205 | Peak |
| Antennal Polarity & Test Distance: Vertical at 3 m | | | | | | | | | | |
| Frequency (MHz) | Emission Level (dBuV/m) | Read Level (dBuV) | Limit (dBuV/m) | Margin (dB) | Antenna Factor (dB/m) | Cable Loss (dB) | Preamp Factor (dB) | Antenna Height (cm) | Table Angle (Degree) | Remark |
| 2362.48 | 40.15 | 38.52 | 54 | -13.85 | 31.76 | 5.37 | 35.5 | 102 | 219 | Peak |
| 2362.48 | 51.82 | 50.19 | 74 | -22.18 | 31.76 | 5.37 | 35.5 | 102 | 219 | Peak |
| 2440 | 92.82 | 90.97 | | | 31.85 | 5.46 | 35.46 | 102 | 219 | Average |
| 2440 | 95.27 | 93.42 | | | 31.85 | 5.46 | 35.46 | 102 | 219 | Peak |
| 2488.08 | 53.15 | 51.14 | 74 | -20.85 | 31.9 | 5.53 | 35.42 | 102 | 219 | Peak |
| 2488.08 | 40.98 | 38.97 | 54 | -13.02 | 31.9 | 5.53 | 35.42 | 102 | 219 | Peak |

Remarks:

- Emission Level = Read Level + Antenna Factor + Cable Loss - Preamp Factor
Margin value = Emission level – Limit value
- 2440 MHz: Fundamental frequency.

| EUT Test Condition | | Measurement Detail | |
|--------------------------|--------------------|--------------------|---------------------------|
| Channel | Channel 39 | Frequency Range | 1 GHz ~ 25 GHz |
| Input Power | 120 Vac, 60 Hz | Detector Function | Peak (PK) Average (AV) |
| Environmental Conditions | 25 deg. C, 65 % RH | Tested By | Harry Hsueh & Karl Lee |

| Antennal Polarity & Test Distance: Horizontal at 3 m | | | | | | | | | | |
|--|-------------------------|-------------------|----------------|-------------|-----------------------|-----------------|--------------------|---------------------|----------------------|---------|
| Frequency (MHz) | Emission Level (dBuV/m) | Read Level (dBuV) | Limit (dBuV/m) | Margin (dB) | Antenna Factor (dB/m) | Cable Loss (dB) | Preamp Factor (dB) | Antenna Height (cm) | Table Angle (Degree) | Remark |
| 2480 | 89.85 | 87.89 | | | 31.88 | 5.5 | 35.42 | 160 | 205 | Average |
| 2480 | 93.25 | 91.29 | | | 31.88 | 5.5 | 35.42 | 160 | 205 | Peak |
| 2491.72 | 51.99 | 49.98 | 74 | -22.01 | 31.9 | 5.53 | 35.42 | 160 | 205 | Peak |
| 2491.72 | 40.78 | 38.77 | 54 | -13.22 | 31.9 | 5.53 | 35.42 | 160 | 205 | Peak |
| 4960 | 38.52 | 30.25 | 54 | -15.48 | 33.99 | 8.29 | 34.01 | 139 | 67 | Average |
| 4960 | 47.86 | 39.59 | 74 | -26.14 | 33.99 | 8.29 | 34.01 | 139 | 67 | Peak |

| Antennal Polarity & Test Distance: Vertical at 3 m | | | | | | | | | | |
|--|-------------------------|-------------------|----------------|-------------|-----------------------|-----------------|--------------------|---------------------|----------------------|---------|
| Frequency (MHz) | Emission Level (dBuV/m) | Read Level (dBuV) | Limit (dBuV/m) | Margin (dB) | Antenna Factor (dB/m) | Cable Loss (dB) | Preamp Factor (dB) | Antenna Height (cm) | Table Angle (Degree) | Remark |
| 2480 | 90.42 | 88.46 | | | 31.88 | 5.5 | 35.42 | 102 | 219 | Average |
| 2480 | 94.26 | 92.3 | | | 31.88 | 5.5 | 35.42 | 102 | 219 | Peak |
| 2489.64 | 52.53 | 50.52 | 74 | -21.47 | 31.9 | 5.53 | 35.42 | 102 | 219 | Peak |
| 2489.64 | 40.81 | 38.8 | 54 | -13.19 | 31.9 | 5.53 | 35.42 | 102 | 219 | Peak |
| 4960 | 39.06 | 30.79 | 54 | -14.94 | 33.99 | 8.29 | 34.01 | 155 | 121 | Average |
| 4960 | 48.16 | 39.89 | 74 | -25.84 | 33.99 | 8.29 | 34.01 | 155 | 121 | Peak |

Remarks:

- Emission Level = Read Level + Antenna Factor + Cable Loss - Preamp Factor
Margin value = Emission level – Limit value
- 2480 MHz: Fundamental frequency.

Mode B

| EUT Test Condition | | Measurement Detail | |
|--------------------------|--------------------|--------------------|---------------------------|
| Channel | Channel 19 | Frequency Range | 1 GHz ~ 25 GHz |
| Input Power | 120 Vac, 60 Hz | Detector Function | Peak (PK) Average (AV) |
| Environmental Conditions | 25 deg. C, 65 % RH | Tested By | Harry Hsueh & Karl Lee |

| Antennal Polarity & Test Distance: Horizontal at 3 m | | | | | | | | | | |
|--|-------------------------|-------------------|----------------|-------------|-----------------------|-----------------|--------------------|---------------------|----------------------|---------|
| Frequency (MHz) | Emission Level (dBuV/m) | Read Level (dBuV) | Limit (dBuV/m) | Margin (dB) | Antenna Factor (dB/m) | Cable Loss (dB) | Preamp Factor (dB) | Antenna Height (cm) | Table Angle (Degree) | Remark |
| 2345.28 | 39.85 | 38.28 | 54 | -14.15 | 31.74 | 5.33 | 35.5 | 175 | 186 | Average |
| 2345.28 | 50.49 | 48.92 | 74 | -23.51 | 31.74 | 5.33 | 35.5 | 175 | 186 | Peak |
| 2440 | 91.59 | 89.74 | | | 31.85 | 5.46 | 35.46 | 175 | 186 | Average |
| 2440 | 94.8 | 92.95 | | | 31.85 | 5.46 | 35.46 | 175 | 186 | Peak |
| 2496.47 | 40.39 | 38.37 | 54 | -13.61 | 31.9 | 5.53 | 35.41 | 175 | 186 | Average |
| 2496.47 | 52.04 | 50.02 | 74 | -21.96 | 31.9 | 5.53 | 35.41 | 175 | 186 | Peak |

| Antennal Polarity & Test Distance: Vertical at 3 m | | | | | | | | | | |
|--|-------------------------|-------------------|----------------|-------------|-----------------------|-----------------|--------------------|---------------------|----------------------|---------|
| Frequency (MHz) | Emission Level (dBuV/m) | Read Level (dBuV) | Limit (dBuV/m) | Margin (dB) | Antenna Factor (dB/m) | Cable Loss (dB) | Preamp Factor (dB) | Antenna Height (cm) | Table Angle (Degree) | Remark |
| 2354.27 | 40.34 | 38.75 | 54 | -13.66 | 31.76 | 5.33 | 35.5 | 111 | 194 | Average |
| 2354.27 | 51.74 | 50.15 | 74 | -22.26 | 31.76 | 5.33 | 35.5 | 111 | 194 | Peak |
| 2440 | 92.91 | 91.06 | | | 31.85 | 5.46 | 35.46 | 111 | 194 | Average |
| 2440 | 95.13 | 93.28 | | | 31.85 | 5.46 | 35.46 | 111 | 194 | Peak |
| 2486.68 | 40.73 | 38.74 | 54 | -13.27 | 31.88 | 5.53 | 35.42 | 111 | 194 | Average |
| 2486.68 | 52.86 | 50.87 | 74 | -21.14 | 31.88 | 5.53 | 35.42 | 111 | 194 | Peak |

Remarks:

- Emission Level = Read Level + Antenna Factor + Cable Loss - Preamp Factor
Margin value = Emission level – Limit value
- 2440 MHz: Fundamental frequency.

9 kHz ~ 30 MHz DATA:

The amplitude of spurious emissions attenuated more than 20 dB below the permissible value is not required to be report.

30 MHz ~ 1 GHz WORST-CASE DATA:

Mode A

| EUT Test Condition | | Measurement Detail | |
|--------------------------|--------------------|--------------------|------------------------------|
| Channel | Channel 19 | Frequency Range | 30 MHz ~ 1 GHz |
| Input Power | 120 Vac, 60 Hz | Detector Function | Peak (PK) Quasi-peak (QP) |
| Environmental Conditions | 25 deg. C, 65 % RH | Tested By | Harry Hsueh & Karl Lee |

| Antennal Polarity & Test Distance: Horizontal at 3 m | | | | | | | | | | |
|--|-------------------------|-------------------|----------------|-------------|-----------------------|-----------------|--------------------|---------------------|----------------------|--------|
| Frequency (MHz) | Emission Level (dBuV/m) | Read Level (dBuV) | Limit (dBuV/m) | Margin (dB) | Antenna Factor (dB/m) | Cable Loss (dB) | Preamp Factor (dB) | Antenna Height (cm) | Table Angle (Degree) | Remark |
| 41.07 | 11.45 | 29.35 | 40 | -28.55 | 13.59 | 0.74 | 32.23 | 126 | 194 | Peak |
| 124.5 | 14.25 | 35.44 | 43.5 | -29.25 | 9.67 | 1.38 | 32.24 | 176 | 144 | Peak |
| 221.97 | 19.56 | 38.7 | 46 | -26.44 | 11.42 | 1.65 | 32.21 | 135 | 128 | Peak |
| 437.9 | 14.17 | 28.44 | 46 | -31.83 | 15.4 | 2.49 | 32.16 | 190 | 137 | Peak |
| 641.6 | 17.51 | 28.36 | 46 | -28.49 | 18.32 | 2.99 | 32.16 | 100 | 126 | Peak |
| 772.5 | 19.59 | 28.38 | 46 | -26.41 | 20.05 | 3.27 | 32.11 | 174 | 324 | Peak |

| Antennal Polarity & Test Distance: Vertical at 3 m | | | | | | | | | | |
|--|-------------------------|-------------------|----------------|-------------|-----------------------|-----------------|--------------------|---------------------|----------------------|--------|
| Frequency (MHz) | Emission Level (dBuV/m) | Read Level (dBuV) | Limit (dBuV/m) | Margin (dB) | Antenna Factor (dB/m) | Cable Loss (dB) | Preamp Factor (dB) | Antenna Height (cm) | Table Angle (Degree) | Remark |
| 80.49 | 13.37 | 36.25 | 40 | -26.63 | 8.22 | 1.11 | 32.21 | 137 | 125 | Peak |
| 158.52 | 14.38 | 36.46 | 43.5 | -29.12 | 8.67 | 1.52 | 32.27 | 196 | 171 | Peak |
| 224.4 | 14.34 | 33.38 | 46 | -31.66 | 11.51 | 1.65 | 32.2 | 188 | 234 | Peak |
| 371.4 | 12.31 | 27.7 | 46 | -33.69 | 14.49 | 2.26 | 32.14 | 142 | 128 | Peak |
| 652.8 | 17.63 | 28.3 | 46 | -28.37 | 18.49 | 2.99 | 32.15 | 168 | 134 | Peak |
| 731.2 | 18.86 | 28.2 | 46 | -27.14 | 19.62 | 3.16 | 32.12 | 190 | 245 | Peak |

Remarks:

- Emission Level = Read Level + Antenna Factor + Cable Loss - Preamp Factor
Margin value = Emission level – Limit value

Mode B

| EUT Test Condition | | Measurement Detail | |
|--------------------------|--------------------|--------------------|------------------------------|
| Channel | Channel 19 | Frequency Range | 30 MHz ~ 1 GHz |
| Input Power | 120 Vac, 60 Hz | Detector Function | Peak (PK) Quasi-peak (QP) |
| Environmental Conditions | 25 deg. C, 65 % RH | Tested By | Harry Hsueh & Karl Lee |

| Antennal Polarity & Test Distance: Horizontal at 3 m | | | | | | | | | | |
|--|-------------------------|-------------------|----------------|-------------|-----------------------|-----------------|--------------------|---------------------|----------------------|--------|
| Frequency (MHz) | Emission Level (dBuV/m) | Read Level (dBuV) | Limit (dBuV/m) | Margin (dB) | Antenna Factor (dB/m) | Cable Loss (dB) | Preamp Factor (dB) | Antenna Height (cm) | Table Angle (Degree) | Remark |
| 95.07 | 15.32 | 34.41 | 43.5 | -28.18 | 11.62 | 1.28 | 31.99 | 164 | 118 | Peak |
| 203.34 | 24.42 | 43.94 | 43.5 | -19.08 | 11.11 | 1.65 | 32.28 | 190 | 123 | Peak |
| 279.48 | 16.14 | 33.5 | 46 | -29.86 | 12.73 | 2.03 | 32.12 | 171 | 154 | Peak |
| 409.2 | 14.32 | 29.02 | 46 | -31.68 | 15.1 | 2.41 | 32.21 | 134 | 156 | Peak |
| 583.5 | 16.66 | 28.34 | 46 | -29.34 | 17.7 | 2.82 | 32.2 | 198 | 125 | Peak |
| 727.7 | 19.58 | 28.95 | 46 | -26.42 | 19.59 | 3.16 | 32.12 | 172 | 124 | Peak |

| Antennal Polarity & Test Distance: Vertical at 3 m | | | | | | | | | | |
|--|-------------------------|-------------------|----------------|-------------|-----------------------|-----------------|--------------------|---------------------|----------------------|--------|
| Frequency (MHz) | Emission Level (dBuV/m) | Read Level (dBuV) | Limit (dBuV/m) | Margin (dB) | Antenna Factor (dB/m) | Cable Loss (dB) | Preamp Factor (dB) | Antenna Height (cm) | Table Angle (Degree) | Remark |
| 46.47 | 24.1 | 40.96 | 40 | -15.9 | 14.46 | 0.9 | 32.22 | 158 | 196 | Peak |
| 113.97 | 8.1 | 27.65 | 43.5 | -35.4 | 11.42 | 1.28 | 32.25 | 137 | 205 | Peak |
| 236.01 | 12.32 | 30.67 | 46 | -33.68 | 11.95 | 1.85 | 32.15 | 161 | 114 | Peak |
| 425.3 | 14.44 | 28.93 | 46 | -31.56 | 15.28 | 2.41 | 32.18 | 160 | 340 | Peak |
| 692 | 19.5 | 29.44 | 46 | -26.5 | 19.11 | 3.05 | 32.1 | 184 | 127 | Peak |
| 873.3 | 22.5 | 29.44 | 46 | -23.5 | 21.27 | 3.44 | 31.65 | 163 | 253 | Peak |

Remarks:

- Emission Level = Read Level + Antenna Factor + Cable Loss - Preamp Factor
Margin value = Emission level – Limit value

4.2 Conducted Emission Measurement

4.2.1 Limits of Conducted Emission Measurement

| Frequency (MHz) | Conducted Limit (dBuV) | |
|-----------------|------------------------|---------|
| | Quasi-peak | Average |
| 0.15 - 0.5 | 66 - 56 | 56 - 46 |
| 0.50 - 5.0 | 56 | 46 |
| 5.0 - 30.0 | 60 | 50 |

4.2.2 Test Instruments

| Description & Manufacturer | Model No. | Serial No. | Date Of Calibration | Due Date Of Calibration |
|---|--------------------------|----------------|---------------------|-------------------------|
| Test Receiver ROHDE & SCHWARZ | ESCI | 100613 | Nov. 21, 2016 | Nov. 20, 2017 |
| RF signal cable (with 10dB PAD) Woken | 5D-FB | Cable-cond1-01 | Dec. 22, 2016 | Dec. 21, 2017 |
| LISN/AMN ROHDE & SCHWARZ (EUT) | ESH3-Z5 | 835239/001 | Mar. 10, 2017 | Mar. 09, 2018 |
| LISN/AMN ROHDE & SCHWARZ (Peripheral) | ENV216 | 101196 | Apr. 20, 2017 | Apr. 19, 2018 |
| Software ADT | BV ADT_Cond_ V7.3.7.3 | NA | NA | NA |

- Note: 1. The calibration interval of the above test instruments is 12 months and the calibrations are traceable to NML/ROC and NIST/USA.
 2. The test was performed in HwaYa Shielded Room 1.
 3. The VCCI Site Registration No. is C-2040.

4.2.3 Test Procedures

- The EUT was placed 0.4 meters from the conducting wall of the shielded room with EUT being connected to the power mains through a line impedance stabilization network (LISN). Other support units were connected to the power mains through another LISN. The two LISNs provide 50 ohm/50 uH of coupling impedance for the measuring instrument.
- Both lines of the power mains connected to the EUT were checked for maximum conducted interference.
- The frequency range from 150 kHz to 30 MHz was searched. Emission levels under (Limit – 20 dB) was not recorded.

Note: All modes of operation were investigated and the worst-case emissions are reported.

4.2.4 Deviation from Test Standard

No deviation.

4.2.5 TEST SETUP

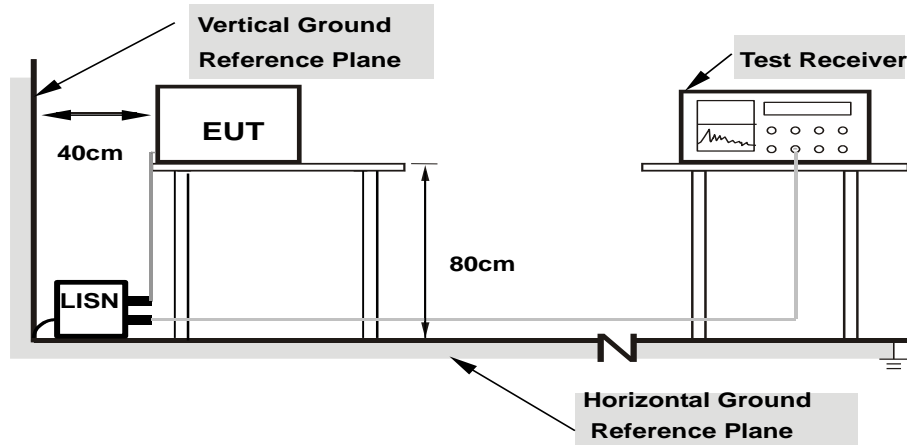

- Note:**
1. Support units were connected to second LISN.
 2. Both of LISNs (AMN) are 80 cm from EUT and at least 80 from other units and other metal planes

4.2.6 EUT Operating Conditions

- a. Placed the EUT on the testing table.
- b. Set the EUT under transmission condition continuously at specific channel frequency.

4.2.7 Test Results

<LE 4.0>

Mode A

| | | | |
|-----------------|----------------|--|--------------------------------------|
| Frequency Range | 150kHz ~ 30MHz | Detector Function & Resolution Bandwidth | Quasi-Peak (QP) / Average (AV), 9kHz |
| Input Power | 120Vac, 60Hz | Environmental Conditions | 25°C, 65%RH |
| Tested by | Getaz Yang | Test Date | 2017/7/28 |

| Phase Of Power : Line (L) | | | | | | | | | | |
|---------------------------|-----------------|------------------------|----------------------|-------|-----------------------|-------|--------------|-------|-------------|--------|
| No | Frequency (MHz) | Correction Factor (dB) | Reading Value (dBuV) | | Emission Level (dBuV) | | Limit (dBuV) | | Margin (dB) | |
| | | | Q.P. | AV. | Q.P. | AV. | Q.P. | AV. | Q.P. | AV. |
| 1 | 0.15391 | 10.35 | 30.70 | 19.62 | 41.05 | 29.97 | 65.79 | 55.79 | -24.74 | -25.82 |
| 2 | 0.23898 | 10.38 | 24.03 | 13.50 | 34.41 | 23.88 | 62.13 | 52.13 | -27.72 | -28.25 |
| 3 | 0.61543 | 10.40 | 27.75 | 19.28 | 38.15 | 29.68 | 56.00 | 46.00 | -17.85 | -16.32 |
| 4 | 2.41389 | 10.48 | 18.96 | 11.92 | 29.44 | 22.40 | 56.00 | 46.00 | -26.56 | -23.60 |
| 5 | 4.49010 | 10.59 | 28.28 | 17.79 | 38.87 | 28.38 | 56.00 | 46.00 | -17.13 | -17.62 |
| 6 | 13.48310 | 11.01 | 38.09 | 24.90 | 49.10 | 35.91 | 60.00 | 50.00 | -10.90 | -14.09 |

Remarks:

1. Q.P. and AV. are abbreviations of quasi-peak and average individually.
2. The emission levels of other frequencies were very low against the limit.
3. Margin value = Emission level – Limit value
4. Correction factor = Insertion loss + Cable loss
5. Emission Level = Correction Factor + Reading Value

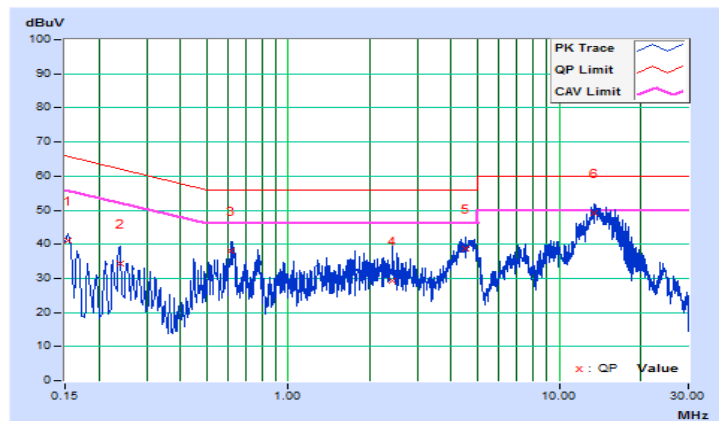

| | | | |
|-----------------|----------------|--|--------------------------------------|
| Frequency Range | 150kHz ~ 30MHz | Detector Function & Resolution Bandwidth | Quasi-Peak (QP) / Average (AV), 9kHz |
| Input Power | 120Vac, 60Hz | Environmental Conditions | 25°C, 65%RH |
| Tested by | Getaz Yang | Test Date | 2017/7/28 |

| Phase Of Power : Neutral (N) | | | | | | | | | | |
|------------------------------|-----------------|------------------------|----------------------|-------|-----------------------|-------|--------------|-------|-------------|--------|
| No | Frequency (MHz) | Correction Factor (dB) | Reading Value (dBuV) | | Emission Level (dBuV) | | Limit (dBuV) | | Margin (dB) | |
| | | | Q.P. | AV. | Q.P. | AV. | Q.P. | AV. | Q.P. | AV. |
| 1 | 0.23216 | 10.14 | 20.70 | 10.31 | 30.84 | 20.45 | 62.37 | 52.37 | -31.53 | -31.92 |
| 2 | 0.59627 | 10.16 | 29.47 | 17.52 | 39.63 | 27.68 | 56.00 | 46.00 | -16.37 | -18.32 |
| 3 | 0.76386 | 10.17 | 28.31 | 16.46 | 38.48 | 26.63 | 56.00 | 46.00 | -17.52 | -19.37 |
| 4 | 2.29268 | 10.25 | 26.61 | 16.08 | 36.86 | 26.33 | 56.00 | 46.00 | -19.14 | -19.67 |
| 5 | 4.68951 | 10.36 | 29.68 | 18.55 | 40.04 | 28.91 | 56.00 | 46.00 | -15.96 | -17.09 |
| 6 | 13.59649 | 10.69 | 33.60 | 22.89 | 44.29 | 33.58 | 60.00 | 50.00 | -15.71 | -16.42 |

Remarks:

1. Q.P. and AV. are abbreviations of quasi-peak and average individually.
2. The emission levels of other frequencies were very low against the limit.
3. Margin value = Emission level – Limit value
4. Correction factor = Insertion loss + Cable loss
5. Emission Level = Correction Factor + Reading Value

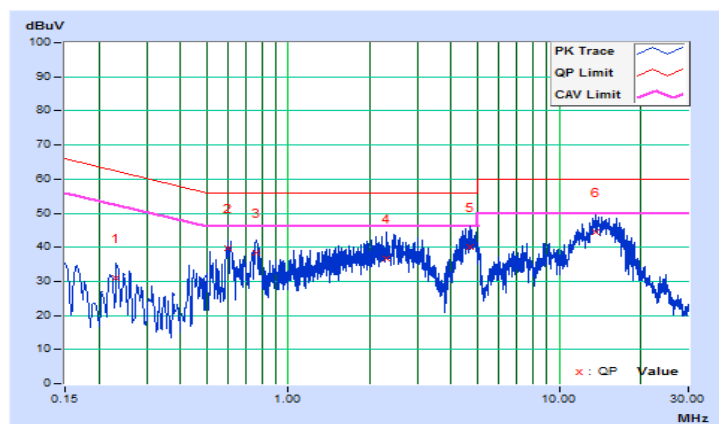

Mode B

| | | | |
|-----------------|----------------|--|--------------------------------------|
| Frequency Range | 150kHz ~ 30MHz | Detector Function & Resolution Bandwidth | Quasi-Peak (QP) / Average (AV), 9kHz |
| Input Power | 120Vac, 60Hz | Environmental Conditions | 25°C, 75%RH |
| Tested by | Getaz Yang | Test Date | 2017/8/28 |

| Phase Of Power : Line (L) | | | | | | | | | | |
|---------------------------|-----------------|------------------------|----------------------|-------|-----------------------|-------|--------------|-------|-------------|--------|
| No | Frequency (MHz) | Correction Factor (dB) | Reading Value (dBuV) | | Emission Level (dBuV) | | Limit (dBuV) | | Margin (dB) | |
| | | | Q.P. | AV. | Q.P. | AV. | Q.P. | AV. | Q.P. | AV. |
| 1 | 0.16623 | 10.35 | 26.38 | 15.47 | 36.73 | 25.82 | 65.15 | 55.15 | -28.42 | -29.33 |
| 2 | 0.65761 | 10.40 | 27.69 | 17.08 | 38.09 | 27.48 | 56.00 | 46.00 | -17.91 | -18.52 |
| 3 | 1.01400 | 10.40 | 23.11 | 12.54 | 33.51 | 22.94 | 56.00 | 46.00 | -22.49 | -23.06 |
| 4 | 1.43000 | 10.43 | 21.47 | 11.13 | 31.90 | 21.56 | 56.00 | 46.00 | -24.10 | -24.44 |
| 5 | 3.88282 | 10.56 | 19.91 | 10.60 | 30.47 | 21.16 | 56.00 | 46.00 | -25.53 | -24.84 |
| 6 | 6.79000 | 10.69 | 20.17 | 11.59 | 30.86 | 22.28 | 60.00 | 50.00 | -29.14 | -27.72 |

Remarks:

1. Q.P. and AV. are abbreviations of quasi-peak and average individually.
2. The emission levels of other frequencies were very low against the limit.
3. Margin value = Emission level – Limit value
4. Correction factor = Insertion loss + Cable loss
5. Emission Level = Correction Factor + Reading Value

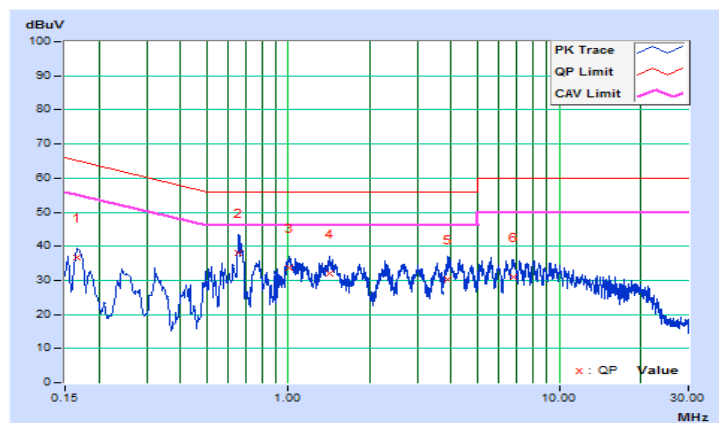

| | | | |
|-----------------|----------------|--|--------------------------------------|
| Frequency Range | 150kHz ~ 30MHz | Detector Function & Resolution Bandwidth | Quasi-Peak (QP) / Average (AV), 9kHz |
| Input Power | 120Vac, 60Hz | Environmental Conditions | 25°C, 75%RH |
| Tested by | Getaz Yang | Test Date | 2017/8/28 |

| Phase Of Power : Neutral (N) | | | | | | | | | | |
|------------------------------|-----------------|------------------------|----------------------|-------|-----------------------|-------|--------------|-------|-------------|--------|
| No | Frequency (MHz) | Correction Factor (dB) | Reading Value (dBuV) | | Emission Level (dBuV) | | Limit (dBuV) | | Margin (dB) | |
| | | | Q.P. | AV. | Q.P. | AV. | Q.P. | AV. | Q.P. | AV. |
| 1 | 0.15400 | 10.11 | 26.98 | 12.66 | 37.09 | 22.77 | 65.78 | 55.78 | -28.69 | -33.01 |
| 2 | 0.16623 | 10.12 | 30.61 | 18.13 | 40.73 | 28.25 | 65.15 | 55.15 | -24.42 | -26.90 |
| 3 | 0.66282 | 10.16 | 27.48 | 19.42 | 37.64 | 29.58 | 56.00 | 46.00 | -18.36 | -16.42 |
| 4 | 1.43000 | 10.20 | 17.71 | 9.90 | 27.91 | 20.10 | 56.00 | 46.00 | -28.09 | -25.90 |
| 5 | 3.13800 | 10.29 | 20.81 | 9.63 | 31.10 | 19.92 | 56.00 | 46.00 | -24.90 | -26.08 |
| 6 | 8.46200 | 10.50 | 16.02 | 9.12 | 26.52 | 19.62 | 60.00 | 50.00 | -33.48 | -30.38 |

Remarks:

1. Q.P. and AV. are abbreviations of quasi-peak and average individually.
2. The emission levels of other frequencies were very low against the limit.
3. Margin value = Emission level – Limit value
4. Correction factor = Insertion loss + Cable loss
5. Emission Level = Correction Factor + Reading Value

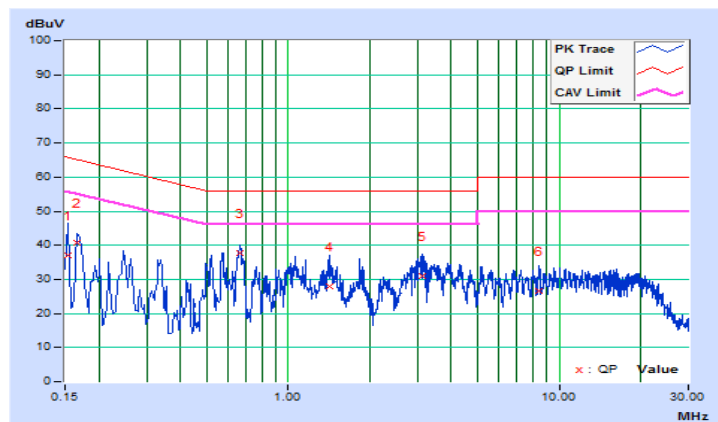

<LE 5.0>

Mode A

| | | | |
|-----------------|----------------|--|--------------------------------------|
| Frequency Range | 150kHz ~ 30MHz | Detector Function & Resolution Bandwidth | Quasi-Peak (QP) / Average (AV), 9kHz |
| Input Power | 120Vac, 60Hz | Environmental Conditions | 25°C, 65%RH |
| Tested by | Getaz Yang | Test Date | 2017/7/28 |

| Phase Of Power : Line (L) | | | | | | | | | | |
|---------------------------|-----------------|------------------------|----------------------|-------|-----------------------|-------|--------------|-------|-------------|--------|
| No | Frequency (MHz) | Correction Factor (dB) | Reading Value (dBuV) | | Emission Level (dBuV) | | Limit (dBuV) | | Margin (dB) | |
| | | | Q.P. | AV. | Q.P. | AV. | Q.P. | AV. | Q.P. | AV. |
| 1 | 0.15760 | 10.35 | 30.42 | 20.21 | 40.77 | 30.56 | 65.59 | 55.59 | -24.82 | -25.03 |
| 2 | 0.61529 | 10.40 | 27.61 | 19.06 | 38.01 | 29.46 | 56.00 | 46.00 | -17.99 | -16.54 |
| 3 | 0.76778 | 10.40 | 24.88 | 16.18 | 35.28 | 26.58 | 56.00 | 46.00 | -20.72 | -19.42 |
| 4 | 2.43735 | 10.48 | 21.39 | 13.38 | 31.87 | 23.86 | 56.00 | 46.00 | -24.13 | -22.14 |
| 5 | 4.49010 | 10.59 | 28.08 | 17.54 | 38.67 | 28.13 | 56.00 | 46.00 | -17.33 | -17.87 |
| 6 | 15.29734 | 11.10 | 32.31 | 21.57 | 43.41 | 32.67 | 60.00 | 50.00 | -16.59 | -17.33 |

Remarks:

1. Q.P. and AV. are abbreviations of quasi-peak and average individually.
2. The emission levels of other frequencies were very low against the limit.
3. Margin value = Emission level – Limit value
4. Correction factor = Insertion loss + Cable loss
5. Emission Level = Correction Factor + Reading Value

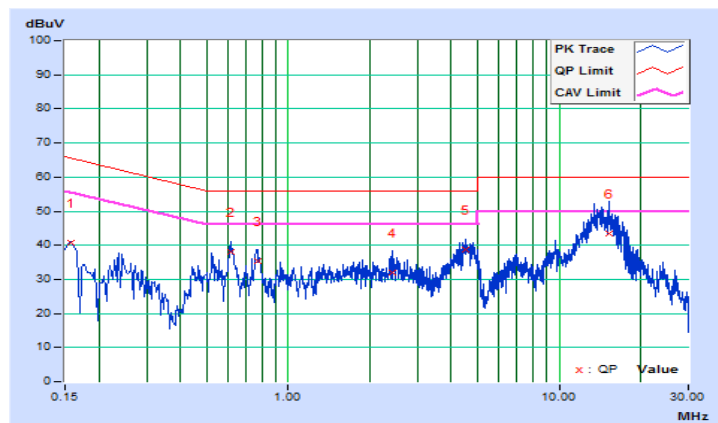

| | | | |
|-----------------|----------------|--|--------------------------------------|
| Frequency Range | 150kHz ~ 30MHz | Detector Function & Resolution Bandwidth | Quasi-Peak (QP) / Average (AV), 9kHz |
| Input Power | 120Vac, 60Hz | Environmental Conditions | 25°C, 65%RH |
| Tested by | Getaz Yang | Test Date | 2017/7/28 |

| Phase Of Power : Neutral (N) | | | | | | | | | | |
|------------------------------|-----------------|------------------------|----------------------|-------|-----------------------|-------|--------------|-------|-------------|--------|
| No | Frequency (MHz) | Correction Factor (dB) | Reading Value (dBuV) | | Emission Level (dBuV) | | Limit (dBuV) | | Margin (dB) | |
| | | | Q.P. | AV. | Q.P. | AV. | Q.P. | AV. | Q.P. | AV. |
| 1 | 0.15000 | 10.10 | 23.32 | 12.47 | 33.42 | 22.57 | 66.00 | 56.00 | -32.58 | -33.43 |
| 2 | 0.60737 | 10.16 | 30.85 | 19.38 | 41.01 | 29.54 | 56.00 | 46.00 | -14.99 | -16.46 |
| 3 | 0.75996 | 10.17 | 28.17 | 16.40 | 38.34 | 26.57 | 56.00 | 46.00 | -17.66 | -19.43 |
| 4 | 2.56638 | 10.26 | 27.24 | 15.89 | 37.50 | 26.15 | 56.00 | 46.00 | -18.50 | -19.85 |
| 5 | 4.77162 | 10.37 | 29.86 | 18.78 | 40.23 | 29.15 | 56.00 | 46.00 | -15.77 | -16.85 |
| 6 | 15.14094 | 10.76 | 34.25 | 22.86 | 45.01 | 33.62 | 60.00 | 50.00 | -14.99 | -16.38 |

Remarks:

1. Q.P. and AV. are abbreviations of quasi-peak and average individually.
2. The emission levels of other frequencies were very low against the limit.
3. Margin value = Emission level – Limit value
4. Correction factor = Insertion loss + Cable loss
5. Emission Level = Correction Factor + Reading Value

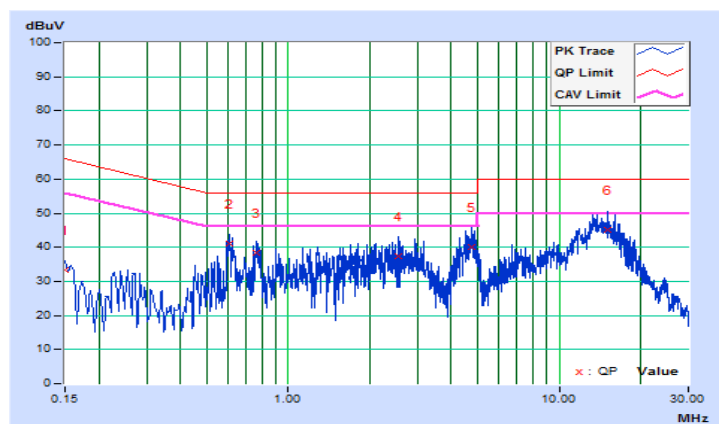

Mode B

| | | | |
|-----------------|----------------|--|--------------------------------------|
| Frequency Range | 150kHz ~ 30MHz | Detector Function & Resolution Bandwidth | Quasi-Peak (QP) / Average (AV), 9kHz |
| Input Power | 120Vac, 60Hz | Environmental Conditions | 25°C, 75%RH |
| Tested by | Getaz Yang | Test Date | 2017/8/28 |

| Phase Of Power : Line (L) | | | | | | | | | | |
|---------------------------|-----------------|------------------------|----------------------|-------|-----------------------|-------|--------------|-------|-------------|--------|
| No | Frequency (MHz) | Correction Factor (dB) | Reading Value (dBuV) | | Emission Level (dBuV) | | Limit (dBuV) | | Margin (dB) | |
| | | | Q.P. | AV. | Q.P. | AV. | Q.P. | AV. | Q.P. | AV. |
| 1 | 0.16200 | 10.35 | 24.10 | 10.85 | 34.45 | 21.20 | 65.36 | 55.36 | -30.91 | -34.16 |
| 2 | 0.66200 | 10.40 | 29.32 | 18.02 | 39.72 | 28.42 | 56.00 | 46.00 | -16.28 | -17.58 |
| 3 | 1.01034 | 10.40 | 21.58 | 11.80 | 31.98 | 22.20 | 56.00 | 46.00 | -24.02 | -23.80 |
| 4 | 1.41400 | 10.42 | 20.04 | 10.49 | 30.46 | 20.91 | 56.00 | 46.00 | -25.54 | -25.09 |
| 5 | 3.97800 | 10.57 | 19.61 | 10.17 | 30.18 | 20.74 | 56.00 | 46.00 | -25.82 | -25.26 |
| 6 | 6.42224 | 10.67 | 18.90 | 10.49 | 29.57 | 21.16 | 60.00 | 50.00 | -30.43 | -28.84 |

Remarks:

1. Q.P. and AV. are abbreviations of quasi-peak and average individually.
2. The emission levels of other frequencies were very low against the limit.
3. Margin value = Emission level – Limit value
4. Correction factor = Insertion loss + Cable loss
5. Emission Level = Correction Factor + Reading Value

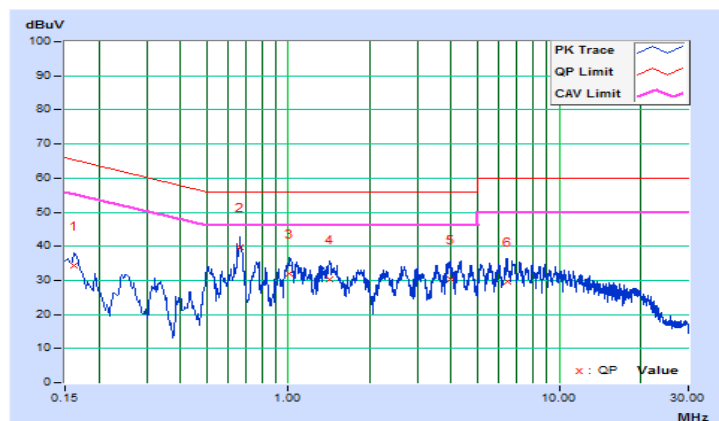

| | | | |
|-----------------|----------------|--|--------------------------------------|
| Frequency Range | 150kHz ~ 30MHz | Detector Function & Resolution Bandwidth | Quasi-Peak (QP) / Average (AV), 9kHz |
| Input Power | 120Vac, 60Hz | Environmental Conditions | 25°C, 75%RH |
| Tested by | Getaz Yang | Test Date | 2017/8/28 |

| Phase Of Power : Neutral (N) | | | | | | | | | | |
|------------------------------|-----------------|------------------------|----------------------|-------|-----------------------|-------|--------------|-------|-------------|--------|
| No | Frequency (MHz) | Correction Factor (dB) | Reading Value (dBuV) | | Emission Level (dBuV) | | Limit (dBuV) | | Margin (dB) | |
| | | | Q.P. | AV. | Q.P. | AV. | Q.P. | AV. | Q.P. | AV. |
| 1 | 0.17384 | 10.12 | 21.13 | 14.02 | 31.25 | 24.14 | 64.77 | 54.77 | -33.52 | -30.63 |
| 2 | 0.31781 | 10.15 | 20.67 | 17.35 | 30.82 | 27.50 | 59.76 | 49.76 | -28.94 | -22.26 |
| 3 | 0.66600 | 10.16 | 26.85 | 15.94 | 37.01 | 26.10 | 56.00 | 46.00 | -18.99 | -19.90 |
| 4 | 1.41800 | 10.20 | 20.20 | 10.38 | 30.40 | 20.58 | 56.00 | 46.00 | -25.60 | -25.42 |
| 5 | 1.70223 | 10.21 | 21.15 | 11.84 | 31.36 | 22.05 | 56.00 | 46.00 | -24.64 | -23.95 |
| 6 | 16.22600 | 10.80 | 24.85 | 22.82 | 35.65 | 33.62 | 60.00 | 50.00 | -24.35 | -16.38 |

Remarks:

1. Q.P. and AV. are abbreviations of quasi-peak and average individually.
2. The emission levels of other frequencies were very low against the limit.
3. Margin value = Emission level – Limit value
4. Correction factor = Insertion loss + Cable loss
5. Emission Level = Correction Factor + Reading Value

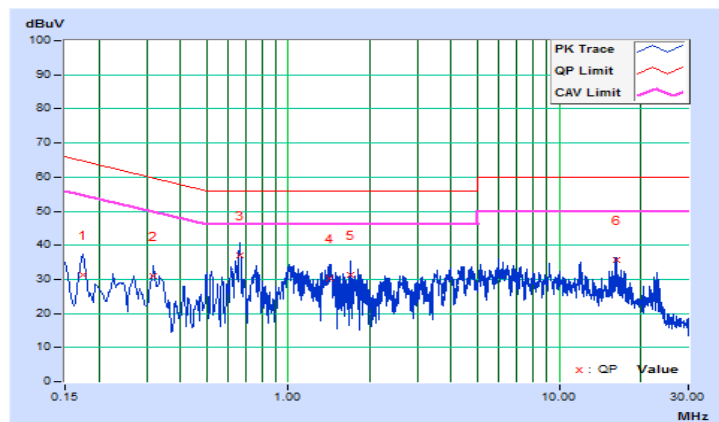

4.3 6 dB Bandwidth Measurement

4.3.1 Limits of 6 dB Bandwidth Measurement

The minimum of 6 dB Bandwidth Measurement is 0.5 MHz.

4.3.2 Test Setup

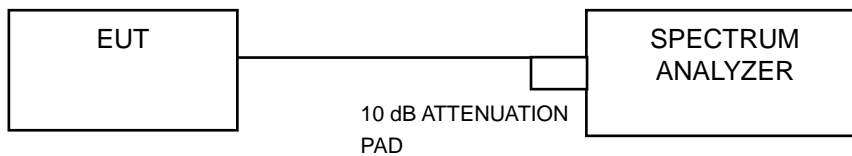

4.3.3 Test Instruments

Refer to section 4.1.2 to get information of above instrument.

4.3.4 Test Procedure

- Set resolution bandwidth (RBW) = 100 kHz
- Set the video bandwidth (VBW) $\geq 3 \times$ RBW, Detector = Peak.
- Trace mode = max hold.
- Sweep = auto couple.
- Measure the maximum width of the emission that is constrained by the frequencies associated with the two amplitude points (upper and lower) that are attenuated by 6 dB relative to the maximum level measured in the fundamental emission

4.3.5 Deviation from Test Standard

No deviation.

4.3.6 EUT Operating Conditions

The software provided by client to enable the EUT under transmission condition continuously at lowest, middle and highest channel frequencies individually.

4.3.7 Test Result

<LE 4.0>

| Channel | Frequency (MHz) | 6 dB Bandwidth (MHz) | Minimum Limit (MHz) | Pass / Fail |
|---------|-----------------|----------------------|---------------------|-------------|
| 0 | 2402 | 0.67 | 0.5 | Pass |
| 19 | 2440 | 0.67 | 0.5 | Pass |
| 39 | 2480 | 0.67 | 0.5 | Pass |

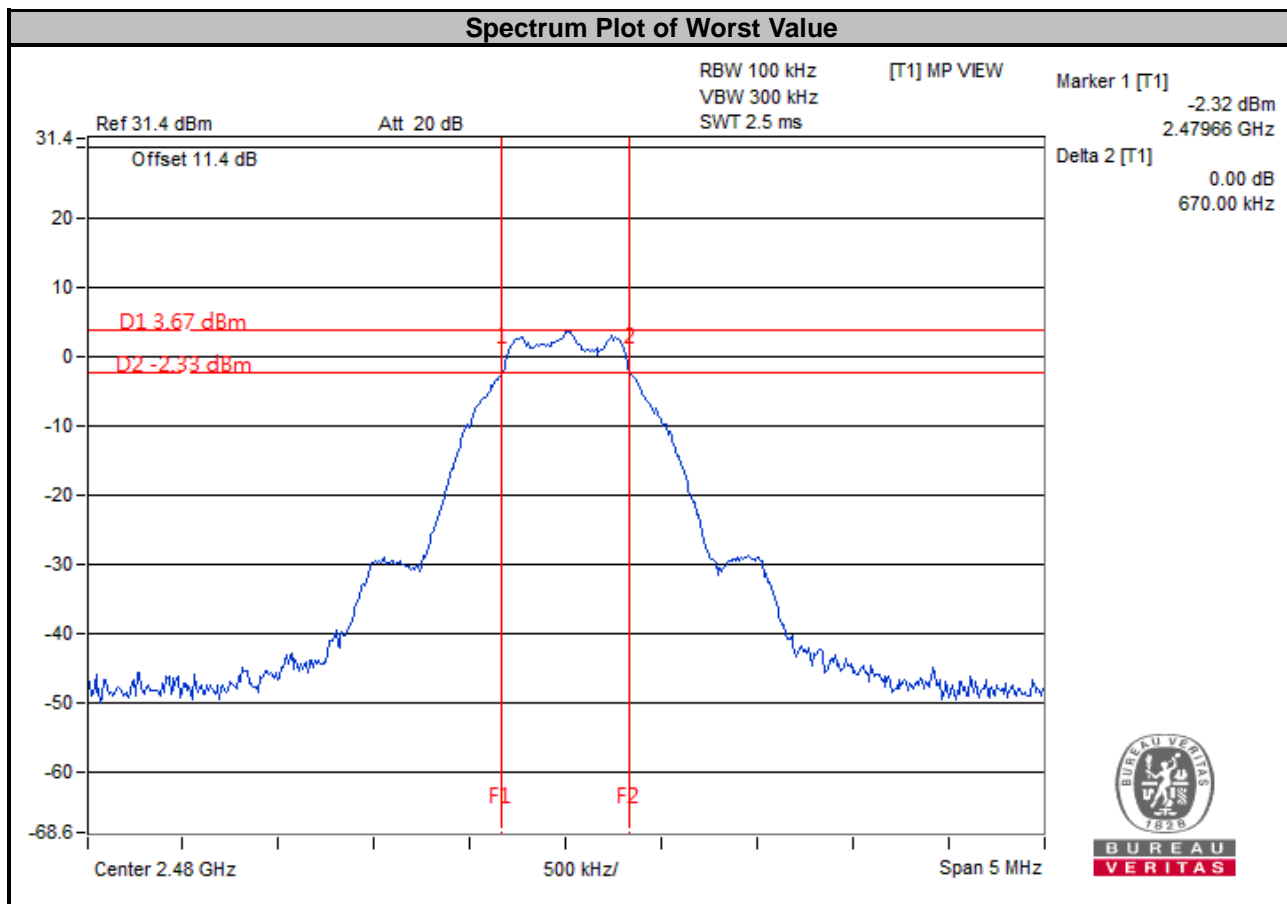

4.4 Occupied Bandwidth Measurement

4.4.1 Test SetUp

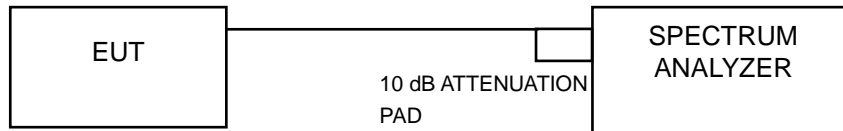

4.4.2 Test Instruments

Refer to section 4.1.2 to get information of above instrument.

4.4.3 Test Procedure

The transmitter output was connected to the spectrum analyzer through an attenuator. The bandwidth of the fundamental frequency was measured by spectrum analyzer with resolution bandwidth in the range of 1 % to 5 % of the anticipated emission bandwidth, and a video bandwidth at least 3x the resolution bandwidth and set the detector to PEAK. The width of a frequency band such that, below the lower and above the upper frequency limits, the mean powers emitted are each equal to a specified percentage 0.5 % of the total mean power of a given emission.

4.4.4 Deviation From Test Standard

No deviation.

4.4.5 EUT Operating Conditions

The software provided by client to enable the EUT under transmission condition continuously at lowest, middle and highest channel frequencies individually.

4.4.6 Test Results

<LE 4.0>

| Channel | Frequency (MHz) | Occupied Bandwidth (MHz) | Pass / Fail |
|---------|-----------------|--------------------------|-------------|
| 0 | 2402 | 1.05 | Pass |
| 19 | 2440 | 1.06 | Pass |
| 39 | 2480 | 1.05 | Pass |

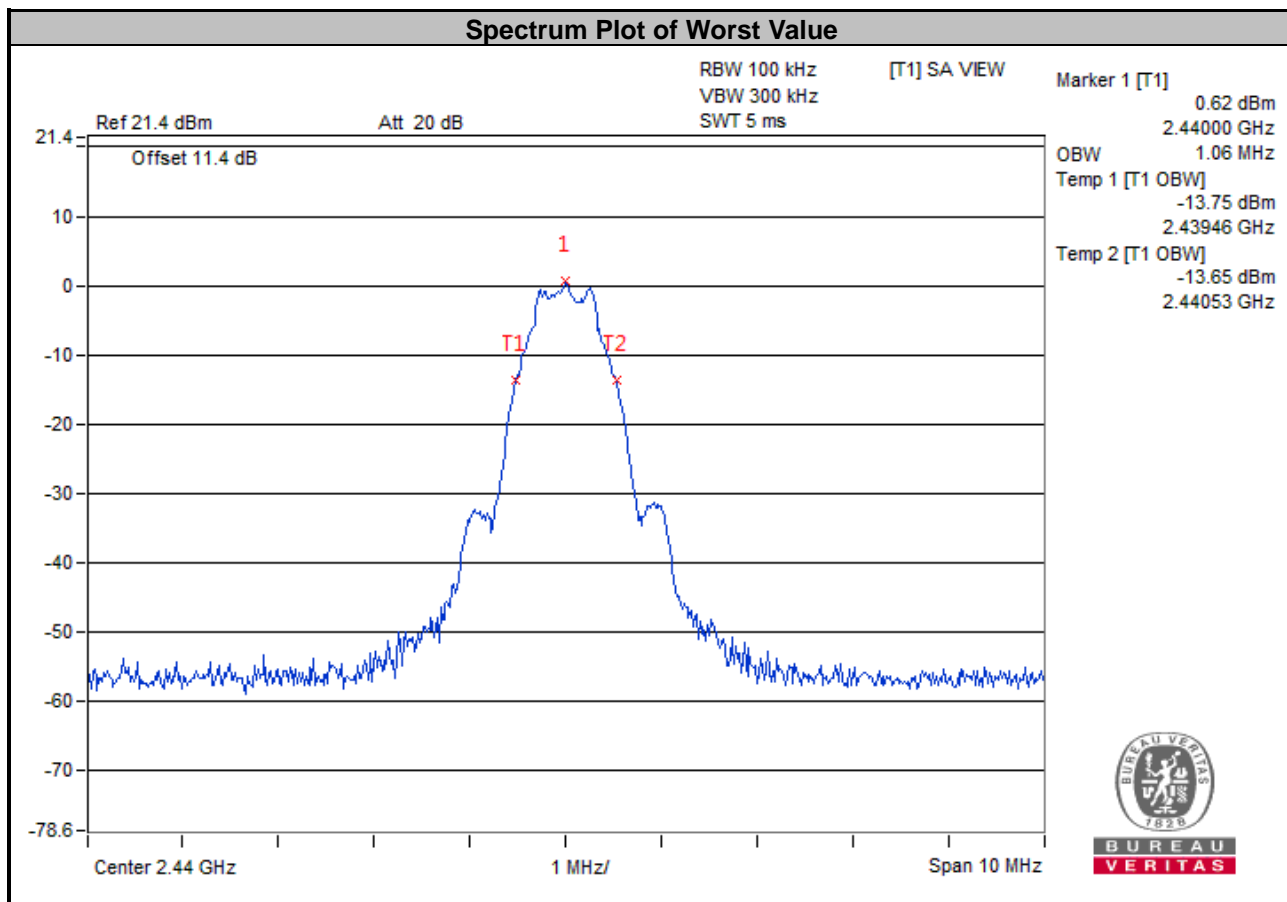

<LE 5.0>

| Channel | Frequency (MHz) | Occupied Bandwidth (MHz) | Pass / Fail |
|---------|-----------------|--------------------------|-------------|
| 0 | 2402 | 2.06 | Pass |
| 19 | 2440 | 2.06 | Pass |
| 39 | 2480 | 2.06 | Pass |

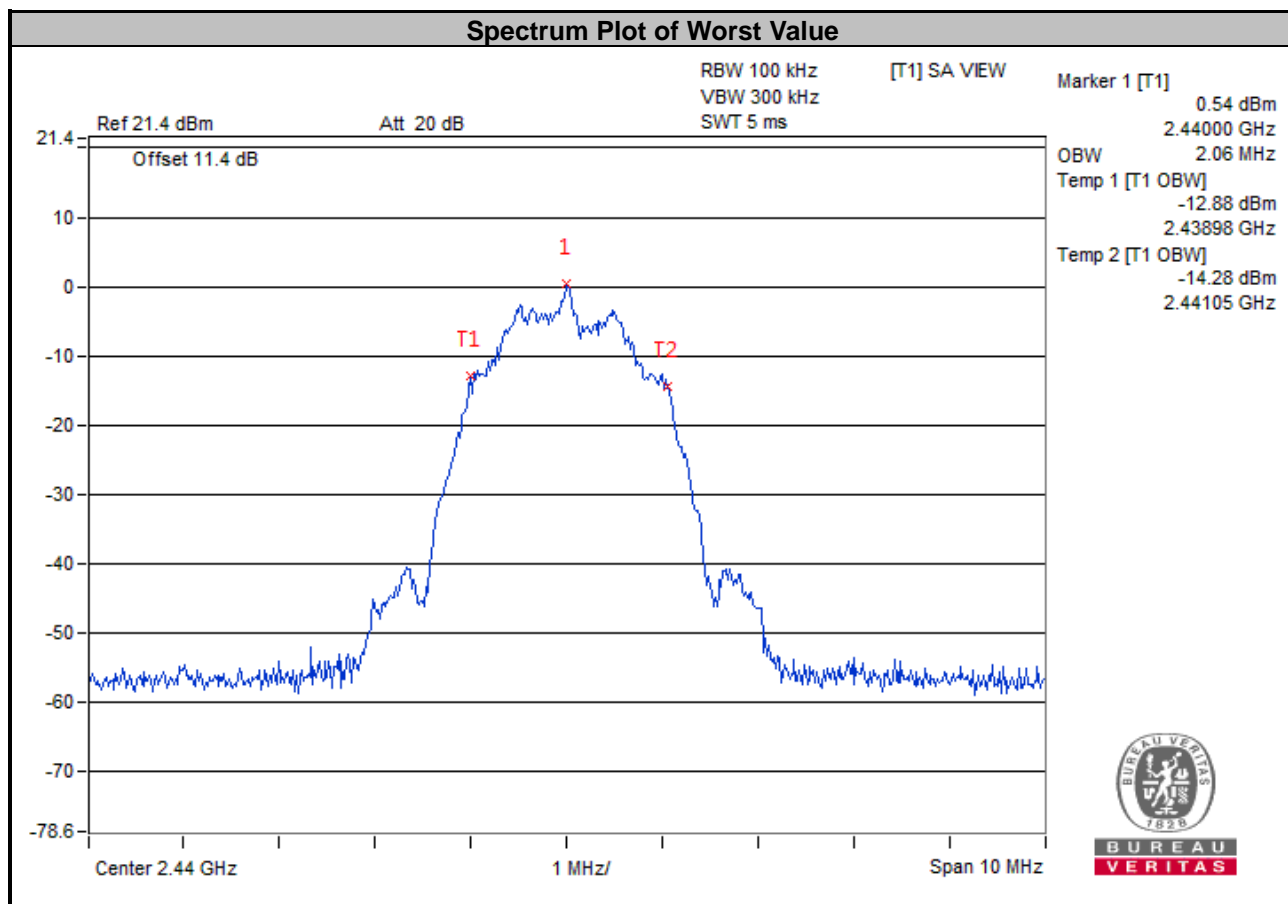

4.5 Conducted Output Power Measurement

4.5.1 Limits of Conducted Output Power Measurement

For systems using digital modulation in the 2400–2483.5 MHz bands: 1 Watt (30 dBm)

4.5.2 Test Setup

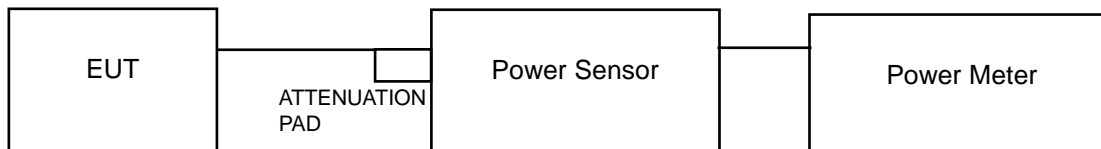

4.5.3 Test Instruments

Refer to section 4.1.2 to get information of above instrument.

4.5.4 Test Procedures

A peak / average power sensor was used on the output port of the EUT. A power meter was used to read the response of the peak / average power sensor. Record the power level.

4.5.5 Deviation from Test Standard

No deviation.

4.5.6 EUT Operating Conditions

The software provided by client to enable the EUT under transmission condition continuously at lowest, middle and highest channel frequencies individually.

4.5.7 Test Results

<LE 4.0>

| Channel | Frequency (MHz) | Peak Power (mW) | Peak Power (dBm) | Limit (dBm) | Pass / Fail |
|---------|-----------------|-----------------|------------------|-------------|-------------|
| 0 | 2402 | 2.582 | 4.12 | 30 | Pass |
| 19 | 2440 | 1.589 | 2.01 | 30 | Pass |
| 39 | 2480 | 2.642 | 4.22 | 30 | Pass |

<LE 5.0>

| Channel | Frequency (MHz) | Peak Power (mW) | Peak Power (dBm) | Limit (dBm) | Pass / Fail |
|---------|-----------------|-----------------|------------------|-------------|-------------|
| 0 | 2402 | 2.729 | 4.36 | 30 | Pass |
| 19 | 2440 | 1.698 | 2.30 | 30 | Pass |
| 39 | 2480 | 2.805 | 4.48 | 30 | Pass |

4.6 Power Spectral Density Measurement

4.6.1 Limits of Power Spectral Density Measurement

The Maximum of Power Spectral Density Measurement is 8 dBm.

4.6.2 Test Setup

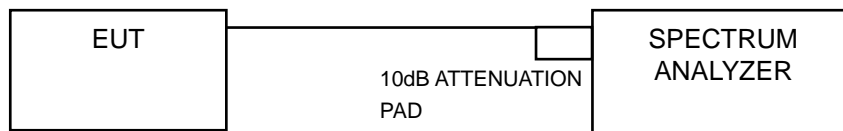

4.6.3 Test Instruments

Refer to section 4.1.2 to get information of above instrument.

4.6.4 Test Procedure

- Set the RBW = 3 kHz, VBW = 10 kHz, Detector = peak.
- Sweep time = auto couple, Trace mode = max hold, allow trace to fully stabilize.
- Use the peak marker function to determine the maximum power level in any 100 kHz band segment within the fundamental EBW.

4.6.5 Deviation from Test Standard

No deviation.

4.6.6 EUT Operating Condition

The software provided by client to enable the EUT under transmission condition continuously at lowest, middle and highest channel frequencies individually.

4.6.7 Test Results

<LE 4.0>

| Channel | Frequency (MHz) | PSD (dBm/3 kHz) | Limit (dBm/3 kHz) | Pass / Fail |
|---------|-----------------|-----------------|-------------------|-------------|
| 0 | 2402 | -11.26 | 8 | Pass |
| 19 | 2440 | -13.84 | 8 | Pass |
| 39 | 2480 | -10.78 | 8 | Pass |

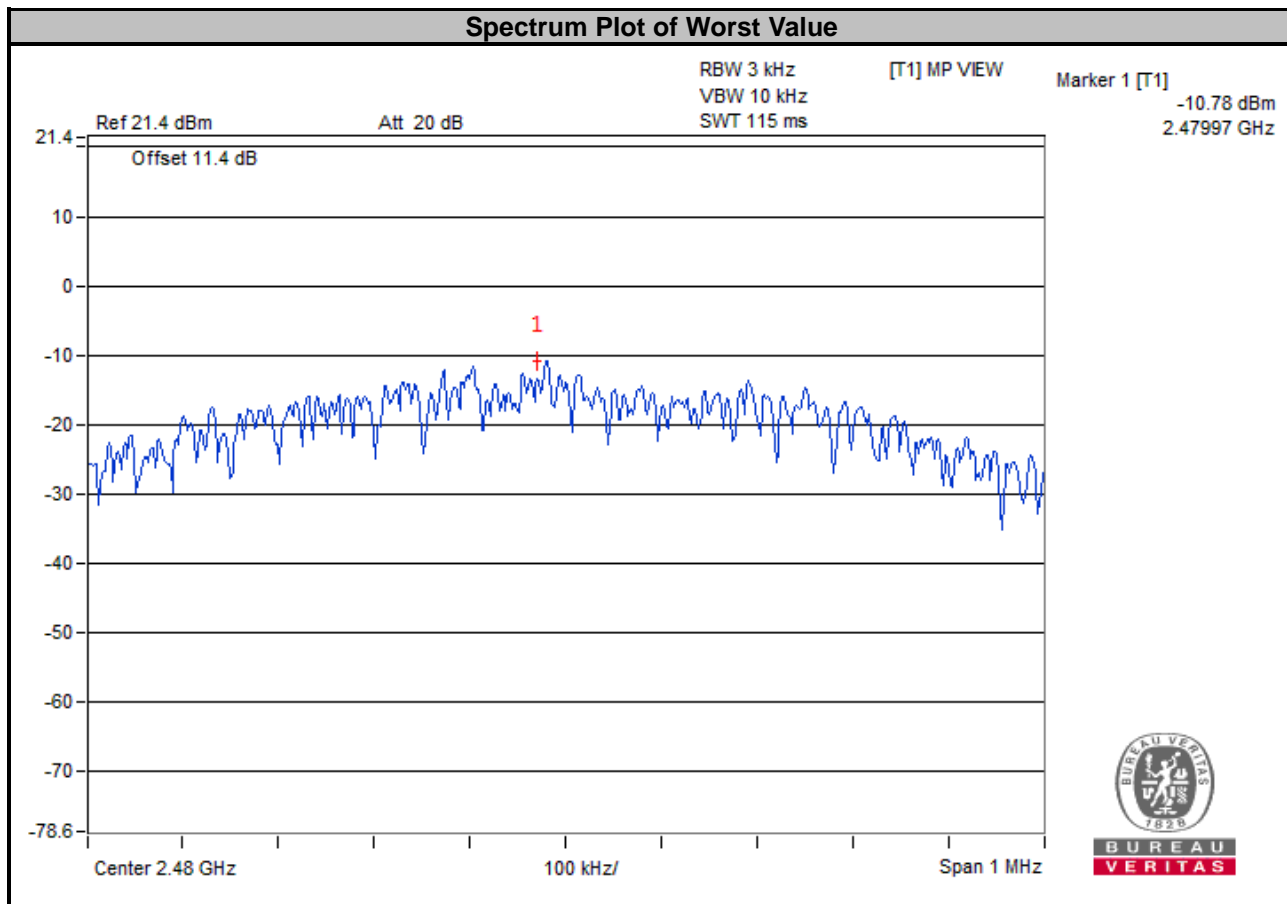

<LE 5.0>

| Channel | Frequency (MHz) | PSD (dBm/3 kHz) | Limit (dBm/3 kHz) | Pass / Fail |
|---------|-----------------|-----------------|-------------------|-------------|
| 0 | 2402 | -14.94 | 8 | Pass |
| 19 | 2440 | -17.41 | 8 | Pass |
| 39 | 2480 | -14.37 | 8 | Pass |

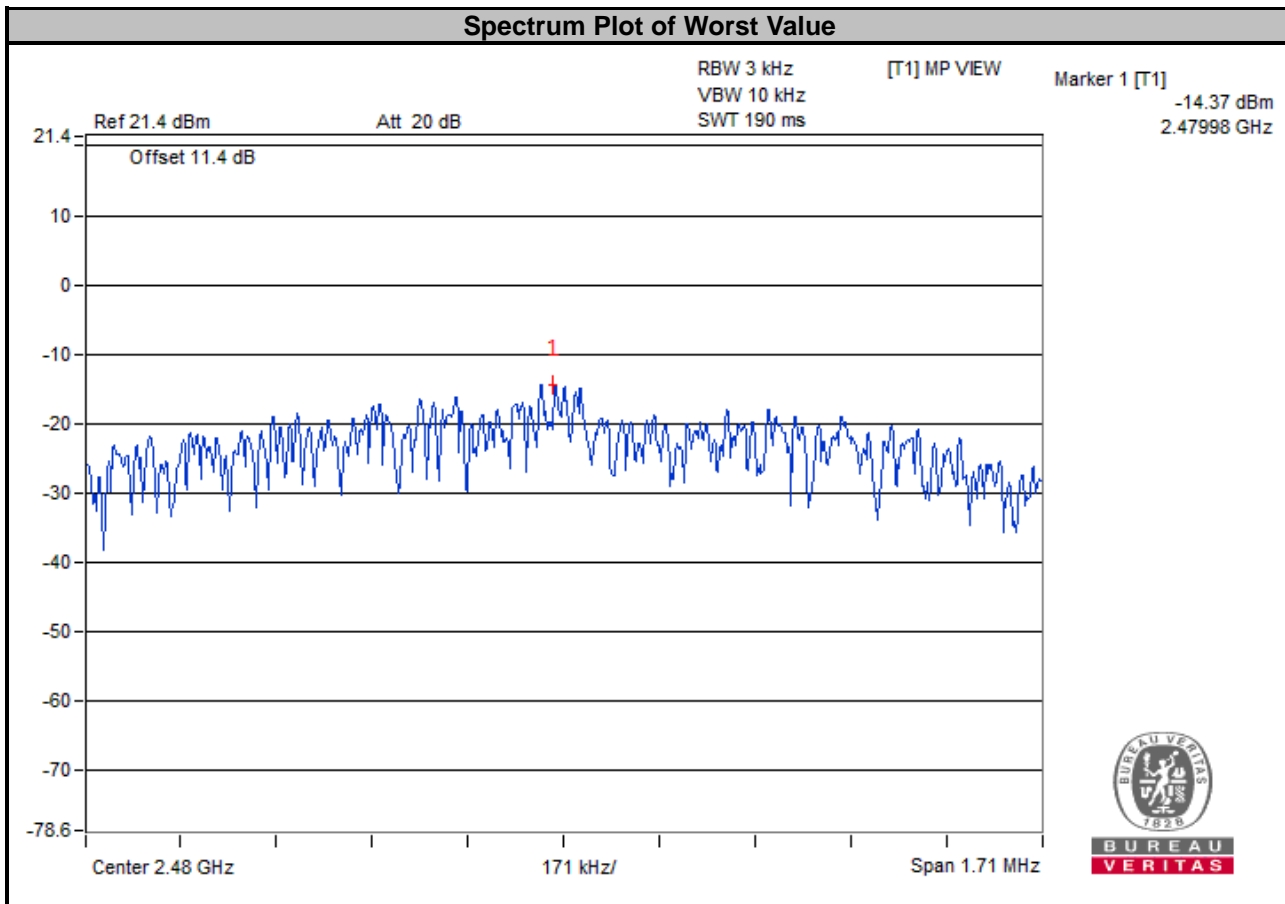

4.7 Conducted Out of Band Emission Measurement

4.7.1 Limits of Conducted Out of Band Emission Measurement

Below -20 dB of the highest emission level of operating band (in 100 kHz Resolution Bandwidth).

4.7.2 Test Setup

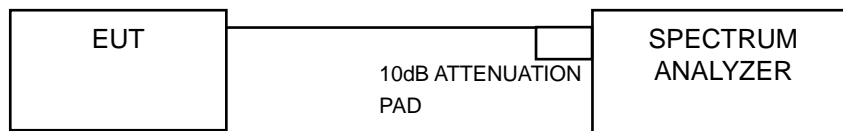

4.7.3 Test Instruments

Refer to section 4.1.2 to get information of above instrument.

4.7.4 Test Procedure

MEASUREMENT PROCEDURE REF

1. Set the RBW = 100 kHz.
2. Set the VBW \geq 300 kHz.
3. Detector = peak.
4. Sweep time = auto couple.
5. Trace mode = max hold.
6. Allow trace to fully stabilize.
7. Use the peak marker function to determine the maximum power level in any 100 kHz band segment within the fundamental EBW.

MEASUREMENT PROCEDURE OOB

1. Set RBW = 100 kHz.
2. Set VBW \geq 300 kHz.
3. Detector = peak.
4. Sweep = auto couple.
5. Trace Mode = max hold.
6. Allow trace to fully stabilize.
7. Use the peak marker function to determine the maximum amplitude level.

4.7.5 Deviation from Test Standard

No deviation.

4.7.6 EUT Operating Condition

The software provided by client to enable the EUT under transmission condition continuously at lowest, middle and highest channel frequencies individually.

4.7.7 TEST RESULTS

<LE 4.0>

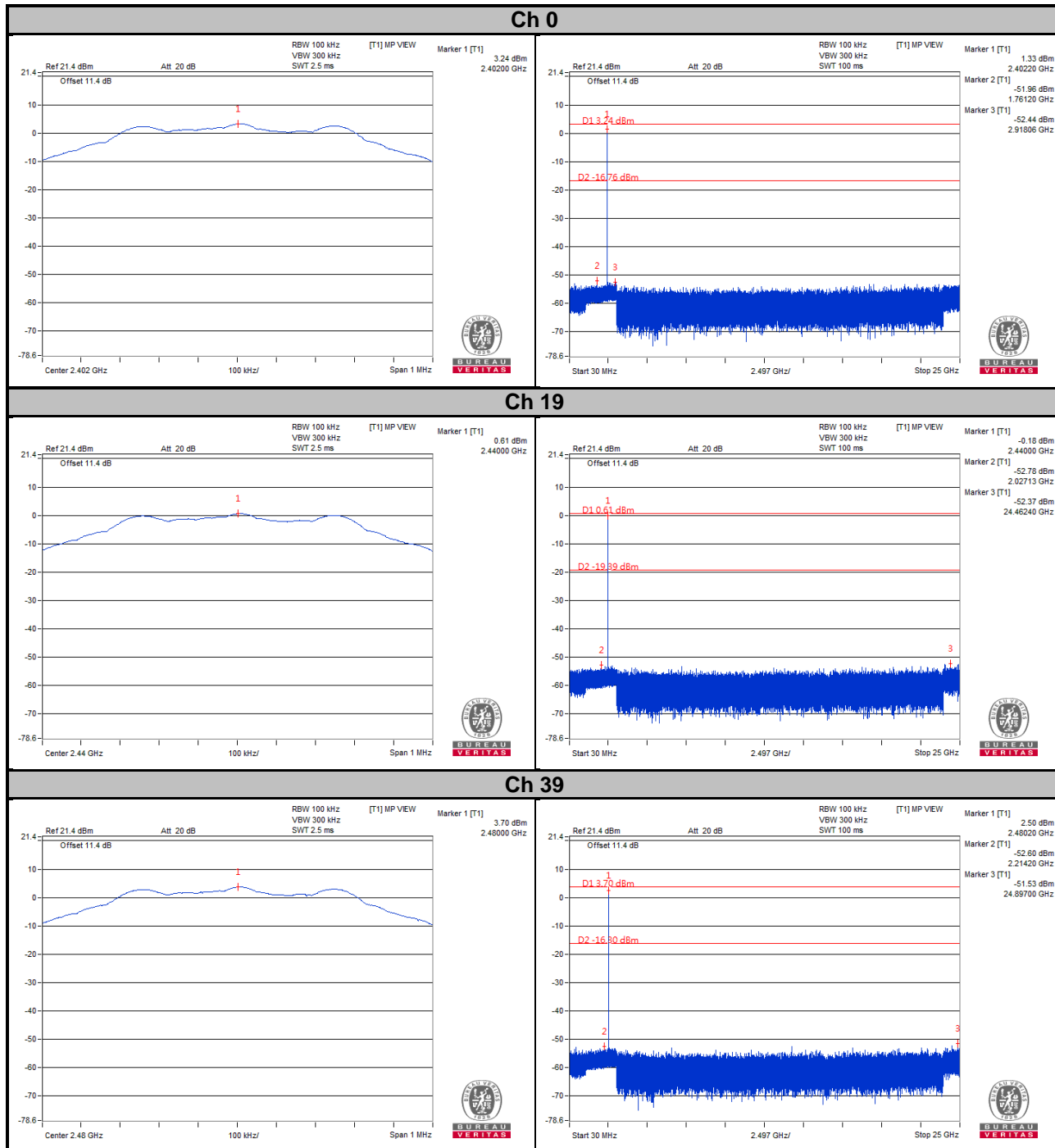

Ch 0 Band Edge

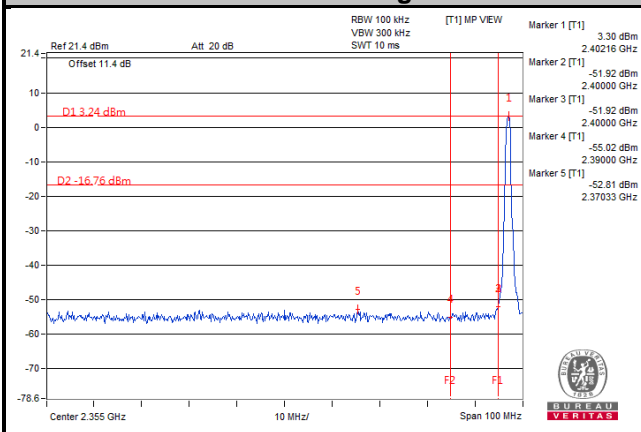

Ch 39 Band Edge

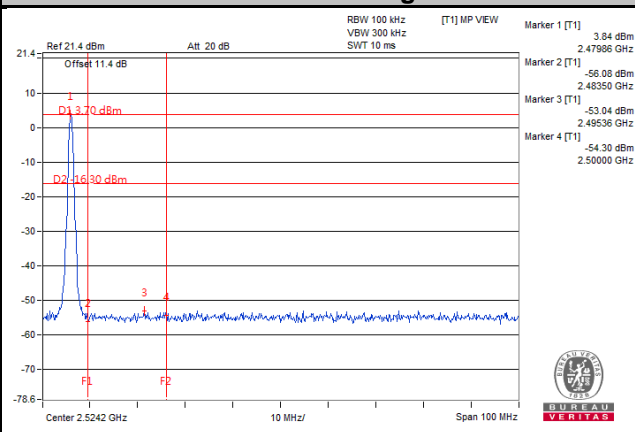

<LE 5.0>

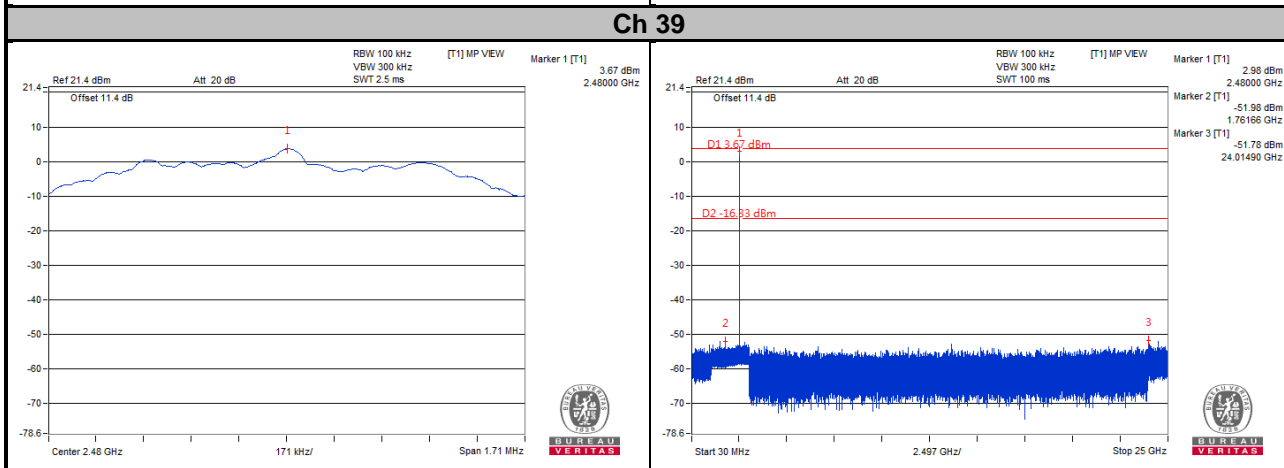
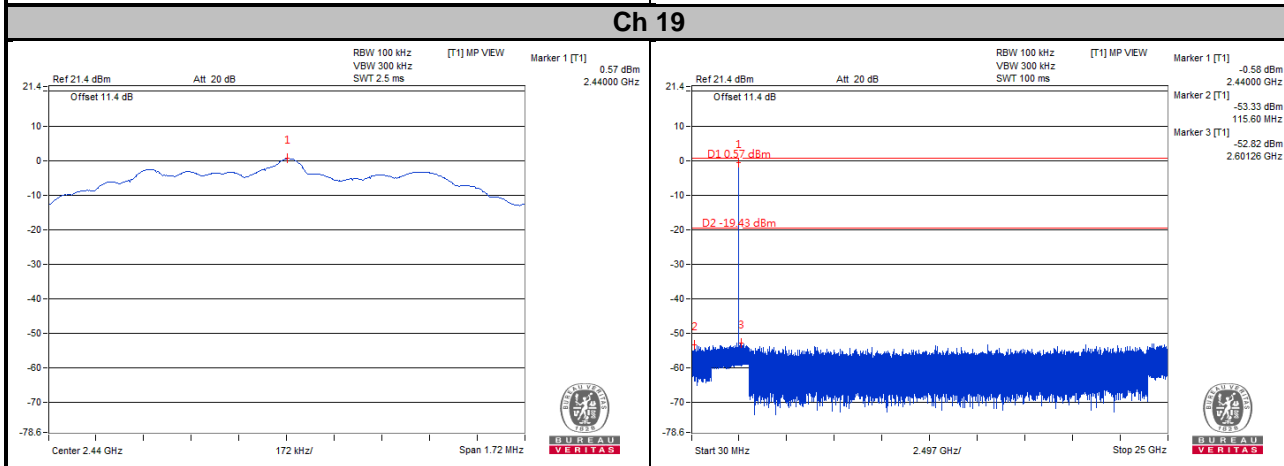
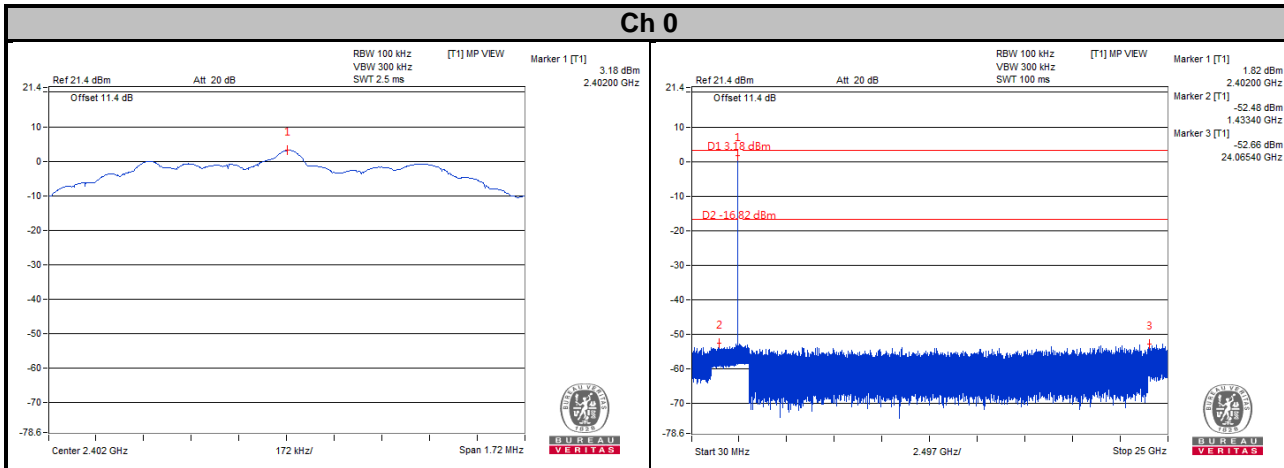

Ch 0 Band Edge

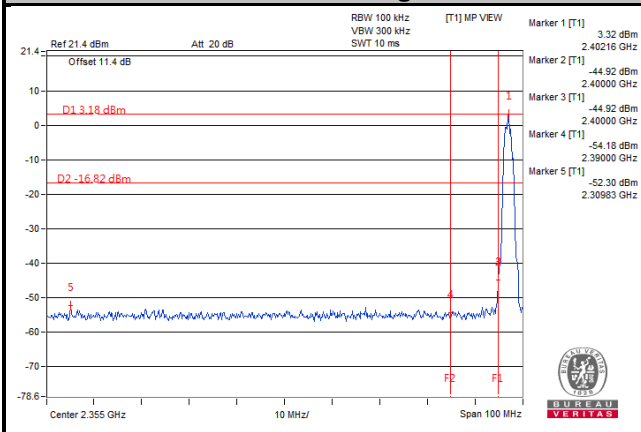

Ch 39 Band Edge

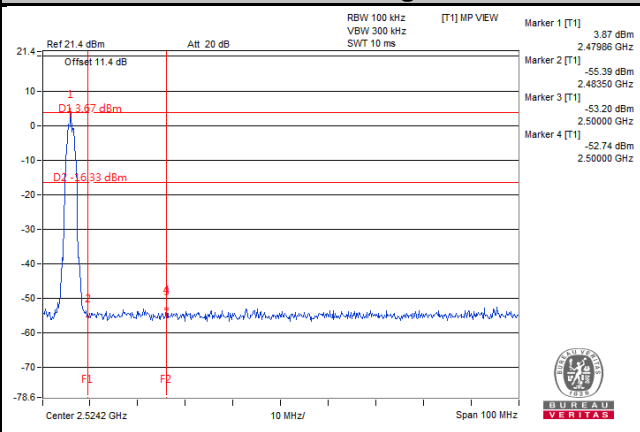

5 Pictures of Test Arrangements

Please refer to the attached file (Test Setup Photo).

Appendix – Information on the Testing Laboratories

We, Bureau Veritas Consumer Products Services (H.K.) Ltd., Taoyuan Branch, were founded in 1988 to provide our best service in EMC, Radio, Telecom and Safety consultation. Our laboratories are accredited and approved according to ISO/IEC 17025.

If you have any comments, please feel free to contact us at the following:

Linko EMC/RF Lab

Tel: 886-2-26052180

Fax: 886-2-26051924

Hsin Chu EMC/RF/Telecom Lab

Tel: 886-3-6668565

Fax: 886-3-6668323

Hwa Ya EMC/RF/Safety

Tel: 886-3-3183232

Fax: 886-3-3270892

Email: service.adt@tw.bureauveritas.com

Web Site: www.bureauveritas-adt.com

The address and road map of all our labs can be found in our web site also.

--- END ---