



# Calibration Certificate of DASY

**Calibration Laboratory of**  
**Schmid & Partner**  
**Engineering AG**  
 Zeughausstrasse 43, 8004 Zurich, Switzerland



**S** Schweizerischer Kalibrierdienst  
**C** Service suisse d'étalonnage  
**S** Servizio svizzero di taratura  
**S** Swiss Calibration Service

Accredited by the Swiss Accreditation Service (SAS)  
 The Swiss Accreditation Service is one of the signatories to the EA  
 Multilateral Agreement for the recognition of calibration certificates

Accreditation No.: **SCS 108**

Client **Sporton (Auden)**

Certificate No: **D835V2-499\_Mar08**

## CALIBRATION CERTIFICATE

Object **D835V2 - SN: 499**

Calibration procedure(s) **QA CAL-05.v7  
 Calibration procedure for dipole validation kits**

Calibration date: **March 17, 2008**

Condition of the calibrated item **In Tolerance**

This calibration certificate documents the traceability to national standards, which realize the physical units of measurements (SI).  
 The measurements and the uncertainties with confidence probability are given on the following pages and are part of the certificate.

All calibrations have been conducted in the closed laboratory facility: environment temperature (22 ± 3)°C and humidity < 70%.

Calibration Equipment used (M&TE critical for calibration)

Primary Standards	ID #	Cal Date (Calibrated by, Certificate No.)	Scheduled Calibration
Power meter EPM-442A	GB37480704	04-Oct-07 (METAS, No. 217-00736)	Oct-08
Power sensor HP 8481A	US37292783	04-Oct-07 (METAS, No. 217-00736)	Oct-08
Reference 20 dB Attenuator	SN: 5086 (20g)	07-Aug-07 (METAS, No 217-00718)	Aug-08
Reference Probe ES3DV2	SN: 3025	01-Mar-08 (SPEAG, No. ES3-3025_Mar08)	Mar-09
DAE4	SN 909	03-Sep-07 (SPEAG, No. DAE4-909_Sep07)	Sep-08

Secondary Standards	ID #	Check Date (in house)	Scheduled Check
Power sensor HP 8481A	MY41092317	18-Oct-02 (SPEAG, in house check Oct-07)	In house check: Oct-09
RF generator R&S SMT-06	100005	04-Aug-99 (SPEAG, in house check Oct-07)	In house check: Oct-09
Network Analyzer HP 8753E	US37390585 S4206	18-Oct-01 (SPEAG, in house check Oct-07)	In house check: Oct-08

	Name	Function	Signature
Calibrated by:	Claudio Leubler	Laboratory Technician	
Approved by:	Katja Pokovic	Technical Manager	

Issued: March 17, 2008

This calibration certificate shall not be reproduced except in full without written approval of the laboratory.



**Calibration Laboratory of**  
Schmid & Partner  
Engineering AG  
Zeughausstrasse 43, 8004 Zurich, Switzerland



**S** Schweizerischer Kalibrierdienst  
**C** Service suisse d'étalonnage  
**S** Servizio svizzero di taratura  
**S** Swiss Calibration Service

Accredited by the Swiss Accreditation Service (SAS)  
The Swiss Accreditation Service is one of the signatories to the EA  
Multilateral Agreement for the recognition of calibration certificates

Accreditation No.: **SCS 108**

**Glossary:**

TSL tissue simulating liquid  
ConvF sensitivity in TSL / NORM x,y,z  
N/A not applicable or not measured

**Calibration is Performed According to the Following Standards:**

- a) IEEE Std 1528-2003, "IEEE Recommended Practice for Determining the Peak Spatial-Averaged Specific Absorption Rate (SAR) in the Human Head from Wireless Communications Devices: Measurement Techniques", December 2003
- b) IEC 62209-1, "Procedure to measure the Specific Absorption Rate (SAR) for hand-held devices used in close proximity to the ear (frequency range of 300 MHz to 3 GHz)", February 2005
- c) Federal Communications Commission Office of Engineering & Technology (FCC OET), "Evaluating Compliance with FCC Guidelines for Human Exposure to Radiofrequency Electromagnetic Fields; Additional Information for Evaluating Compliance of Mobile and Portable Devices with FCC Limits for Human Exposure to Radiofrequency Emissions", Supplement C (Edition 01-01) to Bulletin 65

**Additional Documentation:**

- d) DASY4 System Handbook

**Methods Applied and Interpretation of Parameters:**

- *Measurement Conditions:* Further details are available from the Validation Report at the end of the certificate. All figures stated in the certificate are valid at the frequency indicated.
- *Antenna Parameters with TSL:* The dipole is mounted with the spacer to position its feed point exactly below the center marking of the flat phantom section, with the arms oriented parallel to the body axis.
- *Feed Point Impedance and Return Loss:* These parameters are measured with the dipole positioned under the liquid filled phantom. The impedance stated is transformed from the measurement at the SMA connector to the feed point. The Return Loss ensures low reflected power. No uncertainty required.
- *Electrical Delay:* One-way delay between the SMA connector and the antenna feed point. No uncertainty required.
- *SAR measured:* SAR measured at the stated antenna input power.
- *SAR normalized:* SAR as measured, normalized to an input power of 1 W at the antenna connector.
- *SAR for nominal TSL parameters:* The measured TSL parameters are used to calculate the nominal SAR result.



**Measurement Conditions**

DASY system configuration, as far as not given on page 1.

DASY Version	DASY4	V4.7
Extrapolation	Advanced Extrapolation	
Phantom	Modular Flat Phantom V4.9	
Distance Dipole Center - TSL	15 mm	with Spacer
Zoom Scan Resolution	dx, dy, dz = 5 mm	
Frequency	835 MHz ± 1 MHz	

**Head TSL parameters**

The following parameters and calculations were applied.

	Temperature	Permittivity	Conductivity
Nominal Head TSL parameters	22.0 °C	41.5	0.90 mho/m
Measured Head TSL parameters	(22.0 ± 0.2) °C	41.5 ± 6 %	0.90 mho/m ± 6 %
Head TSL temperature during test	(22.0 ± 0.2) °C	----	----

**SAR result with Head TSL**

SAR averaged over 1 cm <sup>3</sup> (1 g) of Head TSL	Condition	
SAR measured	250 mW input power	2.29 mW / g
SAR normalized	normalized to 1W	9.16 mW / g
SAR for nominal Head TSL parameters <sup>1</sup>	normalized to 1W	<b>9.16 mW / g ± 17.0 % (k=2)</b>

SAR averaged over 10 cm <sup>3</sup> (10 g) of Head TSL	condition	
SAR measured	250 mW input power	1.50 mW / g
SAR normalized	normalized to 1W	6.00 mW / g
SAR for nominal Head TSL parameters <sup>1</sup>	normalized to 1W	<b>6.00 mW / g ± 16.5 % (k=2)</b>

<sup>1</sup> Correction to nominal TSL parameters according to d), chapter "SAR Sensitivities"



**Body TSL parameters**

The following parameters and calculations were applied.

	Temperature	Permittivity	Conductivity
Nominal Body TSL parameters	22.0 °C	55.2	0.97 mho/m
Measured Body TSL parameters	(22.0 ± 0.2) °C	54.0 ± 6 %	1.00 mho/m ± 6 %
Body TSL temperature during test	(22.0 ± 0.2) °C	---	---

**SAR result with Body TSL**

SAR averaged over 1 cm <sup>3</sup> (1 g) of Body TSL	Condition	
SAR measured	250 mW input power	2.46 mW / g
SAR normalized	normalized to 1W	9.84 mW / g
SAR for nominal Body TSL parameters <sup>2</sup>	normalized to 1W	<b>9.52 mW / g ± 17.0 % (k=2)</b>

SAR averaged over 10 cm <sup>3</sup> (10 g) of Body TSL	condition	
SAR measured	250 mW input power	1.63 mW / g
SAR normalized	normalized to 1W	6.52 mW / g
SAR for nominal Body TSL parameters <sup>2</sup>	normalized to 1W	<b>6.37 mW / g ± 16.5 % (k=2)</b>

<sup>2</sup> Correction to nominal TSL parameters according to d), chapter "SAR Sensitivities"





**Appendix**

**Antenna Parameters with Head TSL**

Impedance, transformed to feed point	52.9 $\Omega$ - 2.3 j $\Omega$
Return Loss	- 28.9 dB

**Antenna Parameters with Body TSL**

Impedance, transformed to feed point	49.2 $\Omega$ - 3.3 j $\Omega$
Return Loss	- 29.3 dB

**General Antenna Parameters and Design**

Electrical Delay (one direction)	1.392 ns
----------------------------------	----------

After long term use with 100W radiated power, only a slight warming of the dipole near the feedpoint can be measured.

The dipole is made of standard semirigid coaxial cable. The center conductor of the feeding line is directly connected to the second arm of the dipole. The antenna is therefore short-circuited for DC-signals.

No excessive force must be applied to the dipole arms, because they might bend or the soldered connections near the feedpoint may be damaged.

**Additional EUT Data**

Manufactured by	SPEAG
Manufactured on	July 10, 2003

**DASY4 Validation Report for Head TSL**

Date/Time: 17.03.2008 11:32:45

Test Laboratory: SPEAG, Zurich, Switzerland

**DUT: Dipole 835 MHz; Type: D835V2; Serial: D835V2 - SN:499**

Communication System: CW-835; Frequency: 835 MHz; Duty Cycle: 1:1

Medium: HSL 900 MHz;

Medium parameters used:  $f = 835 \text{ MHz}$ ;  $\sigma = 0.9 \text{ mho/m}$ ;  $\epsilon_r = 41.5$ ;  $\rho = 1000 \text{ kg/m}^3$

Phantom section: Flat Section

Measurement Standard: DASY4 (High Precision Assessment)

DASY4 Configuration:

- Probe: ES3DV2 - SN3025; ConvF(6.09, 6.09, 6.09); Calibrated: 01.03.2008
- Sensor-Surface: 3.4mm (Mechanical Surface Detection)
- Electronics: DAE4 Sn909; Calibrated: 03.09.2007
- Phantom: Flat Phantom 4.9L; Type: QD000P49AA; ;
- Measurement SW: DASY4, V4.7 Build 55; Postprocessing SW: SEMCAD, V1.8 Build 172

**Unnamed procedure/Zoom Scan (7x7x7)/Cube 0:**

Measurement grid:  $dx=5\text{mm}$ ,  $dy=5\text{mm}$ ,  $dz=5\text{mm}$

Reference Value = 54.9 V/m; Power Drift = -0.005 dB

Peak SAR (extrapolated) = 3.34 W/kg

**SAR(1 g) = 2.29 mW/g; SAR(10 g) = 1.5 mW/g**

Maximum value of SAR (measured) = 2.58 mW/g

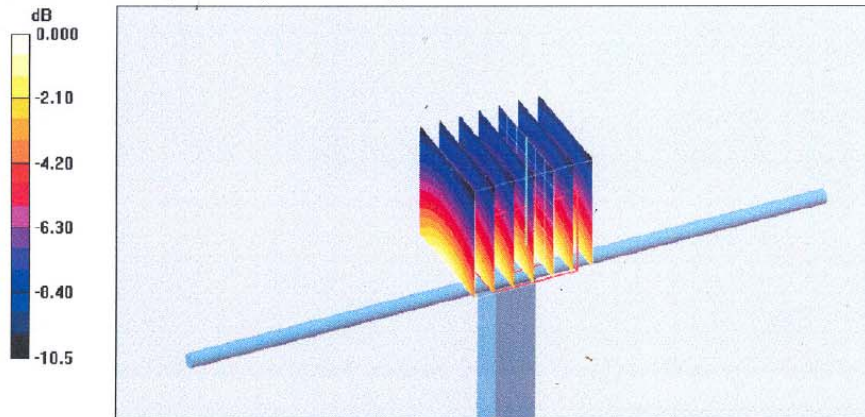

0 dB = 2.58mW/g



### Impedance Measurement Plot for Head TSL

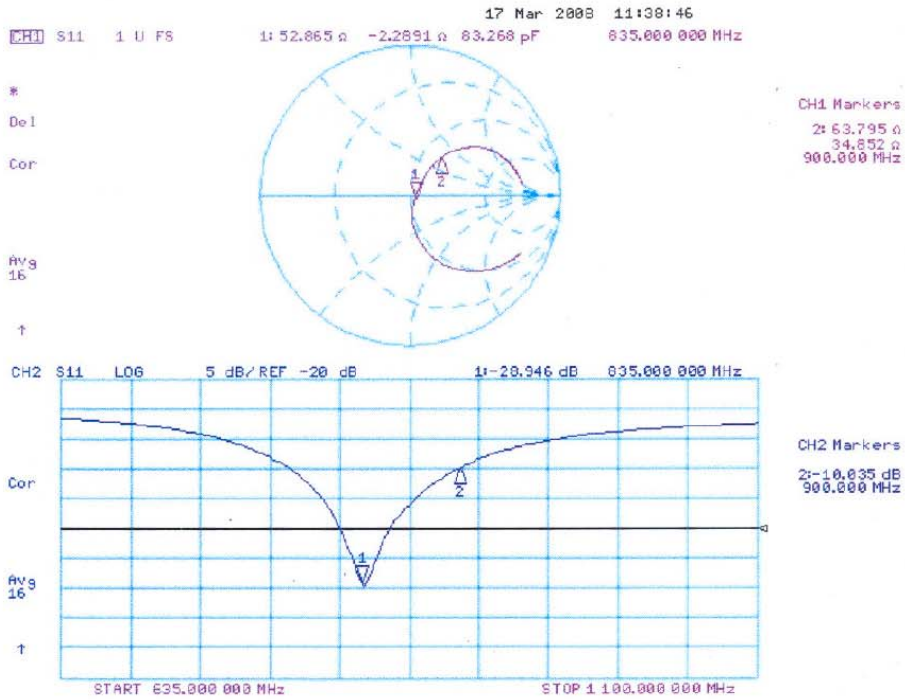

**DASY4 Validation Report for Body TSL**

Date/Time: 10.03.2008 12:48:36

Test Laboratory: SPEAG, Zurich, Switzerland

**DUT: Dipole 835 MHz; Type: D835V2; Serial: D835V2 - SN:499**

Communication System: CW; Frequency: 835 MHz; Duty Cycle: 1:1

Medium: MSL900;

Medium parameters used:  $f = 835$  MHz;  $\sigma = 1$  mho/m;  $\epsilon_r = 54$ ;  $\rho = 1000$  kg/m<sup>3</sup>

Phantom section: Flat Section

Measurement Standard: DASY4 (High Precision Assessment)

**DASY4 Configuration:**

- Probe: ES3DV2 - SN3025; ConvF(5.85, 5.85, 5.85); Calibrated: 01.03.2008
- Sensor-Surface: 4mm (Mechanical Surface Detection)
- Electronics: DAE4 Sn909; Calibrated: 03.09.2007
- Phantom: Flat Phantom 4.9L; Type: QD000P49AA; ;
- Measurement SW: DASY4, V4.7 Build 55; Postprocessing SW: SEMCAD, V1.8 Build 172

**Pin = 250mW, d = 15mm/Zoom Scan (7x7x7)/Cube 0:**

Measurement grid: dx=5mm, dy=5mm, dz=5mm

Reference Value = 51.8 V/m; Power Drift = 0.036 dB

Peak SAR (extrapolated) = 3.59 W/kg

**SAR(1 g) = 2.46 mW/g; SAR(10 g) = 1.63 mW/g**

Maximum value of SAR (measured) = 2.64 mW/g

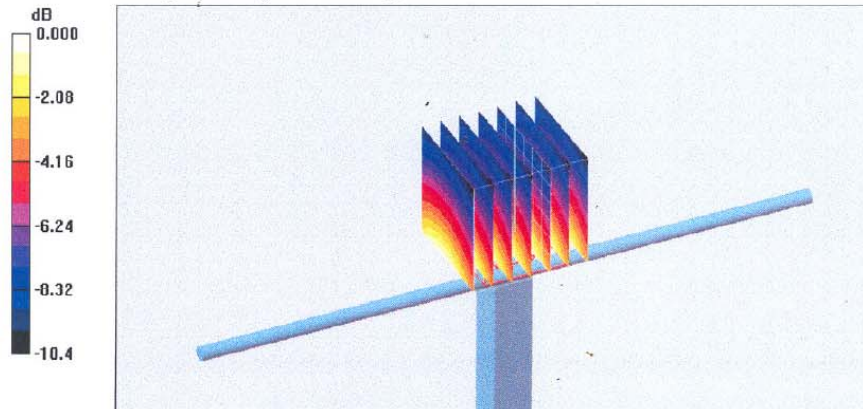

0 dB = 2.64mW/g





### Impedance Measurement Plot for Body TSL

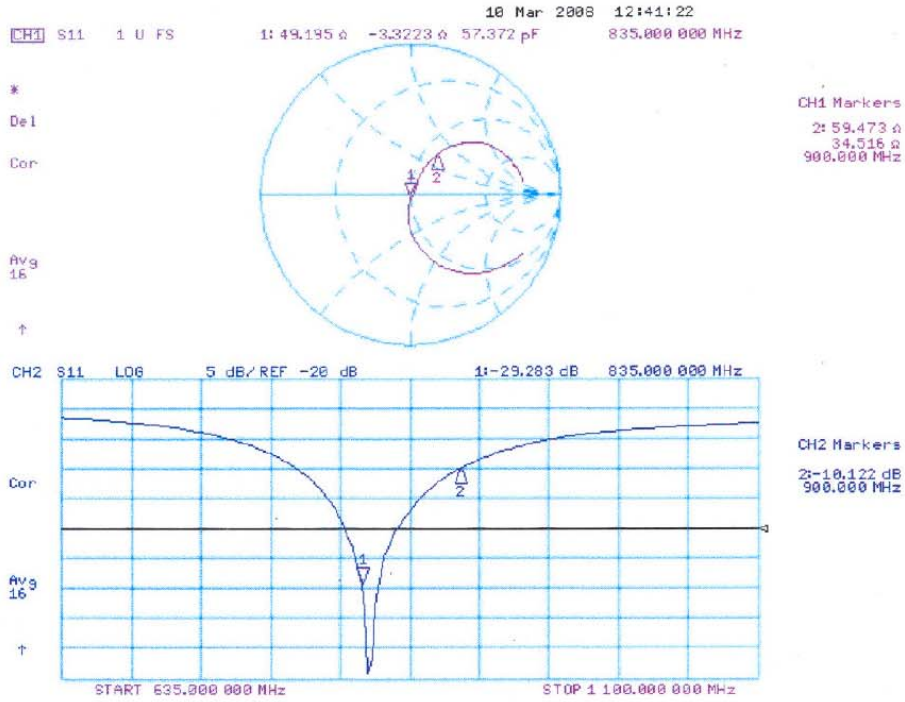



Calibration Laboratory of Schmid & Partner Engineering AG  
Zaughausstrasse 43, 8004 Zurich, Switzerland



S Schweizerischer Kalibrierdienst  
S Service suisse d'étalonnage  
S Servizio svizzero di taratura  
S Swiss Calibration Service

Accredited by the Swiss Federal Office of Metrology and Accreditation  
The Swiss Accreditation Service is one of the signatories to the EA  
Multilateral Agreement for the recognition of calibration certificates

Accreditation No.: SCS 108

Client Sporton (Auden)

Certificate No: D1900V2-5d041\_Mar08

CALIBRATION CERTIFICATE

Object: D1900V2 - SN: 5d041  
Calibration procedure(s): QA CAL-05.v7  
Calibration procedure for dipole validation kits  
Calibration date: March 18, 2008  
Condition of the calibrated item: In Tolerance

This calibration certificate documents the traceability to national standards, which realize the physical units of measurements (SI).  
The measurements and the uncertainties with confidence probability are given on the following pages and are part of the certificate.  
All calibrations have been conducted in the closed laboratory facility; environment temperature (22 ± 3)°C and humidity < 70%.

Calibration Equipment used (M&TE critical for calibration)

Primary Standards	ID #	Cal Date (Calibrated by, Certificate No.)	Scheduled Calibration
Power meter EPM-442A	GB37480704	04-Oct-07 (METAS, No. 217-00736)	Oct-08
Power sensor HP 8461A	US37292783	04-Oct-07 (METAS, No. 217-00736)	Oct-08
Reference 20 dB Attenuator	SN: 5086 (20g)	07-Aug-07 (METAS, No. 217-00718)	Aug-08
Reference 10 dB Attenuator	SN: 5047.2 (10r)	07-Aug-07 (METAS, No. 217-00718)	Aug-08
Reference Probe ES30V2	SN: 3025	01-Mar-08 (SPEAG, No. ES3-3025_Mar08)	Mar-09
DAE4	SN 909	3-Sep-08 (SPEAG, No. DAE4-909_Sep07)	Sep-07
Secondary Standards	ID #	Check Date (in house)	Scheduled Check
Power sensor HP 8481A	MY41092317	18-Oct-02 (SPEAG, in house check Oct-07)	in house check: Oct-08
RF generator R&S SMT-06	100005	4-Aug-99 (SPEAG, in house check Oct-07)	in house check: Oct-08
Network Analyzer HP 8753E	US37390585 S4205	18-Oct-01 (SPEAG, in house check Oct-07)	in house check: Oct-08
Power meter EPM-442A	GB37480704	04-Oct-07 (METAS, No. 217-00736)	Oct-08

Calibrated by: Marcel Fehr, Laboratory Technician  
Approved by: Katja Pokovic, Technical Manager

Issued: March 18, 2008

This calibration certificate shall not be reproduced except in full without written approval of the laboratory.



Calibration Laboratory of  
Schmid & Partner  
Engineering AG  
Zeughausstrasse 43, 8004 Zurich, Switzerland



S Schweizerischer Kalibrierdienst  
C Service suisse d'étalonnage  
S Servizio svizzero di taratura  
S Swiss Calibration Service

Accredited by the Swiss Federal Office of Metrology and Accreditation  
The Swiss Accreditation Service is one of the signatories to the EA  
Multilateral Agreement for the recognition of calibration certificates

Accreditation No.: **SCS 108**

**Glossary:**

TSL tissue simulating liquid  
ConvF sensitivity in TSL / NORM x,y,z  
N/A not applicable or not measured

**Calibration is Performed According to the Following Standards:**

- IEEE Std 1528-2003, "IEEE Recommended Practice for Determining the Peak Spatial-Averaged Specific Absorption Rate (SAR) in the Human Head from Wireless Communications Devices: Measurement Techniques", December 2003
- CENELEC EN 50361, "Basic standard for the measurement of Specific Absorption Rate related to human exposure to electromagnetic fields from mobile phones (300 MHz - 3 GHz), July 2001
- Federal Communications Commission Office of Engineering & Technology (FCC OET), "Evaluating Compliance with FCC Guidelines for Human Exposure to Radiofrequency Electromagnetic Fields; Additional Information for Evaluating Compliance of Mobile and Portable Devices with FCC Limits for Human Exposure to Radiofrequency Emissions", Supplement C (Edition 01-01) to Bulletin 65

**Additional Documentation:**

- DASY4 System Handbook

**Methods Applied and Interpretation of Parameters:**

- Measurement Conditions:** Further details are available from the Validation Report at the end of the certificate. All figures stated in the certificate are valid at the frequency indicated.
- Antenna Parameters with TSL:** The dipole is mounted with the spacer to position its feed point exactly below the center marking of the flat phantom section, with the arms oriented parallel to the body axis.
- Feed Point Impedance and Return Loss:** These parameters are measured with the dipole positioned under the liquid filled phantom. The impedance stated is transformed from the measurement at the SMA connector to the feed point. The Return Loss ensures low reflected power. No uncertainty required.
- Electrical Delay:** One-way delay between the SMA connector and the antenna feed point. No uncertainty required.
- SAR measured:** SAR measured at the stated antenna input power.
- SAR normalized:** SAR as measured, normalized to an input power of 1 W at the antenna connector.
- SAR for nominal TSL parameters:** The measured TSL parameters are used to calculate the nominal SAR result.



**Measurement Conditions**

DASY system configuration, as far as not given on page 1.

DASY Version	DASY4	V4.7
Extrapolation	Advanced Extrapolation	
Phantom	Modular Flat Phantom V5.0	
Distance Dipole Center - TSL	10 mm	with Spacer
Zoom Scan Resolution	dx, dy, dz = 5 mm	
Frequency	1900 MHz ± 1 MHz	

**Head TSL parameters**

The following parameters and calculations were applied.

	Temperature	Permittivity	Conductivity
Nominal Head TSL parameters	22.0 °C	40.0	1.40 mho/m
Measured Head TSL parameters	(22.0 ± 0.2) °C	40.2 ± 6 %	1.47 mho/m ± 6 %
Head TSL temperature during test	(21.1 ± 0.2) °C	---	---

**SAR result with Head TSL**

SAR averaged over 1 cm <sup>2</sup> (1 g) of Head TSL	condition	
SAR measured	250 mW input power	10.1 mW / g
SAR normalized	normalized to 1W	40.4 mW / g
SAR for nominal Head TSL parameters <sup>1</sup>	normalized to 1W	<b>39.5 mW / g ± 17.0 % (k=2)</b>

SAR averaged over 10 cm <sup>2</sup> (10 g) of Head TSL	Condition	
SAR measured	250 mW input power	5.20 mW / g
SAR normalized	normalized to 1W	20.8 mW / g
SAR for nominal Head TSL parameters <sup>1</sup>	normalized to 1W	<b>20.6 mW / g ± 16.5 % (k=2)</b>

<sup>1</sup> Correction to nominal TSL parameters according to d), chapter "SAR Sensitivities"





### Body TSL parameters

The following parameters and calculations were applied.

	Temperature	Permittivity	Conductivity
Nominal Body TSL parameters	22.0 °C	53.3	1.52 mho/m
Measured Body TSL parameters	(22.0 ± 0.2) °C	51.6 ± 8 %	1.57 mho/m ± 6 %
Body TSL temperature during test	(21.4 ± 0.2) °C	---	---

### SAR result with Body TSL

SAR averaged over 1 cm <sup>3</sup> (1 g) of Body TSL	Condition	
SAR measured	250 mW input power	10.4 mW / g
SAR normalized	normalized to 1W	41.6 mW / g
SAR for nominal Body TSL parameters <sup>2</sup>	normalized to 1W	40.1 mW / g ± 17.0 % (k=2)

SAR averaged over 10 cm <sup>3</sup> (10 g) of Body TSL	condition	
SAR measured	250 mW input power	5.44 mW / g
SAR normalized	normalized to 1W	21.8 mW / g
SAR for nominal Body TSL parameters <sup>2</sup>	normalized to 1W	21.3 mW / g ± 16.5 % (k=2)

<sup>2</sup> Correction to nominal TSL parameters according to d), chapter "SAR Sensitivities"



**Appendix**

**Antenna Parameters with Head TSL**

Impedance, transformed to feed point	54.0 $\Omega$ + 5.1 j $\Omega$
Return Loss	- 24.2 dB

**Antenna Parameters with Body TSL**

Impedance, transformed to feed point	48.0 $\Omega$ + 6.1 j $\Omega$
Return Loss	- 23.6 dB

**General Antenna Parameters and Design**

Electrical Delay (one direction)	1.199 ns
----------------------------------	----------

After long term use with 100W radiated power, only a slight warming of the dipole near the feedpoint can be measured.

The dipole is made of standard semirigid coaxial cable. The center conductor of the feeding line is directly connected to the second arm of the dipole. The antenna is therefore short-circuited for DC-signals.

No excessive force must be applied to the dipole arms, because they might bend or the soldered connections near the feedpoint may be damaged.

**Additional EUT Data**

Manufactured by	SPEAG
Manufactured on	July 04, 2003

DASY4 Validation Report for Head TSL

Date/Time: 18.03.2008 12:05:10

Test Laboratory: SPEAG, Zurich, Switzerland

DUT: Dipole 1900 MHz; Type: D1900V2; Serial: D1900V2 - SN:5d041

Communication System: CW; Frequency: 1900 MHz; Duty Cycle: 1:1

Medium: HSL U10 BB;

Medium parameters used:  $f = 1900$  MHz;  $\sigma = 1.47$  mho/m;  $\epsilon_r = 40.2$ ;  $\rho = 1000$  kg/m<sup>3</sup>

Phantom section: Flat Section

Measurement Standard: DASY4 (High Precision Assessment)

DASY4 Configuration:

- Probe: ES3DV2 - SN3025; ConvF(4.9, 4.9, 4.9); Calibrated: 01.03.2008
- Sensor-Surface: 3.4mm (Mechanical Surface Detection)
- Electronics: DAE4 Sn909; Calibrated: 03.09.2007
- Phantom: Flat Phantom 5.0 (front); Type: QD000P50AA ;
- Measurement SW: DASY4, V4.7 Build 55; Postprocessing SW: SEMCAD, V1.8 Build 172

**Pin = 250 mW; d = 10 mm/Zoom Scan (7x7x7)/Cube 0:**

Measurement grid: dx=5mm, dy=5mm, dz=5mm

Reference Value = 91.7 V/m; Power Drift = 0.013 dB

Peak SAR (extrapolated) = 19.1 W/kg

**SAR(1 g) = 10.1 mW/g; SAR(10 g) = 5.2 mW/g**

Maximum value of SAR (measured) = 11.8 mW/g

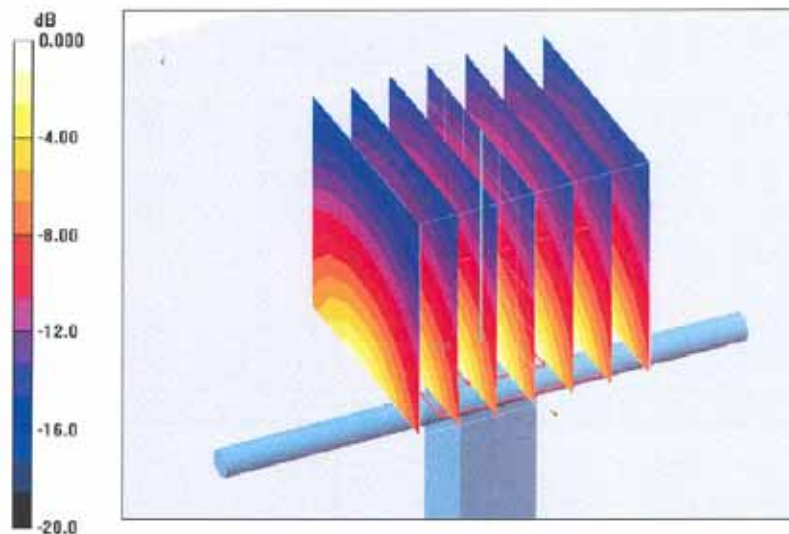

0 dB = 11.8mW/g



Impedance Measurement Plot for Head TSL

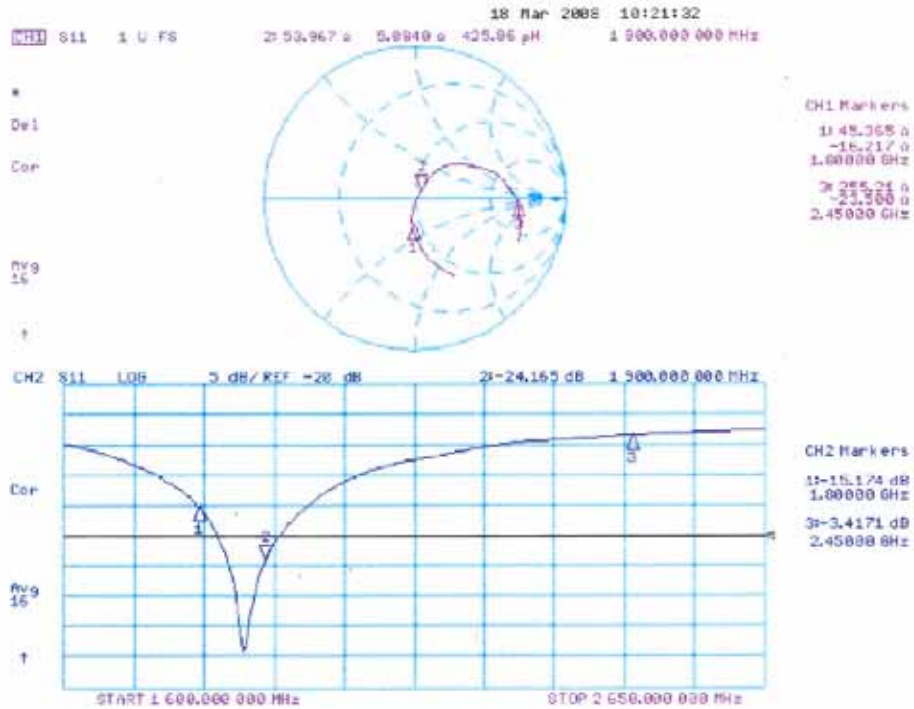



DASY4 Validation Report for Body TSL

Date/Time: 14.03.2008 13:22:24

Test Laboratory: SPEAG, Zurich, Switzerland

DUT: Dipole 1900 MHz; Type: D1900V2; Serial: D1900V2 - SN:5d041

Communication System: CW; Frequency: 1900 MHz; Duty Cycle: 1:1

Medium: MSL U10 BB;

Medium parameters used:  $f = 1900$  MHz;  $\sigma = 1.57$  mho/m;  $\epsilon_r = 51.7$ ;  $\rho = 1000$  kg/m<sup>3</sup>

Phantom section: Flat Section

Measurement Standard: DASY4 (High Precision Assessment)

DASY4 Configuration:

- Probe: ES3DV2 - SN3025; ConvF(4.5, 4.5, 4.5); Calibrated: 01.03.2008
- Sensor-Surface: 3.4mm (Mechanical Surface Detection)
- Electronics: DAE4 Sn909; Calibrated: 03.09.2007
- Phantom: Flat Phantom 5.0 (front); Type: QD000P50AA; ;
- Measurement SW: DASY4, V4.7 Build 55; Postprocessing SW: SEMCAD, V1.8 Build 172

**Pin = 250 mW; d = 10 mm/Zoom Scan (7x7x7)/Cube 0:**

Measurement grid: dx=5mm, dy=5mm, dz=5mm

Reference Value = 89.7 V/m; Power Drift = 0.004 dB

Peak SAR (extrapolated) = 18.6 W/kg

**SAR(1 g) = 10.4 mW/g; SAR(10 g) = 5.44 mW/g**

Maximum value of SAR (measured) = 12.0 mW/g

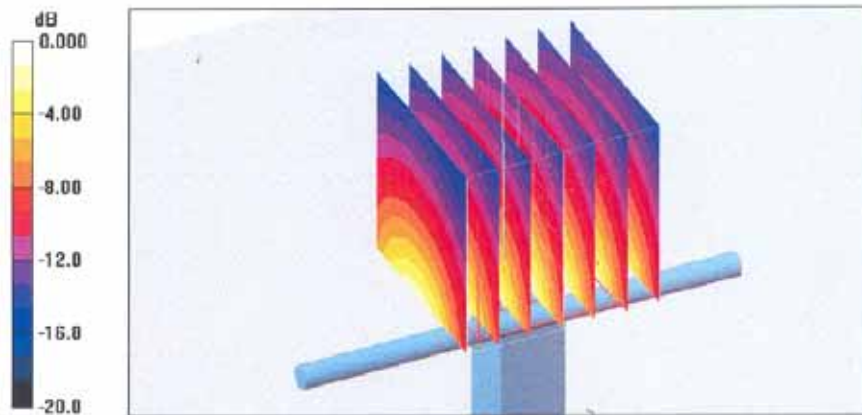

0 dB = 12.0mW/g



Impedance Measurement Plot for Body TSL

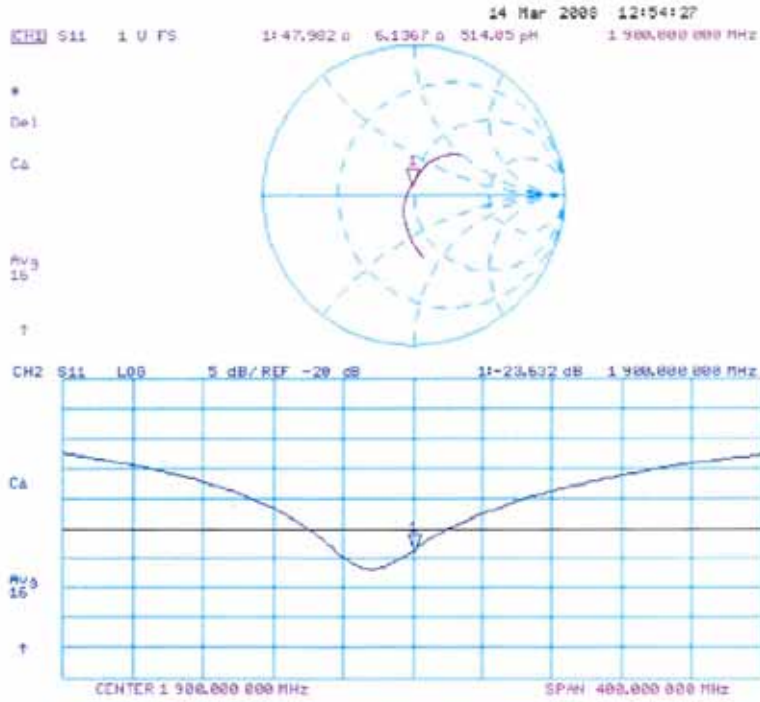



# Calibration Certificate of DASY

**Calibration Laboratory of  
Schmid & Partner  
Engineering AG**  
Zeughausstrasse 43, 8004 Zurich, Switzerland



**S** Schweizerischer Kalibrierdienst  
**C** Service suisse d'étalonnage  
**S** Servizio svizzero di taratura  
**S** Swiss Calibration Service

Accredited by the Swiss Accreditation Service (SAS)  
The Swiss Accreditation Service is one of the signatories to the EA  
Multilateral Agreement for the recognition of calibration certificates

Accreditation No.: **SCS 108**

Client **Sporton (Auden)**

Certificate No: **DAE3-577\_Nov08**

## CALIBRATION CERTIFICATE

Object: **DAE3 - SD 000 D03 AA - SN: 577**

Calibration procedure(s): **QA CAL-06.v12  
Calibration procedure for the data acquisition electronics (DAE)**

Calibration date: **November 12, 2008**

Condition of the calibrated item: **In Tolerance**

This calibration certificate documents the traceability to national standards, which realize the physical units of measurements (SI).  
The measurements and the uncertainties with confidence probability are given on the following pages and are part of the certificate.

All calibrations have been conducted in the closed laboratory facility: environment temperature (22 ± 3)°C and humidity < 70%.

Calibration Equipment used (M&TE critical for calibration)

Primary Standards	ID #	Cal Date (Certificate No.)	Scheduled Calibration
Fluke Process Calibrator Type 702	SN: 6295803	30-Sep-08 (No: 7673)	Sep-09
Keithley Multimeter Type 2001	SN: 0810278	30-Sep-08 (No: 7670)	Sep-09
Secondary Standards	ID #	Check Date (in house)	Scheduled Check
Calibrator Box V1.1	SE UMS 006 AB 1004	06-Jun-08 (in house check)	In house check: Jun-09

Calibrated by:	Name <b>Andrea Guntli</b>	Function <b>Technician</b>	Signature 
Approved by:	Name <b>Fin Bomholt</b>	Function <b>R&amp;D Director</b>	Signature 

Issued: November 12, 2008

This calibration certificate shall not be reproduced except in full without written approval of the laboratory.



**Calibration Laboratory of  
Schmid & Partner  
Engineering AG**  
Zeughausstrasse 43, 8004 Zurich, Switzerland



**S** Schweizerischer Kalibrierdienst  
**C** Service suisse d'étalonnage  
**S** Servizio svizzero di taratura  
**S** Swiss Calibration Service

Accredited by the Swiss Accreditation Service (SAS)  
The Swiss Accreditation Service is one of the signatories to the EA  
Multilateral Agreement for the recognition of calibration certificates

Accreditation No.: **SCS 108**

### Glossary

**DAE** data acquisition electronics  
**Connector angle** information used in DASY system to align probe sensor X to the robot coordinate system.

### Methods Applied and Interpretation of Parameters

- **DC Voltage Measurement:** Calibration Factor assessed for use in DASY system by comparison with a calibrated instrument traceable to national standards. The figure given corresponds to the full scale range of the voltmeter in the respective range.
- **Connector angle:** The angle of the connector is assessed measuring the angle mechanically by a tool inserted. Uncertainty is not required.
- The following parameters as documented in the Appendix contain technical information as a result from the performance test and require no uncertainty.
  - **DC Voltage Measurement Linearity:** Verification of the Linearity at +10% and -10% of the nominal calibration voltage. Influence of offset voltage is included in this measurement.
  - **Common mode sensitivity:** Influence of a positive or negative common mode voltage on the differential measurement.
  - **Channel separation:** Influence of a voltage on the neighbor channels not subject to an input voltage.
  - **AD Converter Values with inputs shorted:** Values on the internal AD converter corresponding to zero input voltage
  - **Input Offset Measurement:** Output voltage and statistical results over a large number of zero voltage measurements.
  - **Input Offset Current:** Typical value for information; Maximum channel input offset current, not considering the input resistance.
  - **Input resistance:** DAE input resistance at the connector, during internal auto-zeroing and during measurement.
  - **Low Battery Alarm Voltage:** Typical value for information. Below this voltage, a battery alarm signal is generated.
  - **Power consumption:** Typical value for information. Supply currents in various operating modes.





**DC Voltage Measurement**

A/D - Converter Resolution nominal

High Range: 1LSB = 6.1 $\mu$ V , full range = -100...+300 mV  
Low Range: 1LSB = 61nV , full range = -1.....+3mV

DASy measurement parameters: Auto Zero Time: 3 sec; Measuring time: 3 sec

Calibration Factors	X	Y	Z
High Range	404.437 $\pm$ 0.1% (k=2)	403.882 $\pm$ 0.1% (k=2)	404.321 $\pm$ 0.1% (k=2)
Low Range	3.93985 $\pm$ 0.7% (k=2)	3.94699 $\pm$ 0.7% (k=2)	3.94542 $\pm$ 0.7% (k=2)

**Connector Angle**

Connector Angle to be used in DASy system	268 $^{\circ}$ $\pm$ 1 $^{\circ}$
---	-----------------------------------



**Appendix**

**1. DC Voltage Linearity**

High Range	Input (μV)	Reading (μV)	Error (%)
Channel X + Input	200000	200000.5	0.00
Channel X + Input	20000	20006.28	0.03
Channel X - Input	20000	-19997.96	-0.01
Channel Y + Input	200000	199999.8	0.00
Channel Y + Input	20000	20003.35	0.02
Channel Y - Input	20000	-20003.31	0.02
Channel Z + Input	200000	200000.3	0.00
Channel Z + Input	20000	20006.28	0.03
Channel Z - Input	20000	-19999.42	0.00

Low Range	Input (μV)	Reading (μV)	Error (%)
Channel X + Input	2000	2000	0.00
Channel X + Input	200	200.64	0.32
Channel X - Input	200	-199.61	-0.19
Channel Y + Input	2000	2000	0.00
Channel Y + Input	200	199.39	-0.31
Channel Y - Input	200	-201.03	0.52
Channel Z + Input	2000	2000	0.00
Channel Z + Input	200	199.42	-0.29
Channel Z - Input	200	-200.73	0.36

**2. Common mode sensitivity**

DASy measurement parameters: Auto Zero Time: 3 sec; Measuring time: 3 sec

	Common mode Input Voltage (mV)	High Range Average Reading (μV)	Low Range Average Reading (μV)
Channel X	200	13.38	13.83
	- 200	-13.53	-13.82
Channel Y	200	-5.55	-6.09
	- 200	5.06	5.66
Channel Z	200	-1.00	-0.72
	- 200	-0.80	-0.52

**3. Channel separation**

DASy measurement parameters: Auto Zero Time: 3 sec; Measuring time: 3 sec

	Input Voltage (mV)	Channel X (μV)	Channel Y (μV)	Channel Z (μV)
Channel X	200	-	1.66	0.50
Channel Y	200	1.90	-	3.95
Channel Z	200	-0.95	0.48	-



**4. AD-Converter Values with inputs shorted**

DASY measurement parameters: Auto Zero Time: 3 sec; Measuring time: 3 sec

	High Range (LSB)	Low Range (LSB)
Channel X	15967	16080
Channel Y	15851	16385
Channel Z	16197	16100

**5. Input Offset Measurement**

DASY measurement parameters: Auto Zero Time: 3 sec; Measuring time: 3 sec

Input 10MΩ

	Average (μV)	min. Offset (μV)	max. Offset (μV)	Std. Deviation (μV)
Channel X	1.13	-1.22	2.29	0.58
Channel Y	-1.51	-2.99	0.83	0.52
Channel Z	0.02	-0.89	0.92	0.38

**6. Input Offset Current**

Nominal Input circuitry offset current on all channels: <25fA

**7. Input Resistance**

	Zeroing (MOhm)	Measuring (MOhm)
Channel X	0.2000	198.6
Channel Y	0.2001	199.4
Channel Z	0.2000	198.8

**8. Low Battery Alarm Voltage** (verified during pre test)

Typical values	Alarm Level (VDC)
Supply (+ Vcc)	+7.9
Supply (- Vcc)	-7.6

**9. Power Consumption** (verified during pre test)

Typical values	Switched off (mA)	Stand by (mA)	Transmitting (mA)
Supply (+ Vcc)	+0.0	+6	+14
Supply (- Vcc)	-0.01	-8	-9



Calibration Laboratory of Schmid & Partner Engineering AG Zeughausstrasse 43, 8004 Zurich, Switzerland



S Schweizerischer Kalibrierdienst
S Service suisse d'etalonnage
S Servizio svizzero di taratura
S Swiss Calibration Service

Accredited by the Swiss Accreditation Service (SAS)
The Swiss Accreditation Service is one of the signatories to the EA Multilateral Agreement for the recognition of calibration certificates

Accreditation No.: SCS 108

Client Sporton (Auden)

Certificate No: EX3-3514\_Jan09

CALIBRATION CERTIFICATE

Object: EX3DV3 - SN:3514
Calibration procedure(s): QA CAL-01.v6, QA CAL-14.v3 and QA CAL-23.v3
Calibration date: January 21, 2009
Condition of the calibrated item: In Tolerance

This calibration certificate documents the traceability to national standards, which realize the physical units of measurements (SI). The measurements and the uncertainties with confidence probability are given on the following pages and are part of the certificate.

All calibrations have been conducted in the closed laboratory facility: environment temperature (22 ± 3)°C and humidity < 70%.

Calibration Equipment used (M&TE critical for calibration)

Table with 4 columns: Primary Standards, ID #, Cal Date (Certificate No.), Scheduled Calibration. Lists various power meters, sensors, and attenuators with their respective IDs and calibration dates.

Table with 4 columns: Secondary Standards, ID #, Check Date (in house), Scheduled Check. Lists RF generator and Network Analyzer with their IDs and check dates.

Calibrated by: Katja Pokovic, Technical Manager
Approved by: Niels Kuster, Quality Manager

Issued: January 21, 2009

This calibration certificate shall not be reproduced except in full without written approval of the laboratory.





Calibration Laboratory of  
Schmid & Partner  
Engineering AG  
Zeughausstrasse 43, 8004 Zurich, Switzerland



S Schweizerischer Kalibrierdienst  
C Service suisse d'étalonnage  
S Servizio svizzero di taratura  
S Swiss Calibration Service

Accredited by the Swiss Accreditation Service (SAS)  
The Swiss Accreditation Service is one of the signatories to the EA  
Multilateral Agreement for the recognition of calibration certificates

Accreditation No.: SCS 108

**Glossary:**

TSL	tissue simulating liquid
NORM <sub>x,y,z</sub>	sensitivity in free space
ConvF	sensitivity in TSL / NORM <sub>x,y,z</sub>
DCP	diode compression point
Polarization $\varphi$	$\varphi$ rotation around probe axis
Polarization $\vartheta$	$\vartheta$ rotation around an axis that is in the plane normal to probe axis (at measurement center), i.e., $\vartheta = 0$ is normal to probe axis

**Calibration is Performed According to the Following Standards:**

- a) IEEE Std 1528-2003, "IEEE Recommended Practice for Determining the Peak Spatial-Averaged Specific Absorption Rate (SAR) in the Human Head from Wireless Communications Devices: Measurement Techniques", December 2003
- b) IEC 62209-1, "Procedure to measure the Specific Absorption Rate (SAR) for hand-held devices used in close proximity to the ear (frequency range of 300 MHz to 3 GHz)", February 2005

**Methods Applied and Interpretation of Parameters:**

- *NORM<sub>x,y,z</sub>*: Assessed for E-field polarization  $\vartheta = 0$  ( $f \leq 900$  MHz in TEM-cell;  $f > 1800$  MHz: R22 waveguide). *NORM<sub>x,y,z</sub>* are only intermediate values, i.e., the uncertainties of *NORM<sub>x,y,z</sub>* does not effect the  $E^2$ -field uncertainty inside TSL (see below *ConvF*).
- *NORM(f)<sub>x,y,z</sub>* = *NORM<sub>x,y,z</sub>* \* *frequency\_response* (see Frequency Response Chart). This linearization is implemented in DASY4 software versions later than 4.2. The uncertainty of the frequency response is included in the stated uncertainty of *ConvF*.
- *DCP<sub>x,y,z</sub>*: DCP are numerical linearization parameters assessed based on the data of power sweep (no uncertainty required). DCP does not depend on frequency nor media.
- *ConvF and Boundary Effect Parameters*: Assessed in flat phantom using E-field (or Temperature Transfer Standard for  $f \leq 800$  MHz) and inside waveguide using analytical field distributions based on power measurements for  $f > 800$  MHz. The same setups are used for assessment of the parameters applied for boundary compensation (alpha, depth) of which typical uncertainty values are given. These parameters are used in DASY4 software to improve probe accuracy close to the boundary. The sensitivity in TSL corresponds to *NORM<sub>x,y,z</sub>* \* *ConvF* whereby the uncertainty corresponds to that given for *ConvF*. A frequency dependent *ConvF* is used in DASY version 4.4 and higher which allows extending the validity from  $\pm 50$  MHz to  $\pm 100$  MHz.
- *Spherical isotropy (3D deviation from isotropy)*: in a field of low gradients realized using a flat phantom exposed by a patch antenna.
- *Sensor Offset*: The sensor offset corresponds to the offset of virtual measurement center from the probe tip (on probe axis). No tolerance required.



EX3DV3 SN:3514

January 21, 2009

# Probe EX3DV3

## SN:3514

Manufactured:	December 15, 2002
Last calibrated:	January 31, 2008
Recalibrated:	January 21, 2009

Calibrated for DASY Systems

(Note: non-compatible with DASY2 system!)



EX3DV3 SN:3514

January 21, 2009

DASY - Parameters of Probe: EX3DV3 SN:3514

Sensitivity in Free Space <sup>A</sup>			Diode Compression <sup>B</sup>	
NormX	0.66 ± 10.1%	μV/(V/m) <sup>2</sup>	DCP X	91 mV
NormY	0.70 ± 10.1%	μV/(V/m) <sup>2</sup>	DCP Y	94 mV
NormZ	0.60 ± 10.1%	μV/(V/m) <sup>2</sup>	DCP Z	95 mV

Sensitivity in Tissue Simulating Liquid (Conversion Factors)

Please see Page 8.

Boundary Effect

TSL	900 MHz	Typical SAR gradient: 5 % per mm	
	Sensor Center to Phantom Surface Distance	2.0 mm	3.0 mm
	SAR <sub>be</sub> [%] Without Correction Algorithm	7.7	4.4
	SAR <sub>be</sub> [%] With Correction Algorithm	0.8	0.3

TSL	1810 MHz	Typical SAR gradient: 10 % per mm	
	Sensor Center to Phantom Surface Distance	2.0 mm	3.0 mm
	SAR <sub>be</sub> [%] Without Correction Algorithm	6.2	3.4
	SAR <sub>be</sub> [%] With Correction Algorithm	0.7	0.3

Sensor Offset

Probe Tip to Sensor Center 1.0 mm

The reported uncertainty of measurement is stated as the standard uncertainty of measurement multiplied by the coverage factor k=2, which for a normal distribution corresponds to a coverage probability of approximately 95%.

<sup>A</sup> The uncertainties of NormX,Y,Z do not affect the E<sup>2</sup>-field uncertainty inside TSL (see Page 8).

<sup>B</sup> Numerical linearization parameter; uncertainty not required.



EX3DV3 SN:3514

January 21, 2009

### Frequency Response of E-Field

(TEM-Cell: ifi110 EXX, Waveguide: R22)

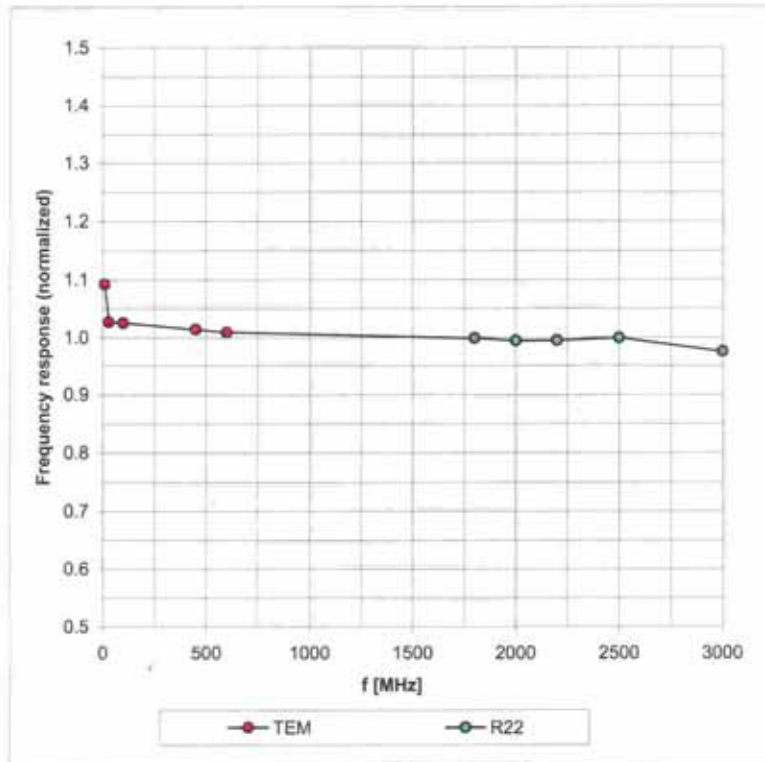

Uncertainty of Frequency Response of E-field:  $\pm 6.3\%$  (k=2)





EX3DV3 SN:3514

January 21, 2009

### Receiving Pattern ( $\phi$ ), $\vartheta = 0^\circ$

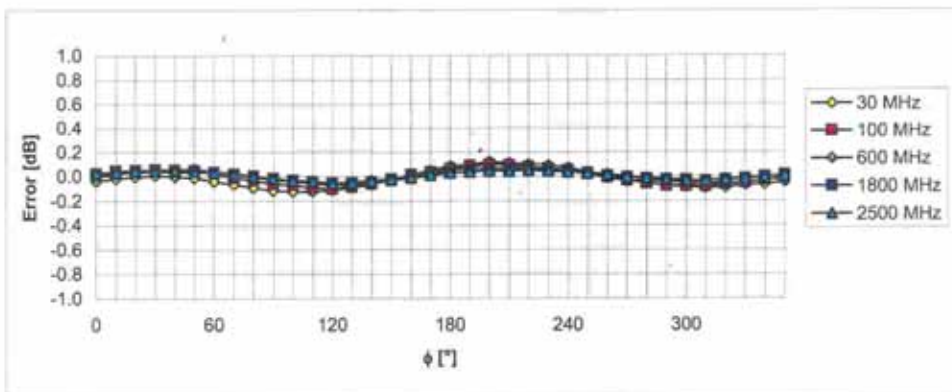
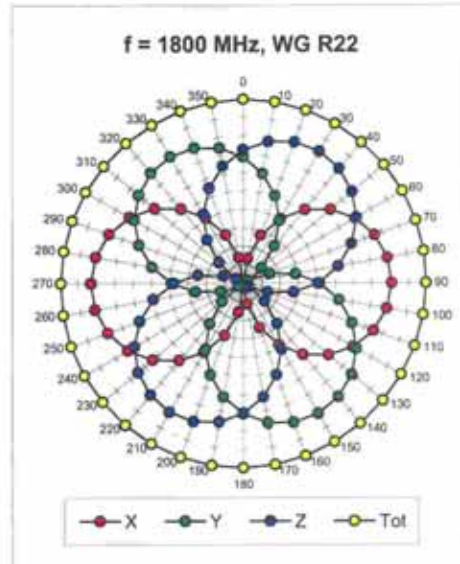
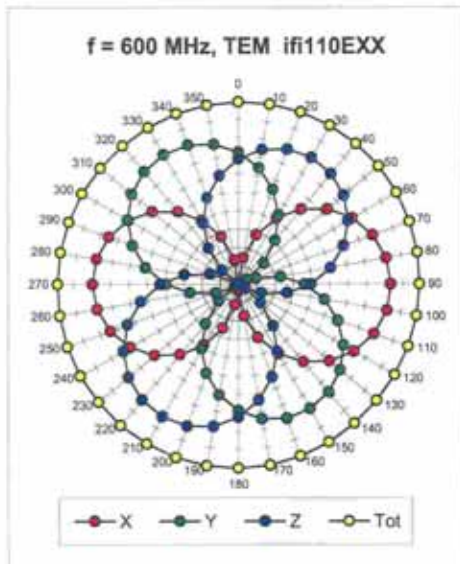

Uncertainty of Axial Isotropy Assessment:  $\pm 0.5\%$  (k=2)



EX3DV3 SN:3514

January 21, 2009

### Dynamic Range $f(\text{SAR}_{\text{head}})$ (Waveguide R22, $f = 1800$ MHz)

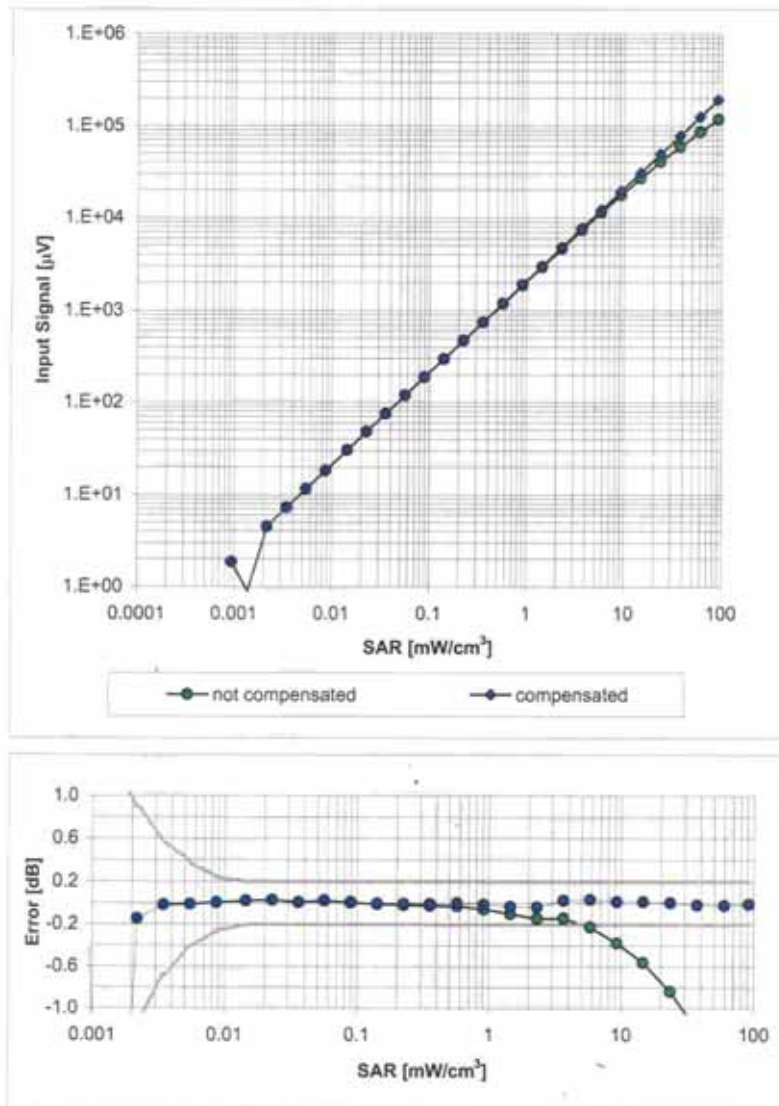

Uncertainty of Linearity Assessment:  $\pm 0.6\%$  ( $k=2$ )



EX3DV3 SN:3514

January 21, 2009

### Conversion Factor Assessment

f [MHz]	Validity [MHz] <sup>c</sup>	TSL	Permittivity	Conductivity	Alpha	Depth	ConvF Uncertainty
900	± 50 / ± 100	Head	41.5 ± 5%	0.97 ± 5%	0.45	0.76	9.31 ± 11.0% (k=2)
1810	± 50 / ± 100	Head	40.0 ± 5%	1.40 ± 5%	0.60	0.63	8.16 ± 11.0% (k=2)
2300	± 50 / ± 100	Head	39.4 ± 5%	1.71 ± 5%	0.53	0.63	7.78 ± 11.0% (k=2)
2600	± 50 / ± 100	Head	39.0 ± 5%	1.96 ± 5%	0.16	2.19	7.34 ± 11.0% (k=2)
3500	± 50 / ± 100	Head	37.9 ± 5%	2.91 ± 5%	0.50	0.86	6.89 ± 13.1% (k=2)
5200	± 50 / ± 100	Head	36.0 ± 5%	4.66 ± 5%	0.40	1.70	4.78 ± 13.1% (k=2)
5300	± 50 / ± 100	Head	35.9 ± 5%	4.76 ± 5%	0.40	1.70	4.40 ± 13.1% (k=2)
5500	± 50 / ± 100	Head	35.6 ± 5%	4.96 ± 5%	0.40	1.70	4.22 ± 13.1% (k=2)
5600	± 50 / ± 100	Head	35.5 ± 5%	5.07 ± 5%	0.40	1.70	4.13 ± 13.1% (k=2)
5800	± 50 / ± 100	Head	35.3 ± 5%	5.27 ± 5%	0.40	1.70	4.13 ± 13.1% (k=2)
900	± 50 / ± 100	Body	55.0 ± 5%	1.05 ± 5%	0.42	0.76	9.41 ± 11.0% (k=2)
1810	± 50 / ± 100	Body	53.3 ± 5%	1.52 ± 5%	0.85	0.56	8.18 ± 11.0% (k=2)
2300	± 50 / ± 100	Body	52.8 ± 5%	1.85 ± 5%	0.18	4.17	7.60 ± 11.0% (k=2)
2600	± 50 / ± 100	Body	52.5 ± 5%	2.16 ± 5%	0.34	1.14	7.20 ± 11.0% (k=2)
3500	± 50 / ± 100	Body	51.3 ± 5%	3.31 ± 5%	0.53	0.81	6.40 ± 13.1% (k=2)
5200	± 50 / ± 100	Body	49.0 ± 5%	5.30 ± 5%	0.45	1.75	4.29 ± 13.1% (k=2)
5300	± 50 / ± 100	Body	48.9 ± 5%	5.42 ± 5%	0.45	1.75	3.94 ± 13.1% (k=2)
5500	± 50 / ± 100	Body	48.6 ± 5%	5.65 ± 5%	0.45	1.75	3.88 ± 13.1% (k=2)
5600	± 50 / ± 100	Body	48.5 ± 5%	5.77 ± 5%	0.45	1.75	3.89 ± 13.1% (k=2)
5800	± 50 / ± 100	Body	48.2 ± 5%	6.00 ± 5%	0.45	1.75	3.85 ± 13.1% (k=2)

<sup>c</sup> The validity of ± 100 MHz only applies for DASY v4.4 and higher (see Page 2). The uncertainty is the RSS of the ConvF uncertainty at calibration frequency and the uncertainty for the indicated frequency band.



EX3DV3 SN:3514

January 21, 2009

### Deviation from Isotropy in HSL Error ( $\phi, \vartheta$ ), $f = 900$ MHz

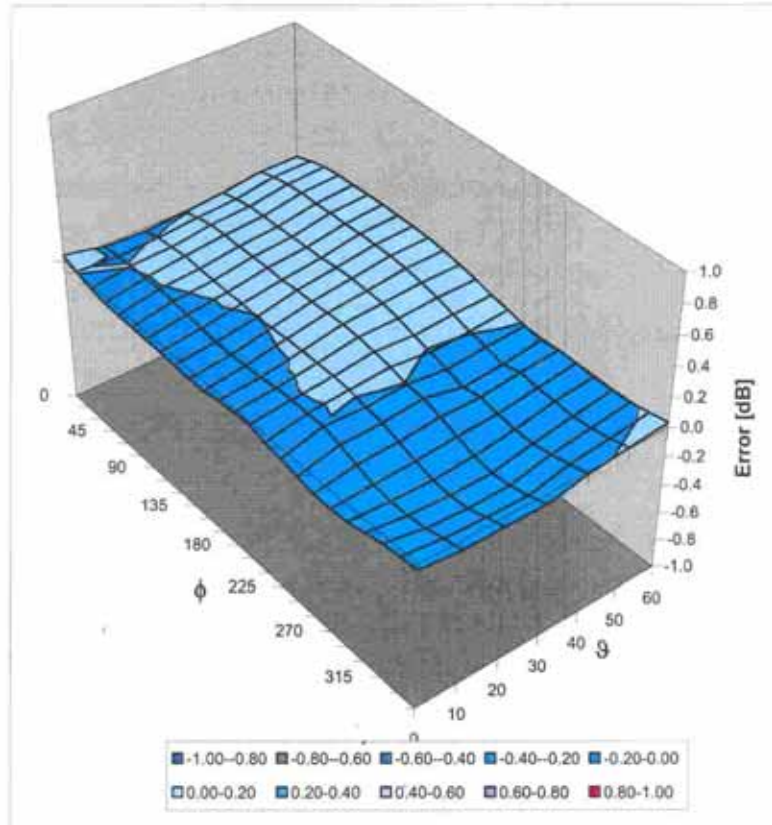

Uncertainty of Spherical Isotropy Assessment:  $\pm 2.6\%$  ( $k=2$ )