



# FCC TEST REPORT (PART 15)

**REPORT NO.:** RF950915L21

**MODEL NO.:** TITA100

**RECEIVED:** Sep. 18, 2006

**TESTED:** Sep. 21 ~ Sep. 25, 2006

**ISSUED:** Oct. 02, 2006

**APPLICANT:** High Tech Computer Corp.

**ADDRESS:** 23, Hsin-Hua Rd., Taoyuan, 330, Taiwan, R.O.C.

**ISSUED BY:** Advance Data Technology Corporation

**LAB ADDRESS:** No. 47, 14<sup>th</sup> Ling, Chia Pau Tsuen, Lin Kou Hsiang 244, Taipei Hsien, Taiwan, R.O.C.

**TEST LOCATION:** No. 19, Hwa Ya 2<sup>nd</sup> Rd., Wen Hwa Tsuen, Kwei Shan Hsiang, Taoyuan Hsien 333, Taiwan, R.O.C.

This test report consists of 109 pages in total. It may be duplicated completely for legal use with the approval of the applicant. It should not be reproduced except in full, without the written approval of our laboratory. The client should not use it to claim product endorsement by CNLA, A2LA or any government agencies. The test results in the report only apply to the tested sample.





## TABLE OF CONTENTS

1.	CERTIFICATION .....	4
2.	SUMMARY OF TEST RESULTS .....	5
2.1	MEASUREMENT UNCERTAINTY.....	5
3.	GENERAL INFORMATION .....	6
3.1	GENERAL DESCRIPTION OF EUT .....	6
3.2	DESCRIPTION OF TEST MODES .....	8
3.2.1	CONFIGURATION OF SYSTEM UNDER TEST .....	9
3.2.2	TEST MODE APPLICABILITY AND TESTED CHANNEL DETAIL:.....	10
3.3.3	GENERAL DESCRIPTION OF APPLIED STANDARDS .....	13
3.3.4	DESCRIPTION OF SUPPORT UNITS.....	13
4.	TEST TYPES AND RESULTS.....	14
4.1	CONDUCTED EMISSION MEASUREMENT .....	14
4.1.1	LIMITS OF CONDUCTED EMISSION MEASUREMENT .....	14
4.1.2	TEST INSTRUMENTS.....	14
4.1.3	TEST PROCEDURES .....	15
4.1.4	DEVIATION FROM TEST STANDARD .....	15
4.1.5	TEST SETUP .....	16
4.1.6	EUT OPERATING CONDITIONS .....	16
4.1.7	TEST RESULTS.....	17
4.2	RADIATED EMISSION MEASUREMENT .....	59
4.2.1	LIMITS OF RADIATED EMISSION MEASUREMENT .....	59
4.2.2	TEST INSTRUMENTS.....	60
4.2.3	TEST PROCEDURES .....	61
4.2.4	DEVIATION FROM TEST STANDARD .....	61
4.2.5	TEST SETUP .....	62
4.2.6	EUT OPERATING CONDITIONS .....	62
4.2.7	TEST RESULTS.....	63
4.3	6dB BANDWIDTH MEASUREMENT .....	79
4.3.1	LIMITS OF 6dB BANDWIDTH MEASUREMENT .....	79
4.3.2	TEST INSTRUMENTS.....	79
4.3.3	TEST PROCEDURE.....	79
4.3.4	DEVIATION FROM TEST STANDARD .....	79
4.3.5	TEST SETUP .....	80
4.3.6	EUT OPERATING CONDITIONS .....	80
4.3.7	TEST RESULTS.....	81
4.4	MAXIMUM PEAK OUTPUT POWER .....	87
4.4.1	LIMITS OF MAXIMUM PEAK OUTPUT POWER MEASUREMENT .....	87
4.4.2	TEST INSTRUMENTS.....	87
4.4.3	TEST PROCEDURES .....	88
4.4.4	DEVIATION FROM TEST STANDARD .....	88
4.4.5	TEST SETUP .....	88
4.4.6	EUT OPERATING CONDITIONS .....	88
4.4.7	TEST RESULTS.....	89
4.5	POWER SPECTRAL DENSITY MEASUREMENT .....	90
4.5.1	LIMITS OF POWER SPECTRAL DENSITY MEASUREMENT .....	90
4.5.2	TEST INSTRUMENTS.....	90
4.5.3	TEST PROCEDURE.....	91
4.5.4	DEVIATION FROM TEST STANDARD .....	91
4.5.5	TEST SETUP .....	91



4.5.6 EUT OPERATING CONDITION .....	91
4.5.7 TEST RESULTS.....	92
4.6 BAND EDGES MEASUREMENT .....	98
4.6.1 LIMITS OF BAND EDGES MEASUREMENT .....	98
4.6.2 TEST INSTRUMENTS.....	98
4.6.3 TEST PROCEDURE.....	98
4.6.4 DEVIATION FROM TEST STANDARD.....	98
4.6.5 EUT OPERATING CONDITION .....	98
4.6.6 TEST RESULTS.....	99
4.7 ANTENNA REQUIREMENT .....	107
4.7.1 STANDARD APPLICABLE .....	107
4.7.2 ANTENNA CONNECTED CONSTRUCTION.....	107
5. INFORMATION ON THE TESTING LABORATORIES.....	108
APPENDIX-A .....	A-1



## 1. CERTIFICATION

**PRODUCT:** Pocket PC Phone  
**MODEL NO.:** TITA100  
**TEST SAMPLE:** ENGINEERING SAMPLE  
**TESTED:** Sep. 21 ~ Sep. 25, 2006  
**APPLICANT:** High Tech Computer Corp.  
**STANDARDS:** FCC Part 15, Subpart C (Section 15.247),  
ANSI C63.4-2003

The above equipment have been tested by **Advance Data Technology Corporation**, and found compliance with the requirement of the above standards. The test record, data evaluation & Equipment Under Test (EUT) configurations represented herein are true and accurate accounts of the measurements of the sample's EMC characteristics under the conditions specified in this report.

**PREPARED BY** : Andrea Hsia , **DATE:** Oct. 02, 2006  
Andrea Hsia

**TECHNICAL ACCEPTANCE** : Long Chen , **DATE:** Oct. 02, 2006  
Responsible for RF Long Chen

**APPROVED BY** : Gary Chang , **DATE:** Oct. 02, 2006  
Gary Chang / Supervisor

## 2. SUMMARY OF TEST RESULTS

The EUT has been tested according to the following specifications:

APPLIED STANDARD: FCC Part 15, Subpart C			
STANDARD SECTION	TEST TYPE AND LIMIT	RESULT	REMARK
15.207	AC Power Conducted Emission	PASS	Meet the requirement of limit. Minimum passing margin is -4.89dB at 0.399MHz.
15.247(a)(2)	Spectrum Bandwidth of a Direct Sequence Spread Spectrum System Limit: min. 500kHz	PASS	Meet the requirement of limit
15.247(b)	Maximum Peak Output Power Limit: max. 30dBm	PASS	Meet the requirement of limit
15.247(d)	Radiated Emissions Limit: Table 15.209	PASS	Meet the requirement of limit. Minimum passing margin is -1.20dB at 2390.00MHz.
15.247(e)	Power Spectral Density Limit: max. 8dBm	PASS	Meet the requirement of limit
15.247(d)	Band Edge Measurement Limit: 20dB less than the peak value of fundamental frequency	PASS	Meet the requirement of limit

### 2.1 MEASUREMENT UNCERTAINTY

Where relevant, the following measurement uncertainty levels have been estimated for tests performed on the EUT as specified in CISPR 16-4:

MEASUREMENT	FREQUENCY	UNCERTAINTY
Conducted emissions	9kHz ~ 30MHz	2.44 dB
Radiated emissions	30MHz ~ 200MHz	3.59 dB
	200MHz ~1000MHz	3.61 dB
	1GHz ~ 18GHz	2.26 dB
	18GHz ~ 40GHz	1.94 dB

This uncertainty represents an expanded uncertainty expressed at approximately the 95% confidence level using a coverage factor of k=2.

### 3. GENERAL INFORMATION

#### 3.1 GENERAL DESCRIPTION OF EUT

<b>PRODUCT</b>	Pocket PC Phone
<b>MODEL NO.</b>	TITA100
<b>FCC ID</b>	NM8TITA100
<b>POWER SUPPLY</b>	3.70Vdc from rechargeable lithium battery 5.00Vdc from power adapter or cradle 5.00Vdc from host equipment
<b>MODULATION TYPE</b>	CCK, DQPSK, DBPSK for DSSS 64QAM, 16QAM, QPSK, BPSK for OFDM
<b>MODULATION TECHNOLOGY</b>	DSSS, OFDM
<b>TRANSFER RATE</b>	802.11b:11/5.5/2/1Mbps 802.11g: 54/48/36/24/18/12/9/6Mbps
<b>FREQUENCY RANGE</b>	2.412 ~ 2.462GHz
<b>NUMBER OF CHANNEL</b>	11
<b>OUTPUT POWER</b>	80.353mW
<b>ANTENNA TYPE</b>	PIFA antenna with 0dBi gain
<b>DATA CABLE</b>	1.5m USB non-shielded cable without core 1.6m non-shielded cable for Earphone
<b>I/O PORTS</b>	Refer to user's manual
<b>ASSOCIATED DEVICES</b>	Belt chip, Pouch, Cradle, Earphone

**NOTE:**

1. The applicant defined the normal working voltage of the battery is from 3.6Vdc to 4.2Vdc.
2. The EUT have two different appearances.
3. The EUT is a CDMA850/CDMA1900 Pocket PC Phone with wireless LAN and bluetooth functions. This report is only covered the functions of wireless LAN. The bluetooth is covered in the other test report, which standards used also FCC Part 15. The mobile phone function is covered in another two test reports, which standards used are FCC Part 24 and FCC Part 22.
4. The EUT have lithium batteries listed as below:

<b>BATTERY 1:</b>	
<b>BRAND:</b>	Dynapack International Technology Corporation
<b>MODEL:</b>	TRIN160
<b>RATING:</b>	3.7Vdc, 1500mAh

<b>BATTERY 2:</b>	
<b>BRAND:</b>	SK mobile energy CO., LTD
<b>MODEL:</b>	TRIN160
<b>RATING:</b>	3.7Vdc, 1500mAh

**NOTE:** After pre-tested both batteries and both model, found TITA100 with batter 1 is worse, therefore all the test results came out from this.

5. The EUT was operated with following power adapters:

<b>ADAPTER 1:</b>	
<b>BRAND:</b>	DELTA ELECTRONIC, INC.
<b>MODEL:</b>	ADP-5FH B
<b>INPUT:</b>	100-240Vac ~ 50-60Hz, 0.2A,
<b>OUTPUT:</b>	5.0Vdc, 1A
<b>POWER LINE:</b>	DC 1.8m non-shielded cable without core

<b>ADAPTER 2:</b>	
<b>BRAND:</b>	PHIHONG
<b>MODEL:</b>	PSAA05A-050
<b>INPUT:</b>	100~240Vac, 200mA, 50-60Hz
<b>OUTPUT:</b>	5.0Vdc, 1A
<b>POWER LINE:</b>	DC 1.8m non-shielded cable without core

6. The EUT was operated with following charging cradle:

<b>MODEL:</b>	TITA150
<b>OUTPUT:</b>	5.0Vdc, 1A

7. The EUT operates in the 2.4GHz frequency spectrum and complies with 802.11b & 802.11g techniques.

8. The above EUT information was declared by manufacturer and for more detailed features description, please refer to the manufacturer's specifications or User's Manual.

### 3.2 DESCRIPTION OF TEST MODES

Since the EUT is considered a portable unit, it was pre-tested on the positioned of each 3 axis. For wireless LAN function, the worst case was found when positioned on Z-plane. Therefore only the test data of this Z-plane was used for radiated test.

There are 7 test modes presented in the report as below.

TEST MODE	TEST CONDITION
A	The EUT with battery 1, and was powered by the adapter 1.
B	The EUT with battery 1, and was powered by the adapter 2.
C	The EUT with battery 1 connected with the earphone via USB cable, and was powered by the adapter 1 via USB cable.
D	The EUT with battery 1 connected with the earphone via USB cable, and was powered by the adapter 2 via USB cable.
E	The EUT with battery 1 connected with the earphone and notebook via USB cable, and was powered by notebook.
F	The EUT with battery 1 connected with the cradle, and was powered by the adapter 1.
G	The EUT with battery 1 connected with the cradle, and was powered by the adapter 2.

11 channels are provided to the EUT for wireless LAN function:

CHANNEL	FREQUENCY	CHANNEL	FREQUENCY
1	2412 MHz	7	2442 MHz
2	2417 MHz	8	2447 MHz
3	2422 MHz	9	2452 MHz
4	2427 MHz	10	2457 MHz
5	2432 MHz	11	2462 MHz
6	2437 MHz		



### 3.2.1 CONFIGURATION OF SYSTEM UNDER TEST

#### TEST MODE A, B,

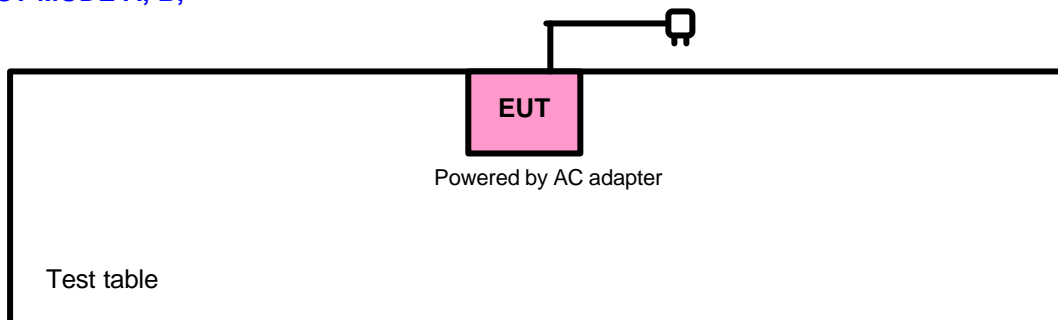

#### TEST MODE C, D

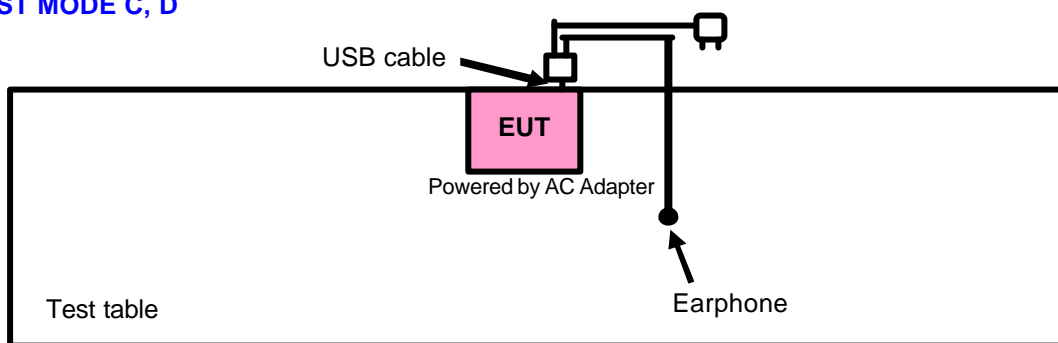

#### TEST MODE E

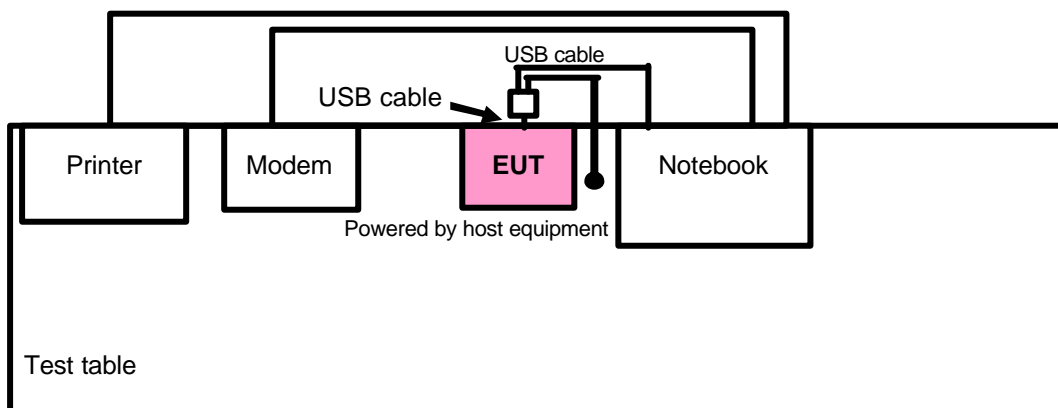

#### TEST MODE F, G

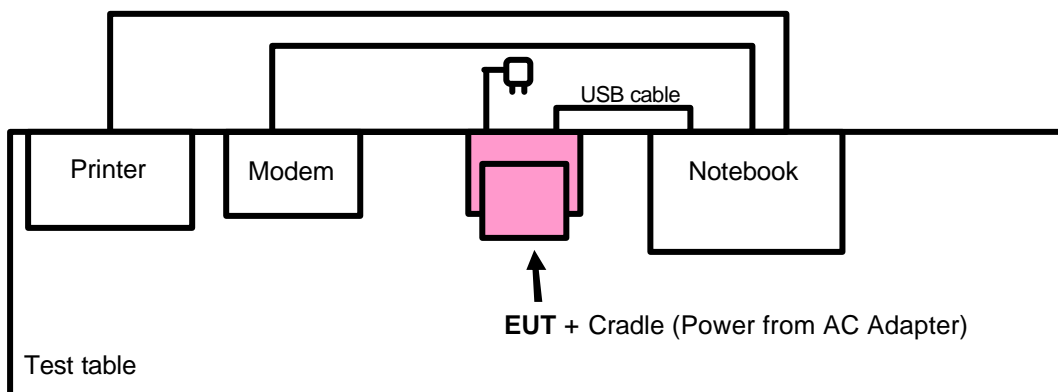

### 3.2.2 TEST MODE APPLICABILITY AND TESTED CHANNEL DETAIL :

EUT CONFIGURE MODE	APPLICABLE TO				DESCRIPTION
	PLC	RE<1G	RE <sup>3</sup> 1G	APCM	
A	v	v	-	-	The EUT with battery 1, and was powered by the adapter 1.
B	v	v	-	-	The EUT with battery 1, and was powered by the adapter 2.
C	v	v	-	-	The EUT with battery 1 connected with the earphone via USB cable, and was powered by the adapter 1 via USB cable.
D	v	v	-	-	The EUT with battery 1 connected with the earphone via USB cable, and was powered by the adapter 2 via USB cable.
E	v	v	v	v	The EUT with battery 1 connected with the earphone and notebook via USB cable, and was powered by notebook.
F	v	v	-	-	The EUT with battery 1 connected with the cradle, and was powered by the adapter 1.
G	v	v	-	-	The EUT with battery 1 connected with the cradle, and was powered by the adapter 2.

Where **PLC**: Power Line Conducted Emission  
**RE<sup>3</sup> 1G**: Radiated Emission above 1GHz

**RE<1G**: Radiated Emission below 1GHz  
**APCM**: Antenna Port Conducted Measurement

**NOTE**: “-“ means no effect.

#### **POWER LINE CONDUCTED EMISSION TEST:**

? Pre-Scan has been conducted to determine the worst-case mode from all possible combinations between available modulations, data rates and antenna ports (if EUT with antenna diversity architecture).

Following channel(s) was (were) selected for the final test as listed below.

EUT CONFIGURE MODE	AVAILABLE CHANNEL	TESTED CHANNEL	MODULATION TECHNOLOGY	MODULATION TYPE	DATA RATE (Mbps)
A	1 to 11	1, 6, 11	OFDM	BPSK	6
B	1 to 11	1, 6, 11	OFDM	BPSK	6
C	1 to 11	1, 6, 11	OFDM	BPSK	6
D	1 to 11	1, 6, 11	OFDM	BPSK	6
E	1 to 11	1, 6, 11	OFDM	BPSK	6
F	1 to 11	1, 6, 11	OFDM	BPSK	6
G	1 to 11	1, 6, 11	OFDM	BPSK	6

**RADIATED EMISSION TEST (BELOW 1 GHz):**

- ? Pre-Scan has been conducted to determine the worst-case mode from all possible combinations between available modulations, data rates, antenna ports (if EUT with antenna diversity architecture), X, Y and Z Axis.
- Following channel(s) was (were) selected for the final test as listed below.

EUT CONFIGURE MODE	AVAILABLE CHANNEL	TESTED CHANNEL	MODULATION TECHNOLOGY	MODULATION TYPE	DATA RATE (Mbps)	AXIS
A	1 to 11	11	OFDM	BPSK	6	Z
B	1 to 11	11	OFDM	BPSK	6	Z
C	1 to 11	11	OFDM	BPSK	6	Z
D	1 to 11	11	OFDM	BPSK	6	Z
E	1 to 11	11	OFDM	BPSK	6	Z
F	1 to 11	11	OFDM	BPSK	6	Z
G	1 to 11	11	OFDM	BPSK	6	Z

**RADIATED EMISSION TEST (ABOVE 1 GHz):**

- ? Pre-Scan has been conducted to determine the worst-case mode from all possible combinations between available modulations, data rates, antenna ports (if EUT with antenna diversity architecture).
- Following channel(s) was (were) selected for the final test as listed below.

EUT CONFIGURE MODE	AVAILABLE CHANNEL	TESTED CHANNEL	MODULATION TECHNOLOGY	MODULATION TYPE	DATA RATE (Mbps)
E	1 to 11	1, 6, 11	DSSS	DBPSK	1
E	1 to 11	1, 6, 11	OFDM	BPSK	6

**BANDEDGE MEASUREMENT:**

- ? Pre-Scan has been conducted to determine the worst-case mode from all possible combinations between available modulations, data rates and antenna ports (if EUT with antenna diversity architecture).
- Following channel(s) was (were) selected for the final test as listed below.

AVAILABLE CHANNEL	TESTED CHANNEL	MODULATION TECHNOLOGY	MODULATION TYPE	DATA RATE(Mbps)
1 to 11	1, 11	DSSS	DBPSK	1
1 to 11	1, 11	OFDM	BPSK	6



**ANTENNA PORT CONDUCTED MEASUREMENT:**

- ? Pre-Scan has been conducted to determine the worst-case mode from all possible combinations between available modulations, data rates and antenna ports (if EUT with antenna diversity architecture).
- Following channel(s) was (were) selected for the final test as listed below.

AVAILABLE CHANNEL	TESTED CHANNEL	MODULATION TECHNOLOGY	MODULATION TYPE	DATA RATE(Mbps)
1 to 11	1, 6, 11	DSSS	DBPSK	1
1 to 11	1, 6, 11	OFDM	BPSK	6



### 3.3.3 GENERAL DESCRIPTION OF APPLIED STANDARDS

The EUT is a RF Product. According to the specifications of the manufacturer, it must comply with the requirements of the following standards:

**FCC Part 15, Subpart C. (15.247)**

**ANSI C63.4- 2003**

All test items have been performed and recorded as per the above standards.

**NOTE:** The EUT is also considered as a kind of computer peripheral, because the connection to computer is necessary for typical use. It has been verified to comply with the requirements of FCC Part 15, Subpart B, Class B (DoC). The test report has been issued separately.

### 3.3.4 DESCRIPTION OF SUPPORT UNITS

The EUT has been tested as an independent unit together with other necessary accessories or support units. The following support units or accessories were used to form a representative test configuration during the tests.

NO.	PRODUCT	BRAND	MODEL NO.	SERIAL NO.	FCC ID
1	NOTEBOOK COMPUTER	DELL	PP05L	12130898320	E2K24CLNS
2	MODEM	ACEEX	1414V/3	0401008248	IFAXDM1414
3	PRINTER	EPSON	LQ-300+	DCGY047265	FCC DoC Approved

NO.	SIGNAL CABLE DESCRIPTION OF THE ABOVE SUPPORT UNITS
1	NA
2	1.2 m shielded cable without core
3	1.2 m shielded cable without core

**NOTE:** All power cords of the above support units are non shielded (1.8m).

## 4. TEST TYPES AND RESULTS

### 4.1 CONDUCTED EMISSION MEASUREMENT

#### 4.1.1 LIMITS OF CONDUCTED EMISSION MEASUREMENT

FREQUENCY OF EMISSION (MHz)	CONDUCTED LIMIT (dB $\mu$ V)	
	Quasi-peak	Average
0.15 ~ 0.5	66 to 56	56 to 46
0.5 ~ 5	56	46
5 ~ 30	60	50

- NOTE:**
1. The lower limit shall apply at the transition frequencies.
  2. The limit decreases in line with the logarithm of the frequency in the range of 0.15 to 0.50 MHz.
  3. All emanations from a class A/B digital device or system, including any network of conductors and apparatus connected thereto, shall not exceed the level of field strengths specified above.

#### 4.1.2 TEST INSTRUMENTS

DESCRIPTION & MANUFACTURER	MODEL NO.	SERIAL NO.	CALIBRATED UNTIL
Test Receiver ROHDE & SCHWARZ	ESCS30	100288	Nov. 02, 2006
RF signal cable Woken	5D-FB	Cable-HYCO3-01	Jan. 06, 2007
LISN ROHDE & SCHWARZ	ESH2-Z5	100100	Jan. 09, 2007
LISN ROHDE & SCHWARZ	ESH3-Z5	100311	Jan. 22, 2007
Software ADT	ADT_Cond_V3	NA	NA

- NOTE:**
1. The calibration interval of the above test instruments is 12 months and the calibrations are traceable to NML/ROC and NIST/USA.
  2. The test was performed in HwaYa Shielded Room 2.
  3. The VCCI Site Registration No. is C-2047.

#### 4.1.3 TEST PROCEDURES

- a. The EUT was placed 0.4 meters from the conducting wall of the shielded room with EUT being connected to the power mains through a line impedance stabilization network (LISN). Other support units were connected to the power mains through another LISN. The two LISNs provide 50 ohm/ 50uH of coupling impedance for the measuring instrument.
- b. Both lines of the power mains connected to the EUT were checked for maximum conducted interference.
- c. The frequency range from 150kHz to 30MHz was searched. Emission levels under (Limit - 20dB) was not recorded.

#### 4.1.4 DEVIATION FROM TEST STANDARD

No deviation

#### 4.1.5 TEST SETUP

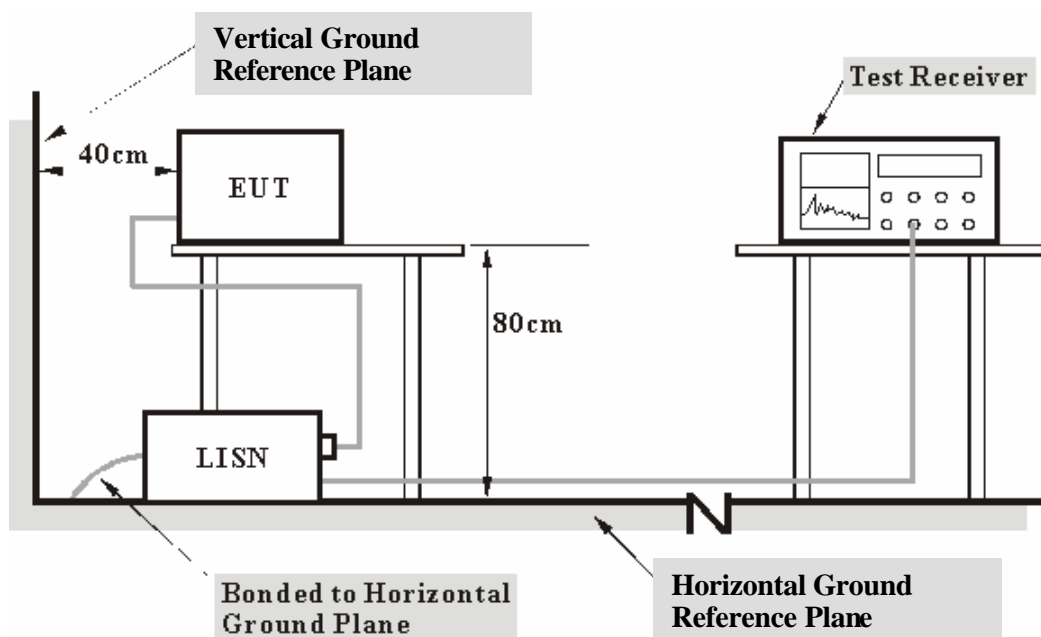

- Note: 1. Support units were connected to second LISN.  
 2. Both of LISNs (AMN) 80 cm from EUT and at the least 80 cm from other units and other metal planes support units.

For the actual test configuration, please refer to the attached file (Test Setup Photo).

#### 4.1.6 EUT OPERATING CONDITIONS

##### TEST MODE A ~ D:

The EUT placed on the testing table and set it under transmission condition continuously at specific channel frequency.

##### TEST MODE E ~ G:

- Connected the EUT to a notebook system via USB cable and placed on a testing table.
- The notebook system ran a test program (provided by manufacturer) to enable EUT under transmission condition continuously at specific channel frequency.
- The necessary accessories enable the EUT in full functions.



#### 4.1.7 TEST RESULTS

##### CONDUCTED WORST CASE DATA:

EUT TEST CONDITION		MEASUREMENT DETAIL	
CHANNEL	Channel 1	PHASE	Line 1
MODULATION TYPE	BPSK	6dB BANDWIDTH	9 kHz
ENVIRONMENTAL CONDITIONS	20deg. C, 60%RH, 991hPa	INPUT POWER (SYSTEM)	120Vac, 60 Hz
TRANSFER RATE	6Mbps	TEST MODE	A
TESTED BY	Mstch Tsui		

No	Freq. [MHz]	Corr. Factor [dB]	Reading Value [dB (uV)]		Emission Level [dB (uV)]		Limit [dB (uV)]		Margin (dB)	
			Q.P.	AV.	Q.P.	AV.	Q.P.	AV.	Q.P.	AV.
1	0.181	0.10	38.75	-	38.85	-	64.43	54.43	-25.58	-
2	0.240	0.10	32.25	-	32.35	-	62.10	52.10	-29.75	-
3	0.486	0.10	33.94	-	34.04	-	56.24	46.24	-22.20	-
4	0.912	0.10	31.44	-	31.54	-	56.00	46.00	-24.46	-
5	2.617	0.25	33.35	-	33.60	-	56.00	46.00	-22.40	-
6	18.785	0.58	30.53	-	31.11	-	60.00	50.00	-28.89	-

- REMARKS:**
1. Q.P. and AV. are abbreviations of quasi-peak and average individually.
  2. "-": The Quasi-peak reading value also meets average limit and measurement with the average detector is unnecessary.
  3. The emission levels of other frequencies were very low against the limit.
  4. Margin value = Emission level - Limit value
  5. Correction factor = Insertion loss + Cable loss
  6. Emission Level = Correction Factor + Reading Value.

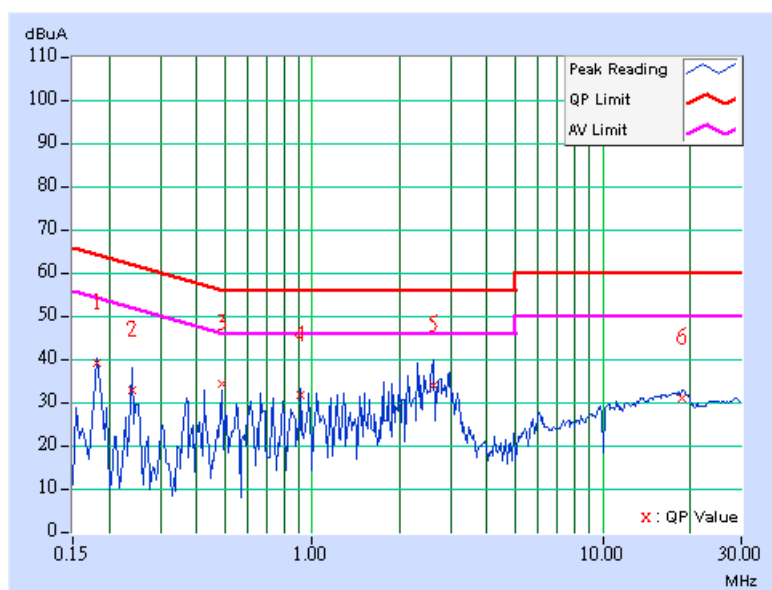

EUT TEST CONDITION		MEASUREMENT DETAIL	
CHANNEL	Channel 1	PHASE	Line 2
MODULATION TYPE	BPSK	6dB BANDWIDTH	9 kHz
ENVIRONMENTAL CONDITIONS	20deg. C, 60%RH, 991hPa	INPUT POWER (SYSTEM)	120Vac, 60 Hz
TRANSFER RATE	6Mbps	TEST MODE	A
TESTED BY	Mstch Tsui		

No	Freq. [MHz]	Corr. Factor (dB)	Reading Value [dB (uV)]		Emission Level [dB (uV)]		Limit [dB (uV)]		Margin (dB)	
			Q.P.	AV.	Q.P.	AV.	Q.P.	AV.	Q.P.	AV.
			1	0.181	0.10	37.74	-	37.84	-	64.43
2	0.244	0.10	34.09	-	34.19	-	61.97	51.97	-27.78	-
3	0.486	0.11	33.94	-	34.05	-	56.24	46.24	-22.18	-
4	1.277	0.20	30.09	-	30.29	-	56.00	46.00	-25.71	-
5	2.555	0.25	33.16	-	33.41	-	56.00	46.00	-22.59	-
6	18.671	0.58	30.58	-	31.16	-	60.00	50.00	-28.84	-

- REMARKS:**
1. Q.P. and AV. are abbreviations of quasi-peak and average individually.
  2. "-": The Quasi-peak reading value also meets average limit and measurement with the average detector is unnecessary.
  3. The emission levels of other frequencies were very low against the limit.
  4. Margin value = Emission level - Limit value
  5. Correction factor = Insertion loss + Cable loss
  6. Emission Level = Correction Factor + Reading Value.

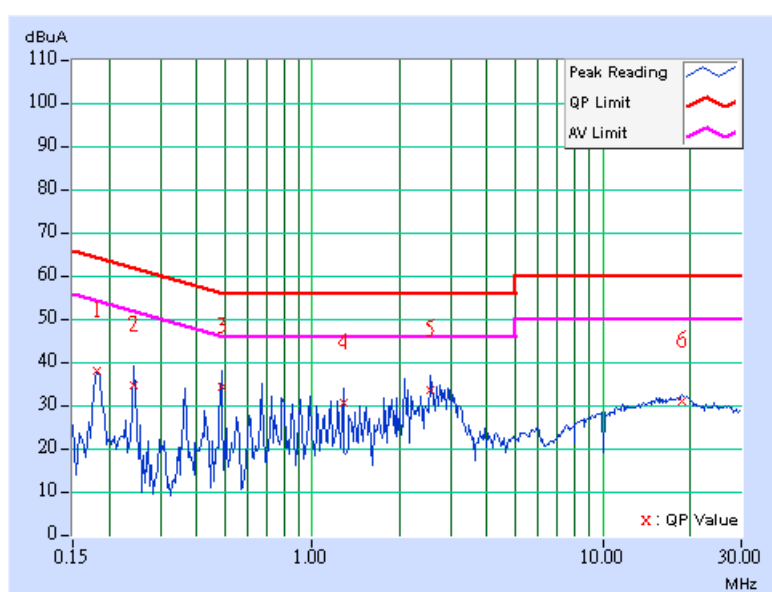

EUT TEST CONDITION		MEASUREMENT DETAIL	
CHANNEL	Channel 6	PHASE	Line 1
MODULATION TYPE	BPSK	6dB BANDWIDTH	9 kHz
ENVIRONMENTAL CONDITIONS	20deg. C, 60%RH, 991 hPa	INPUT POWER (SYSTEM)	120Vac, 60 Hz
TRANSFER RATE	6Mbps	TEST MODE	A
TESTED BY	Mstch Tsui		

No	Freq. [MHz]	Corr. Factor [dB]	Reading Value [dB (uV)]		Emission Level [dB (uV)]		Limit [dB (uV)]		Margin (dB)	
			Q.P.	AV.	Q.P.	AV.	Q.P.	AV.	Q.P.	AV.
			1	0.185	0.10	37.44	-	37.54	-	64.25
2	0.244	0.10	34.17	-	34.27	-	61.96	51.96	-27.69	-
3	0.490	0.10	31.54	-	31.64	-	56.17	46.17	-24.53	-
4	1.094	0.11	23.58	-	23.69	-	56.00	46.00	-32.31	-
5	2.799	0.27	35.57	-	35.84	-	56.00	46.00	-20.16	-
6	19.086	0.57	30.20	-	30.77	-	60.00	50.00	-29.23	-

- REMARKS:**
1. Q.P. and AV. are abbreviations of quasi-peak and average individually.
  2. "-": The Quasi-peak reading value also meets average limit and measurement with the average detector is unnecessary.
  3. The emission levels of other frequencies were very low against the limit.
  4. Margin value = Emission level - Limit value
  5. Correction factor = Insertion loss + Cable loss
  6. Emission Level = Correction Factor + Reading Value.

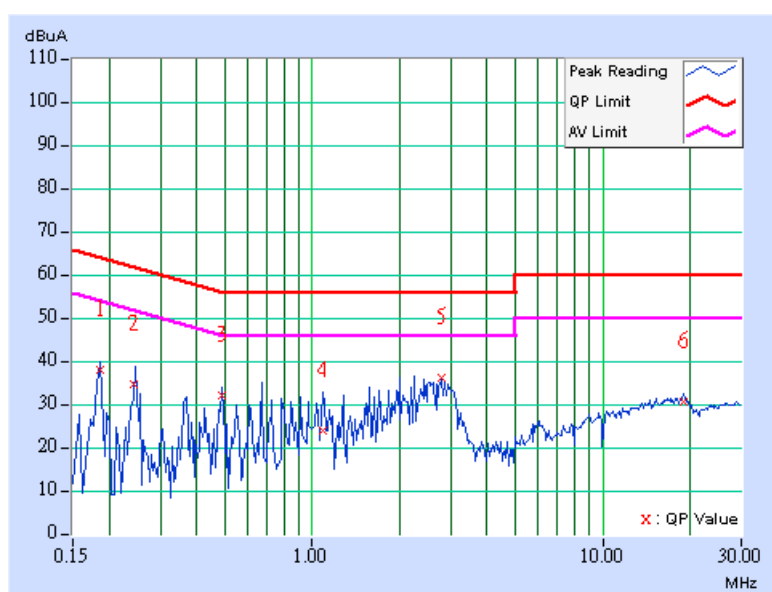

EUT TEST CONDITION		MEASUREMENT DETAIL	
CHANNEL	Channel 6	PHASE	Line 2
MODULATION TYPE	BPSK	6dB BANDWIDTH	9 kHz
ENVIRONMENTAL CONDITIONS	20deg. C, 60%RH, 991hPa	INPUT POWER (SYSTEM)	120Vac, 60 Hz
TRANSFER RATE	6Mbps	TEST MODE	A
TESTED BY	Mstch Tsui		

No	Freq. [MHz]	Corr. Factor [dB]	Reading Value [dB (uV)]		Emission Level [dB (uV)]		Limit [dB (uV)]		Margin (dB)	
			Q.P.	AV.	Q.P.	AV.	Q.P.	AV.	Q.P.	AV.
			1	0.181	0.10	37.31	-	37.41	-	64.43
2	0.244	0.10	35.01	-	35.11	-	61.97	51.97	-26.86	-
3	0.490	0.11	31.25	-	31.36	-	56.17	46.17	-24.81	-
4	0.728	0.15	33.40	-	33.55	-	56.00	46.00	-22.45	-
5	2.738	0.26	34.37	-	34.63	-	56.00	46.00	-21.37	-
6	19.387	0.57	29.81	-	30.38	-	60.00	50.00	-29.62	-

- REMARKS:**
1. Q.P. and AV. are abbreviations of quasi-peak and average individually.
  2. "-": The Quasi-peak reading value also meets average limit and measurement with the average detector is unnecessary.
  3. The emission levels of other frequencies were very low against the limit.
  4. Margin value = Emission level - Limit value
  5. Correction factor = Insertion loss + Cable loss
  6. Emission Level = Correction Factor + Reading Value.

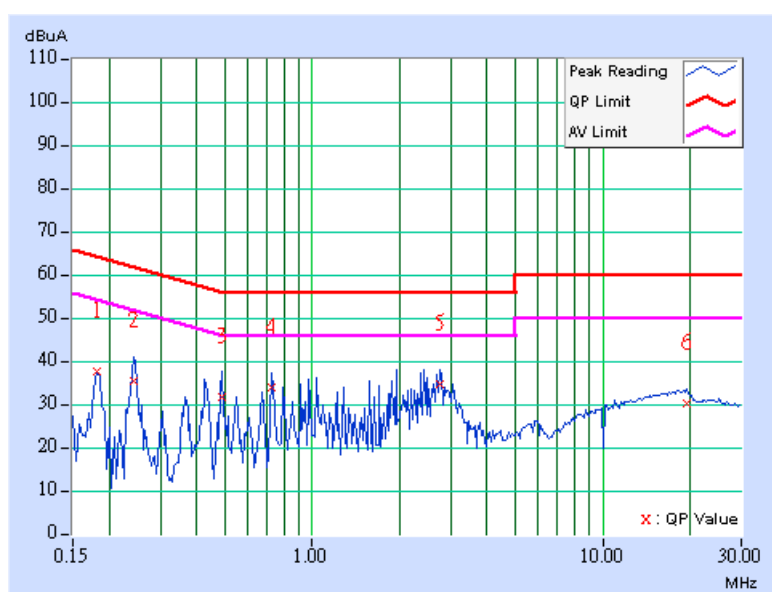

EUT TEST CONDITION		MEASUREMENT DETAIL	
CHANNEL	Channel 11	PHASE	Line 1
MODULATION TYPE	BPSK	6dB BANDWIDTH	9 kHz
ENVIRONMENTAL CONDITIONS	20deg. C, 60%RH, 991hPa	INPUT POWER (SYSTEM)	120Vac, 60 Hz
TRANSFER RATE	6Mbps	TEST MODE	A
TESTED BY	Mstch Tsui		

No	Freq. [MHz]	Corr. Factor [dB]	Reading Value [dB (uV)]		Emission Level [dB (uV)]		Limit [dB (uV)]		Margin (dB)	
			Q.P.	AV.	Q.P.	AV.	Q.P.	AV.	Q.P.	AV.
			1	0.185	0.10	37.02	-	37.12	-	64.25
2	0.244	0.10	34.80	-	34.90	-	61.97	51.97	-27.07	-
3	0.670	0.10	32.87	-	32.97	-	56.00	46.00	-23.03	-
4	2.066	0.21	34.35	-	34.56	-	56.00	46.00	-21.44	-
5	2.738	0.26	36.09	-	36.35	-	56.00	46.00	-19.65	-
6	18.905	0.58	29.74	-	30.32	-	60.00	50.00	-29.68	-

- REMARKS:**
1. Q.P. and AV. are abbreviations of quasi-peak and average individually.
  2. "-": The Quasi-peak reading value also meets average limit and measurement with the average detector is unnecessary.
  3. The emission levels of other frequencies were very low against the limit.
  4. Margin value = Emission level - Limit value
  5. Correction factor = Insertion loss + Cable loss
  6. Emission Level = Correction Factor + Reading Value.

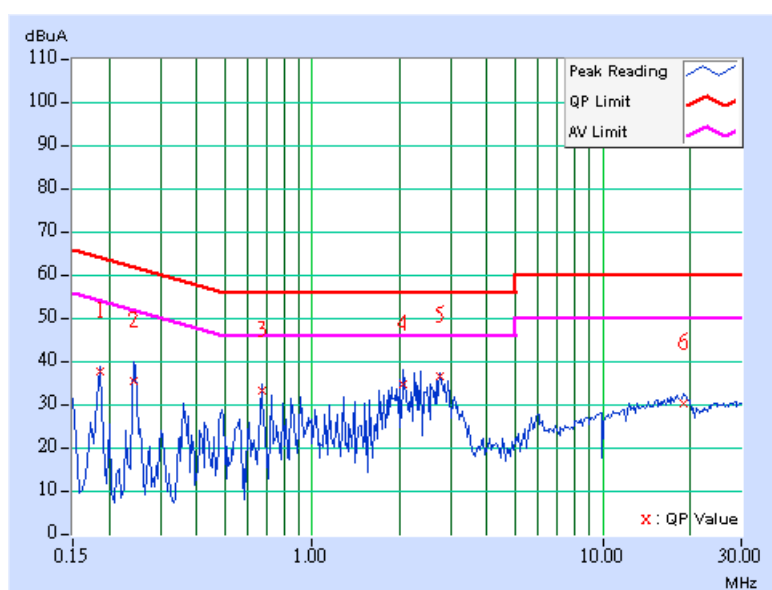

EUT TEST CONDITION		MEASUREMENT DETAIL	
CHANNEL	Channel 11	PHASE	Line 2
MODULATION TYPE	BPSK	6dB BANDWIDTH	9 kHz
ENVIRONMENTAL CONDITIONS	20deg. C, 60%RH, 991 hPa	INPUT POWER (SYSTEM)	120Vac, 60 Hz
TRANSFER RATE	6Mbps	TEST MODE	A
TESTED BY	Mstch Tsui		

No	Freq. [MHz]	Corr. Factor [dB]	Reading Value [dB (uV)]		Emission Level [dB (uV)]		Limit [dB (uV)]		Margin (dB)	
			Q.P.	AV.	Q.P.	AV.	Q.P.	AV.	Q.P.	AV.
			1	0.181	0.10	36.27	-	36.37	-	64.43
2	0.240	0.10	33.84	-	33.94	-	62.10	52.10	-28.16	-
3	0.486	0.11	33.38	-	33.49	-	56.24	46.24	-22.74	-
4	0.974	0.20	30.63	-	30.83	-	56.00	46.00	-25.17	-
5	2.734	0.26	36.61	-	36.87	-	56.00	46.00	-19.13	-
6	19.328	0.57	30.50	-	31.07	-	60.00	50.00	-28.93	-

- REMARKS:**
1. Q.P. and AV. are abbreviations of quasi-peak and average individually.
  2. "-": The Quasi-peak reading value also meets average limit and measurement with the average detector is unnecessary.
  3. The emission levels of other frequencies were very low against the limit.
  4. Margin value = Emission level - Limit value
  5. Correction factor = Insertion loss + Cable loss
  6. Emission Level = Correction Factor + Reading Value.

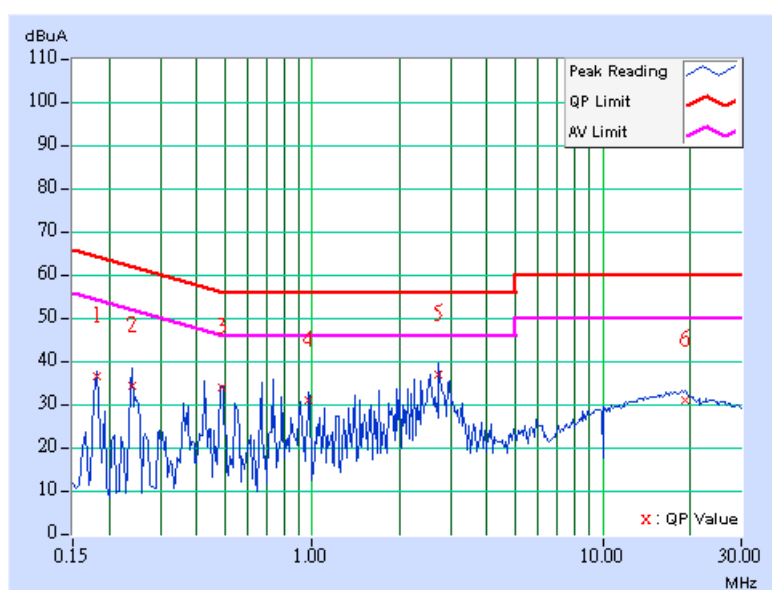

EUT TEST CONDITION		MEASUREMENT DETAIL	
CHANNEL	Channel 1	PHASE	Line 1
MODULATION TYPE	BPSK	6dB BANDWIDTH	9 kHz
ENVIRONMENTAL CONDITIONS	20deg. C, 60%RH, 991 hPa	INPUT POWER (SYSTEM)	120Vac, 60 Hz
TRANSFER RATE	6Mbps	TEST MODE	B
TESTED BY	Match Tsui		

No	Freq. [MHz]	Corr. Factor (dB)	Reading Value [dB (uV)]		Emission Level [dB (uV)]		Limit [dB (uV)]		Margin (dB)	
			Q.P.	AV.	Q.P.	AV.	Q.P.	AV.	Q.P.	AV.
			1	0.318	0.10	43.52	-	43.62	-	59.76
2	0.447	0.10	43.03	-	43.13	-	56.93	46.93	-13.80	-
3	0.538	0.10	42.86	-	42.96	-	56.00	46.00	-13.04	-
4	0.869	0.10	40.64	-	40.74	-	56.00	46.00	-15.26	-
5	1.551	0.16	40.93	-	41.09	-	56.00	46.00	-14.91	-
6	8.680	0.36	38.15	-	38.51	-	60.00	50.00	-21.49	-

- REMARKS:**
1. Q.P. and AV. are abbreviations of quasi-peak and average individually.
  2. "-": The Quasi-peak reading value also meets average limit and measurement with the average detector is unnecessary.
  3. The emission levels of other frequencies were very low against the limit.
  4. Margin value = Emission level - Limit value
  5. Correction factor = Insertion loss + Cable loss
  6. Emission Level = Correction Factor + Reading Value.

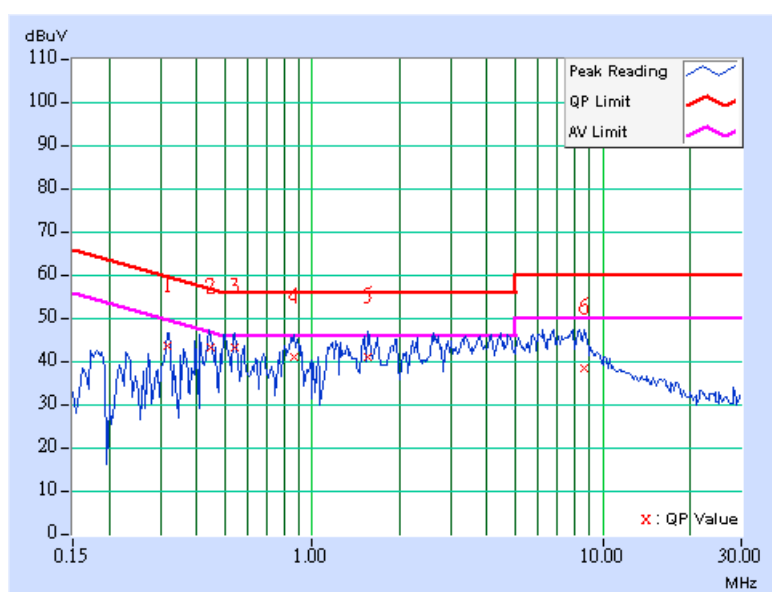

EUT TEST CONDITION		MEASUREMENT DETAIL	
CHANNEL	Channel 1	PHASE	Line 2
MODULATION TYPE	BPSK	6dB BANDWIDTH	9 kHz
ENVIRONMENTAL CONDITIONS	20deg. C, 60%RH, 991hPa	INPUT POWER (SYSTEM)	120Vac, 60 Hz
TRANSFER RATE	6Mbps	TEST MODE	B
TESTED BY	Match Tsui		

No	Freq. [MHz]	Corr. Factor [dB]	Reading Value [dB (uV)]		Emission Level [dB (uV)]		Limit [dB (uV)]		Margin (dB)	
			Q.P.	AV.	Q.P.	AV.	Q.P.	AV.	Q.P.	AV.
			1	0.373	0.10	40.62	-	40.72	-	58.44
2	0.500	0.12	37.85	-	37.97	-	56.00	46.00	-18.03	-
3	0.810	0.17	35.81	-	35.98	-	56.00	46.00	-20.02	-
4	1.195	0.20	37.16	-	37.36	-	56.00	46.00	-18.64	-
5	2.035	0.20	35.69	-	35.89	-	56.00	46.00	-20.11	-
6	6.637	0.41	34.61	-	35.02	-	60.00	50.00	-24.98	-

- REMARKS:**
1. Q.P. and AV. are abbreviations of quasi-peak and average individually.
  2. "-": The Quasi-peak reading value also meets average limit and measurement with the average detector is unnecessary.
  3. The emission levels of other frequencies were very low against the limit.
  4. Margin value = Emission level - Limit value
  5. Correction factor = Insertion loss + Cable loss
  6. Emission Level = Correction Factor + Reading Value.

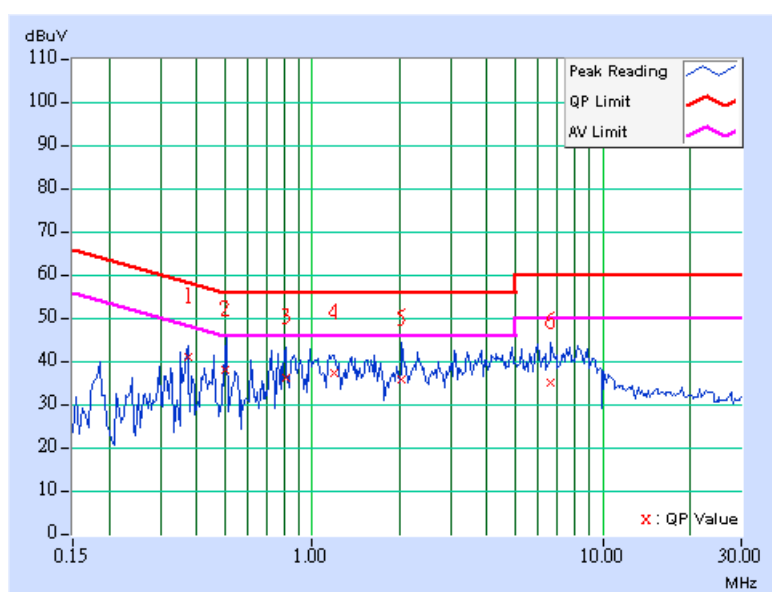



EUT TEST CONDITION		MEASUREMENT DETAIL	
CHANNEL	Channel 6	PHASE	Line 1
MODULATION TYPE	BPSK	6dB BANDWIDTH	9 kHz
ENVIRONMENTAL CONDITIONS	20deg. C, 60%RH, 991 hPa	INPUT POWER (SYSTEM)	120Vac, 60 Hz
TRANSFER RATE	6Mbps	TEST MODE	B
TESTED BY	Match Tsui		

No	Freq. [MHz]	Corr. Factor [dB]	Reading Value [dB (uV)]		Emission Level [dB (uV)]		Limit [dB (uV)]		Margin (dB)	
			Q.P.	AV.	Q.P.	AV.	Q.P.	AV.	Q.P.	AV.
			1	0.318	0.10	43.48	-	43.58	-	59.76
2	0.443	0.10	43.17	-	43.27	-	57.01	47.01	-13.74	-
3	0.537	0.10	42.84	-	42.94	-	56.00	46.00	-13.06	-
4	0.841	0.10	41.14	-	41.24	-	56.00	46.00	-14.76	-
5	1.953	0.20	37.60	-	37.80	-	56.00	46.00	-18.20	-
6	7.953	0.36	39.11	-	39.47	-	60.00	50.00	-20.53	-

- REMARKS:**
1. Q.P. and AV. are abbreviations of quasi-peak and average individually.
  2. "-": The Quasi-peak reading value also meets average limit and measurement with the average detector is unnecessary.
  3. The emission levels of other frequencies were very low against the limit.
  4. Margin value = Emission level - Limit value
  5. Correction factor = Insertion loss + Cable loss
  6. Emission Level = Correction Factor + Reading Value.

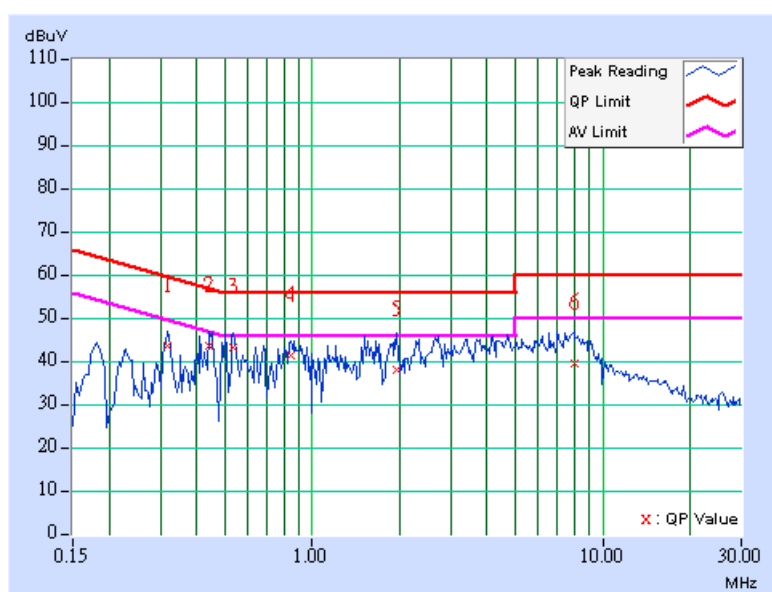

EUT TEST CONDITION		MEASUREMENT DETAIL	
CHANNEL	Channel 6	PHASE	Line 2
MODULATION TYPE	BPSK	6dB BANDWIDTH	9 kHz
ENVIRONMENTAL CONDITIONS	20deg. C, 60%RH, 991hPa	INPUT POWER (SYSTEM)	120Vac, 60 Hz
TRANSFER RATE	6Mbps	TEST MODE	B
TESTED BY	Match Tsui		

No	Freq. [MHz]	Corr. Factor [dB]	Reading Value [dB (uV)]		Emission Level [dB (uV)]		Limit [dB (uV)]		Margin (dB)	
			Q.P.	AV.	Q.P.	AV.	Q.P.	AV.	Q.P.	AV.
			1	0.318	0.10	39.88	-	39.98	-	59.76
2	0.427	0.10	38.09	-	38.19	-	57.30	47.30	-19.11	-
3	0.503	0.12	37.37	-	37.49	-	56.00	46.00	-18.51	-
4	1.000	0.20	37.27	-	37.47	-	56.00	46.00	-18.53	-
5	2.695	0.26	34.77	-	35.03	-	56.00	46.00	-20.97	-
6	7.723	0.43	35.48	-	35.91	-	60.00	50.00	-24.09	-

- REMARKS:**
1. Q.P. and AV. are abbreviations of quasi-peak and average individually.
  2. "-": The Quasi-peak reading value also meets average limit and measurement with the average detector is unnecessary.
  3. The emission levels of other frequencies were very low against the limit.
  4. Margin value = Emission level - Limit value
  5. Correction factor = Insertion loss + Cable loss
  6. Emission Level = Correction Factor + Reading Value.

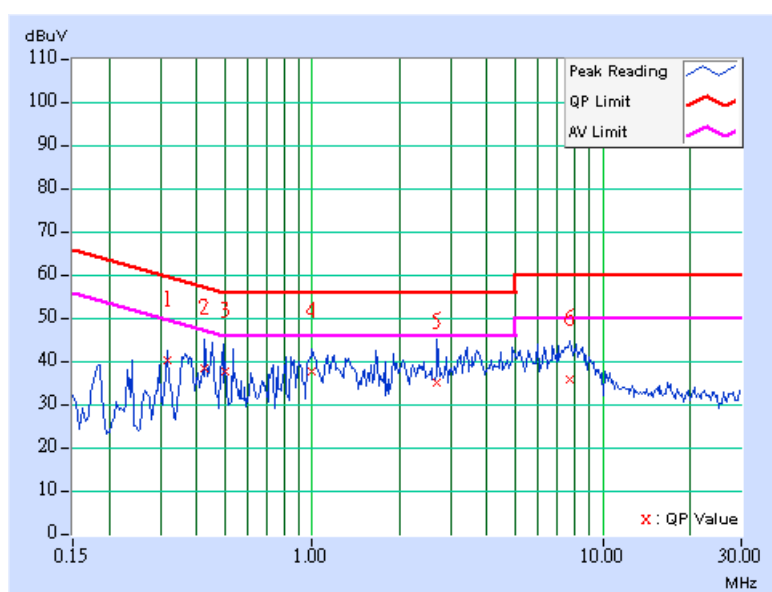

EUT TEST CONDITION		MEASUREMENT DETAIL	
CHANNEL	Channel 11	PHASE	Line 1
MODULATION TYPE	BPSK	6dB BANDWIDTH	9 kHz
ENVIRONMENTAL CONDITIONS	20deg. C, 60%RH, 991 hPa	INPUT POWER (SYSTEM)	120Vac, 60 Hz
TRANSFER RATE	6Mbps	TEST MODE	B
TESTED BY	Match Tsui		

No	Freq. [MHz]	Corr. Factor (dB)	Reading Value [dB (uV)]		Emission Level [dB (uV)]		Limit [dB (uV)]		Margin (dB)	
			Q.P.	AV.	Q.P.	AV.	Q.P.	AV.	Q.P.	AV.
			1	0.318	0.10	43.46	-	43.56	-	59.76
2	0.448	0.10	42.77	-	42.87	-	56.91	46.91	-14.04	-
3	0.533	0.10	43.02	-	43.12	-	56.00	46.00	-12.88	-
4	0.865	0.10	41.09	-	41.19	-	56.00	46.00	-14.81	-
5	2.727	0.26	38.69	-	38.95	-	56.00	46.00	-17.05	-
6	7.004	0.36	39.21	-	39.57	-	60.00	50.00	-20.43	-

- REMARKS:**
1. Q.P. and AV. are abbreviations of quasi-peak and average individually.
  2. "-": The Quasi-peak reading value also meets average limit and measurement with the average detector is unnecessary.
  3. The emission levels of other frequencies were very low against the limit.
  4. Margin value = Emission level - Limit value
  5. Correction factor = Insertion loss + Cable loss
  6. Emission Level = Correction Factor + Reading Value.

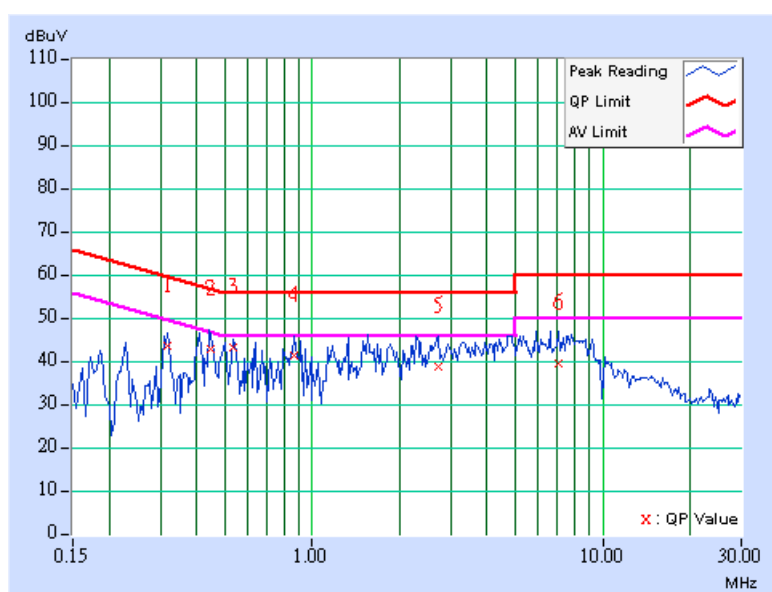

EUT TEST CONDITION		MEASUREMENT DETAIL	
CHANNEL	Channel 11	PHASE	Line 2
MODULATION TYPE	BPSK	6dB BANDWIDTH	9 kHz
ENVIRONMENTAL CONDITIONS	20deg. C, 60%RH, 991 hPa	INPUT POWER (SYSTEM)	120Vac, 60 Hz
TRANSFER RATE	6Mbps	TEST MODE	B
TESTED BY	Match Tsui		

No	Freq. [MHz]	Corr. Factor [dB]	Reading Value [dB (uV)]		Emission Level [dB (uV)]		Limit [dB (uV)]		Margin (dB)	
			Q.P.	AV.	Q.P.	AV.	Q.P.	AV.	Q.P.	AV.
			1	0.367	0.10	40.80	-	40.90	-	58.56
2	0.425	0.10	37.17	-	37.27	-	57.36	47.36	-20.08	-
3	0.500	0.12	38.16	-	38.28	-	56.00	46.00	-17.72	-
4	1.180	0.20	37.92	-	38.12	-	56.00	46.00	-17.88	-
5	2.367	0.23	35.25	-	35.48	-	56.00	46.00	-20.52	-
6	6.512	0.41	34.68	-	35.09	-	60.00	50.00	-24.91	-

- REMARKS:**
1. Q.P. and AV. are abbreviations of quasi-peak and average individually.
  2. "-": The Quasi-peak reading value also meets average limit and measurement with the average detector is unnecessary.
  3. The emission levels of other frequencies were very low against the limit.
  4. Margin value = Emission level - Limit value
  5. Correction factor = Insertion loss + Cable loss
  6. Emission Level = Correction Factor + Reading Value.

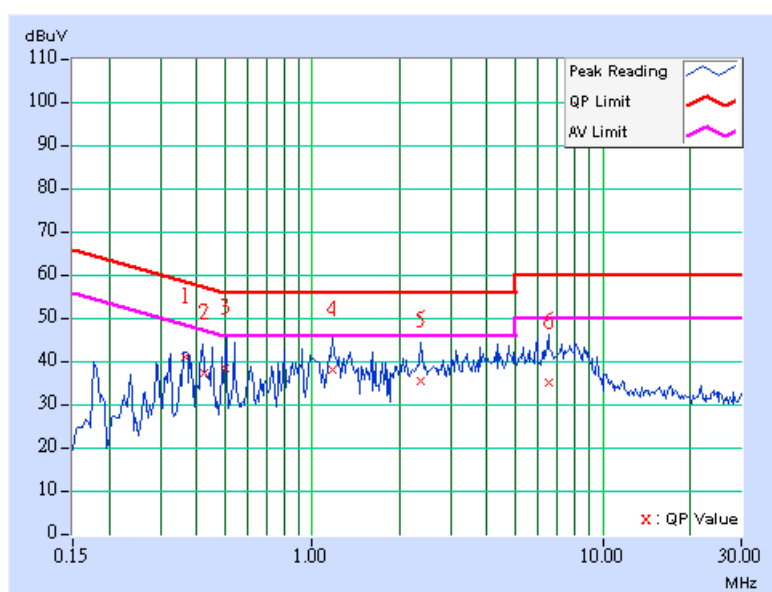

EUT TEST CONDITION		MEASUREMENT DETAIL	
CHANNEL	Channel 1	PHASE	Line 1
MODULATION TYPE	BPSK	6dB BANDWIDTH	9 kHz
ENVIRONMENTAL CONDITIONS	20deg. C, 60%RH, 991hPa	INPUT POWER (SYSTEM)	120Vac, 60 Hz
TRANSFER RATE	6Mbps	TEST MODE	C
TESTED BY	Mstch Tsui		

No	Freq. [MHz]	Corr. Factor [dB]	Reading Value [dB (uV)]		Emission Level [dB (uV)]		Limit [dB (uV)]		Margin (dB)	
			Q.P.	AV.	Q.P.	AV.	Q.P.	AV.	Q.P.	AV.
1	0.185	0.10	38.43	-	38.53	-	64.25	54.25	-25.72	-
2	0.244	0.10	32.82	-	32.92	-	61.97	51.97	-29.05	-
3	0.607	0.10	32.77	-	32.87	-	56.00	46.00	-23.13	-
4	0.974	0.10	33.31	-	33.41	-	56.00	46.00	-22.59	-
5	2.434	0.24	38.60	-	38.84	-	56.00	46.00	-17.16	-
6	17.653	0.59	33.33	-	33.92	-	60.00	50.00	-26.08	-

- REMARKS:**
1. Q.P. and AV. are abbreviations of quasi-peak and average individually.
  2. "-": The Quasi-peak reading value also meets average limit and measurement with the average detector is unnecessary.
  3. The emission levels of other frequencies were very low against the limit.
  4. Margin value = Emission level - Limit value
  5. Correction factor = Insertion loss + Cable loss
  6. Emission Level = Correction Factor + Reading Value.

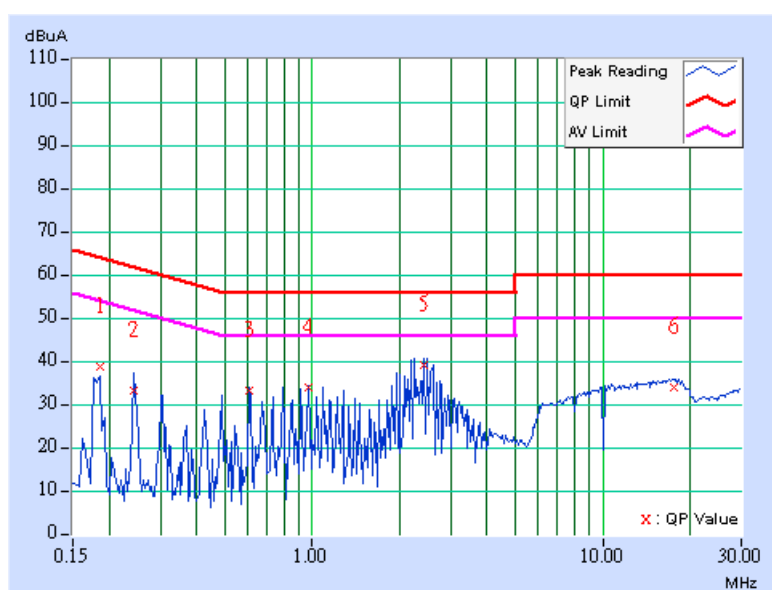

EUT TEST CONDITION		MEASUREMENT DETAIL	
CHANNEL	Channel 1	PHASE	Line 2
MODULATION TYPE	BPSK	6dB BANDWIDTH	9 kHz
ENVIRONMENTAL CONDITIONS	20deg. C, 60%RH, 991hPa	INPUT POWER (SYSTEM)	120Vac, 60 Hz
TRANSFER RATE	6Mbps	TEST MODE	C
TESTED BY	Mstch Tsui		

No	Freq. [MHz]	Corr. Factor [dB]	Reading Value [dB (uV)]		Emission Level [dB (uV)]		Limit [dB (uV)]		Margin (dB)	
			Q.P.	AV.	Q.P.	AV.	Q.P.	AV.	Q.P.	AV.
			1	0.181	0.10	39.92	-	40.02	-	64.43
2	0.244	0.10	33.53	-	33.63	-	61.97	51.97	-28.34	-
3	0.671	0.15	28.47	-	28.62	-	56.00	46.00	-27.38	-
4	1.035	0.20	30.32	-	30.52	-	56.00	46.00	-25.48	-
5	2.313	0.23	37.26	-	37.49	-	56.00	46.00	-18.51	-
6	15.206	0.63	33.18	-	33.81	-	60.00	50.00	-26.19	-

- REMARKS:**
1. Q.P. and AV. are abbreviations of quasi-peak and average individually.
  2. "-": The Quasi-peak reading value also meets average limit and measurement with the average detector is unnecessary.
  3. The emission levels of other frequencies were very low against the limit.
  4. Margin value = Emission level - Limit value
  5. Correction factor = Insertion loss + Cable loss
  6. Emission Level = Correction Factor + Reading Value.

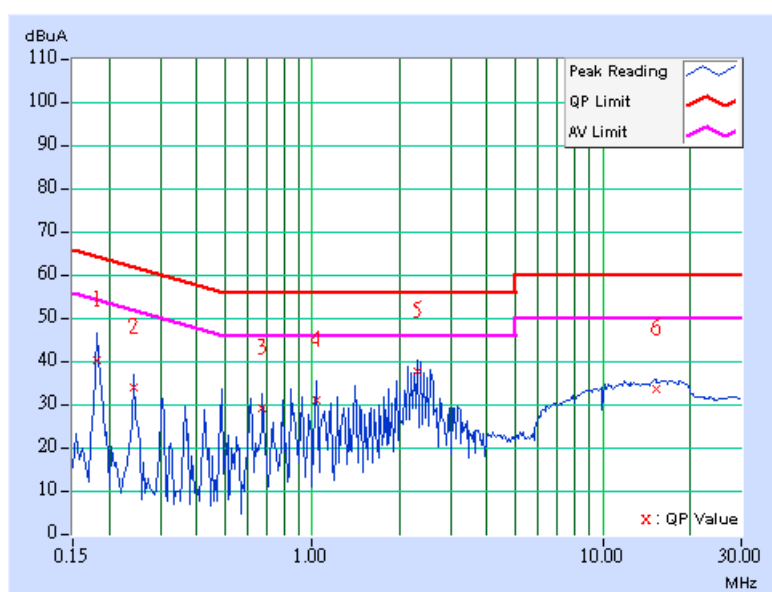

EUT TEST CONDITION		MEASUREMENT DETAIL	
CHANNEL	Channel 6	PHASE	Line 1
MODULATION TYPE	BPSK	6dB BANDWIDTH	9 kHz
ENVIRONMENTAL CONDITIONS	20deg. C, 60%RH, 991hPa	INPUT POWER (SYSTEM)	120Vac, 60 Hz
TRANSFER RATE	6Mbps	TEST MODE	C
TESTED BY	Mstch Tsui		

No	Freq. [MHz]	Corr. Factor (dB)	Reading Value [dB (uV)]		Emission Level [dB (uV)]		Limit [dB (uV)]		Margin (dB)	
			Q.P.	AV.	Q.P.	AV.	Q.P.	AV.	Q.P.	AV.
			1	0.185	0.10	37.72	-	37.82	-	64.25
2	0.240	0.10	28.85	-	28.95	-	62.10	52.10	-33.15	-
3	0.486	0.10	32.43	-	32.53	-	56.24	46.24	-23.71	-
4	1.219	0.12	27.60	-	27.72	-	56.00	46.00	-28.28	-
5	2.313	0.23	41.12	-	41.35	-	56.00	46.00	-14.65	-
6	15.143	0.63	33.77	-	34.40	-	60.00	50.00	-25.60	-

- REMARKS:**
1. Q.P. and AV. are abbreviations of quasi-peak and average individually.
  2. "-": The Quasi-peak reading value also meets average limit and measurement with the average detector is unnecessary.
  3. The emission levels of other frequencies were very low against the limit.
  4. Margin value = Emission level - Limit value
  5. Correction factor = Insertion loss + Cable loss
  6. Emission Level = Correction Factor + Reading Value.

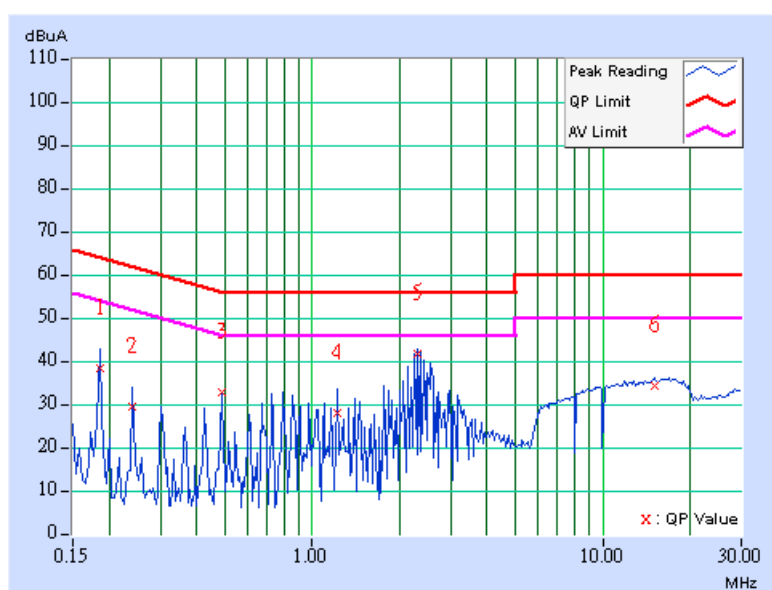

EUT TEST CONDITION		MEASUREMENT DETAIL	
CHANNEL	Channel 6	PHASE	Line 2
MODULATION TYPE	BPSK	6dB BANDWIDTH	9 kHz
ENVIRONMENTAL CONDITIONS	20deg. C, 60%RH, 991 hPa	INPUT POWER (SYSTEM)	120Vac, 60 Hz
TRANSFER RATE	6Mbps	TEST MODE	C
TESTED BY	Mstch Tsui		

No	Freq. [MHz]	Corr. Factor [dB]	Reading Value [dB (uV)]		Emission Level [dB (uV)]		Limit [dB (uV)]		Margin (dB)	
			Q.P.	AV.	Q.P.	AV.	Q.P.	AV.	Q.P.	AV.
1	0.185	0.10	38.29	-	38.39	-	64.25	54.25	-25.86	-
2	0.244	0.10	32.76	-	32.86	-	61.97	51.97	-29.11	-
3	0.607	0.13	28.39	-	28.52	-	56.00	46.00	-27.48	-
4	1.037	0.20	30.38	-	30.58	-	56.00	46.00	-25.42	-
5	2.434	0.24	36.42	-	36.66	-	56.00	46.00	-19.34	-
6	16.676	0.61	32.73	-	33.34	-	60.00	50.00	-26.66	-

- REMARKS:**
1. Q.P. and AV. are abbreviations of quasi-peak and average individually.
  2. "-": The Quasi-peak reading value also meets average limit and measurement with the average detector is unnecessary.
  3. The emission levels of other frequencies were very low against the limit.
  4. Margin value = Emission level - Limit value
  5. Correction factor = Insertion loss + Cable loss
  6. Emission Level = Correction Factor + Reading Value.

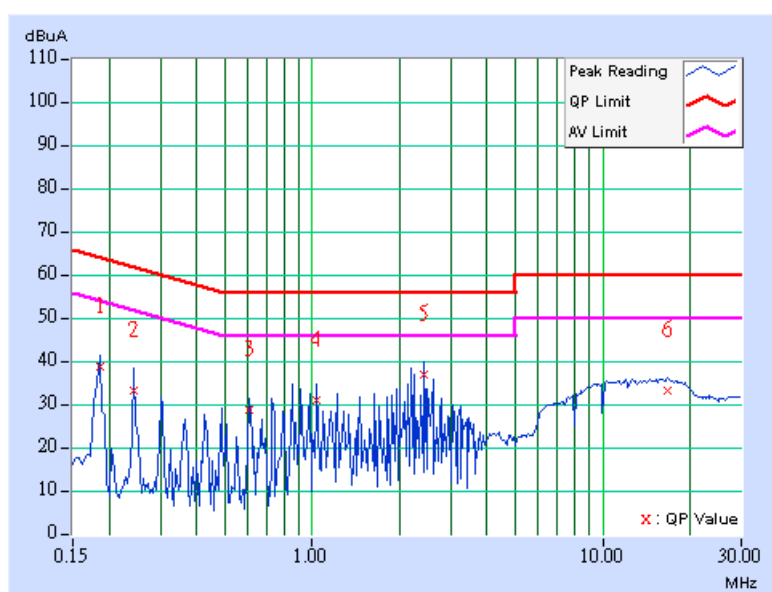



EUT TEST CONDITION		MEASUREMENT DETAIL	
CHANNEL	Channel 11	PHASE	Line 1
MODULATION TYPE	BPSK	6dB BANDWIDTH	9 kHz
ENVIRONMENTAL CONDITIONS	20deg. C, 60%RH, 991 hPa	INPUT POWER (SYSTEM)	120Vac, 60 Hz
TRANSFER RATE	6Mbps	TEST MODE	C
TESTED BY	Mstch Tsui		

No	Freq. [MHz]	Corr. Factor [dB]	Reading Value [dB (uV)]		Emission Level [dB (uV)]		Limit [dB (uV)]		Margin (dB)	
			Q.P.	AV.	Q.P.	AV.	Q.P.	AV.	Q.P.	AV.
			1	0.181	0.10	36.81	-	36.91	-	64.43
2	0.248	0.10	26.37	-	26.47	-	61.84	51.84	-35.37	-
3	0.607	0.10	34.94	-	35.04	-	56.00	46.00	-20.96	-
4	0.974	0.10	32.91	-	33.01	-	56.00	46.00	-22.99	-
5	2.250	0.22	39.88	-	40.10	-	56.00	46.00	-15.90	-
6	17.508	0.59	32.92	-	33.51	-	60.00	50.00	-26.49	-

- REMARKS:**
1. Q.P. and AV. are abbreviations of quasi-peak and average individually.
  2. "-": The Quasi-peak reading value also meets average limit and measurement with the average detector is unnecessary.
  3. The emission levels of other frequencies were very low against the limit.
  4. Margin value = Emission level - Limit value
  5. Correction factor = Insertion loss + Cable loss
  6. Emission Level = Correction Factor + Reading Value.

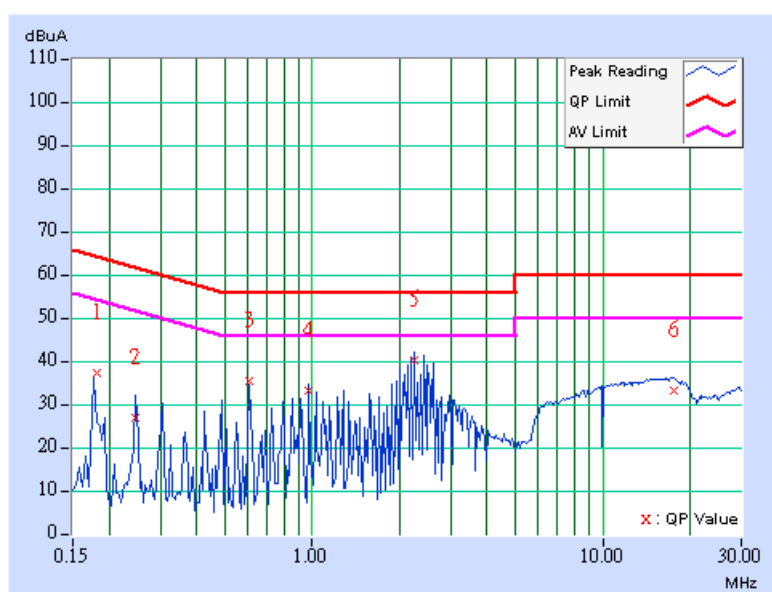

EUT TEST CONDITION		MEASUREMENT DETAIL	
CHANNEL	Channel 11	PHASE	Line 2
MODULATION TYPE	BPSK	6dB BANDWIDTH	9 kHz
ENVIRONMENTAL CONDITIONS	20deg. C, 60%RH, 991 hPa	INPUT POWER (SYSTEM)	120Vac, 60 Hz
TRANSFER RATE	6Mbps	TEST MODE	C
TESTED BY	Mstch Tsui		

No	Freq. [MHz]	Corr. Factor [dB]	Reading Value [dB (uV)]		Emission Level [dB (uV)]		Limit [dB (uV)]		Margin (dB)	
			Q.P.	AV.	Q.P.	AV.	Q.P.	AV.	Q.P.	AV.
			1	0.185	0.10	35.65	-	35.75	-	64.25
2	0.242	0.10	31.09	-	31.19	-	62.01	52.01	-30.82	-
3	0.853	0.18	30.95	-	31.13	-	56.00	46.00	-24.87	-
4	1.215	0.20	30.45	-	30.65	-	56.00	46.00	-25.35	-
5	2.250	0.22	37.45	-	37.67	-	56.00	46.00	-18.33	-
6	14.289	0.61	32.53	-	33.14	-	60.00	50.00	-26.86	-

- REMARKS:**
1. Q.P. and AV. are abbreviations of quasi-peak and average individually.
  2. "-": The Quasi-peak reading value also meets average limit and measurement with the average detector is unnecessary.
  3. The emission levels of other frequencies were very low against the limit.
  4. Margin value = Emission level - Limit value
  5. Correction factor = Insertion loss + Cable loss
  6. Emission Level = Correction Factor + Reading Value.

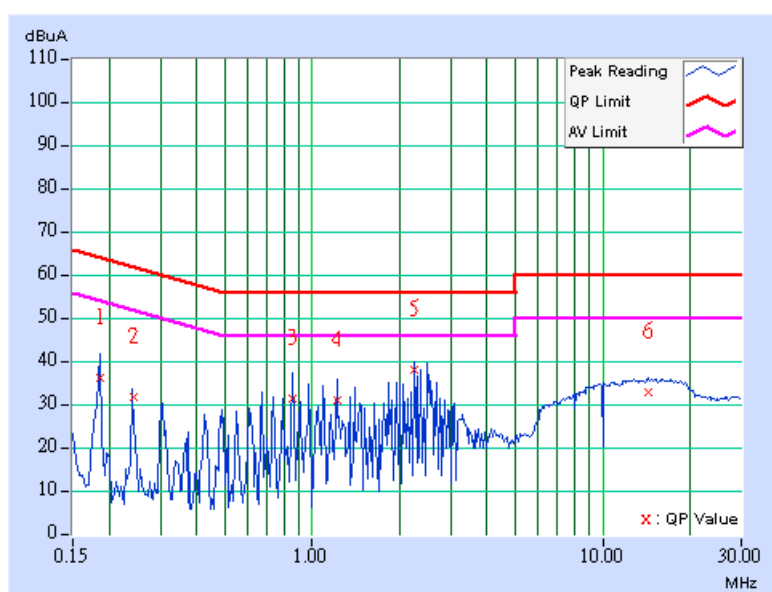

EUT TEST CONDITION		MEASUREMENT DETAIL	
CHANNEL	Channel 1	PHASE	Line 1
MODULATION TYPE	BPSK	6dB BANDWIDTH	9 kHz
ENVIRONMENTAL CONDITIONS	20deg. C, 60%RH, 991hPa	INPUT POWER (SYSTEM)	120Vac, 60 Hz
TRANSFER RATE	6Mbps	TEST MODE	D
TESTED BY	Mstch Tsui		

No	Freq. [MHz]	Corr. Factor (dB)	Reading Value [dB (uV)]		Emission Level [dB (uV)]		Limit [dB (uV)]		Margin (dB)	
			Q.P.	AV.	Q.P.	AV.	Q.P.	AV.	Q.P.	AV.
1	0.443	0.10	44.95	-	45.05	-	57.01	47.01	-11.96	-
2	0.861	0.10	42.31	-	42.41	-	56.00	46.00	-13.59	-
3	1.520	0.15	42.45	-	42.60	-	56.00	46.00	-13.40	-
4	2.395	0.23	38.78	-	39.01	-	56.00	46.00	-16.99	-
5	4.695	0.37	38.87	-	39.24	-	56.00	46.00	-16.76	-
6	8.723	0.36	40.08	-	40.44	-	60.00	50.00	-19.56	-

- REMARKS:**
1. Q.P. and AV. are abbreviations of quasi-peak and average individually.
  2. "-": The Quasi-peak reading value also meets average limit and measurement with the average detector is unnecessary.
  3. The emission levels of other frequencies were very low against the limit.
  4. Margin value = Emission level - Limit value
  5. Correction factor = Insertion loss + Cable loss
  6. Emission Level = Correction Factor + Reading Value.

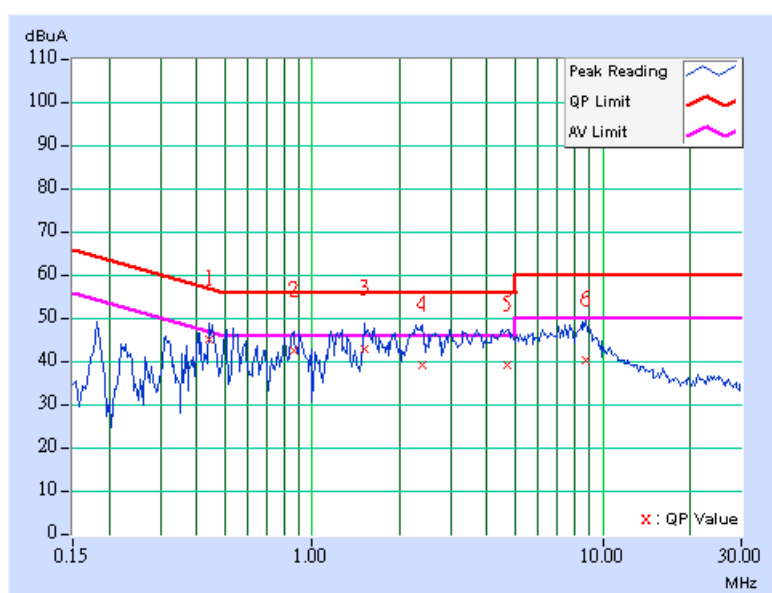

EUT TEST CONDITION		MEASUREMENT DETAIL	
CHANNEL	Channel 1	PHASE	Line 2
MODULATION TYPE	BPSK	6dB BANDWIDTH	9 kHz
ENVIRONMENTAL CONDITIONS	20deg. C, 60%RH, 991hPa	INPUT POWER (SYSTEM)	120Vac, 60 Hz
TRANSFER RATE	6Mbps	TEST MODE	D
TESTED BY	Mstch Tsui		

No	Freq. [MHz]	Corr. Factor [dB]	Reading Value [dB (uV)]		Emission Level [dB (uV)]		Limit [dB (uV)]		Margin (dB)	
			Q.P.	AV.	Q.P.	AV.	Q.P.	AV.	Q.P.	AV.
			1	0.373	0.10	40.50	-	40.60	-	58.44
2	0.861	0.18	36.62	-	36.80	-	56.00	46.00	-19.20	-
3	1.469	0.20	34.26	-	34.46	-	56.00	46.00	-21.54	-
4	2.660	0.26	34.53	-	34.79	-	56.00	46.00	-21.21	-
5	4.469	0.38	34.87	-	35.25	-	56.00	46.00	-20.75	-
6	7.457	0.42	37.20	-	37.62	-	60.00	50.00	-22.38	-

- REMARKS:**
1. Q.P. and AV. are abbreviations of quasi-peak and average individually.
  2. "-": The Quasi-peak reading value also meets average limit and measurement with the average detector is unnecessary.
  3. The emission levels of other frequencies were very low against the limit.
  4. Margin value = Emission level - Limit value
  5. Correction factor = Insertion loss + Cable loss
  6. Emission Level = Correction Factor + Reading Value.

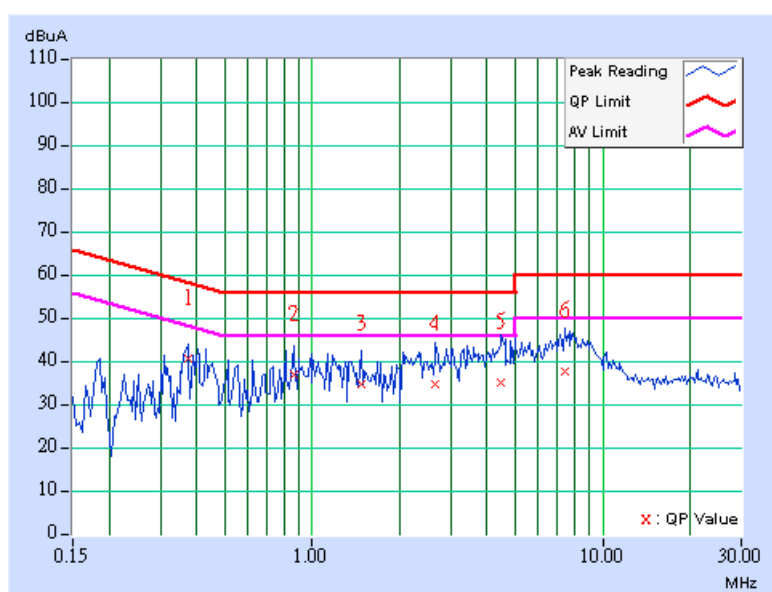

EUT TEST CONDITION		MEASUREMENT DETAIL	
CHANNEL	Channel 6	PHASE	Line 1
MODULATION TYPE	BPSK	6dB BANDWIDTH	9 kHz
ENVIRONMENTAL CONDITIONS	20deg. C, 60%RH, 991hPa	INPUT POWER (SYSTEM)	120Vac, 60 Hz
TRANSFER RATE	6Mbps	TEST MODE	D
TESTED BY	Mstch Tsui		

No	Freq. [MHz]	Corr. Factor [dB]	Reading Value [dB (uV)]		Emission Level [dB (uV)]		Limit [dB (uV)]		Margin (dB)	
			Q.P.	AV.	Q.P.	AV.	Q.P.	AV.	Q.P.	AV.
			1	0.541	0.10	44.18	-	44.28	-	56.00
2	0.845	0.10	42.26	-	42.36	-	56.00	46.00	-13.64	-
3	1.586	0.16	39.00	-	39.16	-	56.00	46.00	-16.84	-
4	2.316	0.23	40.29	-	40.52	-	56.00	46.00	-15.48	-
5	3.305	0.31	39.92	-	40.23	-	56.00	46.00	-15.77	-
6	6.660	0.37	40.93	-	41.30	-	60.00	50.00	-18.70	-

- REMARKS:**
1. Q.P. and AV. are abbreviations of quasi-peak and average individually.
  2. "-": The Quasi-peak reading value also meets average limit and measurement with the average detector is unnecessary.
  3. The emission levels of other frequencies were very low against the limit.
  4. Margin value = Emission level - Limit value
  5. Correction factor = Insertion loss + Cable loss
  6. Emission Level = Correction Factor + Reading Value.

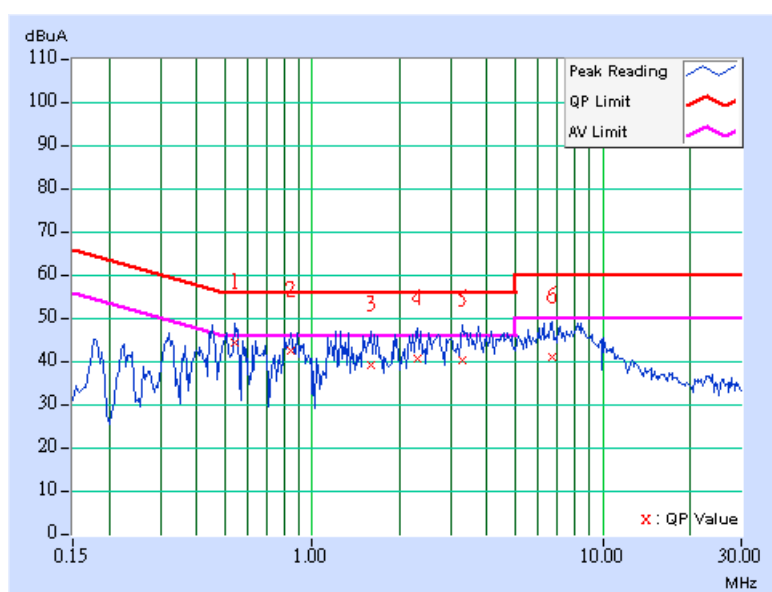

EUT TEST CONDITION		MEASUREMENT DETAIL	
CHANNEL	Channel 6	PHASE	Line 2
MODULATION TYPE	BPSK	6dB BANDWIDTH	9 kHz
ENVIRONMENTAL CONDITIONS	20deg. C, 60%RH, 991hPa	INPUT POWER (SYSTEM)	120Vac, 60 Hz
TRANSFER RATE	6Mbps	TEST MODE	D
TESTED BY	Mstch Tsui		

No	Freq. [MHz]	Corr. Factor (dB)	Reading Value [dB (uV)]		Emission Level [dB (uV)]		Limit [dB (uV)]		Margin (dB)	
			Q.P.	AV.	Q.P.	AV.	Q.P.	AV.	Q.P.	AV.
1	0.448	0.11	41.24	-	41.35	-	56.91	46.91	-15.56	-
2	0.767	0.16	34.57	-	34.73	-	56.00	46.00	-21.27	-
3	1.219	0.20	37.12	-	37.32	-	56.00	46.00	-18.68	-
4	2.598	0.25	35.62	-	35.87	-	56.00	46.00	-20.13	-
5	6.297	0.40	36.38	-	36.78	-	60.00	50.00	-23.22	-
6	8.608	0.44	37.36	-	37.80	-	60.00	50.00	-22.20	-

- REMARKS:**
1. Q.P. and AV. are abbreviations of quasi-peak and average individually.
  2. "-": The Quasi-peak reading value also meets average limit and measurement with the average detector is unnecessary.
  3. The emission levels of other frequencies were very low against the limit.
  4. Margin value = Emission level - Limit value
  5. Correction factor = Insertion loss + Cable loss
  6. Emission Level = Correction Factor + Reading Value.

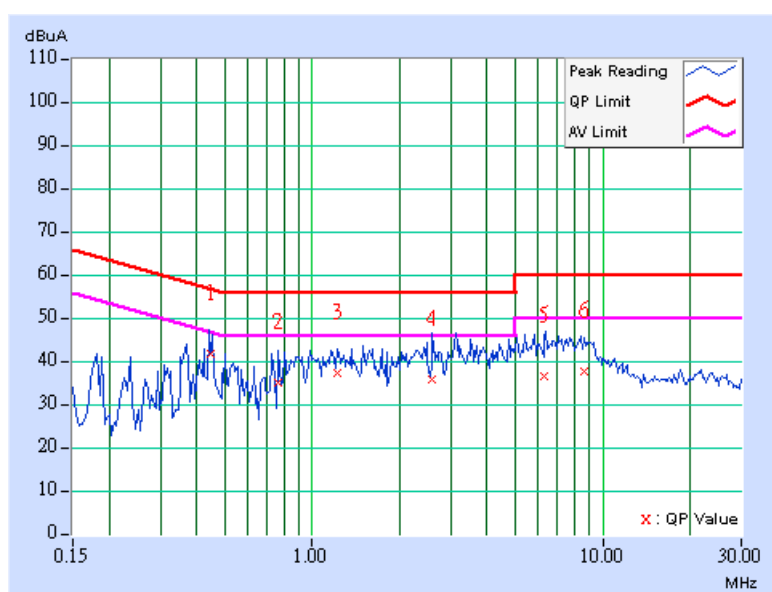

EUT TEST CONDITION		MEASUREMENT DETAIL	
CHANNEL	Channel 11	PHASE	Line 1
MODULATION TYPE	BPSK	6dB BANDWIDTH	9 kHz
ENVIRONMENTAL CONDITIONS	20deg. C, 60%RH, 991hPa	INPUT POWER (SYSTEM)	120Vac, 60 Hz
TRANSFER RATE	6Mbps	TEST MODE	D
TESTED BY	Mstch Tsui		

No	Freq. [MHz]	Corr. Factor (dB)	Reading Value [dB (uV)]		Emission Level [dB (uV)]		Limit [dB (uV)]		Margin (dB)	
			Q.P.	AV.	Q.P.	AV.	Q.P.	AV.	Q.P.	AV.
			1	0.455	0.10	42.61	-	42.71	-	56.79
2	0.849	0.10	41.83	-	41.93	-	56.00	46.00	-14.07	-
3	1.328	0.13	39.83	-	39.96	-	56.00	46.00	-16.04	-
4	2.316	0.23	40.43	-	40.66	-	56.00	46.00	-15.34	-
5	3.746	0.35	39.63	-	39.98	-	56.00	46.00	-16.02	-
6	8.406	0.36	40.48	-	40.84	-	60.00	50.00	-19.16	-

- REMARKS:**
1. Q.P. and AV. are abbreviations of quasi-peak and average individually.
  2. "-": The Quasi-peak reading value also meets average limit and measurement with the average detector is unnecessary.
  3. The emission levels of other frequencies were very low against the limit.
  4. Margin value = Emission level - Limit value
  5. Correction factor = Insertion loss + Cable loss
  6. Emission Level = Correction Factor + Reading Value.

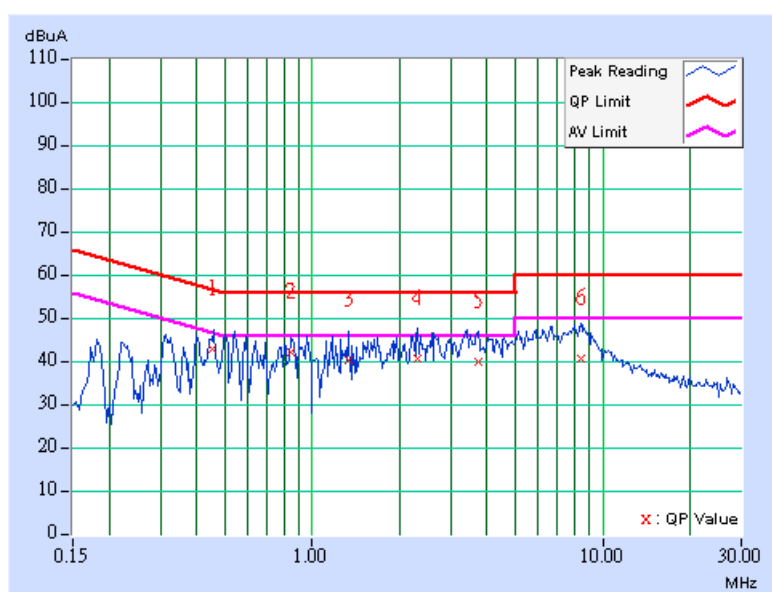

EUT TEST CONDITION		MEASUREMENT DETAIL	
CHANNEL	Channel 11	PHASE	Line 2
MODULATION TYPE	BPSK	6dB BANDWIDTH	9 kHz
ENVIRONMENTAL CONDITIONS	20deg. C, 60%RH, 991hPa	INPUT POWER (SYSTEM)	120Vac, 60 Hz
TRANSFER RATE	6Mbps	TEST MODE	D
TESTED BY	Mstch Tsui		

No	Freq. [MHz]	Corr. Factor (dB)	Reading Value [dB (uV)]		Emission Level [dB (uV)]		Limit [dB (uV)]		Margin (dB)	
			Q.P.	AV.	Q.P.	AV.	Q.P.	AV.	Q.P.	AV.
			1	0.447	0.11	40.86	-	40.97	-	56.93
2	0.541	0.12	38.86	-	38.98	-	56.00	46.00	-17.02	-
3	0.877	0.18	33.74	-	33.92	-	56.00	46.00	-22.08	-
4	2.270	0.22	36.82	-	37.04	-	56.00	46.00	-18.96	-
5	4.523	0.38	34.81	-	35.19	-	56.00	46.00	-20.81	-
6	7.617	0.42	37.13	-	37.55	-	60.00	50.00	-22.45	-

- REMARKS:**
1. Q.P. and AV. are abbreviations of quasi-peak and average individually.
  2. "-": The Quasi-peak reading value also meets average limit and measurement with the average detector is unnecessary.
  3. The emission levels of other frequencies were very low against the limit.
  4. Margin value = Emission level - Limit value
  5. Correction factor = Insertion loss + Cable loss
  6. Emission Level = Correction Factor + Reading Value.

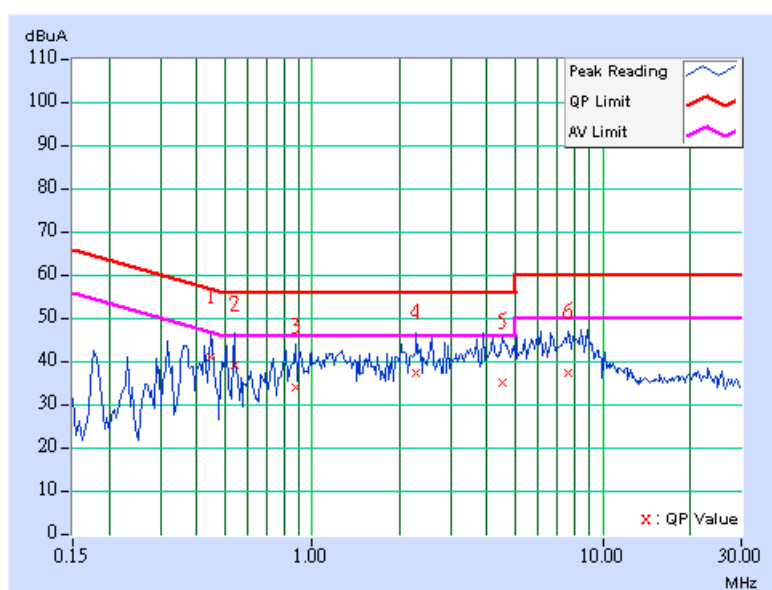



EUT TEST CONDITION		MEASUREMENT DETAIL	
CHANNEL	Channel 1	PHASE	Line 1
MODULATION TYPE	BPSK	6dB BANDWIDTH	9 kHz
ENVIRONMENTAL CONDITIONS	20deg. C, 60%RH, 991hPa	INPUT POWER (SYSTEM)	120Vac, 60 Hz
TRANSFER RATE	6Mbps	TEST MODE	E
TESTED BY	Mstch Tsui		

No	Freq. [MHz]	Corr. Factor [dB]	Reading Value [dB (uV)]		Emission Level [dB (uV)]		Limit [dB (uV)]		Margin (dB)	
			Q.P.	AV.	Q.P.	AV.	Q.P.	AV.	Q.P.	AV.
1	0.154	0.10	43.84	-	43.94	-	65.79	55.79	-21.85	-
2	0.216	0.10	44.87	-	44.97	-	62.96	52.96	-17.99	-
3	0.330	0.10	32.79	-	32.89	-	59.46	49.46	-26.57	-
4	1.832	0.18	22.59	-	22.77	-	56.00	46.00	-33.23	-
5	3.781	0.35	22.07	-	22.42	-	56.00	46.00	-33.58	-
6	8.711	0.36	21.56	-	21.92	-	60.00	50.00	-38.08	-

- REMARKS:**
1. Q.P. and AV. are abbreviations of quasi-peak and average individually.
  2. "-": The Quasi-peak reading value also meets average limit and measurement with the average detector is unnecessary.
  3. The emission levels of other frequencies were very low against the limit.
  4. Margin value = Emission level - Limit value
  5. Correction factor = Insertion loss + Cable loss
  6. Emission Level = Correction Factor + Reading Value.

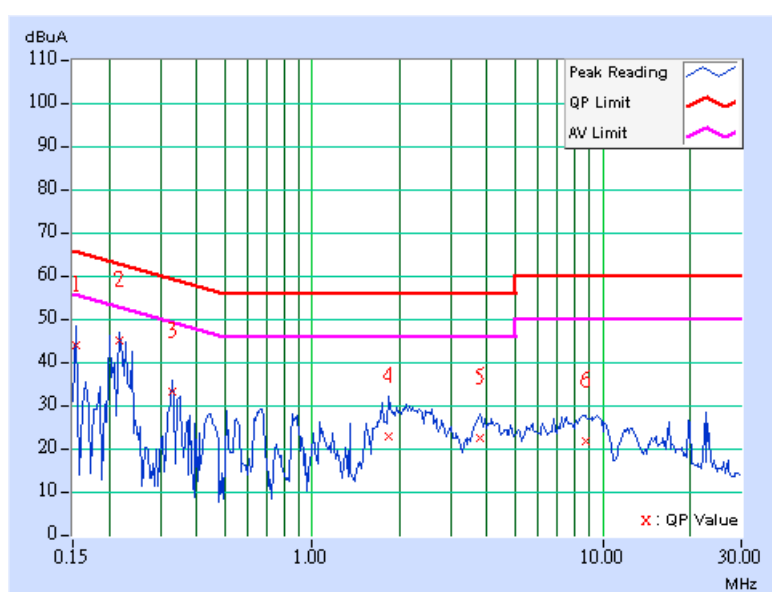

EUT TEST CONDITION		MEASUREMENT DETAIL	
CHANNEL	Channel 1	PHASE	Line 2
MODULATION TYPE	BPSK	6dB BANDWIDTH	9 kHz
ENVIRONMENTAL CONDITIONS	20deg. C, 60%RH, 991hPa	INPUT POWER (SYSTEM)	120Vac, 60 Hz
TRANSFER RATE	6Mbps	TEST MODE	E
TESTED BY	Mstch Tsui		

No	Freq. [MHz]	Corr. Factor [dB]	Reading Value [dB (uV)]		Emission Level [dB (uV)]		Limit [dB (uV)]		Margin (dB)	
			Q.P.	AV.	Q.P.	AV.	Q.P.	AV.	Q.P.	AV.
			1	0.166	0.10	34.87	-	34.97	-	65.18
2	0.216	0.10	45.88	-	45.98	-	62.96	52.96	-16.98	-
3	0.322	0.10	33.98	-	34.08	-	59.66	49.66	-25.58	-
4	0.955	0.19	26.41	-	26.60	-	56.00	46.00	-29.40	-
5	1.813	0.20	22.29	-	22.49	-	56.00	46.00	-33.51	-
6	11.582	0.51	21.44	-	21.95	-	60.00	50.00	-38.05	-

- REMARKS:**
1. Q.P. and AV. are abbreviations of quasi-peak and average individually.
  2. "-": The Quasi-peak reading value also meets average limit and measurement with the average detector is unnecessary.
  3. The emission levels of other frequencies were very low against the limit.
  4. Margin value = Emission level - Limit value
  5. Correction factor = Insertion loss + Cable loss
  6. Emission Level = Correction Factor + Reading Value.

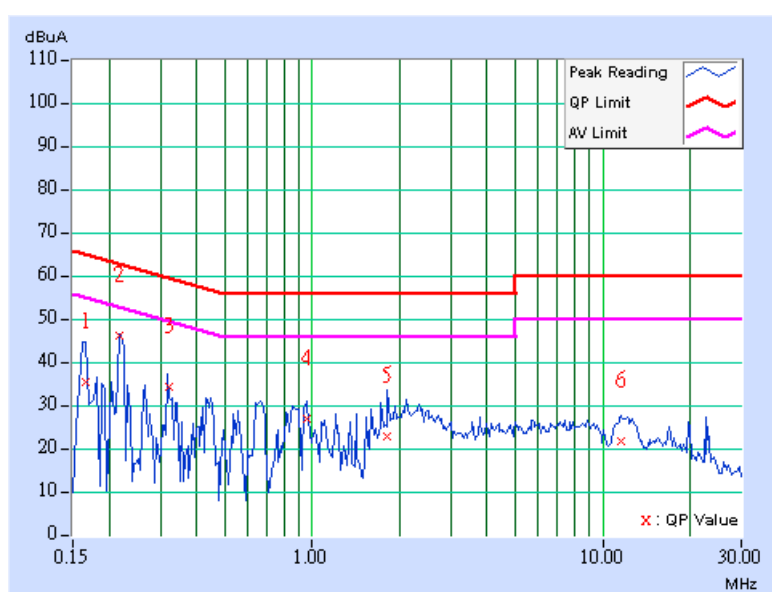

EUT TEST CONDITION		MEASUREMENT DETAIL	
CHANNEL	Channel 6	PHASE	Line 1
MODULATION TYPE	BPSK	6dB BANDWIDTH	9 kHz
ENVIRONMENTAL CONDITIONS	20deg. C, 60%RH, 991hPa	INPUT POWER (SYSTEM)	120Vac, 60 Hz
TRANSFER RATE	6Mbps	TEST MODE	E
TESTED BY	Mstch Tsui		

No	Freq. [MHz]	Corr. Factor (dB)	Reading Value [dB (uV)]		Emission Level [dB (uV)]		Limit [dB (uV)]		Margin (dB)	
			Q.P.	AV.	Q.P.	AV.	Q.P.	AV.	Q.P.	AV.
			1	0.166	0.10	35.00	-	35.10	-	65.18
2	0.220	0.10	44.42	-	44.52	-	62.81	52.81	-18.29	-
3	0.322	0.10	33.28	-	33.38	-	59.66	49.66	-26.28	-
4	0.677	0.10	27.49	-	27.59	-	56.00	46.00	-28.41	-
5	1.883	0.19	24.76	-	24.95	-	56.00	46.00	-31.05	-
6	9.785	0.36	22.01	-	22.37	-	60.00	50.00	-37.63	-

- REMARKS:**
1. Q.P. and AV. are abbreviations of quasi-peak and average individually.
  2. "-": The Quasi-peak reading value also meets average limit and measurement with the average detector is unnecessary.
  3. The emission levels of other frequencies were very low against the limit.
  4. Margin value = Emission level - Limit value
  5. Correction factor = Insertion loss + Cable loss
  6. Emission Level = Correction Factor + Reading Value.

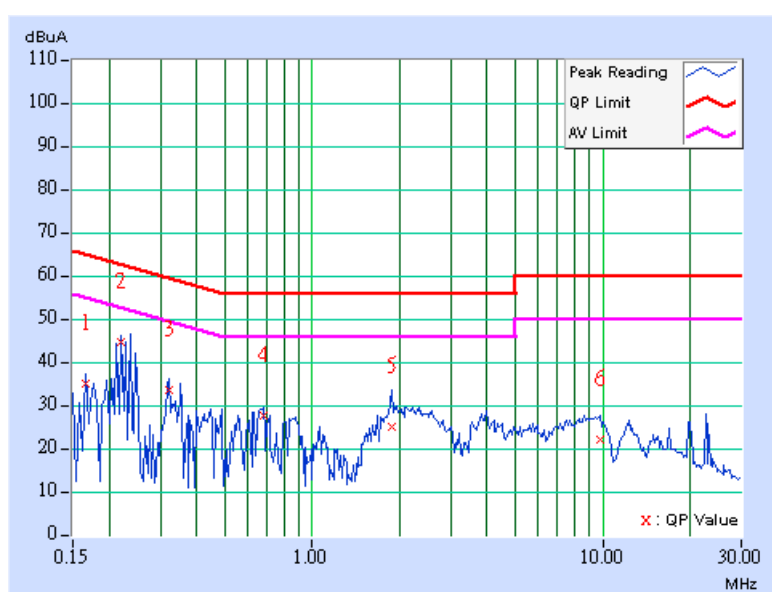

EUT TEST CONDITION		MEASUREMENT DETAIL	
CHANNEL	Channel 6	PHASE	Line 2
MODULATION TYPE	BPSK	6dB BANDWIDTH	9 kHz
ENVIRONMENTAL CONDITIONS	20deg. C, 60%RH, 991 hPa	INPUT POWER (SYSTEM)	120Vac, 60 Hz
TRANSFER RATE	6Mbps	TEST MODE	E
TESTED BY	Mstch Tsui		

No	Freq. [MHz]	Corr. Factor [dB]	Reading Value [dB (uV)]		Emission Level [dB (uV)]		Limit [dB (uV)]		Margin (dB)	
			Q.P.	AV.	Q.P.	AV.	Q.P.	AV.	Q.P.	AV.
			1	0.162	0.10	37.41	-	37.51	-	65.38
2	0.216	0.10	44.95	-	45.05	-	62.96	52.96	-17.91	-
3	0.447	0.11	29.25	-	29.36	-	56.93	46.93	-27.58	-
4	0.873	0.18	27.39	-	27.57	-	56.00	46.00	-28.43	-
5	2.148	0.21	25.03	-	25.24	-	56.00	46.00	-30.76	-
6	12.211	0.54	21.43	-	21.97	-	60.00	50.00	-38.03	-

- REMARKS:**
1. Q.P. and AV. are abbreviations of quasi-peak and average individually.
  2. "-": The Quasi-peak reading value also meets average limit and measurement with the average detector is unnecessary.
  3. The emission levels of other frequencies were very low against the limit.
  4. Margin value = Emission level - Limit value
  5. Correction factor = Insertion loss + Cable loss
  6. Emission Level = Correction Factor + Reading Value.

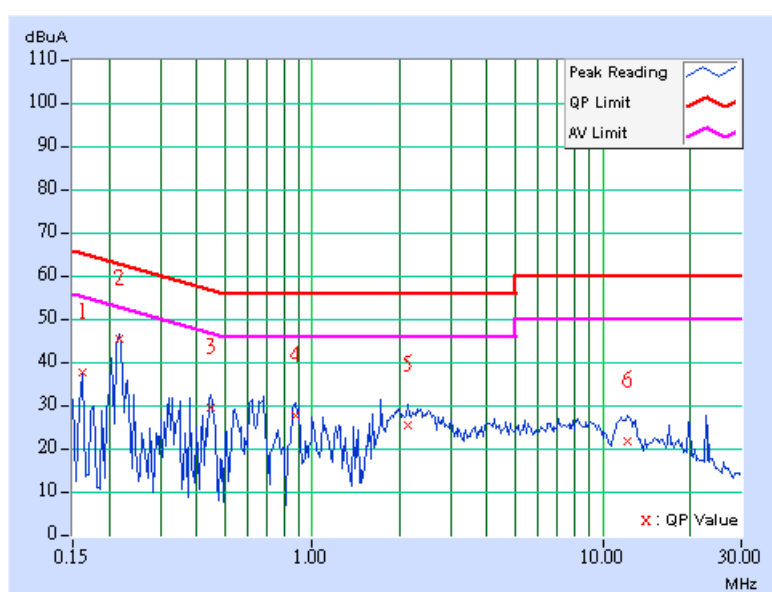

EUT TEST CONDITION		MEASUREMENT DETAIL	
CHANNEL	Channel 11	PHASE	Line 1
MODULATION TYPE	BPSK	6dB BANDWIDTH	9 kHz
ENVIRONMENTAL CONDITIONS	20deg. C, 60%RH, 991hPa	INPUT POWER (SYSTEM)	120Vac, 60 Hz
TRANSFER RATE	6Mbps	TEST MODE	E
TESTED BY	Mstch Tsui		

No	Freq. [MHz]	Corr. Factor [dB]	Reading Value [dB (uV)]		Emission Level [dB (uV)]		Limit [dB (uV)]		Margin (dB)	
			Q.P.	AV.	Q.P.	AV.	Q.P.	AV.	Q.P.	AV.
1	0.170	0.10	34.45	-	34.55	-	64.98	54.98	-30.43	-
2	0.216	0.10	45.70	-	45.80	-	62.96	52.96	-17.16	-
3	0.334	0.10	31.84	-	31.94	-	59.36	49.36	-27.42	-
4	0.951	0.10	25.14	-	25.24	-	56.00	46.00	-30.76	-
5	1.863	0.19	24.39	-	24.58	-	56.00	46.00	-31.42	-
6	10.047	0.36	21.37	-	21.73	-	60.00	50.00	-38.27	-

- REMARKS:**
1. Q.P. and AV. are abbreviations of quasi-peak and average individually.
  2. "-": The Quasi-peak reading value also meets average limit and measurement with the average detector is unnecessary.
  3. The emission levels of other frequencies were very low against the limit.
  4. Margin value = Emission level - Limit value
  5. Correction factor = Insertion loss + Cable loss
  6. Emission Level = Correction Factor + Reading Value.

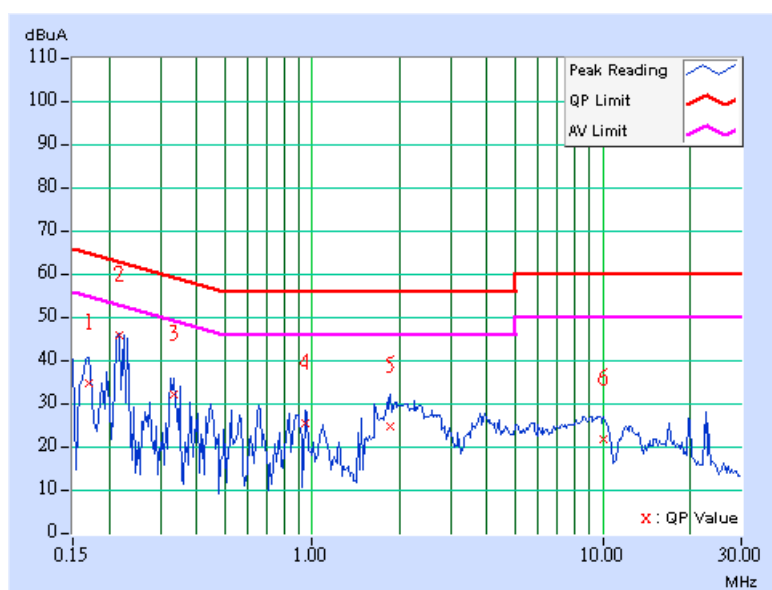

EUT TEST CONDITION		MEASUREMENT DETAIL	
CHANNEL	Channel 11	PHASE	Line 2
MODULATION TYPE	BPSK	6dB BANDWIDTH	9 kHz
ENVIRONMENTAL CONDITIONS	20deg. C, 60%RH, 991hPa	INPUT POWER (SYSTEM)	120Vac, 60 Hz
TRANSFER RATE	6Mbps	TEST MODE	E
TESTED BY	Mstch Tsui		

No	Freq. [MHz]	Corr. Factor [dB]	Reading Value [dB (uV)]		Emission Level [dB (uV)]		Limit [dB (uV)]		Margin (dB)	
			Q.P.	AV.	Q.P.	AV.	Q.P.	AV.	Q.P.	AV.
1	0.154	0.10	44.15	-	44.25	-	65.79	55.79	-21.54	-
2	0.216	0.10	45.24	-	45.34	-	62.96	52.96	-17.62	-
3	0.334	0.10	33.17	-	33.27	-	59.36	49.36	-26.09	-
4	0.681	0.15	28.07	-	28.22	-	56.00	46.00	-27.78	-
5	1.859	0.20	23.84	-	24.04	-	56.00	46.00	-31.96	-
6	11.629	0.52	21.66	-	22.18	-	60.00	50.00	-37.82	-

- REMARKS:**
1. Q.P. and AV. are abbreviations of quasi-peak and average individually.
  2. "-": The Quasi-peak reading value also meets average limit and measurement with the average detector is unnecessary.
  3. The emission levels of other frequencies were very low against the limit.
  4. Margin value = Emission level - Limit value
  5. Correction factor = Insertion loss + Cable loss
  6. Emission Level = Correction Factor + Reading Value.

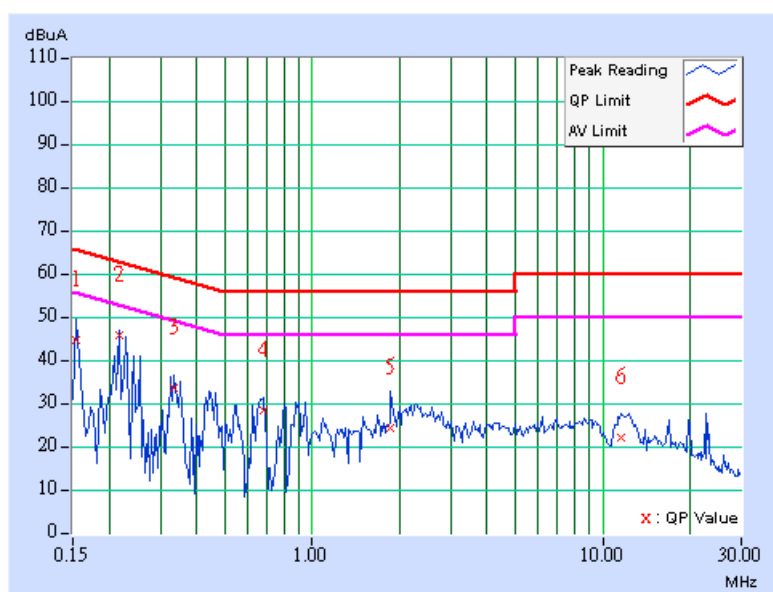

EUT TEST CONDITION		MEASUREMENT DETAIL	
CHANNEL	Channel 1	PHASE	Line 1
MODULATION TYPE	BPSK	6dB BANDWIDTH	9 kHz
ENVIRONMENTAL CONDITIONS	20deg. C, 60%RH, 991hPa	INPUT POWER (SYSTEM)	120Vac, 60 Hz
TRANSFER RATE	6Mbps	TEST MODE	F
TESTED BY	Mstch Tsui		

No	Freq. [MHz]	Corr. Factor [dB]	Reading Value [dB (uV)]		Emission Level [dB (uV)]		Limit [dB (uV)]		Margin (dB)	
			Q.P.	AV.	Q.P.	AV.	Q.P.	AV.	Q.P.	AV.
1	0.180	0.10	33.46	-	33.56	-	64.49	54.49	-30.93	-
2	0.365	0.10	34.38	-	34.48	-	58.62	48.62	-24.14	-
3	0.607	0.10	30.14	-	30.24	-	56.00	46.00	-25.76	-
4	1.637	0.16	28.39	-	28.55	-	56.00	46.00	-27.45	-
5	3.156	0.30	28.98	-	29.28	-	56.00	46.00	-26.72	-
6	9.164	0.36	34.57	-	34.93	-	60.00	50.00	-25.07	-

- REMARKS:**
1. Q.P. and AV. are abbreviations of quasi-peak and average individually.
  2. "-": The Quasi-peak reading value also meets average limit and measurement with the average detector is unnecessary.
  3. The emission levels of other frequencies were very low against the limit.
  4. Margin value = Emission level - Limit value
  5. Correction factor = Insertion loss + Cable loss
  6. Emission Level = Correction Factor + Reading Value.

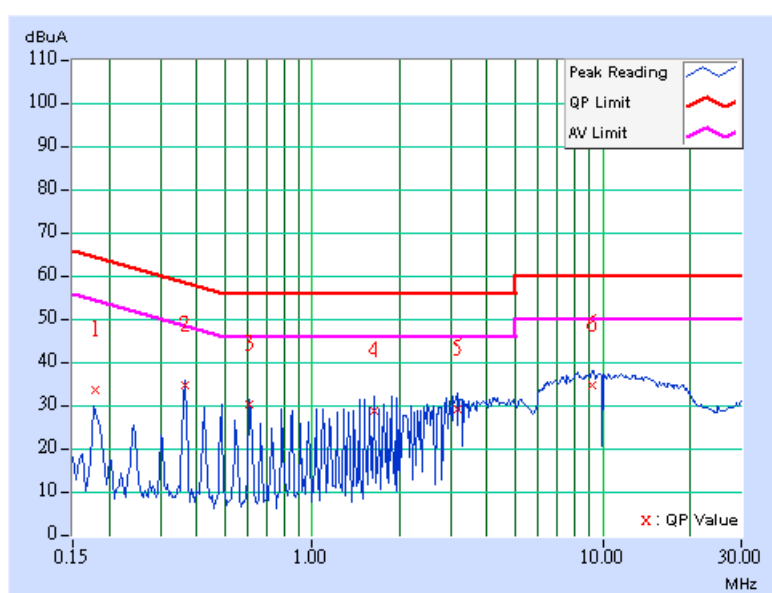

EUT TEST CONDITION		MEASUREMENT DETAIL	
CHANNEL	Channel 1	PHASE	Line 2
MODULATION TYPE	BPSK	6dB BANDWIDTH	9 kHz
ENVIRONMENTAL CONDITIONS	20deg. C, 60%RH, 991hPa	INPUT POWER (SYSTEM)	120Vac, 60 Hz
TRANSFER RATE	6Mbps	TEST MODE	F
TESTED BY	Mstch Tsui		

No	Freq. [MHz]	Corr. Factor (dB)	Reading Value [dB (uV)]		Emission Level [dB (uV)]		Limit [dB (uV)]		Margin (dB)	
			Q.P.	AV.	Q.P.	AV.	Q.P.	AV.	Q.P.	AV.
1	0.181	0.10	33.55	-	33.65	-	64.43	54.43	-30.78	-
2	0.365	0.10	34.95	-	35.05	-	58.62	48.62	-23.57	-
3	0.486	0.11	30.52	-	30.63	-	56.24	46.24	-25.60	-
4	1.336	0.20	28.45	-	28.65	-	56.00	46.00	-27.35	-
5	2.426	0.24	32.75	-	32.99	-	56.00	46.00	-23.01	-
6	9.102	0.45	35.25	-	35.70	-	60.00	50.00	-24.30	-

- REMARKS:**
1. Q.P. and AV. are abbreviations of quasi-peak and average individually.
  2. "-": The Quasi-peak reading value also meets average limit and measurement with the average detector is unnecessary.
  3. The emission levels of other frequencies were very low against the limit.
  4. Margin value = Emission level - Limit value
  5. Correction factor = Insertion loss + Cable loss
  6. Emission Level = Correction Factor + Reading Value.

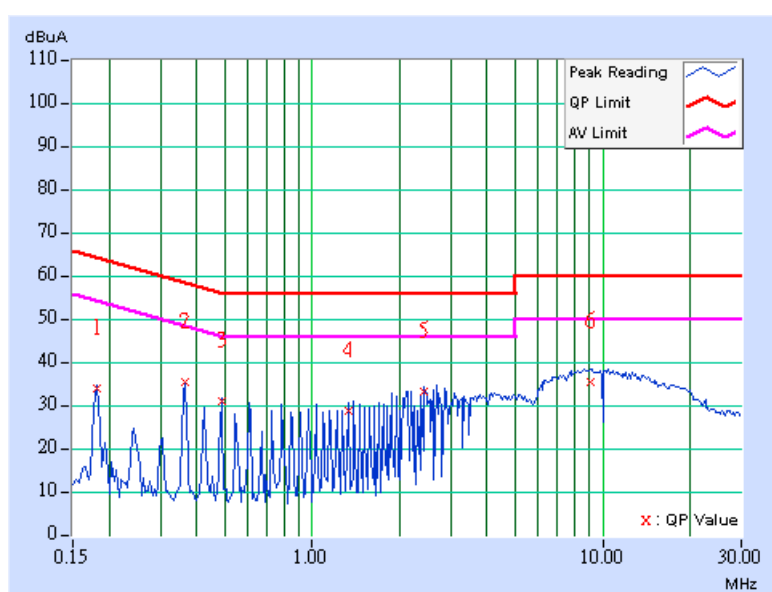



EUT TEST CONDITION		MEASUREMENT DETAIL	
CHANNEL	Channel 6	PHASE	Line 1
MODULATION TYPE	BPSK	6dB BANDWIDTH	9 kHz
ENVIRONMENTAL CONDITIONS	20deg. C, 60%RH, 991hPa	INPUT POWER (SYSTEM)	120Vac, 60 Hz
TRANSFER RATE	6Mbps	TEST MODE	F
TESTED BY	Mstch Tsui		

No	Freq. [MHz]	Corr. Factor (dB)	Reading Value [dB (uV)]		Emission Level [dB (uV)]		Limit [dB (uV)]		Margin (dB)	
			Q.P.	AV.	Q.P.	AV.	Q.P.	AV.	Q.P.	AV.
			1	0.181	0.10	34.88	-	34.98	-	64.43
2	0.365	0.10	34.44	-	34.54	-	58.62	48.62	-24.08	-
3	0.486	0.10	29.76	-	29.86	-	56.24	46.24	-26.38	-
4	1.824	0.18	27.77	-	27.95	-	56.00	46.00	-28.05	-
5	4.250	0.37	29.71	-	30.08	-	56.00	46.00	-25.92	-
6	8.805	0.36	34.96	-	35.32	-	60.00	50.00	-24.68	-

- REMARKS:**
1. Q.P. and AV. are abbreviations of quasi-peak and average individually.
  2. "-": The Quasi-peak reading value also meets average limit and measurement with the average detector is unnecessary.
  3. The emission levels of other frequencies were very low against the limit.
  4. Margin value = Emission level - Limit value
  5. Correction factor = Insertion loss + Cable loss
  6. Emission Level = Correction Factor + Reading Value.

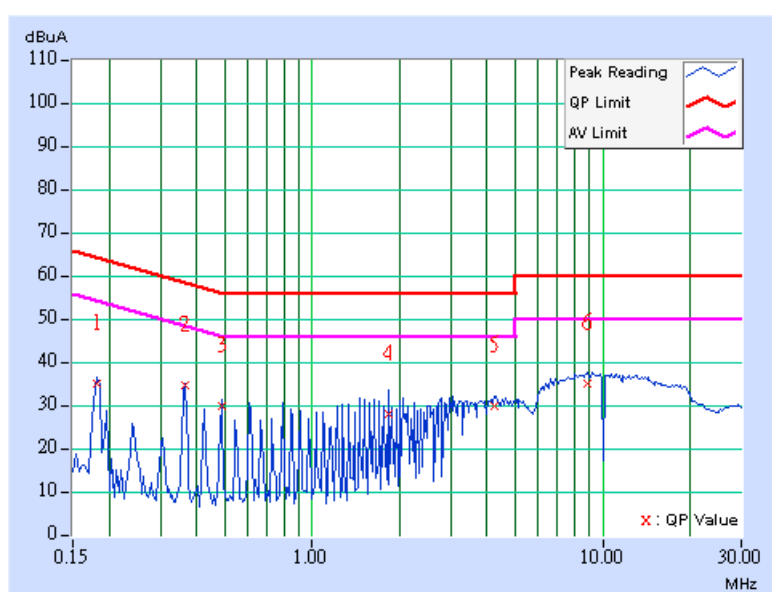

EUT TEST CONDITION		MEASUREMENT DETAIL	
CHANNEL	Channel 6	PHASE	Line 2
MODULATION TYPE	BPSK	6dB BANDWIDTH	9 kHz
ENVIRONMENTAL CONDITIONS	20deg. C, 60%RH, 991hPa	INPUT POWER (SYSTEM)	120Vac, 60 Hz
TRANSFER RATE	6Mbps	TEST MODE	F
TESTED BY	Mstch Tsui		

No	Freq. [MHz]	Corr. Factor [dB]	Reading Value [dB (uV)]		Emission Level [dB (uV)]		Limit [dB (uV)]		Margin (dB)	
			Q.P.	AV.	Q.P.	AV.	Q.P.	AV.	Q.P.	AV.
			1	0.181	0.10	34.15	-	34.25	-	64.43
2	0.365	0.10	34.97	-	35.07	-	58.62	48.62	-23.55	-
3	0.486	0.11	30.62	-	30.73	-	56.24	46.24	-25.50	-
4	1.820	0.20	28.04	-	28.24	-	56.00	46.00	-27.76	-
5	2.430	0.24	32.97	-	33.21	-	56.00	46.00	-22.79	-
6	9.352	0.45	35.80	-	36.25	-	60.00	50.00	-23.75	-

- REMARKS:**
1. Q.P. and AV. are abbreviations of quasi-peak and average individually.
  2. "-": The Quasi-peak reading value also meets average limit and measurement with the average detector is unnecessary.
  3. The emission levels of other frequencies were very low against the limit.
  4. Margin value = Emission level - Limit value
  5. Correction factor = Insertion loss + Cable loss
  6. Emission Level = Correction Factor + Reading Value.

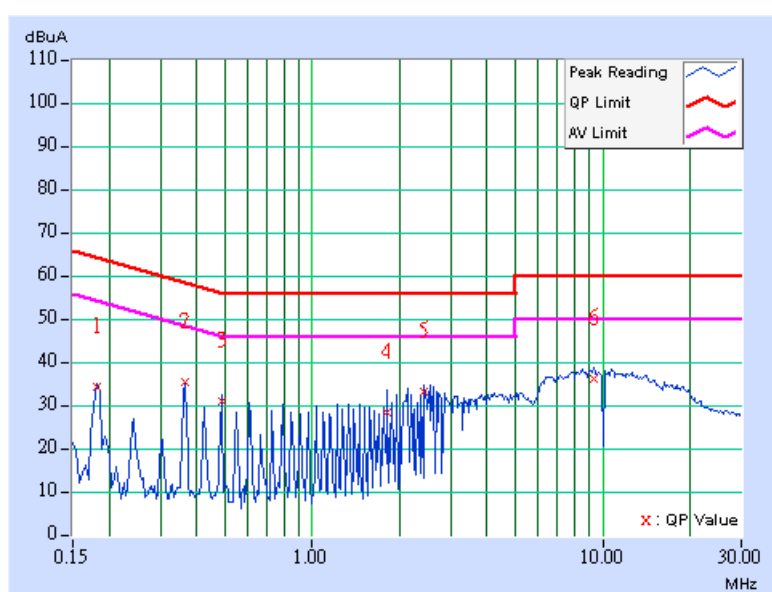

EUT TEST CONDITION		MEASUREMENT DETAIL	
CHANNEL	Channel 11	PHASE	Line 1
MODULATION TYPE	BPSK	6dB BANDWIDTH	9 kHz
ENVIRONMENTAL CONDITIONS	20deg. C, 60%RH, 991hPa	INPUT POWER (SYSTEM)	120Vac, 60 Hz
TRANSFER RATE	6Mbps	TEST MODE	F
TESTED BY	Mstch Tsui		

No	Freq. [MHz]	Corr. Factor [dB]	Reading Value [dB (uV)]		Emission Level [dB (uV)]		Limit [dB (uV)]		Margin (dB)	
			Q.P.	AV.	Q.P.	AV.	Q.P.	AV.	Q.P.	AV.
			1	0.181	0.10	35.20	-	35.30	-	64.43
2	0.365	0.10	34.50	-	34.60	-	58.62	48.62	-24.02	-
3	0.607	0.10	30.14	-	30.24	-	56.00	46.00	-25.76	-
4	1.457	0.15	30.42	-	30.57	-	56.00	46.00	-25.43	-
5	2.793	0.27	30.60	-	30.87	-	56.00	46.00	-25.13	-
6	9.293	0.36	35.15	-	35.51	-	60.00	50.00	-24.49	-

- REMARKS:**
1. Q.P. and AV. are abbreviations of quasi-peak and average individually.
  2. "-": The Quasi-peak reading value also meets average limit and measurement with the average detector is unnecessary.
  3. The emission levels of other frequencies were very low against the limit.
  4. Margin value = Emission level - Limit value
  5. Correction factor = Insertion loss + Cable loss
  6. Emission Level = Correction Factor + Reading Value.

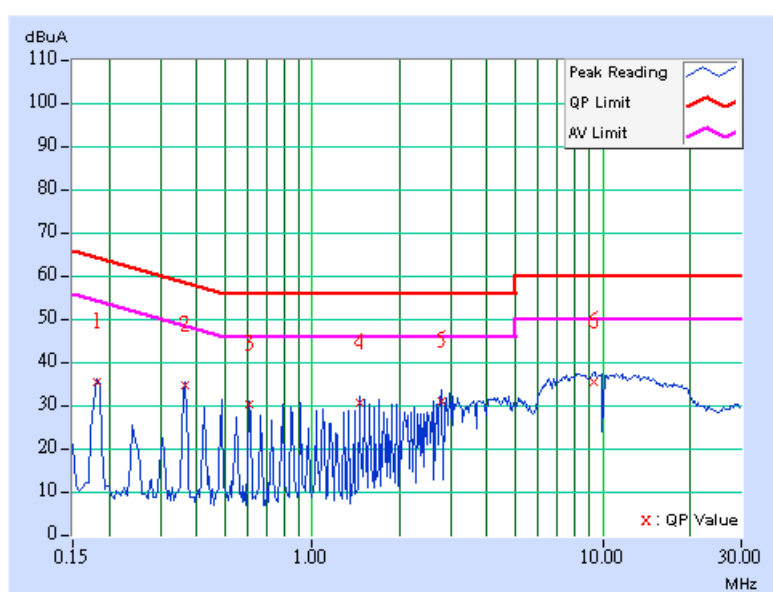

EUT TEST CONDITION		MEASUREMENT DETAIL	
CHANNEL	Channel 11	PHASE	Line 2
MODULATION TYPE	BPSK	6dB BANDWIDTH	9 kHz
ENVIRONMENTAL CONDITIONS	20deg. C, 60%RH, 991 hPa	INPUT POWER (SYSTEM)	120Vac, 60 Hz
TRANSFER RATE	6Mbps	TEST MODE	F
TESTED BY	Mstch Tsui		

No	Freq. [MHz]	Corr. Factor [dB]	Reading Value [dB (uV)]		Emission Level [dB (uV)]		Limit [dB (uV)]		Margin (dB)	
			Q.P.	AV.	Q.P.	AV.	Q.P.	AV.	Q.P.	AV.
1	0.185	0.10	32.90	-	33.00	-	64.25	54.25	-31.25	-
2	0.365	0.10	35.05	-	35.15	-	58.62	48.62	-23.47	-
3	0.482	0.11	27.22	-	27.33	-	56.30	46.30	-28.97	-
4	1.883	0.20	31.35	-	31.55	-	56.00	46.00	-24.45	-
5	2.609	0.25	32.46	-	32.71	-	56.00	46.00	-23.29	-
6	9.047	0.45	34.84	-	35.29	-	60.00	50.00	-24.71	-

- REMARKS:**
1. Q.P. and AV. are abbreviations of quasi-peak and average individually.
  2. "-": The Quasi-peak reading value also meets average limit and measurement with the average detector is unnecessary.
  3. The emission levels of other frequencies were very low against the limit.
  4. Margin value = Emission level - Limit value
  5. Correction factor = Insertion loss + Cable loss
  6. Emission Level = Correction Factor + Reading Value.

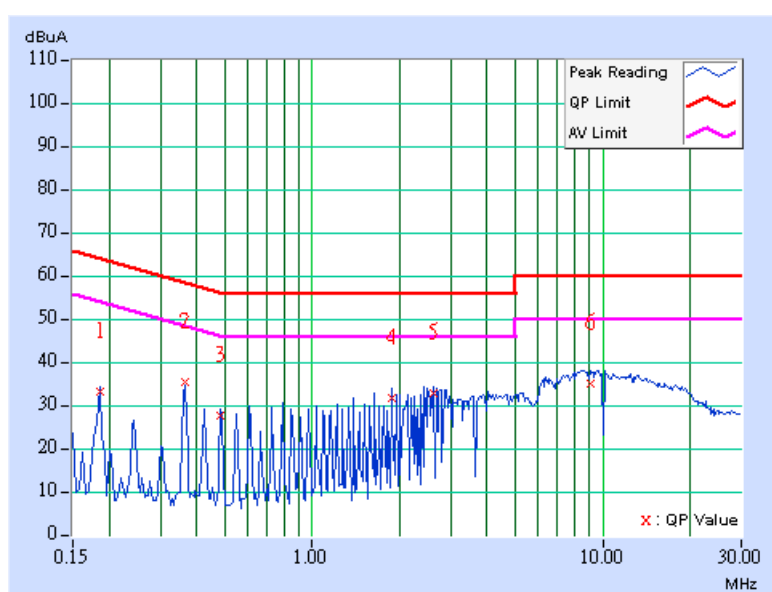

EUT TEST CONDITION		MEASUREMENT DETAIL	
CHANNEL	Channel 1	PHASE	Line 1
MODULATION TYPE	BPSK	6dB BANDWIDTH	9 kHz
ENVIRONMENTAL CONDITIONS	20deg. C, 60%RH, 991 hPa	INPUT POWER (SYSTEM)	120Vac, 60 Hz
TRANSFER RATE	6Mbps	TEST MODE	G
TESTED BY	Mstch Tsui		

No	Freq. [MHz]	Corr. Factor (dB)	Reading Value [dB (uV)]		Emission Level [dB (uV)]		Limit [dB (uV)]		Margin (dB)	
			Q.P.	AV.	Q.P.	AV.	Q.P.	AV.	Q.P.	AV.
			1	0.396	0.10	52.35	42.67	52.45	42.77	57.93
2	0.537	0.10	45.51	-	45.61	-	56.00	46.00	-10.39	-
3	0.935	0.10	40.97	-	41.07	-	56.00	46.00	-14.93	-
4	2.219	0.22	38.81	-	39.03	-	56.00	46.00	-16.97	-
5	4.137	0.37	38.40	-	38.77	-	56.00	46.00	-17.23	-
6	8.164	0.36	42.05	-	42.41	-	60.00	50.00	-17.59	-

- REMARKS:**
1. Q.P. and AV. are abbreviations of quasi-peak and average individually.
  2. "-": The Quasi-peak reading value also meets average limit and measurement with the average detector is unnecessary.
  3. The emission levels of other frequencies were very low against the limit.
  4. Margin value = Emission level - Limit value
  5. Correction factor = Insertion loss + Cable loss
  6. Emission Level = Correction Factor + Reading Value.

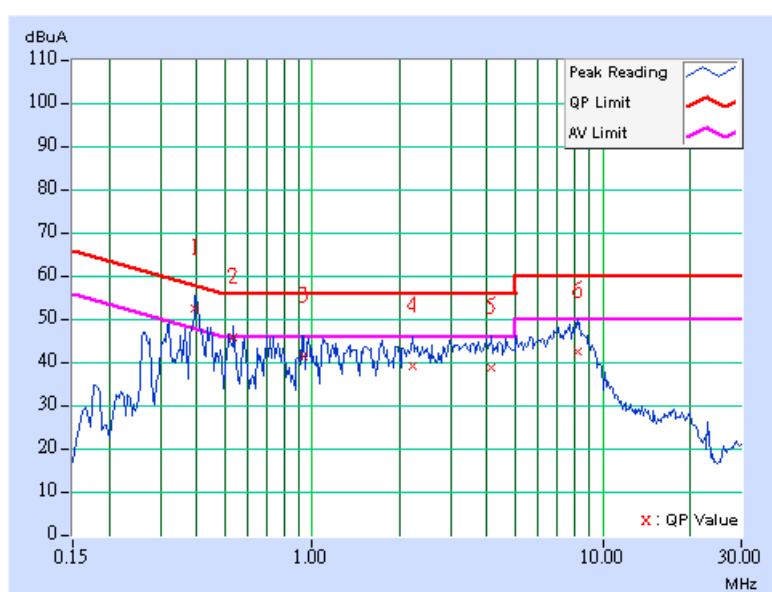

EUT TEST CONDITION		MEASUREMENT DETAIL	
CHANNEL	Channel 1	PHASE	Line 2
MODULATION TYPE	BPSK	6dB BANDWIDTH	9 kHz
ENVIRONMENTAL CONDITIONS	20deg. C, 60%RH, 991 hPa	INPUT POWER (SYSTEM)	120Vac, 60 Hz
TRANSFER RATE	6Mbps	TEST MODE	G
TESTED BY	Mstch Tsui		

No	Freq. [MHz]	Corr. Factor [dB]	Reading Value [dB (uV)]		Emission Level [dB (uV)]		Limit [dB (uV)]		Margin (dB)	
			Q.P.	AV.	Q.P.	AV.	Q.P.	AV.	Q.P.	AV.
1	0.400	0.10	49.27	39.49	49.37	39.59	57.85	47.85	-8.48	-8.26
2	0.545	0.12	38.32	-	38.44	-	56.00	46.00	-17.56	-
3	0.810	0.17	38.89	-	39.06	-	56.00	46.00	-16.94	-
4	1.180	0.20	38.95	-	39.15	-	56.00	46.00	-16.85	-
5	3.051	0.29	35.78	-	36.07	-	56.00	46.00	-19.93	-
6	7.910	0.43	39.65	-	40.08	-	60.00	50.00	-19.92	-

- REMARKS:**
1. Q.P. and AV. are abbreviations of quasi-peak and average individually.
  2. "-": The Quasi-peak reading value also meets average limit and measurement with the average detector is unnecessary.
  3. The emission levels of other frequencies were very low against the limit.
  4. Margin value = Emission level - Limit value
  5. Correction factor = Insertion loss + Cable loss
  6. Emission Level = Correction Factor + Reading Value.

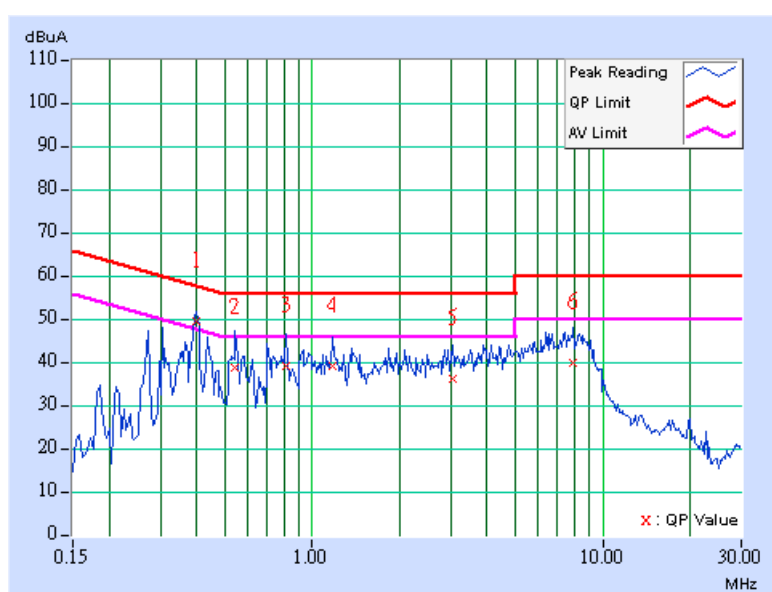

EUT TEST CONDITION		MEASUREMENT DETAIL	
CHANNEL	Channel 6	PHASE	Line 1
MODULATION TYPE	BPSK	6dB BANDWIDTH	9 kHz
ENVIRONMENTAL CONDITIONS	20deg. C, 60%RH, 991 hPa	INPUT POWER (SYSTEM)	120Vac, 60 Hz
TRANSFER RATE	6Mbps	TEST MODE	G
TESTED BY	Mstch Tsui		

No	Freq. [MHz]	Corr. Factor [dB]	Reading Value [dB (uV)]		Emission Level [dB (uV)]		Limit [dB (uV)]		Margin (dB)	
			Q.P.	AV.	Q.P.	AV.	Q.P.	AV.	Q.P.	AV.
			1	0.314	0.10	45.58	-	45.68	-	59.86
2	0.395	0.10	52.22	42.33	52.32	42.43	57.97	47.97	-5.65	-5.54
3	0.541	0.10	44.86	-	44.96	-	56.00	46.00	-11.04	-
4	0.966	0.10	39.98	-	40.08	-	56.00	46.00	-15.92	-
5	2.137	0.21	39.14	-	39.35	-	56.00	46.00	-16.65	-
6	7.980	0.36	41.85	-	42.21	-	60.00	50.00	-17.79	-

- REMARKS:**
1. Q.P. and AV. are abbreviations of quasi-peak and average individually.
  2. "-": The Quasi-peak reading value also meets average limit and measurement with the average detector is unnecessary.
  3. The emission levels of other frequencies were very low against the limit.
  4. Margin value = Emission level - Limit value
  5. Correction factor = Insertion loss + Cable loss
  6. Emission Level = Correction Factor + Reading Value.

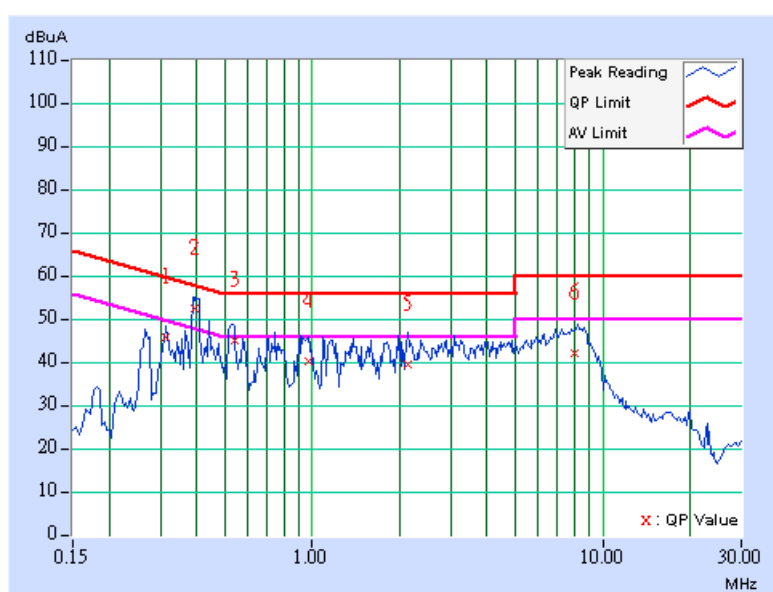

EUT TEST CONDITION		MEASUREMENT DETAIL	
CHANNEL	Channel 6	PHASE	Line 2
MODULATION TYPE	BPSK	6dB BANDWIDTH	9 kHz
ENVIRONMENTAL CONDITIONS	20deg. C, 60%RH, 991 hPa	INPUT POWER (SYSTEM)	120Vac, 60 Hz
TRANSFER RATE	6Mbps	TEST MODE	G
TESTED BY	Mstch Tsui		

No	Freq. [MHz]	Corr. Factor [dB]	Reading Value [dB (uV)]		Emission Level [dB (uV)]		Limit [dB (uV)]		Margin (dB)	
			Q.P.	AV.	Q.P.	AV.	Q.P.	AV.	Q.P.	AV.
1	0.318	0.10	42.06	-	42.16	-	59.76	49.76	-17.60	-
2	0.392	0.10	49.44	38.71	49.54	38.81	58.02	48.02	-8.48	-9.21
3	0.537	0.12	40.75	-	40.87	-	56.00	46.00	-15.13	-
4	0.814	0.17	38.65	-	38.82	-	56.00	46.00	-17.18	-
5	1.926	0.20	34.99	-	35.19	-	56.00	46.00	-20.81	-
6	3.715	0.35	35.73	-	36.08	-	56.00	46.00	-19.92	-

- REMARKS:**
1. Q.P. and AV. are abbreviations of quasi-peak and average individually.
  2. "-": The Quasi-peak reading value also meets average limit and measurement with the average detector is unnecessary.
  3. The emission levels of other frequencies were very low against the limit.
  4. Margin value = Emission level - Limit value
  5. Correction factor = Insertion loss + Cable loss
  6. Emission Level = Correction Factor + Reading Value.

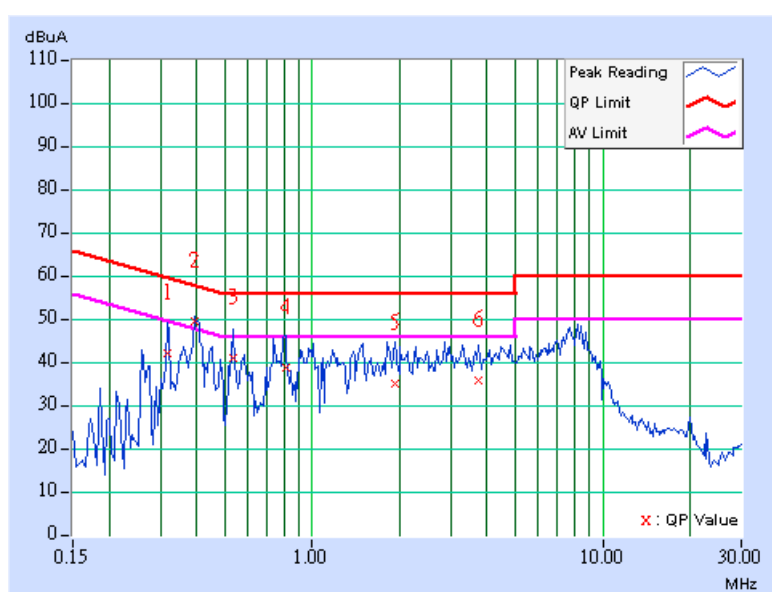



EUT TEST CONDITION		MEASUREMENT DETAIL	
CHANNEL	Channel 11	PHASE	Line 1
MODULATION TYPE	BPSK	6dB BANDWIDTH	9 kHz
ENVIRONMENTAL CONDITIONS	20deg. C, 60%RH, 991 hPa	INPUT POWER (SYSTEM)	120Vac, 60 Hz
TRANSFER RATE	6Mbps	TEST MODE	G
TESTED BY	Mstch Tsui		

No	Freq. [MHz]	Corr. Factor (dB)	Reading Value [dB (uV)]		Emission Level [dB (uV)]		Limit [dB (uV)]		Margin (dB)	
			Q.P.	AV.	Q.P.	AV.	Q.P.	AV.	Q.P.	AV.
1	0.399	0.10	52.45	42.89	52.55	42.99	57.88	47.88	-5.33	-4.89
2	0.537	0.10	45.51	-	45.61	-	56.00	46.00	-10.39	-
3	0.938	0.10	41.54	-	41.64	-	56.00	46.00	-14.36	-
4	2.219	0.22	38.81	-	39.03	-	56.00	46.00	-16.97	-
5	4.137	0.37	39.21	-	39.58	-	56.00	46.00	-16.42	-
6	8.166	0.36	43.21	-	43.57	-	60.00	50.00	-16.43	-

- REMARKS:**
1. Q.P. and AV. are abbreviations of quasi-peak and average individually.
  2. "-": The Quasi-peak reading value also meets average limit and measurement with the average detector is unnecessary.
  3. The emission levels of other frequencies were very low against the limit.
  4. Margin value = Emission level - Limit value
  5. Correction factor = Insertion loss + Cable loss
  6. Emission Level = Correction Factor + Reading Value.

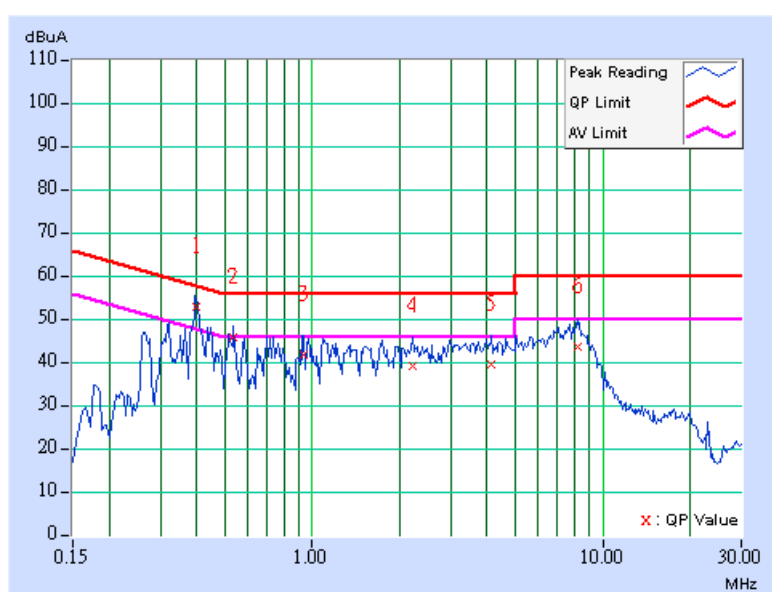

EUT TEST CONDITION		MEASUREMENT DETAIL	
CHANNEL	Channel 11	PHASE	Line 2
MODULATION TYPE	BPSK	6dB BANDWIDTH	9 kHz
ENVIRONMENTAL CONDITIONS	20deg. C, 60%RH, 991 hPa	INPUT POWER (SYSTEM)	120Vac, 60 Hz
TRANSFER RATE	6Mbps	TEST MODE	G
TESTED BY	Mstch Tsui		

No	Freq. [MHz]	Corr. Factor [dB]	Reading Value [dB (uV)]		Emission Level [dB (uV)]		Limit [dB (uV)]		Margin (dB)	
			Q.P.	AV.	Q.P.	AV.	Q.P.	AV.	Q.P.	AV.
			1	0.425	0.10	49.74	39.49	49.84	39.59	57.36
2	0.545	0.12	38.32	-	38.44	-	56.00	46.00	-17.56	-
3	0.825	0.17	38.96	-	39.13	-	56.00	46.00	-16.87	-
4	1.185	0.20	39.21	-	39.41	-	56.00	46.00	-16.59	-
5	3.051	0.29	35.78	-	36.07	-	56.00	46.00	-19.93	-
6	7.925	0.43	40.50	-	40.93	-	60.00	50.00	-19.07	-

- REMARKS:**
1. Q.P. and AV. are abbreviations of quasi-peak and average individually.
  2. "-": The Quasi-peak reading value also meets average limit and measurement with the average detector is unnecessary.
  3. The emission levels of other frequencies were very low against the limit.
  4. Margin value = Emission level - Limit value
  5. Correction factor = Insertion loss + Cable loss
  6. Emission Level = Correction Factor + Reading Value.

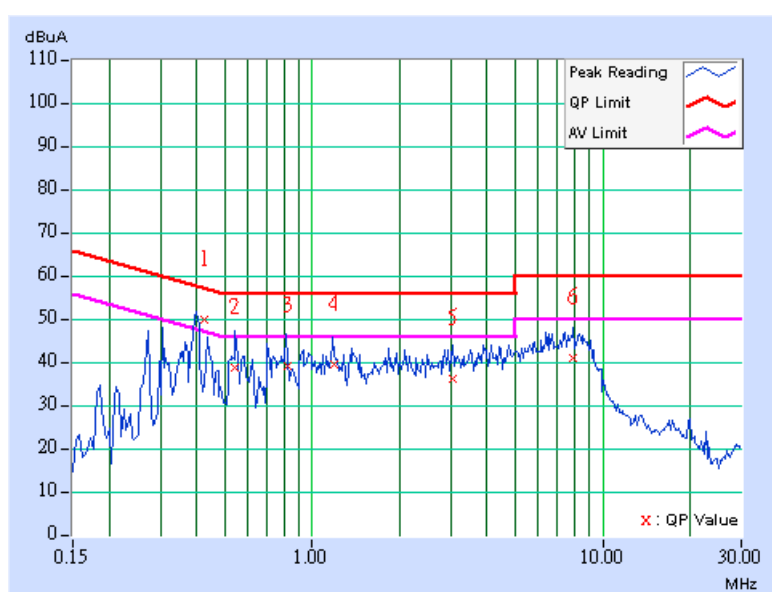

## 4.2 RADIATED EMISSION MEASUREMENT

### 4.2.1 LIMITS OF RADIATED EMISSION MEASUREMENT

Emissions radiated outside of the specified bands, shall be according to the general radiated limits in 15.209 as following:

FREQUENCIES (MHz)	FIELD STRENGTH (microvolts/meter)	MEASUREMENT DISTANCE (meters)
0.009 ~ 0.490	2400/F(kHz)	300
0.490 ~ 1.705	24000/F(kHz)	30
1.705 ~ 30.0	30	30
30 ~ 88	100	3
88 ~ 216	150	3
216 ~ 960	200	3
Above 960	500	3

#### NOTE

1. The lower limit shall apply at the transition frequencies.
2. Emission level (dBuV/m) = 20 log Emission level (uV/m).
3. As shown in 15.35(b), for frequencies above 1000MHz, the field strength limits are based on average detector, however, the peak field strength of any emission shall not exceed the maximum permitted average limits, specified above by more than 20dB under any condition of modulation.

#### 4.2.2 TEST INSTRUMENTS

DESCRIPTION & MANUFACTURER	MODEL NO.	SERIAL NO.	CALIBRATED UNTIL
Test Receiver ROHDE & SCHWARZ	ESMI	839013/007 839379/002	Jan. 24, 2007
Spectrum Analyzer ROHDE & SCHWARZ	FSP40	100040	Jun. 07, 2007
BILOG Antenna SCHWARZBECK	VULB9163	121	Jun. 01, 2007
HORN Antenna SCHWARZBECK	BBHA 9120 D	9120D-407	Jan. 22, 2007
HORN Antenna SCHWARZBECK	BBHA 9170	BBHA9170242	Jan. 19, 2007
Preamplifier Agilent	8449B	3008A01911	Sep. 21, 2007
RF signal cable HUBER+SUHNNER	SUCOFLEX 104	218188/218189	Dec. 13, 2006
RF signal cable Worken	8D-FB	Cable-HYCH9-01	Mar. 08, 2007
Software ADT.	ADT_Radiated_ V7.6.01	NA	NA
Antenna Tower EMCO	2070/2080	512.835.4684	NA
Antenna Tower Controller EMCO	2090	NA	NA
Turn Table EMCO	2087-2.03	NA	NA
Turn Table Controller EMCO	2090	NA	NA

- NOTE:**
1. The calibration interval of the above test instruments is 12 months and the calibrations are traceable to NML/ROC and NIST/USA.
  2. The test was performed in HwaYa Chamber 9.
  3. The horn antenna and HP preamplifier (model: 8449B) are used only for the measurement of emission frequency above 1GHz if tested.
  4. The IC Site Registration No. is IC4924A-9.

#### 4.2.3 TEST PROCEDURES

- a. The EUT was placed on the top of a rotating table 0.8 meters above the ground at a 3 meter semi-anechoic chamber. The table was rotated 360 degrees to determine the position of the highest radiation.
- b. The EUT was set 3 meters away from the interference-receiving antenna, which was mounted on the top of a variable-height antenna tower.
- c. The antenna is a broadband antenna, and its height is varied from one meter to four meters above the ground to determine the maximum value of the field strength. Both horizontal and vertical polarizations of the antenna are set to make the measurement.
- d. For each suspected emission, the EUT was arranged to its worst case and then the antenna was tuned to heights from 1 meter to 4 meters and the rotatable table was turned from 0 degrees to 360 degrees to find the maximum reading.
- e. The test-receiver system was set to Peak Detect Function and Specified Bandwidth with Maximum Hold Mode.
- f. If the emission level of the EUT in peak mode was lower than the limit specified, then testing could be stopped and the peak values of the EUT would be reported. Otherwise the emissions would be re-tested one by one using the peak, quasi-peak or average method as specified and then reported in a data sheet.

**NOTE:**

1. The resolution bandwidth and video bandwidth of test receiver/spectrum analyzer is 120kHz for Quasi-peak detection at frequency below 1GHz.
2. The resolution bandwidth of test receiver/spectrum analyzer is 1 MHz and video bandwidth is 3MHz for Peak detection at frequency above 1GHz.
3. The resolution bandwidth of test receiver/spectrum analyzer is 1 MHz and the video bandwidth is 10Hz for Average detection (AV) at frequency above 1GHz.

#### 4.2.4 DEVIATION FROM TEST STANDARD

No deviation

#### 4.2.5 TEST SETUP

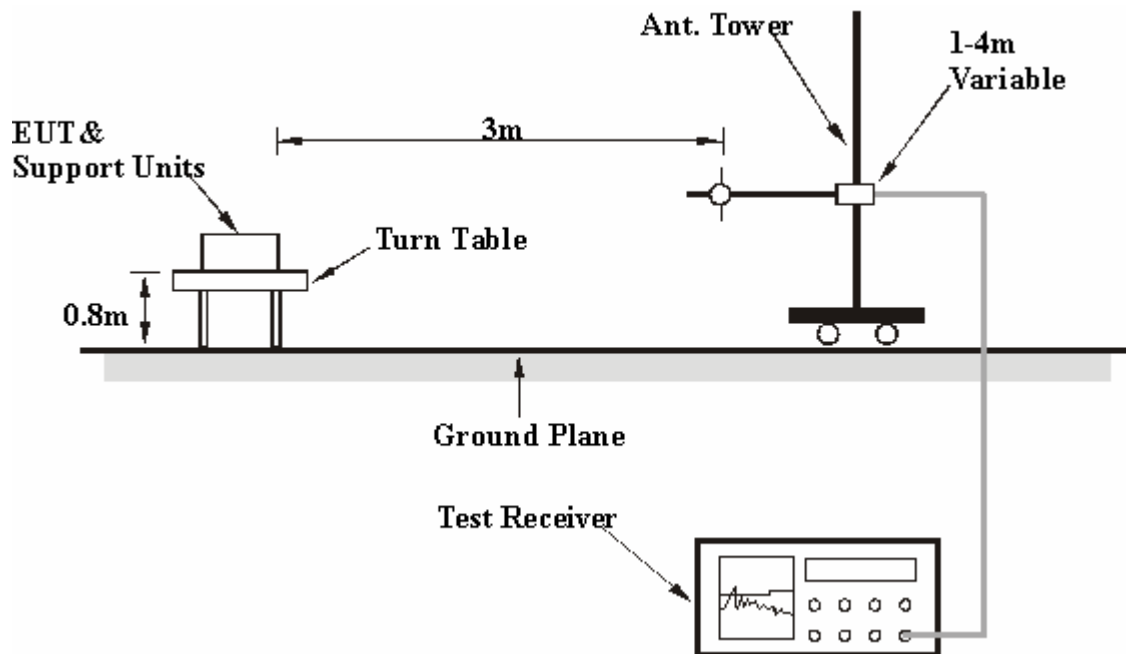

For the actual test configuration, please refer to the attached file (Test Setup Photo).

#### 4.2.6 EUT OPERATING CONDITIONS

Same as 4.1.6

#### 4.2.7 TEST RESULTS

##### RADIATED WORST CASE DATA:

EUT TEST CONDITION		MEASUREMENT DETAIL	
CHANNEL	Channel 11	FREQUENCY RANGE	Below 1000MHz
MODULATION TYPE	BPSK	DETECTOR FUNCTION	Quasi-Peak
TRANSFER RATE	6Mbps	INPUT POWER (SYSTEM)	120Vac, 60 Hz
ENVIRONMENTAL CONDITIONS	26deg. C, 65%RH, 991hPa	TEST MODE	A
TESTED BY	Match Tsui		

ANTENNA POLARITY & TEST DISTANCE: HORIZONTAL AT 3 M								
No.	Freq. (MHz)	Emission Level (dBuV/m)	Limit (dBuV/m)	Margin (dB)	Antenna Height (m)	Table Angle (Degree)	Raw Value (dBuV)	Correction Factor (dB/m)
1	49.44	23.04 QP	40.00	-16.96	3.00 H	10	9.17	13.88
2	119.42	29.47 QP	43.50	-14.03	3.00 H	10	19.48	9.99
3	134.97	27.90 QP	43.50	-15.60	2.00 H	301	15.88	12.02
4	210.78	30.85 QP	43.50	-12.65	2.00 H	10	20.57	10.28
5	255.49	27.96 QP	46.00	-18.04	1.00 H	48	16.42	11.54
6	269.10	27.96 QP	46.00	-18.04	1.00 H	86	14.88	13.08
7	640.38	26.42 QP	46.00	-19.58	2.00 H	10	5.17	21.25
8	945.57	30.70 QP	46.00	-15.30	2.00 H	301	3.55	27.14

ANTENNA POLARITY & TEST DISTANCE: VERTICAL AT 3 M								
No.	Freq. (MHz)	Emission Level (dBuV/m)	Limit (dBuV/m)	Margin (dB)	Antenna Height (m)	Table Angle (Degree)	Raw Value (dBuV)	Correction Factor (dB/m)
1	57.21	30.33 QP	40.00	-9.67	1.00 V	187	17.06	13.27
2	127.19	25.45 QP	43.50	-18.05	1.00 V	282	14.46	10.99
3	136.91	27.83 QP	43.50	-15.67	1.00 V	206	15.56	12.28
4	162.18	26.83 QP	43.50	-16.67	1.00 V	162	14.38	12.45
5	210.78	26.11 QP	43.50	-17.39	1.00 V	232	15.83	10.28
6	241.88	29.40 QP	46.00	-16.60	1.00 V	23	18.10	11.31
7	640.38	29.62 QP	46.00	-16.38	1.00 V	232	8.38	21.25
8	937.80	26.33 QP	46.00	-19.67	1.00 V	282	-0.43	26.76
9	945.57	35.44 QP	46.00	-10.56	1.00 V	42	8.29	27.14

- REMARKS:**
1. Emission level(dBuV/m)=Raw Value(dBuV) + Correction Factor(dB/m)
  2. Correction Factor(dB/m) = Antenna Factor (dB/m) + Cable Factor (dB)
  3. The other emission levels were very low against the limit.
  4. Margin value = Emission level – Limit value.

EUT TEST CONDITION		MEASUREMENT DETAIL	
CHANNEL	Channel 11	FREQUENCY RANGE	Below 1000MHz
MODULATION TYPE	BPSK	DETECTOR FUNCTION	Quasi-Peak
TRANSFER RATE	6Mbps	INPUT POWER (SYSTEM)	120Vac, 60 Hz
ENVIRONMENTAL CONDITIONS	26deg. C, 65%RH, 991hPa	TEST MODE	B
TESTED BY	Match Tsui		

ANTENNA POLARITY & TEST DISTANCE: HORIZONTAL AT 3 M								
No.	Freq. (MHz)	Emission Level (dBuV/m)	Limit (dBuV/m)	Margin (dB)	Antenna Height (m)	Table Angle (Degree)	Raw Value (dBuV)	Correction Factor (dB/m)
1	51.38	22.04 QP	40.00	-17.96	2.00 H	238	8.35	13.70
2	119.42	28.32 QP	43.50	-15.18	2.00 H	251	18.33	9.99
3	133.03	23.05 QP	43.50	-20.45	2.00 H	124	11.29	11.76
4	210.78	23.44 QP	43.50	-20.06	2.00 H	92	13.16	10.28
5	230.22	27.40 QP	46.00	-18.60	2.00 H	301	16.48	10.92
6	383.79	26.74 QP	46.00	-19.26	2.00 H	251	10.59	16.15
7	576.23	26.65 QP	46.00	-19.35	1.50 H	61	6.42	20.23
8	671.48	25.36 QP	46.00	-20.64	2.00 H	92	3.56	21.80
9	877.54	25.44 QP	46.00	-20.56	1.50 H	105	0.66	24.78
10	935.85	26.21 QP	46.00	-19.79	2.00 H	282	-0.46	26.67
11	951.40	32.71 QP	46.00	-13.29	1.00 H	17	5.39	27.32

ANTENNA POLARITY & TEST DISTANCE: VERTICAL AT 3 M								
No.	Freq. (MHz)	Emission Level (dBuV/m)	Limit (dBuV/m)	Margin (dB)	Antenna Height (m)	Table Angle (Degree)	Raw Value (dBuV)	Correction Factor (dB/m)
1	49.44	36.61 QP	40.00	-3.39	1.00 V	29	22.73	13.88
2	63.05	26.56 QP	40.00	-13.44	1.00 V	118	13.97	12.59
3	111.64	26.09 QP	43.50	-17.41	1.00 V	24	16.76	9.33
4	136.91	29.99 QP	43.50	-13.51	1.00 V	194	17.71	12.28
5	162.18	27.77 QP	43.50	-15.73	1.00 V	118	15.31	12.45
6	210.78	25.35 QP	43.50	-18.15	1.00 V	24	15.07	10.28
7	241.88	30.30 QP	46.00	-15.70	1.00 V	327	18.99	11.31
8	576.23	26.43 QP	46.00	-19.57	1.00 V	11	6.20	20.23
9	640.38	29.89 QP	46.00	-16.11	1.00 V	24	8.65	21.25
10	937.80	25.96 QP	46.00	-20.04	1.00 V	358	-0.80	26.76
11	949.46	35.82 QP	46.00	-10.18	1.00 V	61	8.49	27.33

- REMARKS:**
1. Emission level(dBuV/m)=Raw Value(dBuV) + Correction Factor(dB/m)
  2. Correction Factor(dB/m) = Antenna Factor (dB/m) + Cable Factor (dB)
  3. The other emission levels were very low against the limit.
  4. Margin value = Emission level – Limit value.



EUT TEST CONDITION		MEASUREMENT DETAIL	
CHANNEL	Channel 11	FREQUENCY RANGE	Below 1000MHz
MODULATION TYPE	BPSK	DETECTOR FUNCTION	Quasi-Peak
TRANSFER RATE	6Mbps	INPUT POWER (SYSTEM)	120Vac, 60 Hz
ENVIRONMENTAL CONDITIONS	24deg. C, 65%RH, 991hPa	TEST MODE	C
TESTED BY	Match Tsui		

ANTENNA POLARITY & TEST DISTANCE: HORIZONTAL AT 3 M								
No.	Freq. (MHz)	Emission Level (dBuV/m)	Limit (dBuV/m)	Margin (dB)	Antenna Height (m)	Table Angle (Degree)	Raw Value (dBuV)	Correction Factor (dB/m)
1	76.65	25.06 QP	40.00	-14.94	2.00 H	30	14.52	10.54
2	142.75	33.29 QP	43.50	-10.21	2.00 H	30	20.61	12.67
3	191.34	31.34 QP	43.50	-12.16	1.00 H	219	20.84	10.50
4	210.78	29.69 QP	43.50	-13.81	2.50 H	10	19.41	10.28
5	255.49	31.93 QP	46.00	-14.07	1.50 H	24	20.39	11.54
6	391.56	28.22 QP	46.00	-17.78	1.50 H	42	11.83	16.39
7	512.08	29.56 QP	46.00	-16.44	2.00 H	16	10.71	18.85
8	601.50	29.81 QP	46.00	-16.19	2.00 H	219	8.99	20.82
9	720.08	29.80 QP	46.00	-16.20	1.00 H	219	6.80	23.00
10	760.90	29.46 QP	46.00	-16.54	1.50 H	213	5.53	23.93
11	801.72	28.57 QP	46.00	-17.43	2.00 H	42	4.56	24.01
12	945.57	30.64 QP	46.00	-15.36	2.50 H	10	3.49	27.14

- REMARKS:**
1. Emission level(dBuV/m)=Raw Value(dBuV) + Correction Factor(dB/m)
  2. Correction Factor(dB/m) = Antenna Factor (dB/m) + Cable Factor (dB)
  3. The other emission levels were very low against the limit.
  4. Margin value = Emission level – Limit value.

EUT TEST CONDITION		MEASUREMENT DETAIL	
CHANNEL	Channel 11	FREQUENCY RANGE	Below 1000MHz
MODULATION TYPE	BPSK	DETECTOR FUNCTION	Quasi-Peak
TRANSFER RATE	6Mbps	INPUT POWER (SYSTEM)	120Vac, 60 Hz
ENVIRONMENTAL CONDITIONS	24deg. C, 65%RH, 991hPa	TEST MODE	C
TESTED BY	Match Tsui		

ANTENNA POLARITY & TEST DISTANCE: VERTICAL AT 3 M								
No.	Freq. (MHz)	Emission Level (dBuV/m)	Limit (dBuV/m)	Margin (dB)	Antenna Height (m)	Table Angle (Degree)	Raw Value (dBuV)	Correction Factor (dB/m)
1	41.66	34.60 QP	40.00	-5.40	1.00 V	111	20.49	14.11
2	76.65	26.03 QP	40.00	-13.97	1.00 V	168	15.50	10.54
3	109.70	31.01 QP	43.50	-12.49	1.00 V	168	21.85	9.17
4	150.52	30.34 QP	43.50	-13.16	1.00 V	143	17.69	12.64
5	191.34	28.92 QP	43.50	-14.58	1.00 V	80	18.42	10.50
6	599.56	30.56 QP	46.00	-15.44	1.00 V	137	9.77	20.80
7	681.20	29.96 QP	46.00	-16.04	1.00 V	80	7.96	22.00
8	720.08	31.78 QP	46.00	-14.22	1.00 V	80	8.78	23.00
9	731.74	31.35 QP	46.00	-14.65	1.00 V	137	8.00	23.36
10	760.90	29.81 QP	46.00	-16.19	1.00 V	137	5.89	23.93
11	801.72	32.10 QP	46.00	-13.90	1.00 V	162	8.09	24.01
12	863.93	29.61 QP	46.00	-16.39	1.00 V	162	4.92	24.69
13	945.57	35.10 QP	46.00	-10.90	1.00 V	168	7.96	27.14

- REMARKS:**
1. Emission level(dBuV/m)=Raw Value(dBuV) + Correction Factor(dB/m)
  2. Correction Factor(dB/m) = Antenna Factor (dB/m) + Cable Factor (dB)
  3. The other emission levels were very low against the limit.
  4. Margin value = Emission level – Limit value.

EUT TEST CONDITION		MEASUREMENT DETAIL	
CHANNEL	Channel 11	FREQUENCY RANGE	Below 1000MHz
MODULATION TYPE	BPSK	DETECTOR FUNCTION	Quasi-Peak
TRANSFER RATE	6Mbps	INPUT POWER (SYSTEM)	120Vac, 60 Hz
ENVIRONMENTAL CONDITIONS	24deg. C, 68%RH, 991hPa	TEST MODE	D
TESTED BY	Match Tsui		

ANTENNA POLARITY & TEST DISTANCE: HORIZONTAL AT 3 M								
No.	Freq. (MHz)	Emission Level (dBuV/m)	Limit (dBuV/m)	Margin (dB)	Antenna Height (m)	Table Angle (Degree)	Raw Value (dBuV)	Correction Factor (dB/m)
1	30.00	22.17 QP	40.00	-17.83	1.50 H	143	10.51	11.67
2	72.77	28.73 QP	40.00	-11.27	2.00 H	206	17.63	11.10
3	109.70	26.67 QP	43.50	-16.83	2.00 H	17	17.51	9.17
4	142.75	30.93 QP	43.50	-12.57	2.00 H	17	18.26	12.67
5	173.85	30.13 QP	43.50	-13.37	2.00 H	194	18.46	11.67
6	210.78	30.99 QP	43.50	-12.51	2.00 H	175	20.70	10.28
7	383.79	28.33 QP	46.00	-17.67	1.50 H	29	12.18	16.15
8	599.56	31.56 QP	46.00	-14.44	2.50 H	16	10.76	20.80
9	640.38	30.16 QP	46.00	-15.84	2.00 H	175	8.92	21.25
10	720.08	29.71 QP	46.00	-16.29	2.00 H	17	6.71	23.00
11	751.18	28.11 QP	46.00	-17.89	2.00 H	17	4.20	23.91
12	760.90	29.09 QP	46.00	-16.91	2.50 H	16	5.17	23.93
13	955.29	31.08 QP	46.00	-14.92	2.00 H	175	3.86	27.21

- REMARKS:**
1. Emission level(dBuV/m)=Raw Value(dBuV) + Correction Factor(dB/m)
  2. Correction Factor(dB/m) = Antenna Factor (dB/m) + Cable Factor (dB)
  3. The other emission levels were very low against the limit.
  4. Margin value = Emission level – Limit value.

EUT TEST CONDITION		MEASUREMENT DETAIL	
CHANNEL	Channel 11	FREQUENCY RANGE	Below 1000MHz
MODULATION TYPE	BPSK	DETECTOR FUNCTION	Quasi-Peak
TRANSFER RATE	6Mbps	INPUT POWER (SYSTEM)	120Vac, 60 Hz
ENVIRONMENTAL CONDITIONS	24deg. C, 68%RH, 991hPa	TEST MODE	D
TESTED BY	Match Tsui		

ANTENNA POLARITY & TEST DISTANCE: VERTICAL AT 3 M								
No.	Freq. (MHz)	Emission Level (dBuV/m)	Limit (dBuV/m)	Margin (dB)	Antenna Height (m)	Table Angle (Degree)	Raw Value (dBuV)	Correction Factor (dB/m)
1	35.83	37.45 QP	40.00	-2.55	1.00 V	105	24.84	12.61
2	74.71	28.84 QP	40.00	-11.16	1.00 V	156	18.02	10.82
3	109.70	31.92 QP	43.50	-11.58	1.00 V	149	22.75	9.17
4	142.75	30.54 QP	43.50	-12.96	1.00 V	149	17.87	12.67
5	599.56	29.16 QP	46.00	-16.84	1.00 V	130	8.36	20.80
6	681.20	29.62 QP	46.00	-16.38	1.00 V	105	7.62	22.00
7	720.08	31.17 QP	46.00	-14.83	1.00 V	92	8.17	23.00
8	731.74	31.42 QP	46.00	-14.58	1.00 V	118	8.06	23.36
9	760.90	30.54 QP	46.00	-15.46	1.00 V	130	6.62	23.93
10	799.78	30.51 QP	46.00	-15.49	1.00 V	86	6.52	23.98
11	865.87	28.98 QP	46.00	-17.02	1.00 V	118	4.28	24.71
12	945.57	33.82 QP	46.00	-12.18	1.00 V	105	6.68	27.14

- REMARKS:**
1. Emission level(dBuV/m)=Raw Value(dBuV) + Correction Factor(dB/m)
  2. Correction Factor(dB/m) = Antenna Factor (dB/m) + Cable Factor (dB)
  3. The other emission levels were very low against the limit.
  4. Margin value = Emission level – Limit value.

EUT TEST CONDITION		MEASUREMENT DETAIL	
CHANNEL	Channel 11	FREQUENCY RANGE	Below 1000MHz
MODULATION TYPE	BPSK	DETECTOR FUNCTION	Quasi-Peak
TRANSFER RATE	6Mbps	INPUT POWER (SYSTEM)	120Vac, 60 Hz
ENVIRONMENTAL CONDITIONS	24deg. C, 68%RH, 991hPa	TEST MODE	E
TESTED BY	Match Tsui		

ANTENNA POLARITY & TEST DISTANCE: HORIZONTAL AT 3 M								
No.	Freq. (MHz)	Emission Level (dBuV/m)	Limit (dBuV/m)	Margin (dB)	Antenna Height (m)	Table Angle (Degree)	Raw Value (dBuV)	Correction Factor (dB/m)
1	76.65	27.18 QP	40.00	-12.82	2.00 H	333	16.64	10.54
2	111.64	32.92 QP	43.50	-10.58	1.50 H	282	23.59	9.33
3	152.46	34.82 QP	43.50	-8.68	1.50 H	346	22.19	12.63
4	166.07	30.35 QP	43.50	-13.15	2.00 H	295	18.16	12.19
5	210.78	36.50 QP	43.50	-7.00	1.50 H	282	26.22	10.28
6	249.66	32.91 QP	46.00	-13.09	1.50 H	61	21.35	11.56
7	457.66	31.54 QP	46.00	-14.46	1.00 H	73	13.86	17.67
8	465.43	31.07 QP	46.00	-14.93	1.00 H	327	13.22	17.85
9	531.52	34.82 QP	46.00	-11.18	1.00 H	327	15.59	19.23
10	584.01	32.19 QP	46.00	-13.81	2.00 H	54	11.77	20.42
11	601.50	32.98 QP	46.00	-13.02	2.00 H	358	12.15	20.82
12	735.63	31.89 QP	46.00	-14.11	2.00 H	333	8.41	23.47
13	945.57	32.87 QP	46.00	-13.13	1.00 H	327	5.73	27.14

ANTENNA POLARITY & TEST DISTANCE: VERTICAL AT 3 M								
No.	Freq. (MHz)	Emission Level (dBuV/m)	Limit (dBuV/m)	Margin (dB)	Antenna Height (m)	Table Angle (Degree)	Raw Value (dBuV)	Correction Factor (dB/m)
1	113.59	30.51 QP	43.50	-12.99	1.50 V	289	21.02	9.50
2	249.66	35.46 QP	46.00	-10.54	1.00 V	30	23.90	11.56
3	457.66	33.17 QP	46.00	-12.83	1.00 V	61	15.50	17.67
4	471.26	30.13 QP	46.00	-15.87	1.00 V	213	12.15	17.98
5	517.92	33.76 QP	46.00	-12.24	1.00 V	61	14.80	18.96
6	597.62	31.02 QP	46.00	-14.98	1.00 V	86	10.27	20.75
7	640.38	30.72 QP	46.00	-15.28	1.00 V	213	9.47	21.25
8	751.18	33.67 QP	46.00	-12.33	1.00 V	80	9.76	23.91
9	945.57	35.75 QP	46.00	-10.25	1.00 V	86	8.61	27.14

- REMARKS:**
1. Emission level(dBuV/m)=Raw Value(dBuV) + Correction Factor(dB/m)
  2. Correction Factor(dB/m) = Antenna Factor (dB/m) + Cable Factor (dB)
  3. The other emission levels were very low against the limit.
  4. Margin value = Emission level – Limit value.



EUT TEST CONDITION		MEASUREMENT DETAIL	
CHANNEL	Channel 11	FREQUENCY RANGE	Below 1000MHz
MODULATION TYPE	BPSK	DETECTOR FUNCTION	Quasi-Peak
TRANSFER RATE	6Mbps	INPUT POWER (SYSTEM)	120Vac, 60 Hz
ENVIRONMENTAL CONDITIONS	24deg. C, 68%RH, 991hPa	TEST MODE	F
TESTED BY	Match Tsui		

ANTENNA POLARITY & TEST DISTANCE: HORIZONTAL AT 3 M								
No.	Freq. (MHz)	Emission Level (dBuV/m)	Limit (dBuV/m)	Margin (dB)	Antenna Height (m)	Table Angle (Degree)	Raw Value (dBuV)	Correction Factor (dB/m)
1	121.36	36.89 QP	43.50	-6.61	1.75 H	61	26.67	10.22
2	255.49	24.75 QP	46.00	-21.25	1.00 H	276	13.21	11.54
3	346.85	25.40 QP	46.00	-20.60	1.00 H	225	10.35	15.05
4	387.68	31.13 QP	46.00	-14.87	1.00 H	137	14.86	16.27
5	568.46	26.33 QP	46.00	-19.67	1.25 H	99	6.29	20.04
6	945.57	33.48 QP	46.00	-12.52	1.25 H	54	6.33	27.14

ANTENNA POLARITY & TEST DISTANCE: VERTICAL AT 3 M								
No.	Freq. (MHz)	Emission Level (dBuV/m)	Limit (dBuV/m)	Margin (dB)	Antenna Height (m)	Table Angle (Degree)	Raw Value (dBuV)	Correction Factor (dB/m)
1	49.44	26.25 QP	40.00	-13.75	1.00 V	149	12.38	13.88
2	115.53	37.46 QP	43.50	-6.04	1.00 V	149	27.80	9.66
3	150.52	25.25 QP	43.50	-18.25	1.00 V	168	12.61	12.64
4	300.20	23.92 QP	46.00	-22.08	1.50 V	314	9.41	14.52
5	603.45	27.54 QP	46.00	-18.46	1.50 V	181	6.69	20.84
6	626.77	28.17 QP	46.00	-17.83	1.50 V	181	7.07	21.10

- REMARKS:**
1. Emission level(dBuV/m)= Raw Value(dBuV) + Correction Factor(dB/m)
  2. Correction Factor(dB/m) = Antenna Factor (dB/m) + Cable Factor (dB)
  3. The other emission levels were very low against the limit.
  4. Margin value = Emission level – Limit value.

EUT TEST CONDITION		MEASUREMENT DETAIL	
CHANNEL	Channel 11	FREQUENCY RANGE	Below 1000MHz
MODULATION TYPE	BPSK	DETECTOR FUNCTION	Quasi-Peak
TRANSFER RATE	6Mbps	INPUT POWER (SYSTEM)	120Vac, 60 Hz
ENVIRONMENTAL CONDITIONS	24deg. C, 68%RH, 991hPa	TEST MODE	G
TESTED BY	Match Tsui		

ANTENNA POLARITY & TEST DISTANCE: HORIZONTAL AT 3 M								
No.	Freq. (MHz)	Emission Level (dBuV/m)	Limit (dBuV/m)	Margin (dB)	Antenna Height (m)	Table Angle (Degree)	Raw Value (dBuV)	Correction Factor (dB/m)
1	113.59	32.77 QP	43.50	-10.73	1.00 H	232	23.28	9.50
2	158.30	27.84 QP	43.50	-15.66	1.50 H	238	15.23	12.61
3	166.07	27.62 QP	43.50	-15.88	2.00 H	225	15.43	12.19
4	210.78	30.39 QP	43.50	-13.11	2.00 H	200	20.11	10.28
5	249.66	32.64 QP	46.00	-13.36	2.00 H	143	21.08	11.56
6	457.66	30.12 QP	46.00	-15.88	1.50 H	282	12.45	17.67
7	465.43	36.00 QP	46.00	-10.00	2.00 H	238	18.15	17.85
8	599.56	35.32 QP	46.00	-10.68	2.00 H	219	14.52	20.80
9	751.18	33.39 QP	46.00	-12.61	1.50 H	238	9.48	23.91
10	801.72	33.26 QP	46.00	-12.74	1.00 H	232	9.25	24.01
11	865.87	30.40 QP	46.00	-15.60	1.00 H	263	5.69	24.71
12	955.29	32.86 QP	46.00	-13.14	2.00 H	200	5.64	27.21

- REMARKS:**
1. Emission level(dBuV/m)=Raw Value(dBuV) + Correction Factor(dB/m)
  2. Correction Factor(dB/m) = Antenna Factor (dB/m) + Cable Factor (dB)
  3. The other emission levels were very low against the limit.
  4. Margin value = Emission level – Limit value.

EUT TEST CONDITION		MEASUREMENT DETAIL	
CHANNEL	Channel 11	FREQUENCY RANGE	Below 1000MHz
MODULATION TYPE	BPSK	DETECTOR FUNCTION	Quasi-Peak
TRANSFER RATE	6Mbps	INPUT POWER (SYSTEM)	120Vac, 60 Hz
ENVIRONMENTAL CONDITIONS	24deg. C, 68%RH, 991hPa	TEST MODE	G
TESTED BY	Match Tsui		

ANTENNA POLARITY & TEST DISTANCE: VERTICAL AT 3 M								
No.	Freq. (MHz)	Emission Level (dBuV/m)	Limit (dBuV/m)	Margin (dB)	Antenna Height (m)	Table Angle (Degree)	Raw Value (dBuV)	Correction Factor (dB/m)
1	30.00	26.30 QP	40.00	-13.70	1.00 V	308	14.63	11.67
2	63.05	22.63 QP	40.00	-17.37	1.00 V	308	10.03	12.60
3	113.59	34.31 QP	43.50	-9.19	1.00 V	16	24.81	9.50
4	249.66	30.77 QP	46.00	-15.23	1.00 V	10	19.21	11.56
5	374.07	28.87 QP	46.00	-17.13	1.50 V	320	13.02	15.84
6	399.34	29.15 QP	46.00	-16.85	1.00 V	30	12.51	16.64
7	457.66	33.98 QP	46.00	-12.02	1.00 V	61	16.30	17.67
8	465.43	34.42 QP	46.00	-11.58	1.00 V	30	16.57	17.85
9	599.56	32.03 QP	46.00	-13.97	1.00 V	308	11.24	20.80
10	731.74	30.06 QP	46.00	-15.94	1.00 V	42	6.70	23.36
11	801.72	31.00 QP	46.00	-15.00	1.00 V	16	7.00	24.01
12	945.57	33.93 QP	46.00	-12.07	1.00 V	30	6.79	27.14

- REMARKS:**
1. Emission level(dBuV/m)=Raw Value(dBuV) + Correction Factor(dB/m)
  2. Correction Factor(dB/m) = Antenna Factor (dB/m) + Cable Factor (dB)
  3. The other emission levels were very low against the limit.
  4. Margin value = Emission level – Limit value.



### 802.11b DSSS MODULATION

EUT TEST CONDITION		MEASUREMENT DETAIL	
CHANNEL	Channel 1	FREQUENCY RANGE	1 ~ 25GHz
MODULATION TYPE	DBPSK	DETECTOR FUNCTION	Peak (PK) Average (AV)
TRANSFER RATE	1Mbps	ENVIRONMENTAL CONDITIONS	23deg. C, 68%RH, 991hPa
INPUT POWER (SYSTEM)	120Vac, 60 Hz	TEST MODE	E
TESTED BY	Lori Chiu		

ANTENNA POLARITY & TEST DISTANCE: HORIZONTAL AT 3 M								
No.	Freq. (MHz)	Emission Level (dBuV/m)	Limit (dBuV/m)	Margin (dB)	Antenna Height (m)	Table Angle (Degree)	Raw Value (dBuV)	Correction Factor (dB/m)
1	1090.00	38.91 PK	74.00	-35.09	1.31 H	125	11.35	27.57
1	1090.00	28.99 AV	54.00	-25.01	1.31 H	125	1.43	27.57
2	2386.00	71.31 PK	74.00	-2.69	1.06 H	171	40.74	30.57
2	2386.00	50.61 AV	54.00	-3.39	1.06 H	171	20.04	30.57
3	*2412.00	110.42 PK			1.05 H	171	79.76	30.66
3	*2412.00	105.96 AV			1.05 H	171	75.30	30.66
4	4824.00	48.21 PK	74.00	-25.79	1.05 H	273	12.06	36.14
4	4824.00	43.42 AV	54.00	-10.58	1.05 H	273	7.28	36.14

ANTENNA POLARITY & TEST DISTANCE: VERTICAL AT 3 M								
No.	Freq. (MHz)	Emission Level (dBuV/m)	Limit (dBuV/m)	Margin (dB)	Antenna Height (m)	Table Angle (Degree)	Raw Value (dBuV)	Correction Factor (dB/m)
1	1090.00	43.60 PK	74.00	-30.40	1.06 V	136	16.04	27.57
1	1090.00	40.12 AV	54.00	-13.88	1.06 V	136	12.56	27.57
2	2386.00	66.91 PK	74.00	-7.09	1.58 V	7	36.34	30.57
2	2386.00	46.10 AV	54.00	-7.90	1.58 V	7	15.53	30.57
3	*2412.00	102.10 PK			1.02 V	9	71.44	30.66
3	*2412.00	97.58 AV			1.02 V	9	66.92	30.66
4	4824.00	45.67 PK	74.00	-28.33	1.07 V	218	9.53	36.14
4	4824.00	40.11 AV	54.00	-13.89	1.07 V	218	3.96	36.14

- REMARKS:**
1. Emission level (dBuV/m) = Raw Value (dBuV) + Correction Factor (dB/m).
  2. Correction Factor (dB/m) = Antenna Factor (dB/m) + Cable Factor (dB).
  3. The other emission levels were very low against the limit.
  4. Margin value = Emission level – Limit value.
  5. " \* ": Fundamental frequency.

EUT TEST CONDITION		MEASUREMENT DETAIL	
CHANNEL	Channel 6	FREQUENCY RANGE	1 ~ 25GHz
MODULATION TYPE	DBPSK	DETECTOR FUNCTION	Peak (PK) Average (AV)
TRANSFER RATE	1Mbps	ENVIRONMENTAL CONDITIONS	23deg. C, 68%RH, 991hPa
INPUT POWER (SYSTEM)	120Vac, 60 Hz	TEST MODE	E
TESTED BY	Lori Chiu		

ANTENNA POLARITY & TEST DISTANCE: HORIZONTAL AT 3 M								
No.	Freq. (MHz)	Emission Level (dBuV/m)	Limit (dBuV/m)	Margin (dB)	Antenna Height (m)	Table Angle (Degree)	Raw Value (dBuV)	Correction Factor (dB/m)
1	1090.00	38.45 PK	74.00	-35.55	1.42 H	213	10.88	27.57
1	1090.00	28.58 AV	54.00	-25.42	1.42 H	213	1.01	27.57
2	*2437.00	110.31 PK			1.26 H	150	79.56	30.75
2	*2437.00	105.76 AV			1.26 H	150	75.01	30.75
3	4874.00	48.24 PK	74.00	-25.76	1.12 H	251	11.99	36.25
3	4874.00	43.37 AV	54.00	-10.63	1.12 H	251	7.12	36.25

ANTENNA POLARITY & TEST DISTANCE: VERTICAL AT 3 M								
No.	Freq. (MHz)	Emission Level (dBuV/m)	Limit (dBuV/m)	Margin (dB)	Antenna Height (m)	Table Angle (Degree)	Raw Value (dBuV)	Correction Factor (dB/m)
1	1090.00	46.21 PK	74.00	-27.79	1.16 V	175	18.64	27.57
1	1090.00	40.10 AV	54.00	-13.90	1.16 V	175	12.53	27.57
2	*2437.00	102.11 PK			1.35 V	225	71.36	30.75
2	*2437.00	97.49 AV			1.35 V	225	66.74	30.75
3	4874.00	45.20 PK	74.00	-28.80	1.21 V	274	8.95	36.25
3	4874.00	40.38 AV	54.00	-13.62	1.21 V	274	4.13	36.25

- REMARKS:**
1. Emission level (dBuV/m) = Raw Value (dBuV) + Correction Factor (dB/m).
  2. Correction Factor (dB/m) = Antenna Factor (dB/m) + Cable Factor (dB).
  3. The other emission levels were very low against the limit.
  4. Margin value = Emission level – Limit value.
  5. " \* ": Fundamental frequency.

EUT TEST CONDITION		MEASUREMENT DETAIL	
CHANNEL	Channel 11	FREQUENCY RANGE	1 ~ 25GHz
MODULATION TYPE	DBPSK	DETECTOR FUNCTION	Peak (PK) Average (AV)
TRANSFER RATE	1Mbps	ENVIRONMENTAL CONDITIONS	23deg. C, 68%RH, 991hPa
INPUT POWER (SYSTEM)	120Vac, 60 Hz	TEST MODE	E
TESTED BY	Lori Chiu		

ANTENNA POLARITY & TEST DISTANCE: HORIZONTAL AT 3 M								
No.	Freq. (MHz)	Emission Level (dBuV/m)	Limit (dBuV/m)	Margin (dB)	Antenna Height (m)	Table Angle (Degree)	Raw Value (dBuV)	Correction Factor (dB/m)
1	1090.00	38.21 PK	74.00	-35.79	1.40 H	137	10.64	27.57
1	1090.00	28.57 AV	54.00	-25.43	1.40 H	137	1.00	27.57
2	*2462.00	110.35 PK			1.28 H	166	79.52	30.83
2	*2462.00	105.90 AV			1.28 H	166	75.07	30.83
3	2489.00	69.76 PK	74.00	-4.24	1.28 H	166	38.84	30.92
3	2489.00	50.16 AV	54.00	-3.84	1.28 H	166	19.24	30.92
4	4924.00	48.42 PK	74.00	-25.58	1.32 H	167	12.05	36.37
4	4924.00	43.29 AV	54.00	-10.71	1.32 H	167	6.92	36.37

ANTENNA POLARITY & TEST DISTANCE: VERTICAL AT 3 M								
No.	Freq. (MHz)	Emission Level (dBuV/m)	Limit (dBuV/m)	Margin (dB)	Antenna Height (m)	Table Angle (Degree)	Raw Value (dBuV)	Correction Factor (dB/m)
1	1090.00	43.57 PK	74.00	-30.43	1.06 V	255	16.00	27.57
1	1090.00	40.05 AV	54.00	-13.95	1.06 V	255	12.48	27.57
2	*2462.00	102.08 PK			1.42 V	333	71.25	30.83
2	*2462.00	97.42 AV			1.42 V	333	66.59	30.83
3	2489.00	67.72 PK	74.00	-6.28	1.43 V	331	36.80	30.92
3	2489.00	46.24 AV	54.00	-7.76	1.43 V	331	15.32	30.92
4	4924.00	45.58 PK	74.00	-28.42	1.11 V	57	9.21	36.37
4	4924.00	40.05 AV	54.00	-13.95	1.11 V	57	3.68	36.37

- REMARKS:**
1. Emission level (dBuV/m) = Raw Value (dBuV) + Correction Factor (dB/m).
  2. Correction Factor (dB/m) = Antenna Factor (dB/m) + Cable Factor (dB).
  3. The other emission levels were very low against the limit.
  4. Margin value = Emission level – Limit value.
  5. “ \* “: Fundamental frequency.

### 802.11g OFDM MODULATION

EUT TEST CONDITION		MEASUREMENT DETAIL	
CHANNEL	Channel 1	FREQUENCY RANGE	1 ~ 25GHz
MODULATION TYPE	BPSK	DETECTOR FUNCTION	Peak (PK) Average (AV)
TRANSFER RATE	6Mbps	ENVIRONMENTAL CONDITIONS	23deg. C, 68%RH, 991hPa
INPUT POWER (SYSTEM)	120Vac, 60 Hz	TEST MODE	E
TESTED BY	Lori Chiu		

#### ANTENNA POLARITY & TEST DISTANCE: HORIZONTAL AT 3 M

No.	Freq. (MHz)	Emission Level (dBuV/m)	Limit (dBuV/m)	Margin (dB)	Antenna Height (m)	Table Angle (Degree)	Raw Value (dBuV)	Correction Factor (dB/m)
1	1152.00	39.92 PK	74.00	-34.08	1.12 H	267	12.49	27.43
1	1152.00	29.79 AV	54.00	-24.21	1.12 H	267	2.36	27.43
2	2390.00	72.74 PK	74.00	-1.26	1.04 H	171	41.53	31.21
<b>2</b>	<b>2390.00</b>	<b>52.80 AV</b>	<b>54.00</b>	<b>-1.20</b>	<b>1.04 H</b>	<b>171</b>	<b>21.59</b>	<b>31.21</b>
3	*2412.00	109.37 PK			1.04 H	171	78.17	31.20
3	*2412.00	99.27 AV			1.04 H	171	68.07	31.20
4	4824.00	46.46 PK	74.00	-27.54	1.04 H	90	10.03	36.42
4	4824.00	33.42 AV	54.00	-20.58	1.04 H	90	-3.00	36.42

#### ANTENNA POLARITY & TEST DISTANCE: VERTICAL AT 3 M

No.	Freq. (MHz)	Emission Level (dBuV/m)	Limit (dBuV/m)	Margin (dB)	Antenna Height (m)	Table Angle (Degree)	Raw Value (dBuV)	Correction Factor (dB/m)
1	1150.00	40.98 PK	74.00	-33.02	1.00 V	141	13.55	27.43
1	1150.00	34.56 AV	54.00	-19.44	1.00 V	141	7.13	27.43
2	2390.00	71.86 PK	74.00	-2.14	1.00 V	317	40.65	31.21
2	2390.00	49.63 AV	54.00	-4.37	1.00 V	317	18.42	31.21
3	*2412.00	103.04 PK			1.00 V	83	71.84	31.20
3	*2412.00	92.83 AV			1.00 V	83	61.63	31.20
4	4824.00	46.51 PK	74.00	-27.49	1.10 V	108	10.09	36.42
4	4824.00	33.24 AV	54.00	-20.76	1.10 V	108	-3.18	36.42

- REMARKS:**
1. Emission level (dBuV/m) = Raw Value (dBuV) + Correction Factor (dB/m).
  2. Correction Factor (dB/m) = Antenna Factor (dB/m) + Cable Factor (dB).
  3. The other emission levels were very low against the limit.
  4. Margin value = Emission level – Limit value.
  5. “ \* “: Fundamental frequency.

EUT TEST CONDITION		MEASUREMENT DETAIL	
CHANNEL	Channel 6	FREQUENCY RANGE	1 ~ 25GHz
MODULATION TYPE	BPSK	DETECTOR FUNCTION	Peak (PK) Average (AV)
TRANSFER RATE	6Mbps	ENVIRONMENTAL CONDITIONS	23deg. C, 68%RH, 991hPa
INPUT POWER (SYSTEM)	120Vac, 60 Hz	TEST MODE	E
TESTED BY	Lori Chiu		

ANTENNA POLARITY & TEST DISTANCE: HORIZONTAL AT 3 M								
No.	Freq. (MHz)	Emission Level (dBuV/m)	Limit (dBuV/m)	Margin (dB)	Antenna Height (m)	Table Angle (Degree)	Raw Value (dBuV)	Correction Factor (dB/m)
1	1152.00	40.10 PK	74.00	-33.90	1.21 H	254	12.40	27.70
1	1152.00	29.91 AV	54.00	-24.09	1.21 H	254	2.21	27.70
2	2390.00	55.57 PK	74.00	-18.43	1.30 H	168	24.98	30.59
2	2390.00	44.82 AV	54.00	-9.18	1.30 H	168	14.23	30.59
3	*2437.00	109.32 PK			1.29 H	167	78.57	30.75
3	*2437.00	98.88 AV			1.29 H	167	68.13	30.75
4	2483.50	55.93 PK	74.00	-18.07	1.29 H	168	25.03	30.90
4	2483.50	45.40 AV	54.00	-8.60	1.29 H	168	14.50	30.90
5	4874.00	46.26 PK	74.00	-27.74	1.20 H	318	10.01	36.25
5	4874.00	33.15 AV	54.00	-20.85	1.20 H	318	-3.10	36.25

ANTENNA POLARITY & TEST DISTANCE: VERTICAL AT 3 M								
No.	Freq. (MHz)	Emission Level (dBuV/m)	Limit (dBuV/m)	Margin (dB)	Antenna Height (m)	Table Angle (Degree)	Raw Value (dBuV)	Correction Factor (dB/m)
1	1152.00	40.85 PK	74.00	-33.15	1.11 V	210	13.15	27.70
1	1152.00	34.61 AV	54.00	-19.39	1.11 V	210	6.91	27.70
2	*2437.00	102.98 PK			1.01 V	152	72.23	30.75
2	*2437.00	92.67 AV			1.01 V	152	61.92	30.75
3	4874.00	46.12 PK	74.00	-27.88	1.08 V	245	9.87	36.25
3	4874.00	33.01 AV	54.00	-20.99	1.08 V	245	-3.24	36.25

- REMARKS:**
1. Emission level (dBuV/m) = Raw Value (dBuV) + Correction Factor (dB/m).
  2. Correction Factor (dB/m) = Antenna Factor (dB/m) + Cable Factor (dB).
  3. The other emission levels were very low against the limit.
  4. Margin value = Emission level – Limit value.
  5. “ \* “: Fundamental frequency.

EUT TEST CONDITION		MEASUREMENT DETAIL	
CHANNEL	Channel 11	FREQUENCY RANGE	1 ~ 25GHz
MODULATION TYPE	BPSK	DETECTOR FUNCTION	Peak (PK) Average (AV)
TRANSFER RATE	6Mbps	ENVIRONMENTAL CONDITIONS	23deg. C, 68%RH, 991hPa
INPUT POWER (SYSTEM)	120Vac, 60 Hz	TEST MODE	E
TESTED BY	Lori Chiu		

ANTENNA POLARITY & TEST DISTANCE: HORIZONTAL AT 3 M								
No.	Freq. (MHz)	Emission Level (dBuV/m)	Limit (dBuV/m)	Margin (dB)	Antenna Height (m)	Table Angle (Degree)	Raw Value (dBuV)	Correction Factor (dB/m)
1	1152.00	40.01 PK	74.00	-33.99	1.08 H	285	12.31	27.70
1	1152.00	29.86 AV	54.00	-24.14	1.08 H	285	2.16	27.70
2	*2462.00	108.97 PK			1.26 H	167	78.14	30.83
2	*2462.00	98.47 AV			1.26 H	167	67.64	30.83
3	2483.50	71.87 PK	74.00	-2.13	1.27 H	166	40.97	30.90
3	2483.50	52.12 AV	54.00	-1.88	1.27 H	166	21.22	30.90
4	4924.00	46.37 PK	74.00	-27.63	1.22 H	11	10.00	36.37
4	4924.00	33.31 AV	54.00	-20.69	1.22 H	11	-3.06	36.37

ANTENNA POLARITY & TEST DISTANCE: VERTICAL AT 3 M								
No.	Freq. (MHz)	Emission Level (dBuV/m)	Limit (dBuV/m)	Margin (dB)	Antenna Height (m)	Table Angle (Degree)	Raw Value (dBuV)	Correction Factor (dB/m)
1	1152.00	40.76 PK	74.00	-33.24	1.00 V	127	13.06	27.70
1	1152.00	34.35 AV	54.00	-19.65	1.00 V	127	6.65	27.70
2	*2462.00	102.49 PK			1.46 V	324	71.66	30.83
2	*2462.00	92.03 AV			1.46 V	324	61.20	30.83
3	2483.50	68.15 PK	74.00	-5.85	1.42 V	324	37.25	30.90
3	2483.50	49.01 AV	54.00	-4.99	1.42 V	324	18.11	30.90
4	4924.00	46.12 PK	74.00	-27.88	1.41 V	265	9.75	36.37
4	4924.00	33.27 AV	54.00	-20.73	1.41 V	265	-3.10	36.37

- REMARKS:**
1. Emission level (dBuV/m) = Raw Value (dBuV) + Correction Factor (dB/m).
  2. Correction Factor (dB/m) = Antenna Factor (dB/m) + Cable Factor (dB).
  3. The other emission levels were very low against the limit.
  4. Margin value = Emission level – Limit value.
  5. “ \* “: Fundamental frequency.



## 4.3 6dB BANDWIDTH MEASUREMENT

### 4.3.1 LIMITS OF 6dB BANDWIDTH MEASUREMENT

The minimum of 6dB Bandwidth Measurement is 0.5 MHz.

### 4.3.2 TEST INSTRUMENTS

DESCRIPTION & MANUFACTURER	MODEL NO.	SERIAL NO.	CALIBRATED UNTIL
SPECTRUM ANALYZER	FSP40	100040	Jun. 07, 2007

**NOTE:** The calibration interval of the above test instruments is 12 months and the calibrations are traceable to NML/ROC and NIST/USA.

### 4.3.3 TEST PROCEDURE

The transmitter output was connected to the spectrum analyzer through an attenuator. The bandwidth of the fundamental frequency was measured by spectrum analyzer with 100kHz RBW and 100kHz VBW. The 6dB bandwidth is defined as the total spectrum the power of which is higher than peak power minus 6dB.

### 4.3.4 DEVIATION FROM TEST STANDARD

No deviation

#### 4.3.5 TEST SETUP

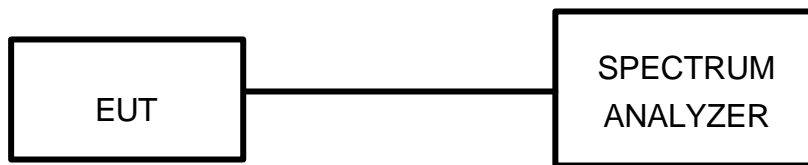

#### 4.3.6 EUT OPERATING CONDITIONS

The software provided by client to enable the EUT under transmission condition continuously at lowest, middle and highest channel frequencies individually.





### 4.3.7 TEST RESULTS

#### 802.11b DSSS MODULATION

<b>MODULATION TYPE</b>	DBPSK	<b>TRANSFER RATE</b>	1Mbps
<b>INPUT POWER (SYSTEM)</b>	120Vac, 60 Hz	<b>ENVIRONMENTAL CONDITIONS</b>	23deg. C, 68%RH, 991hPa
<b>TESTED BY</b>	Long Chen		

<b>CHANNEL</b>	<b>CHANNEL FREQUENCY (MHz)</b>	<b>6dB BANDWIDTH (MHz)</b>	<b>MINIMUM LIMIT (MHz)</b>	<b>PASS/FAIL</b>
1	2412	10.08	0.5	PASS
6	2437	10.12	0.5	PASS
11	2462	10.12	0.5	PASS

CH1

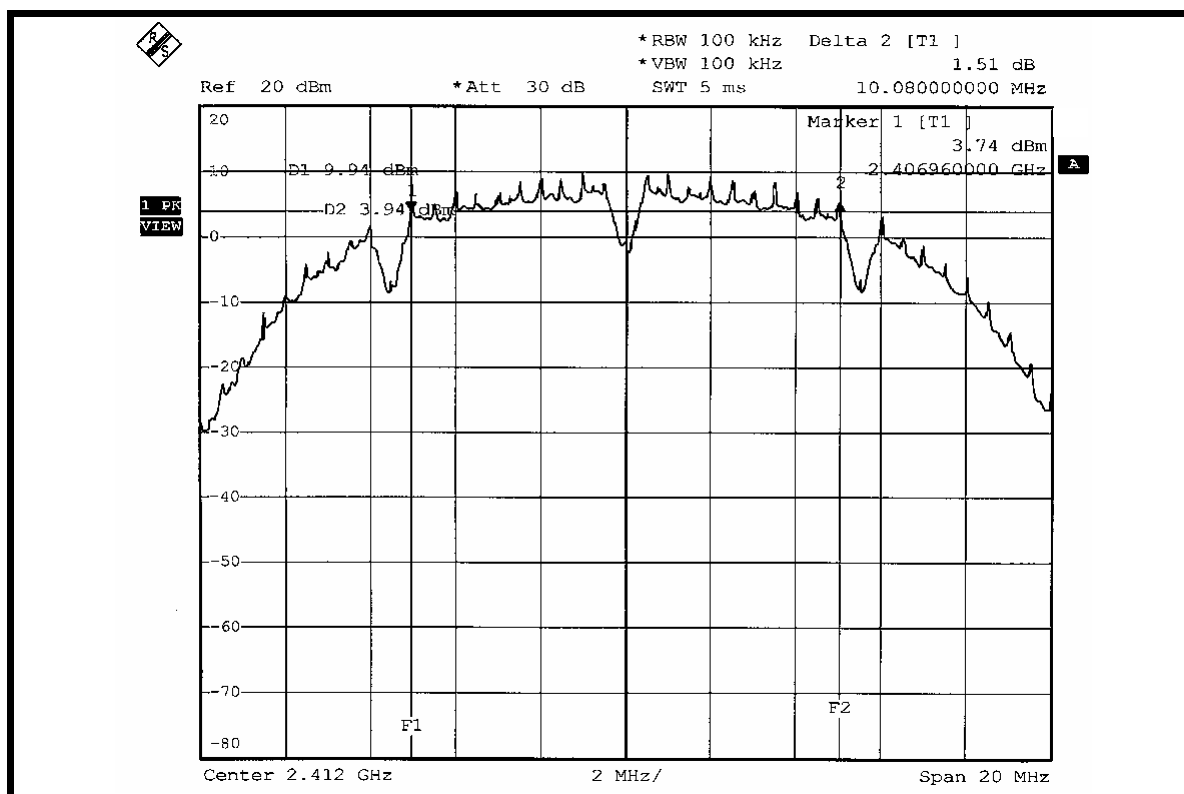

CH6

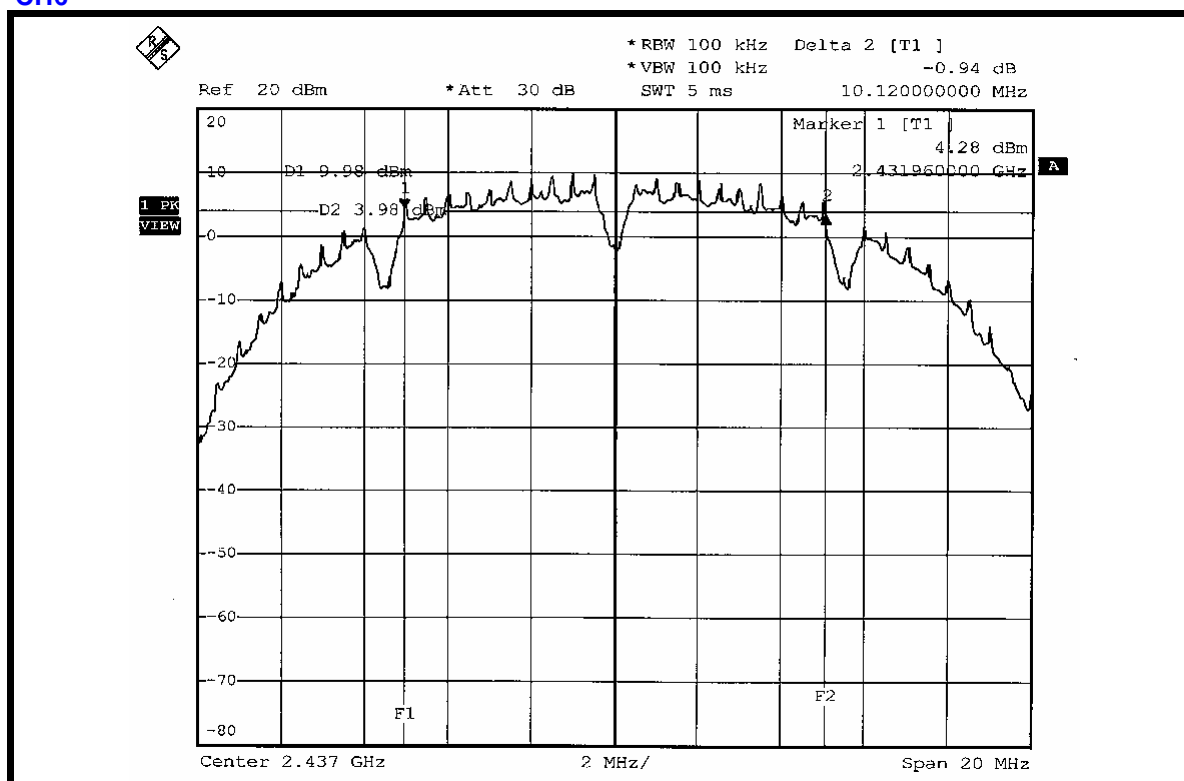

CH11

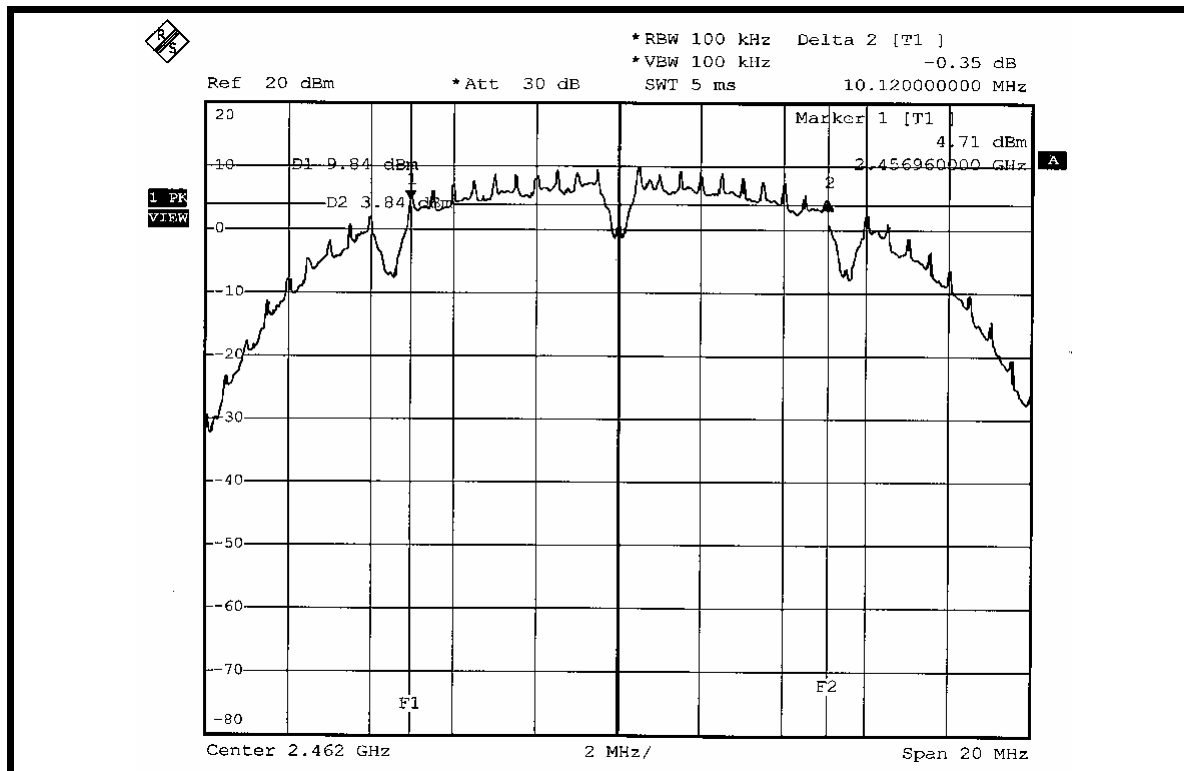



### 802.11g OFDM MODULATION

<b>MODULATION TYPE</b>	BPSK	<b>TRANSFER RATE</b>	6Mbps
<b>INPUT POWER (SYSTEM)</b>	120Vac, 60 Hz	<b>ENVIRONMENTAL CONDITIONS</b>	23deg. C, 68%RH, 991hPa
<b>TESTED BY</b>	Long Chen		

<b>CHANNEL</b>	<b>CHANNEL FREQUENCY (MHz)</b>	<b>6dB BANDWIDTH (MHz)</b>	<b>MINIMUM LIMIT (MHz)</b>	<b>PASS/FAIL</b>
1	2412	16.40	0.5	PASS
6	2437	16.40	0.5	PASS
11	2462	16.40	0.5	PASS

CH1

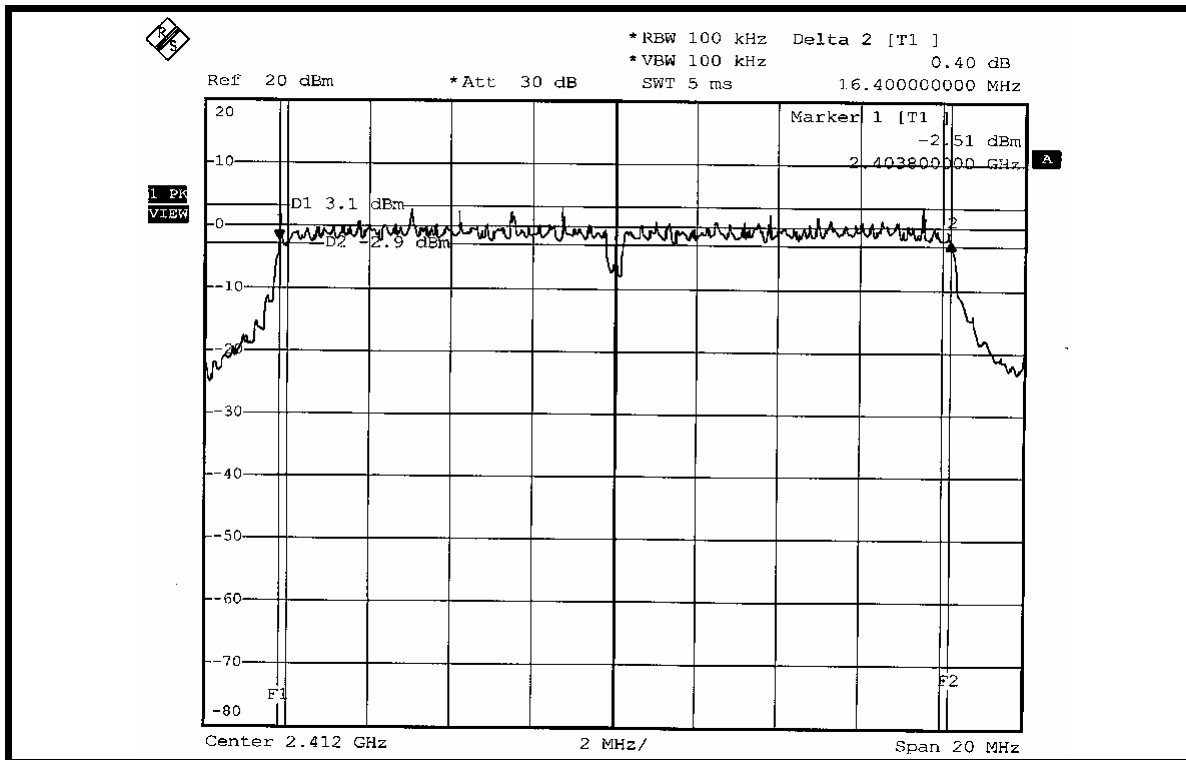

CH6

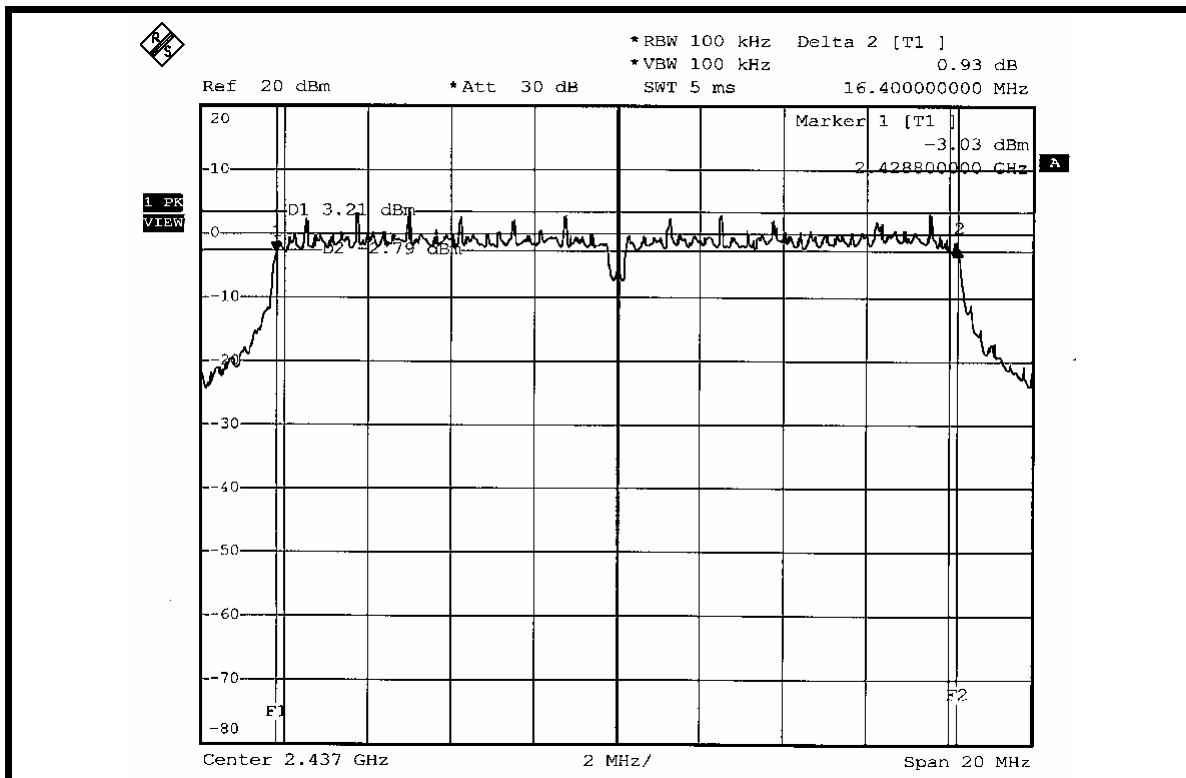

CH11

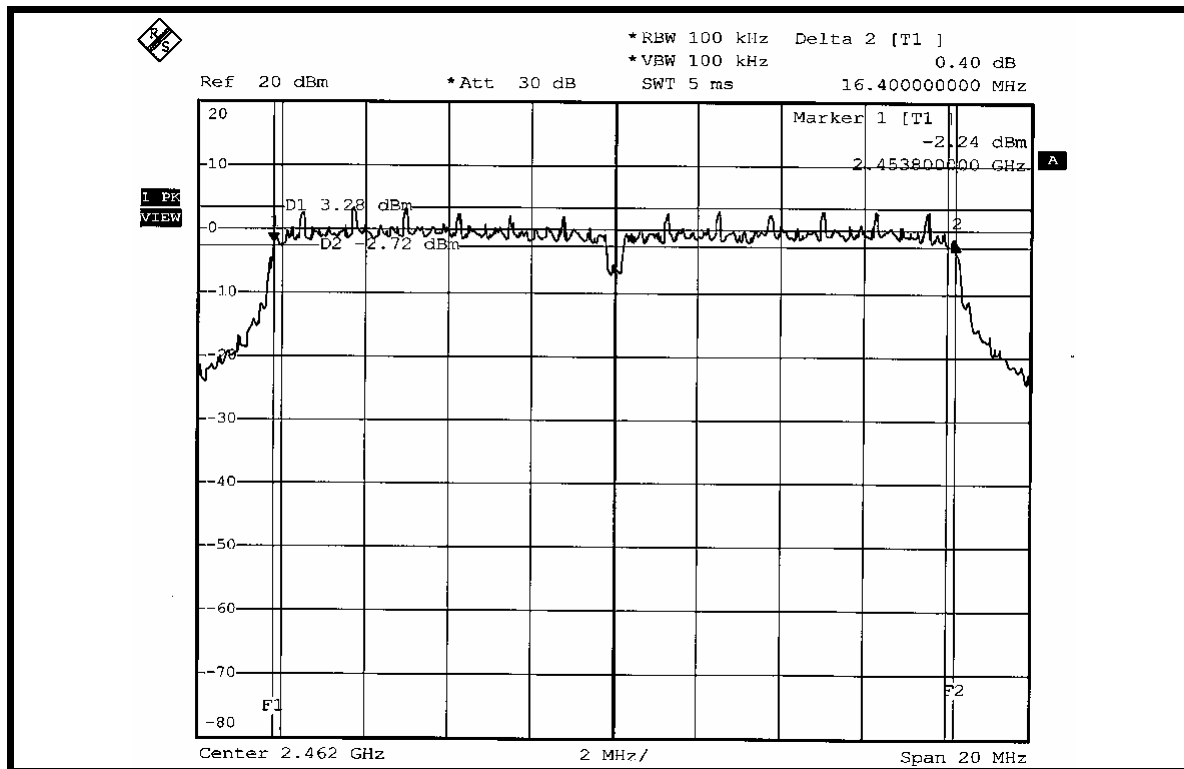



#### 4.4 MAXIMUM PEAK OUTPUT POWER

##### 4.4.1 LIMITS OF MAXIMUM PEAK OUTPUT POWER MEASUREMENT

The Maximum Peak Output Power Measurement is 30dBm.

##### 4.4.2 TEST INSTRUMENTS

DESCRIPTION & MANUFACTURER	MODEL NO.	SERIAL NO.	CALIBRATED UNTIL
R&S SPECTRUM ANALYZER	FSP40	100040	Jun. 07, 2007
AGILENT SIGNAL GENERATOR	E8257C	MY43320668	Dec. 07, 2006
DIGITAL RT OSCILLOSCOPE	TDS1012	C037299	Nov. 28, 2006
NARDA DETECTOR	4503A	FSCM99899	NA

**NOTE:** The calibration interval of the above test instruments is 12 months and the calibrations are traceable to NML/ROC and NIST/USA.

#### 4.4.3 TEST PROCEDURES

1. A detector was used on the output port of the EUT. An oscilloscope was used to read the response of the detector.
2. Replaced the EUT by the signal generator. The center frequency of the S.G was adjusted to the center frequency of the measured channel.
3. Adjusted the power to have the same reading on oscilloscope. Record the power level.

#### 4.4.4 DEVIATION FROM TEST STANDARD

No deviation

#### 4.4.5 TEST SETUP



#### 4.4.6 EUT OPERATING CONDITIONS

Same as Item 4.3.6



#### 4.4.7 TEST RESULTS

##### 802.11b DSSS MODULATION

<b>MODULATION TYPE</b>	DBPSK	<b>TRANSFER RATE</b>	1Mbps
<b>INPUT POWER (SYSTEM)</b>	120Vac, 60 Hz	<b>ENVIRONMENTAL CONDITIONS</b>	23deg. C, 68%RH, 991hPa
<b>TESTED BY</b>	Long Chen		

CHANNEL	CHANNEL FREQUENCY (MHz)	PEAK POWER OUTPUT (mW)	PEAK POWER OUTPUT (dBm)	PEAK POWER LIMIT (dBm)	PASS/FAIL
1	2412	79.433	19.00	30	PASS
6	2437	80.353	19.05	30	PASS
11	2462	79.616	19.01	30	PASS

##### 802.11g OFDM MODULATION

<b>MODULATION TYPE</b>	BPSK	<b>TRANSFER RATE</b>	6Mbps
<b>INPUT POWER (SYSTEM)</b>	120Vac, 60 Hz	<b>ENVIRONMENTAL CONDITIONS</b>	23deg. C, 68%RH, 991hPa
<b>TESTED BY</b>	Long Chen		

CHANNEL	CHANNEL FREQUENCY (MHz)	PEAK POWER OUTPUT (mW)	PEAK POWER OUTPUT (dBm)	PEAK POWER LIMIT (dBm)	PASS/FAIL
1	2412	79.983	19.03	30	PASS
6	2437	80.353	19.05	30	PASS
11	2462	79.616	19.01	30	PASS



## 4.5 POWER SPECTRAL DENSITY MEASUREMENT

### 4.5.1 LIMITS OF POWER SPECTRAL DENSITY MEASUREMENT

The Maximum of Power Spectral Density Measurement is 8dBm.

### 4.5.2 TEST INSTRUMENTS

DESCRIPTION & MANUFACTURER	MODEL NO.	SERIAL NO.	CALIBRATED UNTIL
R&S SPECTRUM ANALYZER	FSP40	100040	Jun. 07, 2007

**NOTE:** The calibration interval of the above test instruments is 12 months and the calibrations are traceable to NML/ROC and NIST/USA.

#### 4.5.3 TEST PROCEDURE

The transmitter output was connected to the spectrum analyzer through an attenuator, the bandwidth of the fundamental frequency was measured with the spectrum analyzer using 3kHz RBW and 30kHz VBW, set sweep time = span/3kHz. The power spectral density was measured and recorded.

The sweep time is allowed to be longer than span/3kHz for a full response of the mixer in the spectrum analyzer.

#### 4.5.4 DEVIATION FROM TEST STANDARD

No deviation

#### 4.5.5 TEST SETUP

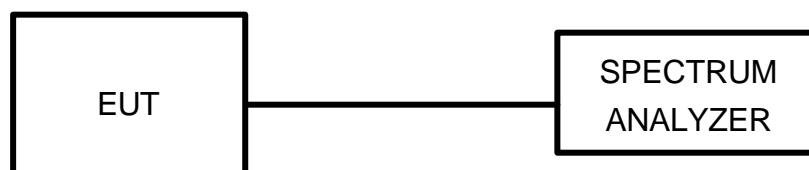

#### 4.5.6 EUT OPERATING CONDITION

Same as Item 4.3.6



#### 4.5.7 TEST RESULTS

##### 802.11b DSSS MODULATION

<b>MODULATION TYPE</b>	DBPSK	<b>TRANSFER RATE</b>	1Mbps
<b>INPUT POWER (SYSTEM)</b>	120Vac, 60 Hz	<b>ENVIRONMENTAL CONDITIONS</b>	23deg. C, 68%RH, 991hPa
<b>TESTED BY</b>	Long Chen		

<b>CHANNEL</b>	<b>CHANNEL FREQUENCY (MHz )</b>	<b>RF POWER LEVEL IN 3kHz BW (dBm)</b>	<b>MAXIMUM LIMIT (dBm)</b>	<b>PASS/FAIL</b>
1	2412	-3.61	8	PASS
6	2437	-3.55	8	PASS
11	2462	-3.74	8	PASS

CH1

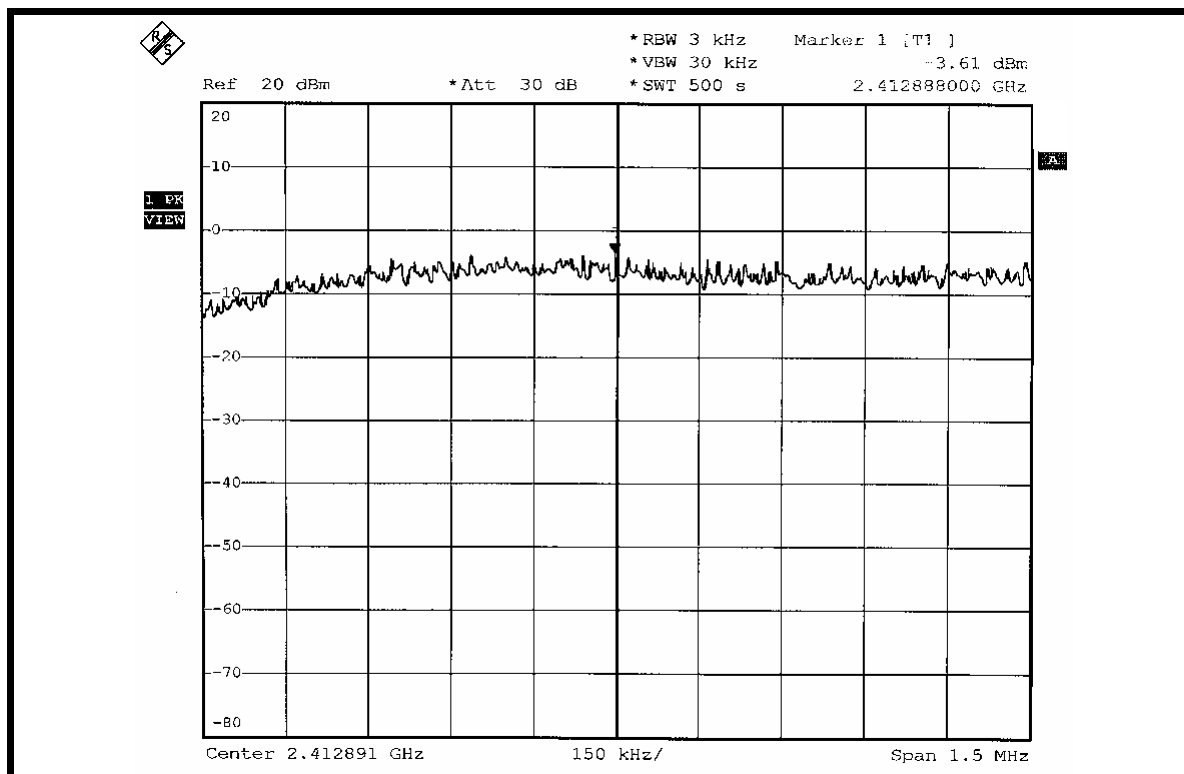

CH6

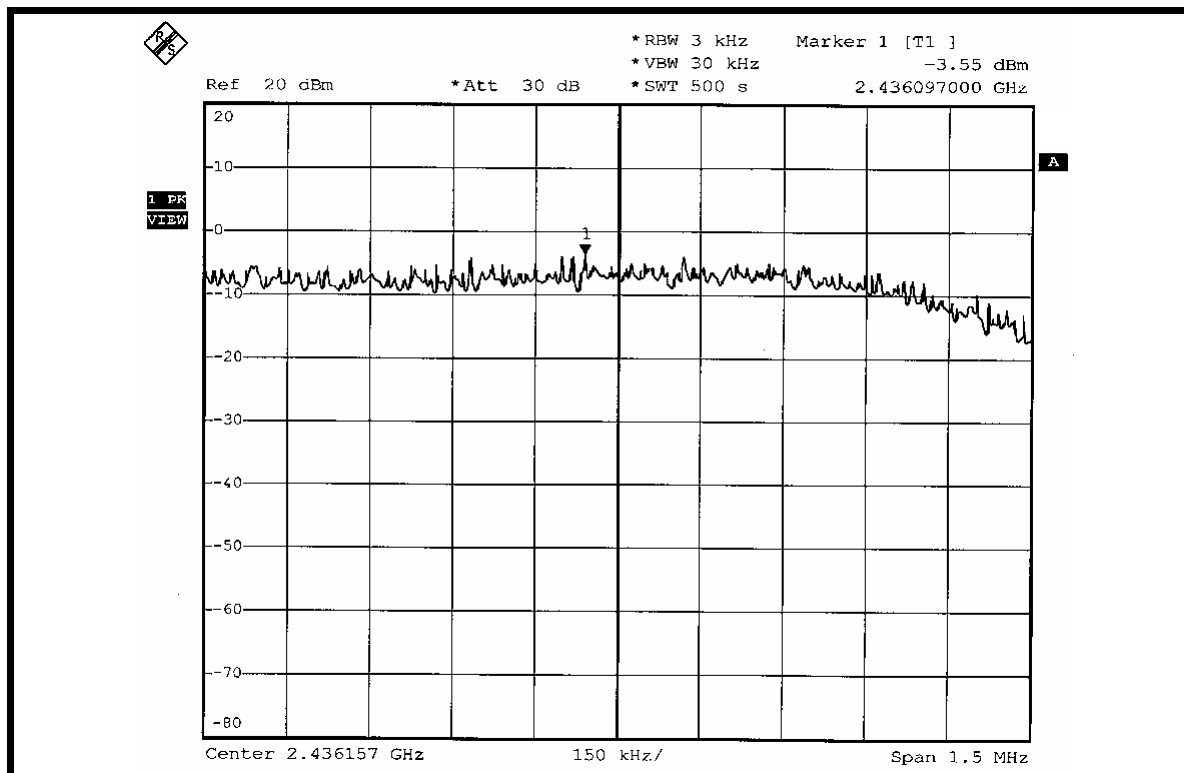





### 802.11g OFDM MODULATION

<b>MODULATION TYPE</b>	BPSK	<b>TRANSFER RATE</b>	6Mbps
<b>INPUT POWER (SYSTEM)</b>	120Vac, 60 Hz	<b>ENVIRONMENTAL CONDITIONS</b>	23deg. C, 68%RH, 991hPa
<b>TESTED BY</b>	Long Chen		

<b>CHANNEL</b>	<b>CHANNEL FREQUENCY (MHz )</b>	<b>RF POWER LEVEL IN 3kHz BW (dBm)</b>	<b>MAXIMUM LIMIT (dBm)</b>	<b>PASS/FAIL</b>
1	2412	-10.44	8	PASS
6	2437	-10.49	8	PASS
11	2462	-10.33	8	PASS

### CH1

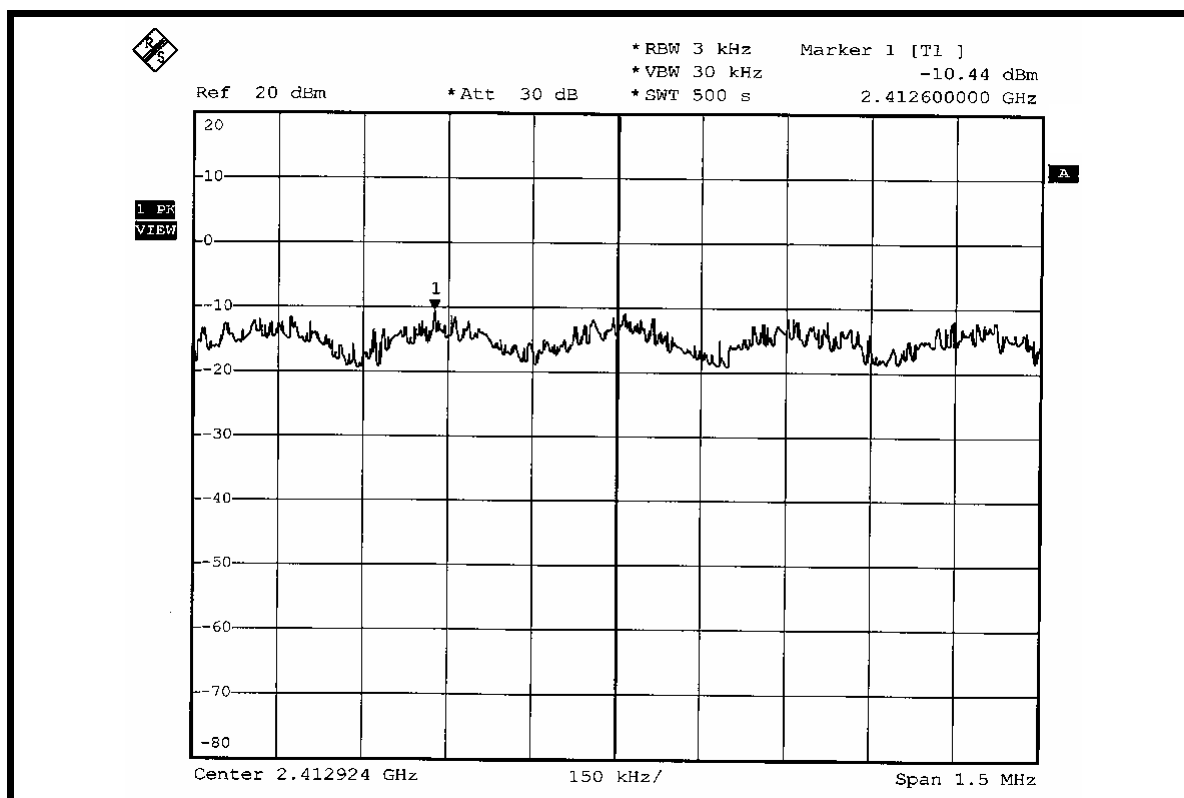

### CH6

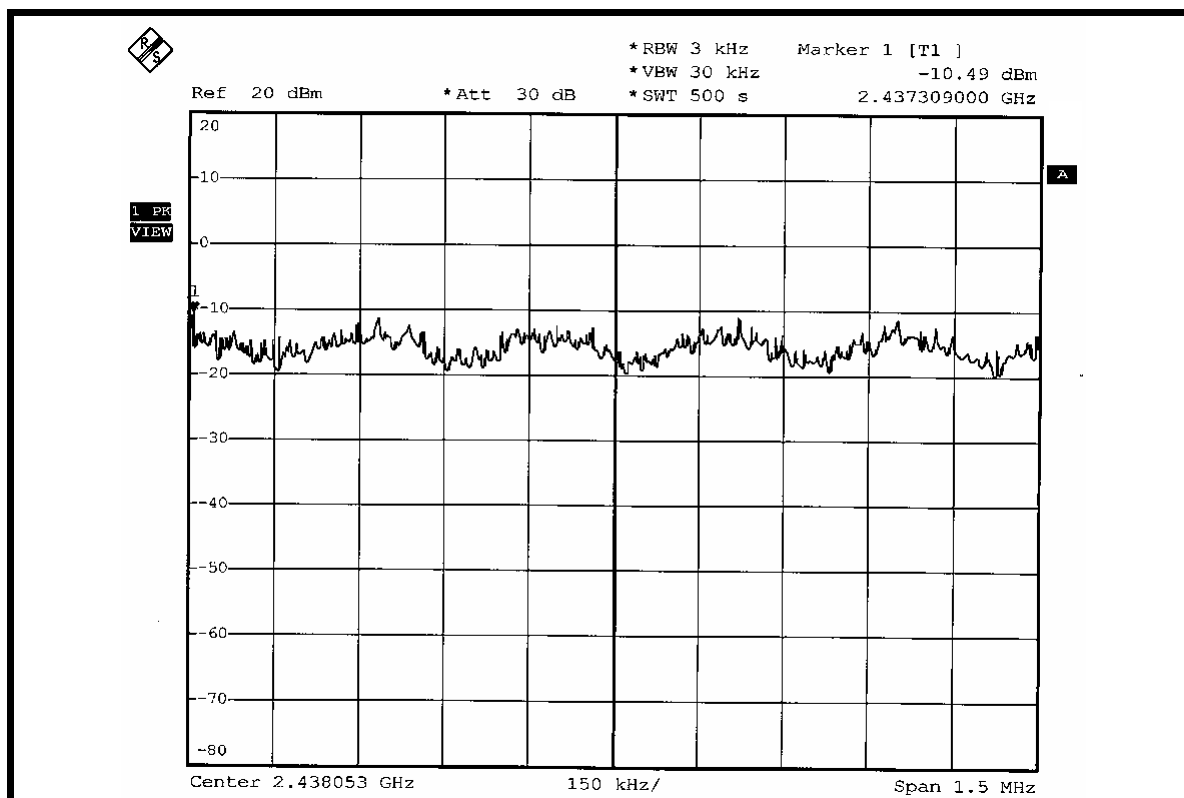



CH11

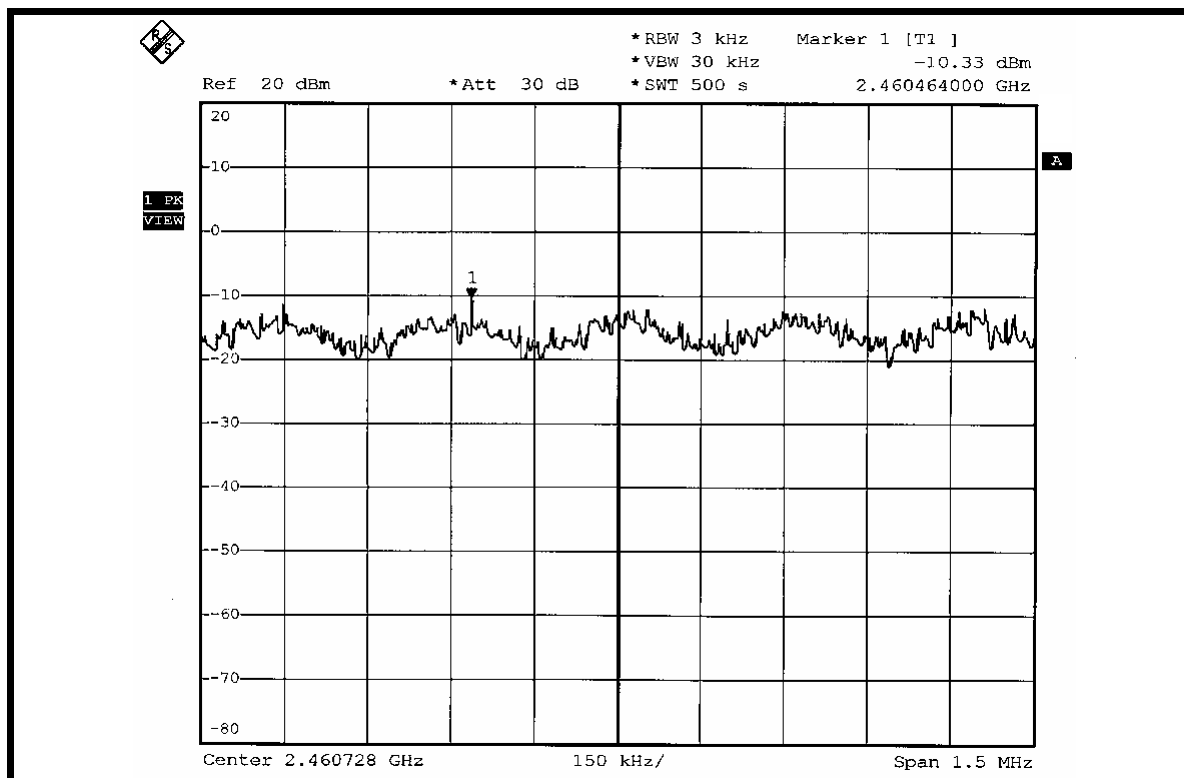



## 4.6 BAND EDGES MEASUREMENT

### 4.6.1 LIMITS OF BAND EDGES MEASUREMENT

Below  $-20\text{dB}$  of the highest emission level of operating band (in 100kHz Resolution Bandwidth).

### 4.6.2 TEST INSTRUMENTS

DESCRIPTION &	MODEL NO.	SERIAL NO.	CALIBRATED UNTIL
R&S SPECTRUM ANALYZER	FSP40	100040	Jun. 07, 2007

**NOTE:** The calibration interval of the above test instruments is 12 months and the calibrations are traceable to NML/ROC and NIST/USA.

### 4.6.3 TEST PROCEDURE

The transmitter output was connected to the spectrum analyzer via a low lose cable. Set both RBW and VBW of spectrum analyzer to 100 kHz and 100 kHz with suitable frequency span including 100 MHz bandwidth from band edge. The band edges was measured and recorded.

The spectrum plots (Peak RBW=VBW=100kHz; Average RBW=1MHz, VBW=10Hz) are attached on the following pages.

### 4.6.4 DEVIATION FROM TEST STANDARD

No deviation

### 4.6.5 EUT OPERATING CONDITION

Same as Item 4.3.6

#### 4.6.6 TEST RESULTS

The spectrum plots are attached on the following 12 images. D1 line indicates the highest level, and D2 line indicates the 20dB offset below D1. It shows compliance with the requirement in part 15.247(d).

#### 802.11b DSSS MODULATION

**NOTE 1:** The band edge emission plot of DSSS technique on the next page shows 54.02dBc between carrier maximum power and local maximum emission in restrict band (2.38796GHz). The emission of carrier strength list in the test result of channel 1 at the item 4.2.7 is 110.42dBuV/m (Peak), so the maximum field strength in restrict band is  $110.42 - 54.02 = 56.40$ dBuV/m which is under 74dBuV/m limit.

The band edge emission plot of DSSS technique on the next page shows 55.34dBc between carrier maximum power and local maximum emission in restrict band (2.38536GHz). The emission of carrier strength list in the test result of channel 1 at the item 4.2.7 is 105.96dBuV/m (Average), so the maximum field strength in restrict band is  $105.96 - 55.34 = 50.62$ dBuV/m which is under 54dBuV/m limit.

**NOTE 2:** The band edge emission plot of DSSS technique on the next second page shows 50.79dBc between carrier maximum power and local maximum emission in restrict band (2.48418GHz). The emission of carrier strength list in the test result of channel 11 at the item 4.2.7 is 110.35dBuV/m (Peak), so the maximum field strength in restrict band is  $110.35 - 50.79 = 59.56$ dBuV/m which is under 74dBuV/m limit.

The band edge emission plot of DSSS technique on the next third page shows 59.06dBc between carrier maximum power and local maximum emission in restrict band (2.48350GHz). The emission of carrier strength list in the test result of channel 11 at the item 4.2.7 is 105.90dBuV/m (Average), so the maximum field strength in restrict band is  $105.90 - 59.06 = 46.84$ dBuV/m which is under 54dBuV/m limit.

### 802.11b DSSS MODULATION

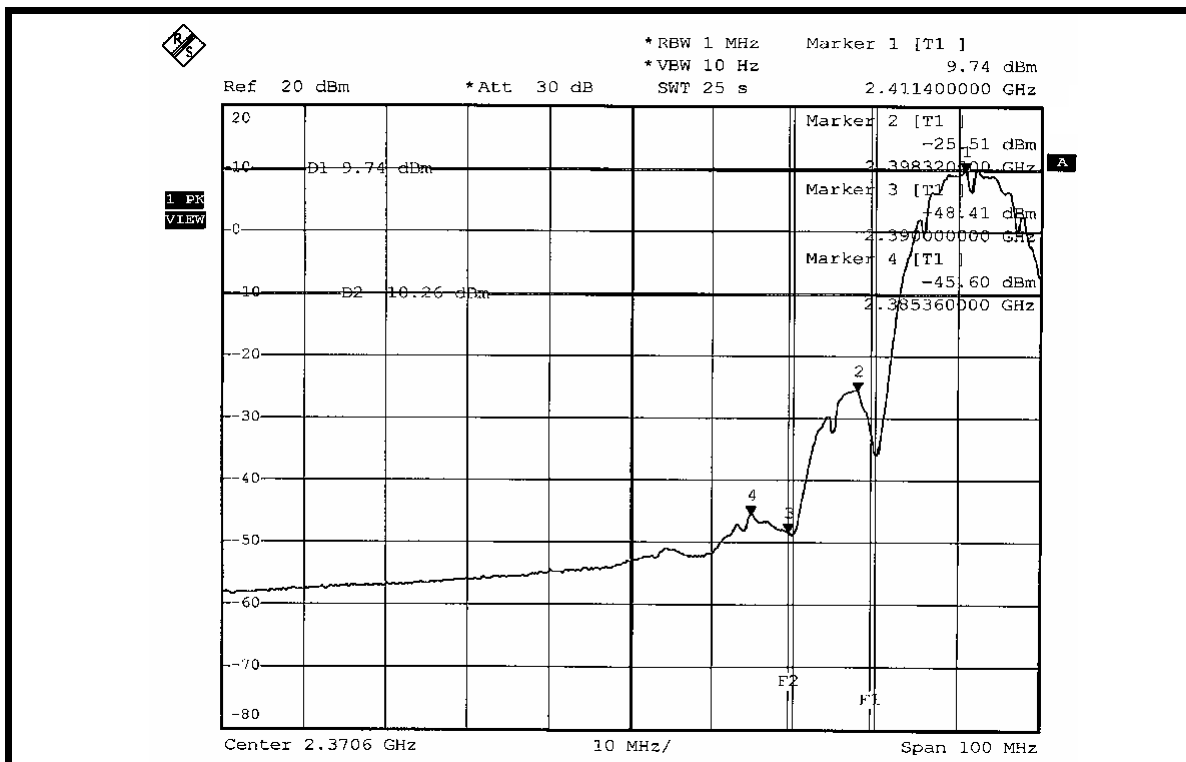
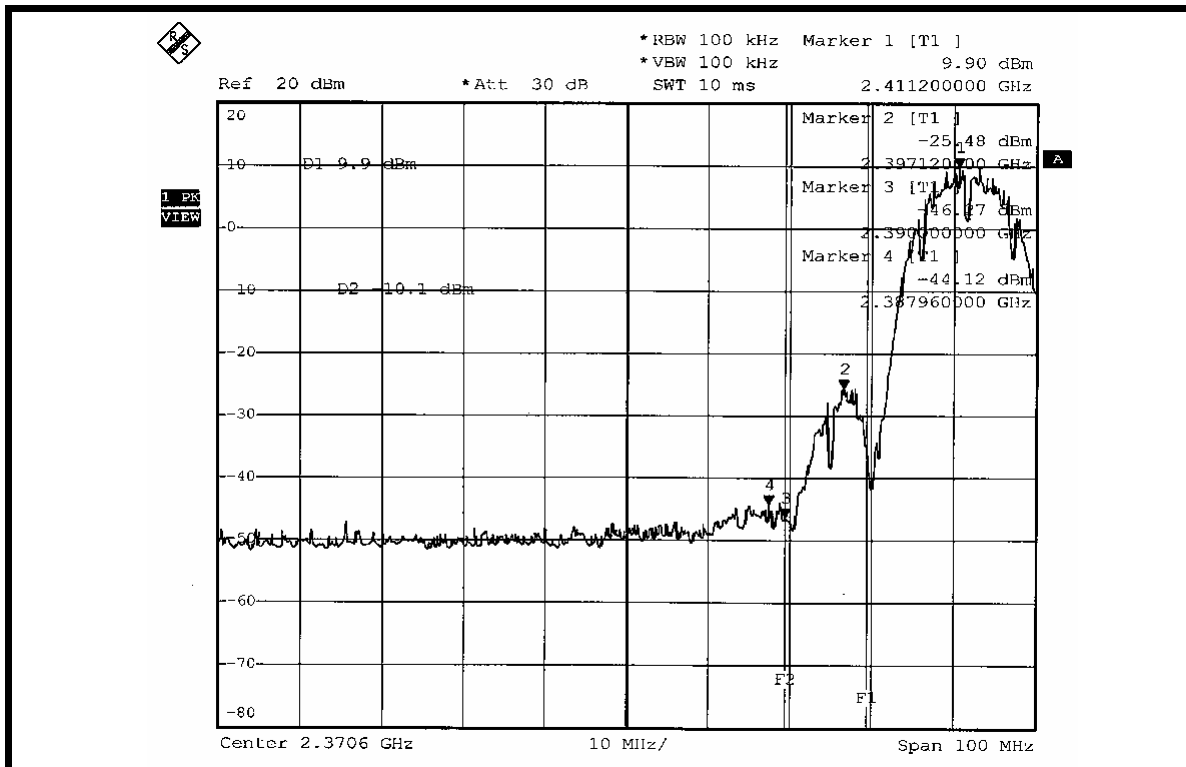

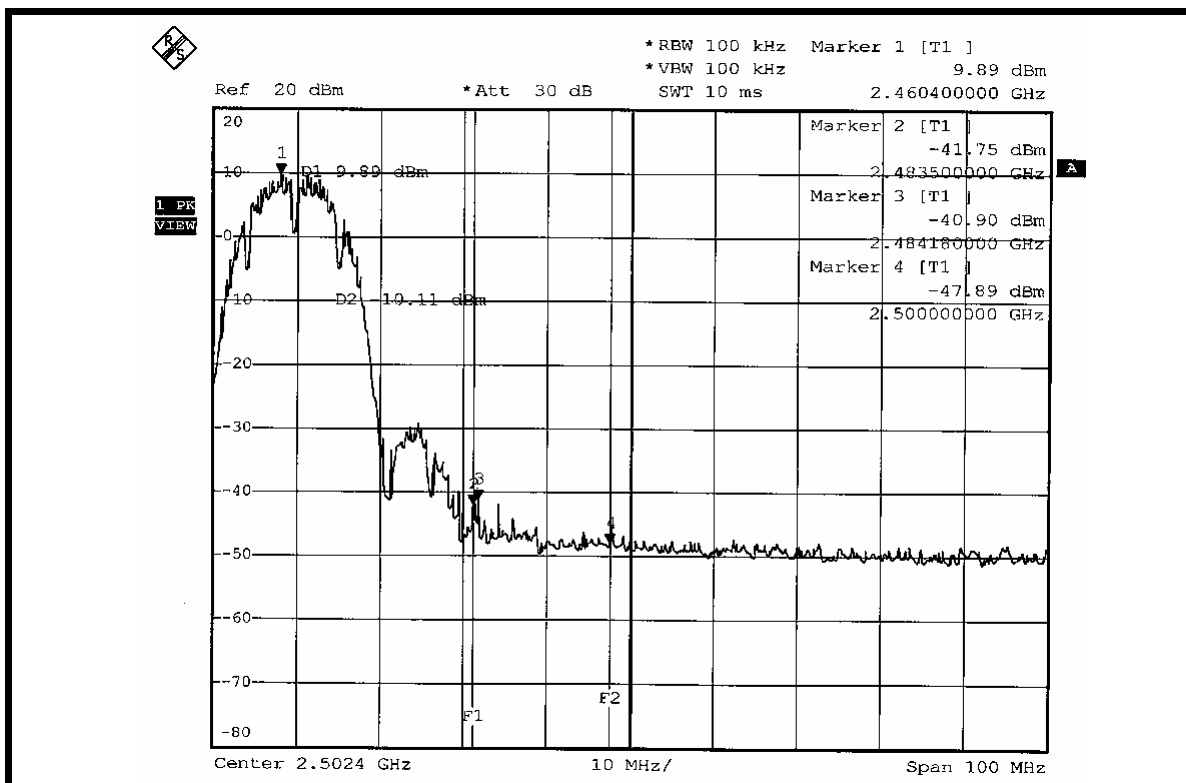
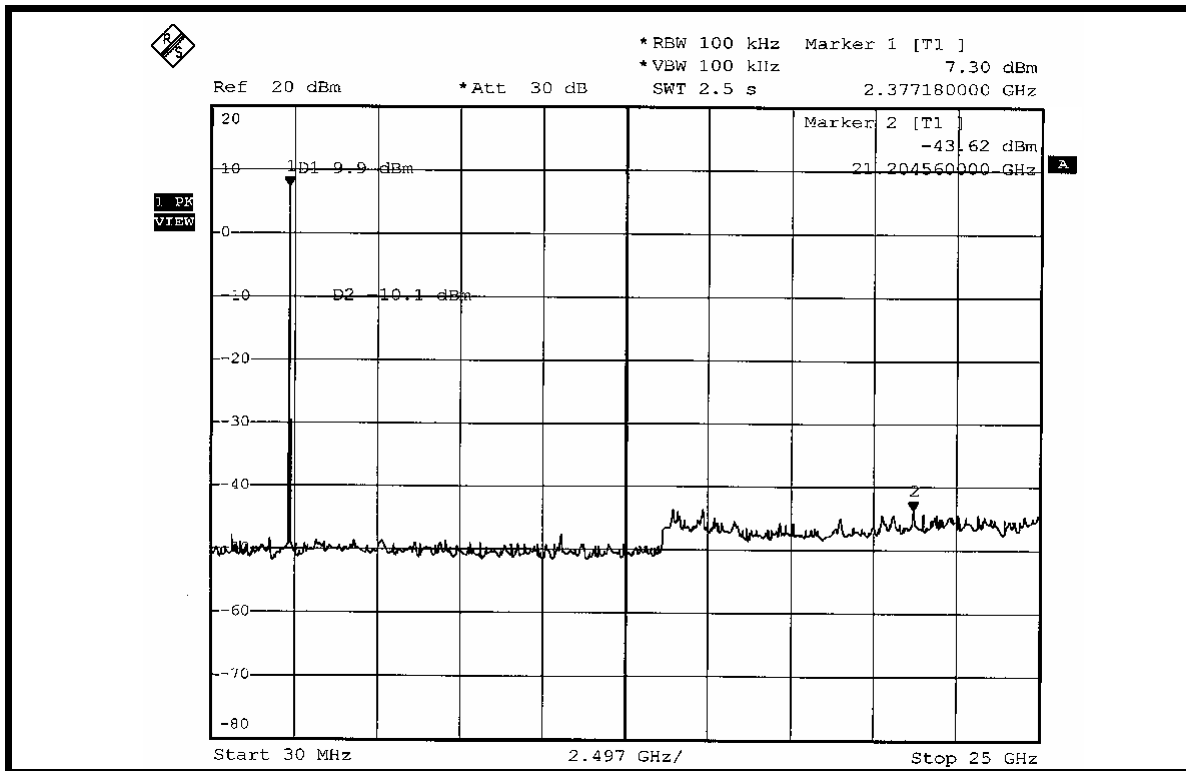

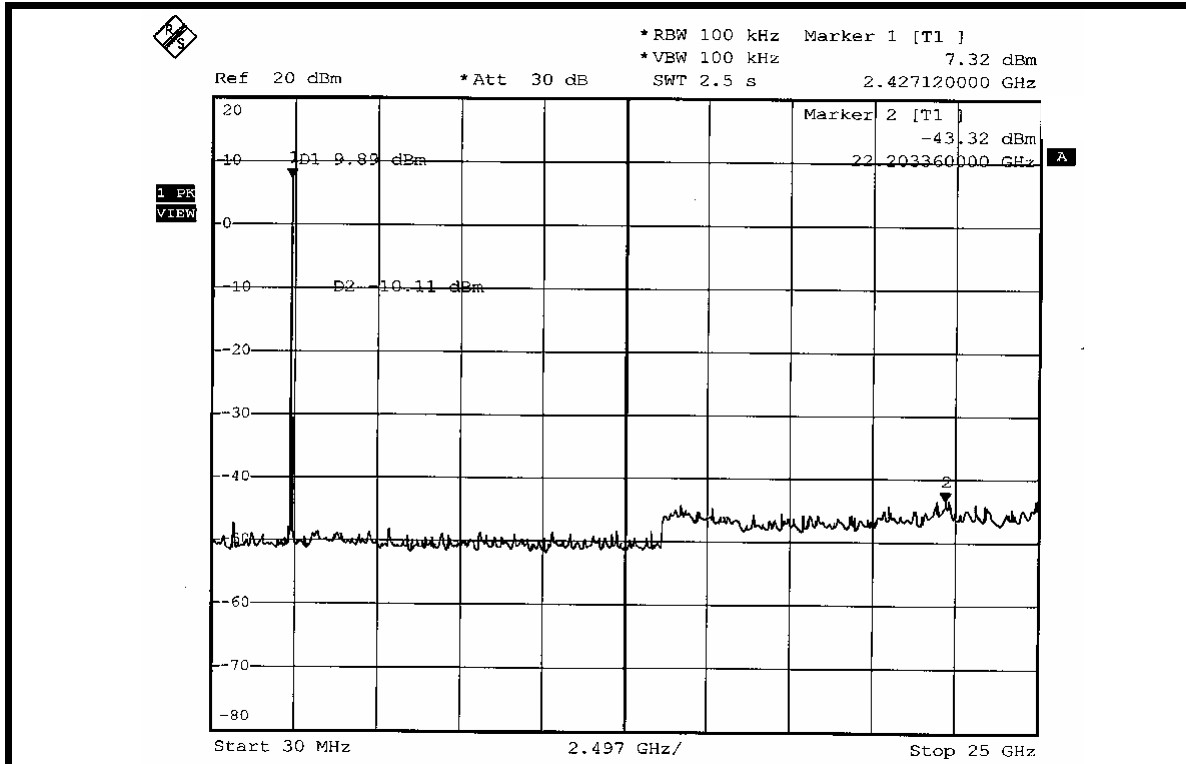
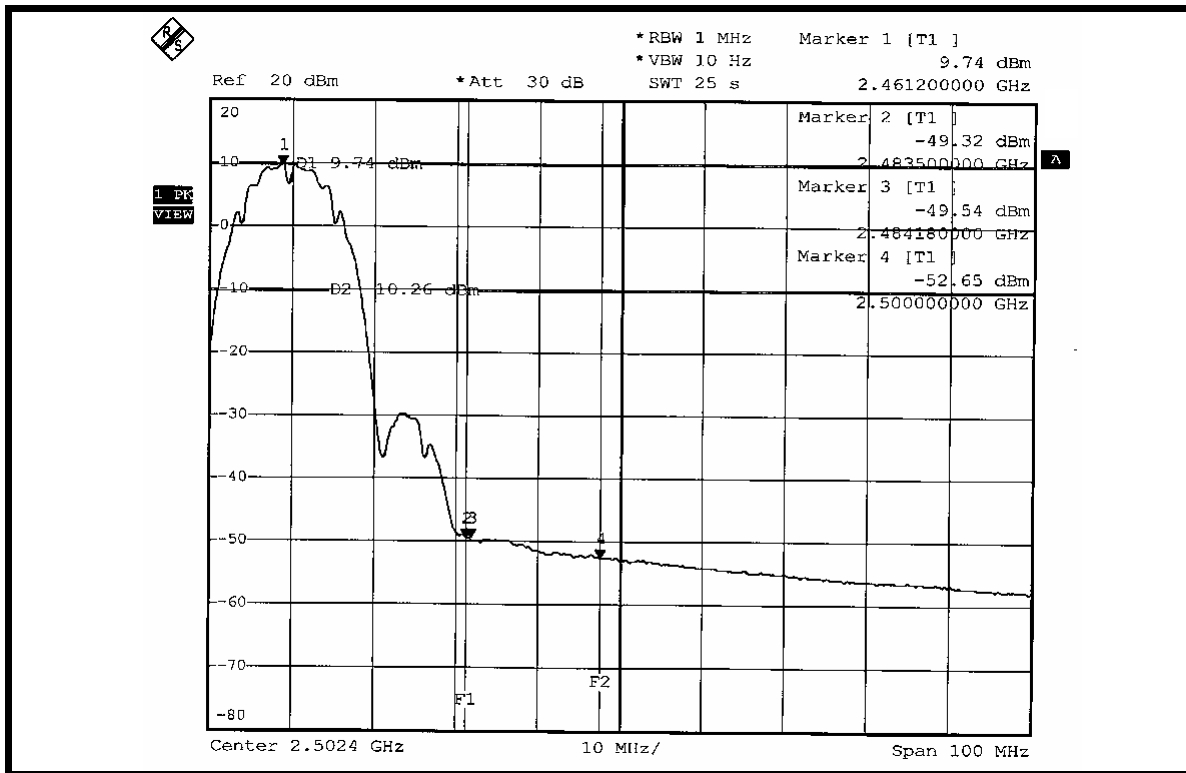

## 802.11g OFDM MODULATION

**NOTE 1:** The band edge emission plot of OFDM technique on the next page shows 41.40dBc between carrier maximum power and local maximum emission in restrict band (2.3900GHz). The emission of carrier strength list in the test result of channel 1 at the item 4.2.7 is 109.37dBuV/m (Peak), so the maximum field strength in restrict band is  $109.37 - 41.40 = 67.97$ dBuV/m which is under 74dBuV/m limit.

The band edge emission plot of OFDM technique on the next page shows 46.32dBc between carrier maximum power and local maximum emission in restrict band (2.3900GHz). The emission of carrier strength list in the test result of channel 1 at the item 4.2.7 is 99.27dBuV/m (Average), so the maximum field strength in restrict band is  $99.27 - 46.32 = 52.95$ dBuV/m which is under 54dBuV/m limit.

**NOTE 2:** The band edge emission plot of OFDM technique on the next second page shows 46.21dBc between carrier maximum power and local maximum emission in restrict band (2.4835GHz). The emission of carrier strength list in the test result of channel 11 at the item 4.2.7 is 108.97dBuV/m (Peak), so the maximum field strength in restrict band is  $108.97 - 46.21 = 62.76$ dBuV/m which is under 74dBuV/m limit.

The band edge emission plot of OFDM technique on the next third page shows 48.43dBc between carrier maximum power and local maximum emission in restrict band (2.4835GHz). The emission of carrier strength list in the test result of channel 11 at the item 4.2.7 is 98.47dBuV/m (Average), so the maximum field strength in restrict band is  $98.47 - 48.43 = 50.04$ dBuV/m which is under 54dBuV/m limit.

### 802.11g OFDM MODULATION

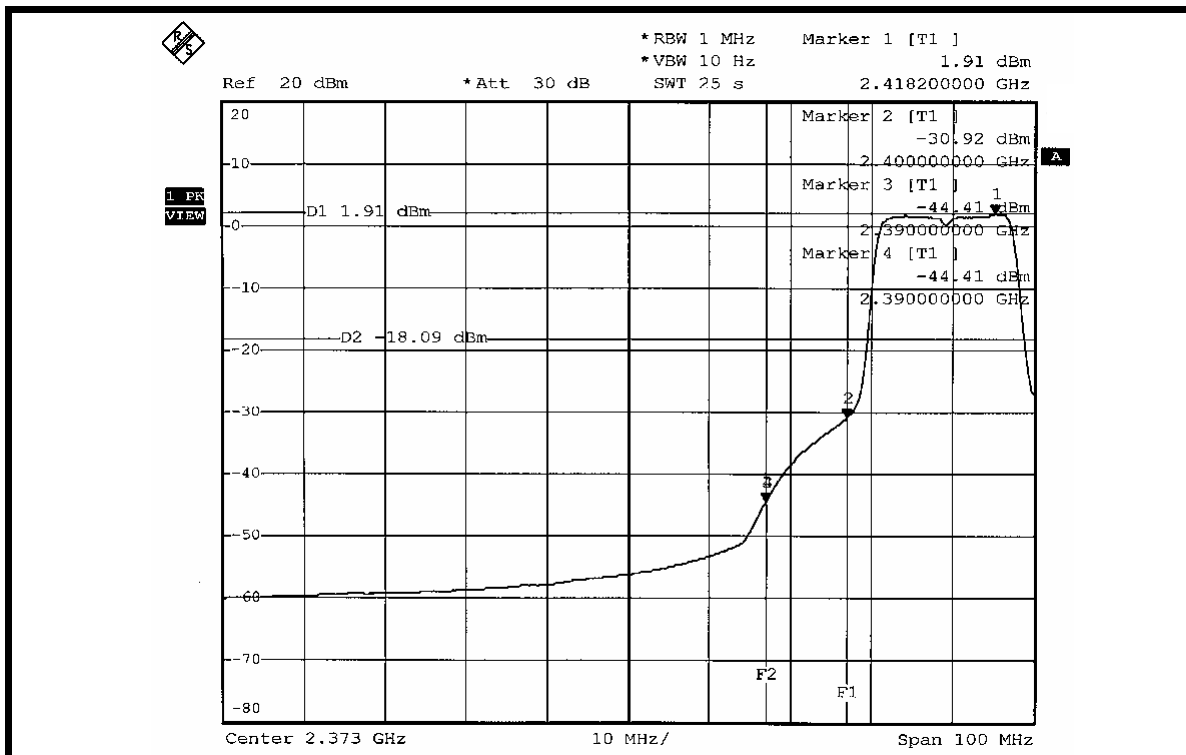
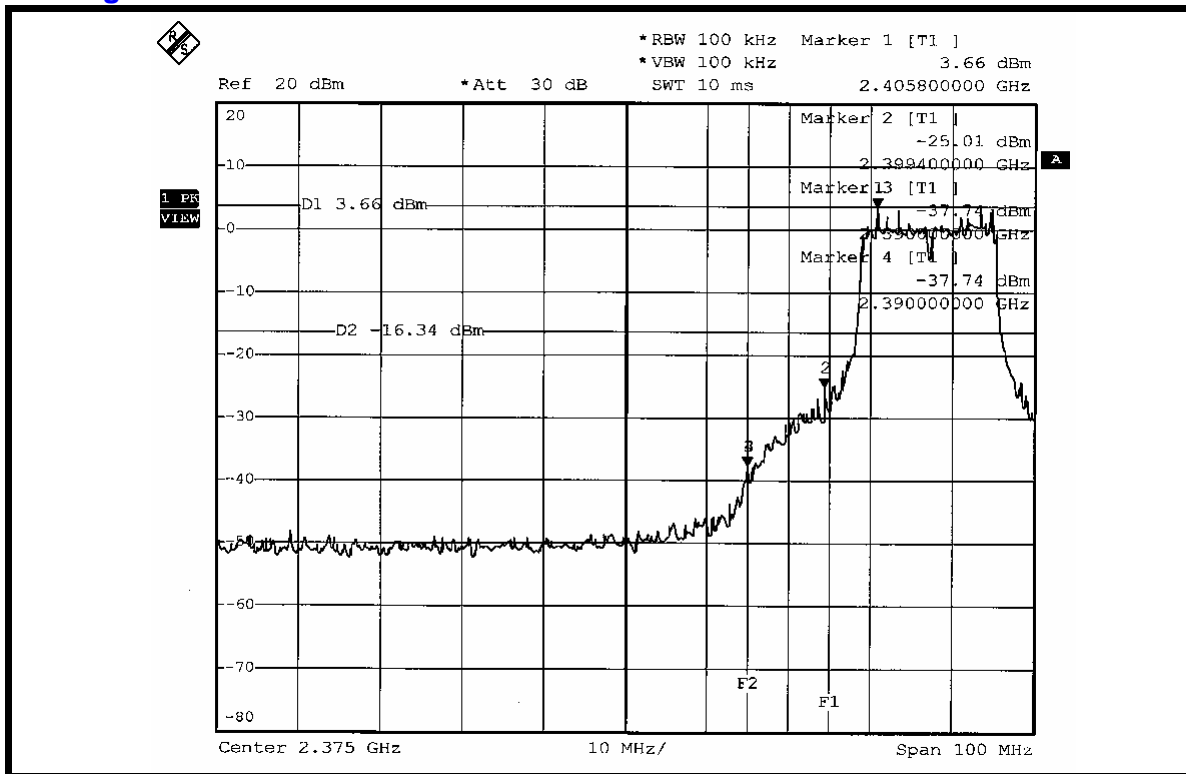



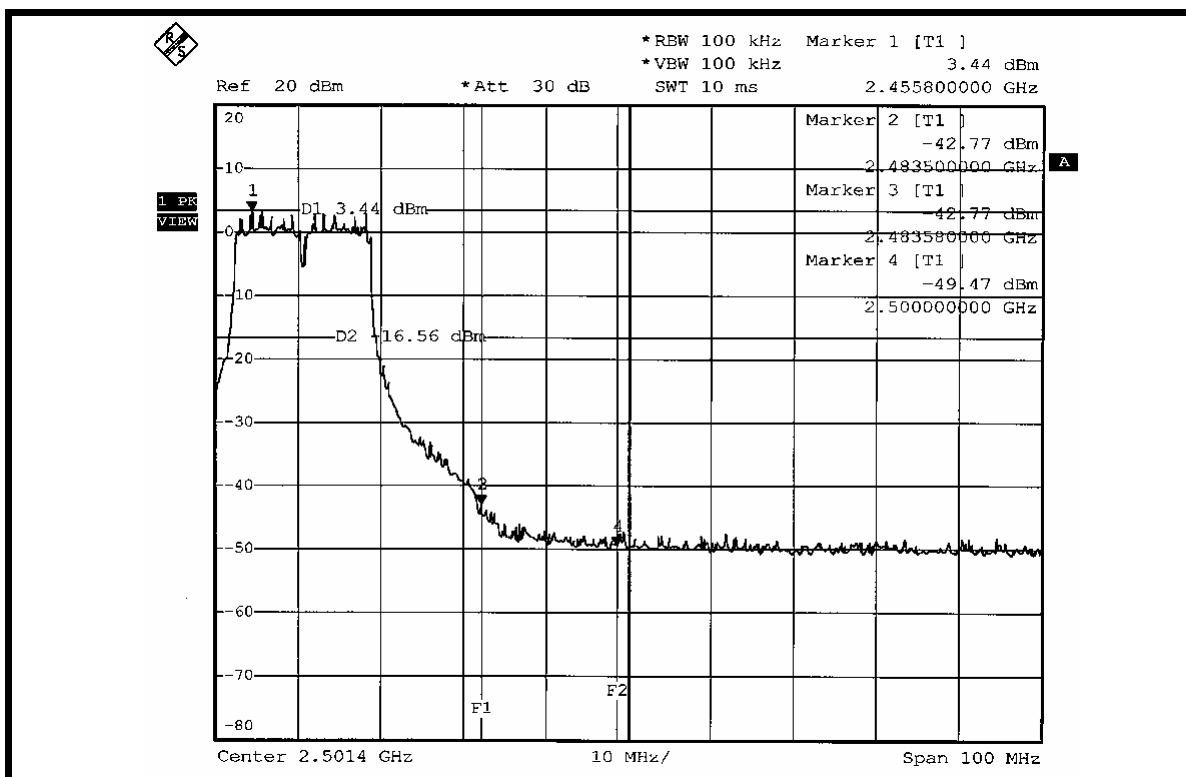
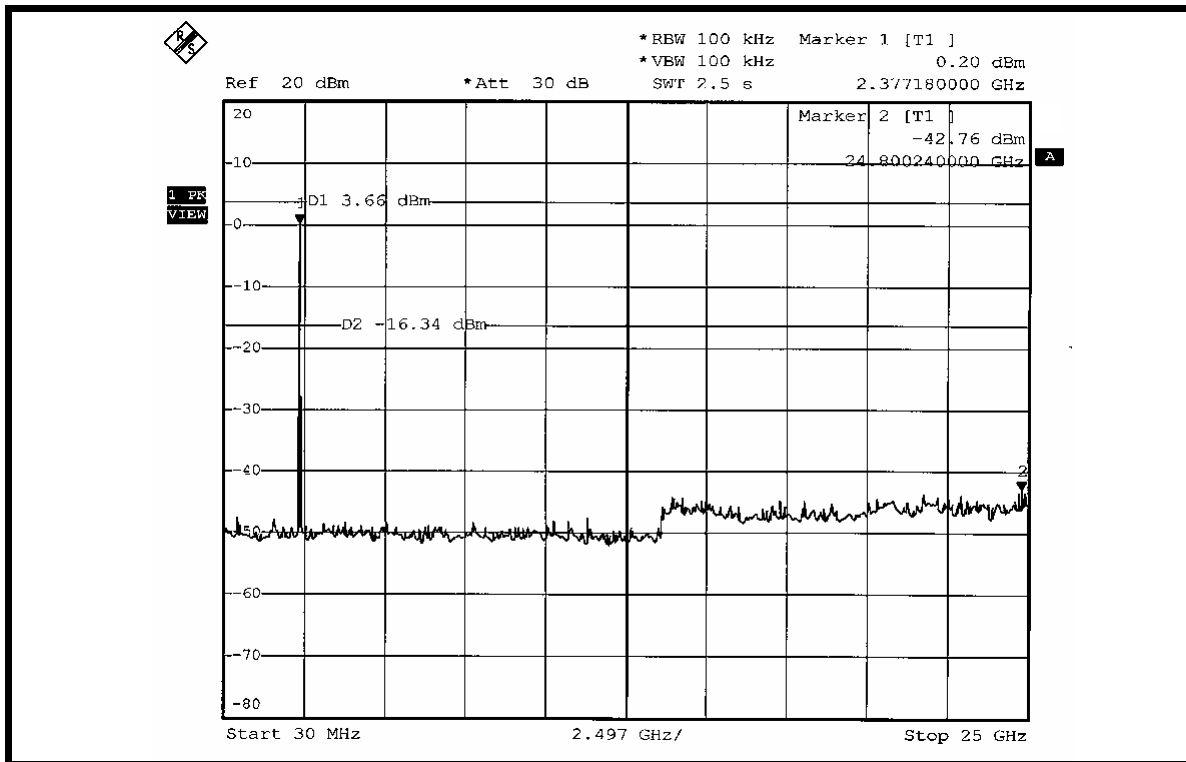





## 4.7 ANTENNA REQUIREMENT

### 4.7.1 STANDARD APPLICABLE

For intentional device, according to FCC 47 CFR Section 15.203, an intentional radiator shall be designed to ensure that no antenna other than that furnished by the responsible party shall be used with the device. And according to FCC 47 CFR Section 15.247 (b), if transmitting antennas of directional gain greater than 6dBi are used, the power shall be reduced by the amount in dB that the directional gain of the antenna exceeds 6dBi.

### 4.7.2 ANTENNA CONNECTED CONSTRUCTION

The antenna used in this product is PIFA antenna without connector. The maximum Gain of the antenna is 0dBi.



## 5. INFORMATION ON THE TESTING LABORATORIES

We, ADT Corp., were founded in 1988 to provide our best service in EMC, Radio, Telecom and Safety consultation. Our laboratories are accredited and approved by the following approval agencies according to ISO/IEC 17025.

<b>USA</b>	FCC, UL, A2LA
<b>GERMANY</b>	TUV Rheinland
<b>JAPAN</b>	VCCI
<b>NORWAY</b>	NEMKO
<b>CANADA</b>	INDUSTRY CANADA , CSA
<b>R.O.C.</b>	CNLA, BSMI, NCC
<b>NETHERLANDS</b>	Telefication
<b>SINGAPORE</b>	PSB , GOST-ASIA (MOU)
<b>RUSSIA</b>	CERTIS (MOU)

Copies of accreditation certificates of our laboratories obtained from approval agencies can be downloaded from our web site:

[www.adt.com.tw/index.5/phtml](http://www.adt.com.tw/index.5/phtml). If you have any comments, please feel free to contact us at the following:

**Linko EMC/RF Lab:**

Tel: 886-2-26052180  
Fax: 886-2-26052943

**Hsin Chu EMC/RF Lab:**

Tel: 886-3-5935343  
Fax: 886-3-5935342

**Hwa Ya EMC/RF/Safety Telecom Lab:**

Tel: 886-3-3183232  
Fax: 886-3-3185050

**Web Site:** [www.adt.com.tw](http://www.adt.com.tw)

The address and road map of all our labs can be found in our web site also.



## **APPENDIX-A**

### **MODIFICATIONS RECORDERS FOR ENGINEERING CHANGES TO THE EUT BY THE LAB**

No any modifications are made to the EUT by the lab during the test