



FCC TEST REPORT (PART 15)

REPORT NO.: RF950915L21

MODEL NO.: TITA100

RECEIVED: Sep. 18, 2006

TESTED: Sep. 21 ~ Sep. 25, 2006

ISSUED: Oct. 02, 2006

APPLICANT: High Tech Computer Corp.

ADDRESS: 23, Hsin-Hua Rd., Taoyuan, 330, Taiwan, R.O.C.

ISSUED BY: Advance Data Technology Corporation

LAB ADDRESS: No. 47, 14th Ling, Chia Pau Tsuen, Lin Kou Hsiang 244, Taipei Hsien, Taiwan, R.O.C.

TEST LOCATION: No. 19, Hwa Ya 2nd Rd., Wen Hwa Tsuen, Kwei Shan Hsiang, Taoyuan Hsien 333, Taiwan, R.O.C.

This test report consists of 99 pages in total. It may be duplicated completely for legal use with the approval of the applicant. It should not be reproduced except in full, without the written approval of our laboratory. The client should not use it to claim product endorsement by CNLA, A2LA or any government agencies. The test results in the report only apply to the tested sample.





TABLE OF CONTENTS

1.	CERTIFICATION	4
2.	SUMMARY OF TEST RESULTS	5
2.1	MEASUREMENT UNCERTAINTY	5
3.	GENERAL INFORMATION	6
3.1	GENERAL DESCRIPTION OF EUT	6
3.2	DESCRIPTION OF TEST MODES	8
3.2.1	CONFIGURATION OF SYSTEM UNDER TEST	9
3.2.2	TEST MODE APPLICABILITY AND TESTED CHANNEL DETAIL:	10
3.3.3	GENERAL DESCRIPTION OF APPLIED STANDARDS	13
3.3.4	DESCRIPTION OF SUPPORT UNITS	13
4.	TEST TYPES AND RESULTS	14
4.1	CONDUCTED EMISSION MEASUREMENT	14
4.1.1	LIMITS OF CONDUCTED EMISSION MEASUREMENT	14
4.1.2	TEST INSTRUMENTS	14
4.1.3	TEST PROCEDURES	15
4.1.4	DEVIATION FROM TEST STANDARD	15
4.1.5	TEST SETUP	16
4.1.6	EUT OPERATING CONDITIONS	16
4.1.7	TEST RESULTS	17
4.2	RADIATED EMISSION MEASUREMENT	59
4.2.1	LIMITS OF RADIATED EMISSION MEASUREMENT	59
4.2.2	TEST INSTRUMENTS	60
4.2.3	TEST PROCEDURES	61
4.2.4	DEVIATION FROM TEST STANDARD	61
4.2.5	TEST SETUP	62
4.2.6	EUT OPERATING CONDITIONS	62
4.2.7	TEST RESULTS	63
4.3	NUMBER OF HOPPING FREQUENCY USED	73
4.3.1	LIMIT OF HOPPING FREQUENCY USED	73
4.3.2	TEST INSTRUMENTS	73
4.3.3	TEST PROCEDURES	73
4.3.4	DEVIATION FROM TEST STANDARD	74
4.3.5	TEST SETUP	74
4.3.6	TEST RESULTS	74
4.4	DWELL TIME ON EACH CHANNEL	76
4.4.1	LIMIT OF DWELL TIME USED	76
4.4.2	TEST INSTRUMENTS	76
4.4.3	TEST PROCEDURES	76
4.4.4	DEVIATION FROM TEST STANDARD	76
4.4.5	TEST SETUP	77
4.4.6	TEST RESULTS	77
4.5	CHANNEL BANDWIDTH	81
4.5.1	LIMITS OF CHANNEL BANDWIDTH	81
4.5.2	TEST INSTRUMENTS	81
4.5.3	TEST PROCEDURE	81
4.5.4	DEVIATION FROM TEST STANDARD	82
4.5.5	TEST SETUP	82
4.5.6	EUT OPERATING CONDITION	82
4.5.7	TEST RESULTS	82



4.6 HOPPING CHANNEL SEPARATION	85
4.6.1 LIMIT OF HOPPING CHANNEL SEPARATION.....	85
4.6.2 TEST INSTRUMENTS.....	85
4.6.3 TEST PROCEDURES	85
4.6.4 DEVIATION FROM TEST STANDARD.....	86
4.6.5 TEST SETUP	86
4.6.6 TEST RESULTS.....	86
4.7 MAXIMUM PEAK OUTPUT POWER.....	89
4.7.1 LIMITS OF MAXIMUM PEAK OUTPUT POWER MEASUREMENT	89
4.7.2 TEST INSTRUMENTS.....	89
4.7.3 TEST PROCEDURES	89
4.7.4 DEVIATION FROM TEST STANDARD.....	89
4.7.5 TEST SETUP	90
4.7.6 EUT OPERATING CONDITION	90
4.7.7 TEST RESULTS.....	90
4.8 BAND EDGES MEASUREMENT	93
4.8.1 LIMITS OF BAND EDGES MEASUREMENT	93
4.8.2 TEST INSTRUMENTS.....	93
4.8.3 TEST PROCEDURE.....	93
4.8.4 DEVIATION FROM TEST STANDARD.....	93
4.8.5 EUT OPERATING CONDITION	93
4.8.6 TEST RESULTS.....	94
4.9 ANTENNA REQUIREMENT	97
4.9.1 STANDARD APPLICABLE	97
4.9.2 ANTENNA CONNECTED CONSTRUCTION.....	97
5. INFORMATION ON THE TESTING LABORATORIES.....	98
APPENDIX-A.....	A-1



1. CERTIFICATION

PRODUCT: Pocket PC Phone
MODEL NO.: TITA100
TEST SAMPLE: ENGINEERING SAMPLE
TESTED: Sep. 21 ~ Sep. 25, 2006
APPLICANT: High Tech Computer Corp.
STANDARDS: FCC Part 15, Subpart C (Section 15.247),
ANSI C63.4-2003

The above equipment have been tested by **Advance Data Technology Corporation**, and found compliance with the requirement of the above standards. The test record, data evaluation & Equipment Under Test (EUT) configurations represented herein are true and accurate accounts of the measurements of the sample's EMC characteristics under the conditions specified in this report.

PREPARED BY : Andrea Hsia , **DATE:** Oct. 02, 2006
Andrea Hsia

TECHNICAL ACCEPTANCE : Long Chen , **DATE:** Oct. 02, 2006
Responsible for RF Long Chen

APPROVED BY : Gary Chang , **DATE:** Oct. 02, 2006
Gary Chang / Supervisor

2. SUMMARY OF TEST RESULTS

The EUT has been tested according to the following specifications:

APPLIED STANDARD: FCC Part 15, Subpart C			
STANDARD SECTION	TEST TYPE AND LIMIT	RESULT	REMARK
15.207	AC Power Conducted Emission	PASS	Meet the requirement of limit Minimum passing margin is -4.54dB at 0.400MHz.
15.247(a)(1)(iii)	Number of Hopping Frequency Used Spec.: At least 15 channels	PASS	Meet the requirement of limit
15.247(a)(1)(iii)	Dwell Time on Each Channel Spec. : Max. 0.4 second within 31.6 second	PASS	Meet the requirement of limit
15.247(a)(1)	1. Hopping Channel Separation Spec. : Min. 25 kHz or 20 dB bandwidth, whichever is greater 2. Spectrum Bandwidth of a Frequency Hopping Sequence Spread Spectrum System	PASS	Meet the requirement of limit
15.247(b)	Maximum Peak Output Power Spec.: max. 30dBm	PASS	Meet the requirement of limit
15.247(d)	Transmitter Radiated Emissions Spec.: Table 15.209	PASS	Meet the requirement of limit Minimum passing margin is -3.41 dB at 51.38MHz.
15.247(d)	Band Edge Measurement	PASS	Meet the requirement of limit

2.1 MEASUREMENT UNCERTAINTY

Where relevant, the following measurement uncertainty levels have been estimated for tests performed on the EUT as specified in CISPR 16-4:

MEASUREMENT	FREQUENCY	UNCERTAINTY
Conducted emissions	9kHz ~ 30MHz	2.44 dB
Radiated emissions	30MHz ~ 200MHz	3.59 dB
	200MHz ~1000MHz	3.61 dB
	1GHz ~ 18GHz	2.26 dB
	18GHz ~ 40GHz	1.94 dB

This uncertainty represents an expanded uncertainty expressed at approximately the 95% confidence level using a coverage factor of k=2.

3. GENERAL INFORMATION

3.1 GENERAL DESCRIPTION OF EUT

PRODUCT	Pocket PC Phone
MODEL NO.	TITA100
FCC ID	NM8TITA100
POWER SUPPLY	3.70Vdc from rechargeable lithium battery 5.00Vdc from power adapter or cradle 5.00Vdc from host equipment
MODULATION TYPE	GFSK for FHSS
MODULATION TECHNOLOGY	FHSS
TRANSFER RATE	723Kbps
FREQUENCY RANGE	2.402 ~ 2.480GHz
NUMBER OF CHANNEL	79
OUTPUT POWER	1.064mW
ANTENNA TYPE	PIFA antenna with 0dBi gain
DATA CABLE	1.5m USB non-shielded cable without core 1.6m non-shielded cable for Earphone
I/O PORTS	Refer to user's manual
ASSOCIATED DEVICES	Belt chip, Pouch, Cradle, Earphone

NOTE:

1. The applicant defined the normal working voltage of the battery is from 3.6Vdc to 4.2Vdc.
2. The EUT have two different appearances.
3. The EUT is a CDMA850/CDMA1900 Pocket PC Phone with wireless LAN and bluetooth functions. This report is only covered the functions of bluetooth. The wireless LAN is covered in the other test report, which standards used also FCC Part 15. The mobile phone function is covered in another two test reports, which standards used are FCC Part 24 and FCC Part 22.
4. The EUT have lithium batteries listed as below:

BATTERY 1:	
BRAND:	Dynapack International Technology Corporation
MODEL:	TRIN160
RATING:	3.7Vdc, 1500mAh

BATTERY 2:	
BRAND:	SK mobile energy CO., LTD
MODEL:	TRIN160
RATING:	3.7Vdc, 1500mAh

NOTE: After pre-tested both batteries and both model, found TITA100 with batter 1 is worse, therefore all the test results came out from this.

5. The EUT was operated with following power adapters:

ADAPTER 1:	
BRAND:	DELTA ELECTRONIC, INC.
MODEL:	ADP-5FH B
INPUT:	100-240Vac ~ 50-60Hz, 0.2A,
OUTPUT:	5.0Vdc, 1A
POWER LINE:	DC 1.8m non-shielded cable without core

ADAPTER 2:	
BRAND:	PHIHONG
MODEL:	PSAA05A-050
INPUT:	100~240Vac, 200mA, 50-60Hz
OUTPUT:	5.0Vdc, 1A
POWER LINE:	DC 1.8m non-shielded cable without core

6. The EUT was operated with following charging cradle:

MODEL:	TITA150
OUTPUT:	5.0Vdc, 1A

7. The EUT operates in the 2.4GHz frequency spectrum and complies with 802.11b & 802.11g techniques.

8. The above EUT information was declared by manufacturer and for more detailed features description, please refer to the manufacturer's specifications or User's Manual.

9. The EUT used the same antenna in Wireless LAN & Bluetooth function, but the two functions can not work at the same time.

3.2 DESCRIPTION OF TEST MODES

Since the EUT is considered a portable unit, it was pre-tested on the positioned of each 3 axis. For wireless LAN function, the worst case was found when positioned on Z-plane. Therefore only the test data of this Z-plane was used for radiated test.

There are 7 test modes presented in the report as below.

TEST MODE	TEST CONDITION
A	The EUT with battery 1, and was powered by the adapter 1.
B	The EUT with battery 1, and was powered by the adapter 2.
C	The EUT with battery 1 connected with the earphone via USB cable, and was powered by the adapter 1 via USB cable.
D	The EUT with battery 1 connected with the earphone via USB cable, and was powered by the adapter 2 via USB cable.
E	The EUT with battery 1 connected with the earphone and notebook via USB cable, and was powered by notebook.
F	The EUT with battery 1 connected with the cradle, and was powered by the adapter 1.
G	The EUT with battery 1 connected with the cradle, and was powered by the adapter 2.

79 channels are provided to this EUT for bluetooth function:

CHANNEL	FREQ. (MHz)	CHANNEL	FREQ. (MHz)	CHANNEL	FREQ. (MHz)	CHANNEL	FREQ. (MHz)
0	2402	20	2422	40	2442	60	2462
1	2403	21	2423	41	2443	61	2463
2	2404	22	2424	42	2444	62	2464
3	2405	23	2425	43	2445	63	2465
4	2406	24	2426	44	2446	64	2466
5	2407	25	2427	45	2447	65	2467
6	2408	26	2428	46	2448	66	2468
7	2409	27	2429	47	2449	67	2469
8	2410	28	2430	48	2450	68	2470
9	2411	29	2431	49	2451	69	2471
10	2412	30	2431	50	2452	70	2472
11	2413	31	2433	51	2453	71	2473
12	2414	32	2434	52	2454	72	2474
13	2415	33	2435	53	2455	73	2475
14	2416	34	2436	54	2456	74	2476
15	2417	35	2437	55	2457	75	2477
16	2418	36	2438	56	2458	76	2478
17	2419	37	2439	57	2459	77	2479
18	2420	38	2440	58	2460	78	2480
19	2421	39	2441	59	2461		

3.2.1 CONFIGURATION OF SYSTEM UNDER TEST

TEST MODE A, B,

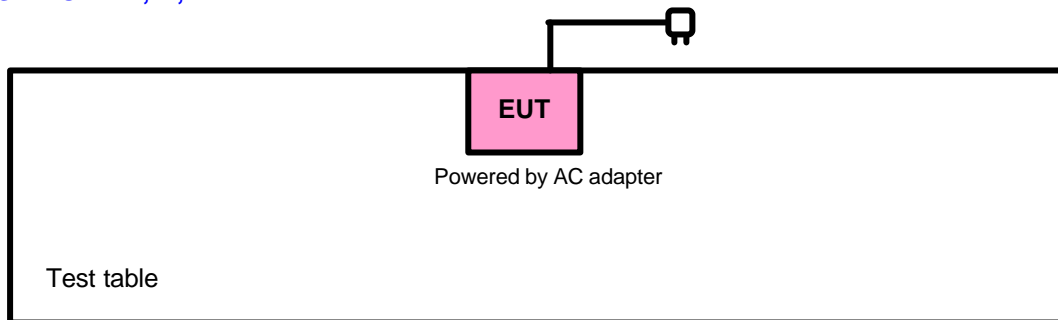

TEST MODE C, D

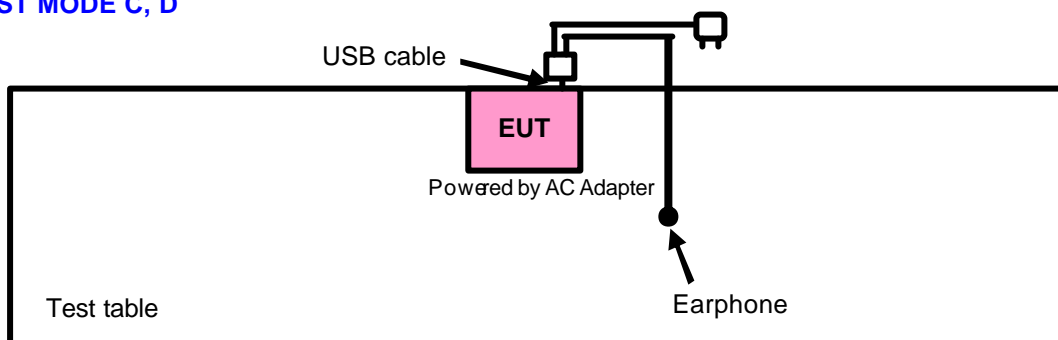

TEST MODE E

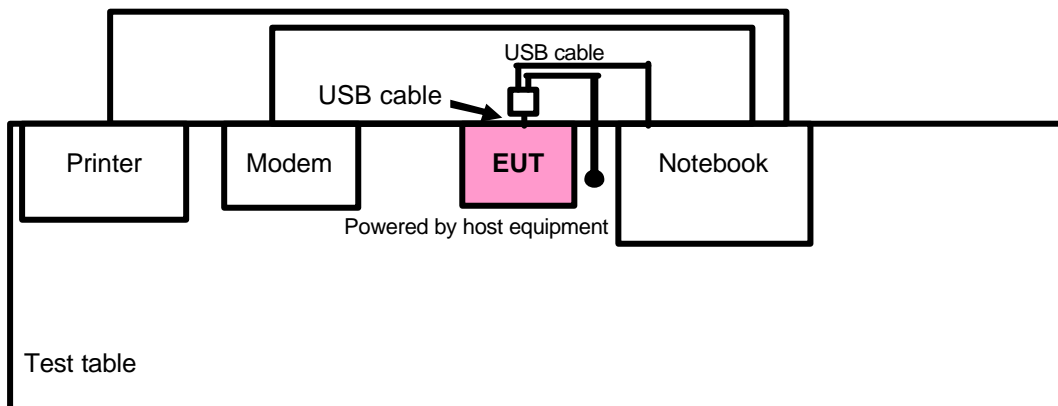

TEST MODE F, G

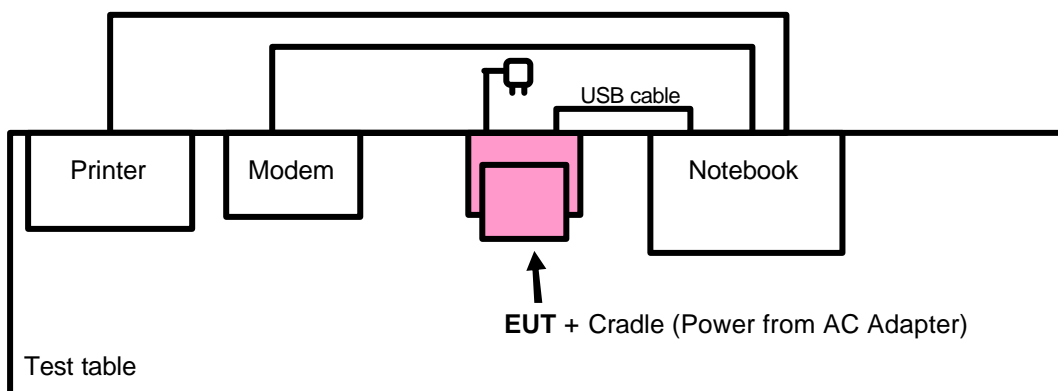

3.2.2 TEST MODE APPLICABILITY AND TESTED CHANNEL DETAIL :

EUT CONFIGURE MODE	APPLICABLE TO				DESCRIPTION
	PLC	RE<1G	RE ³ 1G	APCM	
A	v	v	-	-	The EUT with battery 1, and was powered by the adapter 1.
B	v	v	-	-	The EUT with battery 1, and was powered by the adapter 2.
C	v	v	-	-	The EUT with battery 1 connected with the earphone via USB cable, and was powered by the adapter 1 via USB cable.
D	v	v	-	-	The EUT with battery 1 connected with the earphone via USB cable, and was powered by the adapter 2 via USB cable.
E	v	v	v	v	The EUT with battery 1 connected with the earphone and notebook via USB cable, and was powered by notebook
F	v	v	-	-	The EUT with battery 1 connected with the cradle, and was powered by the adapter 1.
G	v	v	-	-	The EUT with battery 1 connected with the cradle, and was powered by the adapter 2.

Where **PLC**: Power Line Conducted Emission
RE³ 1G: Radiated Emission above 1GHz

RE<1G: Radiated Emission below 1GHz
APCM: Antenna Port Conducted Measurement

NOTE: “-“ means no effect.

POWER LINE CONDUCTED EMISSION TEST:

? Pre-Scan has been conducted to determine the worst-case mode from all possible combinations between available modulations, antenna ports (if EUT with antenna diversity architecture), and packet types.

Following channel(s) was (were) selected for the final test as listed below.

EUT CONFIGURE MODE	AVAILABLE CHANNEL	TESTED CHANNEL	MODULATION TECHNOLOGY	MODULATION TYPE	PACKET TYPE
A	0 to 78	0, 39, 78	FHSS	GFSK	DH5
B	0 to 78	0, 39, 78	FHSS	GFSK	DH5
C	0 to 78	0, 39, 78	FHSS	GFSK	DH5
D	0 to 78	0, 39, 78	FHSS	GFSK	DH5
E	0 to 78	0, 39, 78	FHSS	GFSK	DH5
F	0 to 78	0, 39, 78	FHSS	GFSK	DH5
G	0 to 78	0, 39, 78	FHSS	GFSK	DH5

RADIATED EMISSION TEST (BELOW 1 GHz):

- ? Pre-Scan has been conducted to determine the worst-case mode from all possible combinations between available modulations, data rates, antenna ports (if EUT with antenna diversity architecture), X, Y, Z Axis, and packet type.
- Following channel(s) was (were) selected for the final test as listed below.

EUT CONFIGURE MODE	AVAILABLE CHANNEL	TESTED CHANNEL	MODULATION TECHNOLOGY	MODULATION TYPE	PACKET TYPE	AXIS
A	0 to 78	78	FHSS	GFSK	DH5	Z
B	0 to 78	78	FHSS	GFSK	DH5	Z
C	0 to 78	78	FHSS	GFSK	DH5	Z
D	0 to 78	78	FHSS	GFSK	DH5	Z
E	0 to 78	78	FHSS	GFSK	DH5	Z
F	0 to 78	78	FHSS	GFSK	DH5	Z
G	0 to 78	78	FHSS	GFSK	DH5	Z

RADIATED EMISSION TEST (ABOVE 1 GHz):

- ? Pre-Scan has been conducted to determine the worst-case mode from all possible combinations between available modulations, data rates, antenna ports (if EUT with antenna diversity architecture), X, Y, Z Axis, and packet type.
- Following channel(s) was (were) selected for the final test as listed below.

EUT CONFIGURE MODE	AVAILABLE CHANNEL	TESTED CHANNEL	MODULATION TECHNOLOGY	MODULATION TYPE	PACKET TYPE	AXIS
E	0 to 78	0, 39, 78	FHSS	GFSK	DH5	Z

BANDEDGE MEASUREMENT:

- ? Pre-Scan has been conducted to determine the worst-case mode from all possible combinations between available modulations, antenna ports (if EUT with antenna diversity architecture), and packet types.
- Following channel(s) was (were) selected for the final test as listed below.

AVAILABLE CHANNEL	TESTED CHANNEL	MODULATION TECHNOLOGY	MODULATION TYPE	PACKET TYPE
0 to 78	0, 78	FHSS	GFSK	DH5



ANTENNA PORT CONDUCTED MEASUREMENT:

? Pre-Scan has been conducted to determine the worst-case mode from all possible combinations between available modulations, antenna ports (if EUT with antenna diversity architecture), and packet types.

Following channel(s) was (were) selected for the final test as listed below.

AVAILABLE CHANNEL	TESTED CHANNEL	MODULATION TECHNOLOGY	MODULATION TYPE	PACKET TYPE
0 to 78	0, 39, 78	FHSS	GFSK	DH5



3.3.3 GENERAL DESCRIPTION OF APPLIED STANDARDS

The EUT is a RF Product. According to the specifications of the manufacturer, it must comply with the requirements of the following standards:

FCC Part 15, Subpart C. (15.247)

ANSI C63.4- 2003

All test items have been performed and recorded as per the above standards.

NOTE: The EUT is also considered as a kind of computer peripheral, because the connection to computer is necessary for typical use. It has been verified to comply with the requirements of FCC Part 15, Subpart B, Class B (DoC). The test report has been issued separately.

3.3.4 DESCRIPTION OF SUPPORT UNITS

The EUT has been tested as an independent unit together with other necessary accessories or support units. The following support units or accessories were used to form a representative test configuration during the tests.

NO.	PRODUCT	BRAND	MODEL NO.	SERIAL NO.	FCC ID
1	NOTEBOOK COMPUTER	DELL	PP05L	12130898320	E2K24CLNS
2	MODEM	ACEEX	1414V/3	0401008248	IFAXDM1414
3	PRINTER	EPSON	LQ-300+	DCGY047265	FCC DoC Approved

NO.	SIGNAL CABLE DESCRIPTION OF THE ABOVE SUPPORT UNITS
1	NA
2	1.2 m shielded cable without core
3	1.2 m shielded cable without core

NOTE: All power cords of the above support units are non shielded (1.8m).

4. TEST TYPES AND RESULTS

4.1 CONDUCTED EMISSION MEASUREMENT

4.1.1 LIMITS OF CONDUCTED EMISSION MEASUREMENT

FREQUENCY OF EMISSION (MHz)	CONDUCTED LIMIT (dB μ V)	
	Quasi-peak	Average
0.15 ~ 0.5	66 to 56	56 to 46
0.5 ~ 5	56	46
5 ~ 30	60	50

- NOTE:**
1. The lower limit shall apply at the transition frequencies.
 2. The limit decreases in line with the logarithm of the frequency in the range of 0.15 to 0.50 MHz.
 3. All emanations from a class A/B digital device or system, including any network of conductors and apparatus connected thereto, shall not exceed the level of field strengths specified above.

4.1.2 TEST INSTRUMENTS

DESCRIPTION & MANUFACTURER	MODEL NO.	SERIAL NO.	CALIBRATED UNTIL
Test Receiver ROHDE & SCHWARZ	ESCS30	100288	Nov. 02, 2006
RF signal cable Woken	5D-FB	Cable-HYCO3-01	Jan. 06, 2007
LISN ROHDE & SCHWARZ	ESH2-Z5	100100	Jan. 09, 2007
LISN ROHDE & SCHWARZ	ESH3-Z5	100311	Jan. 22, 2007
Software ADT	ADT_Cond_V3	NA	NA

- NOTE:**
1. The calibration interval of the above test instruments is 12 months and the calibrations are traceable to NML/ROC and NIST/USA.
 2. The test was performed in HwaYa Shielded Room 2.
 3. The VCCI Site Registration No. is C-2047.

4.1.3 TEST PROCEDURES

- a. The EUT was placed 0.4 meters from the conducting wall of the shielded room with EUT being connected to the power mains through a line impedance stabilization network (LISN). Other support units were connected to the power mains through another LISN. The two LISNs provide 50 ohm/ 50uH of coupling impedance for the measuring instrument.
- b. Both lines of the power mains connected to the EUT were checked for maximum conducted interference.
- c. The frequency range from 150kHz to 30MHz was searched. Emission levels under (Limit - 20dB) was not recorded.

4.1.4 DEVIATION FROM TEST STANDARD

No deviation

4.1.5 TEST SETUP

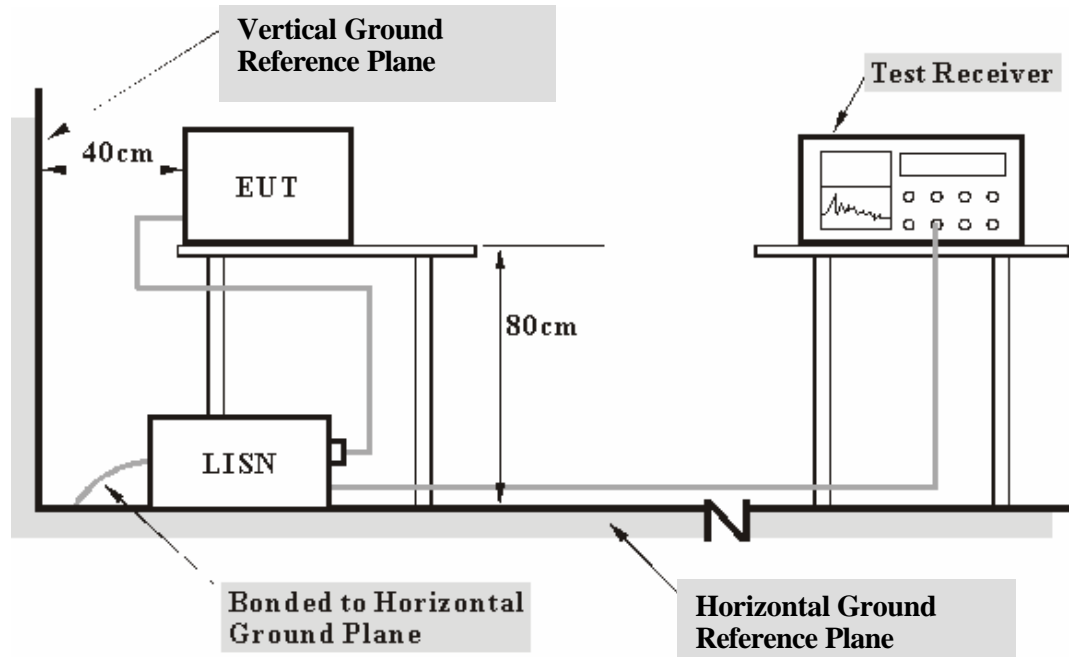

- Note:**
1. Support units were connected to second LISN.
 2. Both of LISNs (AMN) 80 cm from EUT and at the least 80 cm from other units and other metal planes support units.

For the actual test configuration, please refer to the attached file (Test Setup Photo).

4.1.6 EUT OPERATING CONDITIONS

TEST MODE A ~ D:

The EUT placed on the testing table and set it under transmission condition continuously at specific channel frequency.

TEST MODE E ~ G:

- a. Connected the EUT to a notebook system via USB cable and placed on a testing table.
- b. The notebook system ran a test program (provided by manufacturer) to enable EUT under transmission condition continuously at specific channel frequency.
- c. The necessary accessories enable the EUT in full functions

4.1.7 TEST RESULTS

CONDUCTED WORST CASE DATA:

EUT TEST CONDITION		MEASUREMENT DETAIL	
CHANNEL	Channel 0	PHASE	Line 1
MODULATION TYPE	GFSK	6dB BANDWIDTH	9 kHz
ENVIRONMENTAL CONDITIONS	23deg. C, 68%RH, 991hPa	INPUT POWER (SYSTEM)	120Vac, 60 Hz
TEST MODE	A	TESTED BY	Match Tsui

No	Freq. [MHz]	Corr. Factor (dB)	Reading Value [dB (uV)]		Emission Level [dB (uV)]		Limit [dB (uV)]		Margin (dB)	
			Q.P.	AV.	Q.P.	AV.	Q.P.	AV.	Q.P.	AV.
			1	0.181	0.10	43.53	-	43.63	-	64.43
2	0.245	0.10	35.27	-	35.37	-	61.93	51.93	-26.56	-
3	0.728	0.10	30.15	-	30.25	-	56.00	46.00	-25.75	-
4	2.072	0.21	37.38	-	37.59	-	56.00	46.00	-18.41	-
5	2.683	0.26	37.72	-	37.98	-	56.00	46.00	-18.02	-
6	18.231	0.58	29.12	-	29.70	-	60.00	50.00	-30.30	-

- REMARKS:**
1. Q.P. and AV. are abbreviations of quasi-peak and average individually.
 2. "-": The Quasi-peak reading value also meets average limit and measurement with the average detector is unnecessary.
 3. The emission levels of other frequencies were very low against the limit.
 4. Margin value = Emission level - Limit value
 5. Correction factor = Insertion loss + Cable loss
 6. Emission Level = Correction Factor + Reading Value.

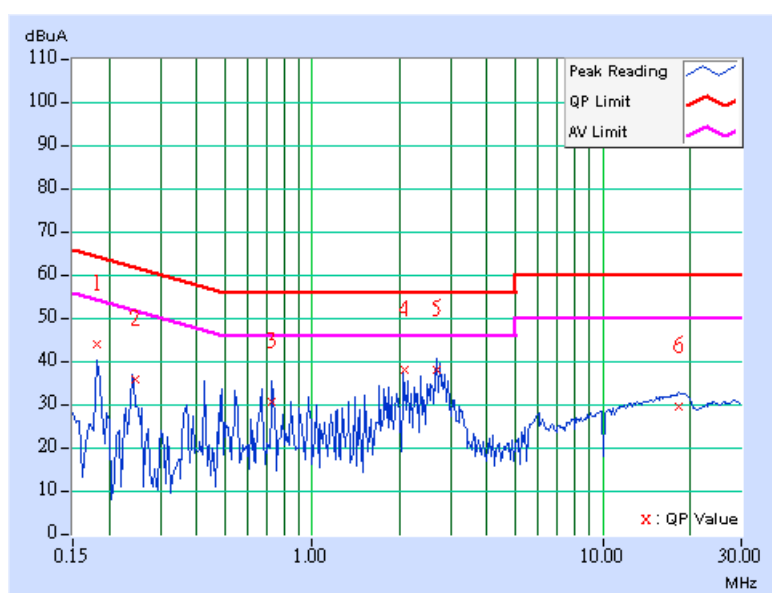

EUT TEST CONDITION		MEASUREMENT DETAIL	
CHANNEL	Channel 0	PHASE	Line 2
MODULATION TYPE	GFSK	6dB BANDWIDTH	9 kHz
ENVIRONMENTAL CONDITIONS	23deg. C, 68%RH, 991hPa	INPUT POWER (SYSTEM)	120Vac, 60 Hz
TEST MODE	A	TESTED BY	Match Tsui

No	Freq. [MHz]	Corr. Factor [dB]	Reading Value [dB (uV)]		Emission Level [dB (uV)]		Limit [dB (uV)]		Margin (dB)	
			Q.P.	AV.	Q.P.	AV.	Q.P.	AV.	Q.P.	AV.
			1	0.181	0.10	35.44	-	35.54	-	64.43
2	0.244	0.10	34.29	-	34.39	-	61.97	51.97	-27.58	-
3	0.423	0.10	32.43	-	32.53	-	57.38	47.38	-24.85	-
4	0.789	0.16	30.18	-	30.34	-	56.00	46.00	-25.66	-
5	2.551	0.25	32.00	-	32.25	-	56.00	46.00	-23.75	-
6	18.859	0.58	29.69	-	30.27	-	60.00	50.00	-29.73	-

- REMARKS:**
1. Q.P. and AV. are abbreviations of quasi-peak and average individually.
 2. "-": The Quasi-peak reading value also meets average limit and measurement with the average detector is unnecessary.
 3. The emission levels of other frequencies were very low against the limit.
 4. Margin value = Emission level - Limit value
 5. Correction factor = Insertion loss + Cable loss
 6. Emission Level = Correction Factor + Reading Value.

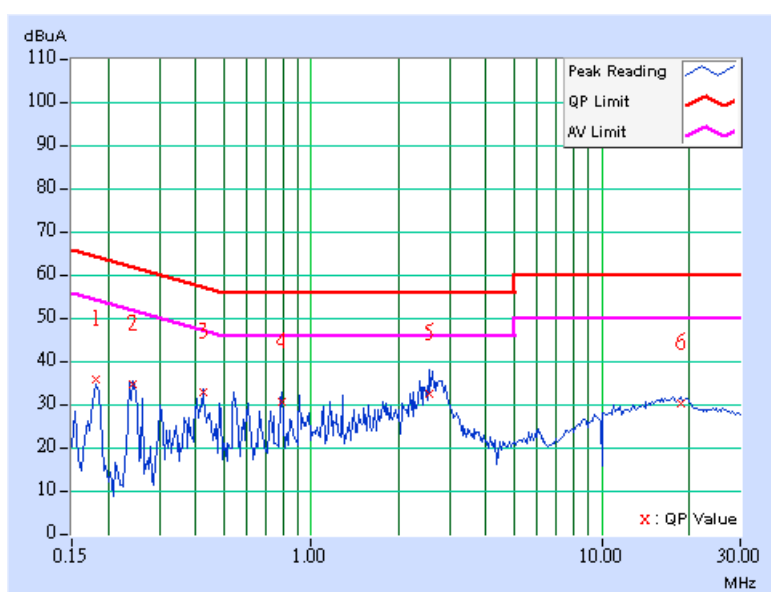

EUT TEST CONDITION		MEASUREMENT DETAIL	
CHANNEL	Channel 39	PHASE	Line 1
MODULATION TYPE	GFSK	6dB BANDWIDTH	9 kHz
ENVIRONMENTAL CONDITIONS	23deg. C, 68%RH, 991hPa	INPUT POWER (SYSTEM)	120Vac, 60 Hz
TEST MODE	A	TESTED BY	Match Tsui

No	Freq. [MHz]	Corr. Factor [dB]	Reading Value [dB (uV)]		Emission Level [dB (uV)]		Limit [dB (uV)]		Margin (dB)	
			Q.P.	AV.	Q.P.	AV.	Q.P.	AV.	Q.P.	AV.
			1	0.181	0.10	39.41	-	39.51	-	64.43
2	0.244	0.10	32.84	-	32.94	-	61.97	51.97	-29.03	-
3	0.611	0.10	34.89	-	34.99	-	56.00	46.00	-21.01	-
4	1.098	0.11	33.98	-	34.09	-	56.00	46.00	-21.91	-
5	2.195	0.22	39.00	-	39.22	-	56.00	46.00	-16.78	-
6	17.056	0.60	31.10	-	31.70	-	60.00	50.00	-28.30	-

- REMARKS:**
1. Q.P. and AV. are abbreviations of quasi-peak and average individually.
 2. "-": The Quasi-peak reading value also meets average limit and measurement with the average detector is unnecessary.
 3. The emission levels of other frequencies were very low against the limit.
 4. Margin value = Emission level - Limit value
 5. Correction factor = Insertion loss + Cable loss
 6. Emission Level = Correction Factor + Reading Value.

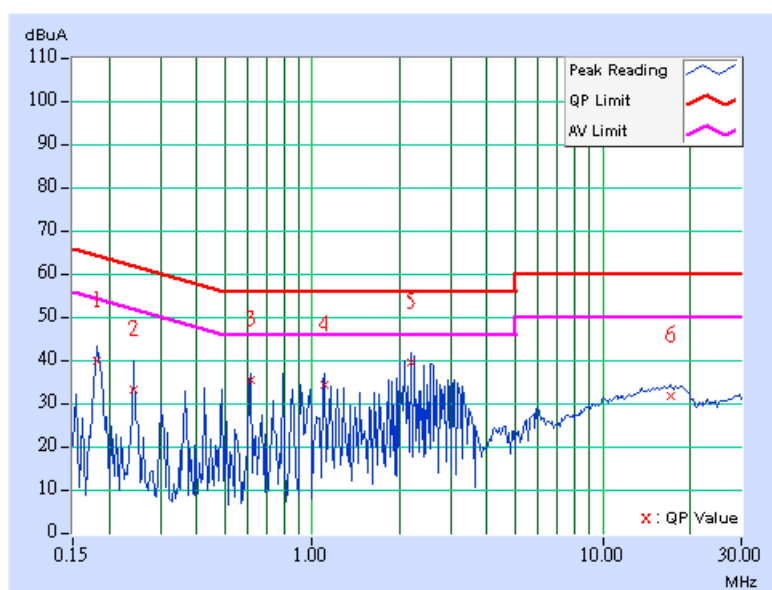

EUT TEST CONDITION		MEASUREMENT DETAIL	
CHANNEL	Channel 39	PHASE	Line 2
MODULATION TYPE	GFSK	6dB BANDWIDTH	9 kHz
ENVIRONMENTAL CONDITIONS	23deg. C, 68%RH, 991hPa	INPUT POWER (SYSTEM)	120Vac, 60 Hz
TEST MODE	A	TESTED BY	Match Tsui

No	Freq. [MHz]	Corr. Factor [dB]	Reading Value [dB (uV)]		Emission Level [dB (uV)]		Limit [dB (uV)]		Margin (dB)	
			Q.P.	AV.	Q.P.	AV.	Q.P.	AV.	Q.P.	AV.
			1	0.185	0.10	40.04	-	40.14	-	64.25
2	0.244	0.10	33.79	-	33.89	-	61.97	51.97	-28.08	-
3	0.486	0.11	33.84	-	33.95	-	56.24	46.24	-22.28	-
4	0.853	0.18	34.14	-	34.32	-	56.00	46.00	-21.68	-
5	2.316	0.23	37.80	-	38.03	-	56.00	46.00	-17.97	-
6	16.698	0.61	30.88	-	31.49	-	60.00	50.00	-28.51	-

- REMARKS:**
1. Q.P. and AV. are abbreviations of quasi-peak and average individually.
 2. "-": The Quasi-peak reading value also meets average limit and measurement with the average detector is unnecessary.
 3. The emission levels of other frequencies were very low against the limit.
 4. Margin value = Emission level - Limit value
 5. Correction factor = Insertion loss + Cable loss
 6. Emission Level = Correction Factor + Reading Value.

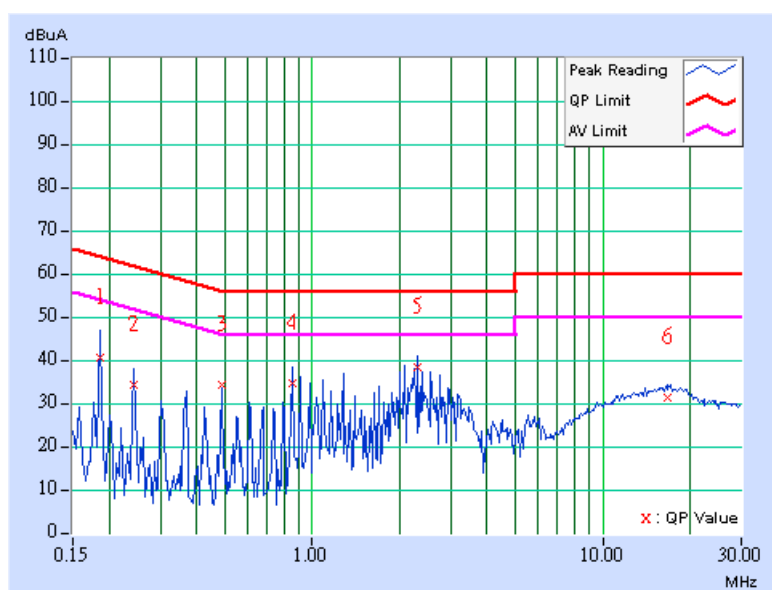

EUT TEST CONDITION		MEASUREMENT DETAIL	
CHANNEL	Channel 78	PHASE	Line 1
MODULATION TYPE	GFSK	6dB BANDWIDTH	9 kHz
ENVIRONMENTAL CONDITIONS	23deg. C, 68%RH, 991hPa	INPUT POWER (SYSTEM)	120Vac, 60 Hz
TEST MODE	A	TESTED BY	Match Tsui

No	Freq. [MHz]	Corr. Factor [dB]	Reading Value [dB (uV)]		Emission Level [dB (uV)]		Limit [dB (uV)]		Margin (dB)	
			Q.P.	AV.	Q.P.	AV.	Q.P.	AV.	Q.P.	AV.
			1	0.181	0.10	38.31	-	38.41	-	64.43
2	0.306	0.10	29.07	-	29.17	-	60.07	50.07	-30.90	-
3	0.611	0.10	34.12	-	34.22	-	56.00	46.00	-21.78	-
4	1.156	0.12	33.36	-	33.48	-	56.00	46.00	-22.52	-
5	2.680	0.26	36.02	-	36.28	-	56.00	46.00	-19.72	-
6	16.680	0.61	30.72	-	31.33	-	60.00	50.00	-28.67	-

- REMARKS:**
1. Q.P. and AV. are abbreviations of quasi-peak and average individually.
 2. "-": The Quasi-peak reading value also meets average limit and measurement with the average detector is unnecessary.
 3. The emission levels of other frequencies were very low against the limit.
 4. Margin value = Emission level - Limit value
 5. Correction factor = Insertion loss + Cable loss
 6. Emission Level = Correction Factor + Reading Value.

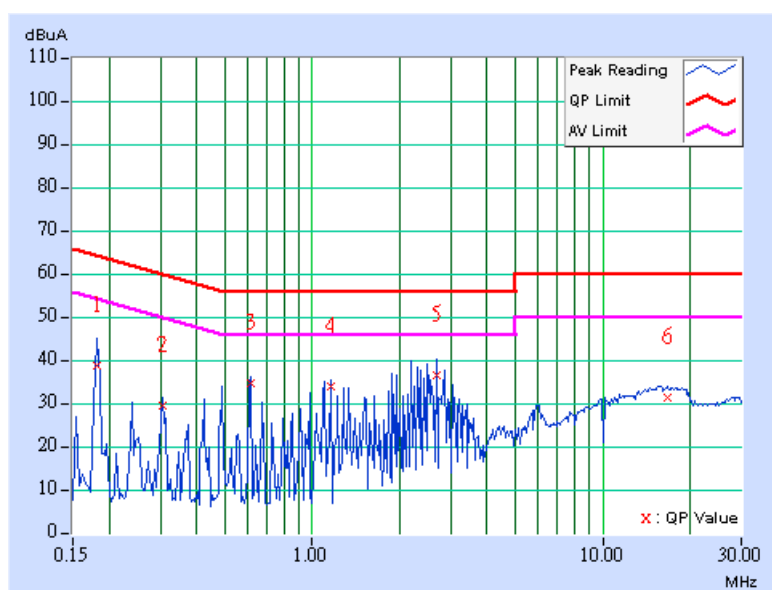

EUT TEST CONDITION		MEASUREMENT DETAIL	
CHANNEL	Channel 78	PHASE	Line 2
MODULATION TYPE	GFSK	6dB BANDWIDTH	9 kHz
ENVIRONMENTAL CONDITIONS	23deg. C, 68%RH, 991hPa	INPUT POWER (SYSTEM)	120Vac, 60 Hz
TEST MODE	A	TESTED BY	Match Tsui

No	Freq. [MHz]	Corr. Factor [dB]	Reading Value [dB (uV)]		Emission Level [dB (uV)]		Limit [dB (uV)]		Margin (dB)	
			Q.P.	AV.	Q.P.	AV.	Q.P.	AV.	Q.P.	AV.
			1	0.185	0.10	37.96	-	38.06	-	64.25
2	0.244	0.10	32.08	-	32.18	-	61.97	51.97	-29.79	-
3	0.489	0.11	34.39	-	34.50	-	56.19	46.19	-21.69	-
4	1.277	0.20	32.90	-	33.10	-	56.00	46.00	-22.90	-
5	2.617	0.25	36.33	-	36.58	-	56.00	46.00	-19.42	-
6	16.566	0.61	29.31	-	29.92	-	60.00	50.00	-30.08	-

- REMARKS:**
1. Q.P. and AV. are abbreviations of quasi-peak and average individually.
 2. "-": The Quasi-peak reading value also meets average limit and measurement with the average detector is unnecessary.
 3. The emission levels of other frequencies were very low against the limit.
 4. Margin value = Emission level - Limit value
 5. Correction factor = Insertion loss + Cable loss
 6. Emission Level = Correction Factor + Reading Value.

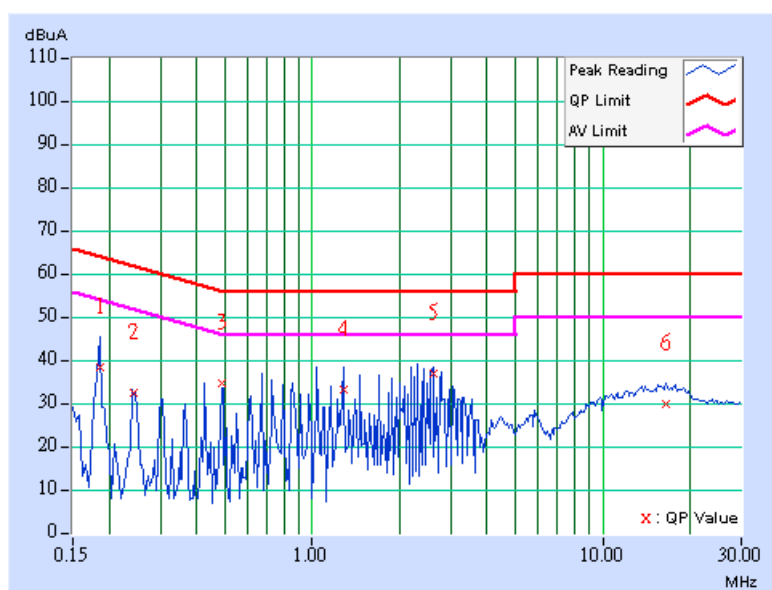

CONDUCTED WORST CASE DATA:

EUT TEST CONDITION		MEASUREMENT DETAIL	
CHANNEL	Channel 0	PHASE	Line 1
MODULATION TYPE	GFSK	6dB BANDWIDTH	9 kHz
ENVIRONMENTAL CONDITIONS	23deg. C, 68%RH, 991hPa	INPUT POWER (SYSTEM)	120Vac, 60 Hz
TEST MODE	B	TESTED BY	Lori Chiu

No	Freq. [MHz]	Corr. Factor [dB]	Reading Value [dB (uV)]		Emission Level [dB (uV)]		Limit [dB (uV)]		Margin (dB)	
			Q.P.	AV.	Q.P.	AV.	Q.P.	AV.	Q.P.	AV.
			1	0.314	0.10	39.50	-	39.60	-	59.86
2	0.400	0.10	47.55	-	47.65	-	57.86	47.86	-10.21	-
3	0.529	0.10	38.60	-	38.70	-	56.00	46.00	-17.30	-
4	0.927	0.10	35.90	-	36.00	-	56.00	46.00	-20.00	-
5	2.430	0.24	32.73	-	32.97	-	56.00	46.00	-23.03	-
6	8.293	0.36	34.40	-	34.76	-	60.00	50.00	-25.24	-

- REMARKS:**
1. Q.P. and AV. are abbreviations of quasi-peak and average individually.
 2. "-": The Quasi-peak reading value also meets average limit and measurement with the average detector is unnecessary.
 3. The emission levels of other frequencies were very low against the limit.
 4. Margin value = Emission level - Limit value
 5. Correction factor = Insertion loss + Cable loss
 6. Emission Level = Correction Factor + Reading Value.

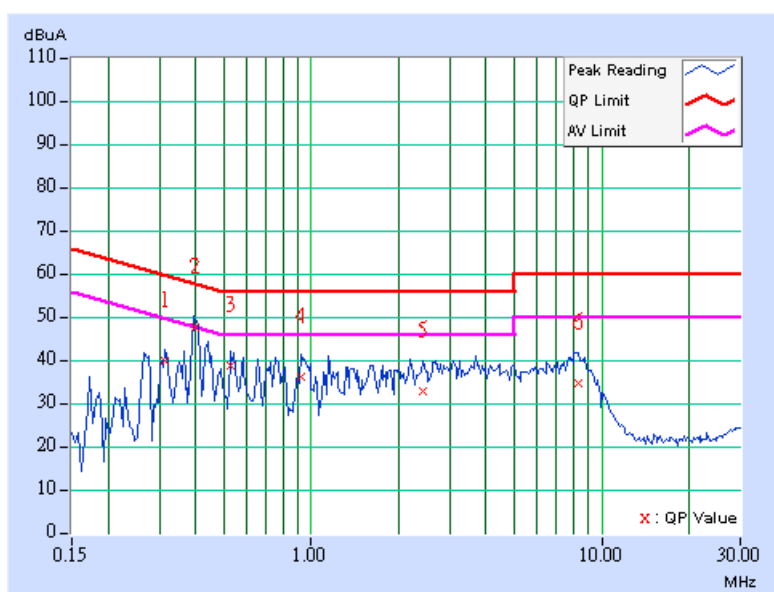

EUT TEST CONDITION		MEASUREMENT DETAIL	
CHANNEL	Channel 0	PHASE	Line 2
MODULATION TYPE	GFSK	6dB BANDWIDTH	9 kHz
ENVIRONMENTAL CONDITIONS	23deg. C, 68%RH, 991hPa	INPUT POWER (SYSTEM)	120Vac, 60 Hz
TEST MODE	B	TESTED BY	Lori Chiu

No	Freq. [MHz]	Corr. Factor (dB)	Reading Value [dB (uV)]		Emission Level [dB (uV)]		Limit [dB (uV)]		Margin (dB)	
			Q.P.	AV.	Q.P.	AV.	Q.P.	AV.	Q.P.	AV.
1	0.310	0.10	36.49	-	36.59	-	59.97	49.97	-23.38	-
2	0.404	0.10	44.98	-	45.08	-	57.77	47.77	-12.69	-
3	0.758	0.16	35.49	-	35.65	-	56.00	46.00	-20.35	-
4	1.586	0.20	30.12	-	30.32	-	56.00	46.00	-25.68	-
5	3.191	0.30	29.48	-	29.78	-	56.00	46.00	-26.22	-
6	8.379	0.44	32.75	-	33.19	-	60.00	50.00	-26.81	-

- REMARKS:**
1. Q.P. and AV. are abbreviations of quasi-peak and average individually.
 2. "-": The Quasi-peak reading value also meets average limit and measurement with the average detector is unnecessary.
 3. The emission levels of other frequencies were very low against the limit.
 4. Margin value = Emission level - Limit value
 5. Correction factor = Insertion loss + Cable loss
 6. Emission Level = Correction Factor + Reading Value.

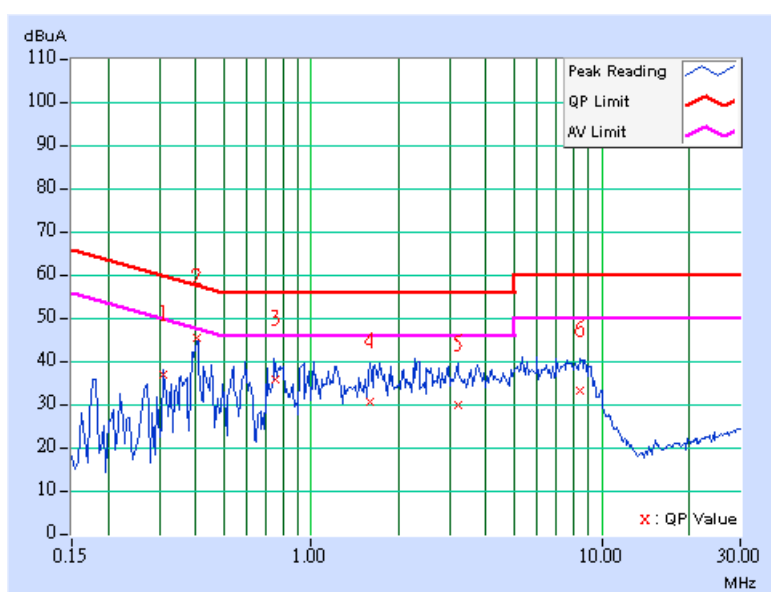

EUT TEST CONDITION		MEASUREMENT DETAIL	
CHANNEL	Channel 39	PHASE	Line 1
MODULATION TYPE	GFSK	6dB BANDWIDTH	9 kHz
ENVIRONMENTAL CONDITIONS	23deg. C, 68%RH, 991hPa	INPUT POWER (SYSTEM)	120Vac, 60 Hz
TEST MODE	B	TESTED BY	Lori Chiu

No	Freq.	Corr.	Reading Value		Emission Level		Limit		Margin	
	[MHz]	Factor	[dB (uV)]		[dB (uV)]		[dB (uV)]		(dB)	
		(dB)	Q.P.	AV.	Q.P.	AV.	Q.P.	AV.	Q.P.	AV.
1	0.310	0.10	39.13	-	39.23	-	59.97	49.97	-20.74	-
2	0.400	0.10	46.99	-	47.09	-	57.85	47.85	-10.76	-
3	0.740	0.10	34.13	-	34.23	-	56.00	46.00	-21.77	-
4	0.982	0.10	33.21	-	33.31	-	56.00	46.00	-22.69	-
5	2.238	0.22	32.40	-	32.62	-	56.00	46.00	-23.38	-
6	8.340	0.36	34.08	-	34.44	-	60.00	50.00	-25.56	-

- REMARKS:**
1. Q.P. and AV. are abbreviations of quasi-peak and average individually.
 2. "-": The Quasi-peak reading value also meets average limit and measurement with the average detector is unnecessary.
 3. The emission levels of other frequencies were very low against the limit.
 4. Margin value = Emission level - Limit value
 5. Correction factor = Insertion loss + Cable loss
 6. Emission Level = Correction Factor + Reading Value.

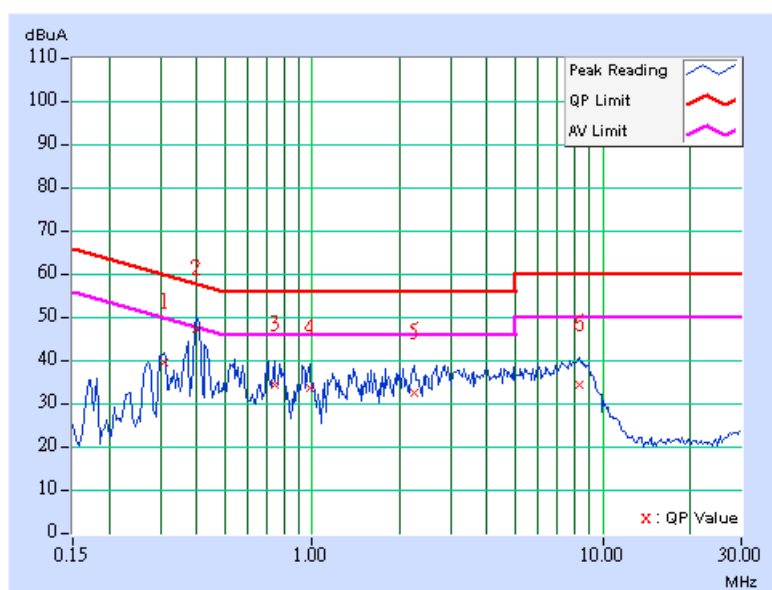

EUT TEST CONDITION		MEASUREMENT DETAIL	
CHANNEL	Channel 39	PHASE	Line 2
MODULATION TYPE	GFSK	6dB BANDWIDTH	9 kHz
ENVIRONMENTAL CONDITIONS	23deg. C, 68%RH, 991hPa	INPUT POWER (SYSTEM)	120Vac, 60 Hz
TEST MODE	B	TESTED BY	Lori Chiu

No	Freq. [MHz]	Corr. Factor [dB]	Reading Value [dB (uV)]		Emission Level [dB (uV)]		Limit [dB (uV)]		Margin (dB)	
			Q.P.	AV.	Q.P.	AV.	Q.P.	AV.	Q.P.	AV.
			1	0.271	0.10	33.98	-	34.08	-	61.08
2	0.402	0.10	44.16	-	44.26	-	57.80	47.80	-13.54	-
3	0.584	0.13	33.29	-	33.42	-	56.00	46.00	-22.58	-
4	1.254	0.20	29.43	-	29.63	-	56.00	46.00	-26.37	-
5	3.930	0.36	28.28	-	28.64	-	56.00	46.00	-27.36	-
6	7.965	0.43	31.57	-	32.00	-	60.00	50.00	-28.00	-

- REMARKS:**
1. Q.P. and AV. are abbreviations of quasi-peak and average individually.
 2. "-": The Quasi-peak reading value also meets average limit and measurement with the average detector is unnecessary.
 3. The emission levels of other frequencies were very low against the limit.
 4. Margin value = Emission level - Limit value
 5. Correction factor = Insertion loss + Cable loss
 6. Emission Level = Correction Factor + Reading Value.

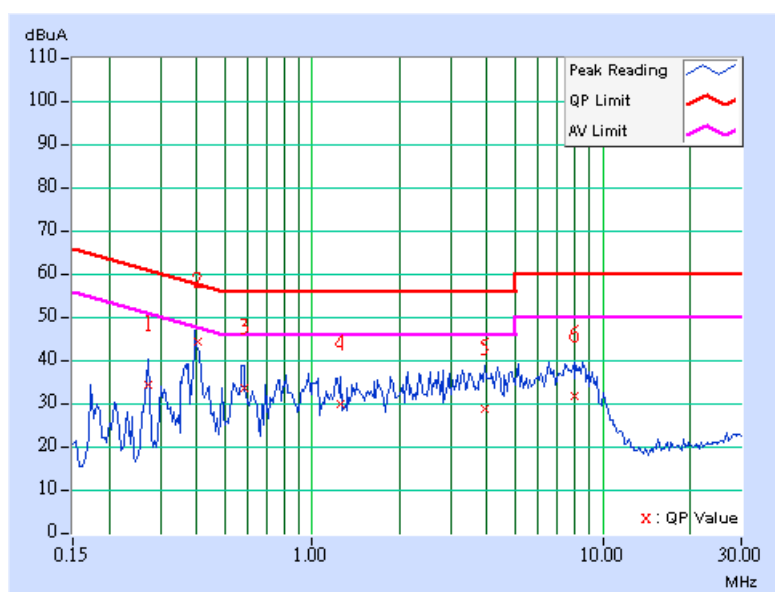

EUT TEST CONDITION		MEASUREMENT DETAIL	
CHANNEL	Channel 78	PHASE	Line 1
MODULATION TYPE	GFSK	6dB BANDWIDTH	9 kHz
ENVIRONMENTAL CONDITIONS	23deg. C, 68%RH, 991hPa	INPUT POWER (SYSTEM)	120Vac, 60 Hz
TEST MODE	B	TESTED BY	Lori Chiu

No	Freq.	Corr.	Reading Value		Emission Level		Limit		Margin	
	[MHz]	Factor	[dB (uV)]		[dB (uV)]		[dB (uV)]		(dB)	
		(dB)	Q.P.	AV.	Q.P.	AV.	Q.P.	AV.	Q.P.	AV.
1	0.314	0.10	38.17	-	38.27	-	59.86	49.86	-21.59	-
2	0.405	0.10	46.22	-	46.32	-	57.74	47.74	-11.42	-
3	0.529	0.10	37.25	-	37.35	-	56.00	46.00	-18.65	-
4	1.152	0.12	32.81	-	32.93	-	56.00	46.00	-23.07	-
5	2.852	0.27	31.67	-	31.94	-	56.00	46.00	-24.06	-
6	8.566	0.36	33.62	-	33.98	-	60.00	50.00	-26.02	-

- REMARKS:**
1. Q.P. and AV. are abbreviations of quasi-peak and average individually.
 2. "-": The Quasi-peak reading value also meets average limit and measurement with the average detector is unnecessary.
 3. The emission levels of other frequencies were very low against the limit.
 4. Margin value = Emission level - Limit value
 5. Correction factor = Insertion loss + Cable loss
 6. Emission Level = Correction Factor + Reading Value.

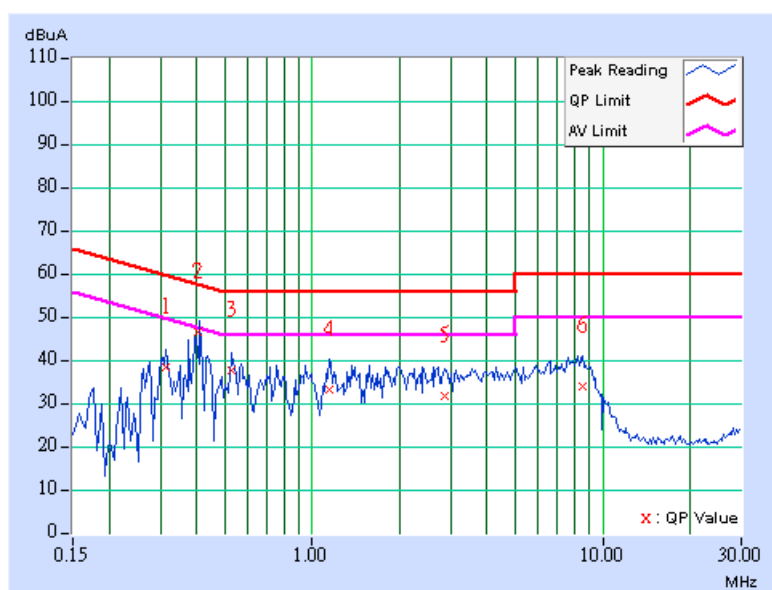

EUT TEST CONDITION		MEASUREMENT DETAIL	
CHANNEL	Channel 78	PHASE	Line 2
MODULATION TYPE	GFSK	6dB BANDWIDTH	9 kHz
ENVIRONMENTAL CONDITIONS	23deg. C, 68%RH, 991hPa	INPUT POWER (SYSTEM)	120Vac, 60 Hz
TEST MODE	B	TESTED BY	Lori Chiu

No	Freq. [MHz]	Corr. Factor [dB]	Reading Value [dB (uV)]		Emission Level [dB (uV)]		Limit [dB (uV)]		Margin (dB)	
			Q.P.	AV.	Q.P.	AV.	Q.P.	AV.	Q.P.	AV.
			1	0.353	0.10	33.94	-	34.04	-	58.89
2	0.397	0.10	43.96	-	44.06	-	57.91	47.91	-13.85	-
3	0.930	0.19	32.99	-	33.18	-	56.00	46.00	-22.82	-
4	2.043	0.20	28.71	-	28.91	-	56.00	46.00	-27.09	-
5	3.738	0.35	29.52	-	29.87	-	56.00	46.00	-26.13	-
6	8.809	0.44	30.99	-	31.43	-	60.00	50.00	-28.57	-

- REMARKS:**
1. Q.P. and AV. are abbreviations of quasi-peak and average individually.
 2. "-": The Quasi-peak reading value also meets average limit and measurement with the average detector is unnecessary.
 3. The emission levels of other frequencies were very low against the limit.
 4. Margin value = Emission level - Limit value
 5. Correction factor = Insertion loss + Cable loss
 6. Emission Level = Correction Factor + Reading Value.

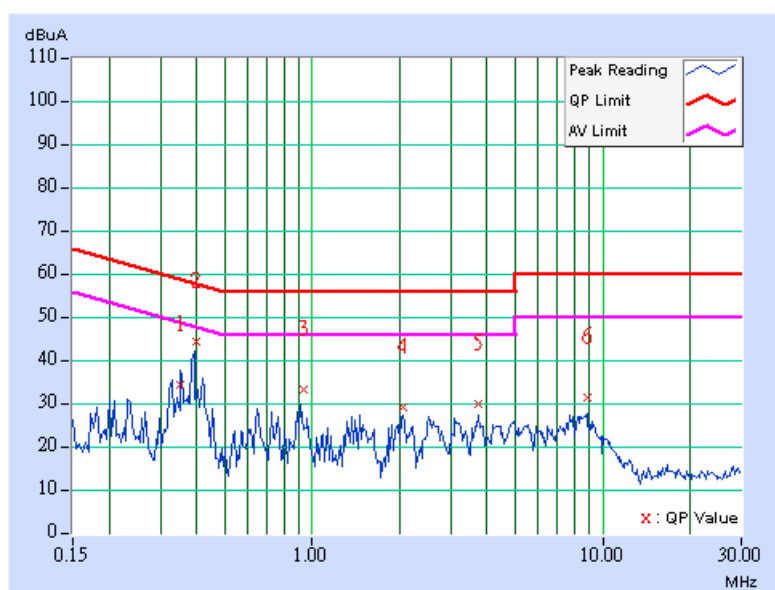

EUT TEST CONDITION		MEASUREMENT DETAIL	
CHANNEL	Channel 0	PHASE	Line 1
MODULATION TYPE	GFSK	6dB BANDWIDTH	9 kHz
ENVIRONMENTAL CONDITIONS	23deg. C, 68%RH, 991hPa	INPUT POWER (SYSTEM)	120Vac, 60 Hz
TEST MODE	C	TESTED BY	Match Tsui

No	Freq. [MHz]	Corr. Factor [dB]	Reading Value [dB (uV)]		Emission Level [dB (uV)]		Limit [dB (uV)]		Margin (dB)	
			Q.P.	AV.	Q.P.	AV.	Q.P.	AV.	Q.P.	AV.
1	0.185	0.10	35.69	-	35.79	-	64.25	54.25	-28.46	-
2	0.244	0.10	29.35	-	29.45	-	61.97	51.97	-32.52	-
3	0.607	0.10	33.58	-	33.68	-	56.00	46.00	-22.32	-
4	1.094	0.11	33.36	-	33.47	-	56.00	46.00	-22.53	-
5	2.371	0.23	41.19	-	41.42	-	56.00	46.00	-14.58	-
6	15.559	0.62	32.63	-	33.25	-	60.00	50.00	-26.75	-

- REMARKS:**
1. Q.P. and AV. are abbreviations of quasi-peak and average individually.
 2. "-": The Quasi-peak reading value also meets average limit and measurement with the average detector is unnecessary.
 3. The emission levels of other frequencies were very low against the limit.
 4. Margin value = Emission level - Limit value
 5. Correction factor = Insertion loss + Cable loss
 6. Emission Level = Correction Factor + Reading Value.

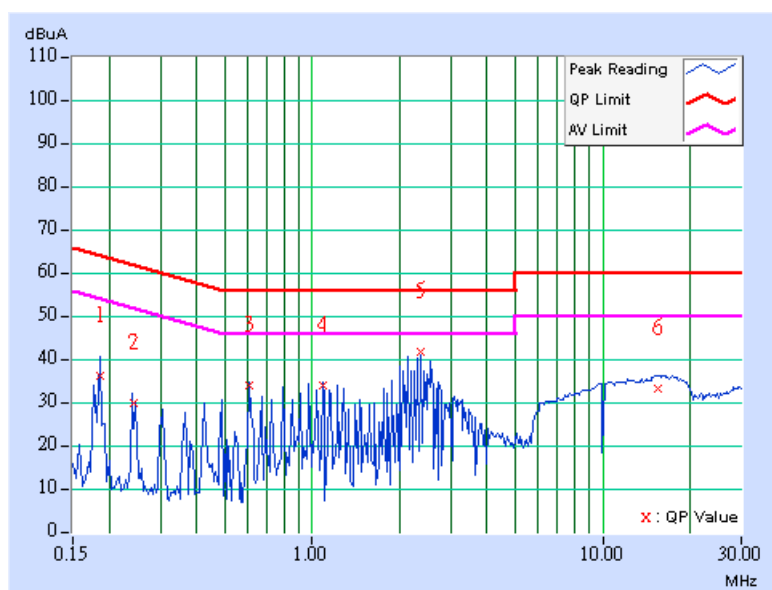

EUT TEST CONDITION		MEASUREMENT DETAIL	
CHANNEL	Channel 0	PHASE	Line 2
MODULATION TYPE	GFSK	6dB BANDWIDTH	9 kHz
ENVIRONMENTAL CONDITIONS	23deg. C, 68%RH, 991hPa	INPUT POWER (SYSTEM)	120Vac, 60 Hz
TEST MODE	C	TESTED BY	Match Tsui

No	Freq. [MHz]	Corr. Factor [dB]	Reading Value [dB (uV)]		Emission Level [dB (uV)]		Limit [dB (uV)]		Margin (dB)	
			Q.P.	AV.	Q.P.	AV.	Q.P.	AV.	Q.P.	AV.
1	0.182	0.10	36.98	-	37.08	-	64.37	54.37	-27.29	-
2	0.244	0.10	30.53	-	30.63	-	61.97	51.97	-31.34	-
3	0.668	0.14	31.11	-	31.25	-	56.00	46.00	-24.75	-
4	1.034	0.20	31.21	-	31.41	-	56.00	46.00	-24.59	-
5	2.188	0.22	39.04	-	39.26	-	56.00	46.00	-16.74	-
6	15.376	0.62	33.84	-	34.46	-	60.00	50.00	-25.54	-

- REMARKS:**
1. Q.P. and AV. are abbreviations of quasi-peak and average individually.
 2. "-": The Quasi-peak reading value also meets average limit and measurement with the average detector is unnecessary.
 3. The emission levels of other frequencies were very low against the limit.
 4. Margin value = Emission level - Limit value
 5. Correction factor = Insertion loss + Cable loss
 6. Emission Level = Correction Factor + Reading Value.

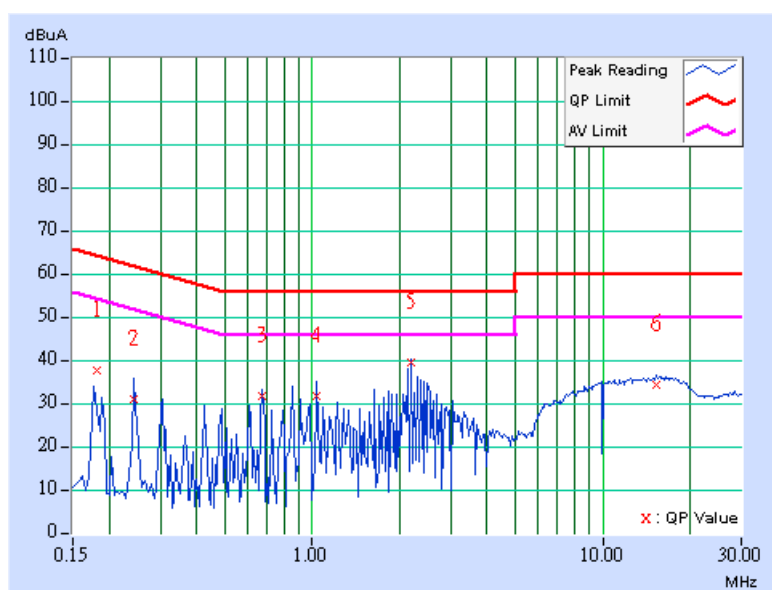

EUT TEST CONDITION		MEASUREMENT DETAIL	
CHANNEL	Channel 39	PHASE	Line 1
MODULATION TYPE	GFSK	6dB BANDWIDTH	9 kHz
ENVIRONMENTAL CONDITIONS	23deg. C, 68%RH, 991hPa	INPUT POWER (SYSTEM)	120Vac, 60 Hz
TEST MODE	C	TESTED BY	Match Tsui

No	Freq. [MHz]	Corr. Factor [dB]	Reading Value [dB (uV)]		Emission Level [dB (uV)]		Limit [dB (uV)]		Margin (dB)	
			Q.P.	AV.	Q.P.	AV.	Q.P.	AV.	Q.P.	AV.
			1	0.182	0.10	36.35	-	36.45	-	64.37
2	0.306	0.10	26.82	-	26.92	-	60.07	50.07	-33.15	-
3	0.607	0.10	33.60	-	33.70	-	56.00	46.00	-22.30	-
4	0.970	0.10	33.77	-	33.87	-	56.00	46.00	-22.13	-
5	2.371	0.23	40.95	-	41.18	-	56.00	46.00	-14.82	-
6	16.586	0.61	33.34	-	33.95	-	60.00	50.00	-26.05	-

- REMARKS:**
1. Q.P. and AV. are abbreviations of quasi-peak and average individually.
 2. "-": The Quasi-peak reading value also meets average limit and measurement with the average detector is unnecessary.
 3. The emission levels of other frequencies were very low against the limit.
 4. Margin value = Emission level - Limit value
 5. Correction factor = Insertion loss + Cable loss
 6. Emission Level = Correction Factor + Reading Value.

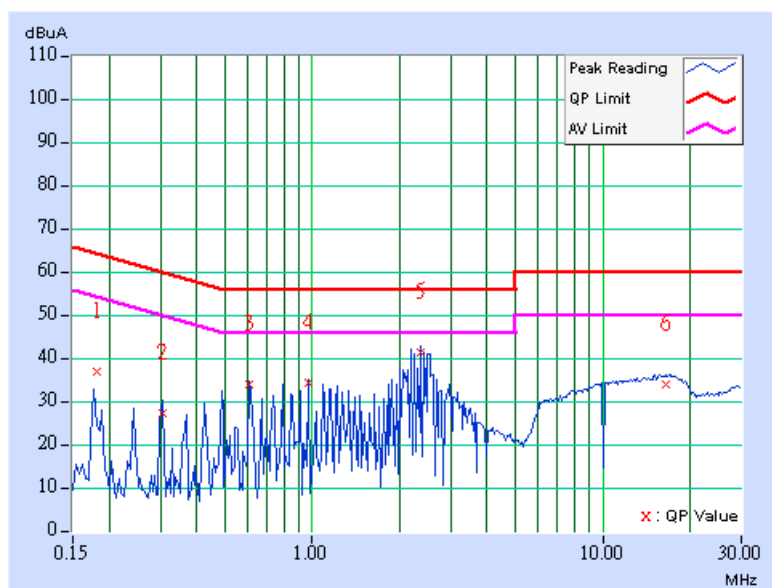

EUT TEST CONDITION		MEASUREMENT DETAIL	
CHANNEL	Channel 39	PHASE	Line 2
MODULATION TYPE	GFSK	6dB BANDWIDTH	9 kHz
ENVIRONMENTAL CONDITIONS	23deg. C, 68%RH, 991hPa	INPUT POWER (SYSTEM)	120Vac, 60 Hz
TEST MODE	C	TESTED BY	Match Tsui

No	Freq. [MHz]	Corr. Factor [dB]	Reading Value [dB (uV)]		Emission Level [dB (uV)]		Limit [dB (uV)]		Margin (dB)	
			Q.P.	AV.	Q.P.	AV.	Q.P.	AV.	Q.P.	AV.
			1	0.185	0.10	35.50	-	35.60	-	64.25
2	0.240	0.10	28.29	-	28.39	-	62.10	52.10	-33.71	-
3	0.487	0.11	31.64	-	31.75	-	56.22	46.22	-24.46	-
4	1.277	0.20	29.64	-	29.84	-	56.00	46.00	-26.16	-
5	2.246	0.22	37.65	-	37.87	-	56.00	46.00	-18.13	-
6	17.984	0.59	32.99	-	33.58	-	60.00	50.00	-26.42	-

- REMARKS:**
1. Q.P. and AV. are abbreviations of quasi-peak and average individually.
 2. "-": The Quasi-peak reading value also meets average limit and measurement with the average detector is unnecessary.
 3. The emission levels of other frequencies were very low against the limit.
 4. Margin value = Emission level - Limit value
 5. Correction factor = Insertion loss + Cable loss
 6. Emission Level = Correction Factor + Reading Value.

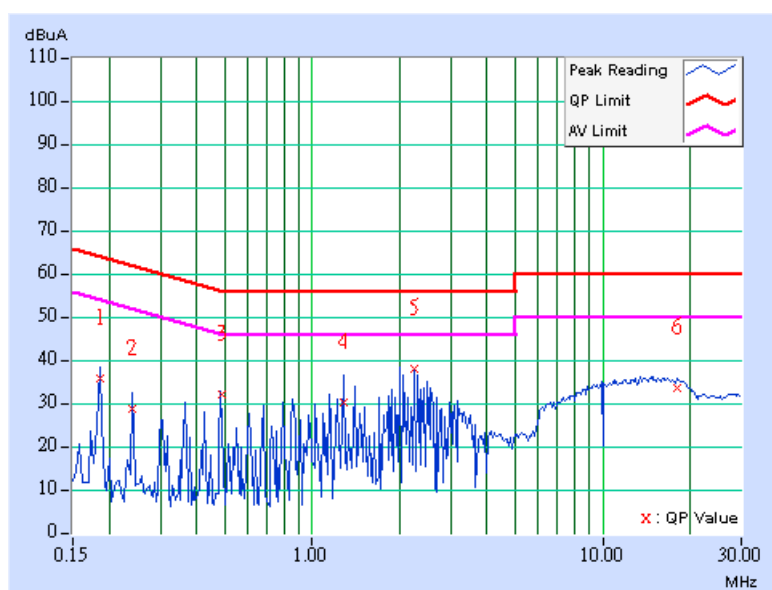

EUT TEST CONDITION		MEASUREMENT DETAIL	
CHANNEL	Channel 78	PHASE	Line 1
MODULATION TYPE	GFSK	6dB BANDWIDTH	9 kHz
ENVIRONMENTAL CONDITIONS	23deg. C, 68%RH, 991hPa	INPUT POWER (SYSTEM)	120Vac, 60 Hz
TEST MODE	C	TESTED BY	Match Tsui

No	Freq. [MHz]	Corr. Factor [dB]	Reading Value [dB (uV)]		Emission Level [dB (uV)]		Limit [dB (uV)]		Margin (dB)	
			Q.P.	AV.	Q.P.	AV.	Q.P.	AV.	Q.P.	AV.
			1	0.181	0.10	35.75	-	35.85	-	64.43
2	0.302	0.10	27.74	-	27.84	-	60.18	50.18	-32.34	-
3	0.607	0.10	33.58	-	33.68	-	56.00	46.00	-22.32	-
4	1.215	0.12	28.10	-	28.22	-	56.00	46.00	-27.78	-
5	2.246	0.22	39.21	-	39.43	-	56.00	46.00	-16.57	-
6	16.219	0.61	33.57	-	34.18	-	60.00	50.00	-25.82	-

- REMARKS:**
1. Q.P. and AV. are abbreviations of quasi-peak and average individually.
 2. "-": The Quasi-peak reading value also meets average limit and measurement with the average detector is unnecessary.
 3. The emission levels of other frequencies were very low against the limit.
 4. Margin value = Emission level - Limit value
 5. Correction factor = Insertion loss + Cable loss
 6. Emission Level = Correction Factor + Reading Value.

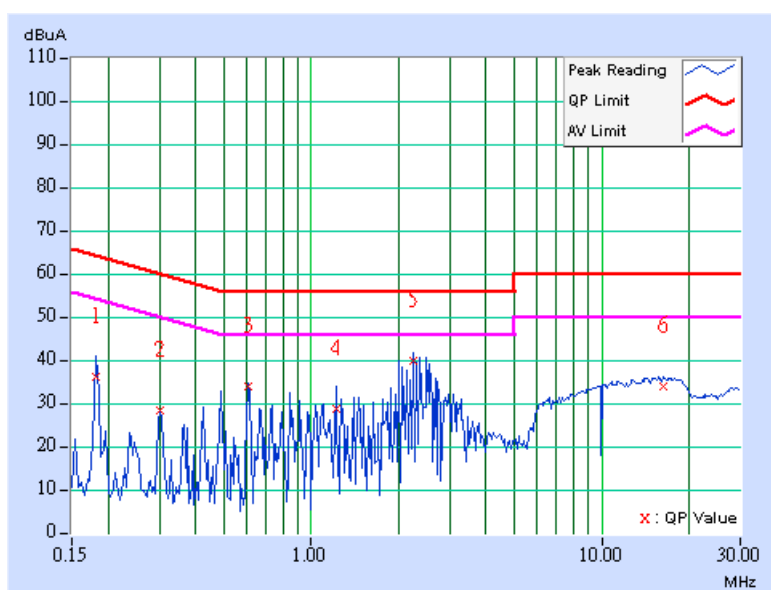

EUT TEST CONDITION		MEASUREMENT DETAIL	
CHANNEL	Channel 78	PHASE	Line 2
MODULATION TYPE	GFSK	6dB BANDWIDTH	9 kHz
ENVIRONMENTAL CONDITIONS	23deg. C, 68%RH, 991hPa	INPUT POWER (SYSTEM)	120Vac, 60 Hz
TEST MODE	C	TESTED BY	Match Tsui

No	Freq. [MHz]	Corr. Factor [dB]	Reading Value [dB (uV)]		Emission Level [dB (uV)]		Limit [dB (uV)]		Margin (dB)	
			Q.P.	AV.	Q.P.	AV.	Q.P.	AV.	Q.P.	AV.
			1	0.181	0.10	35.83	-	35.93	-	64.43
2	0.302	0.10	25.91	-	26.01	-	60.18	50.18	-34.17	-
3	0.853	0.18	31.30	-	31.48	-	56.00	46.00	-24.52	-
4	1.219	0.20	29.83	-	30.03	-	56.00	46.00	-25.97	-
5	2.371	0.23	39.14	-	39.37	-	56.00	46.00	-16.63	-
6	15.734	0.62	33.64	-	34.26	-	60.00	50.00	-25.74	-

- REMARKS:**
1. Q.P. and AV. are abbreviations of quasi-peak and average individually.
 2. "-": The Quasi-peak reading value also meets average limit and measurement with the average detector is unnecessary.
 3. The emission levels of other frequencies were very low against the limit.
 4. Margin value = Emission level - Limit value
 5. Correction factor = Insertion loss + Cable loss
 6. Emission Level = Correction Factor + Reading Value.

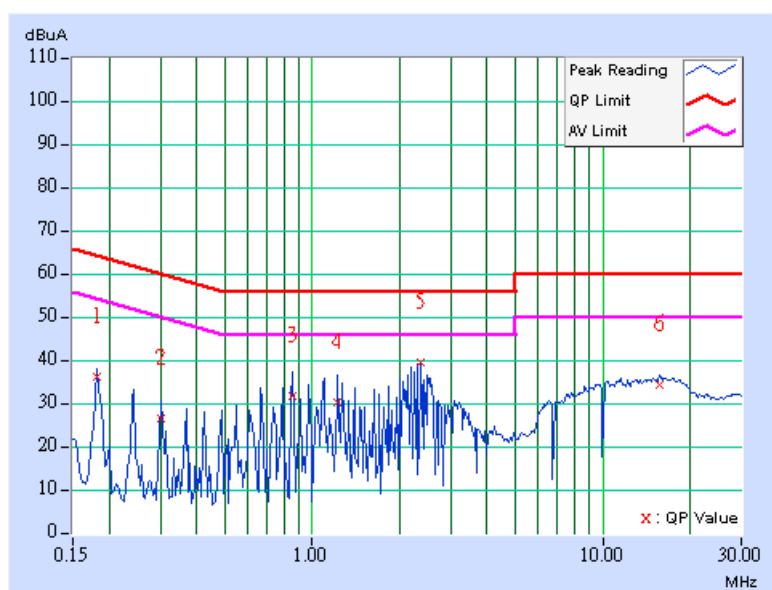

EUT TEST CONDITION		MEASUREMENT DETAIL	
CHANNEL	Channel 0	PHASE	Line 1
MODULATION TYPE	GFSK	6dB BANDWIDTH	9 kHz
ENVIRONMENTAL CONDITIONS	23deg. C, 68%RH, 991hPa	INPUT POWER (SYSTEM)	120Vac, 60 Hz
TEST MODE	D	TESTED BY	Match Tsui

No	Freq. [MHz]	Corr. Factor [dB]	Reading Value [dB (uV)]		Emission Level [dB (uV)]		Limit [dB (uV)]		Margin (dB)	
			Q.P.	AV.	Q.P.	AV.	Q.P.	AV.	Q.P.	AV.
			1	0.412	0.10	44.27	-	44.37	-	57.61
2	0.541	0.10	43.85	-	43.95	-	56.00	46.00	-12.05	-
3	1.195	0.12	40.49	-	40.61	-	56.00	46.00	-15.39	-
4	2.348	0.23	38.65	-	38.88	-	56.00	46.00	-17.12	-
5	3.656	0.34	39.00	-	39.34	-	56.00	46.00	-16.66	-
6	7.695	0.36	40.63	-	40.99	-	60.00	50.00	-19.01	-

- REMARKS:**
1. Q.P. and AV. are abbreviations of quasi-peak and average individually.
 2. "-": The Quasi-peak reading value also meets average limit and measurement with the average detector is unnecessary.
 3. The emission levels of other frequencies were very low against the limit.
 4. Margin value = Emission level - Limit value
 5. Correction factor = Insertion loss + Cable loss
 6. Emission Level = Correction Factor + Reading Value.

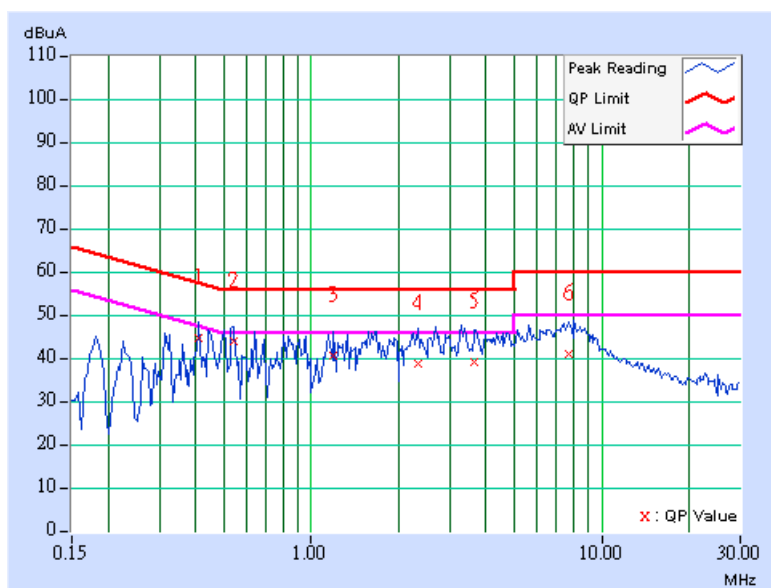

EUT TEST CONDITION		MEASUREMENT DETAIL	
CHANNEL	Channel 0	PHASE	Line 2
MODULATION TYPE	GFSK	6dB BANDWIDTH	9 kHz
ENVIRONMENTAL CONDITIONS	23deg. C, 68%RH, 991hPa	INPUT POWER (SYSTEM)	120Vac, 60 Hz
TEST MODE	D	TESTED BY	Match Tsui

No	Freq. [MHz]	Corr. Factor [dB]	Reading Value [dB (uV)]		Emission Level [dB (uV)]		Limit [dB (uV)]		Margin (dB)	
			Q.P.	AV.	Q.P.	AV.	Q.P.	AV.	Q.P.	AV.
			1	0.315	0.10	41.06	-	41.16	-	59.83
2	0.455	0.11	38.78	-	38.89	-	56.79	46.79	-17.90	-
3	1.184	0.20	38.67	-	38.87	-	56.00	46.00	-17.13	-
4	2.270	0.22	36.52	-	36.74	-	56.00	46.00	-19.26	-
5	4.480	0.38	35.37	-	35.75	-	56.00	46.00	-20.25	-
6	7.934	0.43	36.50	-	36.93	-	60.00	50.00	-23.07	-

- REMARKS:**
1. Q.P. and AV. are abbreviations of quasi-peak and average individually.
 2. "-": The Quasi-peak reading value also meets average limit and measurement with the average detector is unnecessary.
 3. The emission levels of other frequencies were very low against the limit.
 4. Margin value = Emission level - Limit value
 5. Correction factor = Insertion loss + Cable loss
 6. Emission Level = Correction Factor + Reading Value.

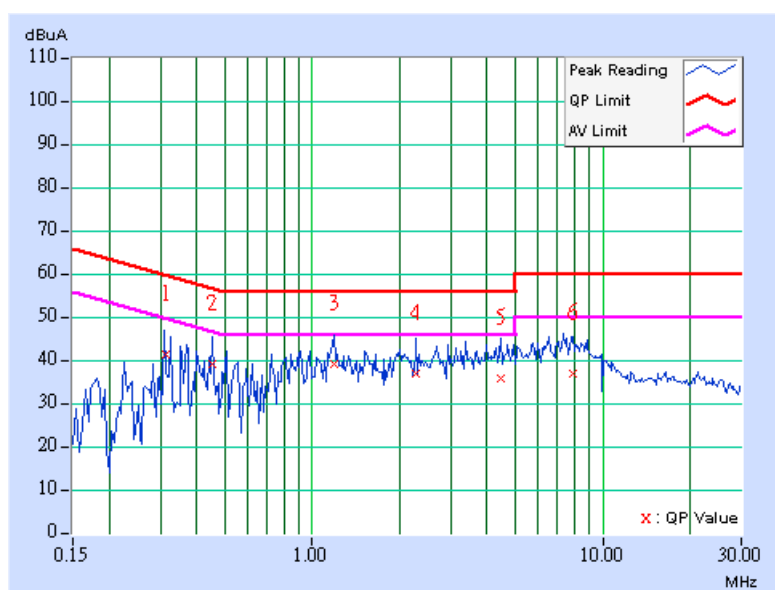

EUT TEST CONDITION		MEASUREMENT DETAIL	
CHANNEL	Channel 39	PHASE	Line 1
MODULATION TYPE	GFSK	6dB BANDWIDTH	9 kHz
ENVIRONMENTAL CONDITIONS	23deg. C, 68%RH, 991hPa	INPUT POWER (SYSTEM)	120Vac, 60 Hz
TEST MODE	D	TESTED BY	Match Tsui

No	Freq. [MHz]	Corr. Factor [dB]	Reading Value [dB (uV)]		Emission Level [dB (uV)]		Limit [dB (uV)]		Margin (dB)	
			Q.P.	AV.	Q.P.	AV.	Q.P.	AV.	Q.P.	AV.
			1	0.408	0.10	44.22	-	44.32	-	57.69
2	0.634	0.10	41.27	-	41.37	-	56.00	46.00	-14.63	-
3	0.896	0.10	40.06	-	40.16	-	56.00	46.00	-15.84	-
4	1.559	0.16	39.59	-	39.75	-	56.00	46.00	-16.25	-
5	3.723	0.35	39.26	-	39.61	-	56.00	46.00	-16.39	-
6	8.672	0.36	41.54	-	41.90	-	60.00	50.00	-18.10	-

- REMARKS:**
1. Q.P. and AV. are abbreviations of quasi-peak and average individually.
 2. "-": The Quasi-peak reading value also meets average limit and measurement with the average detector is unnecessary.
 3. The emission levels of other frequencies were very low against the limit.
 4. Margin value = Emission level - Limit value
 5. Correction factor = Insertion loss + Cable loss
 6. Emission Level = Correction Factor + Reading Value.

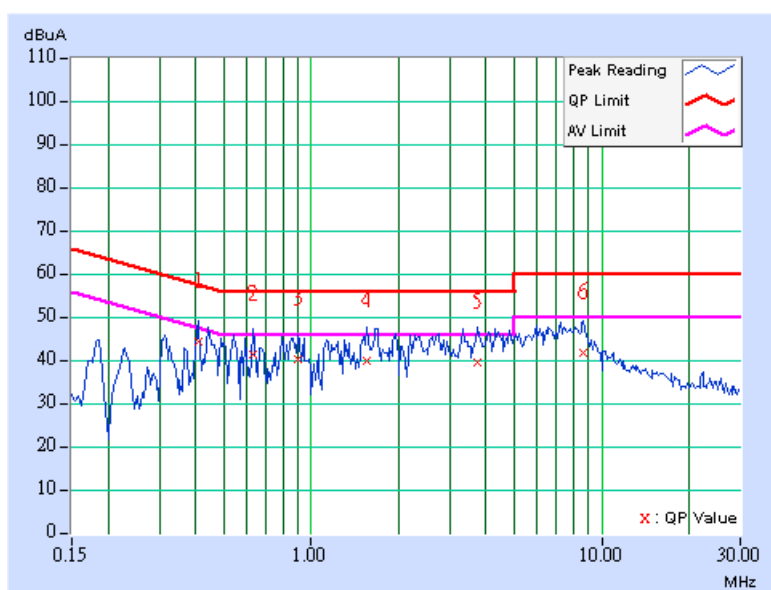

EUT TEST CONDITION		MEASUREMENT DETAIL	
CHANNEL	Channel 39	PHASE	Line 1
MODULATION TYPE	GFSK	6dB BANDWIDTH	9 kHz
ENVIRONMENTAL CONDITIONS	23deg. C, 68%RH, 991hPa	INPUT POWER (SYSTEM)	120Vac, 60 Hz
TEST MODE	D	TESTED BY	Match Tsui

No	Freq. [MHz]	Corr. Factor [dB]	Reading Value [dB (uV)]		Emission Level [dB (uV)]		Limit [dB (uV)]		Margin (dB)	
			Q.P.	AV.	Q.P.	AV.	Q.P.	AV.	Q.P.	AV.
			1	0.427	0.10	36.16	-	36.26	-	57.30
2	0.814	0.17	36.19	-	36.36	-	56.00	46.00	-19.64	-
3	1.172	0.20	39.44	-	39.64	-	56.00	46.00	-16.36	-
4	2.695	0.26	36.20	-	36.46	-	56.00	46.00	-19.54	-
5	4.859	0.38	36.48	-	36.86	-	56.00	46.00	-19.14	-
6	8.707	0.44	36.56	-	37.00	-	60.00	50.00	-23.00	-

- REMARKS:**
1. Q.P. and AV. are abbreviations of quasi-peak and average individually.
 2. "-": The Quasi-peak reading value also meets average limit and measurement with the average detector is unnecessary.
 3. The emission levels of other frequencies were very low against the limit.
 4. Margin value = Emission level - Limit value
 5. Correction factor = Insertion loss + Cable loss
 6. Emission Level = Correction Factor + Reading Value.

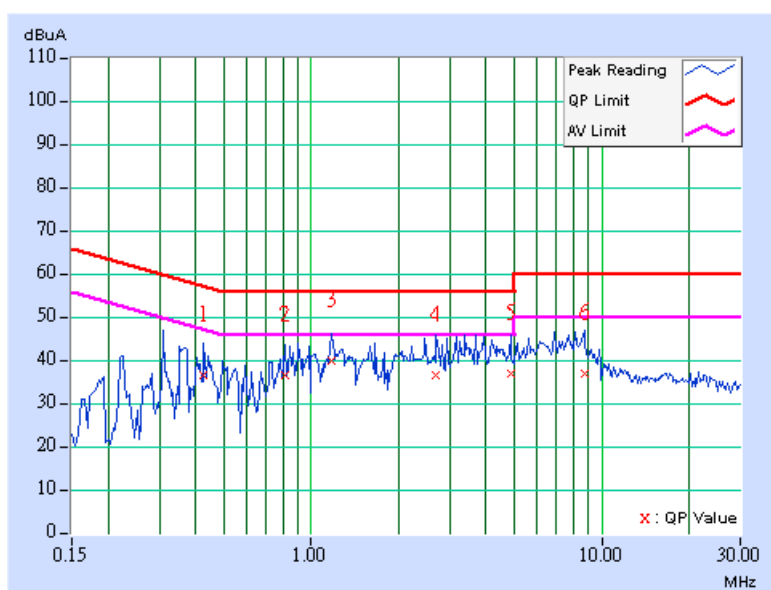

EUT TEST CONDITION		MEASUREMENT DETAIL	
CHANNEL	Channel 78	PHASE	Line 1
MODULATION TYPE	GFSK	6dB BANDWIDTH	9 kHz
ENVIRONMENTAL CONDITIONS	23deg. C, 68%RH, 991hPa	INPUT POWER (SYSTEM)	120Vac, 60 Hz
TEST MODE	D	TESTED BY	Match Tsui

No	Freq. [MHz]	Corr. Factor [dB]	Reading Value [dB (uV)]		Emission Level [dB (uV)]		Limit [dB (uV)]		Margin (dB)	
			Q.P.	AV.	Q.P.	AV.	Q.P.	AV.	Q.P.	AV.
			1	0.408	0.10	44.22	-	44.32	-	57.69
2	0.541	0.10	43.73	-	43.83	-	56.00	46.00	-12.17	-
3	0.845	0.10	41.81	-	41.91	-	56.00	46.00	-14.09	-
4	1.652	0.17	39.70	-	39.87	-	56.00	46.00	-16.13	-
5	3.359	0.32	39.87	-	40.19	-	56.00	46.00	-15.81	-
6	8.434	0.36	41.35	-	41.71	-	60.00	50.00	-18.29	-

- REMARKS:**
1. Q.P. and AV. are abbreviations of quasi-peak and average individually.
 2. "-": The Quasi-peak reading value also meets average limit and measurement with the average detector is unnecessary.
 3. The emission levels of other frequencies were very low against the limit.
 4. Margin value = Emission level - Limit value
 5. Correction factor = Insertion loss + Cable loss
 6. Emission Level = Correction Factor + Reading Value.

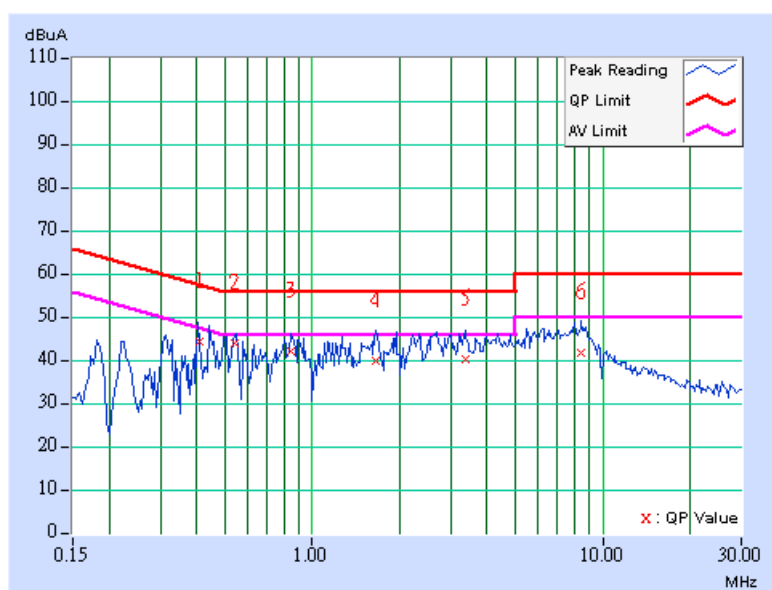

EUT TEST CONDITION		MEASUREMENT DETAIL	
CHANNEL	Channel 78	PHASE	Line 2
MODULATION TYPE	GFSK	6dB BANDWIDTH	9 kHz
ENVIRONMENTAL CONDITIONS	23deg. C, 68%RH, 991hPa	INPUT POWER (SYSTEM)	120Vac, 60 Hz
TEST MODE	D	TESTED BY	Match Tsui

No	Freq. [MHz]	Corr. Factor [dB]	Reading Value [dB (uV)]		Emission Level [dB (uV)]		Limit [dB (uV)]		Margin (dB)	
			Q.P.	AV.	Q.P.	AV.	Q.P.	AV.	Q.P.	AV.
			1	0.357	0.10	41.07	-	41.17	-	58.80
2	0.500	0.12	38.40	-	38.52	-	56.00	46.00	-17.48	-
3	1.172	0.20	39.29	-	39.49	-	56.00	46.00	-16.51	-
4	2.582	0.25	36.09	-	36.34	-	56.00	46.00	-19.66	-
5	4.207	0.37	34.51	-	34.88	-	56.00	46.00	-21.12	-
6	8.211	0.43	37.73	-	38.16	-	60.00	50.00	-21.84	-

- REMARKS:**
1. Q.P. and AV. are abbreviations of quasi-peak and average individually.
 2. "-": The Quasi-peak reading value also meets average limit and measurement with the average detector is unnecessary.
 3. The emission levels of other frequencies were very low against the limit.
 4. Margin value = Emission level - Limit value
 5. Correction factor = Insertion loss + Cable loss
 6. Emission Level = Correction Factor + Reading Value.

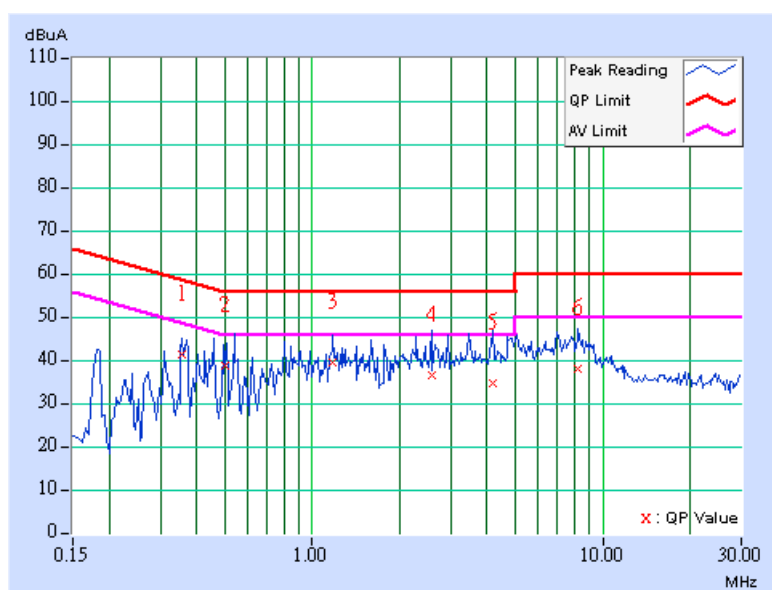

EUT TEST CONDITION		MEASUREMENT DETAIL	
CHANNEL	Channel 0	PHASE	Line 1
MODULATION TYPE	GFSK	6dB BANDWIDTH	9 kHz
ENVIRONMENTAL CONDITIONS	23deg. C, 68%RH, 991hPa	INPUT POWER (SYSTEM)	120Vac, 60 Hz
TEST MODE	E	TESTED BY	Match Tsui

No	Freq. [MHz]	Corr. Factor [dB]	Reading Value [dB (uV)]		Emission Level [dB (uV)]		Limit [dB (uV)]		Margin [dB]	
			Q.P.	AV.	Q.P.	AV.	Q.P.	AV.	Q.P.	AV.
1	0.220	0.10	44.16	-	44.26	-	62.81	52.81	-18.55	-
2	0.326	0.10	33.82	-	33.92	-	59.56	49.56	-25.64	-
3	0.447	0.10	27.47	-	27.57	-	56.93	46.93	-29.36	-
4	0.673	0.10	27.55	-	27.65	-	56.00	46.00	-28.35	-
5	2.086	0.21	25.38	-	25.59	-	56.00	46.00	-30.41	-
6	9.180	0.36	22.06	-	22.42	-	60.00	50.00	-37.58	-

- REMARKS:**
1. Q.P. and AV. are abbreviations of quasi-peak and average individually.
 2. "-": The Quasi-peak reading value also meets average limit and measurement with the average detector is unnecessary.
 3. The emission levels of other frequencies were very low against the limit.
 4. Margin value = Emission level - Limit value
 5. Correction factor = Insertion loss + Cable loss
 6. Emission Level = Correction Factor + Reading Value.

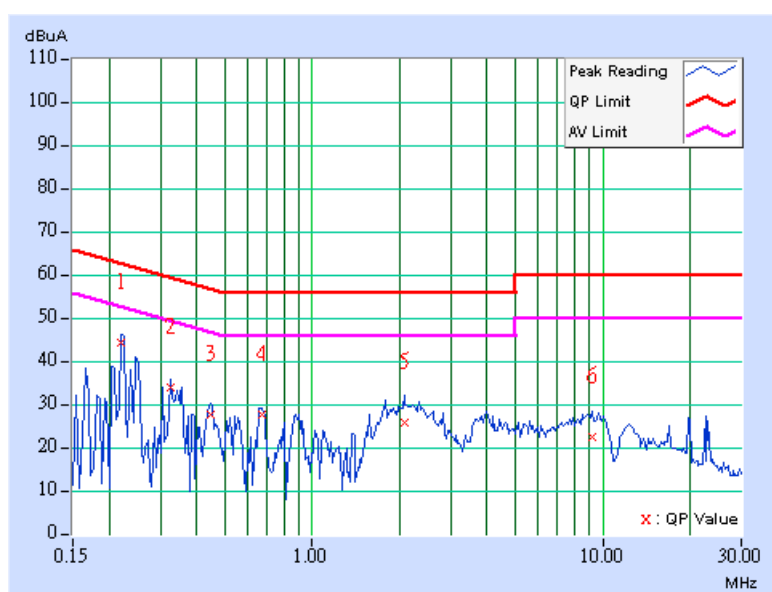

EUT TEST CONDITION		MEASUREMENT DETAIL	
CHANNEL	Channel 0	PHASE	Line 2
MODULATION TYPE	GFSK	6dB BANDWIDTH	9 kHz
ENVIRONMENTAL CONDITIONS	23deg. C, 68%RH, 991hPa	INPUT POWER (SYSTEM)	120Vac, 60 Hz
TEST MODE	E	TESTED BY	Match Tsui

No	Freq. [MHz]	Corr. Factor [dB]	Reading Value [dB (uV)]		Emission Level [dB (uV)]		Limit [dB (uV)]		Margin (dB)	
			Q.P.	AV.	Q.P.	AV.	Q.P.	AV.	Q.P.	AV.
			1	0.150	0.10	42.94	-	43.04	-	66.00
2	0.213	0.10	42.25	-	42.35	-	63.11	53.11	-20.76	-
3	0.330	0.10	33.32	-	33.42	-	59.46	49.46	-26.04	-
4	0.662	0.14	29.05	-	29.19	-	56.00	46.00	-26.81	-
5	2.195	0.22	24.64	-	24.86	-	56.00	46.00	-31.14	-
6	12.020	0.53	21.86	-	22.39	-	60.00	50.00	-37.61	-

- REMARKS:**
1. Q.P. and AV. are abbreviations of quasi-peak and average individually.
 2. "-": The Quasi-peak reading value also meets average limit and measurement with the average detector is unnecessary.
 3. The emission levels of other frequencies were very low against the limit.
 4. Margin value = Emission level - Limit value
 5. Correction factor = Insertion loss + Cable loss
 6. Emission Level = Correction Factor + Reading Value.

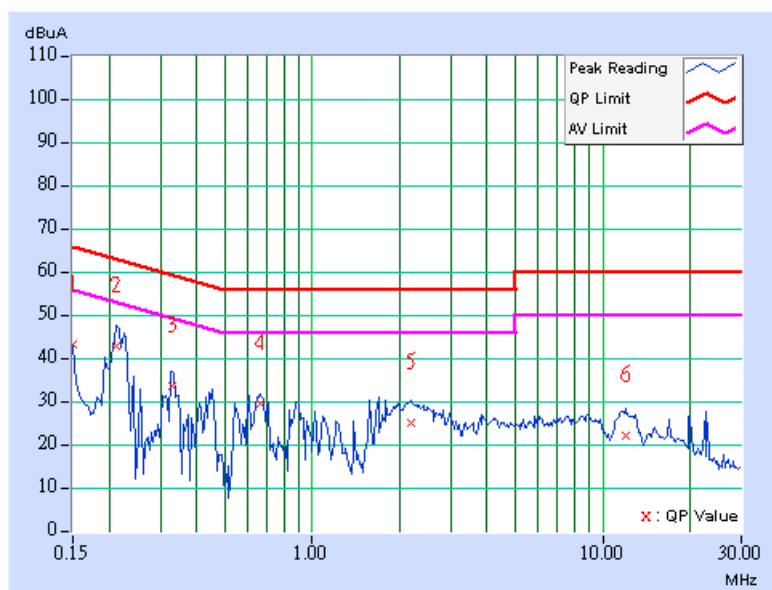

EUT TEST CONDITION		MEASUREMENT DETAIL	
CHANNEL	Channel 39	PHASE	Line 1
MODULATION TYPE	GFSK	6dB BANDWIDTH	9 kHz
ENVIRONMENTAL CONDITIONS	23deg. C, 68%RH, 991hPa	INPUT POWER (SYSTEM)	120Vac, 60 Hz
TEST MODE	E	TESTED BY	Match Tsui

No	Freq. [MHz]	Corr. Factor [dB]	Reading Value [dB (uV)]		Emission Level [dB (uV)]		Limit [dB (uV)]		Margin (dB)	
			Q.P.	AV.	Q.P.	AV.	Q.P.	AV.	Q.P.	AV.
			1	0.150	0.10	46.04	-	46.14	-	66.00
2	0.220	0.10	44.37	-	44.47	-	62.81	52.81	-18.34	-
3	0.326	0.10	33.52	-	33.62	-	59.56	49.56	-25.94	-
4	0.955	0.10	25.22	-	25.32	-	56.00	46.00	-30.68	-
5	2.113	0.21	25.44	-	25.65	-	56.00	46.00	-30.35	-
6	9.262	0.36	21.98	-	22.34	-	60.00	50.00	-37.66	-

- REMARKS:**
1. Q.P. and AV. are abbreviations of quasi-peak and average individually.
 2. "-": The Quasi-peak reading value also meets average limit and measurement with the average detector is unnecessary.
 3. The emission levels of other frequencies were very low against the limit.
 4. Margin value = Emission level - Limit value
 5. Correction factor = Insertion loss + Cable loss
 6. Emission Level = Correction Factor + Reading Value.

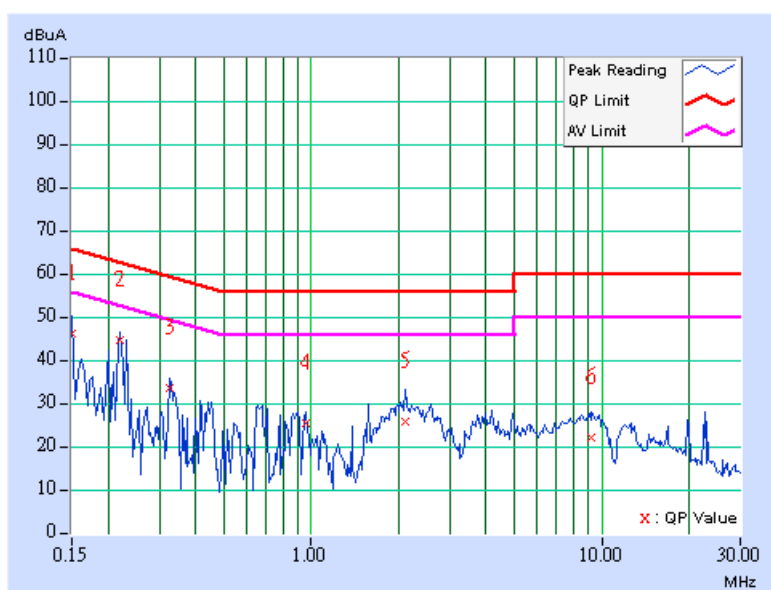

EUT TEST CONDITION		MEASUREMENT DETAIL	
CHANNEL	Channel 39	PHASE	Line 2
MODULATION TYPE	GFSK	6dB BANDWIDTH	9 kHz
ENVIRONMENTAL CONDITIONS	23deg. C, 68%RH, 991hPa	INPUT POWER (SYSTEM)	120Vac, 60 Hz
TEST MODE	E	TESTED BY	Match Tsui

No	Freq. [MHz]	Corr. Factor [dB]	Reading Value [dB (uV)]		Emission Level [dB (uV)]		Limit [dB (uV)]		Margin (dB)	
			Q.P.	AV.	Q.P.	AV.	Q.P.	AV.	Q.P.	AV.
			1	0.150	0.10	43.08	-	43.18	-	66.00
2	0.216	0.10	45.10	-	45.20	-	62.96	52.96	-17.76	-
3	0.333	0.10	32.88	-	32.98	-	59.38	49.38	-26.40	-
4	0.455	0.11	30.05	-	30.16	-	56.79	46.79	-26.63	-
5	1.871	0.20	25.26	-	25.46	-	56.00	46.00	-30.54	-
6	12.484	0.54	21.18	-	21.72	-	60.00	50.00	-38.28	-

- REMARKS:**
1. Q.P. and AV. are abbreviations of quasi-peak and average individually.
 2. "-": The Quasi-peak reading value also meets average limit and measurement with the average detector is unnecessary.
 3. The emission levels of other frequencies were very low against the limit.
 4. Margin value = Emission level - Limit value
 5. Correction factor = Insertion loss + Cable loss
 6. Emission Level = Correction Factor + Reading Value.

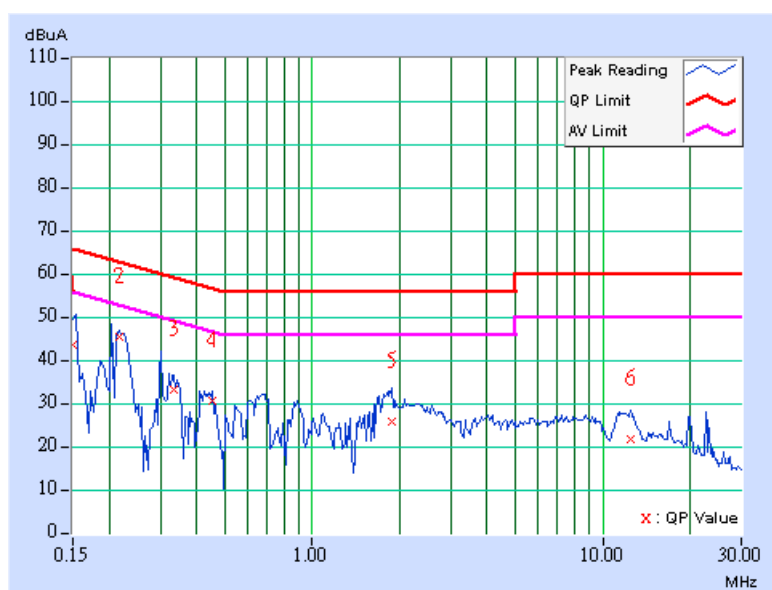

EUT TEST CONDITION		MEASUREMENT DETAIL	
CHANNEL	Channel 78	PHASE	Line 1
MODULATION TYPE	GFSK	6dB BANDWIDTH	9 kHz
ENVIRONMENTAL CONDITIONS	23deg. C, 68%RH, 991hPa	INPUT POWER (SYSTEM)	120Vac, 60 Hz
TEST MODE	E	TESTED BY	Match Tsui

No	Freq. [MHz]	Corr. Factor [dB]	Reading Value [dB (uV)]		Emission Level [dB (uV)]		Limit [dB (uV)]		Margin (dB)	
			Q.P.	AV.	Q.P.	AV.	Q.P.	AV.	Q.P.	AV.
			1	0.158	0.10	40.72	-	40.82	-	65.58
2	0.224	0.10	41.79	-	41.89	-	62.66	52.66	-20.77	-
3	0.334	0.10	24.43	-	24.53	-	59.36	49.36	-34.83	-
4	0.705	0.10	27.34	-	27.44	-	56.00	46.00	-28.56	-
5	1.891	0.19	25.25	-	25.44	-	56.00	46.00	-30.56	-
6	9.340	0.36	21.76	-	22.12	-	60.00	50.00	-37.88	-

- REMARKS:**
1. Q.P. and AV. are abbreviations of quasi-peak and average individually.
 2. "-": The Quasi-peak reading value also meets average limit and measurement with the average detector is unnecessary.
 3. The emission levels of other frequencies were very low against the limit.
 4. Margin value = Emission level - Limit value
 5. Correction factor = Insertion loss + Cable loss
 6. Emission Level = Correction Factor + Reading Value.

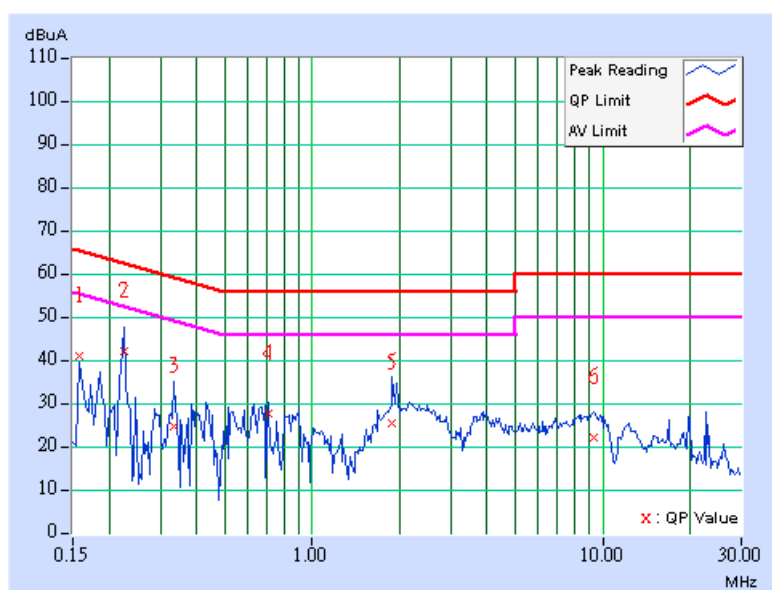

EUT TEST CONDITION		MEASUREMENT DETAIL	
CHANNEL	Channel 78	PHASE	Line 2
MODULATION TYPE	GFSK	6dB BANDWIDTH	9 kHz
ENVIRONMENTAL CONDITIONS	23deg. C, 68%RH, 991hPa	INPUT POWER (SYSTEM)	120Vac, 60 Hz
TEST MODE	E	TESTED BY	Match Tsui

No	Freq. [MHz]	Corr. Factor (dB)	Reading Value [dB (uV)]		Emission Level [dB (uV)]		Limit [dB (uV)]		Margin (dB)	
			Q.P.	AV.	Q.P.	AV.	Q.P.	AV.	Q.P.	AV.
1	0.162	0.10	37.65	-	37.75	-	65.38	55.38	-27.63	-
2	0.216	0.10	45.84	-	45.94	-	62.96	52.96	-17.02	-
3	0.338	0.10	33.00	-	33.10	-	59.26	49.26	-26.16	-
4	0.654	0.14	28.96	-	29.10	-	56.00	46.00	-26.90	-
5	1.813	0.20	22.51	-	22.71	-	56.00	46.00	-33.29	-
6	11.480	0.51	21.66	-	22.17	-	60.00	50.00	-37.83	-

- REMARKS:**
1. Q.P. and AV. are abbreviations of quasi-peak and average individually.
 2. "-": The Quasi-peak reading value also meets average limit and measurement with the average detector is unnecessary.
 3. The emission levels of other frequencies were very low against the limit.
 4. Margin value = Emission level - Limit value
 5. Correction factor = Insertion loss + Cable loss
 6. Emission Level = Correction Factor + Reading Value.

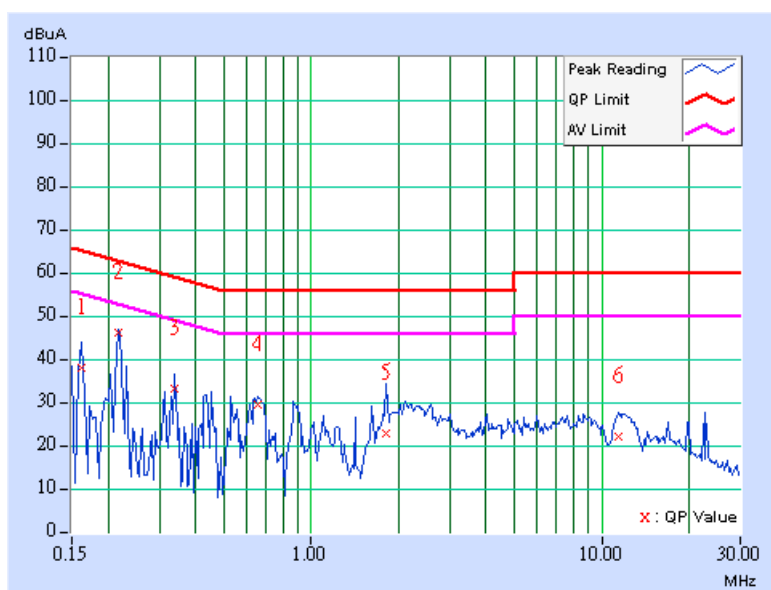

EUT TEST CONDITION		MEASUREMENT DETAIL	
CHANNEL	Channel 0	PHASE	Line 1
MODULATION TYPE	GFSK	6dB BANDWIDTH	9 kHz
ENVIRONMENTAL CONDITIONS	23deg. C, 68%RH, 991hPa	INPUT POWER (SYSTEM)	120Vac, 60 Hz
TEST MODE	F	TESTED BY	Match Tsui

No	Freq. [MHz]	Corr. Factor (dB)	Reading Value [dB (uV)]		Emission Level [dB (uV)]		Limit [dB (uV)]		Margin (dB)	
			Q.P.	AV.	Q.P.	AV.	Q.P.	AV.	Q.P.	AV.
1	0.181	0.10	35.60	-	35.70	-	64.43	54.43	-28.73	-
2	0.365	0.10	34.54	-	34.64	-	58.62	48.62	-23.98	-
3	0.607	0.10	30.14	-	30.24	-	56.00	46.00	-25.76	-
4	1.883	0.19	30.73	-	30.92	-	56.00	46.00	-25.08	-
5	3.035	0.29	31.04	-	31.33	-	56.00	46.00	-24.67	-
6	8.199	0.36	35.17	-	35.53	-	60.00	50.00	-24.47	-

- REMARKS:**
1. Q.P. and AV. are abbreviations of quasi-peak and average individually.
 2. "-": The Quasi-peak reading value also meets average limit and measurement with the average detector is unnecessary.
 3. The emission levels of other frequencies were very low against the limit.
 4. Margin value = Emission level - Limit value
 5. Correction factor = Insertion loss + Cable loss
 6. Emission Level = Correction Factor + Reading Value.

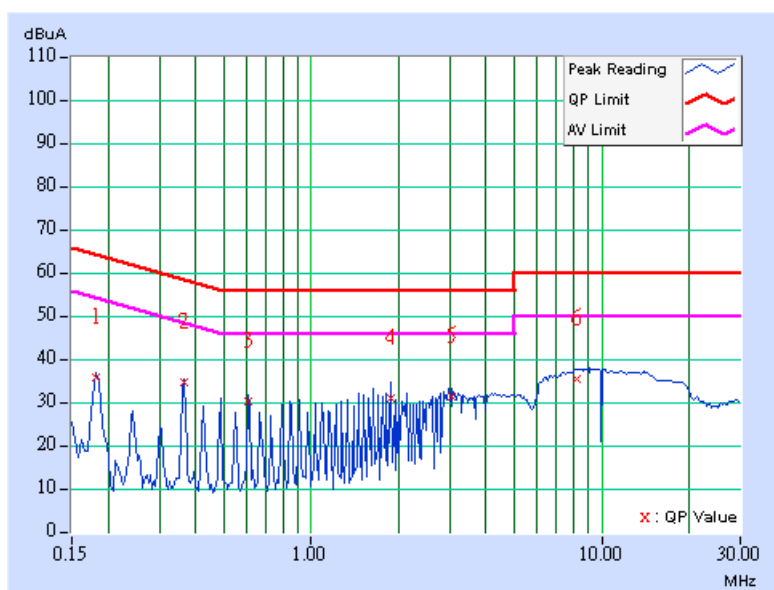

EUT TEST CONDITION		MEASUREMENT DETAIL	
CHANNEL	Channel 0	PHASE	Line 2
MODULATION TYPE	GFSK	6dB BANDWIDTH	9 kHz
ENVIRONMENTAL CONDITIONS	23deg. C, 68%RH, 991hPa	INPUT POWER (SYSTEM)	120Vac, 60 Hz
TEST MODE	F	TESTED BY	Match Tsui

No	Freq. [MHz]	Corr. Factor [dB]	Reading Value [dB (uV)]		Emission Level [dB (uV)]		Limit [dB (uV)]		Margin (dB)	
			Q.P.	AV.	Q.P.	AV.	Q.P.	AV.	Q.P.	AV.
			1	0.181	0.10	34.90	-	35.00	-	64.43
2	0.365	0.10	35.03	-	35.13	-	58.62	48.62	-23.49	-
3	0.486	0.11	30.66	-	30.77	-	56.24	46.24	-25.46	-
4	1.336	0.20	28.61	-	28.81	-	56.00	46.00	-27.19	-
5	2.914	0.28	31.87	-	32.15	-	56.00	46.00	-23.85	-
6	9.051	0.45	35.22	-	35.67	-	60.00	50.00	-24.33	-

- REMARKS:**
1. Q.P. and AV. are abbreviations of quasi-peak and average individually.
 2. "-": The Quasi-peak reading value also meets average limit and measurement with the average detector is unnecessary.
 3. The emission levels of other frequencies were very low against the limit.
 4. Margin value = Emission level - Limit value
 5. Correction factor = Insertion loss + Cable loss
 6. Emission Level = Correction Factor + Reading Value.

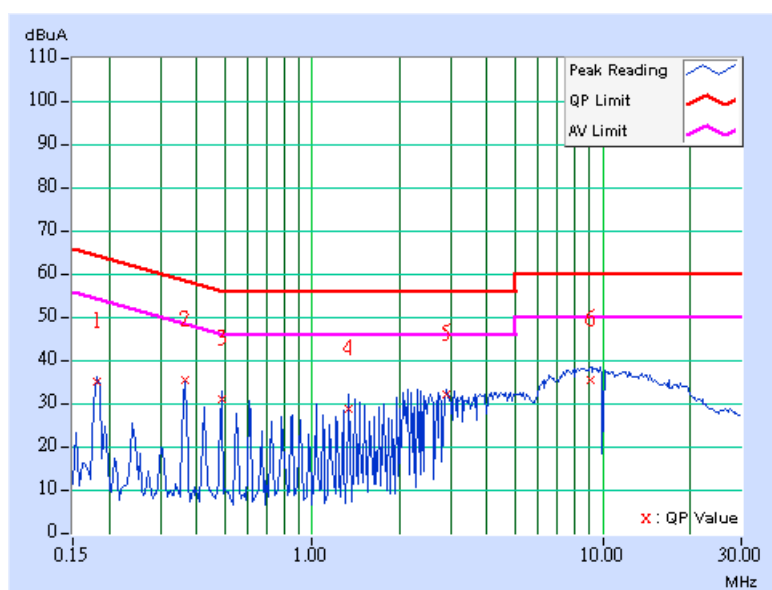

EUT TEST CONDITION		MEASUREMENT DETAIL	
CHANNEL	Channel 39	PHASE	Line 1
MODULATION TYPE	GFSK	6dB BANDWIDTH	9 kHz
ENVIRONMENTAL CONDITIONS	23deg. C, 68%RH, 991hPa	INPUT POWER (SYSTEM)	120Vac, 60 Hz
TEST MODE	F	TESTED BY	Match Tsui

No	Freq. [MHz]	Corr. Factor [dB]	Reading Value [dB (uV)]		Emission Level [dB (uV)]		Limit [dB (uV)]		Margin (dB)	
			Q.P.	AV.	Q.P.	AV.	Q.P.	AV.	Q.P.	AV.
1	0.181	0.10	35.67	-	35.77	-	64.43	54.43	-28.66	-
2	0.365	0.10	34.54	-	34.64	-	58.62	48.62	-23.98	-
3	0.607	0.10	30.14	-	30.24	-	56.00	46.00	-25.76	-
4	1.887	0.19	28.17	-	28.36	-	56.00	46.00	-27.64	-
5	4.191	0.37	30.14	-	30.51	-	56.00	46.00	-25.49	-
6	13.668	0.56	34.01	-	34.57	-	60.00	50.00	-25.43	-

- REMARKS:**
1. Q.P. and AV. are abbreviations of quasi-peak and average individually.
 2. "-": The Quasi-peak reading value also meets average limit and measurement with the average detector is unnecessary.
 3. The emission levels of other frequencies were very low against the limit.
 4. Margin value = Emission level - Limit value
 5. Correction factor = Insertion loss + Cable loss
 6. Emission Level = Correction Factor + Reading Value.

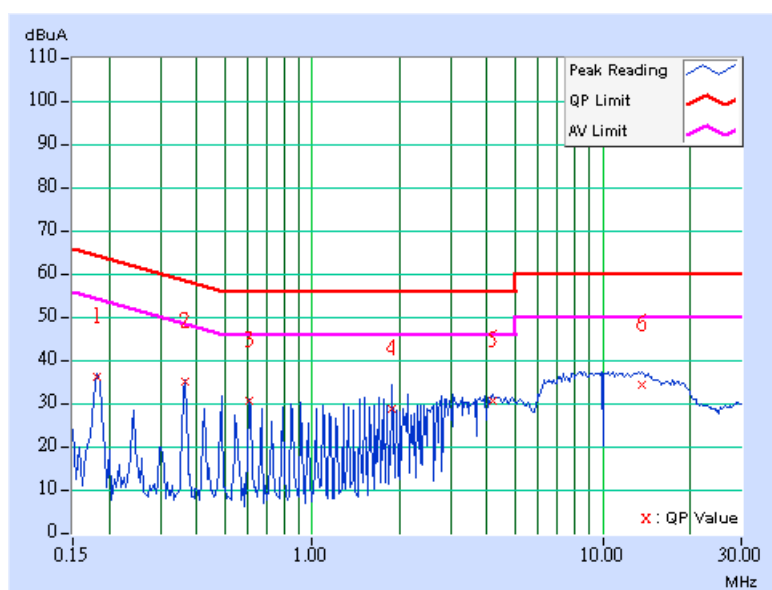

EUT TEST CONDITION		MEASUREMENT DETAIL	
CHANNEL	Channel 39	PHASE	Line 2
MODULATION TYPE	GFSK	6dB BANDWIDTH	9 kHz
ENVIRONMENTAL CONDITIONS	23deg. C, 68%RH, 991hPa	INPUT POWER (SYSTEM)	120Vac, 60 Hz
TEST MODE	F	TESTED BY	Match Tsui

No	Freq. [MHz]	Corr. Factor [dB]	Reading Value [dB (uV)]		Emission Level [dB (uV)]		Limit [dB (uV)]		Margin (dB)	
			Q.P.	AV.	Q.P.	AV.	Q.P.	AV.	Q.P.	AV.
			1	0.184	0.10	34.60	-	34.70	-	64.30
2	0.365	0.10	35.09	-	35.19	-	58.62	48.62	-23.43	-
3	0.791	0.17	29.62	-	29.79	-	56.00	46.00	-26.21	-
4	1.941	0.20	31.00	-	31.20	-	56.00	46.00	-24.80	-
5	2.672	0.26	33.84	-	34.10	-	56.00	46.00	-21.90	-
6	8.262	0.43	35.56	-	35.99	-	60.00	50.00	-24.01	-

- REMARKS:**
1. Q.P. and AV. are abbreviations of quasi-peak and average individually.
 2. "-": The Quasi-peak reading value also meets average limit and measurement with the average detector is unnecessary.
 3. The emission levels of other frequencies were very low against the limit.
 4. Margin value = Emission level - Limit value
 5. Correction factor = Insertion loss + Cable loss
 6. Emission Level = Correction Factor + Reading Value.

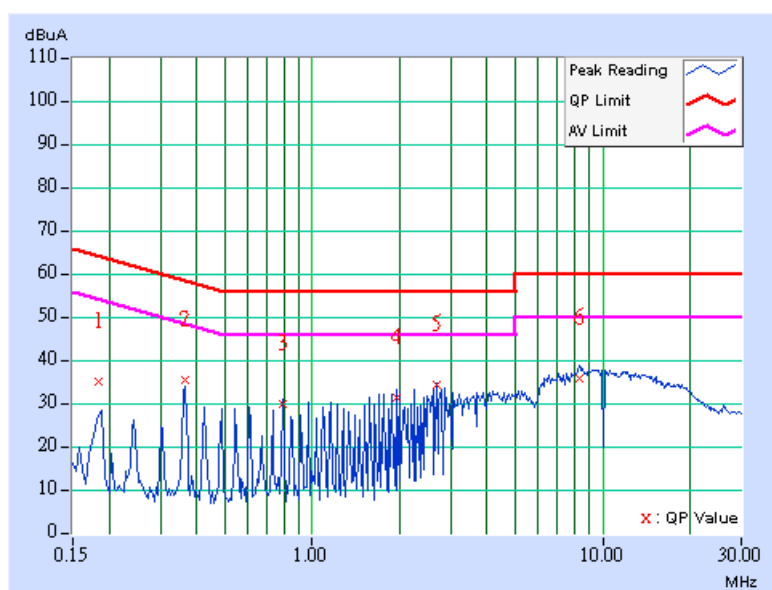

EUT TEST CONDITION		MEASUREMENT DETAIL	
CHANNEL	Channel 78	PHASE	Line 1
MODULATION TYPE	GFSK	6dB BANDWIDTH	9 kHz
ENVIRONMENTAL CONDITIONS	23deg. C, 68%RH, 991hPa	INPUT POWER (SYSTEM)	120Vac, 60 Hz
TEST MODE	F	TESTED BY	Match Tsui

No	Freq. [MHz]	Corr. Factor [dB]	Reading Value [dB (uV)]		Emission Level [dB (uV)]		Limit [dB (uV)]		Margin (dB)	
			Q.P.	AV.	Q.P.	AV.	Q.P.	AV.	Q.P.	AV.
			1	0.181	0.10	35.73	-	35.83	-	64.43
2	0.365	0.10	34.54	-	34.64	-	58.62	48.62	-23.98	-
3	0.607	0.10	30.10	-	30.20	-	56.00	46.00	-25.80	-
4	1.457	0.15	30.42	-	30.57	-	56.00	46.00	-25.43	-
5	2.793	0.27	30.30	-	30.57	-	56.00	46.00	-25.43	-
6	8.625	0.36	34.86	-	35.22	-	60.00	50.00	-24.78	-

- REMARKS:**
1. Q.P. and AV. are abbreviations of quasi-peak and average individually.
 2. "-": The Quasi-peak reading value also meets average limit and measurement with the average detector is unnecessary.
 3. The emission levels of other frequencies were very low against the limit.
 4. Margin value = Emission level - Limit value
 5. Correction factor = Insertion loss + Cable loss
 6. Emission Level = Correction Factor + Reading Value.

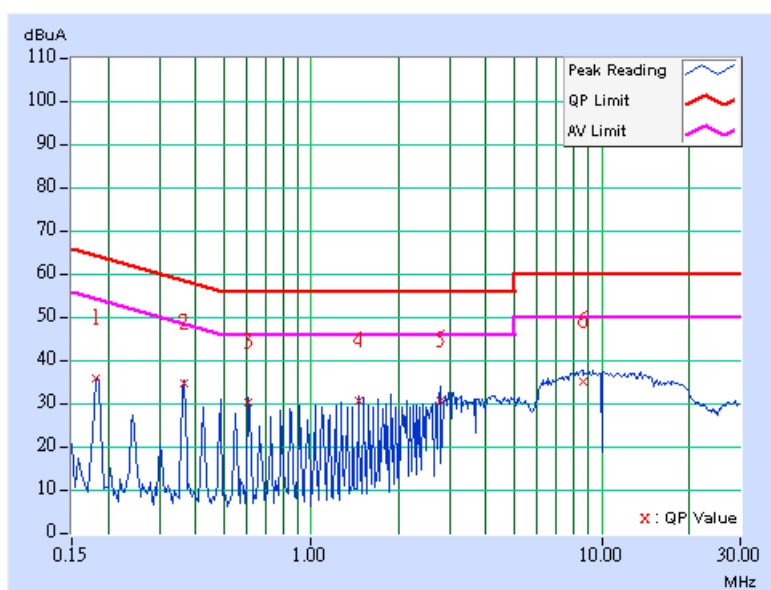

EUT TEST CONDITION		MEASUREMENT DETAIL	
CHANNEL	Channel 78	PHASE	Line 2
MODULATION TYPE	GFSK	6dB BANDWIDTH	9 kHz
ENVIRONMENTAL CONDITIONS	23deg. C, 68%RH, 991hPa	INPUT POWER (SYSTEM)	120Vac, 60 Hz
TEST MODE	F	TESTED BY	Match Tsui

No	Freq. [MHz]	Corr. Factor [dB]	Reading Value [dB (uV)]		Emission Level [dB (uV)]		Limit [dB (uV)]		Margin (dB)	
			Q.P.	AV.	Q.P.	AV.	Q.P.	AV.	Q.P.	AV.
			1	0.181	0.10	35.26	-	35.36	-	64.43
2	0.365	0.10	35.05	-	35.15	-	58.62	48.62	-23.47	-
3	0.791	0.17	29.60	-	29.77	-	56.00	46.00	-26.23	-
4	2.613	0.25	32.76	-	33.01	-	56.00	46.00	-22.99	-
5	5.223	0.39	30.63	-	31.02	-	60.00	50.00	-28.98	-
6	9.355	0.45	35.78	-	36.23	-	60.00	50.00	-23.77	-

- REMARKS:**
1. Q.P. and AV. are abbreviations of quasi-peak and average individually.
 2. "-": The Quasi-peak reading value also meets average limit and measurement with the average detector is unnecessary.
 3. The emission levels of other frequencies were very low against the limit.
 4. Margin value = Emission level - Limit value
 5. Correction factor = Insertion loss + Cable loss
 6. Emission Level = Correction Factor + Reading Value.

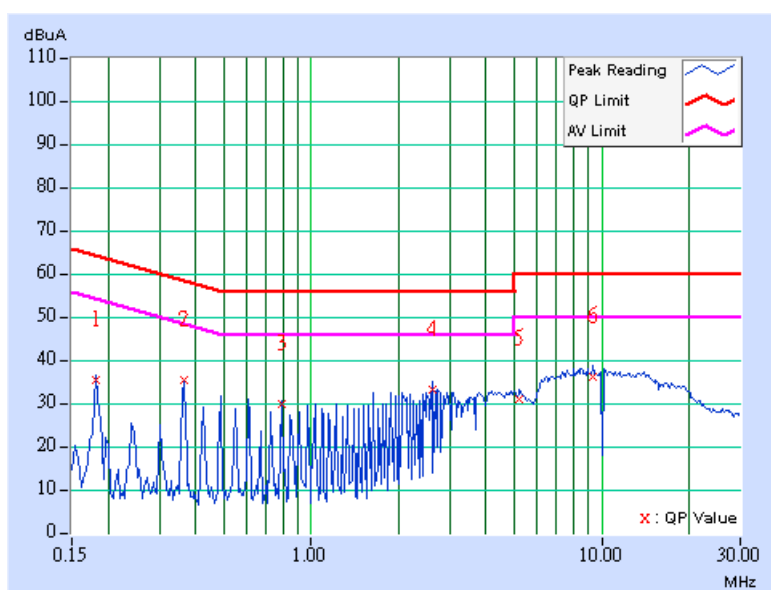

EUT TEST CONDITION		MEASUREMENT DETAIL	
CHANNEL	Channel 0	PHASE	Line 1
MODULATION TYPE	GFSK	6dB BANDWIDTH	9 kHz
ENVIRONMENTAL CONDITIONS	23deg. C, 68%RH, 991hPa	INPUT POWER (SYSTEM)	120Vac, 60 Hz
TEST MODE	G	TESTED BY	Match Tsui

No	Freq. [MHz]	Corr. Factor (dB)	Reading Value [dB (uV)]		Emission Level [dB (uV)]		Limit [dB (uV)]		Margin (dB)	
			Q.P.	AV.	Q.P.	AV.	Q.P.	AV.	Q.P.	AV.
1	0.400	0.10	52.85	41.35	52.95	41.45	57.86	47.86	-4.91	-6.41
2	0.533	0.10	45.37	-	45.47	-	56.00	46.00	-10.53	-
3	0.917	0.10	41.75	-	41.85	-	56.00	46.00	-14.15	-
4	2.020	0.20	38.45	-	38.65	-	56.00	46.00	-17.35	-
5	3.325	0.31	37.89	-	38.20	-	56.00	46.00	-17.80	-
6	7.611	0.36	42.31	-	42.67	-	60.00	50.00	-17.33	-

- REMARKS:**
1. Q.P. and AV. are abbreviations of quasi-peak and average individually.
 2. "-": The Quasi-peak reading value also meets average limit and measurement with the average detector is unnecessary.
 3. The emission levels of other frequencies were very low against the limit.
 4. Margin value = Emission level - Limit value
 5. Correction factor = Insertion loss + Cable loss
 6. Emission Level = Correction Factor + Reading Value.

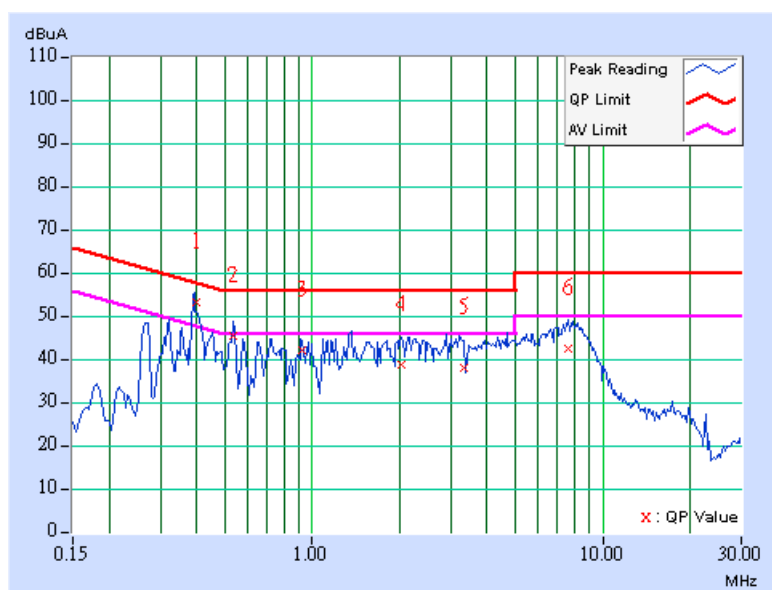

EUT TEST CONDITION		MEASUREMENT DETAIL	
CHANNEL	Channel 0	PHASE	Line 2
MODULATION TYPE	GFSK	6dB BANDWIDTH	9 kHz
ENVIRONMENTAL CONDITIONS	23deg. C, 68%RH, 991hPa	INPUT POWER (SYSTEM)	120Vac, 60 Hz
TEST MODE	G	TESTED BY	Match Tsui

No	Freq. [MHz]	Corr. Factor [dB]	Reading Value [dB (uV)]		Emission Level [dB (uV)]		Limit [dB (uV)]		Margin (dB)	
			Q.P.	AV.	Q.P.	AV.	Q.P.	AV.	Q.P.	AV.
			1	0.412	0.10	50.32	39.59	50.42	39.69	57.60
2	0.916	0.19	39.20	-	39.39	-	56.00	46.00	-16.61	-
3	1.233	0.20	37.74	-	37.94	-	56.00	46.00	-18.06	-
4	2.652	0.26	34.20	-	34.46	-	56.00	46.00	-21.54	-
5	3.754	0.35	35.58	-	35.93	-	56.00	46.00	-20.07	-
6	8.225	0.43	40.74	-	41.17	-	60.00	50.00	-18.83	-

- REMARKS:**
1. Q.P. and AV. are abbreviations of quasi-peak and average individually.
 2. "-": The Quasi-peak reading value also meets average limit and measurement with the average detector is unnecessary.
 3. The emission levels of other frequencies were very low against the limit.
 4. Margin value = Emission level - Limit value
 5. Correction factor = Insertion loss + Cable loss
 6. Emission Level = Correction Factor + Reading Value.

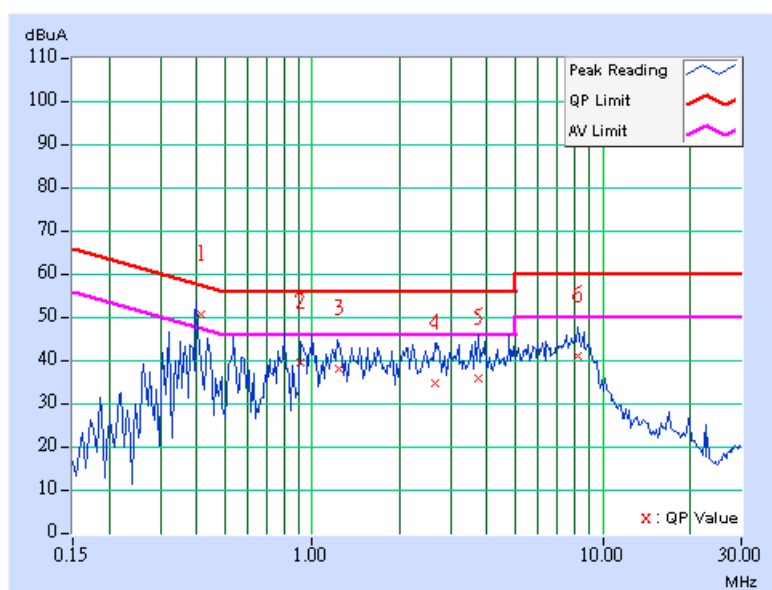

EUT TEST CONDITION		MEASUREMENT DETAIL	
CHANNEL	Channel 39	PHASE	Line 1
MODULATION TYPE	GFSK	6dB BANDWIDTH	9 kHz
ENVIRONMENTAL CONDITIONS	23deg. C, 68%RH, 991hPa	INPUT POWER (SYSTEM)	120Vac, 60 Hz
TEST MODE	G	TESTED BY	Match Tsui

No	Freq. [MHz]	Corr. Factor [dB]	Reading Value [dB (uV)]		Emission Level [dB (uV)]		Limit [dB (uV)]		Margin (dB)	
			Q.P.	AV.	Q.P.	AV.	Q.P.	AV.	Q.P.	AV.
			1	0.400	0.10	52.58	42.67	52.68	42.77	57.85
2	0.537	0.10	45.51	-	45.61	-	56.00	46.00	-10.39	-
3	0.936	0.10	41.23	-	41.33	-	56.00	46.00	-14.67	-
4	2.219	0.22	38.81	-	39.03	-	56.00	46.00	-16.97	-
5	4.137	0.37	39.62	-	39.99	-	56.00	46.00	-16.01	-
6	8.164	0.36	42.05	-	42.41	-	60.00	50.00	-17.59	-

- REMARKS:**
1. Q.P. and AV. are abbreviations of quasi-peak and average individually.
 2. "-": The Quasi-peak reading value also meets average limit and measurement with the average detector is unnecessary.
 3. The emission levels of other frequencies were very low against the limit.
 4. Margin value = Emission level - Limit value
 5. Correction factor = Insertion loss + Cable loss
 6. Emission Level = Correction Factor + Reading Value.

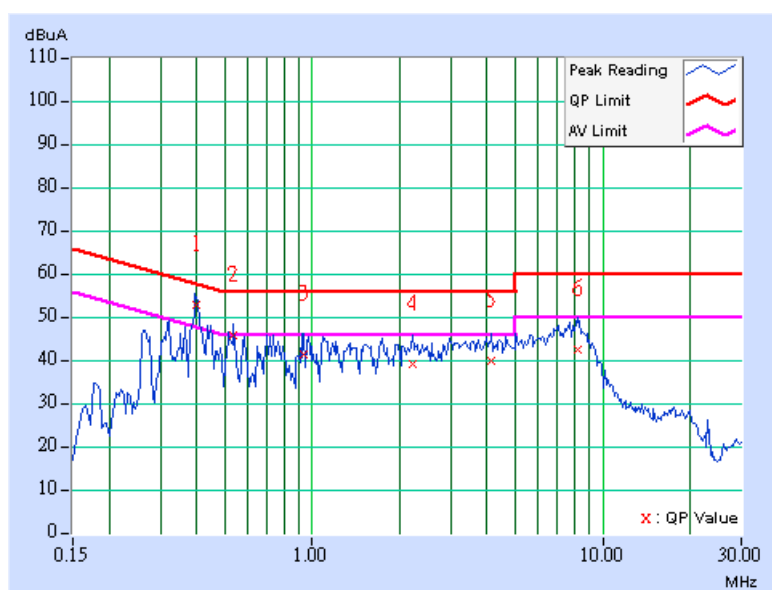

EUT TEST CONDITION		MEASUREMENT DETAIL	
CHANNEL	Channel 39	PHASE	Line 2
MODULATION TYPE	GFSK	6dB BANDWIDTH	9 kHz
ENVIRONMENTAL CONDITIONS	23deg. C, 68%RH, 991hPa	INPUT POWER (SYSTEM)	120Vac, 60 Hz
TEST MODE	G	TESTED BY	Match Tsui

No	Freq. [MHz]	Corr. Factor [dB]	Reading Value [dB (uV)]		Emission Level [dB (uV)]		Limit [dB (uV)]		Margin (dB)	
			Q.P.	AV.	Q.P.	AV.	Q.P.	AV.	Q.P.	AV.
			1	0.322	0.10	42.47	-	42.57	-	59.64
2	0.412	0.10	49.44	38.95	49.54	39.05	57.60	47.60	-8.06	-8.55
3	0.542	0.12	40.89	-	41.01	-	56.00	46.00	-14.99	-
4	1.936	0.20	35.36	-	35.56	-	56.00	46.00	-20.44	-
5	3.725	0.35	35.96	-	36.31	-	56.00	46.00	-19.69	-
6	8.254	0.43	42.22	-	42.65	-	60.00	50.00	-17.35	-

- REMARKS:**
1. Q.P. and AV. are abbreviations of quasi-peak and average individually.
 2. "-": The Quasi-peak reading value also meets average limit and measurement with the average detector is unnecessary.
 3. The emission levels of other frequencies were very low against the limit.
 4. Margin value = Emission level - Limit value
 5. Correction factor = Insertion loss + Cable loss
 6. Emission Level = Correction Factor + Reading Value.

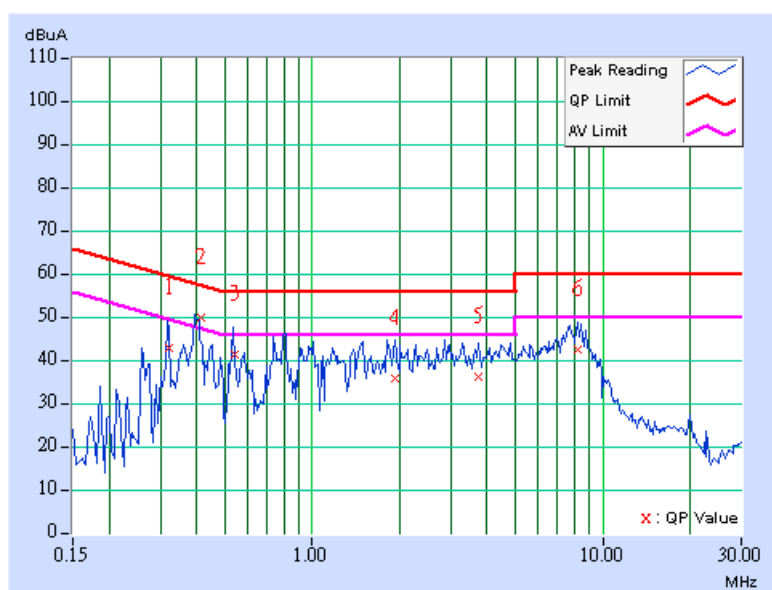

EUT TEST CONDITION		MEASUREMENT DETAIL	
CHANNEL	Channel 78	PHASE	Line 1
MODULATION TYPE	GFSK	6dB BANDWIDTH	9 kHz
ENVIRONMENTAL CONDITIONS	23deg. C, 68%RH, 991hPa	INPUT POWER (SYSTEM)	120Vac, 60 Hz
TEST MODE	G	TESTED BY	Match Tsui

No	Freq. [MHz]	Corr. Factor [dB]	Reading Value [dB (uV)]		Emission Level [dB (uV)]		Limit [dB (uV)]		Margin (dB)	
			Q.P.	AV.	Q.P.	AV.	Q.P.	AV.	Q.P.	AV.
			1	0.400	0.10	53.21	42.67	53.31	42.77	57.85
2	0.537	0.10	45.51	-	45.61	-	56.00	46.00	-10.39	-
3	0.937	0.10	41.23	-	41.33	-	56.00	46.00	-14.67	-
4	2.219	0.22	39.50	-	39.72	-	56.00	46.00	-16.28	-
5	4.138	0.37	39.62	-	39.99	-	56.00	46.00	-16.01	-
6	8.164	0.36	43.20	-	43.56	-	60.00	50.00	-16.44	-

- REMARKS:**
1. Q.P. and AV. are abbreviations of quasi-peak and average individually.
 2. "-": The Quasi-peak reading value also meets average limit and measurement with the average detector is unnecessary.
 3. The emission levels of other frequencies were very low against the limit.
 4. Margin value = Emission level - Limit value
 5. Correction factor = Insertion loss + Cable loss
 6. Emission Level = Correction Factor + Reading Value.

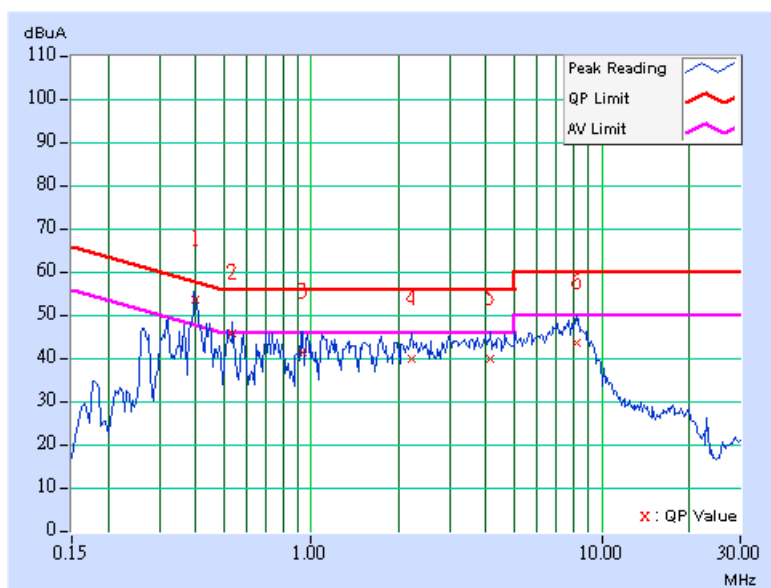

EUT TEST CONDITION		MEASUREMENT DETAIL	
CHANNEL	Channel 78	PHASE	Line 2
MODULATION TYPE	GFSK	6dB BANDWIDTH	9 kHz
ENVIRONMENTAL CONDITIONS	23deg. C, 68%RH, 991hPa	INPUT POWER (SYSTEM)	120Vac, 60 Hz
TEST MODE	G	TESTED BY	Match Tsui

No	Freq. [MHz]	Corr. Factor (dB)	Reading Value [dB (uV)]		Emission Level [dB (uV)]		Limit [dB (uV)]		Margin (dB)	
			Q.P.	AV.	Q.P.	AV.	Q.P.	AV.	Q.P.	AV.
1	0.400	0.10	49.85	41.20	49.95	41.30	57.85	47.85	-7.90	-6.55
2	0.565	0.13	38.32	-	38.45	-	56.00	46.00	-17.55	-
3	0.835	0.17	38.96	-	39.13	-	56.00	46.00	-16.87	-
4	1.175	0.20	39.21	-	39.41	-	56.00	46.00	-16.59	-
5	3.051	0.29	36.54	-	36.83	-	56.00	46.00	-19.17	-
6	7.954	0.43	40.50	-	40.93	-	60.00	50.00	-19.07	-

- REMARKS:**
1. Q.P. and AV. are abbreviations of quasi-peak and average individually.
 2. "-": The Quasi-peak reading value also meets average limit and measurement with the average detector is unnecessary.
 3. The emission levels of other frequencies were very low against the limit.
 4. Margin value = Emission level - Limit value
 5. Correction factor = Insertion loss + Cable loss
 6. Emission Level = Correction Factor + Reading Value.

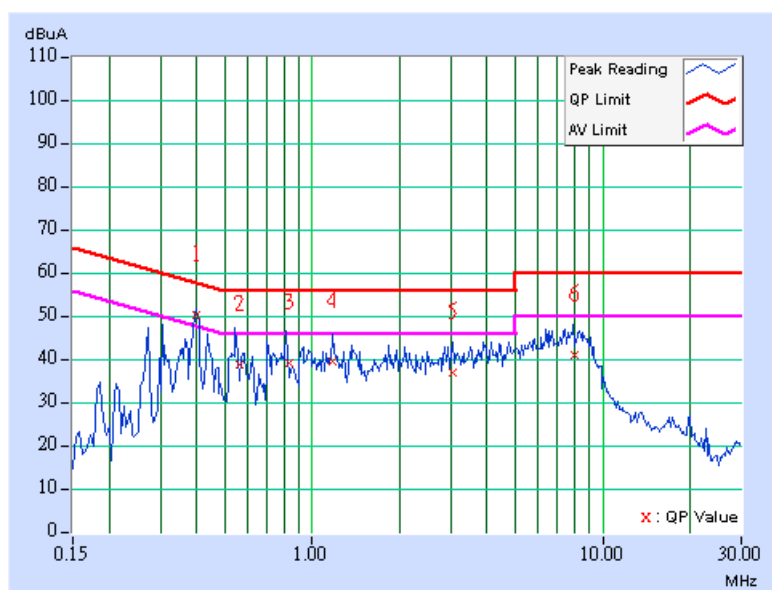



4.2 RADIATED EMISSION MEASUREMENT

4.2.1 LIMITS OF RADIATED EMISSION MEASUREMENT

Emissions radiated outside of the specified bands, shall be according to the general radiated limits in 15.209 as following:

FREQUENCIES (MHz)	FIELD STRENGTH (microvolts/meter)	MEASUREMENT DISTANCE (meters)
0.009-0.490	2400/F(kHz)	300
0.490-1.705	24000/F(kHz)	30
1.705-30.0	30	30
30-88	100	3
88-216	150	3
216-960	200	3
Above 960	500	3

NOTE:

1. The lower limit shall apply at the transition frequencies.
2. Emission level (dBuV/m) = 20 log Emission level (uV/m).
3. As shown in 15.35(b), for frequencies above 1000MHz, the field strength limits are based on average detector, however, the peak field strength of any emission shall not exceed the maximum permitted average limits, specified above by more than 20dB under any condition of modulation.



4.2.2 TEST INSTRUMENTS

DESCRIPTION & MANUFACTURER	MODEL NO.	SERIAL NO.	CALIBRATED UNTIL
Test Receiver ROHDE & SCHWARZ	ESMI	839013/007 839379/002	Jan. 24, 2007
Spectrum Analyzer ROHDE & SCHWARZ	FSEK30	100049	Aug. 13, 2007
BILOG Antenna SCHWARZBECK	VULB9163	121	Jun. 01, 2007
HORN Antenna SCHWARZBECK	BBHA 9120 D	9120D-407	Jan. 22, 2007
HORN Antenna SCHWARZBECK	BBHA 9170	BBHA9170242	Jan. 19, 2007
Preamplifier Agilent	8449B	3008A01911	Sep. 21, 2007
RF signal cable HUBER+SUHNNER	SUCOFLEX 104	218188/218189	Dec. 13, 2006
RF signal cable Worken	8D-FB	Cable-HYCH9-01	Mar. 08, 2007
Software ADT.	ADT_Radiated_ V7.6.01	NA	NA
Antenna Tower EMCO	2070/2080	512.835.4684	NA
Antenna Tower Controller EMCO	2090	NA	NA
Turn Table EMCO	2087-2.03	NA	NA
Turn Table Controller EMCO	2090	NA	NA

- NOTE:**
1. The calibration interval of the above test instruments is 12 months and the calibrations are traceable to NML/ROC and NIST/USA.
 2. The test was performed in HwaYa Chamber 9.
 3. The horn antenna and HP preamplifier (model: 8449B) are used only for the measurement of emission frequency above 1GHz if tested.
 4. The IC Site Registration No. is IC4924A-9.

4.2.3 TEST PROCEDURES

- a. The EUT was placed on the top of a rotating table 0.8 meters above the ground at a 3 meter semi-anechoic chamber. The table was rotated 360 degrees to determine the position of the highest radiation.
- b. The EUT was set 3 meters away from the interference-receiving antenna, which was mounted on the top of a variable-height antenna tower.
- c. The antenna is a broadband antenna, and its height is varied from one meter to four meters above the ground to determine the maximum value of the field strength. Both horizontal and vertical polarizations of the antenna are set to make the measurement.
- d. For each suspected emission, the EUT was arranged to its worst case and then the antenna was tuned to heights from 1 meter to 4 meters and the rotatable table was turned from 0 degrees to 360 degrees to find the maximum reading.
- e. The test-receiver system was set to Peak Detect Function and Specified Bandwidth with Maximum Hold Mode.
- f. If the emission level of the EUT in peak mode was lower than the limit specified, then testing could be stopped and the peak values of the EUT would be reported. Otherwise the emissions would be re-tested one by one using peak, quasi-peak or average method as specified and then reported in a data sheet.

NOTE:

1. The resolution bandwidth and video bandwidth of test receiver/spectrum analyzer is 120kHz for Quasi-peak detection at frequency below 1GHz.
2. The resolution bandwidth of test receiver/spectrum analyzer is 1 MHz and video bandwidth is 3MHz for Peak detection at frequency above 1GHz.

4.2.4 DEVIATION FROM TEST STANDARD

No deviation

4.2.5 TEST SETUP

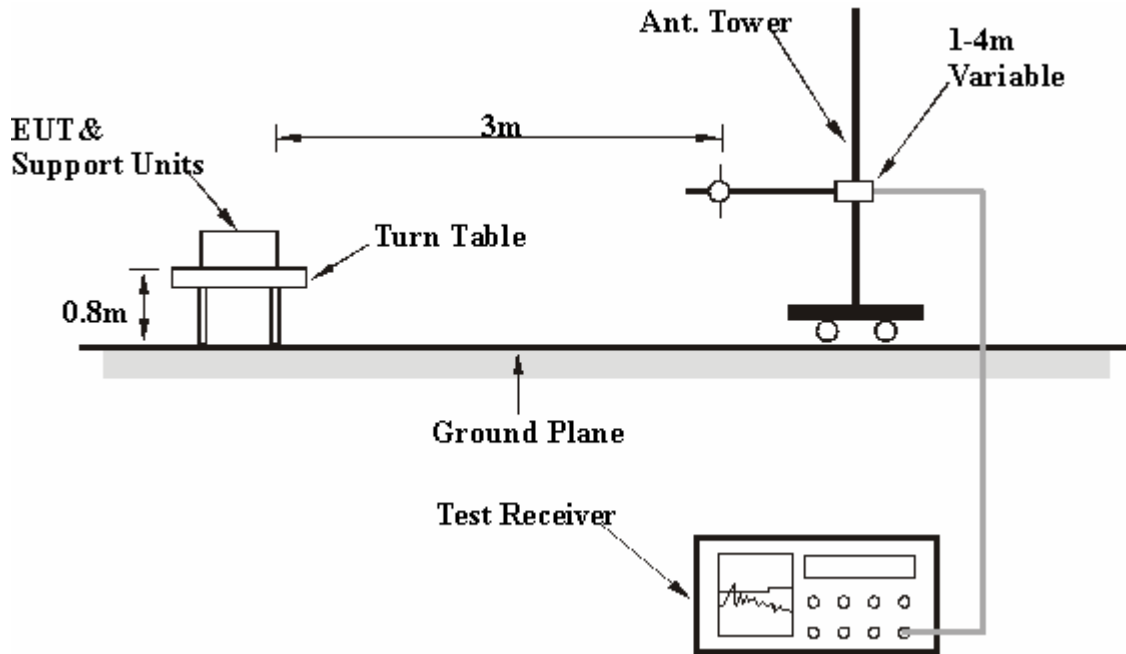

For the actual test configuration, please refer to the attached file (Test Setup Photo).

4.2.6 EUT OPERATING CONDITIONS

Same as 4.1.6

4.2.7 TEST RESULTS

RADIATED WORST CASE DATA:

EUT TEST CONDITION		MEASUREMENT DETAIL	
CHANNEL	Channel 78	FREQUENCY RANGE	Below 1000MHz
MODULATION TYPE	GFSK	DETECTOR FUNCTION	Quasi-Peak
ENVIRONMENTAL CONDITIONS	26deg. C, 65%RH, 991hPa	INPUT POWER (SYSTEM)	120Vac, 60 Hz
TEST MODE	A	TESTED BY	Match Tsui

ANTENNA POLARITY & TEST DISTANCE: HORIZONTAL AT 3 M								
No.	Freq. (MHz)	Emission Level (dBuV/m)	Limit (dBuV/m)	Margin (dB)	Antenna Height (m)	Table Angle (Degree)	Raw Value (dBuV)	Correction Factor (dB/m)
1	30.00	22.96 QP	40.00	-17.04	1.50 H	282	11.29	11.67
2	127.19	29.97 QP	43.50	-13.53	2.00 H	29	18.98	10.99
3	133.03	27.17 QP	43.50	-16.33	1.00 H	244	15.41	11.76
4	191.34	23.57 QP	43.50	-19.93	2.00 H	200	13.07	10.50
5	210.78	31.23 QP	43.50	-12.27	2.00 H	24	20.94	10.28
6	255.49	29.21 QP	46.00	-16.79	1.00 H	29	17.67	11.54
7	269.10	27.33 QP	46.00	-18.67	2.00 H	30	14.25	13.08
8	640.38	29.75 QP	46.00	-16.25	2.00 H	24	8.50	21.25
9	930.02	26.21 QP	46.00	-19.79	2.00 H	23	-0.18	26.39
10	949.46	30.77 QP	46.00	-15.23	1.00 H	86	3.44	27.33

ANTENNA POLARITY & TEST DISTANCE: VERTICAL AT 3 M								
No.	Freq. (MHz)	Emission Level (dBuV/m)	Limit (dBuV/m)	Margin (dB)	Antenna Height (m)	Table Angle (Degree)	Raw Value (dBuV)	Correction Factor (dB/m)
1	57.21	30.36 QP	40.00	-9.64	1.00 V	263	17.09	13.27
2	127.19	28.34 QP	43.50	-15.16	1.00 V	187	17.35	10.99
3	136.91	27.79 QP	43.50	-15.71	1.00 V	30	15.51	12.28
4	162.18	26.66 QP	43.50	-16.84	1.00 V	67	14.21	12.45
5	210.78	26.95 QP	43.50	-16.55	1.50 V	289	16.66	10.28
6	241.88	29.84 QP	46.00	-16.16	1.00 V	23	18.53	11.31
7	640.38	28.70 QP	46.00	-17.30	1.50 V	289	7.45	21.25
8	945.57	33.93 QP	46.00	-12.07	1.00 V	118	6.78	27.14

- REMARKS:**
1. Emission level (dBuV/m) = Raw Value (dBuV) + Correction Factor (dB/m).
 2. Correction Factor (dB/m) = Antenna Factor (dB/m) + Cable Factor (dB).
 3. The other emission levels were very low against the limit.
 4. Margin value = Emission level – Limit value.

EUT TEST CONDITION		MEASUREMENT DETAIL	
CHANNEL	Channel 78	FREQUENCY RANGE	Below 1000MHz
MODULATION TYPE	GFSK	DETECTOR FUNCTION	Quasi-Peak
ENVIRONMENTAL CONDITIONS	26deg. C, 65%RH, 991hPa	INPUT POWER (SYSTEM)	120Vac, 60 Hz
TEST MODE	B	TESTED BY	Match Tsui

ANTENNA POLARITY & TEST DISTANCE: HORIZONTAL AT 3 M								
No.	Freq. (MHz)	Emission Level (dBuV/m)	Limit (dBuV/m)	Margin (dB)	Antenna Height (m)	Table Angle (Degree)	Raw Value (dBuV)	Correction Factor (dB/m)
1	49.44	21.77 QP	40.00	-18.23	2.00 H	80	7.89	13.88
2	121.36	28.77 QP	43.50	-14.73	2.00 H	86	18.56	10.22
3	133.03	24.03 QP	43.50	-19.47	2.00 H	263	12.27	11.76
4	210.78	23.50 QP	43.50	-20.00	2.00 H	92	13.22	10.28
5	230.22	27.10 QP	46.00	-18.90	2.00 H	289	16.18	10.92
6	640.38	25.48 QP	46.00	-20.52	2.00 H	92	4.24	21.25
7	768.68	27.76 QP	46.00	-18.24	2.00 H	92	3.82	23.94
8	933.91	26.46 QP	46.00	-19.54	2.00 H	86	-0.12	26.58
9	951.40	31.76 QP	46.00	-14.24	1.50 H	54	4.44	27.32

ANTENNA POLARITY & TEST DISTANCE: VERTICAL AT 3 M								
No.	Freq. (MHz)	Emission Level (dBuV/m)	Limit (dBuV/m)	Margin (dB)	Antenna Height (m)	Table Angle (Degree)	Raw Value (dBuV)	Correction Factor (dB/m)
1	51.38	36.59 QP	40.00	-3.41	1.00 V	358	22.89	13.70
2	63.05	24.51 QP	40.00	-15.49	1.00 V	61	11.92	12.60
3	113.59	24.95 QP	43.50	-18.55	1.00 V	17	15.45	9.50
4	136.91	27.72 QP	43.50	-15.78	1.00 V	67	15.44	12.28
5	162.18	29.15 QP	43.50	-14.35	1.00 V	61	16.70	12.45
6	210.78	25.71 QP	43.50	-17.79	1.00 V	48	15.43	10.28
7	241.88	29.96 QP	46.00	-16.04	1.00 V	308	18.66	11.31
8	383.79	27.25 QP	46.00	-18.75	1.00 V	358	11.10	16.15
9	512.08	26.02 QP	46.00	-19.98	1.00 V	327	7.17	18.85
10	640.38	28.01 QP	46.00	-17.99	1.00 V	48	6.77	21.25
11	935.85	26.02 QP	46.00	-19.98	1.00 V	339	-0.65	26.67
12	945.57	34.59 QP	46.00	-11.41	1.00 V	327	7.44	27.14

- REMARKS:**
1. Emission level(dBuV/m)=Raw Value(dBuV) + Correction Factor(dB/m)
 2. Correction Factor(dB/m) = Antenna Factor (dB/m) + Cable Factor (dB)
 3. The other emission levels were very low against the limit.
 4. Margin value = Emission level – Limit value.



EUT TEST CONDITION		MEASUREMENT DETAIL	
CHANNEL	Channel 78	FREQUENCY RANGE	Below 1000MHz
MODULATION TYPE	GFSK	DETECTOR FUNCTION	Quasi-Peak
ENVIRONMENTAL CONDITIONS	26deg. C, 65%RH, 991hPa	INPUT POWER (SYSTEM)	120Vac, 60 Hz
TEST MODE	C	TESTED BY	Match Tsui

ANTENNA POLARITY & TEST DISTANCE: HORIZONTAL AT 3 M								
No.	Freq. (MHz)	Emission Level (dBuV/m)	Limit (dBuV/m)	Margin (dB)	Antenna Height (m)	Table Angle (Degree)	Raw Value (dBuV)	Correction Factor (dB/m)
1	76.65	25.06 QP	40.00	-14.94	2.00 H	23	14.52	10.54
2	119.42	29.51 QP	43.50	-13.99	2.00 H	5	19.52	9.99
3	142.75	32.14 QP	43.50	-11.36	2.00 H	23	19.47	12.67
4	191.34	31.99 QP	43.50	-11.51	2.00 H	80	21.48	10.50
5	210.78	30.48 QP	43.50	-13.02	2.50 H	111	20.20	10.28
6	383.79	34.36 QP	46.00	-11.64	2.00 H	5	18.22	16.15
7	521.80	30.96 QP	46.00	-15.04	2.00 H	80	11.92	19.04
8	601.50	29.25 QP	46.00	-16.75	2.00 H	219	8.43	20.82
9	720.08	30.64 QP	46.00	-15.36	2.00 H	80	7.63	23.00
10	760.90	30.29 QP	46.00	-15.71	2.00 H	187	6.37	23.93
11	799.78	28.42 QP	46.00	-17.58	2.50 H	111	4.44	23.98
12	945.57	32.93 QP	46.00	-13.07	2.00 H	130	5.78	27.14

ANTENNA POLARITY & TEST DISTANCE: VERTICAL AT 3 M								
No.	Freq. (MHz)	Emission Level (dBuV/m)	Limit (dBuV/m)	Margin (dB)	Antenna Height (m)	Table Angle (Degree)	Raw Value (dBuV)	Correction Factor (dB/m)
1	41.66	29.47 QP	40.00	-10.53	1.00 V	111	15.35	14.11
2	76.65	25.65 QP	40.00	-14.35	1.00 V	175	15.12	10.54
3	113.59	29.88 QP	43.50	-13.62	1.00 V	200	20.38	9.50
4	142.75	29.95 QP	43.50	-13.55	1.00 V	175	17.28	12.67
5	191.34	28.09 QP	43.50	-15.41	1.50 V	295	17.59	10.50
6	465.43	28.06 QP	46.00	-17.94	1.00 V	73	10.21	17.85
7	601.50	31.53 QP	46.00	-14.47	1.00 V	99	10.71	20.82
8	640.38	29.95 QP	46.00	-16.05	1.00 V	124	8.70	21.25
9	681.20	29.70 QP	46.00	-16.30	1.50 V	175	7.70	22.00
10	720.08	32.48 QP	46.00	-13.52	1.50 V	295	9.48	23.00
11	731.74	32.26 QP	46.00	-13.74	1.00 V	99	8.90	23.36
12	760.90	30.68 QP	46.00	-15.32	1.00 V	99	6.76	23.93
13	801.72	30.35 QP	46.00	-15.65	1.00 V	200	6.34	24.01
14	863.93	30.59 QP	46.00	-15.41	1.00 V	200	5.90	24.69
15	945.57	36.55 QP	46.00	-9.45	1.00 V	73	9.41	27.14

REMARKS:

1. Emission level(dBuV/m)=Raw Value(dBuV) + Correction Factor(dB/m)
2. Correction Factor(dB/m) = Antenna Factor (dB/m) + Cable Factor (dB)
3. The other emission levels were very low against the limit.
4. Margin value = Emission level – Limit value.



EUT TEST CONDITION		MEASUREMENT DETAIL	
CHANNEL	Channel 78	FREQUENCY RANGE	Below 1000MHz
MODULATION TYPE	GFSK	DETECTOR FUNCTION	Quasi-Peak
ENVIRONMENTAL CONDITIONS	26deg. C, 65%RH, 991hPa	INPUT POWER (SYSTEM)	120Vac, 60 Hz
TEST MODE	D	TESTED BY	Match Tsui

ANTENNA POLARITY & TEST DISTANCE: HORIZONTAL AT 3 M								
No.	Freq. (MHz)	Emission Level (dBuV/m)	Limit (dBuV/m)	Margin (dB)	Antenna Height (m)	Table Angle (Degree)	Raw Value (dBuV)	Correction Factor (dB/m)
1	72.77	26.62 QP	40.00	-13.38	2.00 H	213	15.52	11.10
2	142.75	32.21 QP	43.50	-11.29	2.50 H	10	19.53	12.67
3	210.78	30.92 QP	43.50	-12.58	2.00 H	213	20.63	10.28
4	517.92	30.74 QP	46.00	-15.26	2.50 H	16	11.78	18.96
5	611.22	31.65 QP	46.00	-14.35	2.00 H	10	10.72	20.93
6	640.38	31.51 QP	46.00	-14.49	2.00 H	213	10.26	21.25
7	720.08	30.66 QP	46.00	-15.34	2.00 H	48	7.66	23.00
8	751.18	29.28 QP	46.00	-16.72	2.00 H	48	5.37	23.91
9	760.90	29.23 QP	46.00	-16.77	2.00 H	257	5.31	23.93
10	947.52	28.94 QP	46.00	-17.06	2.00 H	257	1.70	27.24

ANTENNA POLARITY & TEST DISTANCE: VERTICAL AT 3 M								
No.	Freq. (MHz)	Emission Level (dBuV/m)	Limit (dBuV/m)	Margin (dB)	Antenna Height (m)	Table Angle (Degree)	Raw Value (dBuV)	Correction Factor (dB/m)
1	35.83	36.34 QP	40.00	-3.66	1.00 V	92	23.74	12.61
2	74.71	26.18 QP	40.00	-13.82	1.00 V	213	15.36	10.82
3	111.64	29.28 QP	43.50	-14.22	1.00 V	124	19.95	9.33
4	146.63	26.30 QP	43.50	-17.20	1.00 V	181	13.65	12.66
5	255.49	28.70 QP	46.00	-17.30	1.00 V	156	17.16	11.54
6	383.79	30.71 QP	46.00	-15.29	1.00 V	99	14.56	16.15
7	603.45	29.62 QP	46.00	-16.38	1.00 V	213	8.78	20.84
8	681.20	29.53 QP	46.00	-16.47	1.00 V	99	7.53	22.00
9	720.08	31.79 QP	46.00	-14.21	1.00 V	105	8.79	23.00
10	731.74	31.42 QP	46.00	-14.58	1.00 V	168	8.06	23.36
11	760.90	29.95 QP	46.00	-16.05	1.00 V	333	6.03	23.93
12	801.72	30.26 QP	46.00	-15.74	1.00 V	181	6.26	24.01
13	863.93	30.40 QP	46.00	-15.60	1.00 V	181	5.71	24.69
14	949.46	34.95 QP	46.00	-11.05	1.00 V	168	7.62	27.33

- REMARKS:**
1. Emission level(dBuV/m)=Raw Value(dBuV) + Correction Factor(dB/m)
 2. Correction Factor(dB/m) = Antenna Factor (dB/m) + Cable Factor (dB)
 3. The other emission levels were very low against the limit.
 4. Margin value = Emission level – Limit value.



EUT TEST CONDITION		MEASUREMENT DETAIL	
CHANNEL	Channel 78	FREQUENCY RANGE	Below 1000MHz
MODULATION TYPE	GFSK	DETECTOR FUNCTION	Quasi-Peak
ENVIRONMENTAL CONDITIONS	26deg. C, 65%RH, 991hPa	INPUT POWER (SYSTEM)	120Vac, 60 Hz
TEST MODE	E	TESTED BY	Match Tsui

ANTENNA POLARITY & TEST DISTANCE: HORIZONTAL AT 3 M								
No.	Freq. (MHz)	Emission Level (dBuV/m)	Limit (dBuV/m)	Margin (dB)	Antenna Height (m)	Table Angle (Degree)	Raw Value (dBuV)	Correction Factor (dB/m)
1	76.65	28.16 QP	40.00	-11.84	1.50 H	48	17.62	10.54
2	113.59	34.28 QP	43.50	-9.22	1.50 H	67	24.78	9.50
3	152.46	33.91 QP	43.50	-9.59	2.50 H	54	21.28	12.63
4	191.34	30.51 QP	43.50	-12.99	1.50 H	48	20.01	10.50
5	210.78	36.34 QP	43.50	-7.16	1.50 H	289	26.06	10.28
6	249.66	32.75 QP	46.00	-13.25	2.00 H	130	21.19	11.56
7	457.66	31.51 QP	46.00	-14.49	1.00 H	124	13.83	17.67
8	465.43	34.57 QP	46.00	-11.43	2.50 H	149	16.72	17.85
9	521.80	33.06 QP	46.00	-12.94	1.50 H	48	14.02	19.04
10	601.50	34.37 QP	46.00	-11.63	2.00 H	346	13.55	20.82
11	731.74	32.00 QP	46.00	-14.00	2.00 H	346	8.65	23.36
12	945.57	32.67 QP	46.00	-13.33	2.50 H	149	5.52	27.14

ANTENNA POLARITY & TEST DISTANCE: VERTICAL AT 3 M								
No.	Freq. (MHz)	Emission Level (dBuV/m)	Limit (dBuV/m)	Margin (dB)	Antenna Height (m)	Table Angle (Degree)	Raw Value (dBuV)	Correction Factor (dB/m)
1	115.53	33.88 QP	43.50	-9.62	1.00 V	194	24.22	9.66
2	249.66	35.82 QP	46.00	-10.18	1.00 V	327	24.26	11.56
3	455.71	33.49 QP	46.00	-12.51	1.00 V	130	15.86	17.63
4	465.43	36.95 QP	46.00	-9.05	2.00 V	54	19.10	17.85
5	512.08	31.88 QP	46.00	-14.12	1.00 V	194	13.03	18.85
6	562.63	32.83 QP	46.00	-13.17	1.00 V	92	12.93	19.90
7	733.69	33.70 QP	46.00	-12.30	2.00 V	73	10.29	23.41
8	945.57	37.02 QP	46.00	-8.98	2.00 V	54	9.88	27.14

- REMARKS:**
1. Emission level(dBuV/m)=Raw Value(dBuV) + Correction Factor(dB/m)
 2. Correction Factor(dB/m) = Antenna Factor (dB/m) + Cable Factor (dB)
 3. The other emission levels were very low against the limit.
 4. Margin value = Emission level – Limit value.



EUT TEST CONDITION		MEASUREMENT DETAIL	
CHANNEL	Channel 78	FREQUENCY RANGE	Below 1000MHz
MODULATION TYPE	GFSK	DETECTOR FUNCTION	Quasi-Peak
ENVIRONMENTAL CONDITIONS	25deg. C, 67%RH, 991hPa	INPUT POWER (SYSTEM)	120Vac, 60 Hz
TEST MODE	F	TESTED BY	Long Chen

ANTENNA POLARITY & TEST DISTANCE: HORIZONTAL AT 3 M								
No.	Freq. (MHz)	Emission Level (dBuV/m)	Limit (dBuV/m)	Margin (dB)	Antenna Height (m)	Table Angle (Degree)	Raw Value (dBuV)	Correction Factor (dB/m)
1	119.42	36.71 QP	43.50	-6.79	1.00 H	118	26.72	9.99
2	199.12	25.86 QP	43.50	-17.64	1.00 H	130	15.88	9.99
3	300.20	28.50 QP	46.00	-17.50	2.00 H	29	13.99	14.52
4	387.68	31.23 QP	46.00	-14.77	1.00 H	289	14.96	16.27
5	407.11	28.62 QP	46.00	-17.38	2.00 H	99	11.84	16.78
6	953.35	34.16 QP	46.00	-11.84	2.00 H	99	6.89	27.27

ANTENNA POLARITY & TEST DISTANCE: VERTICAL AT 3 M								
No.	Freq. (MHz)	Emission Level (dBuV/m)	Limit (dBuV/m)	Margin (dB)	Antenna Height (m)	Table Angle (Degree)	Raw Value (dBuV)	Correction Factor (dB/m)
1	39.72	25.83 QP	40.00	-14.17	1.00 V	301	12.01	13.82
2	74.71	26.19 QP	40.00	-13.81	1.00 V	130	15.37	10.82
3	115.53	37.45 QP	43.50	-6.05	1.00 V	168	27.79	9.66
4	129.14	29.59 QP	43.50	-13.91	1.00 V	225	18.34	11.25
5	300.20	27.45 QP	46.00	-18.55	1.75 V	105	12.94	14.52
6	615.11	27.41 QP	46.00	-18.59	1.00 V	352	6.44	20.97
7	626.77	28.15 QP	46.00	-17.85	1.25 V	162	7.05	21.10
8	681.20	28.09 QP	46.00	-17.91	1.00 V	352	6.09	22.00
9	945.57	38.18 QP	46.00	-7.82	1.75 V	105	11.04	27.14

- REMARKS:**
1. Emission level(dBuV/m)=Raw Value(dBuV) + Correction Factor(dB/m)
 2. Correction Factor(dB/m) = Antenna Factor (dB/m) + Cable Factor (dB)
 3. The other emission levels were very low against the limit.
 4. Margin value = Emission level – Limit value.

EUT TEST CONDITION		MEASUREMENT DETAIL	
CHANNEL	Channel 78	FREQUENCY RANGE	Below 1000MHz
MODULATION TYPE	GFSK	DETECTOR FUNCTION	Quasi-Peak
ENVIRONMENTAL CONDITIONS	26deg. C, 65%RH, 991hPa	INPUT POWER (SYSTEM)	120Vac, 60 Hz
TEST MODE	G	TESTED BY	Match Tsui

ANTENNA POLARITY & TEST DISTANCE: HORIZONTAL AT 3 M								
No.	Freq. (MHz)	Emission Level (dBuV/m)	Limit (dBuV/m)	Margin (dB)	Antenna Height (m)	Table Angle (Degree)	Raw Value (dBuV)	Correction Factor (dB/m)
1	113.59	30.49 QP	43.50	-13.01	1.50 H	251	21.00	9.50
2	210.78	27.86 QP	43.50	-15.64	1.50 H	111	17.58	10.28
3	249.66	32.81 QP	46.00	-13.19	1.00 H	308	21.25	11.56
4	383.79	31.04 QP	46.00	-14.96	2.00 H	232	14.89	16.15
5	457.66	30.55 QP	46.00	-15.45	1.50 H	295	12.87	17.67
6	465.43	36.55 QP	46.00	-9.45	2.00 H	219	18.71	17.85
7	584.01	30.53 QP	46.00	-15.47	1.00 H	92	10.11	20.42
8	601.50	35.40 QP	46.00	-10.60	2.00 H	257	14.58	20.82
9	751.18	33.19 QP	46.00	-12.81	1.50 H	346	9.28	23.91
10	801.72	32.53 QP	46.00	-13.47	1.50 H	251	8.52	24.01
11	865.87	30.22 QP	46.00	-15.78	2.00 H	244	5.51	24.71
12	945.57	30.62 QP	46.00	-15.38	2.00 H	219	3.47	27.14

ANTENNA POLARITY & TEST DISTANCE: VERTICAL AT 3 M								
No.	Freq. (MHz)	Emission Level (dBuV/m)	Limit (dBuV/m)	Margin (dB)	Antenna Height (m)	Table Angle (Degree)	Raw Value (dBuV)	Correction Factor (dB/m)
1	30.00	26.63 QP	40.00	-13.37	1.00 V	333	14.96	11.67
2	113.59	30.53 QP	43.50	-12.97	1.00 V	80	21.04	9.50
3	249.66	30.54 QP	46.00	-15.46	1.00 V	80	18.97	11.56
4	457.66	33.10 QP	46.00	-12.90	1.00 V	263	15.42	17.67
5	465.43	34.09 QP	46.00	-11.91	1.00 V	219	16.24	17.85
6	515.97	30.70 QP	46.00	-15.30	1.50 V	99	11.77	18.93
7	601.50	33.13 QP	46.00	-12.87	1.00 V	295	12.31	20.82
8	751.18	31.71 QP	46.00	-14.29	1.00 V	42	7.80	23.91
9	799.78	30.99 QP	46.00	-15.01	1.00 V	86	7.00	23.98
10	945.57	33.14 QP	46.00	-12.86	1.00 V	219	6.00	27.14

- REMARKS:**
1. Emission level(dBuV/m)=Raw Value(dBuV) + Correction Factor(dB/m)
 2. Correction Factor(dB/m) = Antenna Factor (dB/m) + Cable Factor (dB)
 3. The other emission levels were very low against the limit.
 4. Margin value = Emission level – Limit value.



EUT TEST CONDITION		MEASUREMENT DETAIL	
CHANNEL	Channel 0	FREQUENCY RANGE	1 ~ 25GHz
MODULATION TYPE	GFSK	DETECTOR FUNCTION	Peak (PK) Average (AV)
INPUT POWER (SYSTEM)	120Vac, 60 Hz	ENVIRONMENTAL CONDITIONS	23deg. C, 68%RH, 991hPa
TEST MODE	E	TESTED BY	Morgan Chen

ANTENNA POLARITY & TEST DISTANCE: HORIZONTAL AT 3 M								
No.	Freq. (MHz)	Emission Level (dBuV/m)	Limit (dBuV/m)	Margin (dB)	Antenna Height (m)	Table Angle (Degree)	Raw Value (dBuV)	Correction Factor (dB/m)
1	1601.00	45.11 PK	74.00	-28.89	1.13 H	91	15.86	29.25
1	1601.00	28.92 AV	54.00	-25.08	1.13 H	91	-0.33	29.25
2	2390.00	38.82 PK	74.00	-35.18	1.09 H	36	7.33	31.49
2	2390.00	32.41 AV	54.00	-21.59	1.09 H	36	0.92	31.49
3	*2402.00	87.82 PK			1.08 H	352	56.28	31.54
3	*2402.00	57.82 AV			1.08 H	352	26.28	31.54
4	4804.00	47.32 PK	74.00	-26.68	1.01 H	32	9.84	37.48
4	4804.00	17.32 AV	54.00	-36.68	1.01 H	32	-20.16	37.48

ANTENNA POLARITY & TEST DISTANCE: VERTICAL AT 3 M								
No.	Freq. (MHz)	Emission Level (dBuV/m)	Limit (dBuV/m)	Margin (dB)	Antenna Height (m)	Table Angle (Degree)	Raw Value (dBuV)	Correction Factor (dB/m)
1	1601.00	45.60 PK	74.00	-28.40	1.07 V	19	16.35	29.25
1	1601.00	29.01 AV	54.00	-24.99	1.07 V	19	-0.24	29.25
2	2390.00	35.65 PK	74.00	-38.35	1.33 V	312	4.16	31.49
2	2390.00	30.25 AV	54.00	-23.75	1.33 V	312	-1.24	31.49
3	*2402.00	84.66 PK			1.16 V	204	53.12	31.54
3	*2402.00	54.66 AV			1.16 V	204	23.12	31.54
4	4804.00	47.10 PK	74.00	-26.90	1.08 V	315	9.62	37.48
4	4804.00	17.10 AV	54.00	-36.90	1.08 V	315	-20.38	37.48

- REMARKS:**
1. Emission level (dBuV/m) = Raw Value (dBuV) + Correction Factor (dB/m).
 2. Correction Factor (dB/m) = Antenna Factor (dB/m) + Cable Factor (dB).
 3. The other emission levels were very low against the limit.
 4. Margin value = Emission level – Limit value.
 5. The DH5 packet was the worse case duty cycle for a transmit dwell time on a channel, based upon bluetooth theory the transmitter is on 0.625 * 5 per 247 ms per channel. Therefore, the duty cycle be equal to $20\log(3.125/100) = -30$ dB.
 6. Average value = peak reading – 20log (duty cycle).



EUT TEST CONDITION		MEASUREMENT DETAIL	
CHANNEL	Channel 39	FREQUENCY RANGE	1 ~ 25GHz
MODULATION TYPE	GFSK	DETECTOR FUNCTION	Peak (PK) Average (AV)
INPUT POWER (SYSTEM)	120Vac, 60 Hz	ENVIRONMENTAL CONDITIONS	23deg. C, 68%RH, 991hPa
TEST MODE	E	TESTED BY	Morgan Chen

ANTENNA POLARITY & TEST DISTANCE: HORIZONTAL AT 3 M								
No.	Freq. (MHz)	Emission Level (dBuV/m)	Limit (dBuV/m)	Margin (dB)	Antenna Height (m)	Table Angle (Degree)	Raw Value (dBuV)	Correction Factor (dB/m)
1	1627.00	45.88 PK	74.00	-28.12	1.06 H	352	16.60	29.28
1	1627.00	29.12 AV	54.00	-24.88	1.06 H	352	-0.16	29.28
2	*2441.00	90.75 PK			1.24 H	309	59.03	31.72
2	*2441.00	60.75 AV			1.24 H	309	29.03	31.72
3	4882.00	47.55 PK	74.00	-26.45	1.05 H	15	9.88	37.67
3	4882.00	17.55 AV	54.00	-36.45	1.05 H	15	-20.12	37.67

ANTENNA POLARITY & TEST DISTANCE: VERTICAL AT 3 M								
No.	Freq. (MHz)	Emission Level (dBuV/m)	Limit (dBuV/m)	Margin (dB)	Antenna Height (m)	Table Angle (Degree)	Raw Value (dBuV)	Correction Factor (dB/m)
1	1627.00	45.71 PK	74.00	-28.29	1.06 V	32	16.43	29.28
1	1627.00	29.18 AV	54.00	-24.82	1.06 V	32	-0.10	29.28
2	*2441.00	87.55 PK			1.26 V	302	55.83	31.72
2	*2441.00	57.55 AV			1.26 V	302	25.83	31.72
3	4882.00	47.11 PK	74.00	-26.89	1.03 V	313	9.44	37.67
3	4882.00	17.11 AV	54.00	-36.89	1.03 V	313	-20.56	37.67

- REMARKS:**
1. Emission level (dBuV/m) = Raw Value (dBuV) + Correction Factor (dB/m).
 2. Correction Factor (dB/m) = Antenna Factor (dB/m) + Cable Factor (dB).
 3. The other emission levels were very low against the limit.
 4. Margin value = Emission level – Limit value.
 5. The DH5 packet was the worse case duty cycle for a transmit dwell time on a channel, based upon bluetooth theory the transmitter is on 0.625 * 5 per 247 ms per channel. Therefore, the duty cycle be equal to $20\log(3.125/100) = -30$ dB.
 6. Average value = peak reading – $20\log$ (duty cycle).

EUT TEST CONDITION		MEASUREMENT DETAIL	
CHANNEL	Channel 78	FREQUENCY RANGE	1 ~ 25GHz
MODULATION TYPE	GFSK	DETECTOR FUNCTION	Peak (PK) Average (AV)
INPUT POWER (SYSTEM)	120Vac, 60 Hz	ENVIRONMENTAL CONDITIONS	23deg. C, 68%RH, 991hPa
TEST MODE	E	TESTED BY	Morgan Chen

ANTENNA POLARITY & TEST DISTANCE: HORIZONTAL AT 3 M								
No.	Freq. (MHz)	Emission Level (dBuV/m)	Limit (dBuV/m)	Margin (dB)	Antenna Height (m)	Table Angle (Degree)	Raw Value (dBuV)	Correction Factor (dB/m)
1	1653.00	45.55 PK	74.00	-28.45	1.09 H	35	16.24	29.31
1	1653.00	29.35 AV	54.00	-24.65	1.09 H	35	0.04	29.31
2	*2480.00	92.37 PK			1.01 H	341	60.47	31.90
2	*2480.00	62.37 AV			1.01 H	341	30.47	31.90
3	2483.50	43.12 PK	74.00	-30.88	1.03 H	311	11.21	31.91
3	2483.50	35.33 AV	54.00	-18.67	1.03 H	311	3.42	31.91
4	4960.00	48.55 PK	74.00	-25.45	1.05 H	13	10.72	37.83
4	4960.00	18.55 AV	54.00	-35.45	1.05 H	13	-19.28	37.83

ANTENNA POLARITY & TEST DISTANCE: VERTICAL AT 3 M								
No.	Freq. (MHz)	Emission Level (dBuV/m)	Limit (dBuV/m)	Margin (dB)	Antenna Height (m)	Table Angle (Degree)	Raw Value (dBuV)	Correction Factor (dB/m)
1	1653.00	45.71 PK	74.00	-28.29	1.03 V	32	16.40	29.31
1	1653.00	29.33 AV	54.00	-24.67	1.03 V	32	0.02	29.31
2	*2480.00	89.11 PK			1.13 V	321	57.21	31.90
2	*2480.00	59.11 AV			1.13 V	321	27.21	31.90
3	2483.50	40.11 PK	74.00	-33.89	1.03 V	318	8.20	31.91
3	2483.50	34.43 AV	54.00	-19.57	1.03 V	318	2.52	31.91
4	4960.00	48.13 PK	74.00	-25.87	1.03 V	321	10.30	37.83
4	4960.00	18.13 AV	54.00	-35.87	1.03 V	321	-19.70	37.83

- REMARKS:**
1. Emission level (dBuV/m) = Raw Value (dBuV) + Correction Factor (dB/m).
 2. Correction Factor (dB/m) = Antenna Factor (dB/m) + Cable Factor (dB).
 3. The other emission levels were very low against the limit.
 4. Margin value = Emission level – Limit value.
 5. The DH5 packet was the worse case duty cycle for a transmit dwell time on a channel, based upon bluetooth theory the transmitter is on 0.625 * 5 per 247 ms per channel. Therefore, the duty cycle be equal to $20\log(3.125/100) = -30$ dB.
 6. Average value = peak reading – $20\log(\text{duty cycle})$.



4.3 NUMBER OF HOPPING FREQUENCY USED

4.3.1 LIMIT OF HOPPING FREQUENCY USED

At least 15 channels frequencies, and should be equally spaced.

4.3.2 TEST INSTRUMENTS

DESCRIPTION & MANUFACTURER	MODEL NO.	SERIAL NO.	CALIBRATED UNTIL
SPECTRUM ANALYZER	FSP40	100040	Jun. 07, 2007

NOTE: The calibration interval of the above test instruments is 12 months. And the calibrations are traceable to NML/ROC and NIST/USA.

4.3.3 TEST PROCEDURES

- a. Check the calibration of the measuring instrument (SA) using either an internal calibrator or a known signal from an external generator.
- b. Turn on the EUT and connect its antenna terminal to measurement via a low loss cable. Then set it to any one measured frequency within its operating range and make sure the instrument is operated in its linear range.
- c. Set the SA on MaxHold Mode, and then keep the EUT in hopping mode. Record all the signals from each channel until each one has been recorded.
- d. Set the SA on View mode and then plot the result on SA screen.
- e. Repeat above procedures until all frequencies measured were complete.

4.3.4 DEVIATION FROM TEST STANDARD

No deviation.

4.3.5 TEST SETUP

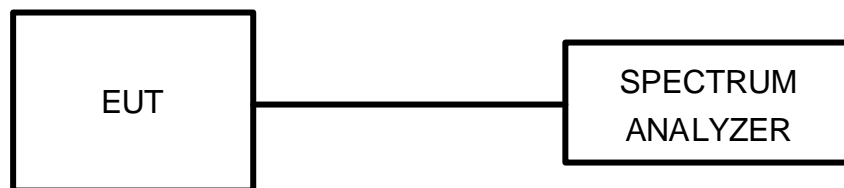

4.3.6 TEST RESULTS

There are 79 hopping frequencies in the hopping mode. Please refer to next two pages for the test result. On the plots, it shows that the hopping frequencies are equally spaced.

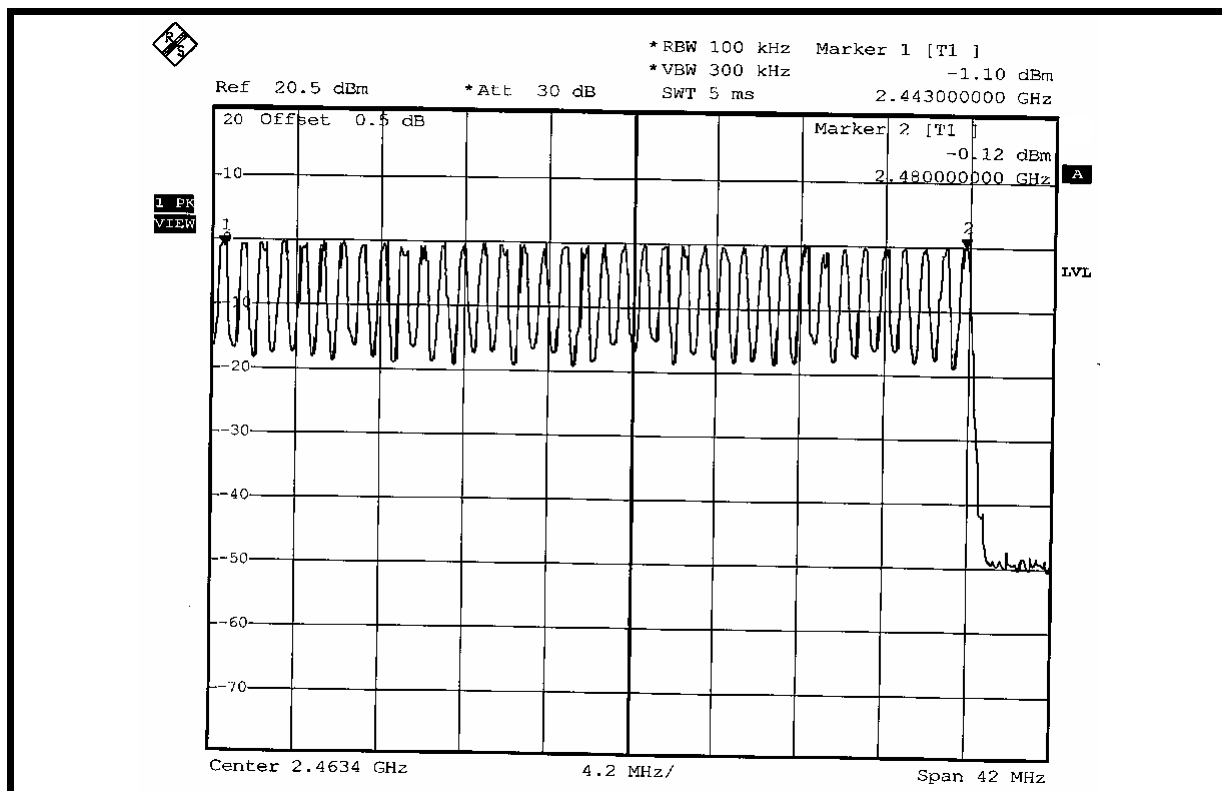
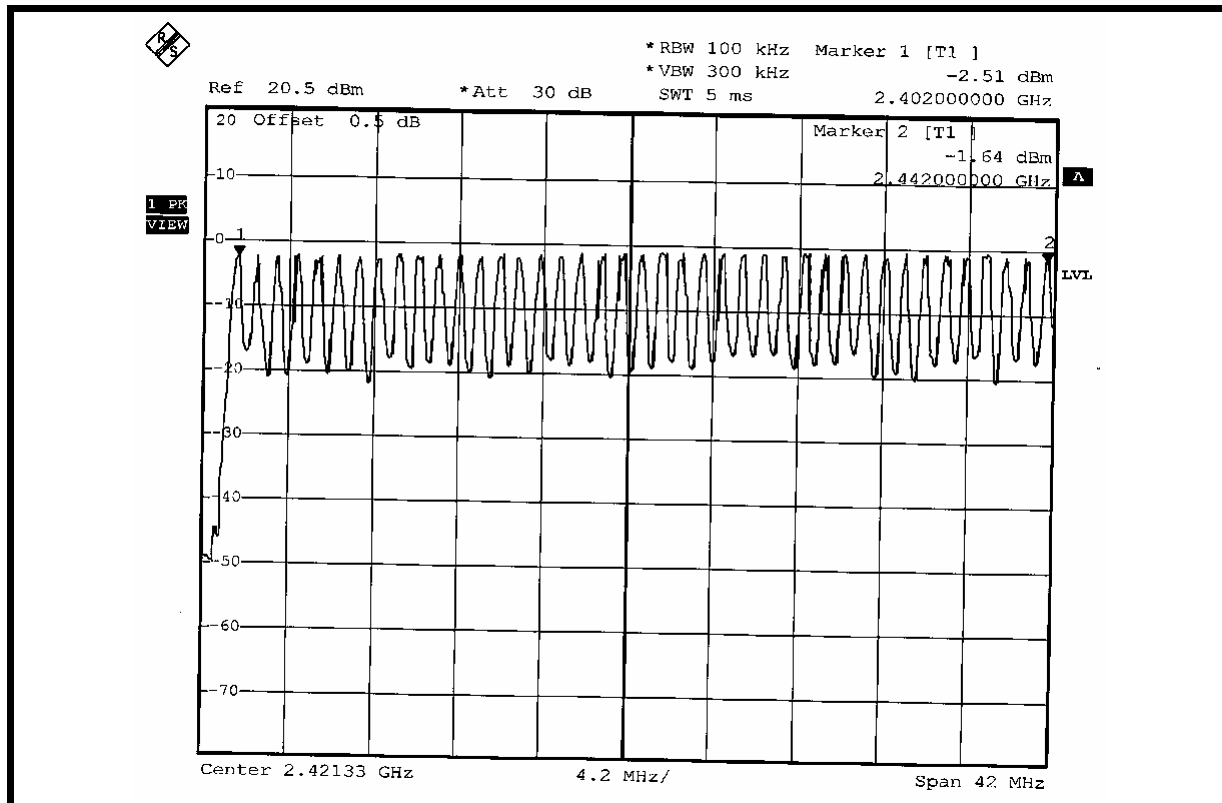



4.4 DWELL TIME ON EACH CHANNEL

4.4.1 LIMIT OF DWELL TIME USED

The average time of occupancy on any channel shall not be greater than 0.4 seconds within a period of 0.4 seconds multiplied by the number of hopping channels employed.

4.4.2 TEST INSTRUMENTS

DESCRIPTION & MANUFACTURER	MODEL NO.	SERIAL NO.	CALIBRATED UNTIL
SPECTRUM ANALYZER	FSP40	100040	Jun. 07, 2007

NOTES: The calibration interval of the above test instruments is 12 months. And the calibrations are traceable to NML/ROC and NIST/USA.

4.4.3 TEST PROCEDURES

- a. Check the calibration of the measuring instrument (SA) using either an internal calibrator or a known signal from an external generator.
- b. Turn on the EUT and connect its antenna terminal to measurement via a low loss cable. Then set it to any one measured frequency within its operating range and make sure the instrument is operated in its linear range.
- c. Adjust the center frequency of SA on any frequency be measured and set SA to zero span mode. And then, set RBW and VBW of spectrum analyzer to proper value.
- d. Measure the time duration of one transmission on the measured frequency. And then plot the result with time difference of this time duration.
- e. Repeat above procedures until all different time-slot modes have been completed.

4.4.4 DEVIATION FROM TEST STANDARD

No deviation.

4.4.5 TEST SETUP

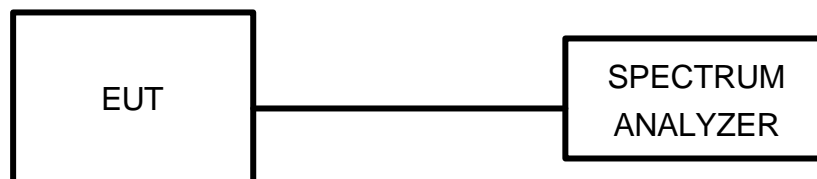

4.4.6 TEST RESULTS

MODE	NUMBER OF TRANSMISSION IN A 31.6 (79HOPPING*0.4)	LENGTH OF TRANSMISSION TIME (msec)	RESULT (msec)	LIMIT (msec)
DH1	50 (times / 5 sec) * 6.32 = 316.00 times	0.474	149.784	400
DH3	25 (times / 5 sec) * 6.32 = 158.00 times	1.728	273.024	400
DH5	18 (times / 5 sec) * 6.32 = 113.76 times	3.040	345.830	400

NOTE: Test plots of the transmitting time slot are shown on next 3 pages.

DH1

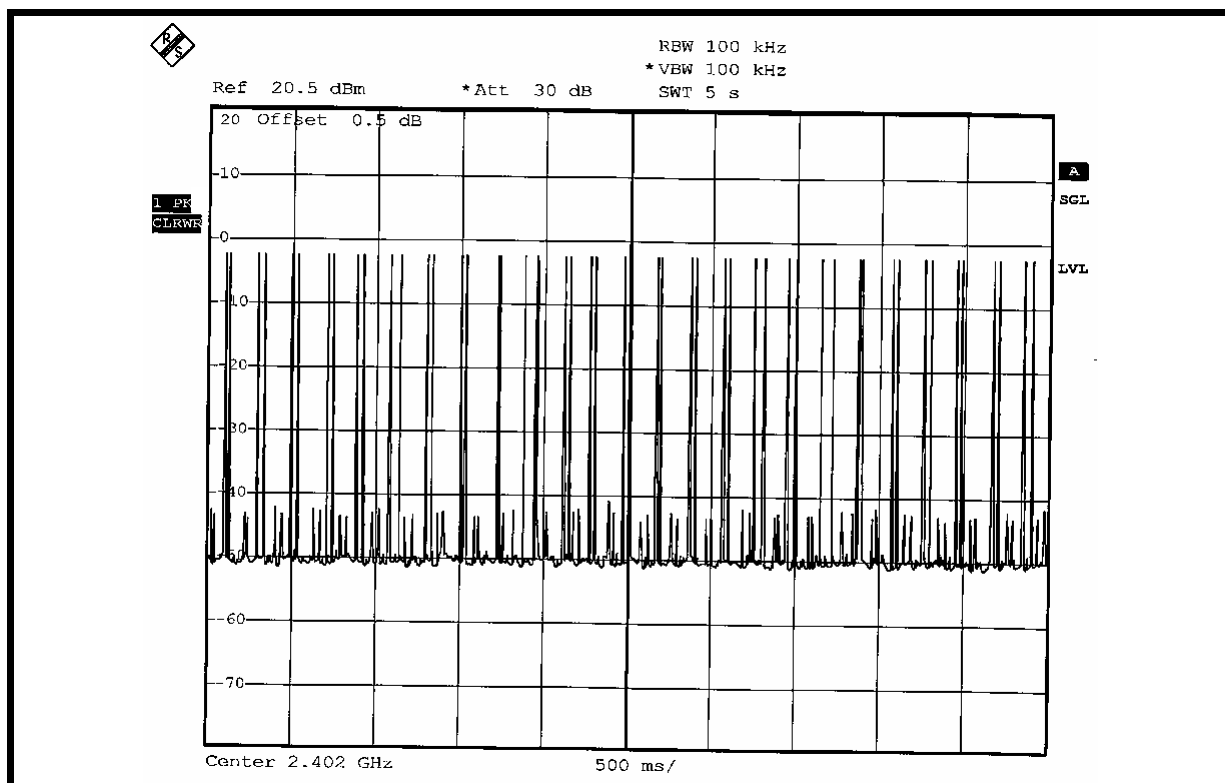
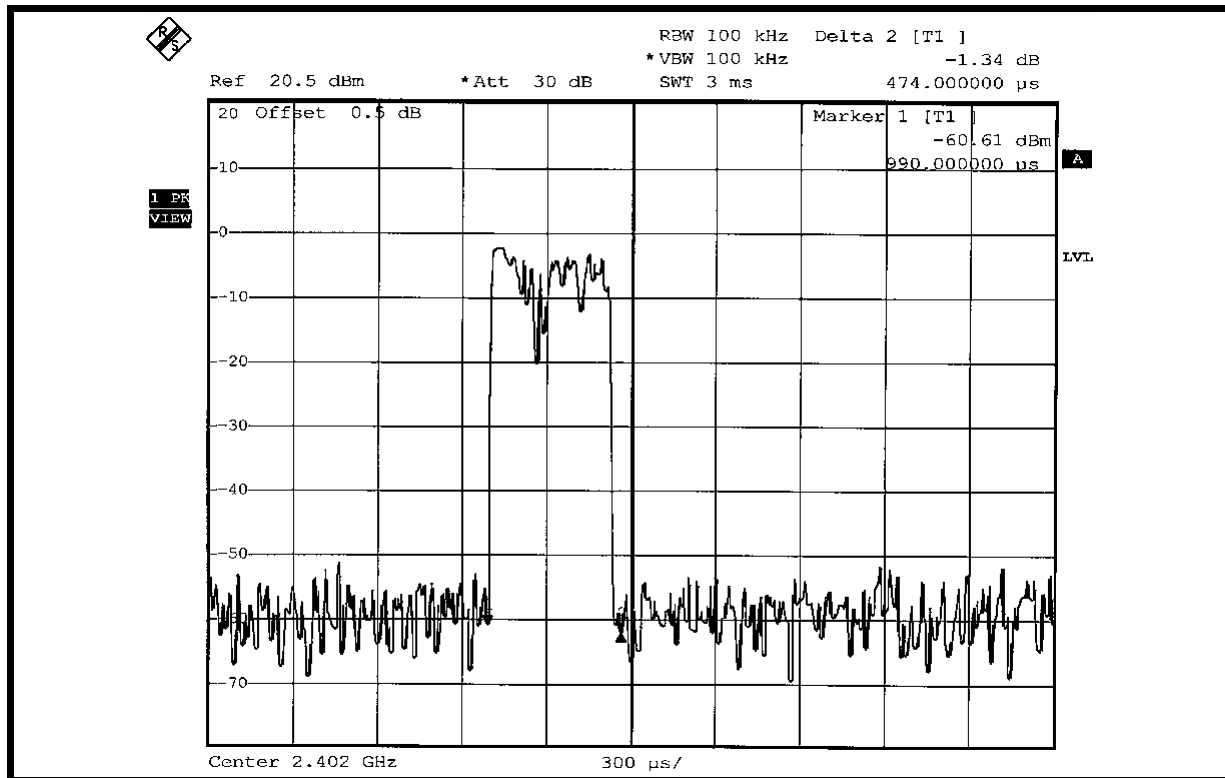

DH3

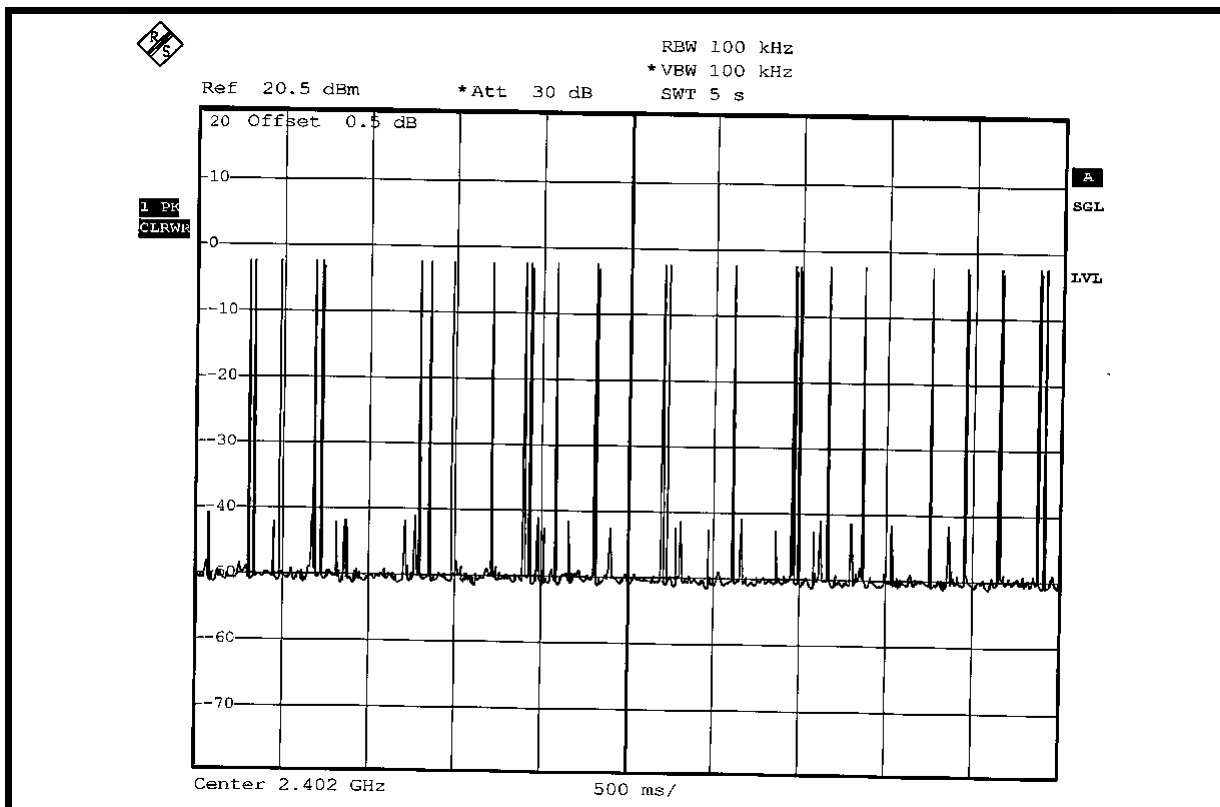
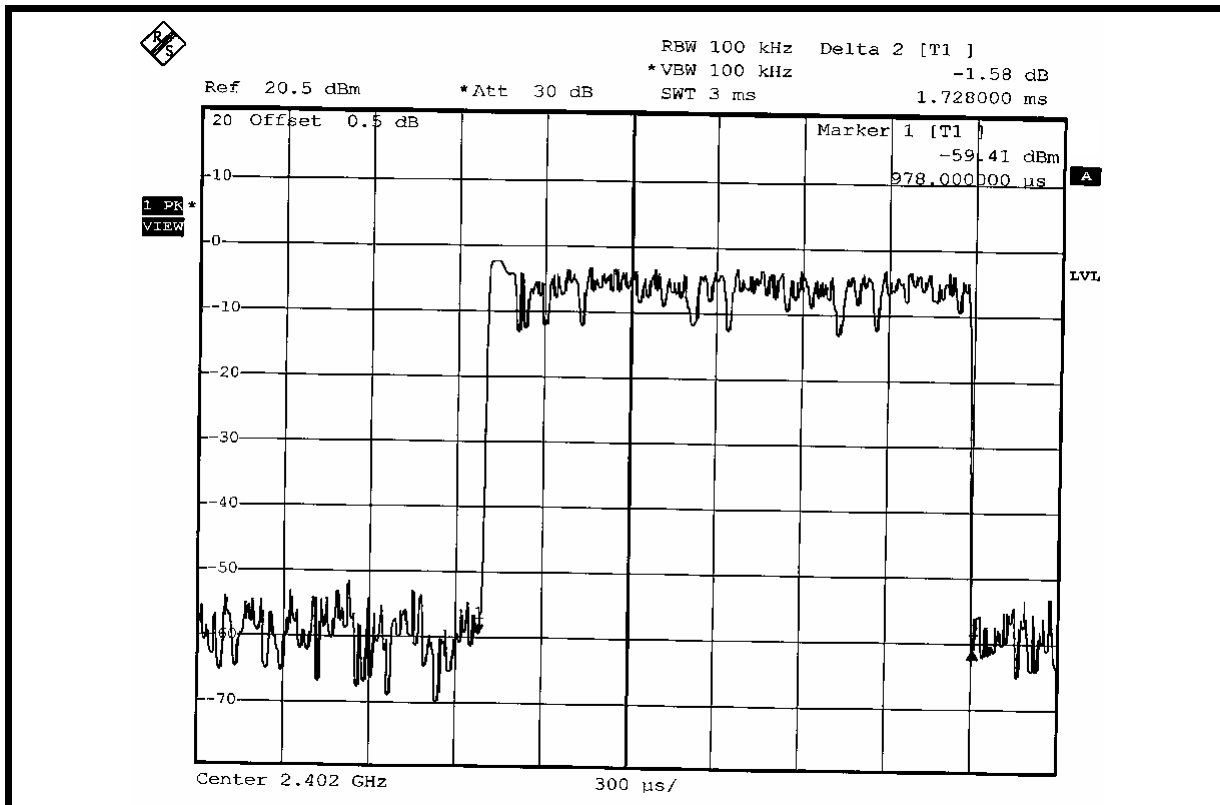

DH5

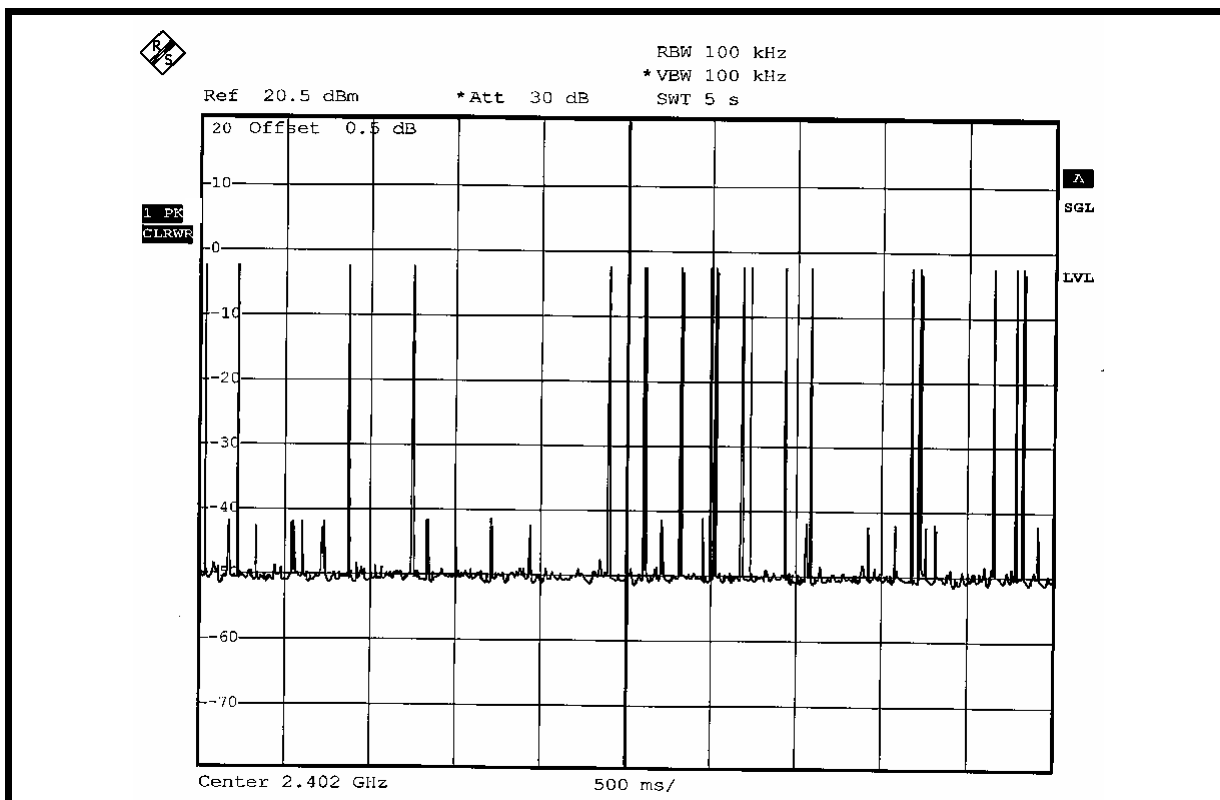
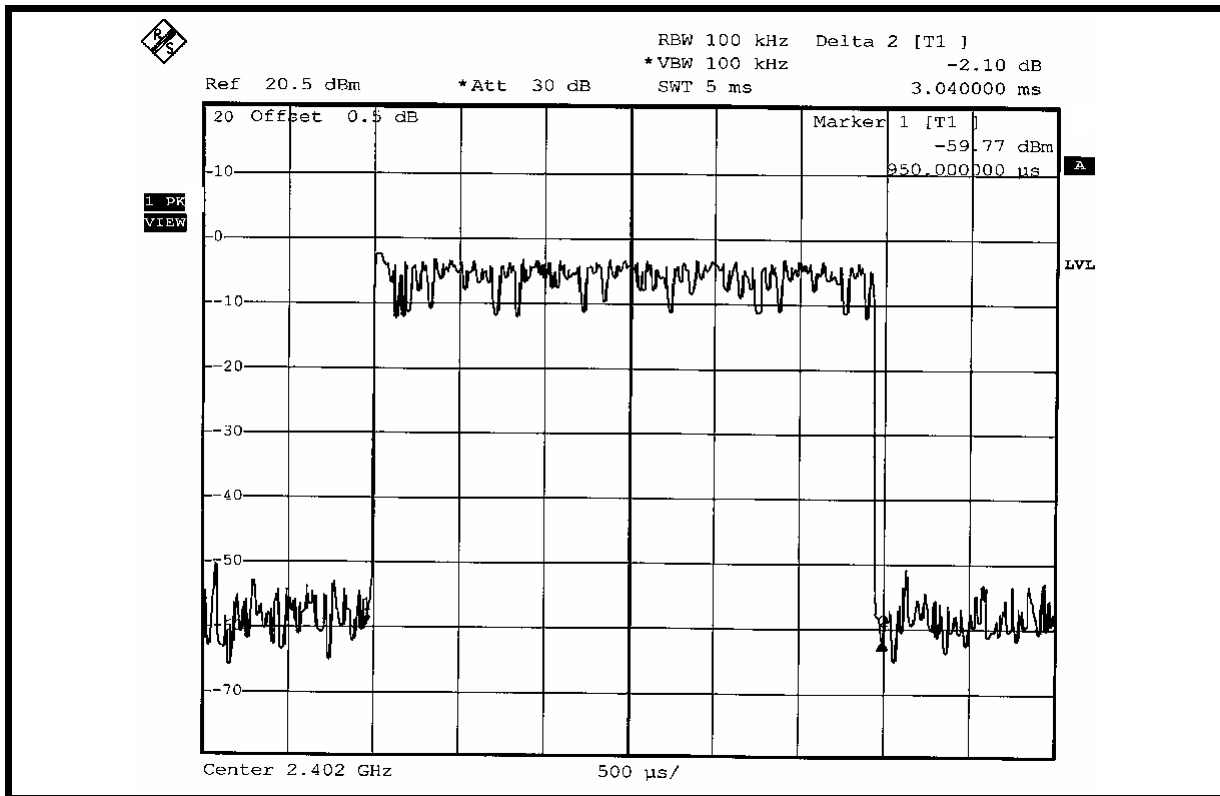



4.5 CHANNEL BANDWIDTH

4.5.1 LIMITS OF CHANNEL BANDWIDTH

For frequency hopping system operating in the 2400-2483.5MHz, If the 20dB bandwidth of hopping channel is greater than 25kHz, the 20dB bandwidth of hopping channel shall be a minimum limit for the hopping channel separation.

4.5.2 TEST INSTRUMENTS

DESCRIPTION & MANUFACTURER	MODEL NO.	SERIAL NO.	CALIBRATED UNTIL
SPECTRUM ANALYZER	FSP40	100040	Jun. 07, 2007

NOTE: The calibration interval of the above test instruments is 12 months. And the calibrations are traceable to NML/ROC and NIST/USA.

4.5.3 TEST PROCEDURE

- a. Check the calibration of the measuring instrument using either an internal calibrator or a known signal from an external generator.
- b. Turn on the EUT and connect it to measurement instrument. Then set it to any one convenient frequency within its operating range. Set a reference level on the measuring instrument equal to the highest peak value.
- c. Measure the frequency difference of two frequencies that were attenuated 20dB from the reference level. Record the frequency difference as the emission bandwidth.
- d. Repeat above procedures until all frequencies measured were complete.

4.5.4 DEVIATION FROM TEST STANDARD

No deviation.

4.5.5 TEST SETUP

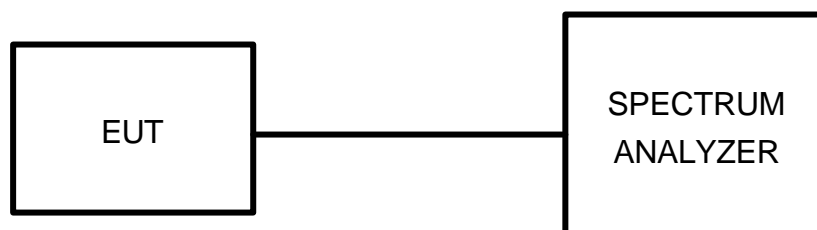

4.5.6 EUT OPERATING CONDITION

The software provided by client enabled the EUT to transmit and receive data at lowest, middle and highest channel frequencies individually.

4.5.7 TEST RESULTS

MODULATION TYPE	GFSK	ENVIRONMENTAL CONDITIONS	23deg. C, 68%RH, 991hPa
INPUT POWER (SYSTEM)	120Vac, 60 Hz	TESTED BY	Long Chen

CHANNEL	CHANNEL FREQUENCY (MHz)	20dB BANDWIDTH (MHz)
0	2402	0.961
39	2441	0.966
78	2480	0.966

CH 0

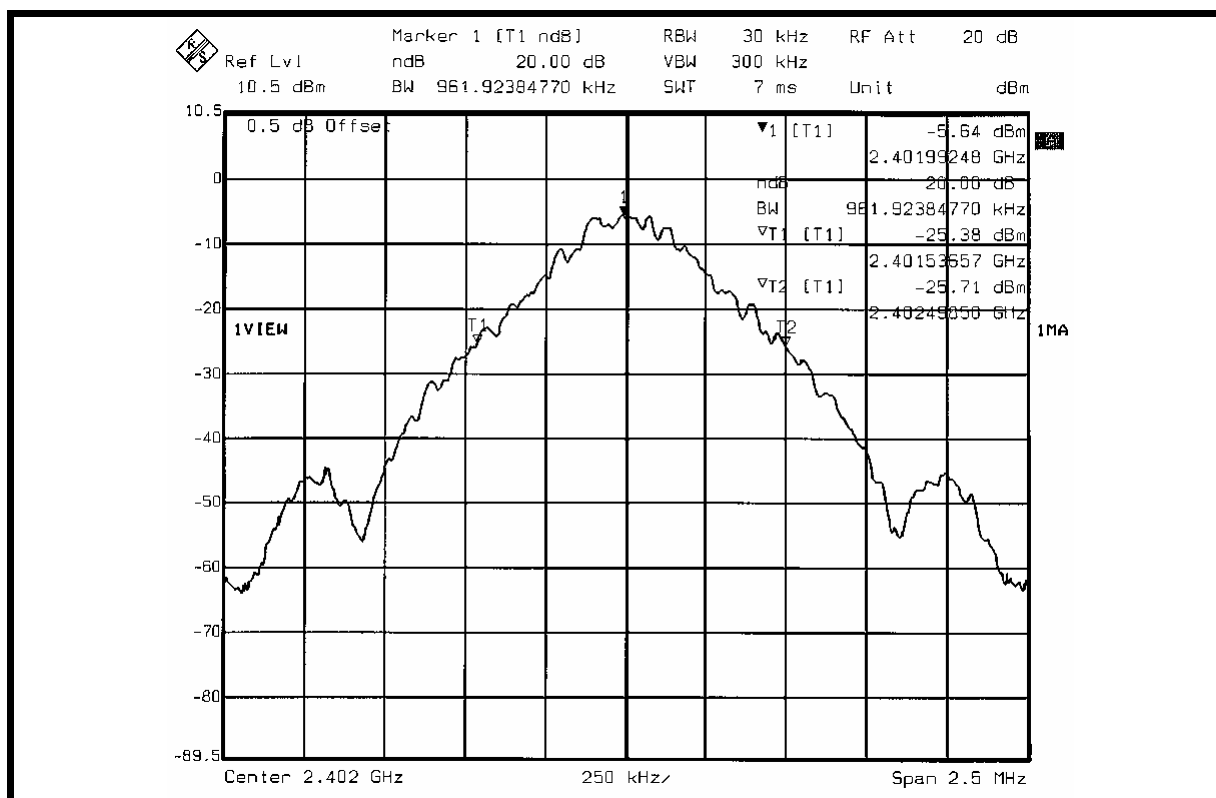

CH 39

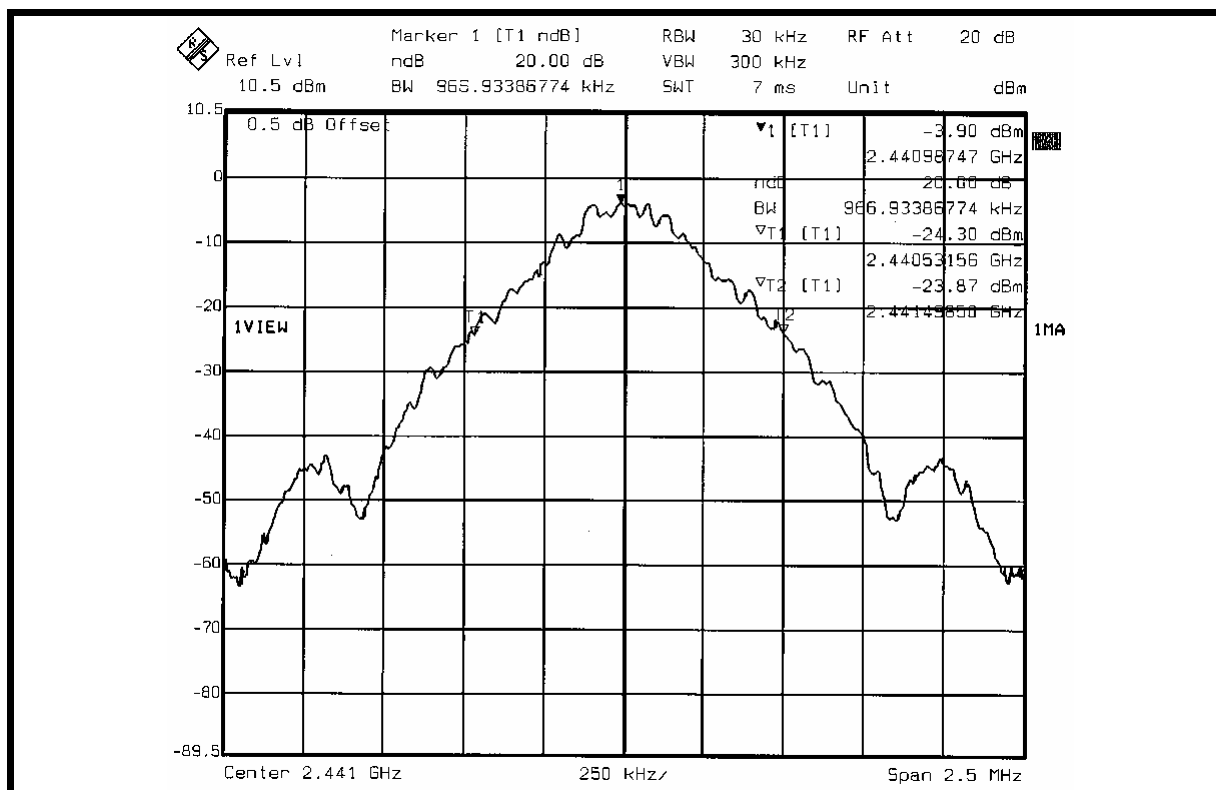

CH 78

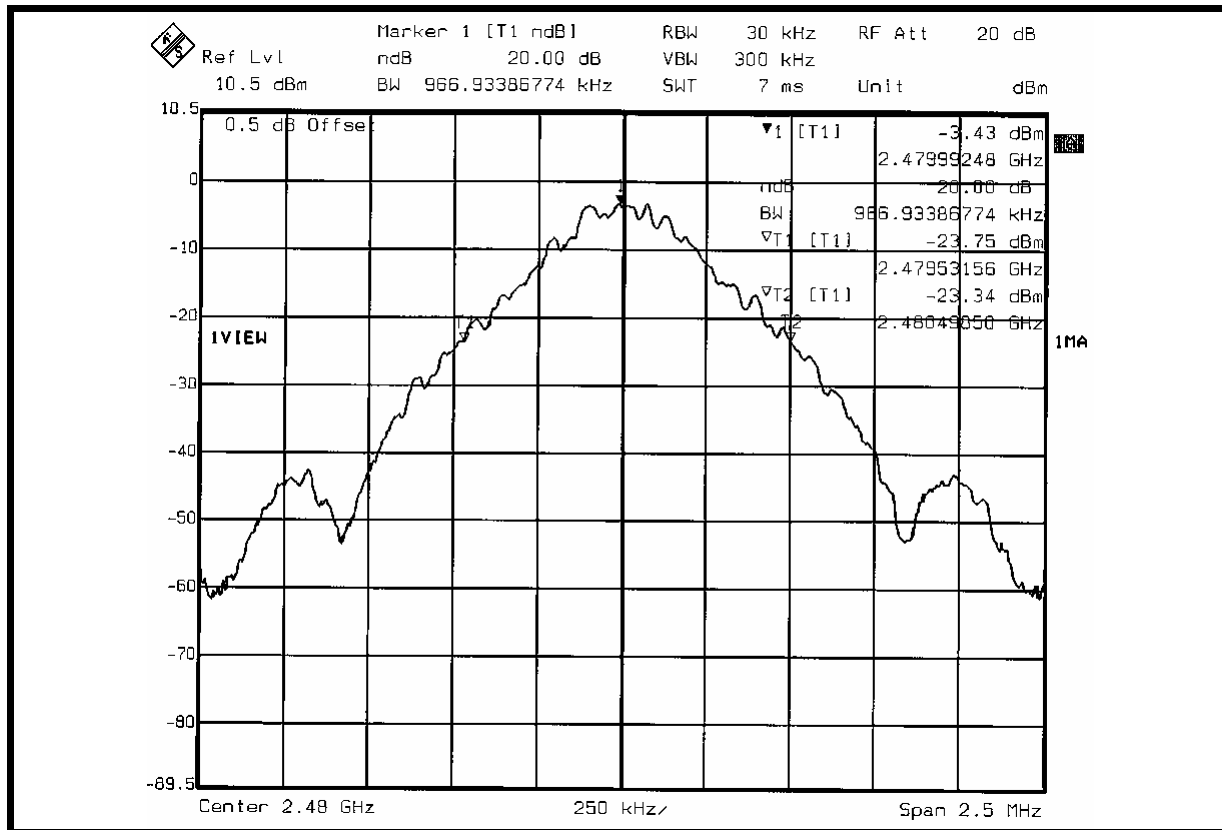



4.6 HOPPING CHANNEL SEPARATION

4.6.1 LIMIT OF HOPPING CHANNEL SEPARATION

At least 25kHz or 20dB bandwidth (whichever is greater).

4.6.2 TEST INSTRUMENTS

DESCRIPTION & MANUFACTURER	MODEL NO.	SERIAL NO.	CALIBRATED UNTIL
SPECTRUM ANALYZER	FSP40	100040	Jun. 07, 2007

NOTES: The calibration interval of the above test instruments is 12 months. And the calibrations are traceable to NML/ROC and NIST/USA.

4.6.3 TEST PROCEDURES

1. Check the calibration of the measuring instrument using either an internal calibrator or a known signal from an external generator.
2. Turn on the EUT and connect it to measurement instrument. Then set it to any one convenient frequency within its operating range.
3. By using the MaxHold function record the separation of two adjacent channels.
4. Measure the frequency difference of these two adjacent channels by SA MARK function. And then plot the result on SA screen.
5. Repeat above procedures until all frequencies measured were complete.

4.6.4 DEVIATION FROM TEST STANDARD

No deviation

4.6.5 TEST SETUP

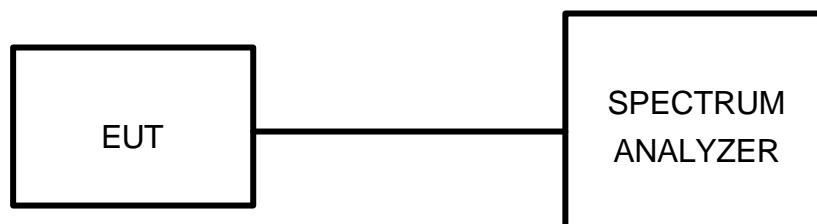

4.6.6 TEST RESULTS

MODULATION TYPE	GFSK	ENVIRONMENTAL CONDITIONS	23deg. C, 68%RH, 991hPa
INPUT POWER (SYSTEM)	120Vac, 60 Hz	TESTED BY	Long Chen

CHANNEL	FREQUENCY (MHz)	ADJACENT CHANNEL SEPARATION (MHz)	MINIMUM LIMIT (MHz)	PASS / FAIL
0	2402	1.010	0.961	PASS
39	2441	1.005	0.966	PASS
78	2480	1.003	0.966	PASS

NOTE: The minimum limit is 20dB bandwidth. Test results please refer to next two pages.

CH 0

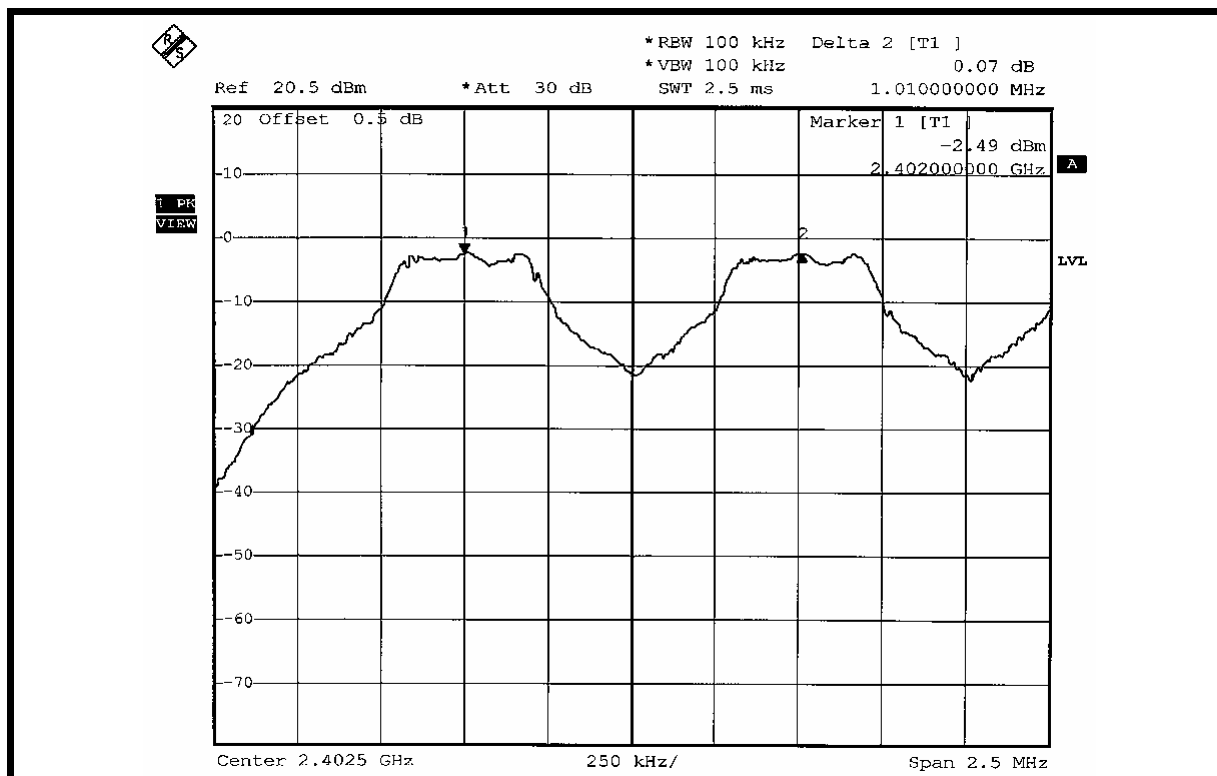

CH 39

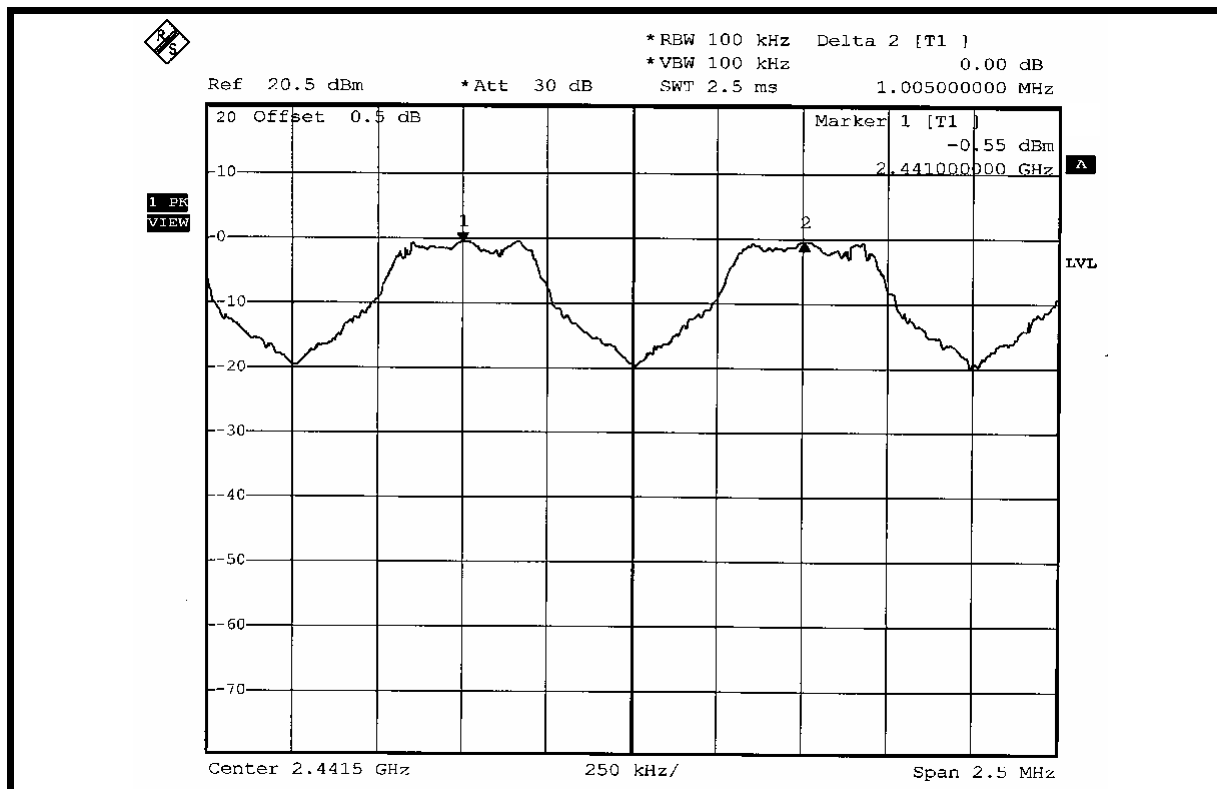

CH 78

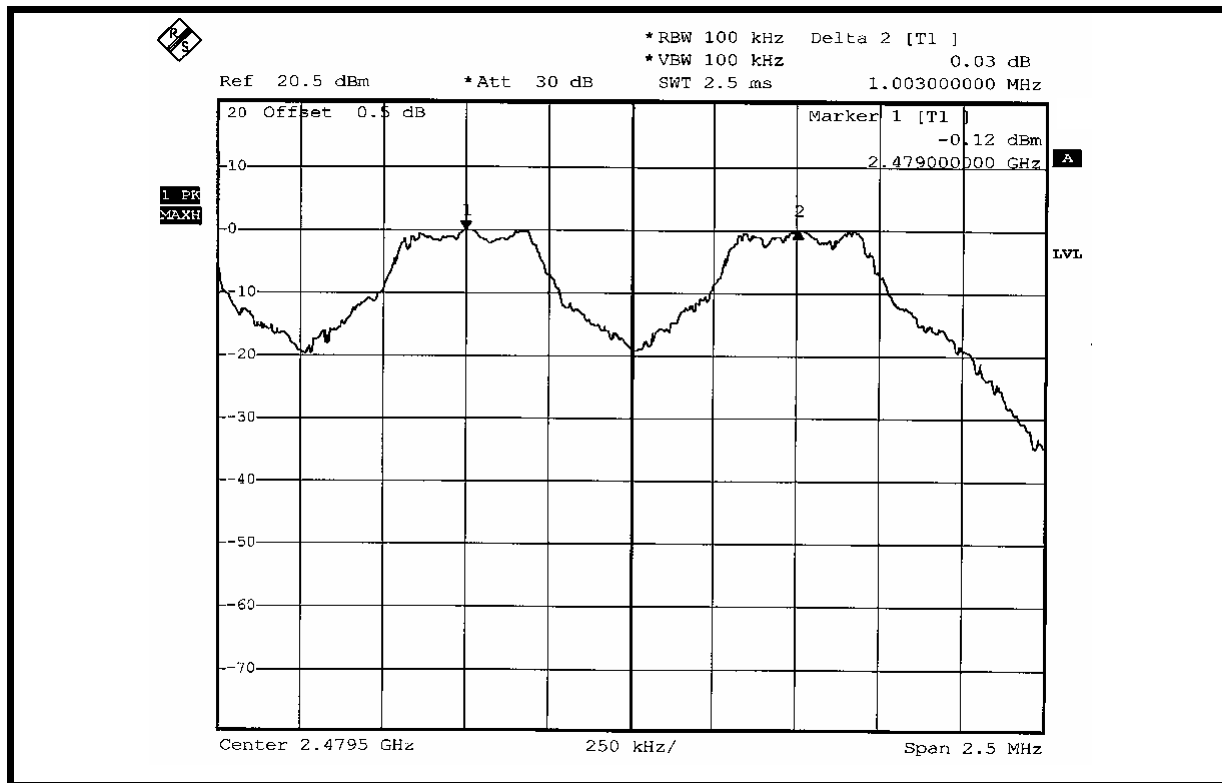



4.7 MAXIMUM PEAK OUTPUT POWER

4.7.1 LIMITS OF MAXIMUM PEAK OUTPUT POWER MEASUREMENT

The Maximum Peak Output Power Measurement is 30dBm.

4.7.2 TEST INSTRUMENTS

DESCRIPTION & MANUFACTURER	MODEL NO.	SERIAL NO.	CALIBRATED UNTIL
SPECTRUM ANALYZER	FSP40	100040	Jun. 07, 2007

NOTE: The calibration interval of the above test instruments is 12 months and the calibrations are traceable to NML/ROC and NIST/USA.

4.7.3 TEST PROCEDURES

- Check the calibration of the measuring instrument using either an internal calibrator or a known signal from an external generator.
- Turn on the EUT and connect it to measurement instrument. Then set it to any one convenient frequency within its operating range. Set a reference level on the measuring instrument equal to the highest peak value.
- The center frequency of the spectrum analyzer is set to the fundamental frequency and using 1 MHz RBW and 3 MHz VBW.
- Measure the captured power within the band and recording the plot.
- Repeat above procedures until all frequencies required were complete.

4.7.4 DEVIATION FROM TEST STANDARD

No deviation

4.7.5 TEST SETUP

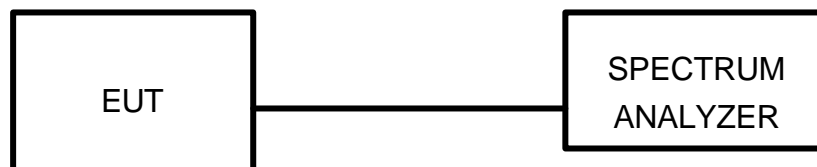

For the actual test configuration, please refer to the related Item – Photographs of the Test Configuration.

4.7.6 EUT OPERATING CONDITION

The software provided by client enabled the EUT to transmit and receive data at lowest, middle and highest channel frequencies individually.

4.7.7 TEST RESULTS

MODULATION TYPE	GFSK	ENVIRONMENTAL CONDITIONS	23deg. C, 68%RH, 991hPa
INPUT POWER (SYSTEM)	120Vac, 60 Hz	TESTED BY	Long Chen

CHANNEL	CHANNEL FREQUENCY (MHz)	PEAK POWER OUTPUT (mW)	PEAK POWER OUTPUT (dBm)	PEAK POWER LIMIT (dBm)	PASS/FAIL
0	2402	0.628	-2.02	30	PASS
39	2441	0.964	-0.16	30	PASS
78	2480	1.064	0.27	30	PASS

CH 78

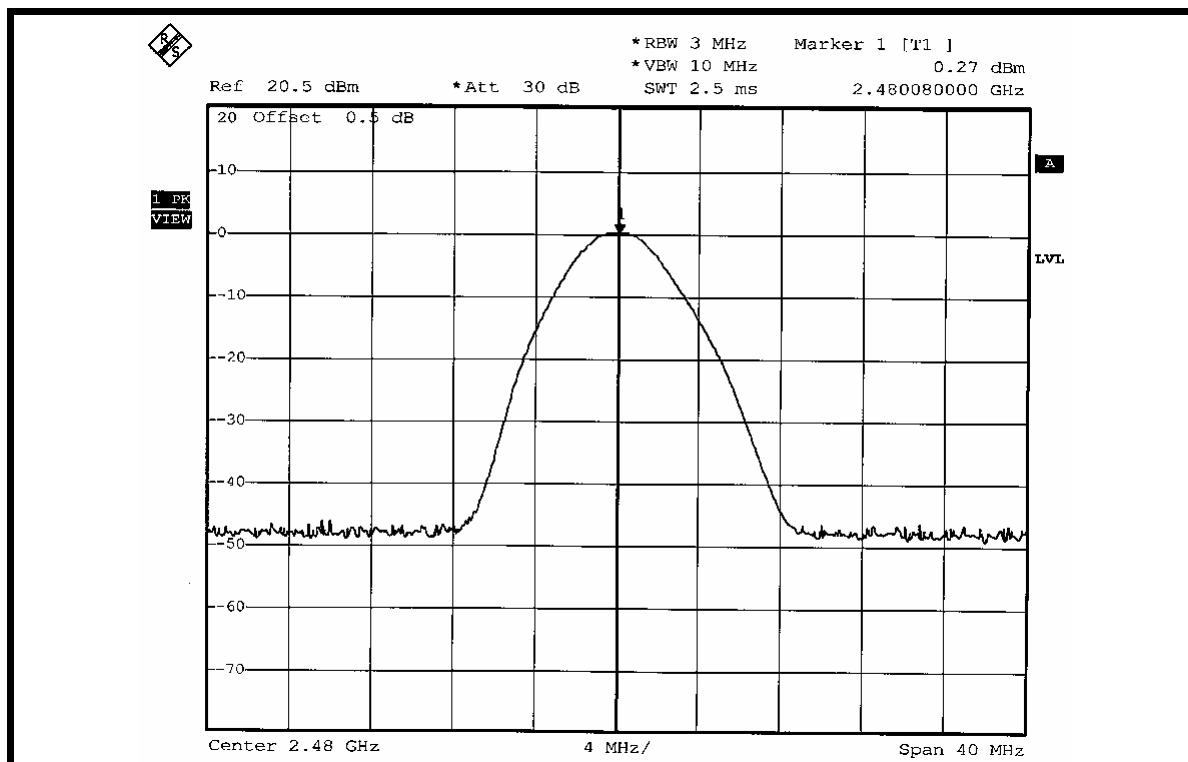



4.8 BAND EDGES MEASUREMENT

4.8.1 LIMITS OF BAND EDGES MEASUREMENT

Below -20dB of the highest emission level of operating band (in 100KHz RBW).

4.8.2 TEST INSTRUMENTS

DESCRIPTION & MANUFACTURER	MODEL NO.	SERIAL NO.	CALIBRATED UNTIL
SPECTRUM ANALYZER	FSP40	100040	Jun. 07, 2007

NOTES: The calibration interval of the above test instruments is 12 months. And the calibrations are traceable to NML/ROC and NIST/USA.

4.8.3 TEST PROCEDURE

The transmitter output was connected to the spectrum analyzer via a low loss cable. Set both RBW and VBW of spectrum analyzer to 100 kHz with suitable frequency span including 100 MHz bandwidth from band edge. The band edges was measured and recorded.

4.8.4 DEVIATION FROM TEST STANDARD

No deviation.

4.8.5 EUT OPERATING CONDITION

The software provided by client enabled the EUT to transmit and receive data at lowest, middle and highest channel frequencies individually.



4.8.6 TEST RESULTS

The spectrum plots are attached on the following 4 images. D1 line indicates the highest level, D2 line indicates the 20dB offset below D1. It shows compliance with the requirement in part 15.247(d).

NOTE 1:

The band edge emission plot on the next page shows 45.86dBc between carrier maximum power and local maximum emission in restrict band (2.35508GHz). The emission of carrier strength list in the test result of channel 0 at the item 5.2.7 is 87.82dBuV/m (Peak), so the maximum field strength in restrict band is $87.82 - 45.86 = 41.96$ dBuV/m, which is under 74 dBuV/m limit.

Average value = $41.96 - 30.00 = 11.96$ dBuV/m, which is under 54dBuV/m limit.

*The DH5 packet was the worse case duty cycle for a transmit dwell time on a channel, based upon bluetooth theory the transmitter is on $0.625 * 5$ per 296.25 ms per channel. Therefore, the duty cycle be equal to: $20\log(3.125/100) = -30$ dB.

Average value = peak reading -30

NOTE 2:

The band edge emission plot on the next second page shows 48.95dBc between carrier maximum power and local maximum emission in restrict band (2.48482GHz). The emission of carrier strength list in the test result of channel 78 at the item 5.2.7 is 92.37dBuV/m (Peak), so the maximum field strength in restrict band is $92.37 - 48.95 = 43.42$ dBuV/m, which is under 74 dBuV/m limit.

Average value = $43.42 - 30.00 = 13.42$ dBuV/m, which is under 54dBuV/m limit.

*The DH5 packet was the worse case duty cycle for a transmit dwell time on a channel, based upon bluetooth theory the transmitter is on $0.625 * 5$ per 296.25 ms per channel. Therefore, the duty cycle be equal to: $20\log(3.125/100) = -30$ dB.

Average value = peak reading -30

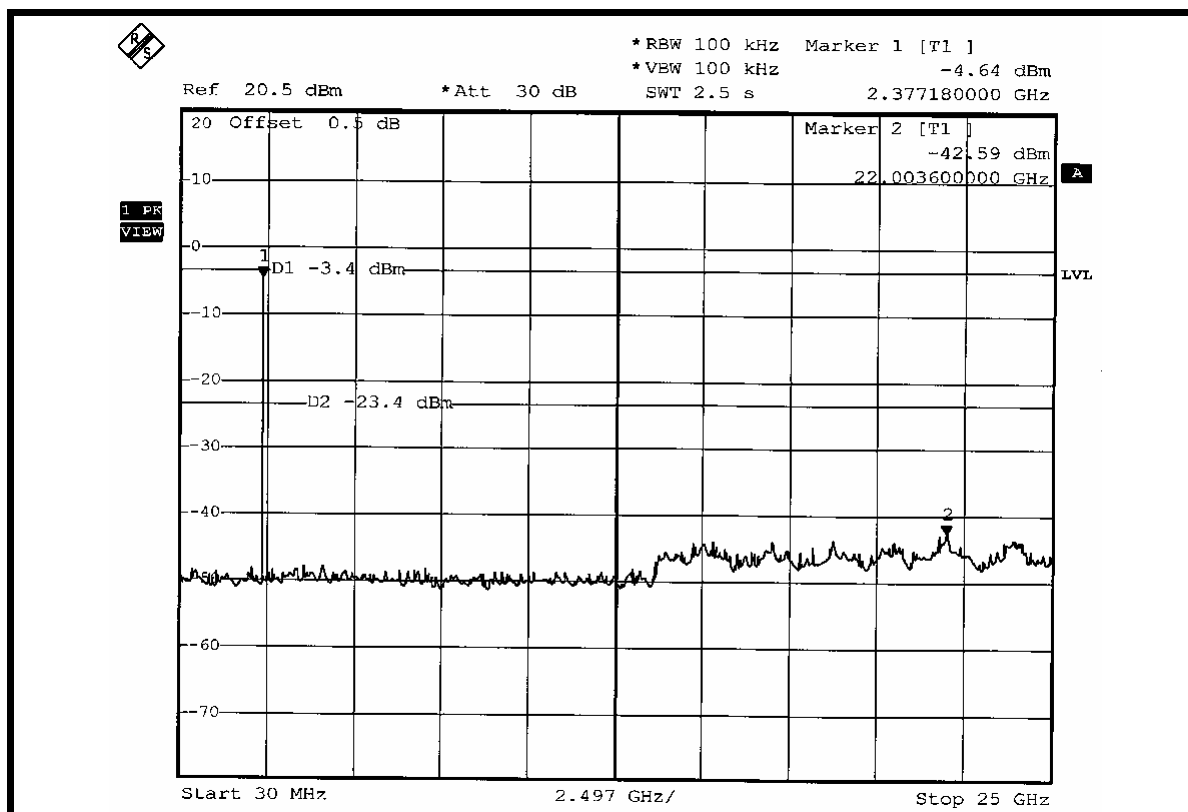
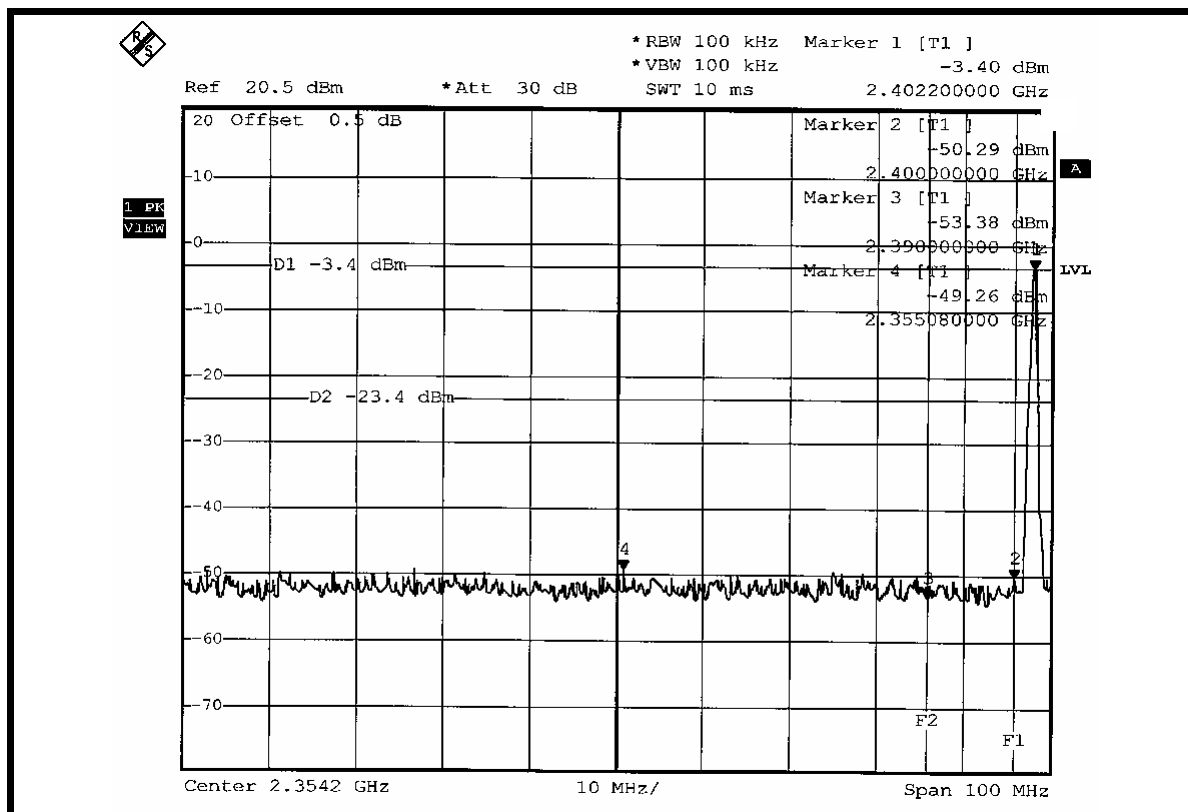



4.9 ANTENNA REQUIREMENT

4.9.1 STANDARD APPLICABLE

For intentional device, according to FCC 47 CFR Section 15.203, an intentional radiator shall be designed to ensure that no antenna other than that furnished by the responsible party shall be used with the device.

And according to FCC 47 CFR Section 15.247 (b), if transmitting antennas of directional gain greater than 6dBi are used, the power shall be reduced by the amount in dB that the directional gain of the antenna exceeds 6dBi.

4.9.2 ANTENNA CONNECTED CONSTRUCTION

The antenna used in this product is PIFA antenna without antenna connector. The maximum gain of this antenna is 0dBi.



5. INFORMATION ON THE TESTING LABORATORIES

We, ADT Corp., were founded in 1988 to provide our best service in EMC, Radio, Telecom and Safety consultation. Our laboratories are accredited and approved by the following approval agencies according to ISO/IEC 17025.

USA	FCC, UL, A2LA
GERMANY	TUV Rheinland
JAPAN	VCCI
NORWAY	NEMKO
CANADA	INDUSTRY CANADA , CSA
R.O.C.	CNLA, BSMI, NCC
NETHERLANDS	Telefication
SINGAPORE	PSB , GOST-ASIA (MOU)
RUSSIA	CERTIS (MOU)

Copies of accreditation certificates of our laboratories obtained from approval agencies can be downloaded from our web site:

www.adt.com.tw/index.5/phtml. If you have any comments, please feel free to contact us at the following:

Linko EMC/RF Lab:

Tel: 886-2-26052180
Fax: 886-2-26052943

Hsin Chu EMC/RF Lab:

Tel: 886-3-5935343
Fax: 886-3-5935342

Hwa Ya EMC/RF/Safety Telecom Lab:

Tel: 886-3-3183232
Fax: 886-3-3185050

Web Site: www.adt.com.tw

The address and road map of all our labs can be found in our web site also.



APPENDIX-A

MODIFICATIONS RECORDERS FOR ENGINEERING CHANGES TO THE EUT BY THE LAB

No any modifications are made to the EUT by the lab during the test