

Smart  
I

# User Manual

©  
R  
P

Congratulations on the purchase of your new Windows Mobile™ **Smartphone!**

**Please Read Before Proceeding.**

**THIS DEVICE IS NOT CHARGED WHEN YOU TAKE IT OUT OF THE BOX.**

**DO NOT REMOVE THE BATTERY PACK WHEN THE DEVICE IS CHARGING.**

**YOUR WARRANTY IS INVALIDATED IF YOU OPEN OR TAMPER WITH THE DEVICE'S OUTER CASING.**

#### **PRIVACY RESTRICTIONS**

Some countries require full disclosure of recorded telephone conversations, and stipulate that you must inform the person with whom you are speaking that the conversation is being recorded. Always obey the relevant laws and regulations of your country when using the recording feature of your phone.

#### **COPYRIGHT INFORMATION**

Microsoft, MS-DOS, Windows, Windows NT, Windows Server, Windows Mobile, ActiveSync, Excel, Internet Explorer, MSN, Outlook, PowerPoint and Word are either registered trademarks or trademarks of Microsoft Corporation in the United States and/or other countries.

## Important Health Information and Safety Precautions

When using this product, the safety precautions below must be taken to avoid possible legal liabilities and damages.

Retain and follow all product safety and operating instructions. Observe all warnings in the operating instructions on the product.

To reduce the risk of bodily injury, electric shock, fire and damage to the equipment, observe the following precautions.

### ELECTRICAL SAFETY

This product is intended for use when supplied with power from the designated battery or power supply unit. Other usage may be dangerous and will invalidate any approval given to this product.

### SAFETY PRECAUTIONS FOR PROPER GROUNDING INSTALLATION

**CAUTION** – Improper connection of associated equipment-grounding can result in a risk of electric shock.

This product is equipped with an ActiveSync Cable for connecting with a desktop or notebook computer. Be sure your computer is properly grounded (earthed) before connecting this product to the computer. The desktop or notebook computer is equipped with a power supply cord having an equipment grounding conductor and a grounding plug. The plug must be plugged into an appropriate outlet which is properly installed and grounded in accordance with all local codes and ordinances.

### SAFETY PRECAUTIONS FOR POWER SUPPLY UNIT

- **Use the correct external power source**

A product should be operated only from the type of power source indicated on the electrical ratings label. If you are not sure of the type of power source required, consult your authorized service provider or local power company. For a product that operates from battery power or other sources, refer to the operating instructions that are included with the product.

- **Handle battery packs carefully**

This product contains a Li-ion battery. There is a risk of fire and burns if the battery pack is handled improperly. Do not attempt to open or service the battery pack. Do not disassemble, crush, puncture, short external contacts or circuits, dispose of in fire or water or expose a battery pack to temperatures higher than 60°C (140°F).

**WARNING!**

DANGER OF EXPLOSION IF BATTERY IS INCORRECTLY REPLACED. TO REDUCE RISK OF FIRE OR BURNS, DO NOT DISASSEMBLE, CRUSH, PUNCTURE, SHORT EXTERNAL CONTACTS, EXPOSE TO TEMPERATURE ABOVE 60°C (140°F), OR DISPOSE OF IN FIRE OR WATER. REPLACE ONLY WITH SPECIFIED BATTERIES. RECYCLE OR DISPOSE OF USED BATTERIES ACCORDING TO THE LOCAL REGULATIONS OR REFERENCE GUIDE SUPPLIED WITH YOUR PRODUCT.

**SAFETY PRECAUTIONS FOR DIRECT SUNLIGHT**

Keep this product away from excessive moisture and extreme temperatures. Do not leave the product or its battery inside a vehicle or in places where the temperature may exceed 60°C (140°F), such as on a car dashboard, window sill, or behind a glass that is exposed to direct sunlight or strong ultraviolet light for extended periods of time. This may damage the product, overheat the battery or pose a risk to the vehicle.

**SAFETY PRECAUTIONS FOR ACOUSTIC PRESSURE**

CAUTION – Permanent hearing loss may occur if earphones or headphones are used for prolonged listening at high volume.

**NOTE:**

For France, mobile headphones or earphones for this device (Manufactured by Supplier Name:COTRON, Model Numbers:CHM-201STV03030) have been tested to comply with the Sound Pressure Level requirement laid down in NF EN 50332-1:2000 standard as required by French Article L. 5232-1.

**SAFETY IN AIRCRAFT**

Due to the possible interference caused by this product to an aircraft's navigation system and its communications network, using this device's phone function on board an airplane is against the law in most countries. If you want to use this device when on board an aircraft, remember to turn off your phone by switching to Flight Mode.

## **ENVIRONMENTAL RESTRICTIONS**

Do not use this product in gas stations, fuel depots, chemical plants or where blasting operations are in progress, or in potentially explosive atmospheres such as fuelling areas, fuel storehouses, below deck on boats, chemical plants, fuel or chemical transfer or storage facilities, and areas where the air contains chemicals or particles, such as grain, dust, or metal powders. Please be aware that sparks in such areas could cause an explosion or fire resulting in bodily injury or even death.

## **EXPLOSIVE ATMOSPHERES**

When in any area with a potentially explosive atmosphere or where flammable materials exist, the product should be turned off and the user should obey all signs and instructions. Sparks in such areas could cause an explosion or fire resulting in bodily injury or even death. Users are advised not to use the equipment at refueling points such as service or gas stations, and are reminded of the need to observe restrictions on the use of radio equipment in fuel depots, chemical plants or where blasting operations are in progress. Areas with a potentially explosive atmosphere are often, but not always, clearly marked. These include fueling areas, below deck on boats, fuel or chemical transfer or storage facilities, and areas where the air contains chemicals or particles, such as grain, dust or metal powders.

## **ROAD SAFETY**

Vehicle drivers in motion are not permitted to use telephony services with handheld devices, except in the case of emergency. In some countries, using hands-free devices as an alternative is allowed.

## **INTERFERENCE WITH MEDICAL EQUIPMENT FUNCTIONS**

This product may cause medical equipment to malfunction. The use of this device is forbidden in most hospitals and medical clinics.

## **NONIONIZING RADIATION**

This product should be operated in the suggested normal condition only to ensure the radiative performance and safety from interference. As with other mobile radio transmitting equipment, users are advised that for satisfactory operation of the equipment and for the safety of personnel, it is recommended that no part of the human body be allowed to come too close to the antenna during operation of the equipment.

## General Precautions

- **Heed service markings**

Except as explained elsewhere in the Operating or Service documentation, do not service any product yourself. Service needed on components inside the casing should be done by an authorized service technician or provider.

- **Damage requiring service**

Unplug the product from the electrical outlet and refer servicing to an authorized service technician or provider under the following conditions:

- Liquid has been spilled or an object has fallen into the product.
- The product has been exposed to rain or water.
- The product has been dropped or damaged.
- There are noticeable signs of overheating.
- The product does not operate normally when you follow the operating instructions.

- **Avoid hot areas**

The product should be placed away from heat sources such as radiators, heat registers, stoves or other products (including amplifiers) that produce heat.

- **Avoid wet areas**

Never use the product in a wet location.

- **Avoid pushing objects into product**

Never push objects of any kind into cabinet slots or other openings in the product. Slots and openings are provided for ventilation. These openings must not be blocked or covered.

- **Mounting Accessories**

Do not use the product on an unstable table, cart, stand, tripod or bracket. Any mounting of the product should follow the manufacturer's instructions, and should use a mounting accessory recommended by the manufacturer.

- **Avoid unstable mounting**

Do not place the product on an unstable base.

- **Use product with approved equipment**

This product should be used only with personal computers and options identified as suitable for use with your equipment.

- **Adjust the volume**

Turn down the volume before using headphones or other audio devices.

- **Cleaning**

Unplug the product from the wall outlet before cleaning. Do not use liquid cleaners or aerosol cleaners. Use a damp cloth for cleaning, but NEVER use water to clean the LCD screen.

# Contents

<b>Chapter 1 Getting Started</b>	<b>11</b>
1.1 Getting to Know your Phone and its Accessories ..	12
1.2 Inserting the SIM Card .....	18
1.3 Installing the Micro SD Card .....	19
1.4 The Home Screen .....	20
1.5 Status Indicators and Program Icons.....	21
1.6 Using the Start Menu.....	24
1.7 Using the Quick List.....	24
1.8 Entering Information .....	25
1.9 Battery Information .....	28
<b>Chapter 2 Using Phone Features</b>	<b>29</b>
2.1 Using the Phone .....	30
2.2 Making a Call .....	31
2.3 Receiving a Call.....	34
2.4 In-call Options .....	34
2.5 Additional Dialing Information .....	36
<b>Chapter 3 Synchronizing Information and             Setting Up E-mail Security</b>	<b>39</b>
3.1 About ActiveSync.....	40



3.2	Setting Up ActiveSync .....	40
3.3	Synchronizing Information .....	43
3.4	Synchronizing via Bluetooth .....	47
3.5	Synchronizing Music and Video .....	48
3.6	Setting Up Email Security .....	49

## **Chapter 4 Managing your Phone** **51**

4.1	Personalizing your Phone .....	52
4.2	Adding and Removing Programs .....	58
4.3	Using Task Manager and Managing Memory .....	60
4.4	Managing and Backing Up Files .....	61
4.5	Protecting your Phone .....	64
4.6	Restarting your Phone .....	66
4.7	Resetting your Phone .....	66

## **Chapter 5 Getting Connected** **67**

5.1	Connecting to the Internet .....	68
5.2	Using Internet Explorer Mobile .....	72
5.3	Using Wireless Modem .....	74
5.4	Using Comm Manager .....	78
5.5	Using Bluetooth .....	79

## **Chapter 6 Exchanging Messages and Using Outlook** **89**

6.1	Using Email and Text Messages .....	90
-----	-------------------------------------	----

6.2	Using MMS Messages .....	98
6.3	Using Pocket MSN Messenger .....	105
6.4	Using Calendar .....	107
6.5	Using Contacts .....	108
6.6	Using Tasks.....	113
6.7	Using Voice Notes .....	114
<b>Chapter 7 Experiencing Multimedia</b>		<b>115</b>
7.1	Using Camera and Video Recorder .....	116
7.2	Using Pictures & Videos .....	125
7.3	Using Windows Media Player.....	130
7.4	Using MIDlet Manager.....	138
<b>Chapter 8 Using Other Applications</b>		<b>143</b>
8.1	Using ClearVue Suite .....	144
8.2	Using Speed Dial .....	148
<b>Appendix</b>		<b>151</b>
A.1	Regulatory Notices.....	152
A.2	PC Requirement to Run ActiveSync 4.x.....	158
A.3	Specifications .....	159
<b>Index</b>		<b>163</b>

# Chapter 1

## Getting Started

- 1.1 Getting to Know your Phone  
and its Accessories**
- 1.2 Inserting the SIM Card**
- 1.3 Installing the Micro SD Card**
- 1.4 The Home Screen**
- 1.5 Status Indicators and Program Icons**
- 1.6 Using the Start Menu**
- 1.7 Using the Quick List**
- 1.8 Entering Information**
- 1.9 Battery Information**

## 1.1 Getting to Know your Phone and its Accessories

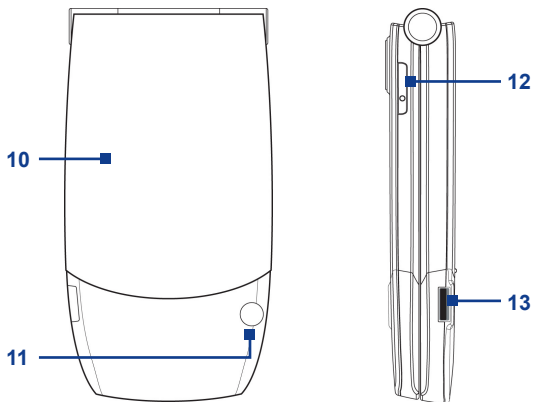
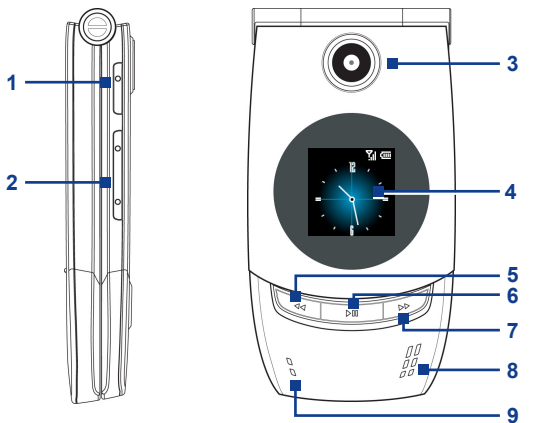



Item	Function
1. <b>Comm Manager</b>	Press to open Comm Manager. Please note the button does not work when the flip cover is closed.
2. <b>VOLUME/ Voice Notes/ Voice Tag</b>	Press to increase or decrease the earpiece volume during a call. When the flip cover is opened, press and hold the Volume Up button to start the <b>Voice Notes</b> recorder or press and hold the Volume Down button to launch the <b>Voice Tag</b> feature.
3. <b>Camera Lens</b>	1.3 Megapixel CMOS lens on the flip cover. It supports the self-capturing feature from the external screen when the flip cover is closed.
4. <b>External Screen</b>	When your phone is powered on and the flip cover is closed, the external screen shows the device status. To customize the display of the external screen, see the “Set up the external screen” section in Chapter 4.
5. <b>Rewind</b>	When Media Player is running, press this hotkey to go back to the beginning of the current file; quickly press twice to jump to the previous file. If Media Player is launched in the foreground but no file is loaded, nothing happens when you press this hotkey.
6. <b>Play/Pause</b>	When the flip cover is closed, press this hotkey to launch Windows Media Player directly.
7. <b>Forward</b>	When Media Player is running, press this hotkey to jump to the next file. If Media Player is launched in foreground but no file is loaded, nothing happens when you press this hotkey.
8. <b>Speaker</b>	Listen to audio media.
9. <b>LED Indicators</b>	The upper bi-color LED Indicator (amber/red/green) notifies you of the battery and network status of your phone respectively, while the lower blue LED indicator notifies you of Bluetooth connectivity status. For more information about LED Indicators, see the table at the end of this section.
10. <b>Battery Cover</b>	
11. <b>External Antenna Connector</b>	Connect your phone to an external antenna (if available) to utilize the superior reception quality.
12. <b>CAMERA</b>	Press to launch the camera. If already running, press to capture an image or start recording a video clip.
13. <b>Earphone/ Sync/Power Connector</b>	Connect the USB cable to synchronize data or recharge the battery; plug in the provided Stereo headset to use the hands-free kit or listen to audio media; alternatively, plug in the AC adapter to recharge the battery.

---

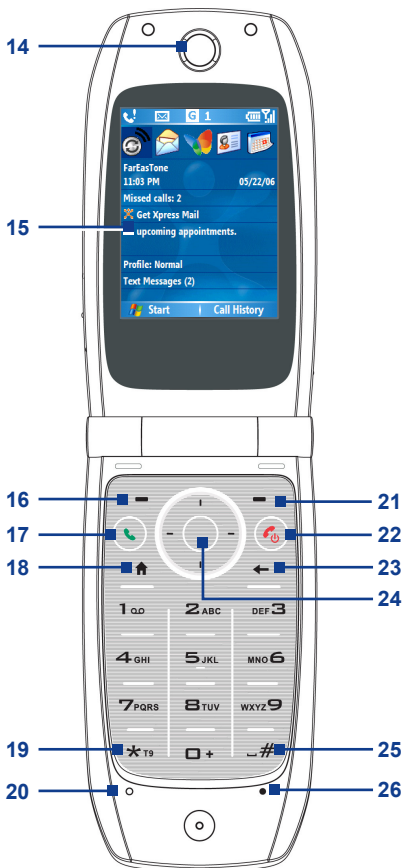
## 14 Getting started



Item	Function
14. Earpiece	Listen to a phone call.
15. Display Screen	
16. Left SOFT KEY	Press to perform the command shown in the label above the button.
17. TALK	Press to dial a phone number, answer a call, switch to another call or put a call on hold. Hold to activate/deactivate loudspeaker mode.
18. HOME	Press to go to the Home Screen. Press and hold to open the Quick List.
19.  T9 Key	Press and switch to different input modes or press and hold to choose an input mode or symbols from the list.
20. Light Sensor	Dark conditions sensed here will activate a backlight under the keypad, making it easier to see the buttons.
21. Right SOFT KEY	Press to perform the command shown in the label above the button.
22. POWER/END	Press and hold to turn on/off the phone or, during a call, press to end the call.
23. BACK	Press to go to the previous screen or backspace over characters.
24. Navigation Control/ENTER	Use to scroll left, right, up or down or press in to use as the ENTER button.
25.  # Key	Press to add a space or press and hold to display a list of symbols.
26. Microphone	Speak into the microphone when receiving or making a phone call or voice recording.

---

## LED indicator lights

Various colors that might display in the two LED Indicators are summarized here.

Upper LED	Status
<b>Solid green</b>	Battery is fully charged.
<b>Blank</b>	Battery case is empty.
<b>Solid amber</b>	Battery is charging or the phone is using ActiveSync to synchronize with a PC.
<b>Flashing green</b>	Connected to the network.
<b>Flashing red</b>	Battery very low (less than 4%).
<b>Flashing amber</b>	Battery temperature is hotter or colder than the functional limits of 0 to 48 degrees Celsius and has stopped charging.
<b>Amber/Green LED off</b>	Battery fault. The "Battery Fault" indicator (  ) is displayed. In this case, the flashing green LED can be recovered by unplugging the AC adapter.
<b>Dim</b>	Disconnected from the network.
Lower LED	Status
<b>Flashing blue</b>	Bluetooth mode set to "On" or "Discoverable" mode.



## Accessories

The following accessories are provided with the device:

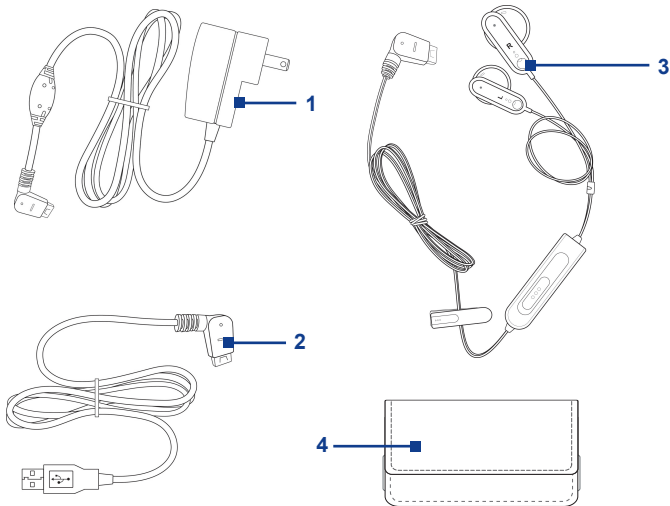

Accessory	Function
<b>1. AC adapter</b>	Recharge the device battery.
<b>2. USB cable</b>	Connect your device to a PC and synchronize data.
<b>3. Stereo headset</b>	Provide a volume control jog dial and a Send/End button. You can use the button to pick up and hang up incoming and outgoing calls. Plug into Earphone/Sync connector to listen to audio files.
<b>4. Pouch</b>	Act as a protective carrying case for your phone.

## 1.2 Inserting the SIM Card

Your SIM (Subscriber Identity Module) card is given to you by your wireless service provider and contains your basic subscriber information, such as your phone number and your address book.

Before you begin, ensure that the phone is turned off.

- 1. Open the battery cover:** Hold the phone in one hand with the front panel facing down in the palm of your hand. With your other hand press down on the battery cover and slide it open.
- 2. Insert the SIM card:** Insert the SIM card into the SIM card slot with its gold contacts facing down. When completed, replace the battery cover.

To take the SIM card out, press the bottom of the SIM card to slide it out of the slot. Then lightly lift up the SIM card.

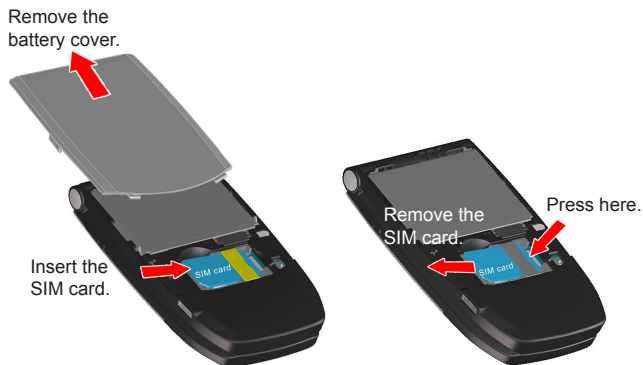

## 1.3 Installing the Micro SD Card

1. Open the battery cover.
2. Remove the SIM card if you have installed it.
3. Lift up the Micro SD card metal socket, and then insert the Micro SD card into the slot.

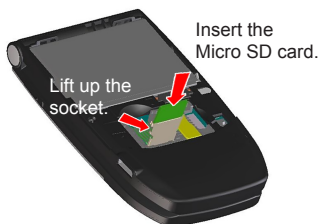

4. Push the metal socket down.
5. Replace the SIM card, battery and battery cover.

## 1.4 The Home Screen

The Home screen displays important information, such as upcoming appointments, status indicators, the current date, time, profile and icons of programs that you have recently used. You can open a program directly by selecting its icon and pressing ENTER.

- To access the Home screen from anywhere, press HOME.
- To customize the Home screen display, including the background, click **Start > Settings > Home Screen**.

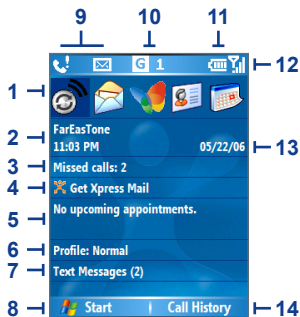



































Home Screen

1. Select a recently-used program, and open it directly from the Home screen.
2. Displays the name of your wireless service provider.
3. Click to view the details of a missed call.
4. Xpress Mail allows you to access data while on the go via your smartphone.
5. Click to see the time of your next appointment.
6. Displays the current profile. Click to change the profile.
7. Click to open the Messages folder.
8. Click to display all program icons.
9. Displays notifications, such as missed calls or new messages.
10. Displays the GPRS or GSM network status.
11. Displays the power status.
12. Displays the network signal strength.
13. Displays the current date and time.
14. Click to open Contacts, Call History or Messages.















## 1.5 Status Indicators and Program Icons

















The following table lists common status indicators and their meanings.

 GPRS available	 New email or text message (SMS, Short Message Service)
 GPRS connected	 New instant message
 Voice call in progress	 Multipress text input mode, lowercase
 Data call in progress	 Multipress text input mode, uppercase
 Calls forwarded	 Multipress text input mode, caps lock
 Call on hold	 T9 text input mode, lowercase
 Missed call	 T9 text input mode, uppercase
 Dialing while no SIM card installed	 T9 text input mode, caps lock
 Speakerphone on	 Numeric input mode
 Battery level	 Ringer off
 Low battery	 Vibrate call alert
 Very low battery	 Microphone muted
 Battery charging	 Bluetooth
 No battery or battery fault	 No SIM card installed
 Signal strength	 SIM card with fault
 Radio connected or no signal	 Roaming
 Radio off	 1 / 2 Line 1/2
 Sync error	

## 22 Getting started

The following table lists icons of the programs that are already installed on your phone.

	<b>ActiveSync</b>	Synchronizes information between your phone and a PC.
	<b>Calculator</b>	Performs basic arithmetic and calculations, such as addition, subtraction, multiplication and division.
	<b>Calendar</b>	Keeps track of your appointments and creates meeting requests.
	<b>Call History</b>	Keeps track of all phone calls made, received and missed.
	<b>Camera</b>	Captures photos in various modes.
	<b>Clear Storage</b>	Clears the memory, restores the phone back to factory default settings, then restarts the phone.
	<b>ClearVue Document</b>	Lets you view Word documents on your phone.
	<b>ClearVue PDF</b>	Lets you view PDF files on your phone.
	<b>ClearVue PPT</b>	Lets you view PowerPoint files on your phone.
	<b>ClearVue Worksheet</b>	Lets you view Excel worksheets on your phone.
	<b>Comm Manager</b>	Lets you easily enable or disable your phone, start or stop synchronization with your computer, mute your phone, enable or disable Bluetooth, stop data services and enable or disable Direct Push.
	<b>Contacts</b>	Keeps track of contact information.
	<b>Download Agent</b>	Provides information about the download status and the downloaded content from the Internet.
	<b>File Explorer</b>	Lets you organize and manage files on your phone.
	<b>Games</b>	Lets you play one of two games: Bubble Breaker and Solitaire come with your phone.

	<b>GetGood</b>	Open the browser to access the GoodLink, which provides you with the real-time wireless push synchronization of email, attachments and PIM data.
	<b>Internet Explorer</b>	Allows you to browse Web and WAP sites and to download new programs and files from the Internet.
	<b>Messaging</b>	Lets you send and receive emails and text messages.
	<b>MIDlet Manager</b>	Lets you download and install Java-based applications, such as games and tools, on your phone.
	<b>Pictures &amp; Videos</b>	Collects, organizes and sorts picture and video files in the My Pictures folder on your phone or on a storage card.
	<b>Pocket MSN</b>	Lets you send and receive instant messages with your MSN Messenger contacts.
	<b>Settings</b>	Personalize your phone to suit the way you use it.
	<b>Speed Dial</b>	Lets you create speed dial entries for dialling frequently-called phone numbers or for opening frequently-accessed programs.
	<b>SIM Manager</b>	Lets you manage the contacts that are stored on your SIM card. You can also use this program to copy SIM contents to Contacts on your phone.
	<b>STK (SIM Tool Kit) Service</b>	Allows you to access information and other services offered by your wireless service provider.
	<b>Task Manager</b>	Keeps track of your running programs.
	<b>Tasks</b>	Keeps track of your tasks.
	<b>Video Recorder</b>	Captures video clips in various modes and duration.
	<b>Voice Notes</b>	Allows you to make short voice recordings.
	<b>Windows Media</b>	Lets you play back video and audio files.
	<b>Wireless Modem</b>	Enables your device to be used as an external modem for a PC by using a Bluetooth port or USB port.

---

## 1.6 Using the Start Menu

The Start menu is located at the bottom-left corner of the Home screen and displays various program icons that are spread across one or more screens.

### To see the available programs in the Start menu

- On the Home screen, click **Start**.
- To see more programs, click **More**.

Your phone comes with several bundled programs that you can start using immediately. You can also install additional programs from the included Windows Mobile™ Getting Started Disc or from the Internet, or purchase mobile phone software from retail stores and install them to your phone.

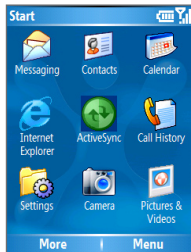

## 1.7 Using the Quick List

The Quick List offers convenient access to a list of functions, such as locking your phone or keypad and choosing a different profile. For more information about profiles, see Chapter 4.

### To access the Quick List

1. Press and hold the HOME button.
2. Scroll through the list and select the desired item by clicking **Select**, pressing the ENTER button or pressing the related numeric key on the keypad.
3. To exit the Quick List at any time, click **Cancel**.

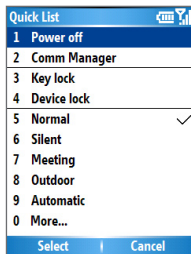



## 1.8 Entering Information

You can enter text and numbers by using the keypad. The phone supports three input modes for entering text and numbers: **Multipress**, **T9** and **Numeric**. Multipress and T9 modes are used for entering text; Numeric mode is used for entering numbers.

When you select a field that requires entering text or numbers, the phone automatically selects the appropriate input mode. The status indicator on the top-right side of the display screen shows the input mode that you are currently using.

<b>abc</b>	Multipress text input mode, lowercase
<b>Abc</b>	Multipress text input mode, uppercase
<b>ABC</b>	Multipress text input mode, caps lock
<b>t9</b>	T9 text input mode, lowercase
<b>T9</b>	T9 text input mode, uppercase
<b>T9</b>	T9 text input mode, caps lock
<b>123</b>	Numeric input mode

### To change the input mode

1. Press and hold the **\*T9** key.
2. On the menu, click the input mode you want.

### Use Multipress mode

In Multipress mode, you can enter a character by pressing the numeric key on which the character appears.

#### To enter text in Multipress mode

- To enter the first character on the numeric key, press once. To enter the second character on the numeric key, press twice, and so on.
- To enter a character that is on the same numeric key, pause after you enter the first character.
- To enter punctuation, press **1** repeatedly until you see the punctuation you want.

### To change the Multipress time out



You can change the length of time to pause between key presses on the same numeric key.

1. On the Home screen, click **Start > Settings > Accessibility**.
2. In **Multipress time out**, select the length of the pause between key presses.

### Use T9 mode

To form a word in T9 mode, press the numeric keys that contain the letters you want. As you enter letters, T9 analyzes your key presses and attempts to complete the word. For example, to enter the word “shoe”, press 7, 4, 6, 3.



### To enter text in T9 mode

1. Press and hold the  key.
2. On the menu, click **T9**.
3. Do any of the following:
  - Enter letters by pressing the keys on which the letters appear. Press a key only once for each letter. If there is more than one choice in the T9 dictionary for your entry, a list of available words is displayed.
  - Press the  key to enter a space after the word as entered or click one of the available words, and then the space is added automatically.
  - If you do not see the desired word, click **Add Word?** from the list, and then enter the word using Multipress.
  - To enter punctuation, press **1** and select from a list of common punctuation marks.

### Use Numeric mode

If a text box permits a numeric entry only, such as a phone number, the input mode automatically defaults to Numeric mode. However, if you need to enter numbers within a line of text, change to Numeric mode, and then change back to Multipress or T9 mode to finish entering the text.

### To enter numbers in text boxes

1. Press and hold the  key to change to Numeric mode.
2. On the keypad, enter the number or numbers you want.
3. Change back to Multipress or T9 input mode by pressing and holding the  key, and then finish entering your text.

### More text entry tasks

In both Multipress and T9 modes, the first letter of a sentence is by default capitalized.

### To change between uppercase, lowercase and caps lock

- Press the  key to change between uppercase, lowercase and caps lock within a text input mode.

### To delete characters

- To backspace and delete a single character in any input mode, press BACK.
- To backspace and delete an entire text or numeric field in any input mode, press and hold BACK.

### To enter a space

- In Multipress or T9 mode, press the  key.

### To enter a symbol

1. Press and hold the  key.
2. On the menu, click **Symbols** to display the Symbol page.
3. Select the symbol you want and press ENTER.

### To start a new line

In a multi-line text box such as the notes area of a contact or a calendar appointment, do the following:

- In any input mode, press ENTER.

### To enter the plus sign for international calls

- In a numeric entry box, press and hold 0.

## 1.9 Battery Information

Battery performance depends on many factors, including your wireless service provider's network configuration, signal strength, the temperature of the environment in which you operate your phone, the features and/or settings you select and use, items attached to your phone's connecting ports, your voice, data and other program usage patterns.

Battery life estimates (approximations):

- Talk time: 3.6 – 7 hours
- Standby time: 146 – 220 hours

**WARNING!** To reduce risk of fire or burns:

- Do not attempt to open, disassemble or service the battery pack.
- Do not crush, puncture, short external contacts or dispose of in fire or water.
- Do not expose to temperatures above 60°C (140°F).
- Replace only with the battery pack designated for this product.
- Recycle or dispose of used batteries as stipulated by local regulation.

### The Power Management screen

- On the Home screen, click **Start > Settings > Power Management** to access the Power Management screen. You can check the battery power from the Main battery bar.
- On the Power Management screen, you can optimize the power performance by adjusting the backlight, display and light sensor settings.

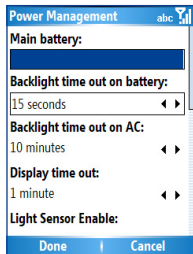

### To manage a low battery

When the low-battery warning appears, do the following:

1. Immediately save your current data.
2. Synchronize with your PC to charge the battery.
3. Turn off your phone.

For information about charging the battery, see the **Quick Start Guide**.

# Chapter 2

## Using Phone Features

**2.1 Using the Phone**

**2.2 Making a Call**

**2.3 Receiving a Call**

**2.4 In-call Options**

**2.5 Additional Dialing Information**



## 2.1 Using the Phone

You can use your phone to make, receive, keep track of calls and send text messages (SMS, Short Message Service) and MMS (Multimedia Messaging Service) messages. You can also dial a phone number directly from Contacts and easily copy SIM contacts to Contacts on the phone.

### The Phone screen

From the Phone screen, you can open, call, find a contact and even save a new number in Contacts. To access the Phone screen, do any of the following:

- Press TALK (.
- Directly enter the phone number by pressing numeric keys on the keypad.

### Enter your PIN

Most Subscriber Identity Module (SIM) cards are preset with a personal identification number (PIN) that is provided by your wireless service provider.

1. On the Home screen, click **Start > Settings > Security > Enable SIM PIN**.
2. Enter the preset PIN provided by your wireless service provider.
3. Click **Done**.

**Note** If your PIN is entered incorrectly three times, the SIM card will be blocked. If this happens, you can unblock it with the PIN Unlocking Key (PUK) obtained from your wireless service provider.

### Set ring tones

You can choose how to be notified of incoming calls, reminders, new messages, alarms, and more.

### To set a ring tone for incoming calls

1. On the Home screen, click **Start > Settings > Sounds**.
2. In the Ring tone list, select a ring tone.
3. Click **Done**.

If you select **Vibrate**, the sound is muted and the phone will vibrate when you receive a call. The vibrate icon (🔇) appears in the title bar. Selecting **None** in the Ring tone list mutes the phone. For more information about sounds, see “Choose how to be notified about events or actions” in Chapter 4.

**Note** To adjust the earpiece volume during a call, press the VOLUME control on the phone side panel. Adjusting the volume at any other time can affect the ring, notification and MP3 sound levels.

## 2.2 Making a Call

With your phone, you can make calls from the Home screen, the Phone screen, from Contacts, Speed Dial, Call History or SIM Contacts (contacts stored on your SIM card).

### Make a call from the Phone screen

1. On the Home screen, access the Phone screen by pressing TALK (📞) or pressing numeric keys on the keypad.
2. When you enter the phone number completely, press TALK (📞).

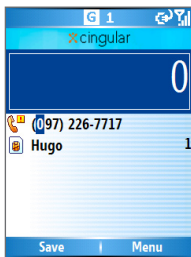

Phone Screen

### Tips

- While entering the phone number, press the **BACK** button if you need to backspace.
- You will notice that when you press a numeric key on the keypad, a list of names and numbers is displayed as your phone searches **Contacts**, **Call History**, **Speed Dial** and your **SIM card** to find a matching name or number. For example, when you press a number such as 5, names that begin with J, K and L will be displayed as well as phone numbers that start with 5. The next number you press continues to narrow the search. When you see the name of the person you want to call, select it and press **TALK** (📞).

### Make a call from Contacts

1. On the Home screen, click **Start > Contacts**.
2. Do one of the following:
  - Select the desired contact and press **TALK** (📞).
  - Select the desired contact in the contact list and press the **ENTER** button twice (once to view the contact details and once to dial the associated number).

### To specify the number to dial

By default, the mobile phone number (m) of a contact is dialed when you make a call from **Contacts**; however, you can choose to dial a different phone number.

1. On the Home screen, click **Start > Contacts**.
2. Select the contact.
3. Press **NAVIGATION** left or right. The letter representing the number changes to m (mobile), w (work) or h (home).

**Tip** You may also access the contact list by clicking **Contacts** on the Home screen (simply by pressing the right **SOFT KEY**).

### To edit the contact

When you select a contact in the contact list and press **ENTER** to view details and different numbers associated with the contact, you can:

- Edit information associated with the contact by clicking **Menu > Edit**.
- Save the selected contact on your SIM card by clicking **Menu > Save to SIM**.



## Make a call from Call History

1. On the Home screen, click **Start > Call History**.
2. Select a name or number and press TALK (📞).

**Tip** On the Call History screen, press ENTER to view details, such as the call type (dialed, missed or received call), call duration, date and time. Pressing ENTER again dials the associated number.

## To customize calls by using the Menu

You can select various options in the **Menu** of Call History to customize and filter the calls made, received or missed:

- **Find Contact:** Find the selected name or number in Contacts.
- **Send Text Message:** Send a text message to the selected name or number.
- **E-mail:** Send an email to the selected name or number.
- **View Timers:** Find the duration of the selected call.
- **Delete:** Remove the selected call or number from Call History.
- **Delete List:** Remove all the calls and numbers from Call History.
- **Save to Contacts:** Save the selected name or number in Contacts.
- **Filter:** Categorize the call or number into various call types.

**Note** You can also save a number in Contacts by clicking **Save** on the Call History screen.

## Make a call from Speed Dial

You can make calls using Speed Dial. To learn how to use Speed Dial, see “Using Speed Dial” in Chapter 8.

## Make a call from SIM Manager

1. Click **Start > Accessories > SIM Manager**. Wait for the contents of your SIM card to load.
2. Choose the contact you want to call and click **Menu > Dial**.

## 2.3 Receiving a Call

When you receive a phone call, you have the option to answer it or ignore it.

### To answer an incoming call

- To answer the call, click **Answer**, or press TALK (📞) or any numeric key.
- Open the flip cover.

**Tip** The way to answer an incoming call depends on the setting in Answer Mode. For details, see "Set up the Answer Mode" in Chapter 4.

### To ignore an incoming call

- To ignore the call, click **Ignore** or press END (📞).

### To end a call

- Press END (📞).
- Close the flip cover.

## 2.4 In-call Options

Your phone provides various options for managing multiple calls at the same time. You are notified when you have another incoming call, and you have the choice of ignoring or accepting the call. If you are already on a call and accept the new call, you can choose to switch between the two callers or set up a conference call between all three parties.

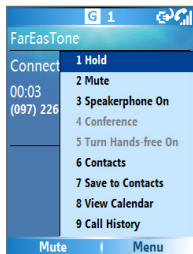

### To answer another call

1. Click **Answer** to take the second call and put the first call on hold.
2. To end the second call and return to the first call, press END (📞).

### To switch between calls

- To switch between two calls, click **Swap**.

### To set up a conference call

1. Either put a call on hold and dial a second number or answer a second incoming call during a call.
2. Click **Menu > Conference**.

#### Notes

- If the conference connection is successful, the word “Conference” appears at the top of the screen.
- To add extra persons to your conference call, click **Menu > Hold**, enter the phone number, and then click **Resume** to return to the call.
- Not all service providers support conference call. Contact your service provider for details.

### To turn the Speakerphone on and off

The built-in Speakerphone allows you to talk handsfree or lets other people listen to the conversation.

- During a call, click **Menu > Speakerphone On**. The speakerphone icon () appears at the top of the screen.
- To turn off the Speakerphone during the call, click **Menu > Speakerphone Off**.

**Tip** The speakerphone can be toggled on and off by simply pressing and holding TALK () during the call

**Warning!** To avoid damage to your hearing, do not hold your phone against your ear when the Speakerphone is turned on.

### To mute a call

Click **Mute** during a call, so that you can hear the caller but the caller cannot hear you. When the microphone is turned off, the mute icon () appears on the screen. Click **Unmute** to turn on the microphone again.



## 2.5 Additional Dialing Information

### Make an emergency call

- Enter the appropriate emergency number for your region and press TALK ()

**Tip** Additional emergency numbers may be included in your SIM card. Contact your service provider for details.

### Make an international call

1. Press and hold the **0** key on the keypad until the  sign appears. The  sign replaces the 00 in the international prefix of the country that you are calling.
2. Enter the full phone number and press TALK (). The full phone number includes country code, area code (without the leading zero, if any) and phone number.

### Insert a pause in a dialing sequence

Some international calls require a pause in the dialing sequence in order for the calls to process successfully.

1. On the Home screen, click **Start > Contacts**.
2. Select the contact entry that contains the phone number into which you want to insert a pause and press ENTER to open the contact card.
3. Select the desired phone number and click **Menu > Edit**.
4. Position the cursor on the phone number where you want to insert a pause, then click **Menu > Insert Pause**. The letter “p” will appear in the number to indicate where the pause will occur in the dialing sequence.
5. Click **Done**.

## Insert a longer pause in a dialing sequence

Some phone numbers may require a longer pause than the default pause in the dialing sequence. In these cases, you can pause as long as you want and manually continue the dialing sequence.

1. On the Home screen, click **Start > Contacts**.
2. Select the contact entry that contains the phone number into which you want to insert a longer pause and press ENTER to open the contact card.
3. Select the desired phone number and click **Menu > Edit**.
4. Position the cursor on the phone number where you want to insert a longer pause, then click **Menu > Insert Wait**. The letter “w” will appear in the number to indicate where the longer pause (wait) will occur in the dialing sequence.
5. Click **Done**.

**Note** When you call a number that contains a longer pause, you must press TALK (📞) to continue dialing.

## SIM Tool Kit (STK)

A SIM card must be inserted in your device in order to use this feature, which allows you to access a range of information services provided by your service provider.

1. On the Home screen, click **Start > SIM Tool Kit (STK)**. A list of provided services appears.
2. To access a service, click the item in the list.



# Chapter 3

## Synchronizing Information and Setting Up E-mail Security

**3.1 About ActiveSync**

**3.2 Setting Up ActiveSync**

**3.3 Synchronizing Information**

**3.4 Synchronizing via Bluetooth**

**3.5 Synchronizing Music and Video**

**3.6 Setting Up Email Security**



## 3.1 About ActiveSync

ActiveSync synchronizes information on your phone with information on your PC such as Outlook content. ActiveSync can also synchronize over a wireless or cellular network with Exchange Server if your company or service provider is running Exchange Server with Exchange ActiveSync.

Specifically, you can use ActiveSync to:

- Synchronize information such as Outlook email, contacts, calendar or tasks information on your phone with your PC, as well as music and video files.
- Synchronize Outlook email, contacts, calendar appointments and tasks on your phone directly with Exchange Server so that you can stay up to date even when your PC is turned off.
- Copy files between your phone and your PC.
- Select which types of information are synchronized and specify how much information is synchronized. For example, you can choose how many weeks of past calendar appointments to synchronize.
- Add and remove programs on your device. For details, see Chapter 4, “Adding and Removing Programs.”

## 3.2 Setting Up ActiveSync

### To install and set up ActiveSync your the computer

1. Install ActiveSync on your PC, as described on the Windows Mobile™ Getting Started Disc.
2. After Setup completes, the Synchronization Setup Wizard automatically starts when you connect your phone to the PC. The wizard will guide you through creating a synchronization relationship between your phone and the computer. Click **Next**.



- Do not select the **Synchronize directly with a server running Microsoft Exchange Server** check box if you will synchronize your device with a computer. Just click **Next**, then skip to step 8.
- If you are going to synchronize your device with Exchange Server, select the **Synchronize directly with a server running Microsoft Exchange Server** check box, then click **Next**.
- On the Exchange server credentials screen, enter the Exchange server address, your user name, password and the domain name.

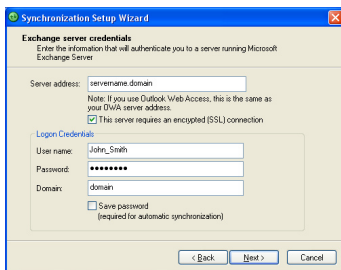

If you do not know what the Exchange server address and domain name are, you can check with your network administrator, or you can check them in your computer by doing the following:

- In Outlook, click **Tools > E-mail Accounts**.
- Select **View or change existing e-mail accounts**.
- Double-click **Microsoft Exchange Server**.
- On the Exchange Server Settings screen, you will see the Exchange Server name.

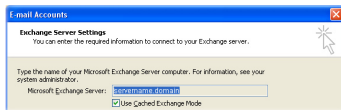

## 42 Synchronizing Information and Setting Up E-mail Security

- To check the domain name, click **Start > Settings > Control Panel**, then double-click **System**.
- In the System Properties dialog box, click the **Computer Name** tab. You will then see the domain name.

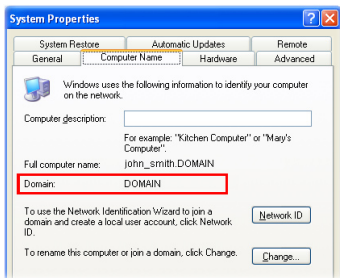

6. On your device, you also need to enter the Exchange server settings. For information about this, see “Synchronizing directly with Exchange Server.”
7. On the Synchronization Setup Wizard, click **Next**.
8. Select the information types to synchronize between your device and the computer.

If you are going to synchronize your device with both your computer and Exchange Server, do the following:

- For the Contacts, Calendar, E-mail and Tasks items, choose whether to synchronize them with the computer or with the Exchange Server. These items cannot be synchronized to both.
  - Select the check boxes of the other information types if you want to synchronize them with your computer.
9. Click **Next**.
  10. Click **Finish**.

**Tip** When you finish the wizard, ActiveSync synchronizes your phone automatically. Once synchronization completes, you can disconnect your phone from your PC.

## 3.3 Synchronizing Information

When you connect your phone to your PC, ActiveSync will immediately synchronize. While the phone is connected, ActiveSync synchronizes every time you make a change on either the PC or the phone.

### To manually start and stop synchronization

1. Connect your phone.
  - To synchronize local information on the PC, such as Outlook information or media files, connect your phone to the PC using Bluetooth or a cable.
  - If you are synchronizing directly with Exchange Server, you can use the connection to the PC to access the network, or you can synchronize over a cellular or Wi-Fi network without connecting to the PC.
2. In ActiveSync, click **Sync**. To end synchronization before it completes, click **Stop**.

### Synchronize Outlook information with the computer

If you have set up a synchronization relationship between your phone and the PC, synchronization keeps Outlook information up to date on both of them.

You can also set up your phone to synchronize with more than one PC, or with a combination of one or more PCs and Exchange Server. When synchronizing with multiple computers, the items you synchronize will appear on all of the computers with which they are synchronized. For example, if you have set up synchronization with two PCs (PC1 and PC2), which have different items, and you synchronize Contacts and Calendar on the phone with both computers, the result is as follows:

Location	New state
PC1	All Outlook contacts and calendar appointments that were on PC2 are now also on PC1.
PC2	All Outlook contacts and calendar appointments that were on PC1 are now also on PC2.
Phone	All Outlook contacts and calendar appointments from both PC1 and PC2 are on the phone.

**Note** Outlook email can be synchronized with only one computer.

### To change which information is synchronized

ActiveSync synchronizes a limited amount of information by default to save storage space on your phone. You can change the amount of information that is synchronized by performing the following steps.

**Note** Before changing synchronization settings on the phone, disconnect it from your PC.

1. On the Home screen, click **Start > ActiveSync**.
2. In ActiveSync, click **Menu > Options**.
3. Do one or more of the following:

- Select the check box for the items you want to synchronize. If you cannot select a check box, you might have to clear the check box for the same information type elsewhere in the list.
- Clear the check box for any items you want to exclude.
- To customize synchronization of a computer, select the computer name then click **Menu > Settings**.
- To customize synchronization of a particular type of information, select the information type then click **Settings**.
- To stop synchronizing with one computer completely, select the computer name and click **Menu > Delete**.

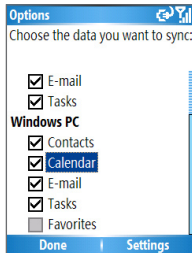

**Note** Outlook email can be synchronized with only one computer.

## Synchronize Outlook information with Exchange Server

You can set up synchronization with Exchange Server on your phone, if it is available to you through your company or wireless service provider. However, you should first ask your administrator or check your computer for the following information and then carry on with the steps: Exchange Server name, domain name, your user name and password. (For information about how to check the Exchange server name and domain on your PC, see “To install and set up ActiveSync on the computer.”)

**Note** Before changing synchronization settings on the phone, disconnect it from your PC.

### To synchronize directly with Exchange Server

1. On the Home screen, click **Start > ActiveSync > Menu > Configure Server**. If you have not yet set up synchronization with Exchange Server, this will say **Add Server Source**.
2. On the Edit Server Settings screen, enter the name of the server running Exchange Server in the **Server address** box and click **Next**.
3. On the User Information screen, enter your user name, password and domain name.
4. If you want the phone to save your password so that you will not need to enter it again when connecting, select the **Save password** check box. Then, click **Next**.
5. On the Options screen, select the check boxes of the types of information that you want to synchronize with Exchange Server.
6. To customize synchronization of a particular type of information, select the type of information then click **Menu > Settings**.
7. To change the rules for resolving synchronization conflicts, click **Menu > Advanced** on the Options screen.
8. Click **Finish**.

**Note** You can also use the Sync Setup Wizard to set up the phone to synchronize remotely with Exchange Server. This wizard is started when you connect your phone to your PC after installing ActiveSync on the PC.

## Schedule synchronization with Exchange Server

You can schedule information to be synchronized automatically between your phone and Exchange Server, or schedule synchronization at regular time intervals. Choose between these two methods, depending on your email volume and which method you think is more cost-effective.

### To receive emails and synchronize other information instantly

The **Direct Push** technology (Push E-Mail feature) enables you to receive new emails on your phone as soon as they arrive in your Inbox on Exchange Server. With this feature, items such as contacts, calendar and tasks are also immediately updated onto your phone when these items have been changed or new entries have been added on Exchange Server. To make Direct Push work, you need to set up a GPRS connection on your phone.

The Direct Push feature works for your phone if your private network such as your corporate network is using Microsoft Exchange Server Service Pack 2 (SP2) with Exchange ActiveSync and after your first full synchronization with Exchange Server.

1. In ActiveSync on your phone, click **Menu > Schedule**.
2. Select **As items arrive** in the **Peak times** and **Off-peak times** boxes.

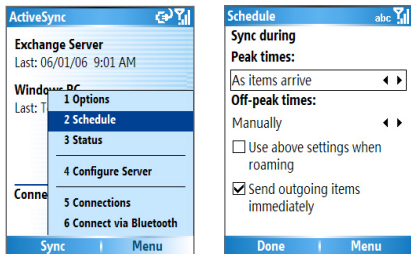

**Note** When the GPRS and Wi-Fi connections are turned on at the same time, the Direct Push feature will always go through GPRS, for which you could be charged as per your network operator's service plan.

### To schedule synchronization at regular time intervals

You can set how often to synchronize during **Peak times** (which usually refer to your working hours) when email volume is high, as well as **Off-times** when email volume is low.

1. In ActiveSync on your device, click **Menu > Schedule**.
2. On the Schedule screen, select a shorter time interval in the **Peak times** box for you to be able to receive emails more frequently.
3. Select a longer interval in the **Off-peak times** box.

**Tip** To set the days and hours that make up your peak and off-peak times, click **Menu > Peak Times** on the Schedule screen.

## 3.4 Synchronizing via Bluetooth

You can connect your phone to the PC to synchronize using the local wireless technologies and Bluetooth. These technologies have similar but slightly different requirements.

### To synchronize with a PC via Bluetooth

1. Follow the instructions in ActiveSync Help on the PC for configuring Bluetooth on your PC to support ActiveSync.
2. On the Home screen, click **Start > ActiveSync**.
3. Click **Menu > Connect via Bluetooth**. Ensure that the phone and the PC are within close range.
4. If this is the first time you have connected to this PC via Bluetooth, you must complete the Bluetooth wizard on the phone and set up a Bluetooth partnership with the PC before synchronizing.
5. Click **Sync**.
6. When finished, click **Menu > Disconnect Bluetooth**.

#### Notes

- To preserve battery power, turn off Bluetooth when not in use.
- To connect and synchronize your phone with a computer via Bluetooth, your computer must have a Bluetooth adapter or dongle.

## 3.5 Synchronizing Music and Video

If you want to take your music or other digital media with you, ActiveSync works with Windows Media Player to synchronize music and video files with your phone.

Other than selecting the media information type in ActiveSync to be synchronized, all media synchronization settings must be set in Windows Media Player. Before media can be synchronized, you must do the following:

- Install Windows Media Player Version 10 on the PC.
- Connect your phone to the PC with a USB cable. If the phone is currently connected using Bluetooth, you must end that connection before media can be synchronized.
- Insert a 32-MB or larger storage card into your phone.
- Set up a sync partnership between the storage card and Windows Media Player.

### Change Media synchronization settings

Once you have selected the Media information type in ActiveSync to be synchronized, any of your favorite music and video files in Windows Media Player playlists can be synchronized by ActiveSync. All you have to do is set up synchronization in Windows Media Player for those media files.

#### To set up a sync relationship with a storage card

1. On the PC, open Windows Media Player.
2. Click the **Sync** tab.
3. Select the storage card.
4. Click **Set up Sync**.
5. Choose whether to synchronize automatically or manually.

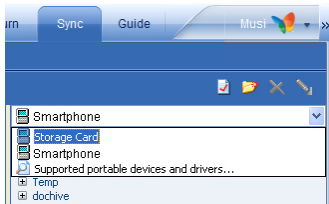

For information about using Windows Media Player on the phone, see “Using Windows Media Player” in Chapter 7.



## 3.6 Setting Up Email Security

Windows Mobile on your phone protects your Outlook emails through Secure/Multipurpose Internet Mail Extension (S/MIME), which allows you to digitally sign your messages as well as encrypt them.

Using authorization keys and certificates, S/MIME allows you to digitally sign your email messages to prove your identity to the recipients. Authorization keys are also used when encrypting messages to improve privacy and prevent undue tampering or hacking of your messages. You can encrypt a message with or without a certificate. However, to read an encrypted message, you need a valid certificate for decrypting email messages.

**Note** S/MIME encryption and digital signatures for Windows Mobile-based devices are available only with Exchange Server 2003 Service Pack 2 or a later version that supports S/MIME. If you aren't using one of these products or have not yet synchronized, these options are unavailable.

### Digitally sign and encrypt all messages

ActiveSync allows you to set up S/MIME email encryption and signing. You will have to obtain a valid certificate for signing or encrypting email before you will be able to sign or encrypt mail successfully.

1. On the Home screen, click **Start > ActiveSync**.
2. Click **Menu > Options**.
3. Select the **E-mail** information type and click **Settings**. On the E-mail Sync screen, click **Menu > Advanced**.

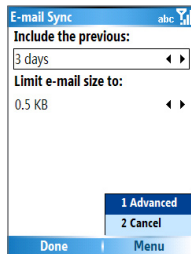
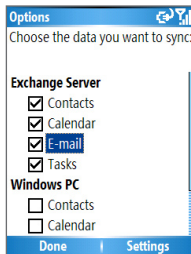

4. Do one or both of the following:
  - To sign all your outgoing email messages so that recipients can be certain that the messages were sent by you and have not been altered in any way, select **Sign messages**.
  - To encrypt all your outgoing email messages so that the contents of your messages are protected from being viewed by anyone other than the intended recipients, select **Encrypt messages**.
5. Click **Menu > Choose Certificate** to select a certificate for signing or encrypting outgoing email messages.

You can select certificates to sign or encrypt email messages individually if you do not choose to sign or encrypt all outgoing emails. For information about signing and encrypting individual messages, see “Individually sign and encrypt a message” in Chapter 6.

# Chapter 4

## Managing your Phone

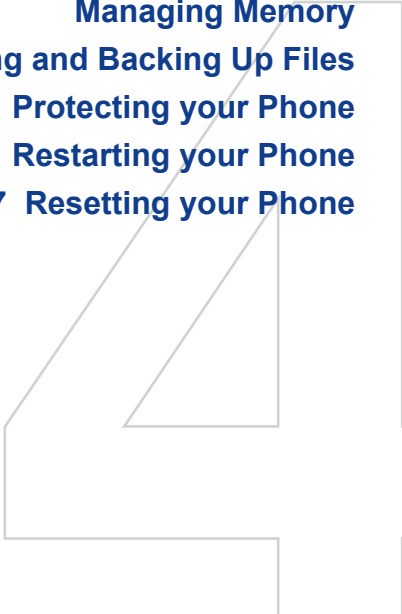
- 4.1 Personalizing your Phone**
  - 4.2 Adding and Removing Programs**
  - 4.3 Using Task Manager and  
Managing Memory**
  - 4.4 Managing and Backing Up Files**
  - 4.5 Protecting your Phone**
  - 4.6 Restarting your Phone**
  - 4.7 Resetting your Phone**
- 

## 4.1 Personalizing your Phone

### Set up the Answer Mode

You can answer an incoming call by pressing TALK (📞) or any numeric key on the keypad, or simply by opening the flip cover.

1. On the Home screen, click **Start > Settings > Phone**.
2. Click **Answer Mode**.
3. Select **Open to answer** or **Any key to answer**.

### Set up the Home screen

The Home screen is your starting place for most tasks. You can gain access to all features and programs from the Home screen.

The top of the Home screen displays icons for the programs that you have most recently used. The center of the Home screen can display your next appointment, the number of new messages (voice mail, text, email or MMS) that you have received and other important information. When you click an icon or item on the Home Screen, the associated program opens.

#### To customize the Home screen

1. On the Home screen, click **Start > Settings > Home Screen**.
2. In **Home screen layout**, **Color scheme**, **Background image** and **Time out**, select the options you want, and then click **Done**.

#### Tip

You have three ways to set up the background image:

- Use ActiveSync to copy your favorite picture file to the directory in your phone: My Device\Application Data\Home. Then, you can select the picture as the background image through **Start > Settings > Home Screen > Background image**.
- Capture a photo using the phone's camera. When viewing the photo in the Review screen, click **Menu > Use as Home Screen** and then follow the on-screen instructions to set the captured photo as the background image.
- Use the Pictures & Videos program to set up the background image. See "To set a picture as the Home screen background" in Chapter 7 for details.

## Set language, locale and other regional options

Your phone should already be set up with the regional settings that are appropriate for your locale.

### To change regional settings

You can specify the language, locale, date and time style, as well as number and currency formatting options.

1. On the Home screen, click **Start > Settings > Regional Settings**.
2. In **Language**, select your preferred language.
3. In **Locale**, select the locale for the language you selected. The Locale option automatically changes the format of the remaining options (such as date, time and currency) according to the locale you specify.
4. Click **Done**.

**Note** You must turn your phone off and on again for the changes to take effect.

## Set the date and time

1. On the Home screen, click **Start > Settings > Clock & Alarm > Date and Time**.
2. In **Time zone**, select your time zone.
3. In **Date**, edit the month, day or year.
4. In **Time**, edit the hour, minute and second.
5. Click **Done**.

## Choose how to be notified about events or actions

A profile is a group of settings that determine how your phone will alert you to incoming calls, events such as email receipt notifications, alarms or system events. A number of different preset combinations of these settings are included with your phone. Each profile appears with a descriptive name.

### To change the current profile

1. On the Home screen, click **Profile [Type]**. Example: **Profile Normal**.
2. Select the desired profile and click **Done**.

**Tip** To quickly change the profile, press and hold the HOME button to display the Quick List and click a profile.

### To edit a profile

1. On the Home screen, click **Profile [Type]**. Example: **Profile Normal**.
2. Select the profile to edit.
3. Click **Menu > Edit**.
4. Do one of the following:
  - Modify the settings and click **Done**.
  - To cancel without saving changes, click **Cancel**.

**Tip** To revert to the default profile settings, click **Menu > Reset to default**.

### To specify the sound for an event

1. On the Home screen, click **Start > Settings > Sounds**.
2. For the desired event, select a sound. Select **None** if you do not want to hear a sound.
3. Click **Done**.

**Note** For ring tones, you can use sounds in either .wav, .mid, .wma or .mp3 file format. For notifications or reminders, you can use .wav or .mid files.

**Tip** When you select a sound, the sound plays. To hear it again, select **Menu > Play**.

### To set sounds for the key presses

1. On the Home screen, click **Start > Settings > Sounds**.
2. In **Keypad control**, select a sound. Select **None** if you do not want to hear any sound while pressing a key.
3. Click **Done**.

## To copy a sound to your phone

After a sound file is located on your phone, you can use it for a ring tone, notification or reminder. Sound files in either .wav, .mid or .wma formats can be used.

1. Connect the phone to your PC using a USB connection.
2. On your PC, copy the desired sound file.
3. In ActiveSync on your PC, click **Explore** and double-click **My Windows Mobile-Based Device**.
4. Do one of the following:
  - To save the sound file on your phone, double-click **Application Data**, double-click **Sounds** and paste the file into that folder.
  - To save the sound file on your storage card, double-click **Storage Card** and paste the file into the folder you want.

## To set an alarm

1. On the Home screen, click **Start > Settings > Clock & Alarm > Alarm**.
2. In **Alarm**, choose one of the following:
  - **Off** to turn the alarm off.
  - **On** to turn the alarm on.
3. In **Alarm time**, enter the time for the alarm to go off.
4. Click **Done**.

## Set personal information

Entering and displaying owner information can prove helpful; they allow someone to return the phone to you if it is lost.

### To enter owner information

1. On the Home screen, click **Start > Settings > Owner Information**.
2. Complete the following:
  - In **Name**, enter your name.

- In **Telephone number**, enter a number where you can be reached.
  - In **E-mail address**, enter your email address.
  - In **Notes**, enter any other information you want to include.
3. Click **Done**.

## Set performance and maintenance options

### To change accessibility settings

1. On the Home screen, click **Start > Settings > Accessibility**.
2. Select your preferences for the following:
  - **System font size** to set the size of the font that is displayed on the screen.
  - **Multipress time out** to set the length of time between key presses when entering text in Multipress mode.
  - **Confirmation time out** to set the delay before an unconfirmed action times out.
  - **In-call alert volume** to set the volume for incoming calls or receiving new message alerts while you are in a call.
3. Click **Done**.

### To change power management settings

You can use Power Management to check the battery and configure settings that prolong battery life.

1. On the Home screen, click **Start > Settings > Power Management**.
2. Adjust the following:
  - In **Backlight time out on battery**, select the amount of time for the phone to be idle before the backlight turns off.
  - In **Backlight time out on AC**, select the amount of time for the phone to be idle before the backlight turns off when using AC (mains) power.



- In **Display time out**, select the time limit for the phone to be idle before the screen turns off.
- In **Light Sensor Enable**, turn it on to see the buttons on the keypad more easily in the dark.

3. Click **Done**.

**Tip** **Main battery** indicates the amount of battery life remaining.

### To find the operating system version number

- On the Home screen, click **Start > Settings > About**.  
The operating system version number installed on your phone along with the manufacturer's copyright information will be listed on the screen.

### To find the phone specification

- On the Home screen, click **Start > Settings > System Information**.  
The System Information screen displays the details about the phone specification, such as processor, speed, memory, display, model name, and so on.

### To turn error reporting on and off

1. On the Home screen, click **Start > Settings > Error Reporting**.
2. In **Error Reporting**, select **Enable** or **Disable** to turn on or off error reporting.
3. Click **Done**.

## Set up the external screen

You can change the display of the external screen when the flip cover is closed.

On the Home screen, click **Start > Settings > External Screen**, then you can configure the following:

- **Background**. Select the type of clock shown on the external display. Selecting Wallpaper allows you to choose a picture as the background of the external screen.

- **Wallpaper image.** Select a picture as the wallpaper.
- **Status bar.** Select **On** or **Off** to show or hide the status bar on the external screen.
- **Date and time.** Select **On** or **Off** to show or hide the current date and time on the external screen.
- **Button lock after idle for.** Select the amount of time for which the phone must be idle before the buttons are locked.
- **Button lock after closing.** Selecting **On** means the buttons will be locked immediately after the flip cover is closed. When you select **Off**, the button lock function will activate according to the configuration in the **Button lock after idle for** item.
- **Display time out.** Select how long the phone must be idle before the external screen turns off.
- **Display off after closing.** Selecting **On** means the external screen will turn off immediately after the flip cover is closed. When you select **Off**, the display time depends on the setting in the **Display time out** item.

## 4.2 Adding and Removing Programs

Before you purchase additional programs for your phone, you should note the name of your phone, the version of Windows Mobile software running on it and the type of processor. This information will help you select a program that is compatible with your phone. For more information, see “To find the operating system version number” in this chapter.

Programs available for purchase usually include a Setup program (commonly named “setup.exe”) that you must first install on your PC. You can then use ActiveSync to add programs to your phone or add a program directly from the Internet.

## To add programs

1. Download the program to your PC (or insert the CD or disk that contains the program into your PC). You may see a single \*.exe file, a \*.zip file, a Setup.exe file or several versions of files for different device types and processors. Be sure to select a program designed for your phone and processor type.
2. Read any installation instructions or documentation that comes with the program. Many programs provide special installation instructions.
3. Connect your phone and PC.
4. Double-click the \*.exe file.
  - If the executable file is an installation wizard, follow the instructions on the screen. Once the program has been installed on your PC, the wizard will automatically transfer the program to your phone.
  - If an installation wizard does not start, you will see an error message stating that the program is valid but that it is designed for a different type of computer. You will need to copy this program to your phone. If you cannot find any installation instructions for the program, use ActiveSync to copy the program file to the Program Files folder on your phone.

## To remove a program

Programs that come with the phone cannot be removed.

1. On the Home screen, click **Start > Settings > Remove Programs**.
2. Scroll to the program to remove.
3. Click **Menu > Remove**.

## 4.3 Using Task Manager and Managing Memory

### To see how much memory is available

1. On the Home screen, click **Start > Settings > About**.
2. Scroll down to **Available Memory**.

### Use Task Manager

Task Manager allows you to view all the programs currently running on your phone in the form of a list. From Task Manager, you can switch to, activate or terminate any currently running program. It also allows you to view the phone memory status and battery information.

### To start Task Manager

- Click **Start > Task Manager**.

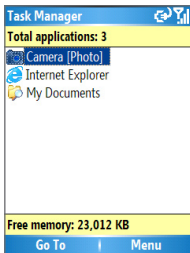

Task Manager

The Task Manager Menu contains the following options.

Option	Allows you to
<b>Go To</b>	Switch to the selected program.
<b>Refresh</b>	Refresh the Task Manager screen to reflect a list of currently running programs.
<b>Stop</b>	Stop the selected program. You can view the free memory status at the bottom of the screen.

Option	Allows you to
<b>Stop All</b>	Stop all listed programs. Click <b>OK</b> to confirm that you want to end all currently running programs. You can view the free memory status at the bottom of the screen.
<b>Stop All But Selected</b>	Stop all running programs in the list except the one you selected.
<b>System Info</b>	View information about power status, memory usage flash and device information.
<b>About</b>	View program name, version and copyright information.

## 4.4 Managing and Backing Up Files

You can back up files to your PC using ActiveSync or copy files to a storage card that is installed by you on your phone. You can also efficiently manage your files and folders using File Explorer installed on your phone.

Using Microsoft ActiveSync, you can copy or move information from the PC to the phone and vice versa. Changes you make to the information on one computer will not affect the information on the other computer. If you want to automatically update information on both your phone and your PC, synchronize the information instead. For more information about copying and synchronizing files, see ActiveSync Help on your PC.

### To copy a file using ActiveSync

Copying a file results in separate versions of a file on your phone and PC. Because the files are not synchronized, changes made to one file will not affect the other.

1. Connect your phone to your PC.
2. In ActiveSync, click **Explore**, which opens the Mobile Device folder for your phone.
3. In the Mobile Device folder, go to the file that you want to copy on your phone or PC.

4. Do one of the following:

- To copy the file to your phone, right-click the file and click **Copy**. Right-click the desired folder on your phone and click **Paste**.
- To copy the file to your PC, right-click the file and click **Copy**. Right-click the desired folder on your PC and click **Paste**.

## Use File Explorer

File Explorer provides many easy-to-use features for file and folder management.

### To start File Explorer

- On the Home screen, click **Start > File Explorer**.

File Explorer operates in the following two views:

- List View
- Icons View

File Explorer displays the entire file structure in your phone's memory. The functions focus primarily on folder management. When initially started, File Explorer is in List View by default. To switch between views, click **Menu > View > Icons** or **List**.

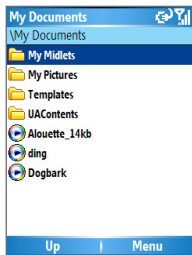

File Explorer - List View

The File Explorer menu contains the following options:

Option	Allows you to
<b>Send</b>	Allows you send the selected file through one of the messaging features.
<b>Beam</b>	Allows you send the selected file through Bluetooth.
<b>Edit</b>	Open a menu where you can choose to cut, copy, paste, delete or rename a file. You can also create a new folder.
<b>Properties</b>	View information about the selected folder or file.
<b>View</b>	Open a menu where you can switch between the Icons or List view.
<b>Sort By</b>	Open a menu where you can choose to sort the files or folders by Name, Date, Size or Type.
<b>My Device</b>	Display the folders and files in the root folder of the phone.
<b>My Documents</b>	Display the folders and files in the My Documents folder.

### To send a file as an email attachment

1. In File Explorer, select a file.
2. Click **Menu > Send**.
3. On the Messaging screen, select **Outlook E-mail** or a custom email account.
4. The file will automatically be attached to the new message. Specify the recipient and subject and type your message.
5. Click **Send**.

## 4.5 Protecting your Phone

There are several levels of security on your phone. You can protect your phone from unauthorized use by requiring a type of password called a PIN (personal identification number) in order to make calls. Your first PIN will be given to you by your wireless service provider. Additionally, you can lock the keypad or the entire phone to prevent unauthorized access.

### To enable the SIM personal identification number (PIN)

1. On the Home screen, click **Start > Settings > Security**.
2. Click **Enable SIM PIN**.
3. Enter your PIN and click **Done**.

**Note** To cancel without enabling the SIM PIN, press HOME.

### To disable the SIM PIN

1. On the Home screen, click **Start > Settings > Security**.
2. Click **Disable SIM PIN**.
3. Enter your PIN and click **Done**.

### To change the SIM PIN

Be sure to make a note of your personal identification number (PIN). When the SIM PIN is enabled, you must provide this PIN to unlock the phone.

1. Click **Start > Settings > Security**.
2. Click **Change PIN2**.
3. In **Old PIN**, enter the current PIN.
4. Enter and confirm the new PIN and click **Done**.

### Lock the keypad

Locking the keypad turns off keypad functionality. This is a helpful feature if, for example, the phone turning itself on in your pocket and making accidental key presses.



### To lock the keypad

- On the Home screen, press and hold the HOME button and click **Key lock**. Once the keypad is locked, the left soft key label changes to **Unlock**.

**Note** You can still receive calls and make emergency calls when the keypad is locked.

### To unlock the keypad

- On the Home screen, click **Unlock** and press the  key.

## Lock your phone

Device Lock is an additional security feature that prevents unauthorized use of your phone.

### To enable/disable Device Lock

- On the Home screen, click **Start > Settings > Security**.
- Click **Device Lock**.
- Select the **Prompt if device unused for** item, then select the amount of time for which the phone should be inactive before automatically locking.
- Select the password type (**Simple SIM** or **Strong alphanumeric**).
- Enter and confirm your password.
- Click **Done**.
- To disable Device Lock, click **Start > Settings > Security > Device Lock** to enter the setting page (requires the password) and clear the **Prompt if device unused for** item.

### To lock/unlock your phone

- Once you configure the Device Lock setting, you can lock your phone from the Quick List directly without configuring the settings again.
- When the device is locked, click **Unlock** and enter the password to unlock your device.

## 4.6 Restarting your Phone

Occasionally, you may want to restart your phone, for example, when a program is not performing properly or the phone does not respond to any key presses.

### To restart the phone

1. Remove the battery.
2. Reinsert the battery and turn on your phone.

**Warning!** If the phone is restarted while a program is running, unsaved work will be lost.

## 4.7 Resetting your Phone

Resetting your phone will remove all the data from its memory which include contacts, tasks, calendar appointments and more, and restore the phone back to the factory default settings.

### To reset your phone

1. Click **Start > Accessories > Clear Storage**.
2. Follow the on-screen instructions to reset the phone. The phone will restart after it has been reset.

# Chapter 5

## Getting Connected

**5.1 Connecting to the Internet**

**5.2 Using Internet Explorer Mobile**

**5.3 Using Wireless Modem**

**5.4 Using Comm Manager**

**5.5 Using Bluetooth**



## 5.1 Connecting to the Internet

Your phone's powerful networking capabilities allow you to access the Internet or your corporate network at work through wireless and conventional connections. Specifically, you can configure your phone to establish a connection via Dial-up, GPRS, Bluetooth, Virtual Private Network (VPN) or Proxy.

With an active connection on your phone, you can browse the Web, download emails or chat using MSN Messenger. Check with your service provider to see if a connection has already been set up for you and if over-the-air configuration is supported.

If you need to manually set up a connection, it is important that you obtain the following information from your Internet Service Provider (ISP) or the company whose intranet you are trying to access:

- ISP server phone number
- User name
- Password
- Access point name (required for GPRS connection)
- Domain name (required for accessing a corporate network or an intranet)

### Set up a GPRS connection

GPRS is a non-voice value-added service that allows information to be sent and received across a mobile telephone network. You can use GPRS to connect to the Internet or to send and receive MMS on your phone. When you use GPRS, you will be billed per KB (Kilobyte) when sending or receiving information.

If GPRS settings are not preset on your phone, obtain the **Access point name** from your wireless service provider. Also, check with your wireless service provider if a user name and password are required.

## To set up a GPRS connection

1. On the Home screen, click **Start > Settings > Connections > GPRS**.
2. Click **Menu > Add**.
3. In **Description**, enter a name for the connection.
4. In **Connects to**, select **The Internet**.
5. Enter the name of the GPRS **Access point** of your wireless service provider.
6. Enter the appropriate information in the remaining fields, if required by your wireless service provider.

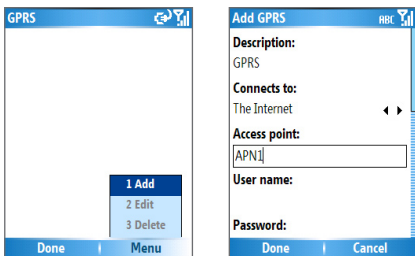

7. Click **Done**.
8. To start browsing the Internet, click **Start > Internet Explorer**.

**Note** For information about setting up and sending MMS, see “Using MMS Messages” in Chapter 6.

## Set up a Dial-up connection

When you use your phone to dial up to your ISP and connect to the Internet or to your corporate network, you will be billed by the number of minutes that you use.

To establish a dial-up connection on your phone, you need the same settings that you normally use when you dial up from your computer. This includes the ISP server phone number, your user name and password.

**To set up a dial-up connection for browsing the Internet**

1. On the Home screen, click **Start > Settings > Connections > Dial-up**.
2. Click **Menu > Add**.
3. In **Description**, enter a name for the connection.
4. In **Connects to**, select **The Internet**.
5. Enter the appropriate information in the remaining fields.

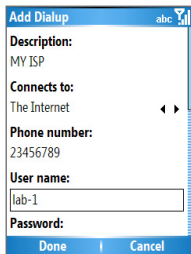
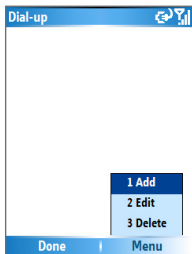

6. Click **Done**.
7. To start browsing the Internet, click **Start > Internet Explorer**.

**To set up a dial-up connection to your corporate network**

1. On the Home screen, click **Start > Settings > Connections > Dial-up**.
2. Click **Menu > Add**.
3. In **Description**, enter a name for the connection.
4. In **Connects to**, select **Work**.
5. Enter the appropriate information in the remaining fields.
6. Click **Done**.

- Note** You can also add and set up the following connections:
- **VPN:** A VPN connection is used to access your corporate network by using an existing Internet connection.
  - **Proxy:** A Proxy connection is used to access the Internet using an existing connection to your corporate or WAP network.

## Advanced options

From the Connections screen, you can access advanced options to specify the service provider, the number of redial attempts, the amount of idle time to wait before disconnecting, and so on.

1. On the Home screen, click **Start > Settings > Connections**.
2. Click **Menu > Advanced**.
3. Select a network service provider for each connection type. You can choose **Automatic** to allow the phone to set a service provider for each connection by default.
4. Click **Menu > Options**.
5. Choose the appropriate information for the remaining fields.
6. Click **Done**.

## Add a URL exception

Some URLs for Web pages on your company intranet may use dots, for example: intranet.companyname.com. To view these pages in Internet Explorer Mobile, you must create a URL exception.

1. On the Home screen, click **Start > Settings > Connections**.
2. Click **Menu > Advanced**.
3. Click **Menu > Work URL Exceptions**.
4. Click **Menu > Add**.
5. In **URL Pattern**, enter the URL name. To add multiple URLs, use a semicolon (;).
6. Click **Done**.

**Note** You do not need to create URL exceptions for Internet URLs.

## 5.2 Using Internet Explorer Mobile

Internet Explorer Mobile is a full-featured Internet browser, optimized for use on your phone.

### To open Internet Explorer

- On the Home screen, click **Start > Internet Explorer**.

### To go to a link

1. While on a Web page, scroll vertically or horizontally to see all available links.
2. Click the link.

### To go to a Web page

1. In Internet Explorer, click **Menu > Address Bar**.
2. Enter the address and click **Go**.

### To change Web page display options

1. While on a Web page, click **Menu > View**.
2. Select one of the following:
  - **One Column.** Arranges the content into one column that is as wide as the screen. This means that you will rarely have to scroll horizontally.
  - **Default.** Maintains a layout similar to what you see on a desktop computer, but makes items smaller and arranges the content so that you can see most of it without having to scroll horizontally.
  - **Desktop.** Keeps the same layout and size as on a desktop computer, which will require both horizontal and vertical scrolling.

### To change the size of text on Web pages

- While on a Web page, click **Menu > Zoom** and select the size you want.



### To show or hide pictures on Web pages

- While on a Web page, click **Menu > View > Show Pictures**.  
A check mark next to **Show Pictures** indicates that pictures will be displayed on Web pages.

### To view a page in full-screen mode

- While on a Web page, click **Menu > View > Full Screen**.

**Tip** To exit full-screen mode, press either **SOFT KEY**, and then click **Menu > View > Full Screen** to cancel the selection.

### To add a Web page to the Favorites list

1. Go to the page you want to add, click **Menu > Address Bar**, enter the address and click **Go**.
2. Click **Menu > Add to Favorites**.
3. Confirm or change the name and Web page address.
4. In **Folder**, select a folder for the favorite.
5. Click **Add**.

**Tip** A quick way to add favorites to your phone is to synchronize with your PC using ActiveSync. For more information, see ActiveSync Help on your PC.

### To view a favorite

1. While on a Web page, click **Favorites**.
2. Select a favorite and click **Go**.

### To move a favorite to a folder

1. Click **Favorites**.
2. Select the favorite to move.
3. Click **Menu > Edit**.
4. Under **Folder**, scroll to the folder to which you want to move the favorite.
5. Click **Done**.

### To clear history, cookies or temporary files

1. While on a Web page, click **Menu > Tools > Options**.
2. Click **Memory**.
3. Select the type of memory to clear.
4. Click **Clear**, click **Yes**, and then click **Done**.

### To send a link via email

1. Go to the desired Web page.
2. Click **Menu > Tools > Send Link via E-mail**.
3. Select **Text Messages** or **Outlook E-mail**.
4. A new message is created with the page address inserted in the message body.

## 5.3 Using Wireless Modem

With **Wireless Modem**, you can use your phone as an external modem for another device such as a PDA or notebook computer.

**Note** Make sure your phone has a GPRS SIM card installed and that you have set up a GPRS or dial-up modem connection on your phone. For information about setting up GPRS on your phone, see “Set up a GPRS connection” in this chapter. Also make sure you have connected your phone to a computer (via Bluetooth or USB). For information about setting up a dial-up connection, see “Set up a Dial-up connection.”

### Set up the phone as a modem

#### To set up the phone as a USB modem

1. On the Home screen of your phone, click **Start > Accessories > Wireless Modem**.
2. Select **USB** as the **Connection** type.
3. To use your phone as a GPRS modem, set the **Access point name** (APN). To set, click **Menu > APN Setting** and enter the access point name.

4. On your notebook, disable ActiveSync. Then plug in the USB cable adapter between the phone and the notebook.

**Note** To disable ActiveSync on your computer, click **File > Connection Settings** then clear **Allow USB connections**.

5. Click **Menu > Start** on your phone.
6. The next thing to do is to add the phone as a USB modem onto your notebook. To do so, continue to do the following steps.
7. After you click **Menu > Start** on the Wireless Modem screen of your phone, your notebook will automatically detect that your phone has been connected. The Found New Hardware dialog box will then appear on your notebook.
8. In the Found New Hardware dialog box, select **Install from a list or specific location (Advanced)** and click **Next**.
9. Select **Search for the best drivers in these locations**.
10. Insert the Getting Started Disc into your CD drive. Select the **Include this location in the search** check box, then click **Browse** and choose the CD drive and root folder where the modem driver is located. Then click **Next**.
11. Wait for the installation to complete, then click **Finish**.
12. On your computer, click **Start > Settings > Control Panel**.
13. Double-click **Phone and Modem Options**.
14. Click the **Modems** tab. Select the new modem from the Modems list, then click **OK**.

