



FCC TEST REPORT (PART 22)

REPORT NO.: RF970711L09

MODEL NO.: SEDN100

RECEIVED: Jul. 11, 2008

TESTED: Jul. 15 ~ Jul. 31, 2008

ISSUED: Aug. 06, 2008

APPLICANT: HTC Corporation

ADDRESS: No. 23, Xinghua Rd., Taoyuan City, 330, Taiwan,
R.O.C.

ISSUED BY: Advance Data Technology Corporation

LAB ADDRESS: No. 47, 14th Ling, Chia Pau Tsuen, Lin Kou Hsiang,
Taipei Hsien 244, Taiwan, R.O.C.

TEST LOCATION: No. 19, Hwa Ya 2nd Rd., Wen Hwa Tsuen, Kwei
Shan Hsiang, Taoyuan Hsien 333, Taiwan, R.O.C.

This test report consists of 76 pages in total. It may be duplicated completely for legal use with the approval of the applicant. It should not be reproduced except in full, without the written approval of our laboratory. The client should not use it to claim product endorsement by TAF or any government agencies. The test results in the report only apply to the tested sample.





TABLE OF CONTENTS

1	CERTIFICATION	4
2	SUMMARY OF TEST RESULTS	5
2.1	MEASUREMENT UNCERTAINTY	5
3	GENERAL INFORMATION.....	6
3.1	GENERAL DESCRIPTION OF EUT.....	6
3.2	DESCRIPTION OF TEST MODES.....	8
3.2.1	CONFIGURATION OF SYSTEM UNDER TEST.....	9
3.2.2	TEST MODE APPLICABILITY AND TESTED CHANNEL DETAIL.....	10
3.3	GENERAL DESCRIPTION OF APPLIED STANDARDS.....	14
3.4	DESCRIPTION OF SUPPORT UNITS.....	14
4	TEST TYPES AND RESULTS.....	15
4.1	OUTPUT POWER MEASUREMENT.....	15
4.1.1	LIMITS OF OUTPUT POWER MEASUREMENT.....	15
4.1.2	TEST INSTRUMENTS.....	16
4.1.3	TEST PROCEDURES.....	17
4.1.4	TEST SETUP.....	18
4.1.5	EUT OPERATING CONDITIONS.....	18
4.1.6	TEST RESULTS.....	19
4.2	FREQUENCY STABILITY MEASUREMENT.....	24
4.2.1	LIMITS OF FREQUENCY STABILITY MEASUREMENT.....	24
4.2.2	TEST INSTRUMENTS.....	24
4.2.3	TEST PROCEDURE.....	25
4.2.4	TEST SETUP.....	25
4.2.5	TEST RESULTS.....	26
4.3	OCCUPIED BANDWIDTH MEASUREMENT.....	28
4.3.1	LIMITS OF OCCUPIED BANDWIDTH MEASUREMENT.....	28
4.3.2	TEST INSTRUMENTS.....	28
4.3.3	TEST SETUP.....	28
4.3.4	TEST PROCEDURES.....	29
4.3.5	EUT OPERATING CONDITION.....	29
4.3.6	TEST RESULTS.....	30
4.4	BAND EDGE MEASUREMENT.....	38
4.4.1	LIMITS OF BAND EDGE MEASUREMENT.....	38
4.4.2	TEST INSTRUMENTS.....	38
4.4.3	TEST SETUP.....	38
4.4.4	TEST PROCEDURES.....	39
4.4.5	EUT OPERATING CONDITION.....	39
4.4.6	TEST RESULTS.....	40
4.5	CONDUCTED SPURIOUS EMISSIONS.....	44
4.5.1	LIMITS OF CONDUCTED SPURIOUS EMISSIONS MEASUREMENT.....	44
4.5.2	TEST INSTRUMENTS.....	44
4.5.3	TEST PROCEDURE.....	45
4.5.4	TEST SETUP.....	45



4.5.5	EUT OPERATING CONDITIONS	45
4.5.6	TEST RESULTS	46
4.6	RADIATED EMISSION MEASUREMENT (BELOW 1GHz).....	58
4.6.1	LIMITS OF RADIATED EMISSION MEASUREMENT	58
4.6.2	TEST INSTRUMENTS	59
4.6.3	TEST PROCEDURES	60
4.6.4	DEVIATION FROM TEST STANDARD	61
4.6.5	TEST SETUP	61
4.6.6	EUT OPERATING CONDITIONS	61
4.6.7	TEST RESULTS	62
4.7	RADIATED EMISSION MEASUREMENT (ABOVE 1GHz)	64
4.7.1	LIMITS OF RADIATED EMISSION MEASUREMENT	64
4.7.2	TEST INSTRUMENTS	65
4.7.3	TEST PROCEDURES	66
4.7.4	DEVIATION FROM TEST STANDARD	66
4.7.5	TEST SETUP	67
4.7.6	EUT OPERATING CONDITIONS	67
4.7.7	TEST RESULTS	68
5	PHOTOGRAPHS OF THE TEST CONFIGURATION.....	74
6	INFORMATION ON THE TESTING LABORATORIES	75
7	APPENDIX A – MODIFICATIONS RECORDERS FOR ENGINEERING CHANGES TO THE EUT BY THE LAB.....	76



1 CERTIFICATION

PRODUCT : Pocket PC Phone
MODEL : SEDN100
APPLICANT : HTC Corporation
TESTED : Jul. 15 ~ Jul. 31, 2008
TEST SAMPLE : ENGINEERING SAMPLE
TEST STANDARDS : **FCC Part 22, Subpart H**
ANSI C63.4-2003

The above equipment (model: SEDN100) has been tested by **Advance Data Technology Corporation**, and found compliance with the requirement of the above standards. The test record, data evaluation & Equipment Under Test (EUT) configurations represented herein are true and accurate accounts of the measurements of the sample's EMC characteristics under the conditions specified in this report.

PREPARED BY : Andrea Hsia , **DATE:** Aug. 06, 2008
Andrea Hsia / Specialist

TECHNICAL ACCEPTANCE : Long Chen , **DATE:** Aug. 06, 2008
Responsible for RF Long Chen / Senior Engineer

APPROVED BY : Gary Chang , **DATE:** Aug. 06, 2008
Gary Chang / Assistant Manager

2 SUMMARY OF TEST RESULTS

The EUT has been tested according to the following specifications:

APPLIED STANDARD: FCC Part 22 & Part 2			
STANDARD SECTION	TEST TYPE AND LIMIT	RESULT	REMARK
2.1047 (d)	Modulation Characteristics	PASS	Meet the requirement of limit.
2.1046 22.913 (a)	Maximum Peak Output Power Limit: max. 7 watts e.r.p peak power	PASS	Meet the requirement of limit. Minimum passing margin is 31.36dBm at 848.8MHz.
2.1055	Frequency Stability AFC Freq. Error vs. Voltage AFC Freq. Error vs. Temperature Limit: max. ± 2.5 ppm	PASS	Meet the requirement of limit.
2.1049 (h)	Occupied Bandwidth	PASS	Meet the requirement of limit.
22.917	Band Edge Measurements	PASS	Meet the requirement of limit.
2.1051 22.917	Conducted Spurious Emissions	PASS	Meet the requirement of limit.
2.1053 22.917	Radiated Spurious Emissions	PASS	Meet the requirement of limit. Minimum passing margin is -33.53dB at 90.26MHz.

2.1 MEASUREMENT UNCERTAINTY

Where relevant, the following measurement uncertainty levels have been estimated for tests performed on the EUT as specified in CISPR 16-4-2:

MEASUREMENT	FREQUENCY	UNCERTAINTY
Conducted emissions	9kHz~30MHz	2.44 dB
Radiated emissions	30MHz ~ 200MHz	3.34 dB
	200MHz ~1000MHz	3.35 dB
	1GHz ~ 18GHz	2.26 dB
	18GHz ~ 40GHz	1.94 dB

This uncertainty represents an expanded uncertainty expressed at approximately the 95% confidence level using a coverage factor of k=2.

3 GENERAL INFORMATION

3.1 GENERAL DESCRIPTION OF EUT

PRODUCT	Pocket PC Phone
MODEL NO.	SEDN100
FCC ID	NM8SEDN100
POWER SUPPLY	3.7Vdc from rechargeable lithium battery 5.0Vdc from power adapter 5.0Vdc from host equipment
MODULATION TYPE	GMSK / 8PSK / BPSK
FREQUENCY RANGE	824MHz ~ 849MHz
NUMBER OF CHANNEL	124 (GSM band) / 102 (WCDMA band)
MAX. ERP POWER	GSM Mode: 31.36dBm (1.368Watts) GPRS Mode: 31.07dBm (1.279Watts) E-GPRS Mode: 24.30dBm (0.269Watts) WCDMA Mode: 21.79dBm (0.151Watts)
ANTENNA TYPE	monopole
MAX. ANTENNA GAIN	0dBi
DATA CABLE	1.28m shielded USB cable without core
I/O PORTS	Refer to user's manual
ACCESSORY DEVICES	Adapter, Battery, earphone (1.50m non-shielded cable without core)

NOTE:

1. The EUT is a Pocket PC Phone. The functions of EUT listed as below:

	TEST STANDARD	REFERENCE REPORT
WLAN 802.11b/g	FCC Part 15	RF970711L09-2
BLUETOOTH		RF970711L09-3
CDMA 850 / WCDMA 850	FCC Part 22	RF970711L09
CDMA 1900 / WCDMA 1900	FCC Part 24	RF970711L09-1

2. The communicated functions of EUT listed as below:

		GSM 850MHz	PCS 1900MHz	WCDMA 850MHz	WCDMA 1900MHz	With 802.11b/g WLAN + Bluetooth 2.0 w EDR
2G	GSM	√	√			
	GPRS	√	√			
	EDGE	√	√			
3G	WCDMA			√	√	
	Release 5 HSDPA			√	√	

3. The EUT has lithium batteries listed as below:

BATTERY :	
BRAND:	HTC
MODEL:	TRIN160
RATING:	3.7Vdc, 1500mAh

4. The EUT were operated with following power adapters:

ADAPTER A :	
BRAND:	PHIHONG
MODEL:	PSAA05A-050
INPUT:	100-240Vac, 200mA, 50-60Hz, 13-20VA
OUTPUT:	5Vdc, 1A
POWER LINE:	1.8m non-shielded cable without core

ADAPTER B :	
BRAND:	DELTA ELECTRONICS. INC.
MODEL:	ADP-5FH B
INPUT:	100-240Vac, 0.2A, 50-60Hz
OUTPUT:	5Vdc, 1A
POWER LINE:	1.8m non-shielded cable without core

5. IMEI Code: 35604001*****

6. The above EUT information was declared by manufacturer and for more detailed features description, please refer to the manufacturer's specifications or User's Manual.

3.2 DESCRIPTION OF TEST MODES

FOR GSM BAND:

124 channels are provided to this EUT in the GSM850 band. Therefore, the low, middle and high channels are chosen for testing.

	CHANNEL	FREQUENCY	TX MODE
LOW	128	824.2 MHz	GSM, GPRS, E-GPRS
MIDDLE	190	836.6 MHz	GSM, GPRS, E-GPRS
HIGH	251	848.8 MHz	GSM, GPRS, E-GPRS

NOTE:

1. Below 1 GHz, the channel 128, 190, and 251 were pre-tested in chamber. The channel 128 was chosen for final test.
2. Above 1 GHz, the channel 128, 190, and 251 were tested individually.
3. The worst case for final test is chosen when the power control level set 5.
4. The channel space is 0.2MHz.
5. Since the EUT is considered a portable unit, it was pre-tested on the positioned of each 3 axis. The worst case was found when positioned on Z-plane. Therefore only the test data of this Z-plane was used for radiated emission measurement test.
6. The EUT is a GPRS class 12 device (Multislot class: 12, Mobile Terminal B), which provide 4 up-link. After pre-tested both functions, found up-link with 1 time slot is worse, therefore, test results of output power, frequency stability, occupied bandwidth and band edge tests came out from this.
7. The EUT is an E-GPRS class 12 device (Multislot class: 12, Mobile Terminal B), which provide 4 up-link. After pre-tested both functions, found up-link with 1 time slot is worse, therefore, test results of output power, frequency stability, occupied bandwidth and band edge tests came out from this.
8. The EUT has GSM, GPRS & E-GPRS functions. After pre-testing, GSM function is the worst case for all the emission tests.

FOR WCDMA BAND:

102 channels are provided to this EUT in the WCDMA850 band. Therefore, the low, middle and high channels are chosen for testing.

	CHANNEL	FREQUENCY	TX MODE
LOW	4132	826.4 MHz	WCDMA
MIDDLE	4182	836.4 MHz	WCDMA
HIGH	4233	846.6 MHz	WCDMA

NOTE:

1. Below 1 GHz, the channel 4132, 4182 and 4233 were pre-tested in chamber. The channel 4132 was chosen for final test.
2. Above 1 GHz, the channel 4132, 4182 and 4233 were tested individually.
3. The channel space is 0.2MHz.
4. Since the EUT is considered a portable unit, it was pre-tested on the positioned of each 3 axis. The worst case was found when positioned on Z-plane. Therefore only the test data of this Z-plane was used for radiated emission measurement test.
5. (RMC, HSDPA Inactive) mode has been chosen for the worst case to do the final test and record.

3.2.1 CONFIGURATION OF SYSTEM UNDER TEST

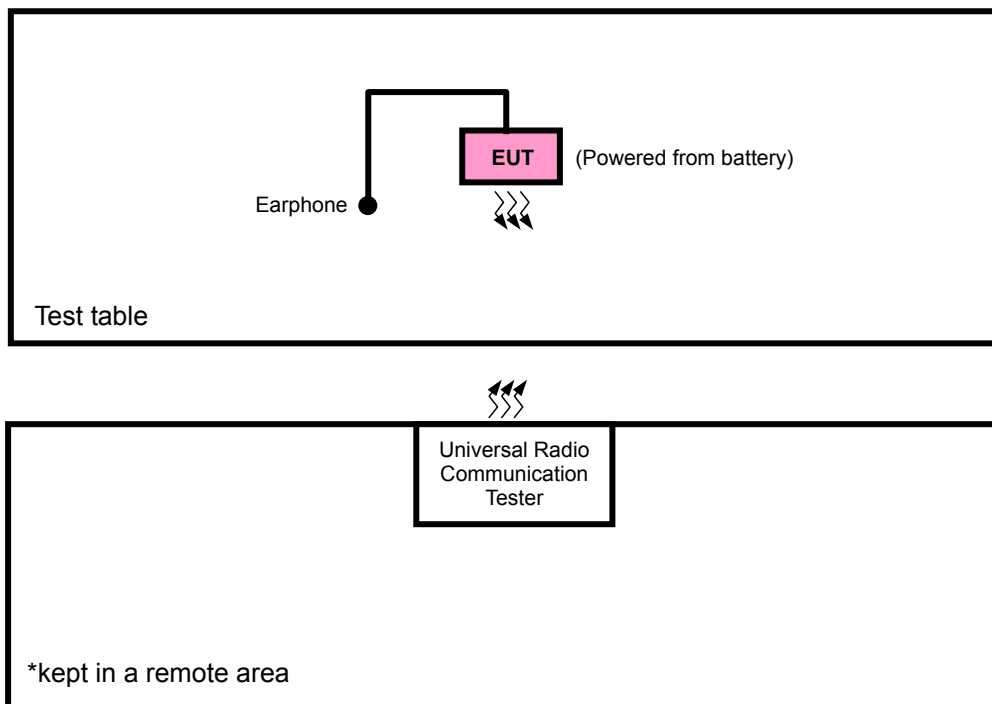

3.2.2 TEST MODE APPLICABILITY AND TESTED CHANNEL DETAIL

FOR GSM BAND:

EUT CONFIGURE MODE	APPLICABLE TO							DESCRIPTION
	OP	FS	OB	BE	CE	RE<1G	RE≥1G	
-	√	√	√	√	√	√	√	-

Where **OP**: Output power **FS**: Frequency stability
OB: Occupied bandwidth **BE**: Band edge
CE: Conducted spurious emissions **RE<1G**: Radiated emission below 1GHz
RE≥1G: Radiated emission above 1GHz

OUTPUT POWER MEASUREMENT:

- Pre-Scan has been conducted to determine the worst-case mode from all possible combinations between available modulations, data rates, XYZ axis and antenna ports (if EUT with antenna diversity architecture).
- Following channel(s) was (were) selected for the final test as listed below.

AVAILABLE CHANNEL	TESTED CHANNEL	MODULATION TECHNOLOGY	AXIS
128 to 251	128, 190, 251	GSM, GPRS, EGPRS	Z

FREQUENCY STABILITY MEASUREMENT:

- Pre-Scan has been conducted to determine the worst-case mode from all possible combinations between available modulations and antenna ports (if EUT with antenna diversity architecture).
- Following channel(s) was (were) selected for the final test as listed below.

AVAILABLE CHANNEL	TESTED CHANNEL	MODULATION TECHNOLOGY
128 to 251	190	GSM

OCCUPIED BANDWIDTH MEASUREMENT:

- Pre-Scan has been conducted to determine the worst-case mode from all possible combinations between available modulations and antenna ports (if EUT with antenna diversity architecture).
- Following channel(s) was (were) selected for the final test as listed below.

AVAILABLE CHANNEL	TESTED CHANNEL	MODULATION TECHNOLOGY
128 to 251	128, 190, 251	GSM, GPRS, EGPRS



BAND EDGE MEASUREMENT:

- Pre-Scan has been conducted to determine the worst-case mode from all possible combinations between available modulations and antenna ports (if EUT with antenna diversity architecture).
- Following channel(s) was (were) selected for the final test as listed below.

AVAILABLE CHANNEL	TESTED CHANNEL	MODULATION TECHNOLOGY
128 to 251	128, 251	GSM, GPRS, EGPRS

CONDUCTED SPURIOUS EMISSIONS MEASUREMENT:

- Pre-Scan has been conducted to determine the worst-case mode from all possible combinations between available modulations and antenna ports (if EUT with antenna diversity architecture).
- Following channel(s) was (were) selected for the final test as listed below.

AVAILABLE CHANNEL	TESTED CHANNEL	MODULATION TECHNOLOGY
128 to 251	128, 190, 251	GSM

RADIATED EMISSION MEASUREMENT (BELOW 1 GHz):

- Pre-Scan has been conducted to determine the worst-case mode from all possible combinations between available modulations, data rates, XYZ axis and antenna ports (if EUT with antenna diversity architecture).
- Following channel(s) was (were) selected for the final test as listed below.

AVAILABLE CHANNEL	TESTED CHANNEL	MODULATION TECHNOLOGY	AXIS
128 to 251	128	GSM	Z

RADIATED EMISSION MEASUREMENT (ABOVE 1 GHz):

- Pre-Scan has been conducted to determine the worst-case mode from all possible combinations between available modulations, data rates, XYZ axis and antenna ports (if EUT with antenna diversity architecture).
- Following channel(s) was (were) selected for the final test as listed below.

AVAILABLE CHANNEL	TESTED CHANNEL	MODULATION TECHNOLOGY	AXIS
128 to 251	128, 190, 251	GSM	Z

FOR WCDMA BAND:

EUT CONFIGURE MODE	APPLICABLE TO							DESCRIPTION
	OP	FS	OB	BE	CE	RE<1G	RE≥1G	
-	√	√	√	√	√	√	√	-

Where **OP**: Output power **FS**: Frequency stability
OB: Occupied bandwidth **BE**: Band edge
CE: Conducted spurious emissions **RE<1G**: Radiated emission below 1GHz
RE≥1G: Radiated emission above 1GHz

OUTPUT POWER MEASUREMENT:

- Pre-Scan has been conducted to determine the worst-case mode from all possible combinations between available modulations, data rates, XYZ axis and antenna ports (if EUT with antenna diversity architecture).
- Following channel(s) was (were) selected for the final test as listed below.

AVAILABLE CHANNEL	TESTED CHANNEL	MODULATION TECHNOLOGY	AXIS
4132 to 4233	4132, 4182, 4233	WCDMA	Z

FREQUENCY STABILITY MEASUREMENT:

- Pre-Scan has been conducted to determine the worst-case mode from all possible combinations between available modulations, data rates, and antenna ports (if EUT with antenna diversity architecture).
- Following channel(s) was (were) selected for the final test as listed below.

AVAILABLE CHANNEL	TESTED CHANNEL	MODULATION TECHNOLOGY
4132 to 4233	4182	WCDMA

OCCUPIED BANDWIDTH MEASUREMENT:

- Pre-Scan has been conducted to determine the worst-case mode from all possible combinations between available modulations, data rates, and antenna ports (if EUT with antenna diversity architecture).
- Following channel(s) was (were) selected for the final test as listed below.

AVAILABLE CHANNEL	TESTED CHANNEL	MODULATION TECHNOLOGY
4132 to 4233	4132, 4182, 4233	WCDMA



BAND EDGE MEASUREMENT:

- Pre-Scan has been conducted to determine the worst-case mode from all possible combinations between available modulations, data rates, and antenna ports (if EUT with antenna diversity architecture).
- Following channel(s) was (were) selected for the final test as listed below.

AVAILABLE CHANNEL	TESTED CHANNEL	MODULATION TECHNOLOGY
4132 to 4233	4132, 4233	WCDMA

CONDUCTED SPURIOUS EMISSIONS MEASUREMENT:

- Pre-Scan has been conducted to determine the worst-case mode from all possible combinations between available modulations, data rates, and antenna ports (if EUT with antenna diversity architecture).
- Following channel(s) was (were) selected for the final test as listed below.

AVAILABLE CHANNEL	TESTED CHANNEL	MODULATION TECHNOLOGY
4132 to 4233	4132, 4182, 4233	WCDMA

RADIATED EMISSION MEASUREMENT (BELOW 1 GHz):

- Pre-Scan has been conducted to determine the worst-case mode from all possible combinations between available modulations, data rates, XYZ axis and antenna ports (if EUT with antenna diversity architecture).
- Following channel(s) was (were) selected for the final test as listed below.

AVAILABLE CHANNEL	TESTED CHANNEL	MODULATION TECHNOLOGY	AXIS
4132 to 4233	4132	WCDMA	Z

RADIATED EMISSION MEASUREMENT (ABOVE 1 GHz):

- Pre-Scan has been conducted to determine the worst-case mode from all possible combinations between available modulations, data rates, XYZ axis and antenna ports (if EUT with antenna diversity architecture).
- Following channel(s) was (were) selected for the final test as listed below.

AVAILABLE CHANNEL	TESTED CHANNEL	MODULATION TECHNOLOGY	AXIS
4132 to 4233	4132, 4182, 4233	WCDMA	Z



3.3 GENERAL DESCRIPTION OF APPLIED STANDARDS

The EUT is a RF product. According to the specifications of the manufacturer, it must comply with the requirements of the following standards:

FCC 47 CFR Part 2

FCC 47 CFR Part 22

ANSI C63.4-2003

ANSI/TIA/EIA-603-C 2004

NOTE: All test items have been performed and recorded as per the above standards.

3.4 DESCRIPTION OF SUPPORT UNITS

The EUT has been tested as an independent unit together with other necessary accessories or support units. The following support units or accessories were used to form a representative test configuration during the tests.

NO.	PRODUCT	BRAND	MODEL NO.	SERIAL NO.	CAL. DATE
1	UNIVERSAL RADIO COMMUNICATION TESTER	R&S	CMU200	101095	Nov. 10, 2008
2	NJZ-2000 (GSM+WCDMA SIMULATOR)	JRC	NJZ-2000	ET00054	Sep. 30, 2008

NO.	SIGNAL CABLE DESCRIPTION OF THE ABOVE SUPPORT UNITS
1	NA
2	NA

NOTE 1: All power cords of the above support units are non shielded (1.8m).

NOTE 2: Item 1-2 acted as a communication partners to transfer data.

4 TEST TYPES AND RESULTS

4.1 OUTPUT POWER MEASUREMENT

4.1.1 LIMITS OF OUTPUT POWER MEASUREMENT

The radiated peak output power shall be according to the specific rule Part 22.913 (a) that “Mobile / Portable station are limited to 7 watts e.r.p”.



4.1.2 TEST INSTRUMENTS

DESCRIPTION & MANUFACTURER	MODEL NO.	SERIAL NO.	CALIBRATED UNTIL
Test Receiver ROHDE & SCHWARZ	ESI7	100033	Jun. 29, 2009
Spectrum Analyzer Agilent	FSP	100041	Apr. 21, 2009
BILOG Antenna SCHWARZBECK	VULB9168	9168-160	May, 01, 2009
HORN Antenna SCHWARZBECK	9120D	9120D-209	Jun. 23, 2009
HORN Antenna SCHWARZBECK	BBHA 9170	BBHA9170243	Dec. 24, 2008
Preamplifier Agilent	8447D	2944A10633	Oct. 28, 2008
Preamplifier Agilent	8449B	3008A01964	Oct. 23, 2008
RF signal cable HUBER+SUHNNER	SUCOFLEX 104	283402/4	Dec. 06, 2008
RF signal cable HUBER+SUHNNER	SUCOFLEX 104	251644/4	Dec. 06, 2008
Software ADT.	ADT_Radiated_V7.6	NA	NA
Antenna Tower inn-co GmbH	MA 4000	013303	NA
Antenna Tower Controller inn-co GmbH	CO2000	017303	NA
Turn Table ADT.	TT100.	TT93021703	NA
Turn Table Controller ADT.	SC100.	SC93021703	NA

- NOTE:**
1. The calibration interval of the above test instruments is 12 months and the calibrations are traceable to NML/ROC and NIST/USA.
 2. The test was performed in HwaYa Chamber 3.
 3. The horn antenna and HP preamplifier (model: 8449B) are used only for the measurement of emission frequency above 1GHz if tested.
 4. The FCC Site Registration No. is 988962.
 5. The IC Site Registration No. is IC3789B-3.

4.1.3 TEST PROCEDURES

- a. The EUT was set up for the maximum peak power with GSM / WCDMA link data modulation. The power was measured with R&S Spectrum Analyzer. All measurements were done at 3 channels, 128, 190 and 251 / 4132, 4182 and 4233 (low, middle and high operational frequency range.)
- b. The conducted peak output power used the power splitter via EUT RF power connector between simulation base station and spectrum analyzer. The path loss included the splitter loss, cable loss and 20dB pad loss. The spectrum set RB/VB 1MHz (GSM) and 5MHz (WCDMA), then read peak power value and record to the test. (All transmitted path loss shall be considered in the test report data.)
- c. E.I.R.P peak power measurement. In the fully anechoic chamber, EUT placed on the 1.5m height of Turn Table, rotated the table around 360 degrees to search the maximum radiation power and receiver antenna shall be rotated vertical and horizontal polarization to find the maximum polar radiated power. The “Read Value” is the spectrum reading the maximum power value.
- d. The substitution horn antenna is substituted for EUT at the same position and signals generator export the CW signal to the calibration antenna. Rotated the Turn Table to find the maximum radiation power. “Raw” is the spectrum reading value, “SG” is signal generator export power, “TX Gain” is calibration antenna isotropic gain value, “TX cable” is the transmitted cable loss between the calibration antenna and signal generator. The “Factor” means that the transmission path loss is equal to “SG” - “TX cable” + “TX Gain” – “Raw”.
- e. Actually the real E.I.R.P peak power is equal to “Read Value” + “Factor”
- f. E.R.P power can be calculated form E.I.R.P power by subtracting the gain of dipole,
 $E.R.P \text{ power} = E.I.P.R \text{ power} - 2.15\text{dBi}$.

NOTE: The resolution bandwidth and video bandwidth of test receiver/spectrum analyzer is 3MHz for Peak detection (PK)

4.1.4 TEST SETUP EIRP POWER MEASUREMENT:

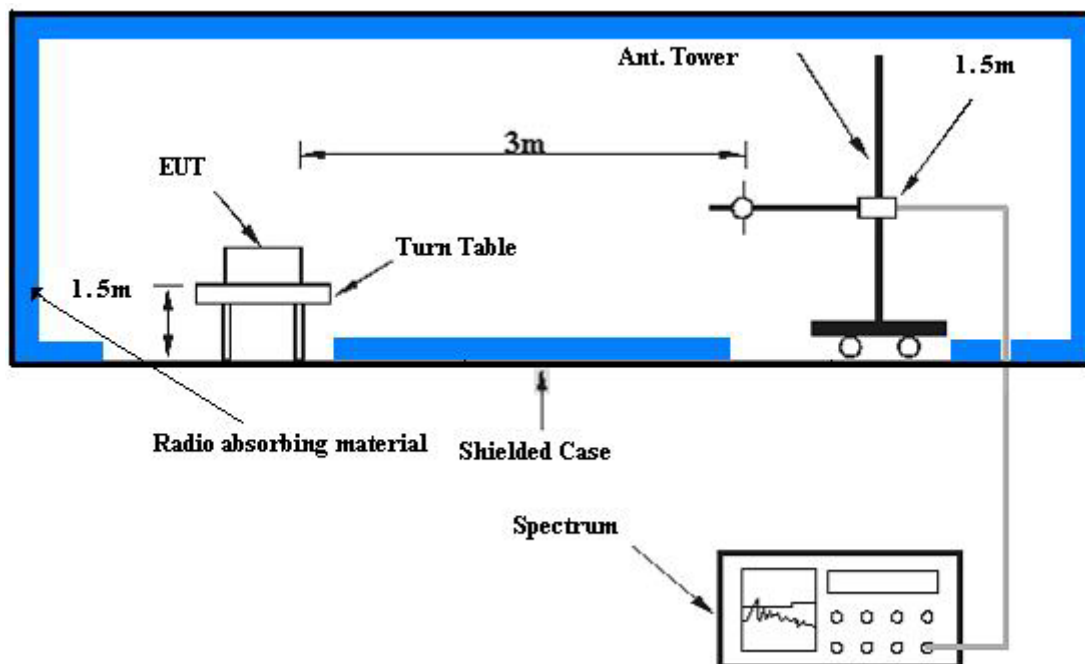

For the actual test configuration, please refer to the attached file (Test Setup Photo).

CONDUCTED POWER MEASUREMENT:

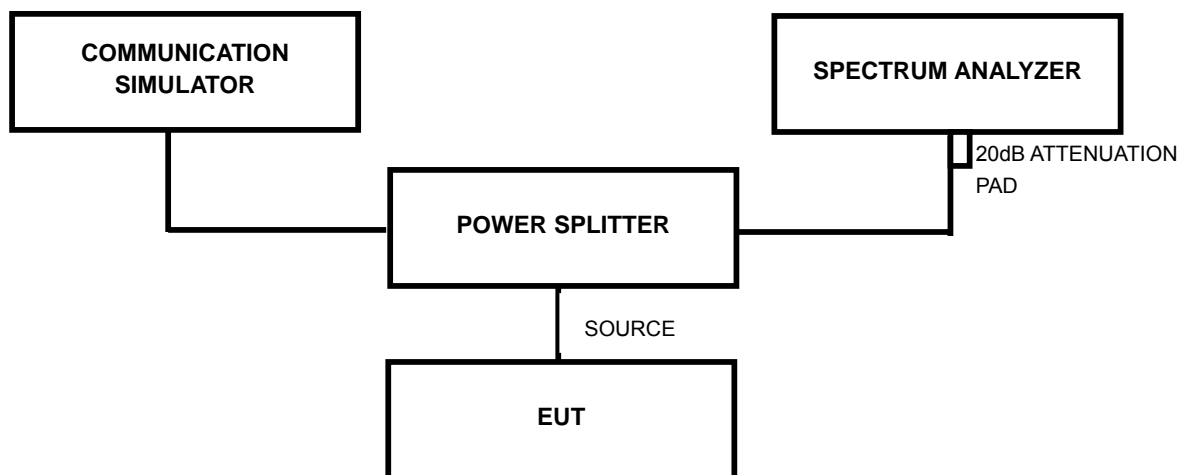

For the actual test configuration, please refer to the related item – Photographs of the Test Configuration.

4.1.5 EUT OPERATING CONDITIONS

- a. The EUT makes a phone call to the communication simulator.
- b. The communication simulator station system controlled an EUT to export maximum output power under transmission mode and specific channel frequency.

4.1.6 TEST RESULTS

FOR GSM BAND:

MODE	TX connected	POWER CONTROL LEVEL	5
INPUT POWER	120Vac, 60 Hz	DETECTOR FUNCTION	Peak
ENVIRONMENTAL CONDITIONS	25deg. C, 65%RH, 991hPa	TESTED BY	Brad Wu

FOR GSM MODE

CONDUCTED PEAK OUTPUT POWER					
CHANNEL NO.	FREQUENCY (MHz)	RAW VALUE (dBm)	CORRECTION FACTOR (dB)	PEAK OUTPUT POWER	
				dBm	Watt
128	824.2	32.42	0.50	32.92	1.959
190	836.6	32.45	0.50	32.95	1.972
251	848.8	32.44	0.50	32.94	1.968

FOR GPRS MODE (UP-LINK WITH 1 TIME SLOT)

CONDUCTED PEAK OUTPUT POWER					
CHANNEL NO.	FREQUENCY (MHz)	RAW VALUE (dBm)	CORRECTION FACTOR (dB)	PEAK OUTPUT POWER	
				dBm	Watt
128	824.2	32.38	0.50	32.88	1.941
190	836.6	32.36	0.50	32.86	1.932
251	848.8	32.35	0.50	32.85	1.928

FOR E-GPRS MODE (UP-LINK WITH 1 TIME SLOT)

CONDUCTED PEAK OUTPUT POWER					
CHANNEL NO.	FREQUENCY (MHz)	RAW VALUE (dBm)	CORRECTION FACTOR (dB)	PEAK OUTPUT POWER	
				dBm	Watt
128	824.2	25.78	0.50	26.28	0.425
190	836.6	25.96	0.50	26.46	0.443
251	848.8	26.04	0.50	26.54	0.451

REMARKS: 1. Peak Output Power (dBm) = Raw Value (dBm) + Correction Factor (dB).
 2. Correction Factor (dB) = Power Splitter Loss (dB) + Cable Loss (dB).



MODE	TX connected	POWER CONTROL LEVEL	5
INPUT POWER	120Vac, 60 Hz	DETECTOR FUNCTION	Peak
ENVIRONMENTAL CONDITIONS	25deg. C, 65%RH, 991hPa	TESTED BY	Brad Wu

FOR GSM MODE

ERP POWER					
CHANNEL NO.	FREQUENCY (MHz)	RAW VALUE (dBm)	CORRECTION FACTOR (dB)	PEAK OUTPUT POWER	
				dBm	Watt
128	824.2	-9.69	40.03	30.34	1.081
190	836.6	-10.30	40.32	30.02	1.005
251	848.8	-9.26	40.62	31.36	1.368

FOR GPRS MODE (UP-LINK WITH 1 TIME SLOT)

ERP POWER					
CHANNEL NO.	FREQUENCY (MHz)	RAW VALUE (dBm)	CORRECTION FACTOR (dB)	PEAK OUTPUT POWER	
				dBm	Watt
128	824.2	-9.96	40.03	30.07	1.016
190	836.6	-10.51	40.32	29.81	0.957
251	848.8	-9.55	40.62	31.07	1.279

FOR E-GPRS MODE (UP-LINK WITH 1 TIME SLOT)

ERP POWER					
CHANNEL NO.	FREQUENCY (MHz)	RAW VALUE (dBm)	CORRECTION FACTOR (dB)	PEAK OUTPUT POWER	
				dBm	Watt
128	824.2	-16.17	40.03	23.86	0.243
190	836.6	-16.74	40.32	23.58	0.228
251	848.8	-16.32	40.62	24.30	0.269

- REMARKS:**
1. Peak Output Power (dBm) = Raw Value (dBm) + Correction Factor (dB).
 2. Correction Factor (dB) = Receiver Antenna Gain (dBi) + Cable Loss (dB) + Free Space Loss (dB).



FOR WCDMA BAND:

The following procedures were followed according to FCC “SAR Measurement Procedures for 3G Devices”, October, 2007.

Output Power Verification

Maximum output power is verified on the High, Middle and Low channels according to the procedures described in section 5.2 of 3GPP TS 34.121, using the appropriate RMC or AMR with TPC (transmit power control) set to all “1”s for WCDMA/HSDPA or applying the required inner loop power control procedures to maintain maximum output power while HSUPA is active. Results for all applicable physical channel configurations (DPCCH, DPDCHn and spreading codes, HSDPA, HSPA) should be tabulated in the SAR report. All configurations that are not supported by the DUT or cannot be measured due to technical or equipment limitations should be clearly identified.



MODE	TX connected	POWER CONTROL LEVEL	0
INPUT POWER	120Vac, 60 Hz	DETECTOR FUNCTION	RMS
ENVIRONMENTAL CONDITIONS	25deg. C, 65%RH, 991hPa	TESTED BY	Brad Wu

CONDUCTED RMS OUTPUT POWER (RMC, HSDPA INACTIVE)					
CHANNEL NO.	FREQUENCY (MHz)	RAW VALUE (dBm)	CORRECTION FACTOR (dB)	PEAK OUTPUT POWER	
				dBm	Watt
4132	826.4	22.68	0.50	23.18	0.208
4182	836.4	22.86	0.50	23.36	0.217
4233	846.6	22.88	0.50	23.38	0.218

CONDUCTED RMS OUTPUT POWER (AMR, HSDPA INACTIVE)					
CHANNEL NO.	FREQUENCY (MHz)	RAW VALUE (dBm)	CORRECTION FACTOR (dB)	RMS OUTPUT POWER	
				dBm	Watt
4132	826.4	22.66	0.50	23.16	0.207
4182	836.4	22.82	0.50	23.32	0.215
4233	846.6	22.84	0.50	23.34	0.216

CONDUCTED RMS OUTPUT POWER (RMC, HSDPA ACTIVE)					
CHANNEL NO.	FREQUENCY (MHz)	RAW VALUE (dBm)	CORRECTION FACTOR (dB)	RMS OUTPUT POWER	
				dBm	Watt
4132	826.4	21.82	0.50	22.32	0.171
4182	836.4	21.98	0.50	22.48	0.177
4233	846.6	21.96	0.50	22.46	0.176

REMARKS: 1. Peak Output Power (dBm) = Raw Value (dBm) + Correction Factor (dB).
 2. Correction Factor (dB) = Power Splitter Loss (dB) + Cable Loss (dB).



MODE	TX connected	POWER CONTROL LEVEL	0
INPUT POWER	120Vac, 60 Hz	DETECTOR FUNCTION	RMS
ENVIRONMENTAL CONDITIONS	25deg. C, 65%RH, 991hPa	TESTED BY	Brad Wu

ERP POWER (RMC, HSDPA INACTIVE)					
CHANNEL NO.	FREQUENCY (MHz)	RAW VALUE (dBm)	CORRECTION FACTOR (dB)	PEAK OUTPUT POWER	
				dBm	Watt
4132	826.4	-18.24	40.03	21.79	0.151
4182	836.4	-19.39	40.32	20.93	0.124
4233	846.6	-18.92	40.62	21.70	0.148

REMARKS: 1. Peak Output Power (dBm) = Raw Value (dBm) + Correction Factor (dB).
 2. Correction Factor (dB) = Receiver Antenna Gain (dBi) + Cable Loss (dB) + Free Space Loss (dB).

4.2 FREQUENCY STABILITY MEASUREMENT

4.2.1 LIMITS OF FREQUENCY STABILITY MEASUREMENT

According to the FCC part 2.4235 shall be tested the frequency stability. The rule is defined that "The frequency stability shall be sufficient to ensure that the fundamental emission stays within the authorized frequency block." The frequency error rate is according to the JTC standard that the frequency error rate shall be accurate to within 2.5ppm of the received frequency from the base station. The test extreme voltage is according to the 2.1055(d)(1) Vary primary supply voltage from 85 to 115 percent of the nominal value for other than hand carried battery equipment and the extreme temperature rule is comply with the 2.1055(a)(1) $-30^{\circ}\text{C} \sim 50^{\circ}\text{C}$.

4.2.2 TEST INSTRUMENTS

DESCRIPTION & MANUFACTURER	MODEL NO.	SERIAL NO.	CALIBRATED UNTIL
* ROHDE & SCHWARZ Spectrum Analyzer	FSP40	100041	Apr. 21, 2009
* Hewlett Packard RF cable	8120-6192	01428251	NA
* Suhner RF cable	Sucoflex104	204850/4	NA
* WIT Standard Temperature & Humidity Chamber	TH-4S-C	W981030	Jun. 25, 2009

- NOTE:**
1. The calibration interval of the above test instruments is 12 months. And the calibrations are traceable to NML/ROC and NIST/USA.
 2. "*" = These equipments are used for the final measurement.
 3. The test was performed in ADT RF OVEN room.

4.2.3 TEST PROCEDURE

- a. Because of the measure the carrier frequency under the condition of the AFC lock, it shall be used the mobile station in the GSM / WCDMA link mode. This is accomplished with the use of the R&S CMU200 / JRC NJZ-2000 simulator station. The oven room could control the temperatures and humidity. The GSM link channel is the 190 and the WCDMA link channel is the 4182.
- b. Power must be removed when changing from one temperature to another or one voltage to another voltage. Power warm up is at least 15 min and power applied should perform before recording frequency error.
- c. EUT is connected the external power supply to control the DC input power. The various Volts from the minimum 3.6Volts to 4.2Volts. Each step shall be record the frequency error rate.
- d. The temperature range step is 10 degrees in this test items. All temperature levels shall be hold the $\pm 0.5^{\circ}\text{C}$ during the measurement testing.
- e. The each temperature step shall be at least 0.5 hours, consider the EUT could be test under the stability condition.

NOTE: The frequency error was recorded frequency error from the GSM simulator.

4.2.4 TEST SETUP

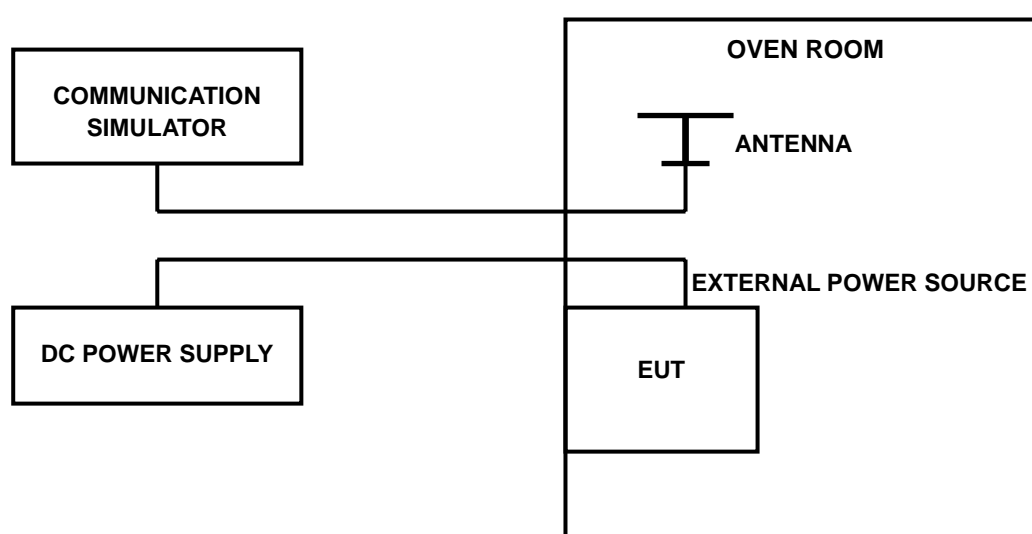



4.2.5 TEST RESULTS

FOR GSM BAND:

MODE	TX Mid. channel	POWER CONTROL LEVEL	5
INPUT POWER	120Vac, 60 Hz	ENVIRONMENTAL CONDITIONS	25deg. C, 65%RH, 991hPa
TESTED BY	Brad Wu		

AFC FREQUENCY ERROR vs. VOLTAGE			
VOLTAGE (Volts)	FREQUENCY ERROR (Hz)	FREQUENCY ERROR (ppm)	LIMIT (ppm)
4.2	-5	-0.0059765718	2.5
3.6	-1	-0.0011953144	2.5

NOTE: The applicant defined the normal working voltage of the battery is from 3.6Vdc to 4.2Vdc.

AFC FREQUENCY ERROR vs. TEMP.			
TEMP. (°C)	FREQUENCY ERROR (Hz)	FREQUENCY ERROR (ppm)	LIMIT (ppm)
50	-6	-0.0071718862	2.5
40	-3	-0.0035859431	2.5
30	-1	-0.0011953144	2.5
20	0	0.0000000000	2.5
10	2	0.0023906287	2.5
0	5	0.0059765718	2.5
-10	6	0.0071718862	2.5
-20	8	0.0095625149	2.5
-30	3	0.0035859431	2.5



FOR WCDMA BAND:

MODE	TX Mid. channel	POWER CONTROL LEVEL	0
INPUT POWER	120Vac, 60 Hz	ENVIRONMENTAL CONDITIONS	25deg. C, 65%RH, 991hPa
TESTED BY	Brad Wu		

AFC FREQUENCY ERROR vs. VOLTAGE			
VOLTAGE (Volts)	FREQUENCY ERROR (Hz)	FREQUENCY ERROR (ppm)	LIMIT (ppm)
4.2	7	0.0083692013	2.5
3.6	11	0.0131516021	2.5

AFC FREQUENCY ERROR vs. TEMP.			
TEMP. (°C)	FREQUENCY ERROR (Hz)	FREQUENCY ERROR (ppm)	LIMIT (ppm)
50	3	0.0035868006	2.5
40	5	0.0059780010	2.5
30	8	0.0095648015	2.5
20	10	0.0119560019	2.5
10	12	0.0143472023	2.5
0	13	0.0155428025	2.5
-10	16	0.0191296031	2.5
-20	18	0.0215208034	2.5
-30	19	0.0227164036	2.5

4.3 OCCUPIED BANDWIDTH MEASUREMENT

4.3.1 LIMITS OF OCCUPIED BANDWIDTH MEASUREMENT

According to FCC 2.1049 (h) specified that emission bandwidth is defined as the width of the signal between two points, one below the carrier center frequency and one above the carrier center frequency, outside of which all emissions are attenuated at least 26 dB below the transmitter power.

4.3.2 TEST INSTRUMENTS

DESCRIPTION & MANUFACTURER	MODEL NO.	SERIAL NO.	CALIBRATED UNTIL
* ROHDE & SCHWARZ Spectrum Analyzer	FSP40	100041	Apr. 21, 2009
* Mini-Circuits Power Splitter	ZAPD-4	400005	NA
* Hewlett Packard RF cable	8120-6192	01428251	NA
* JFW 20dB attenuation	50HF-020-SMA	NA	NA
* Suhner RF cable	Sucoflex104	204850/4	NA

- NOTE:**
1. The calibration interval of the above test instruments is 12 months. And the calibrations are traceable to NML/ROC and NIST/USA.
 2. "*" = These equipments are used for the final measurement.

4.3.3 TEST SETUP

Same as Item 4.2.4 (Conducted Power Setup)

4.3.4 TEST PROCEDURES

- a. The EUT was set up for the maximum peak power with GSM / WCDMA link data modulation. The power was measured with R&S Spectrum Analyzer. All measurements were done at 3 channels, 128, 190 and 251 / 4132, 4182 and 4233 (low, middle and high operational frequency range.)
- b. The conducted occupied bandwidth used the power splitter via EUT RF power connector between simulation base station and spectrum analyzer. This splitter loss and cable loss is the worst loss 4.1dB (GSM band) / 4.1dB (WCDMA band) in the transmitted path track.
- c. FCC 2.1049 (h) required a measurement bandwidth is the fundamental emission below 26dB bandwidth.

4.3.5 EUT OPERATING CONDITION

- a. The EUT makes a phone call to the communication simulator.
- b. The communication simulator station system controlled an EUT to export maximum and minimum output power under transmission mode and specific channel frequency.

4.3.6 TEST RESULTS

FOR GSM BAND:

FOR GSM MODE

CHANNEL	MAX. OUTPUT POWER -26 dBc BANDWIDTH (kHz)
LOW	317.84
MIDDLE	314.56
HIGH	311.29

LOW CHANNEL

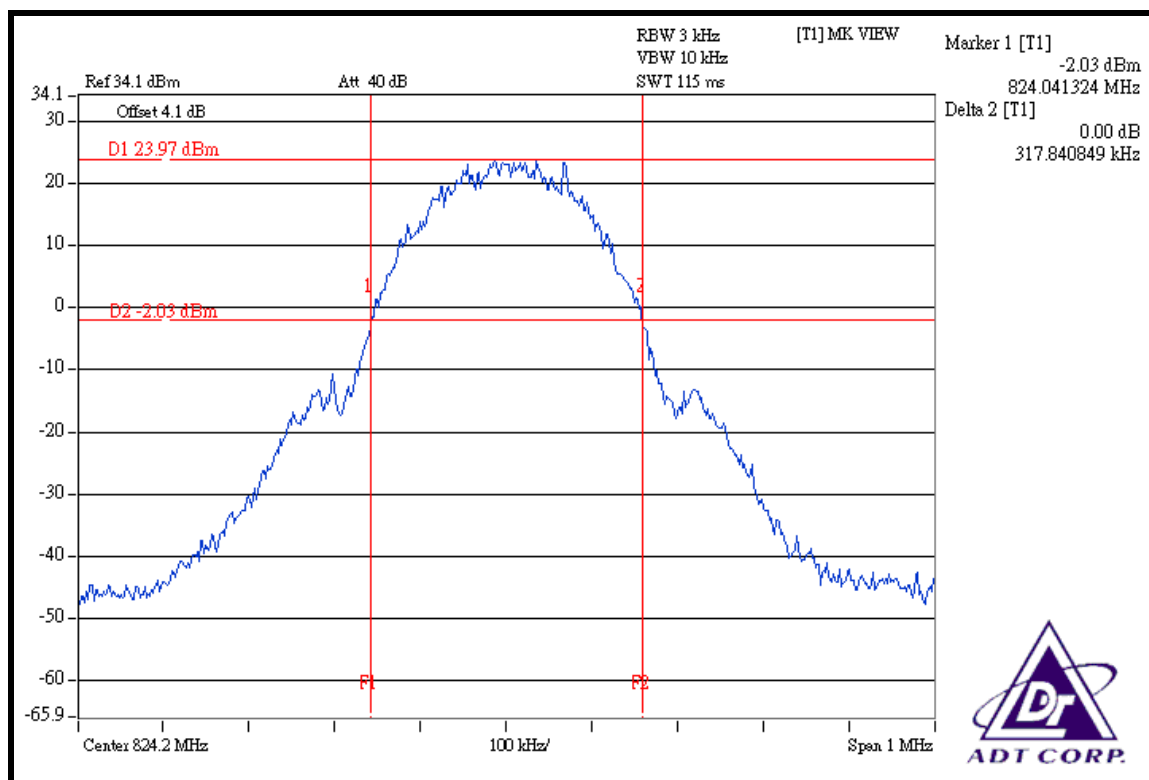



MIDDLE CHANNEL

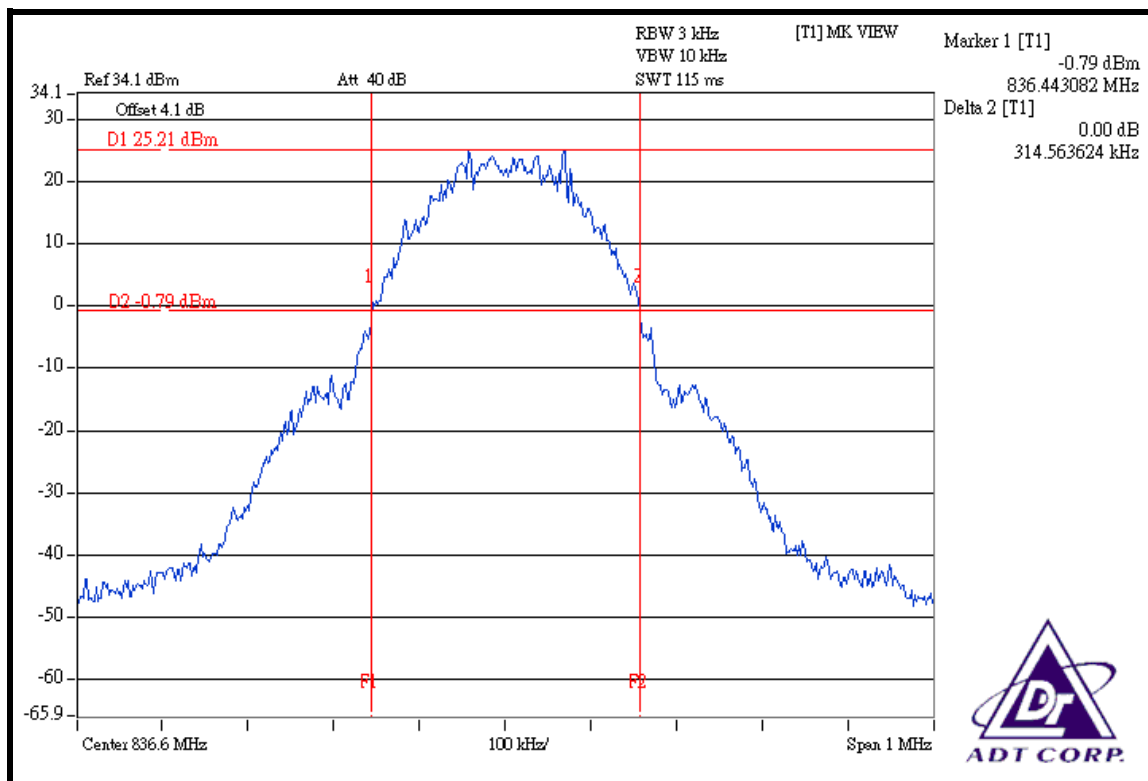

HIGH CHANNEL

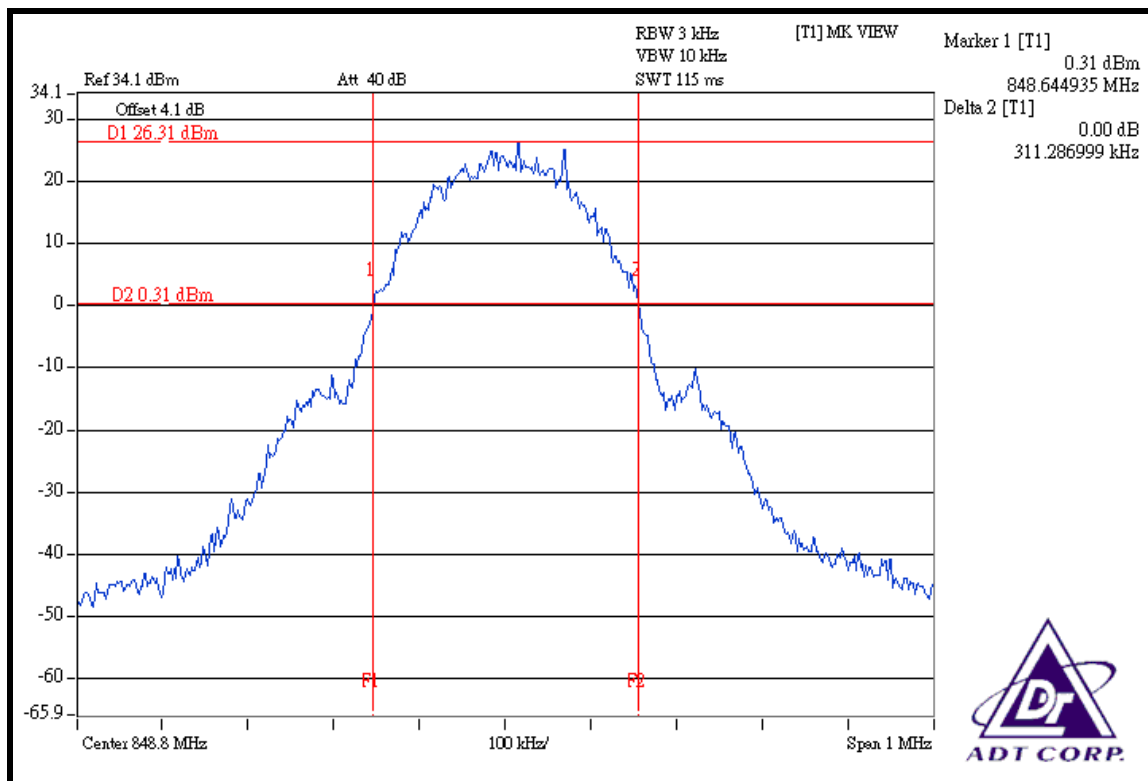

FOR GPRS MODE (UP-LINK WITH 1 TIME SLOT)

CHANNEL	MAX. OUTPUT POWER -26 dBc BANDWIDTH (kHz)
LOW	313.60
MIDDLE	315.21
HIGH	316.51

LOW CHANNEL

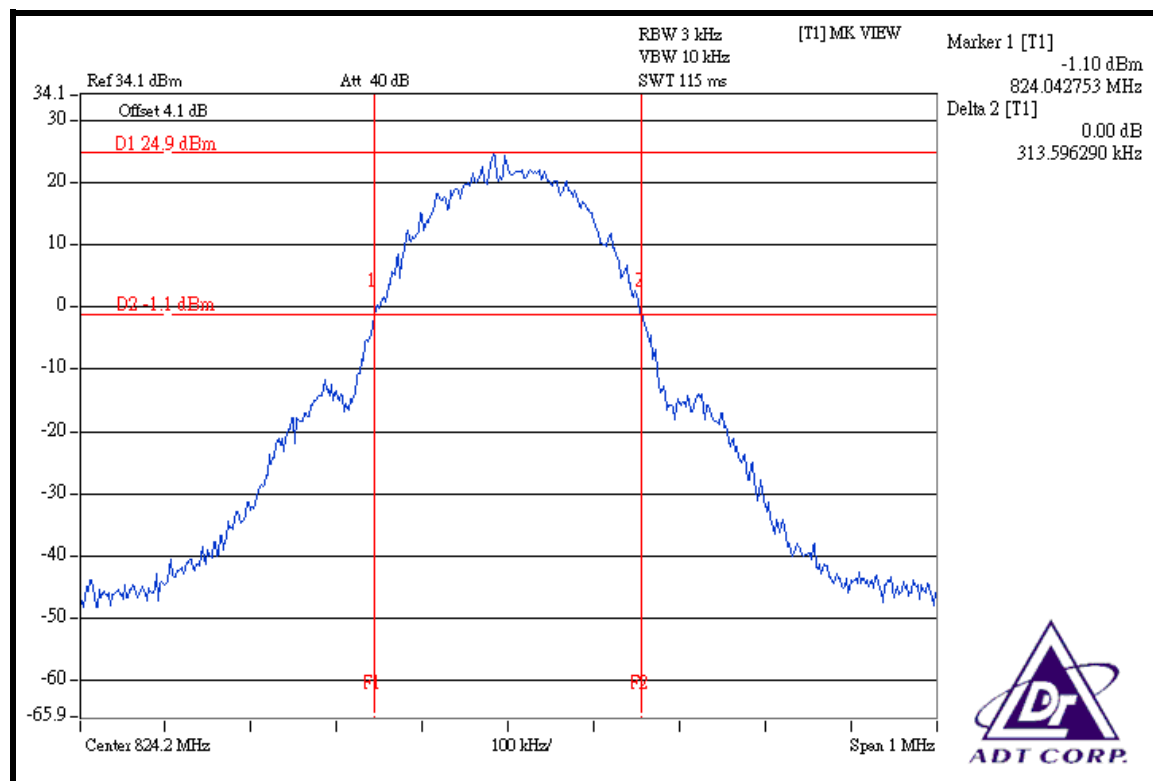



MIDDLE CHANNEL

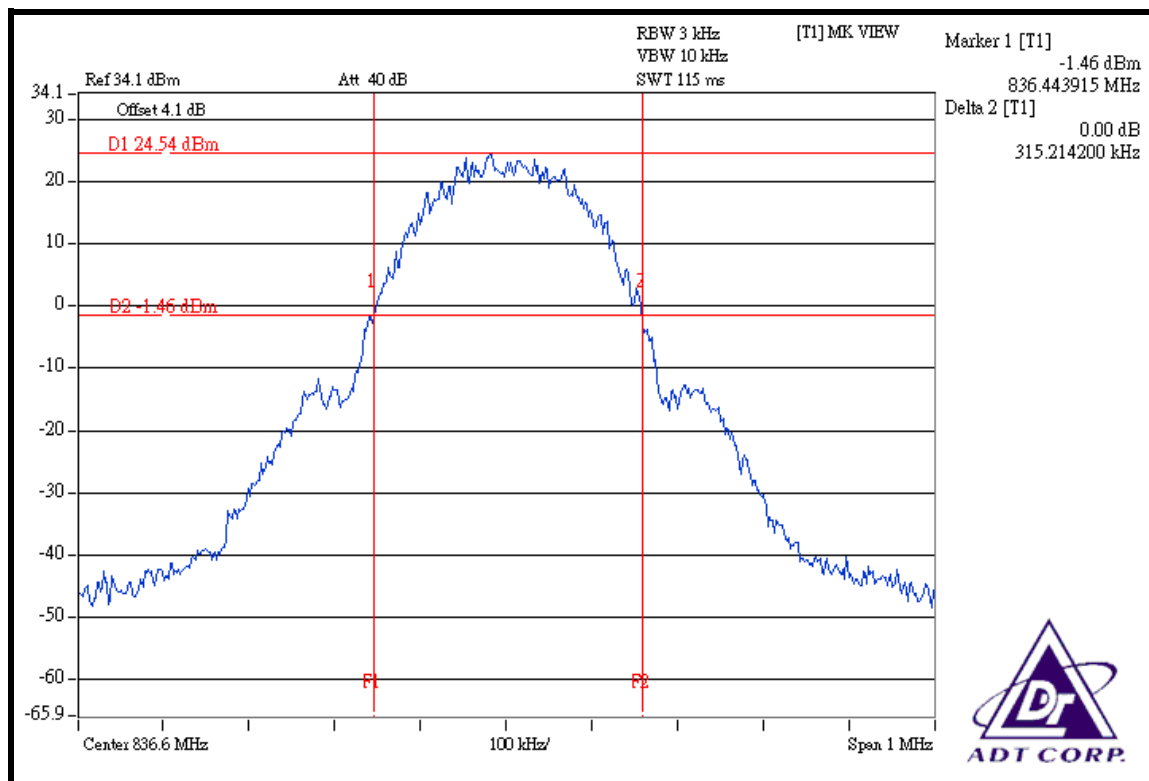

HIGH CHANNEL

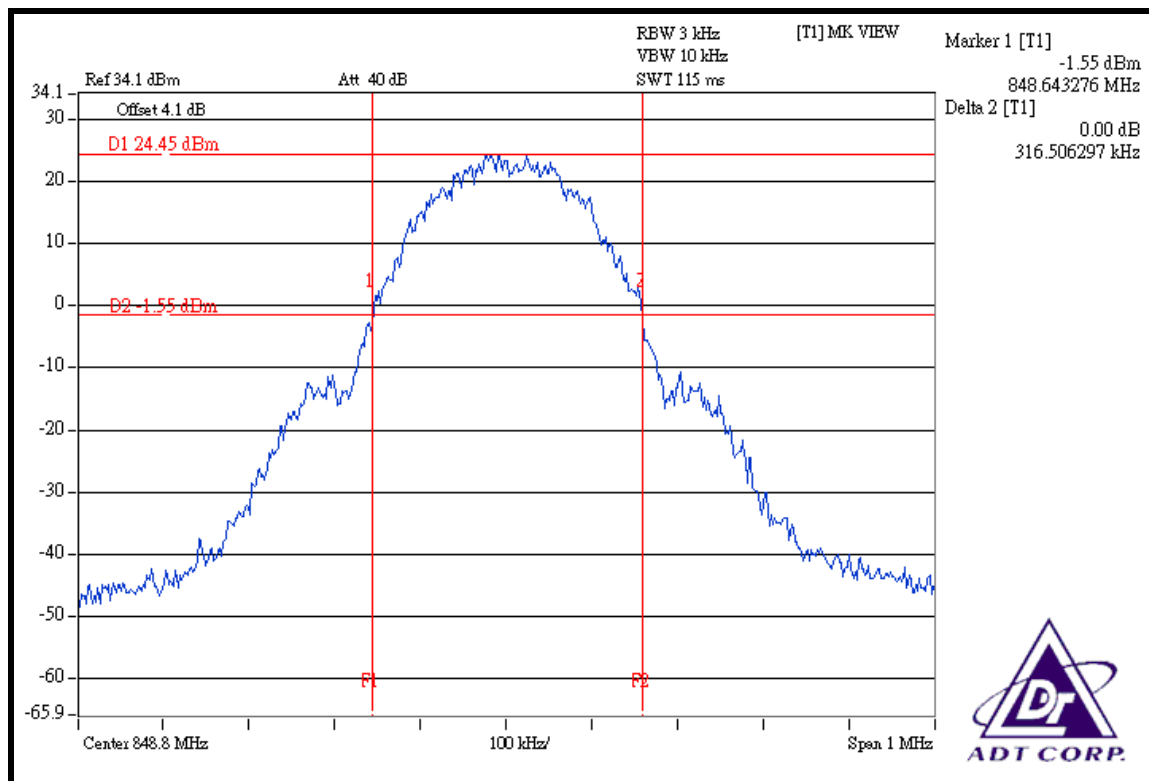

FOR E-GPRS MODE (UP-LINK WITH 1 TIME SLOT)

CHANNEL	MAX. OUTPUT POWER -26 dBc BANDWIDTH (kHz)
LOW	311.61
MIDDLE	314.22
HIGH	314.36

LOW CHANNEL

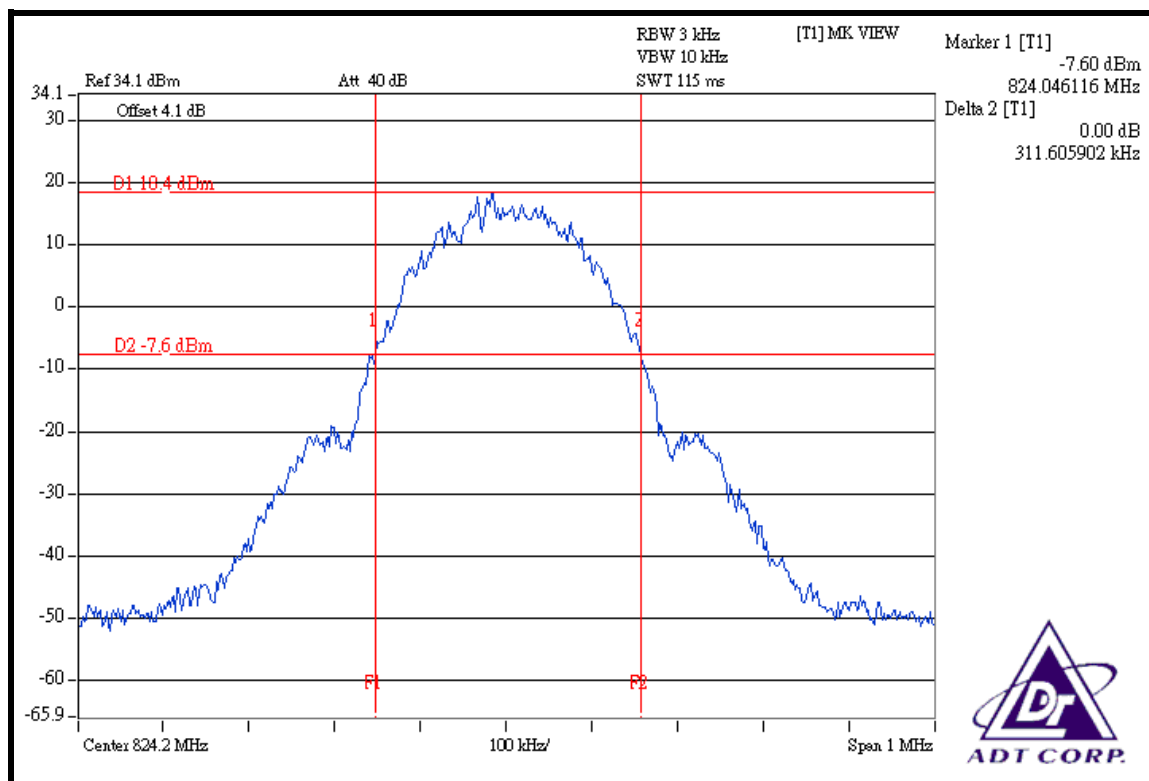

MIDDLE CHANNEL

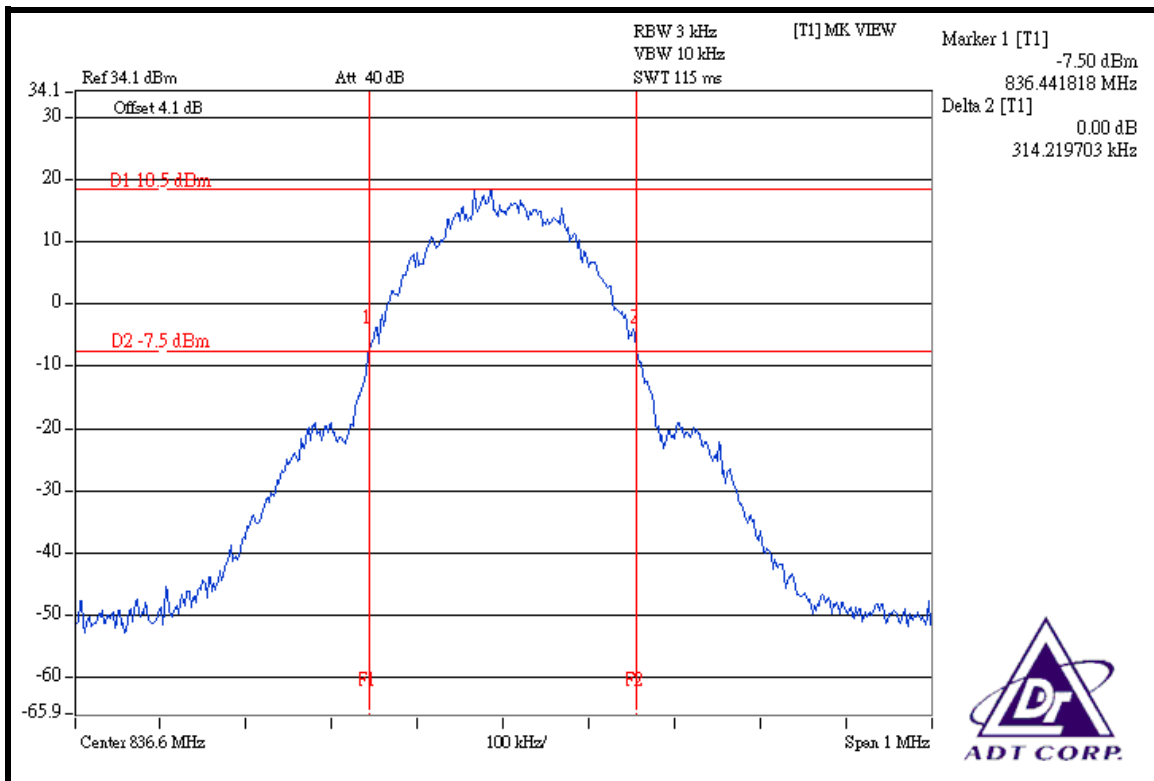

HIGH CHANNEL

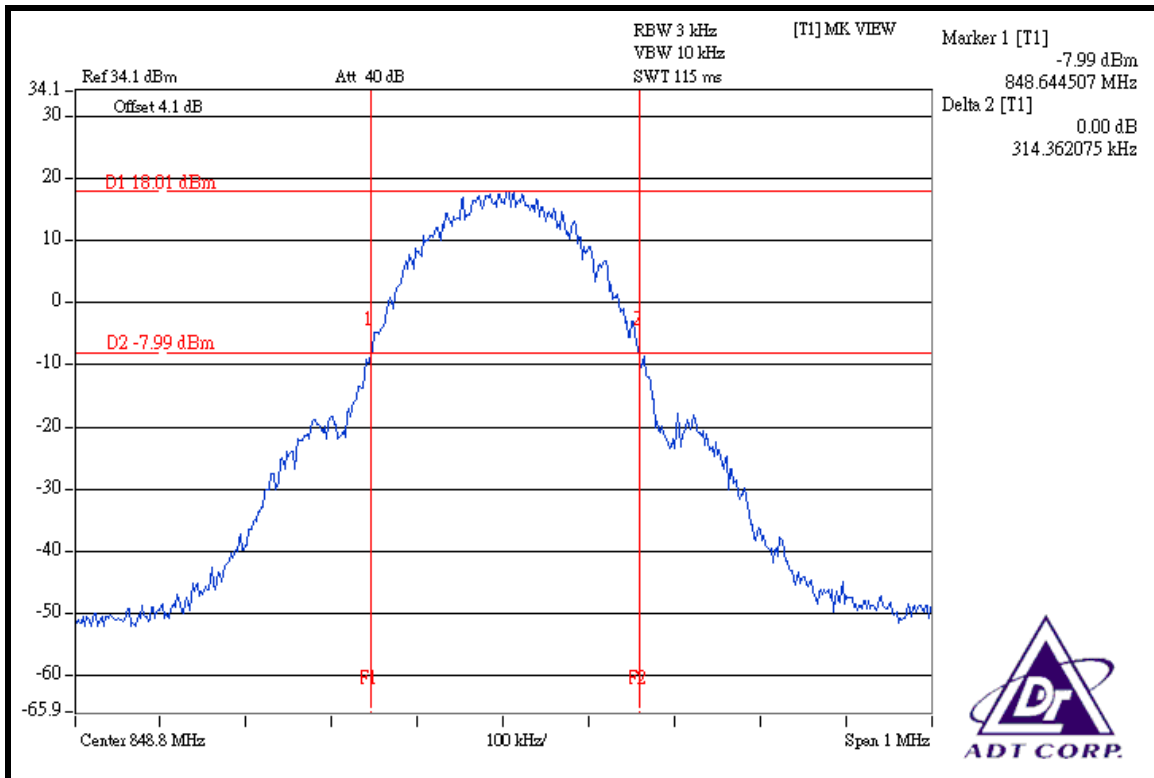

FOR WCDMA BAND:

CHANNEL	MAX. OUTPUT POWER -26 dBc BANDWIDTH (MHz)
LOW	4.69
MIDDLE	4.69
HIGH	4.69

LOW CHANNEL

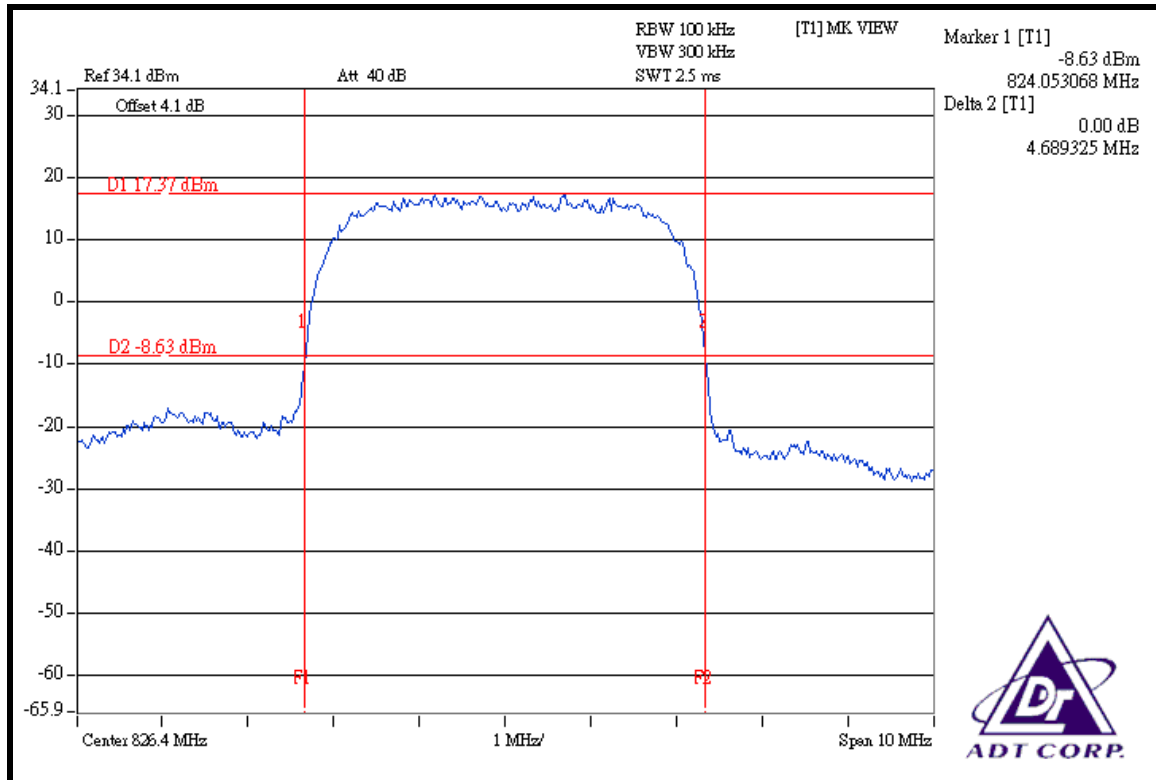

MIDDLE CHANNEL

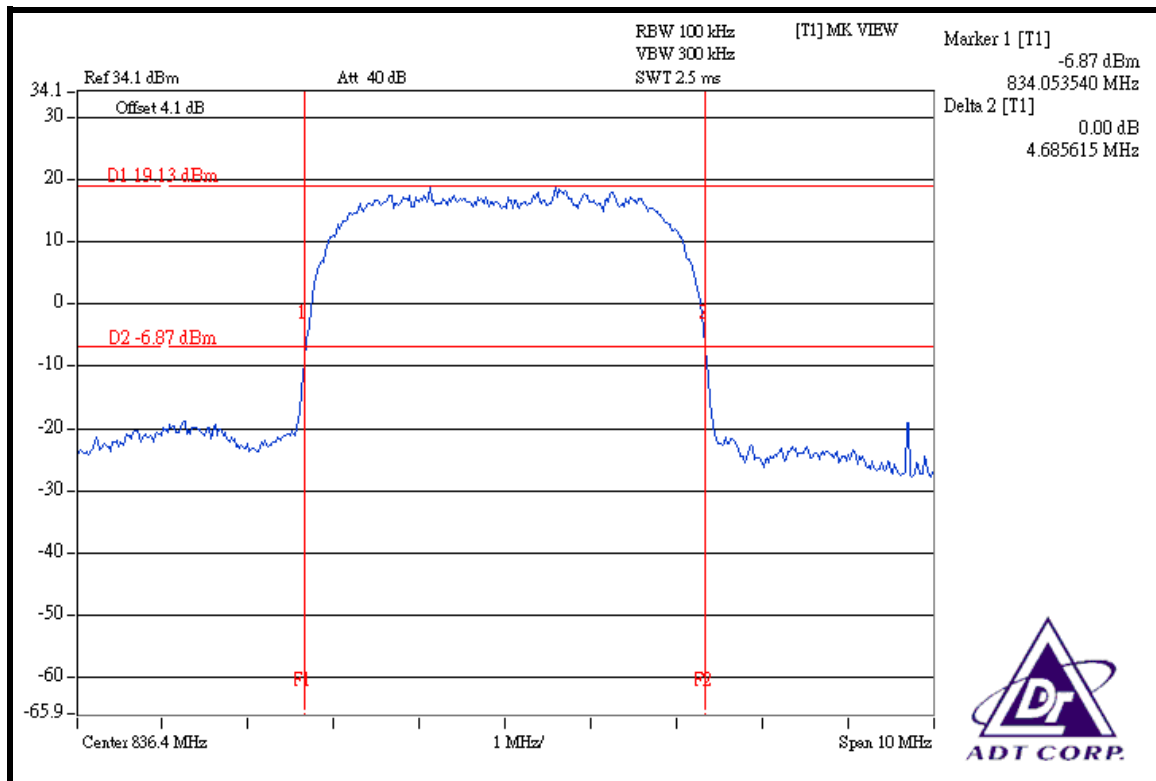

HIGH CHANNEL

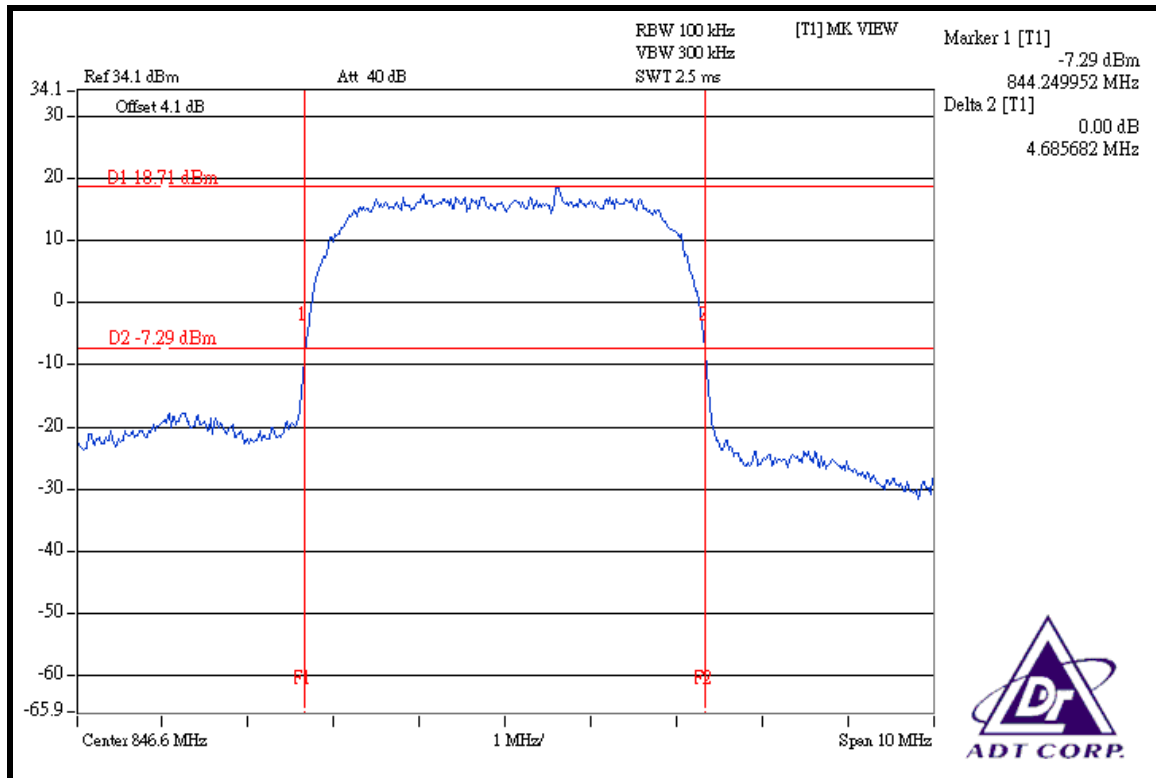

4.4 BAND EDGE MEASUREMENT

4.4.1 LIMITS OF BAND EDGE MEASUREMENT

According to FCC 22.917 specified that power of any emission outside of the authorized operating frequency ranges must be attenuated below the transmitting power (P) by a factor of at least $43 + 10 \log(P)$ dB. In the 1 MHz bands immediately outside and adjacent to the frequency block a resolution bandwidth of at least one percent of the emission bandwidth of the fundamental emission of the transmitter may be employed.

4.4.2 TEST INSTRUMENTS

DESCRIPTION & MANUFACTURER	MODEL NO.	SERIAL NO.	CALIBRATED UNTIL
* ROHDE & SCHWARZ Spectrum Analyzer	FSP40	100041	Apr. 21, 2009
* Mini-Circuits Power Splitter	ZAPD-4	400005	NA
* Hewlett Packard RF cable	8120-6192	01428251	NA
* JFW 20dB attenuation	50HF-020-SMA	NA	NA
* Suhner RF cable	Sucoflex104	204850/4	NA

- NOTE:**
1. The calibration interval of the above test instruments is 12 months. And the calibrations are traceable to NML/ROC and NIST/USA.
 2. "*" = These equipments are used for the final measurement.

4.4.3 TEST SETUP

Same as Item 4.2.4 (Conducted Power Setup)

4.4.4 TEST PROCEDURES

- a. The EUT was set up for the maximum peak power with GSM / WCDMA link data modulation. The power was measured with R&S Spectrum Analyzer. All measurements were done at 2 channels, 128 and 251 / 4132 and 4233 (low and high operational frequency range.)
- b. The band edge measurement used the power splitter via EUT RF power connector between simulation base station and spectrum analyzer. This splitter loss and cable loss is the worst loss 4.1dB (GSM band) / 4.1dB (WCDMA band) in the transmitted path track.
- c. The center frequency of spectrum is the band edge frequency and span is 1.5 MHz. RB of the spectrum is 3kHz and VB of the spectrum is 10kHz (for GSM band).
- d. The center frequency of spectrum is the band edge frequency and span is 10MHz. RB of the spectrum is 100kHz and VB of the spectrum is 300kHz (for WCDMA band).
- e. Record the max trace plot into the test report.

4.4.5 EUT OPERATING CONDITION

- a. The EUT makes a phone call to the communication simulator.
- b. The communication simulator station system controlled an EUT to export maximum output power under transmission mode and specific channel frequency.

4.4.6 TEST RESULTS

FOR GSM BAND: FOR GSM MODE

LOWER BAND EDGE

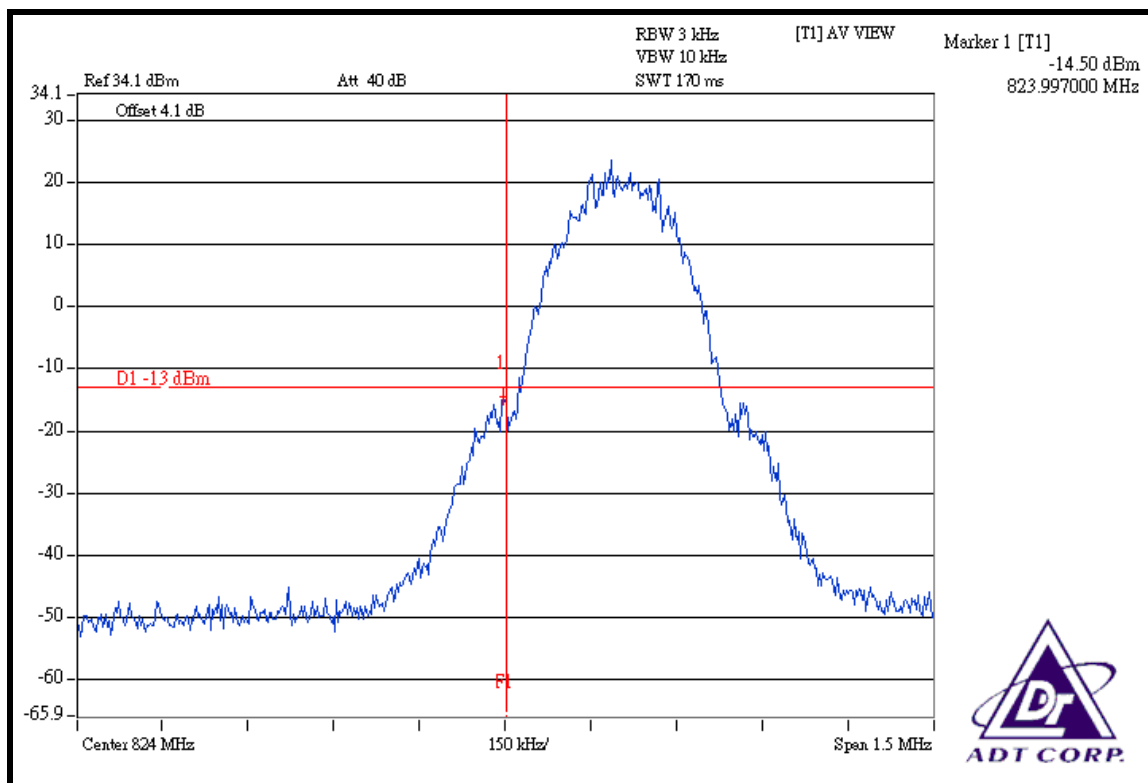

HIGHER BAND EDGE

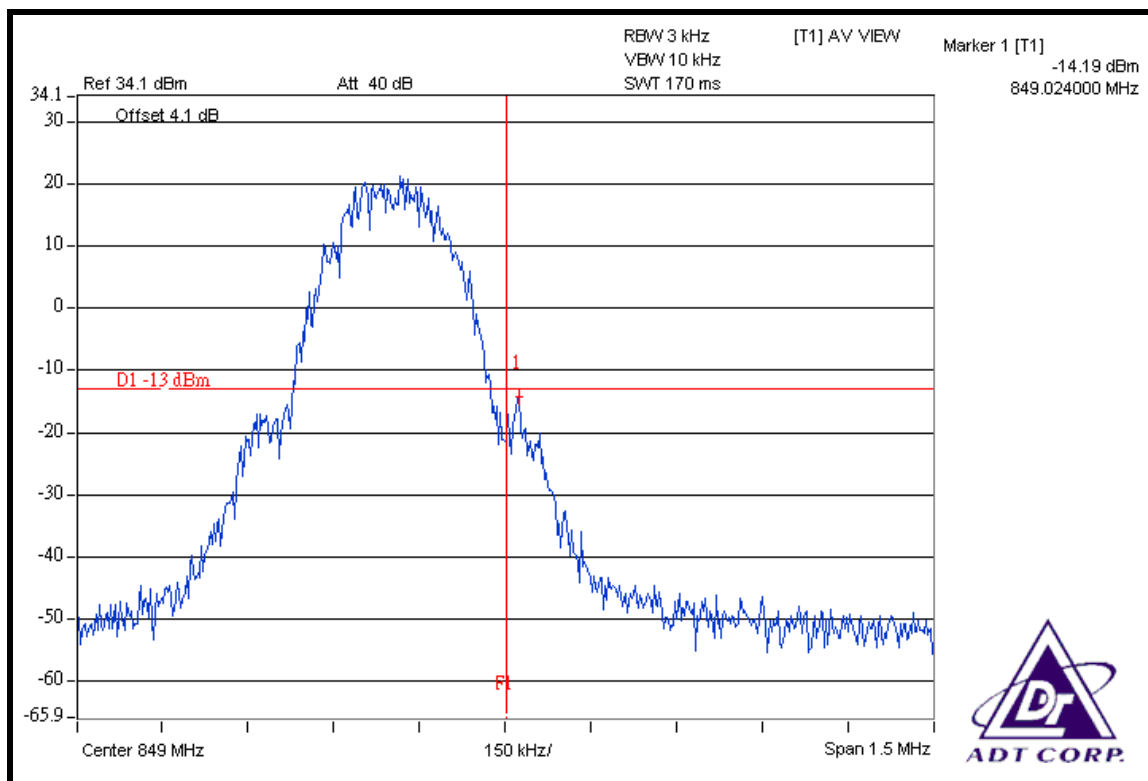



FOR GPRS MODE (UP-LINK WITH 1 TIME SLOT)
LOWER BAND EDGE

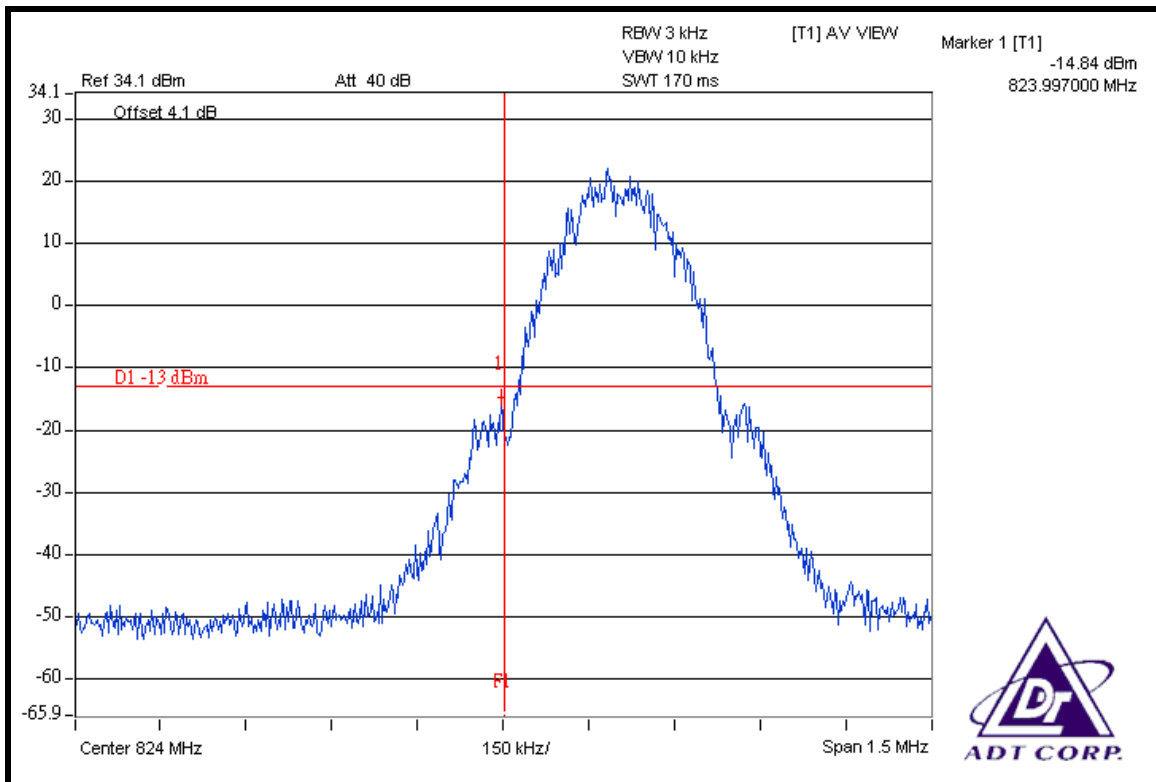

HIGHER BAND EDGE

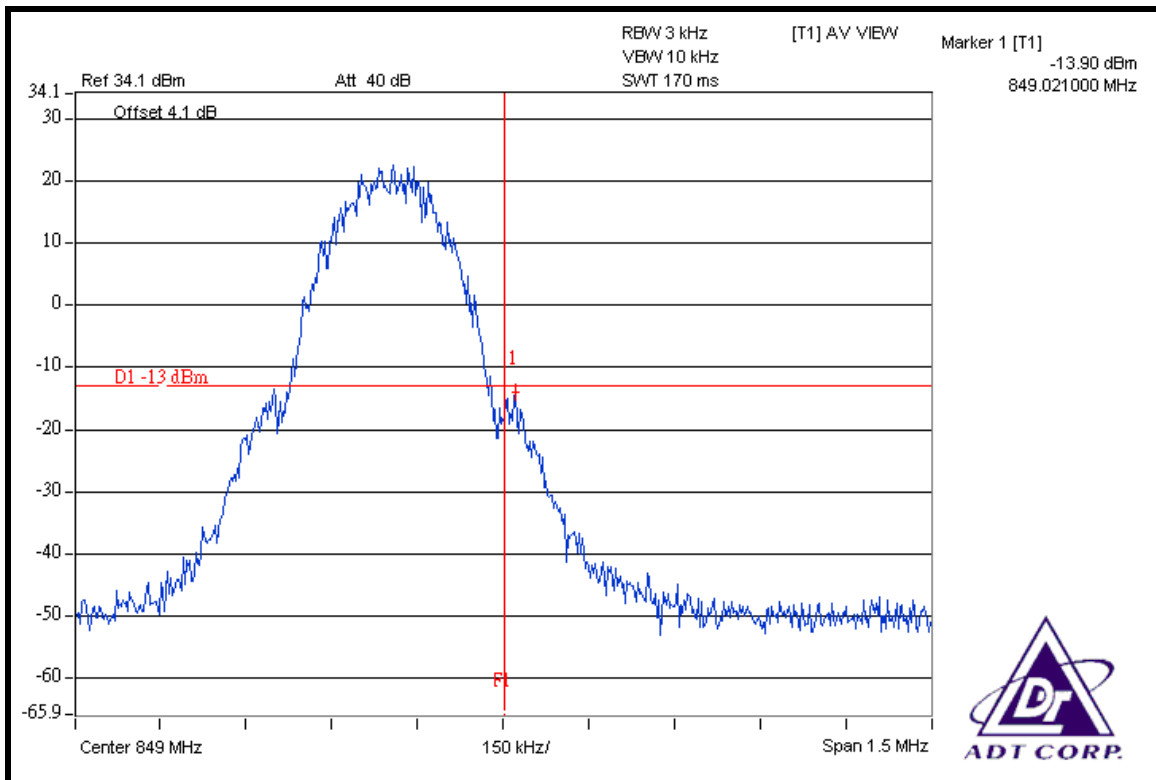



FOR E-GPRS MODE (UP-LINK WITH 1 TIME SLOT)

LOWER BAND EDGE

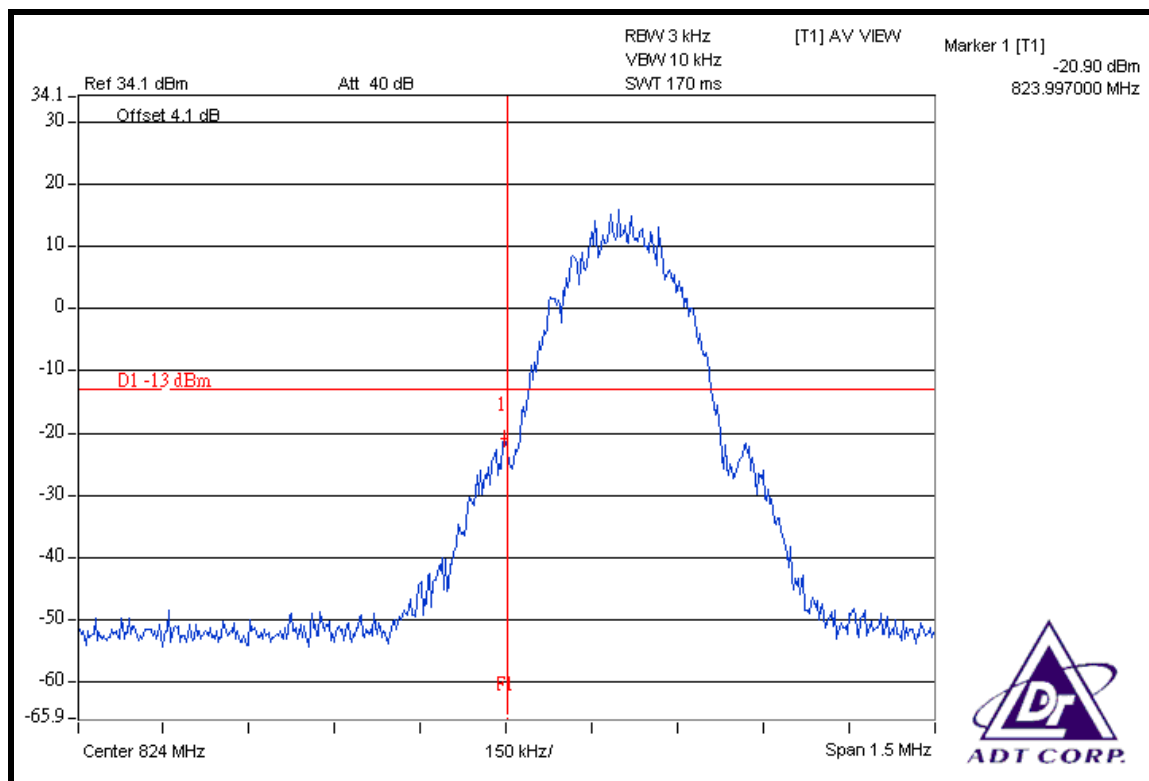

HIGHER BAND EDGE

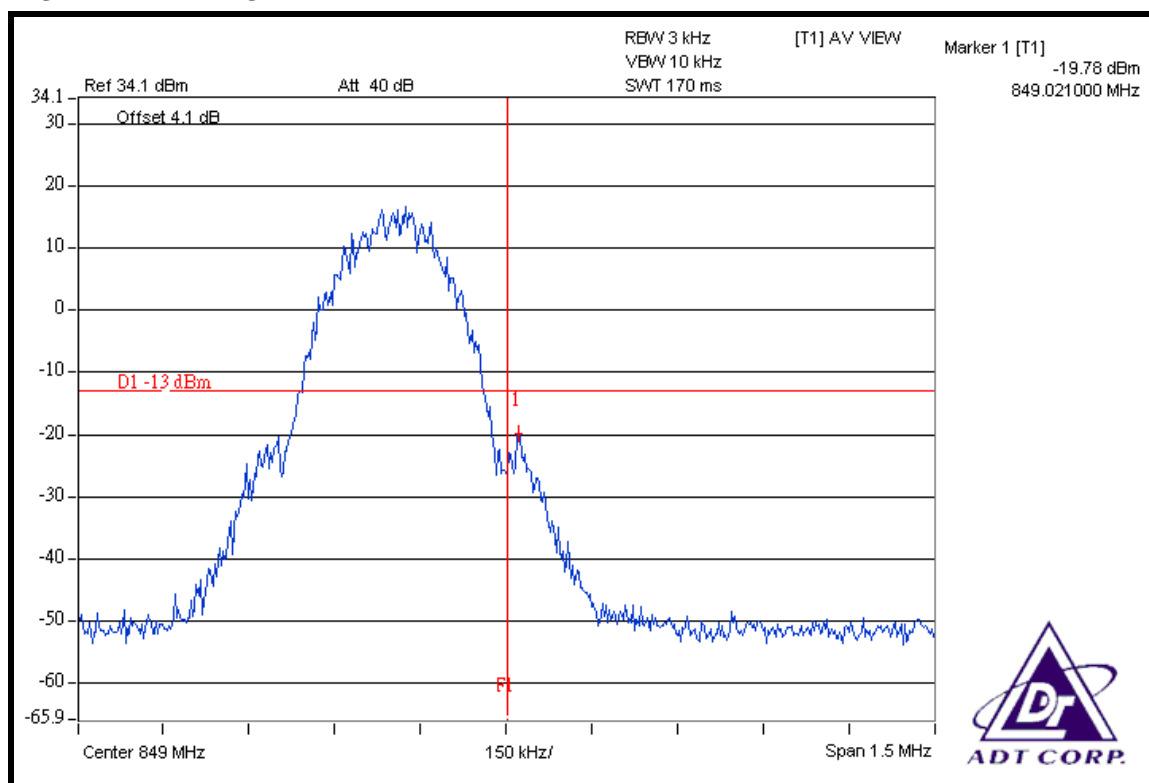



**FOR WCDMA BAND:
LOWER BAND EDGE**

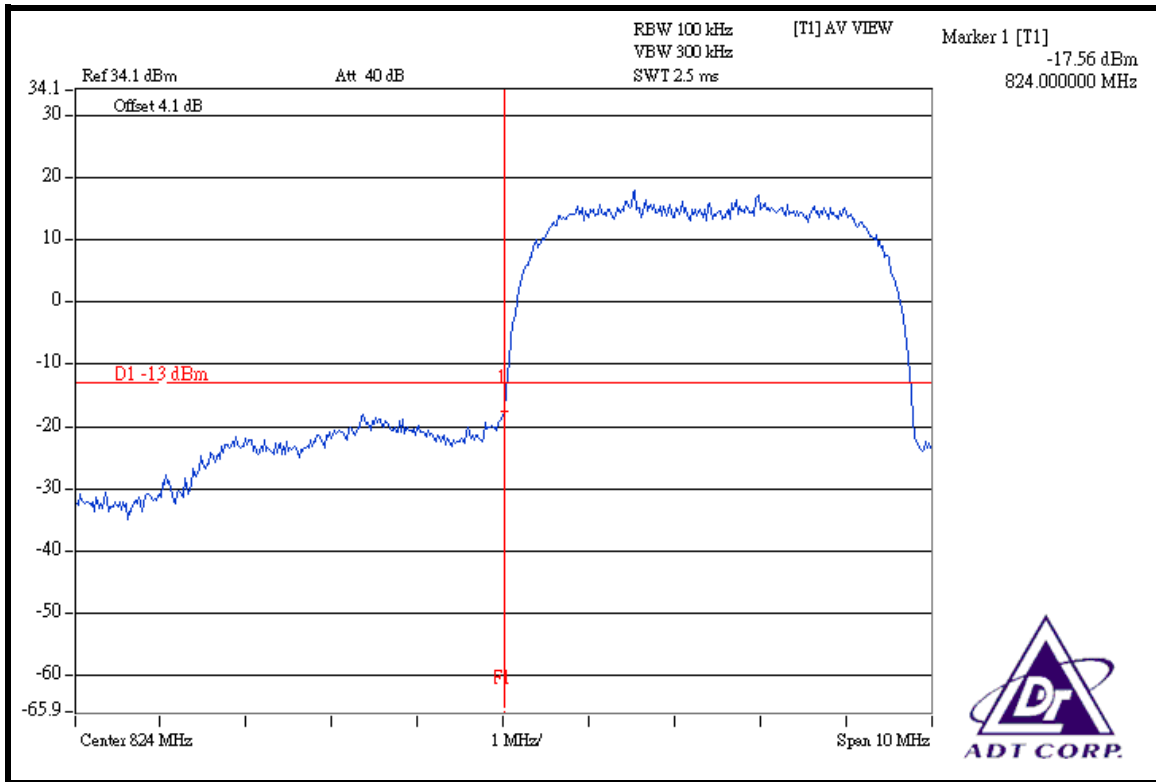

HIGHER BAND EDGE

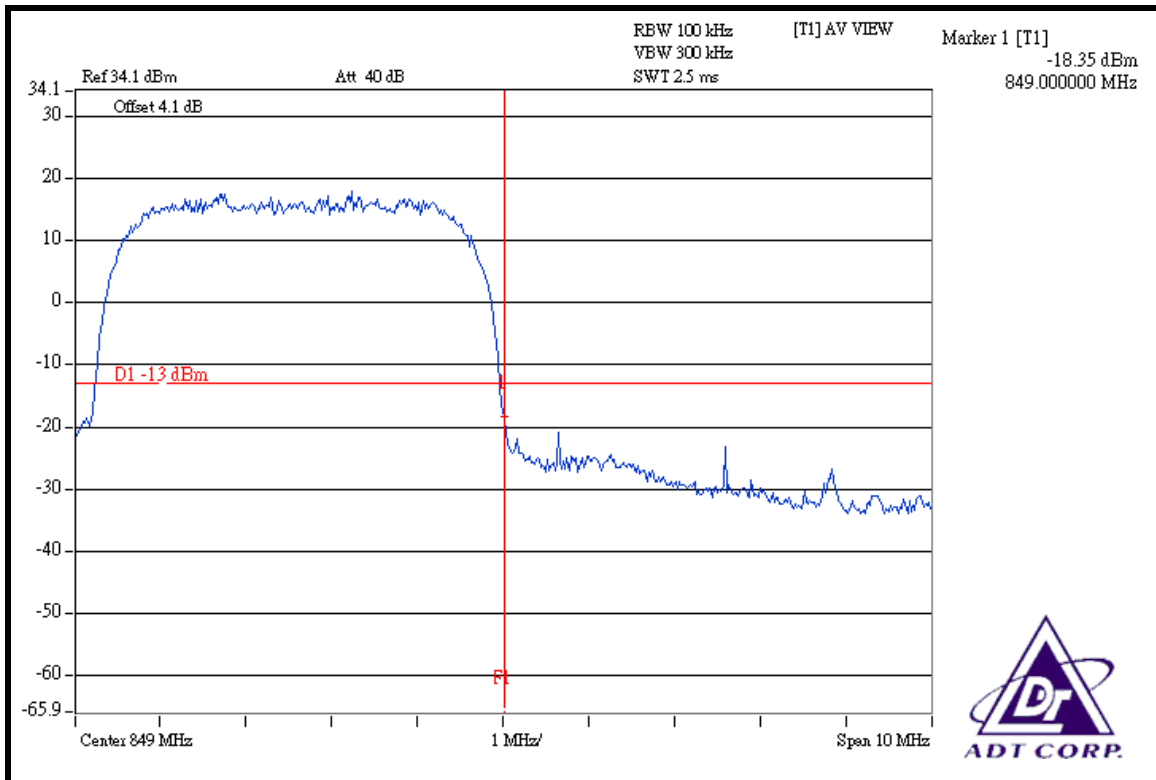

4.5 CONDUCTED SPURIOUS EMISSIONS

4.5.1 LIMITS OF CONDUCTED SPURIOUS EMISSIONS MEASUREMENT

In the FCC 22.917, On any frequency outside a licensee's frequency block within GSM spectrum, the power of any emission shall be attenuated below the transmitter power (P) by at least $43 + 10 \log (P)$ dB. The emission limit equal to -13dBm .

4.5.2 TEST INSTRUMENTS

DESCRIPTION & MANUFACTURER	MODEL NO.	SERIAL NO.	CALIBRATED UNTIL
* ROHDE & SCHWARZ Spectrum Analyzer	FSP40	100041	Apr. 21, 2009
* Wainwright Instruments Band Reject Filter	WRCG1850/1910-183 0/1930-60/10SS	SN1	NA
* Wainwright Instruments High Pass Filter	WHK3.1/18G-10SS	SN1	NA
* Mini-Circuits Power Splitter	ZAPD-4	400005	NA
* Hewlett Packard RF cable	8120-6192	01428251	NA
* JFW 20dB attenuation	50HF-020-SMA	NA	NA
* Suhner RF cable	Sucoflex104	204850/4	NA

- NOTE:**
1. The calibration interval of the above test instruments is 12 months. And the calibrations are traceable to NML/ROC and NIST/USA.
 2. "*" = These equipments are used for the final measurement.

4.5.3 TEST PROCEDURE

- a. The EUT was set up for the maximum peak power with GSM / WCDMA link data modulation. The power was measured with R&S Spectrum Analyzer. All measurements were done at 3 channels, 128, 190 and 251 / 4132, 4182 and 4233 (low, middle and high operational frequency range.)
- b. The conducted spurious emission used the power splitter via EUT RF power connector between simulation base station and spectrum analyzer. This splitter loss and cable loss are the worst loss 4.1dB (GSM band) / 4.1dB (WCDMA band) in the transmitted path track.
- c. When the spectrum scanned from 9kHz to 1GHz, it shall be connected to the band reject filter attenuated the carried frequency. The spectrum set RB=1MHz, VB=3MHz (GSM band) / RB=1MHz, VB=1MHz (WCDMA band).
- d. When the spectrum scanned from 1GHz to 9GHz, it shall be connected to the high pass filter attenuated the carried frequency. The spectrum set RB=1MHz, VB=3MHz (GSM band) / RB=1MHz, VB=1MHz (WCDMA band).

4.5.4 TEST SETUP

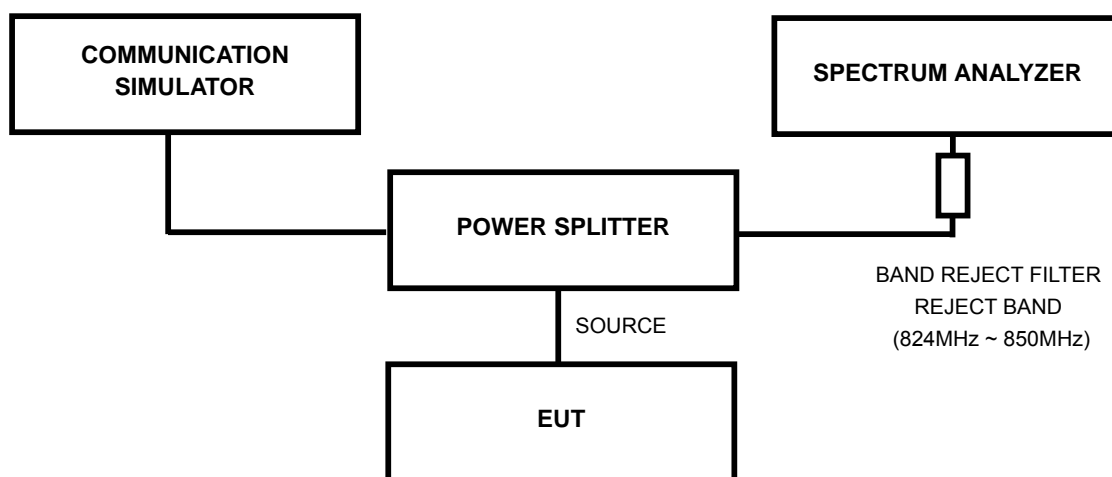

4.5.5 EUT OPERATING CONDITIONS

- a. The EUT makes a phone call to the communication simulator.
- b. The communication simulator station system controlled an EUT to export maximum output power under transmission mode and specific channel frequency.

4.5.6 TEST RESULTS

FOR GSM BAND:

CH 128: 9kHz ~ 1GHz

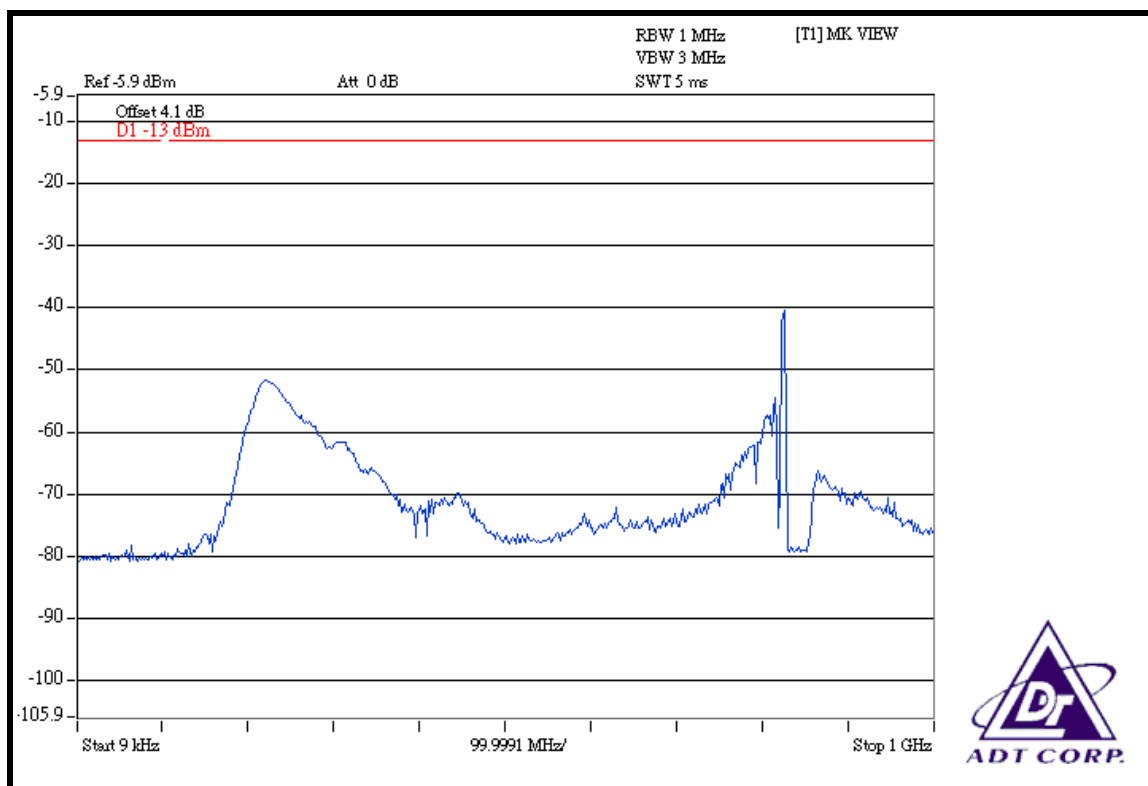

1GHz ~ 4GHz

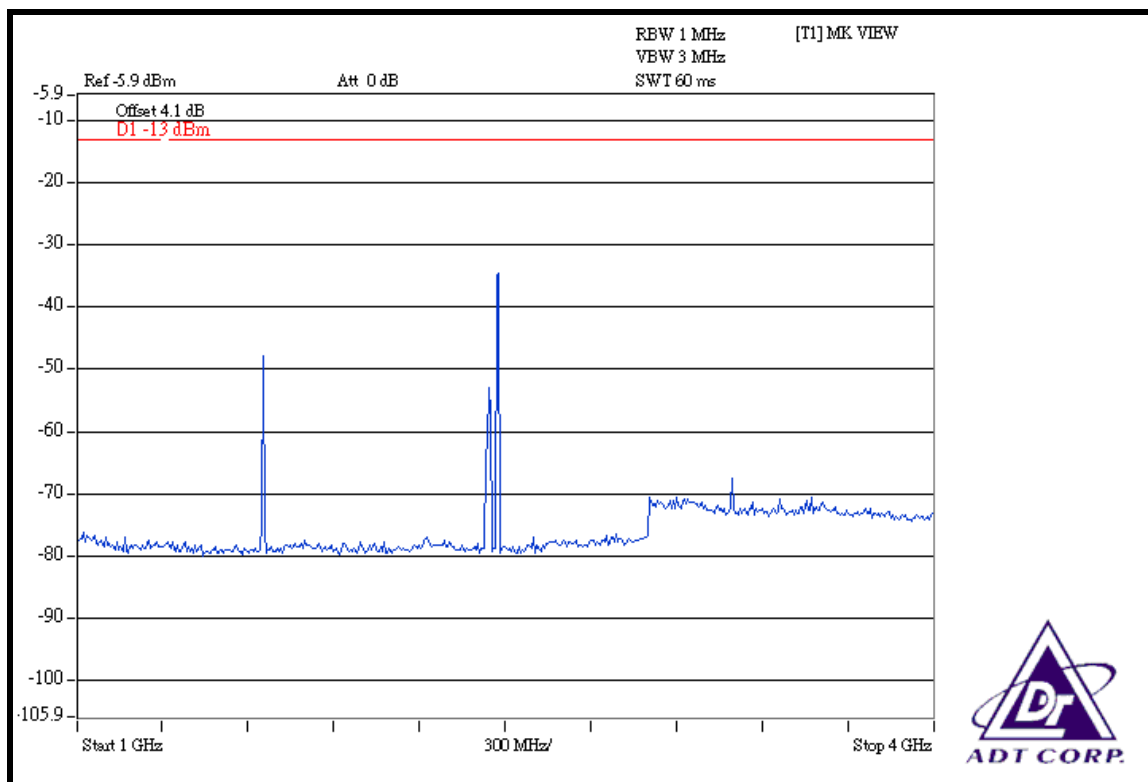



4GHz ~ 7GHz

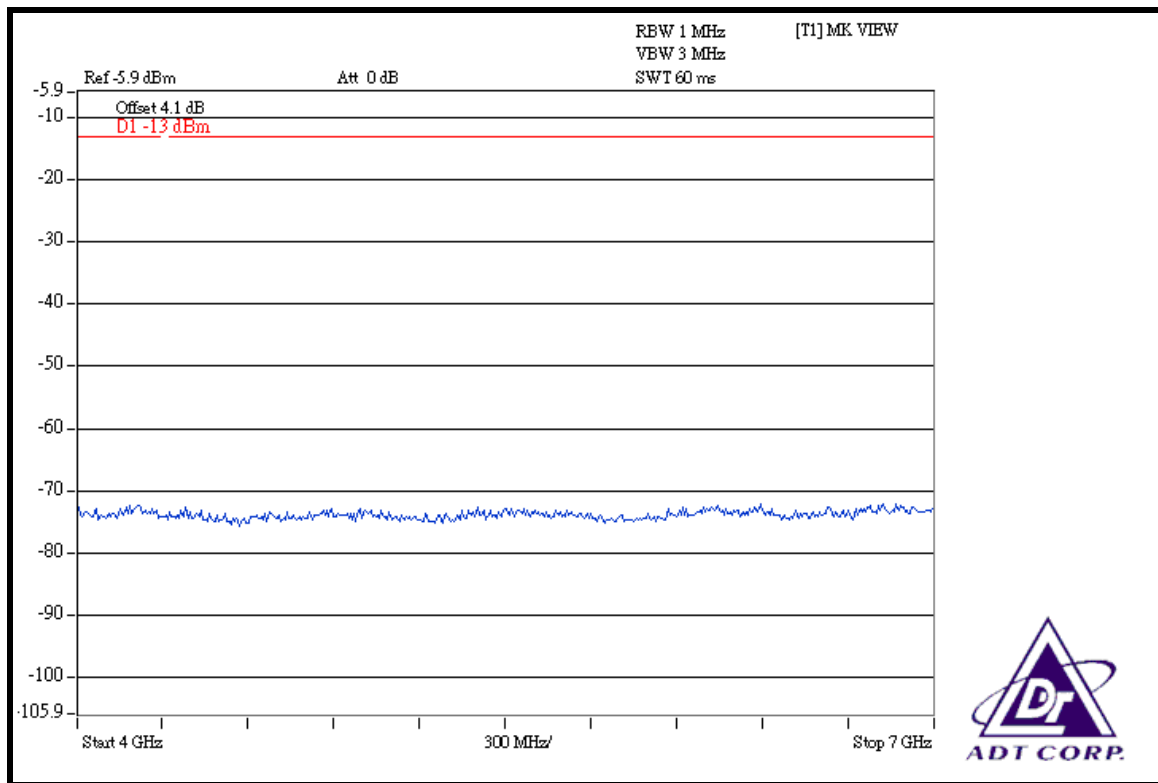

7GHz ~ 9GHz

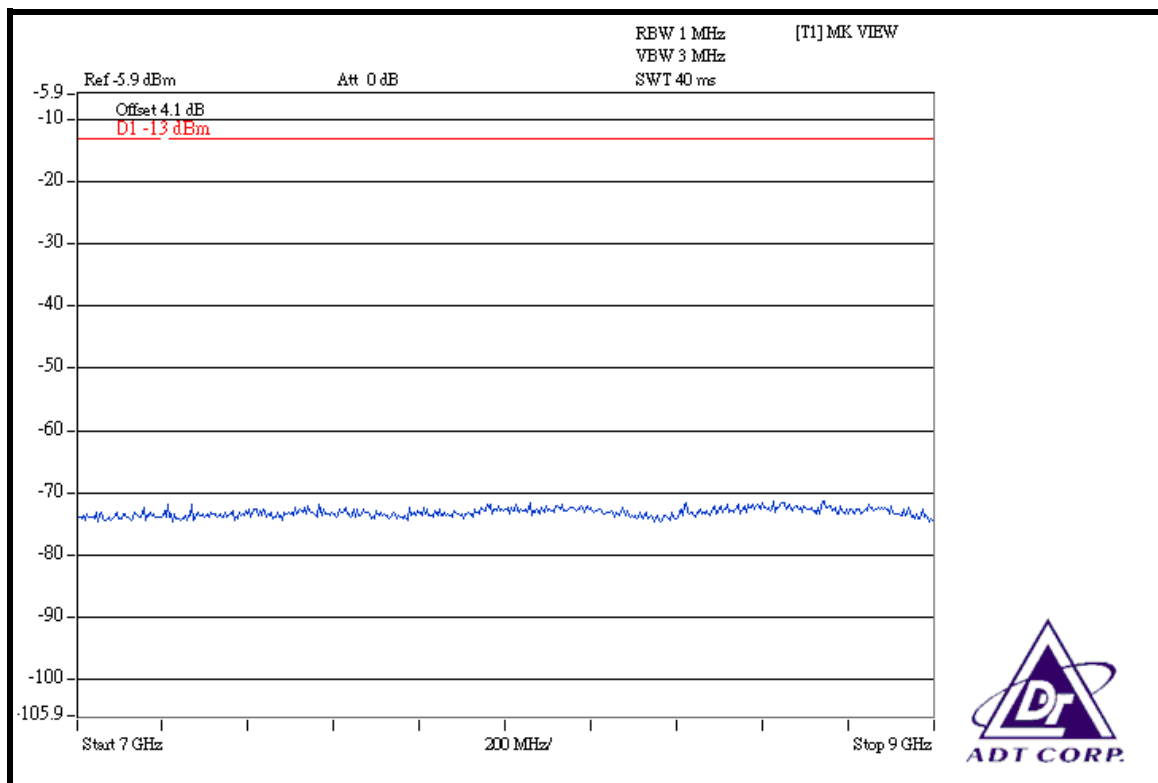

CH 190:
9kHz ~ 1GHz

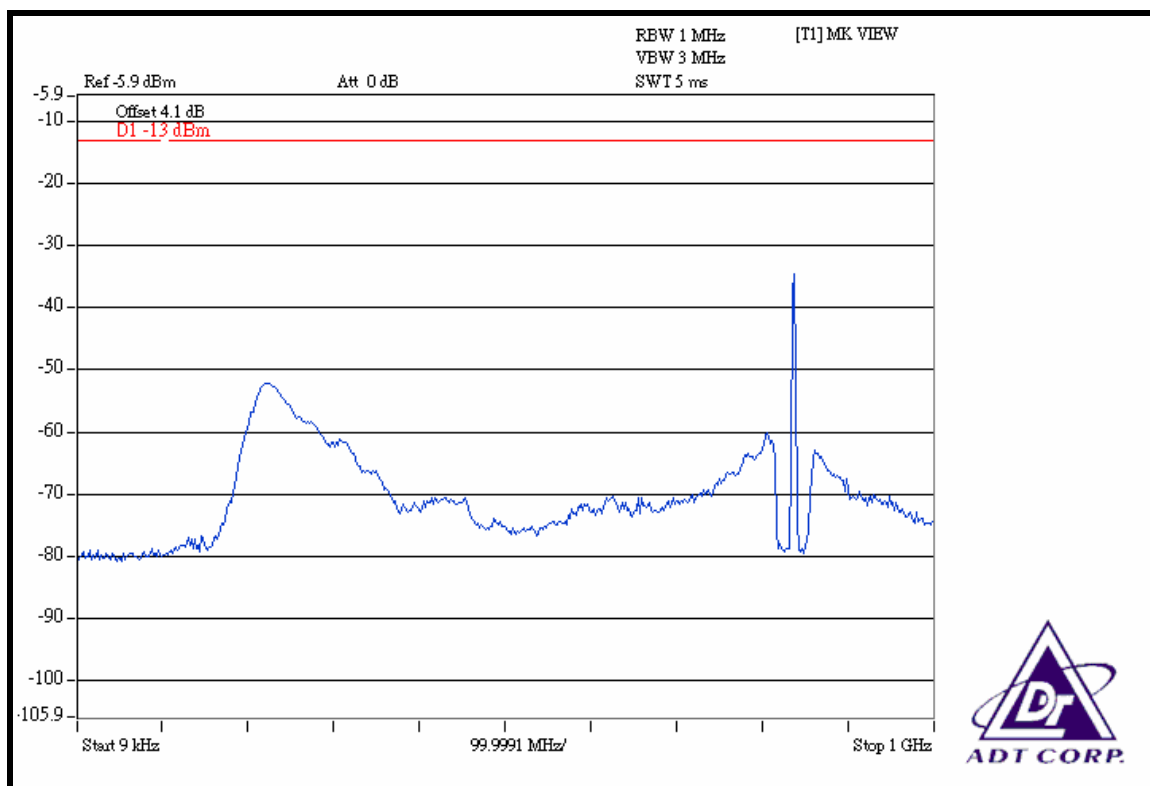

1GHz ~ 4GHz

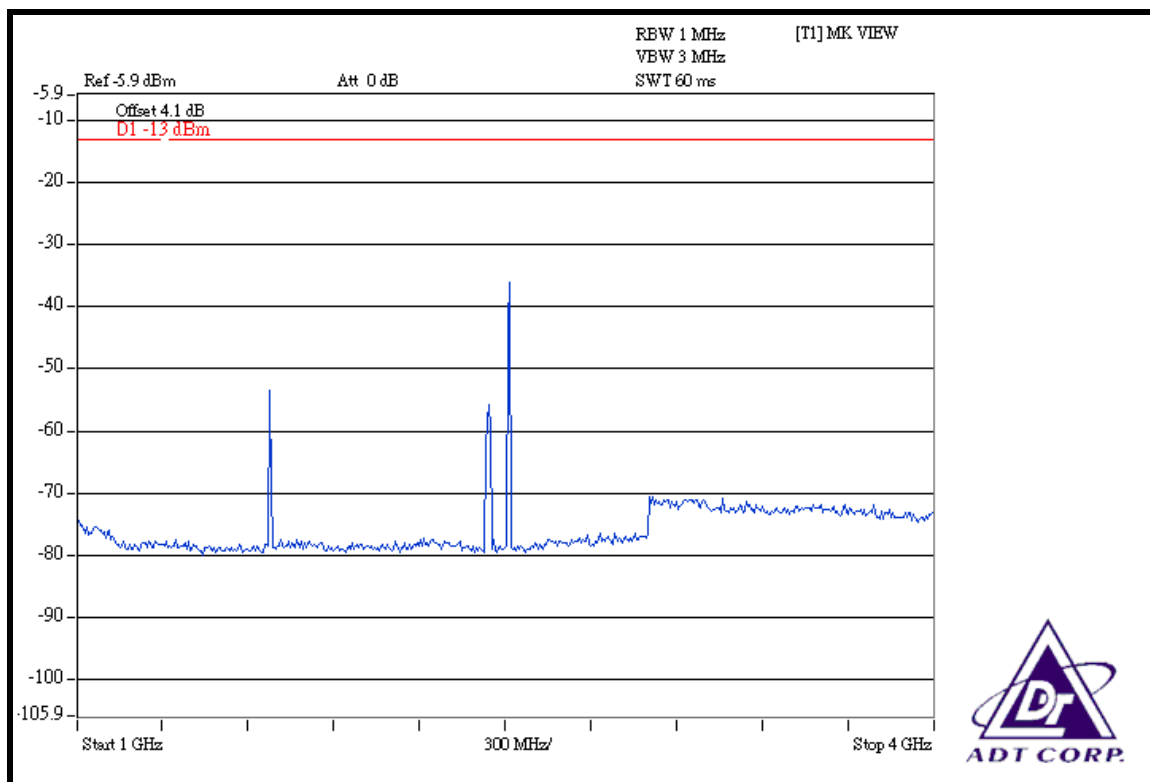

4GHz ~ 7GHz

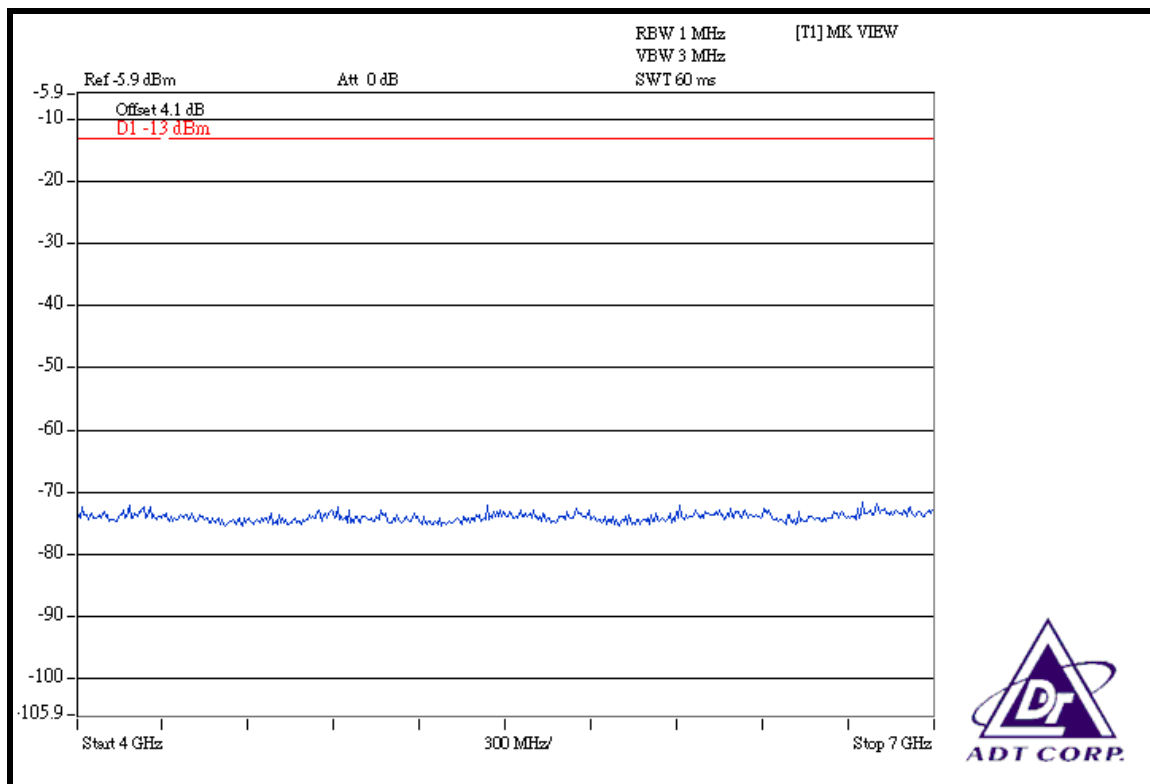

7GHz ~ 9GHz

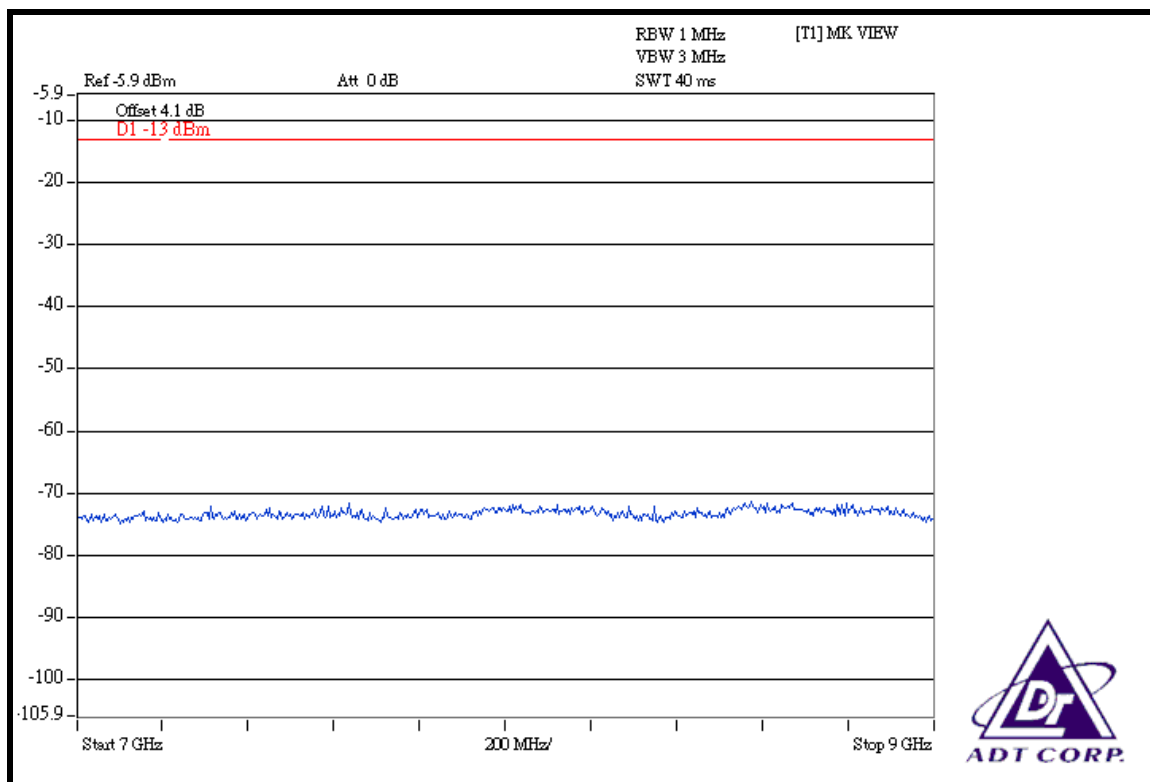

CH 251:

9kHz ~ 1GHz

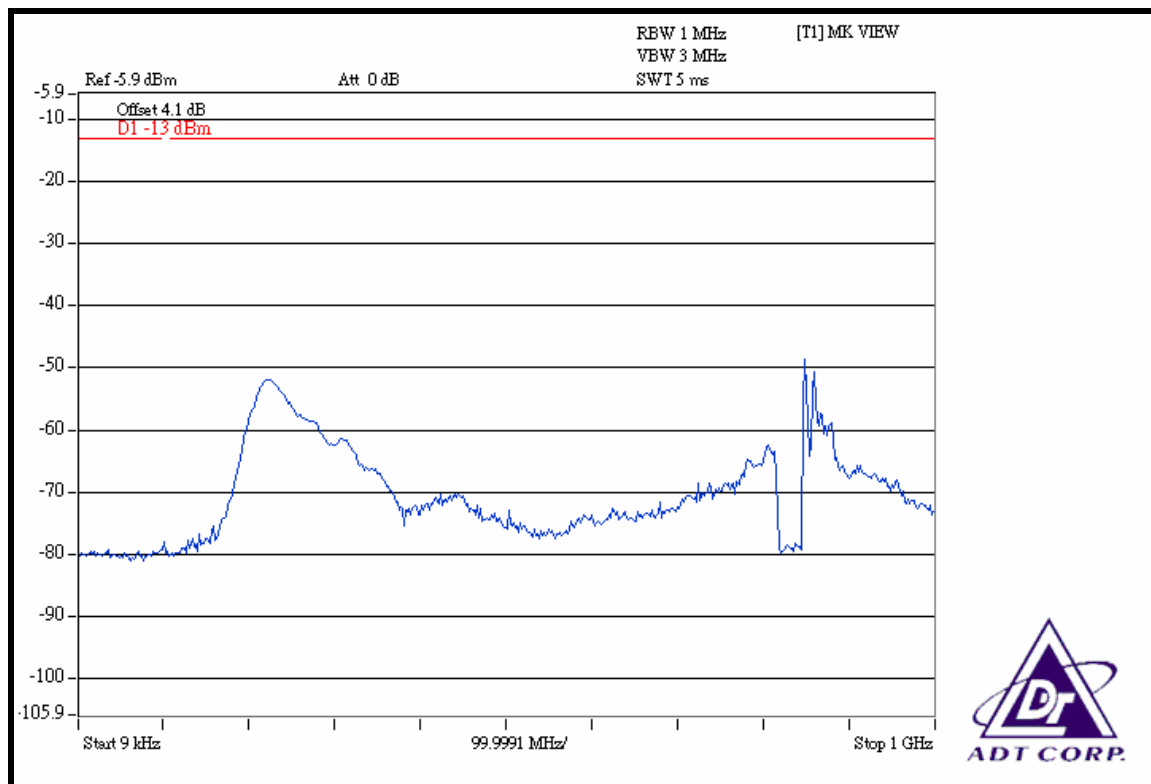

1GHz ~ 4GHz

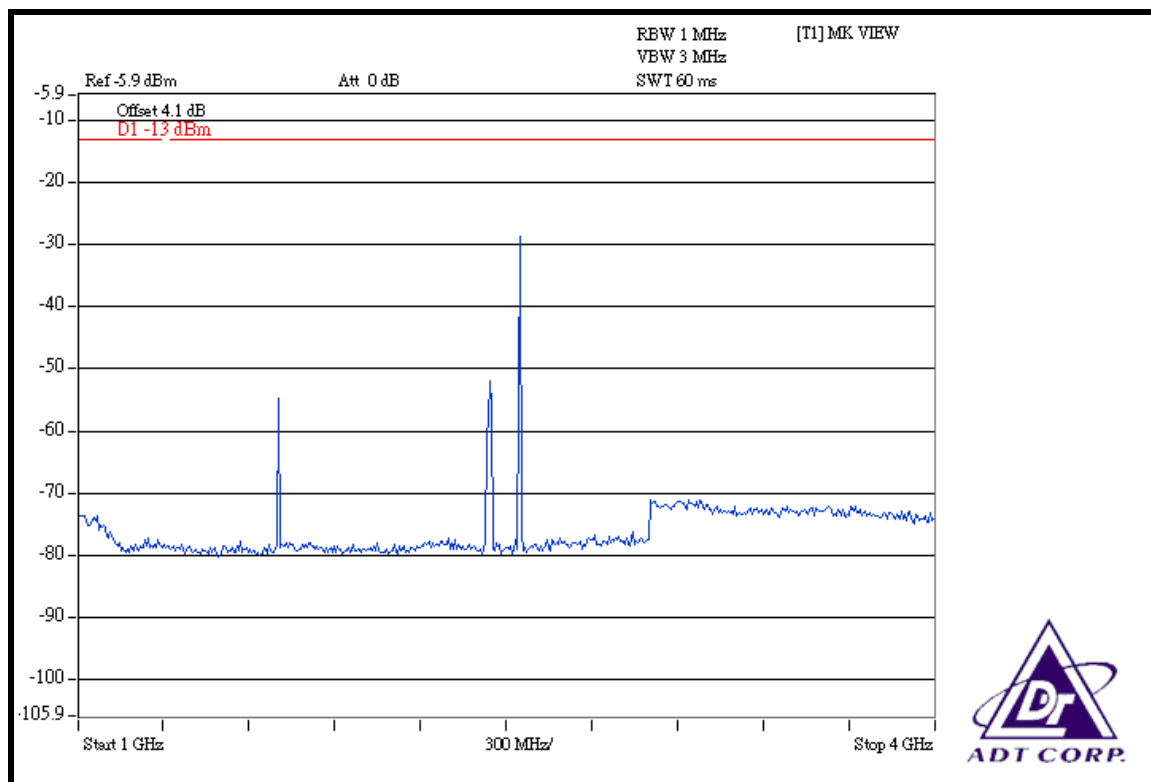

4GHz ~ 7GHz

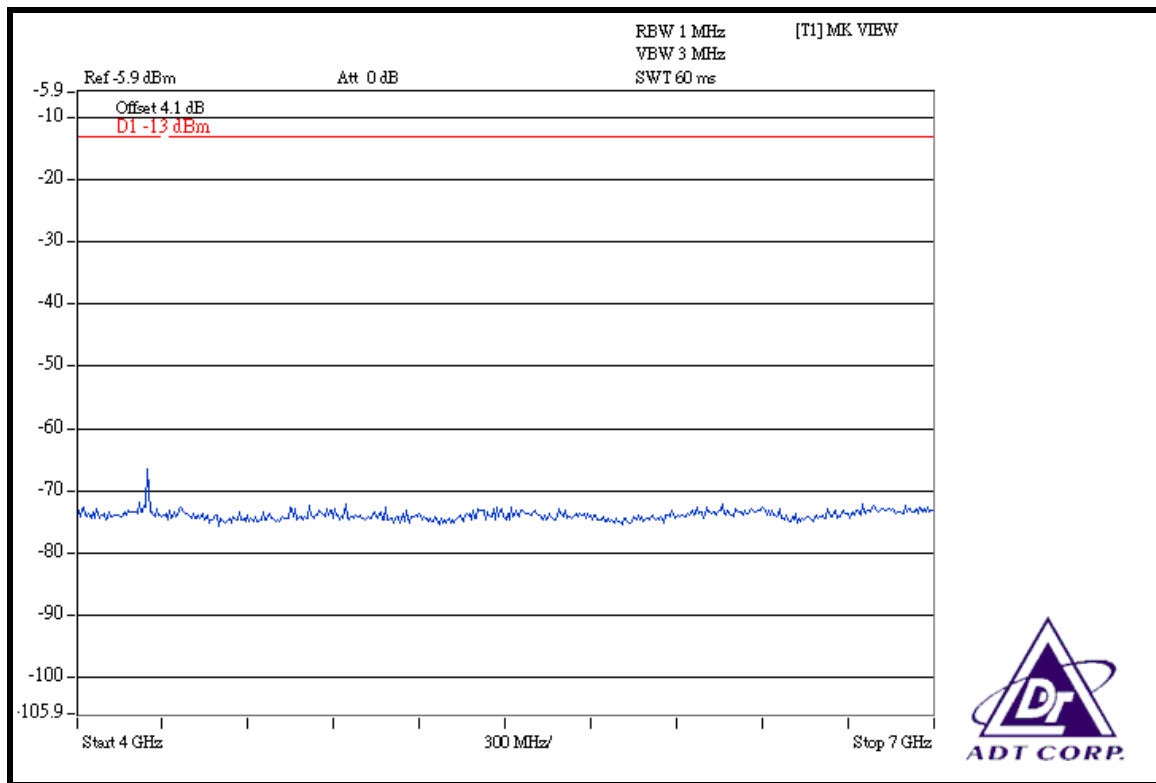

7GHz ~ 9GHz

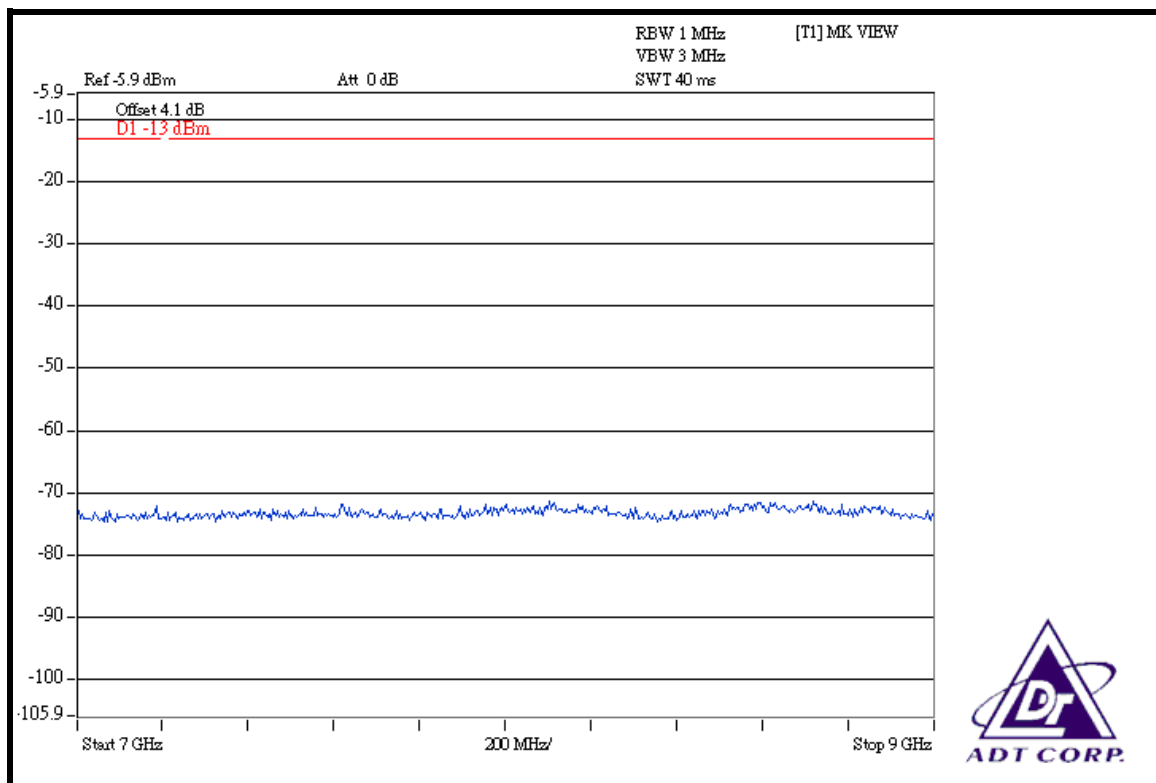

**FOR WCDMA BAND:
CH 4132:**

9kHz ~ 1GHz

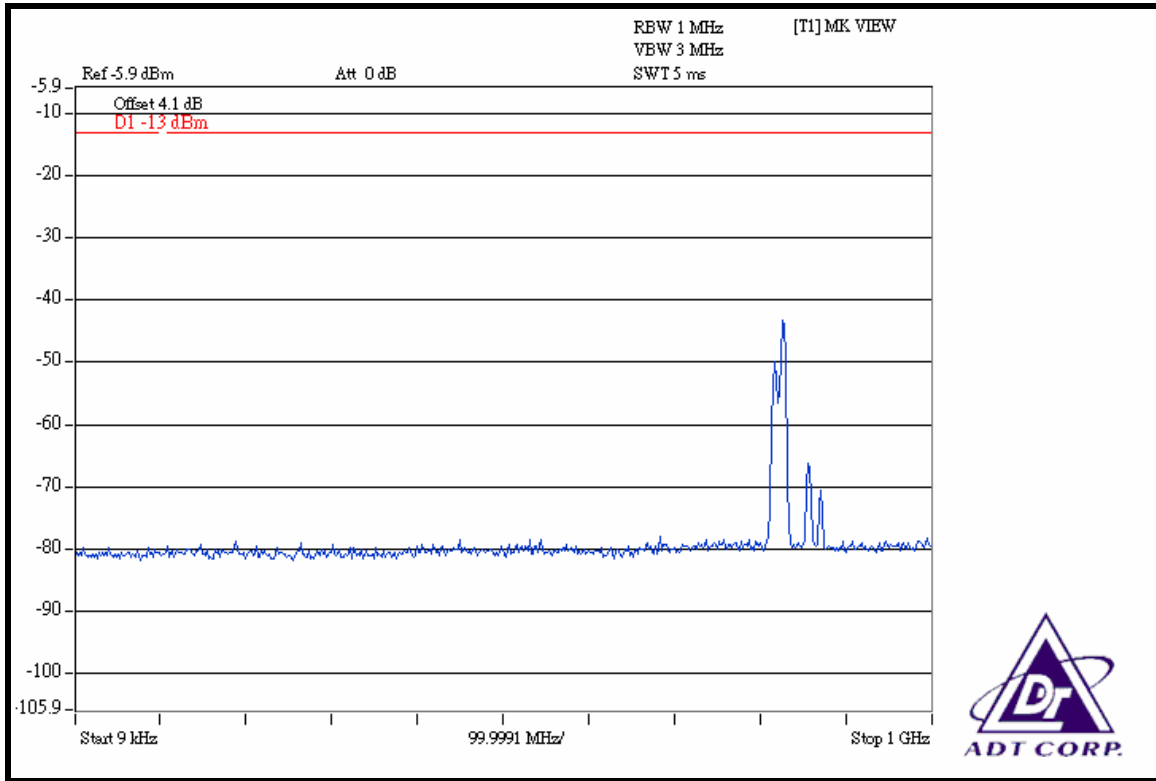

1GHz ~ 4GHz

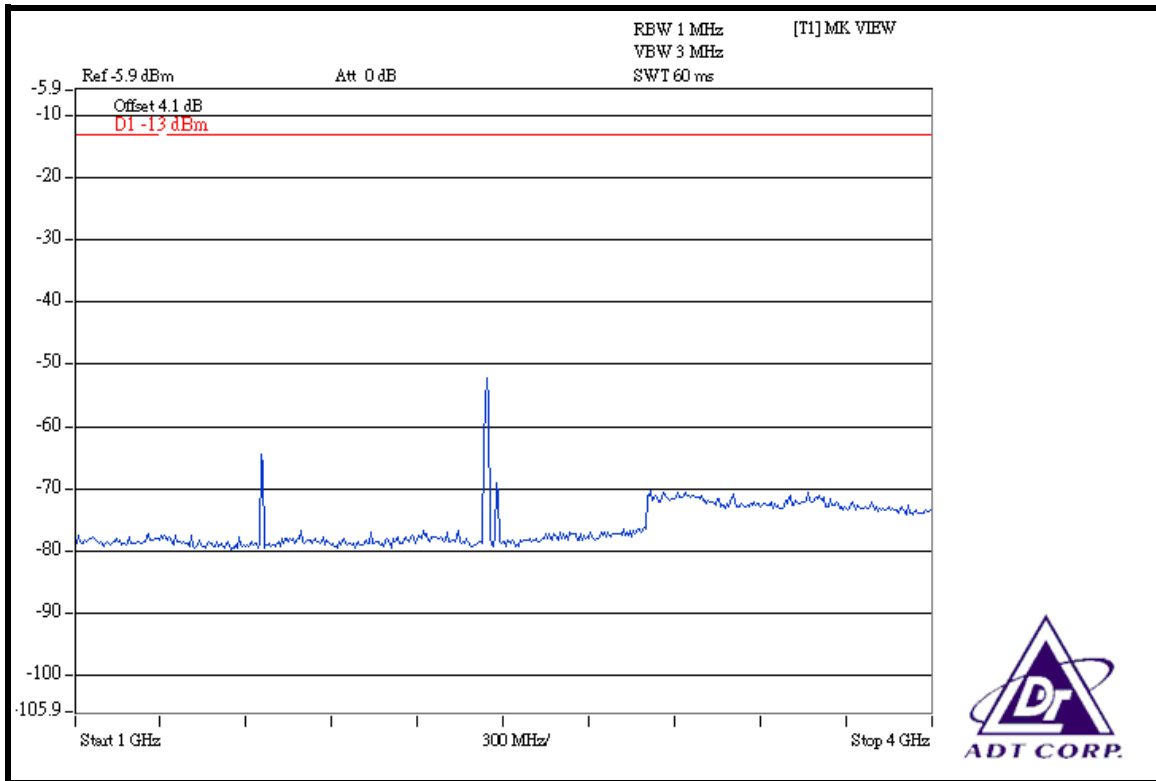

4GHz ~ 7GHz

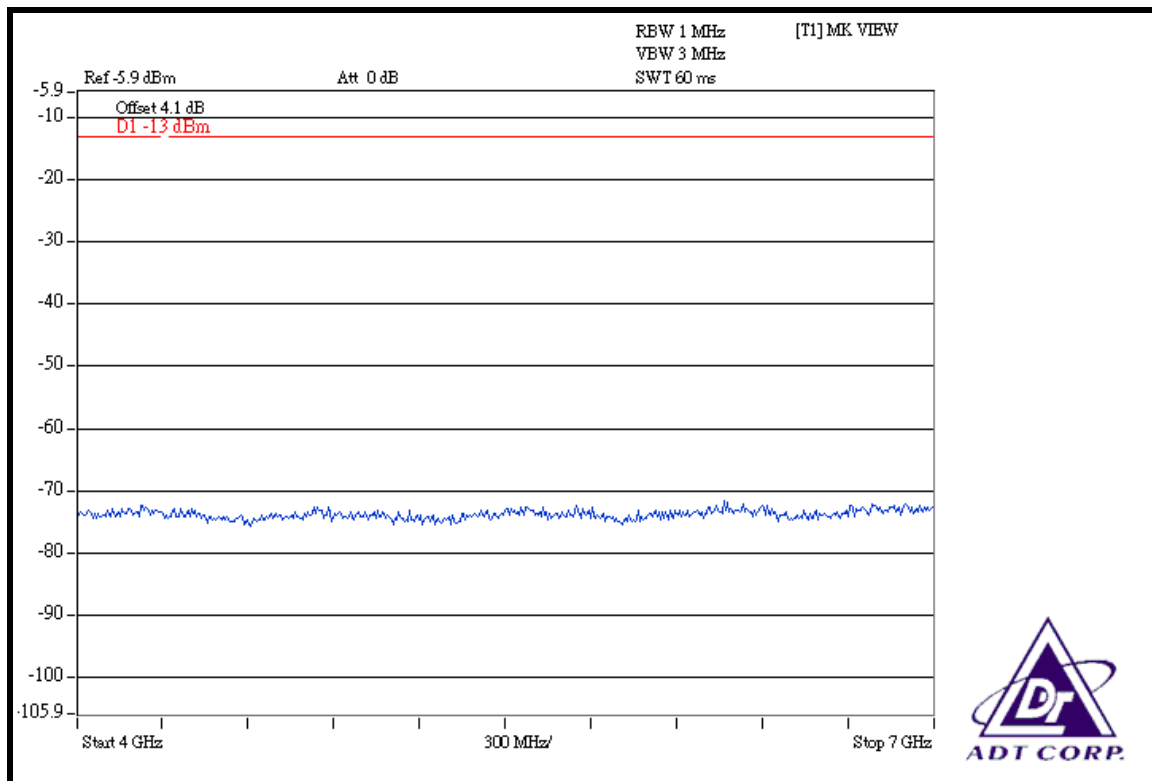

7GHz ~ 9GHz

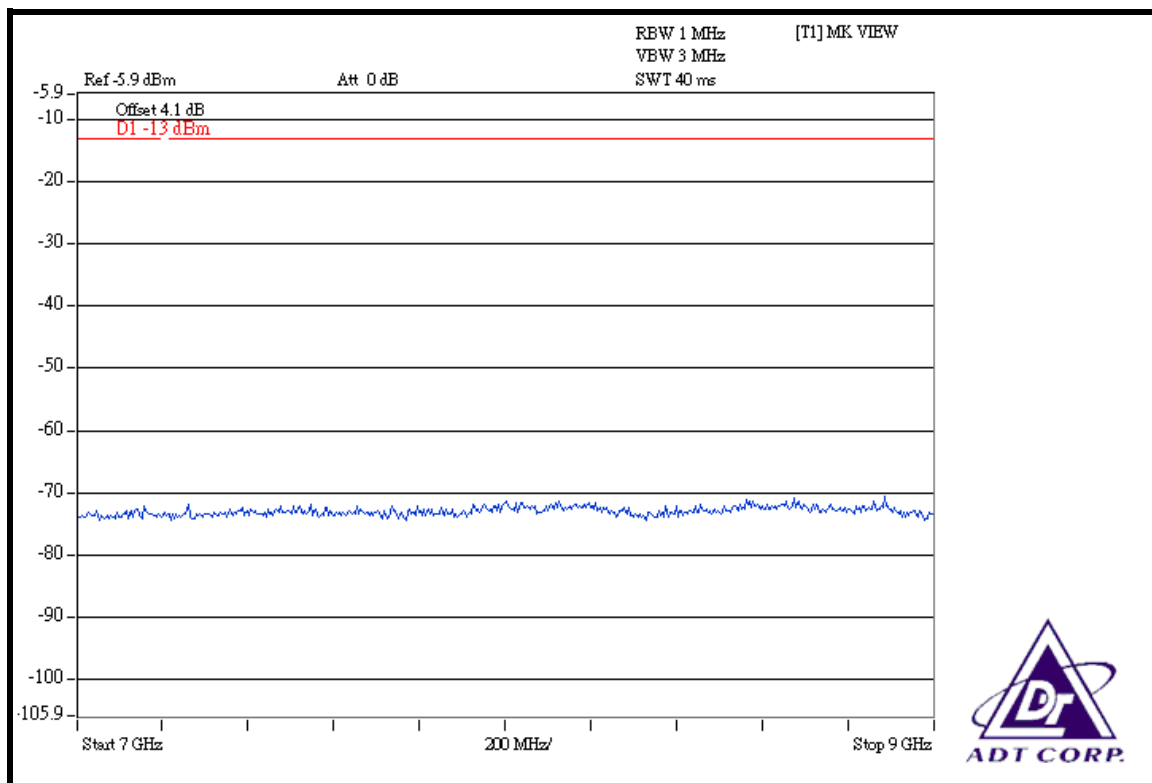

CH 4182:
9kHz ~ 1GHz

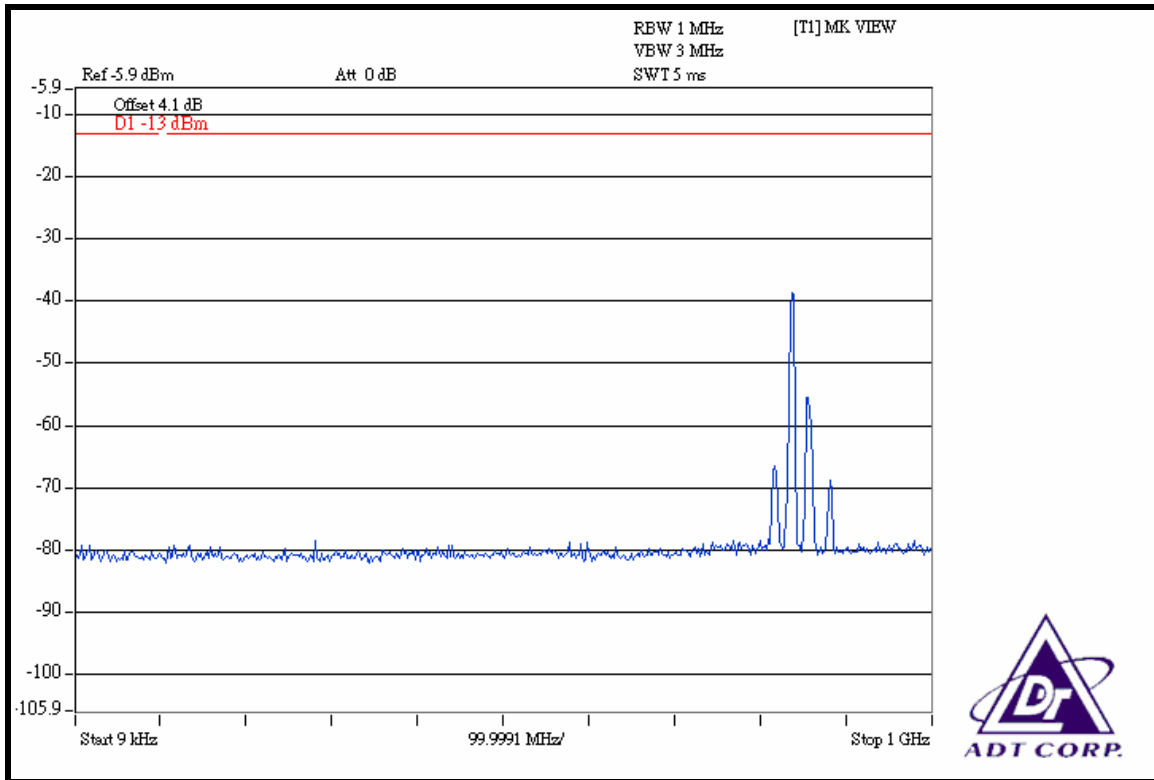

1GHz ~ 4GHz

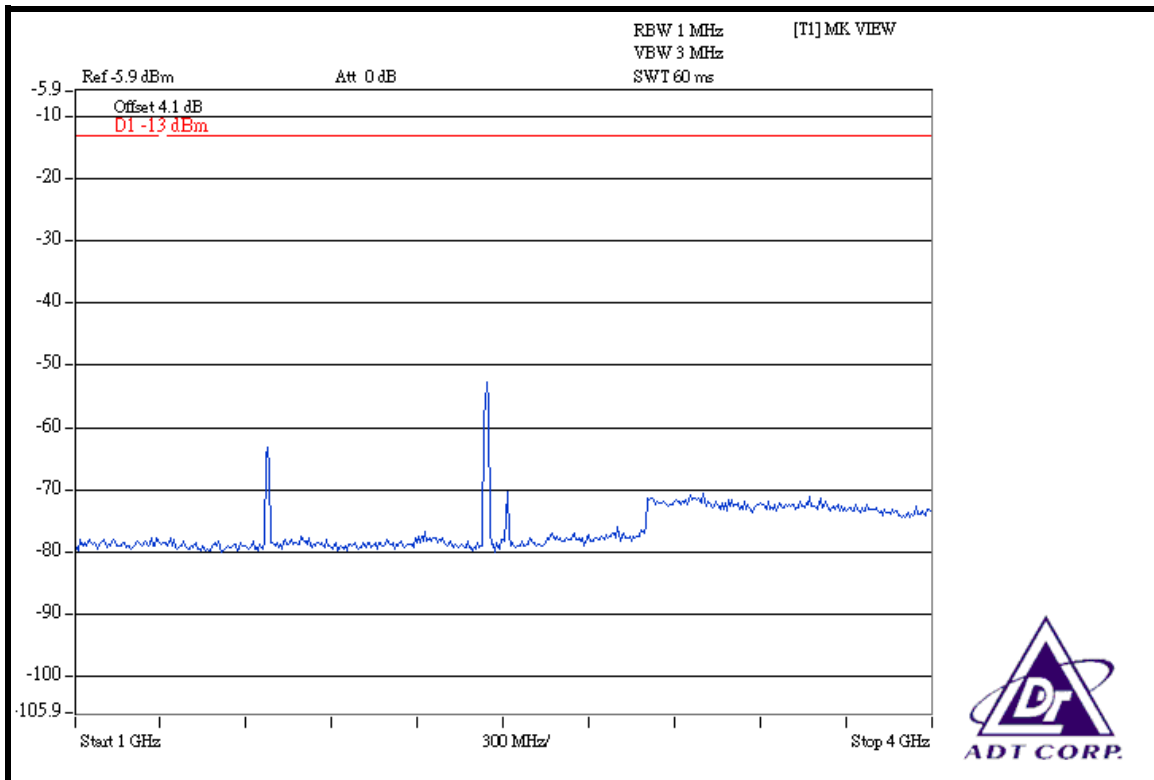

4GHz ~ 7GHz

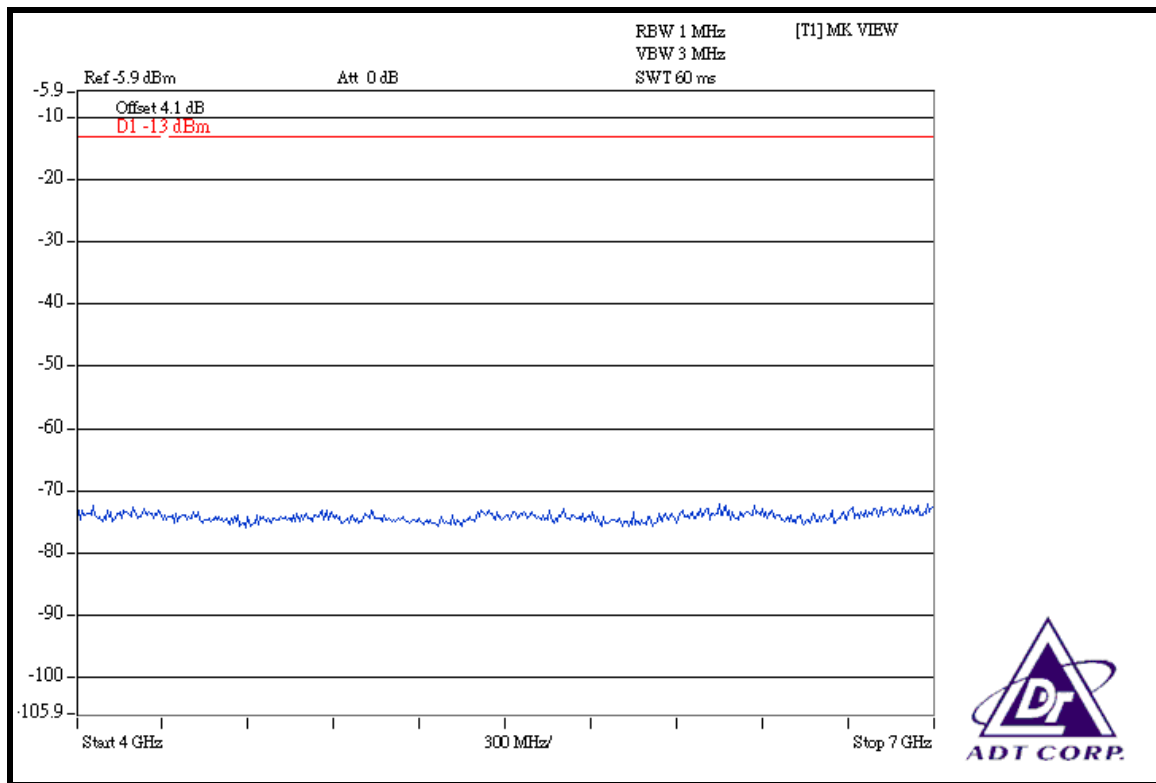

7GHz ~ 9GHz

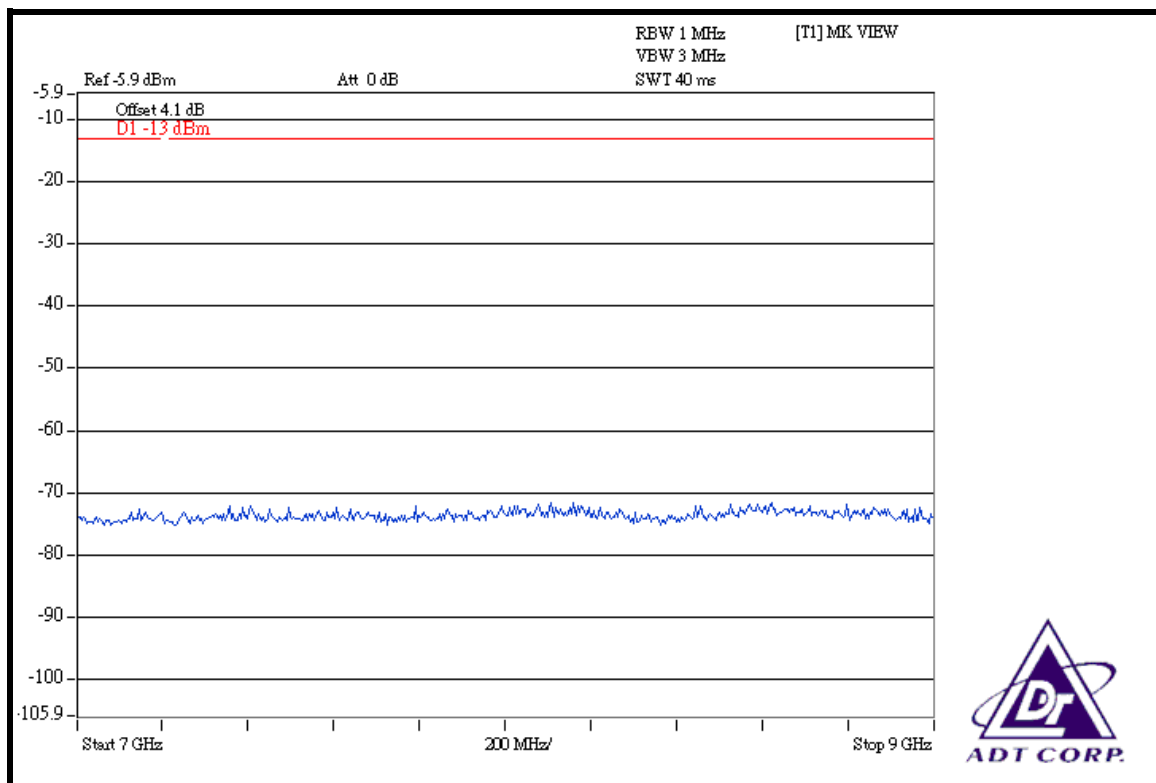

CH 4233:
9kHz ~ 1GHz

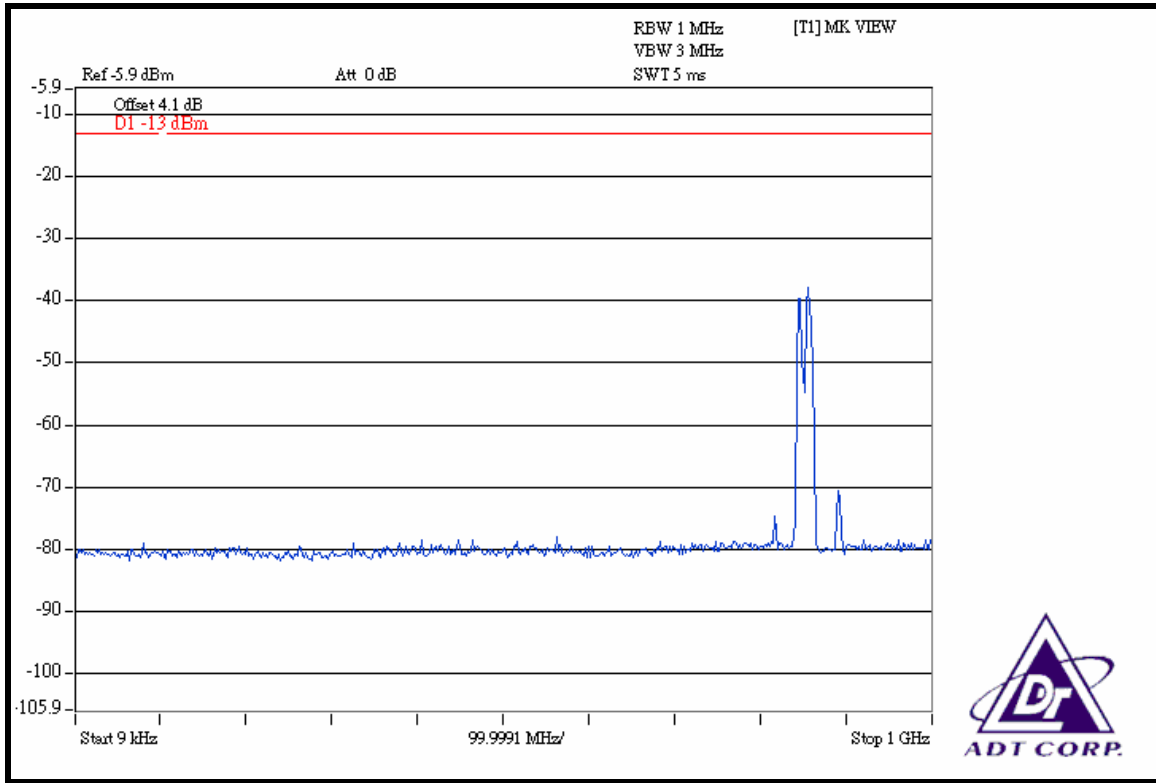

1GHz ~ 4GHz

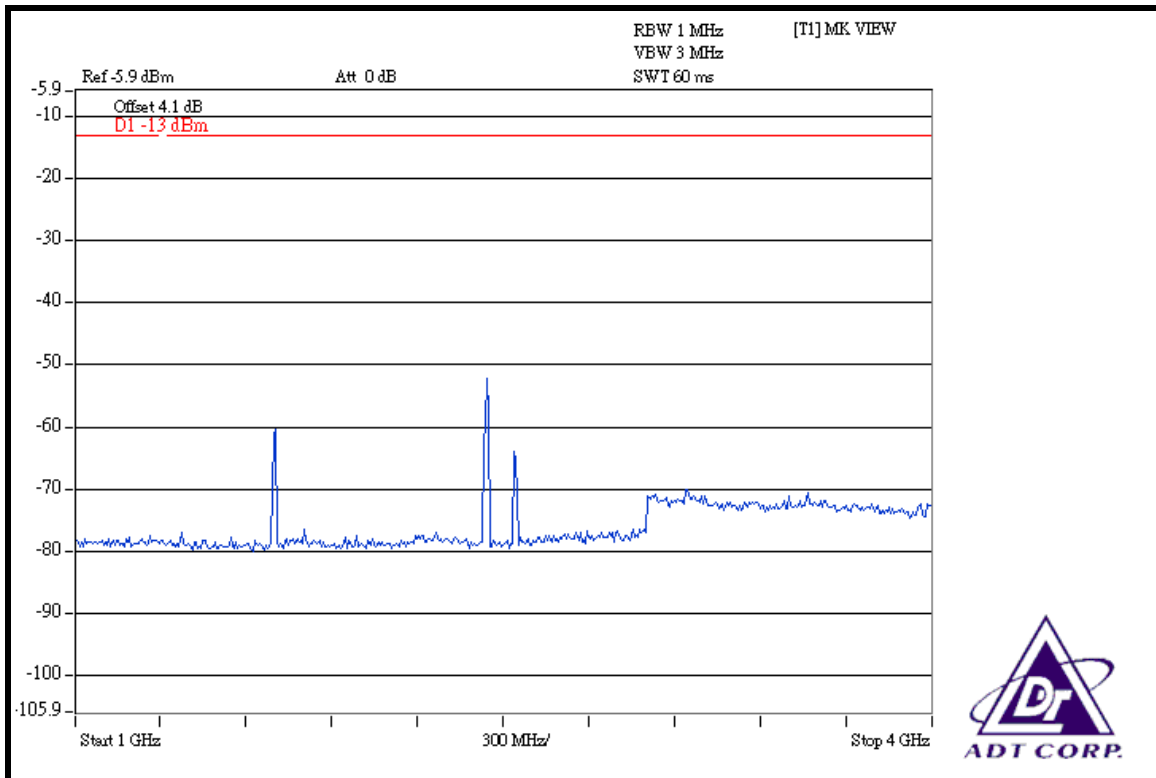

4GHz ~ 7GHz

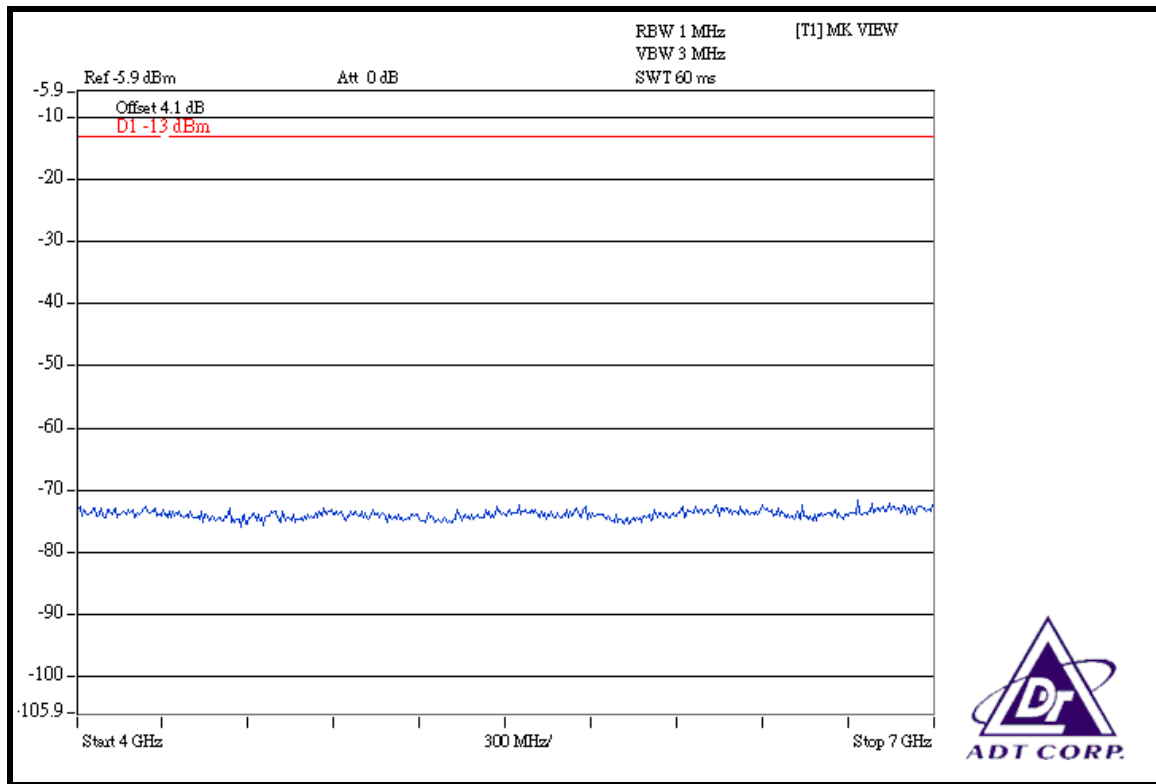

7GHz ~ 9GHz

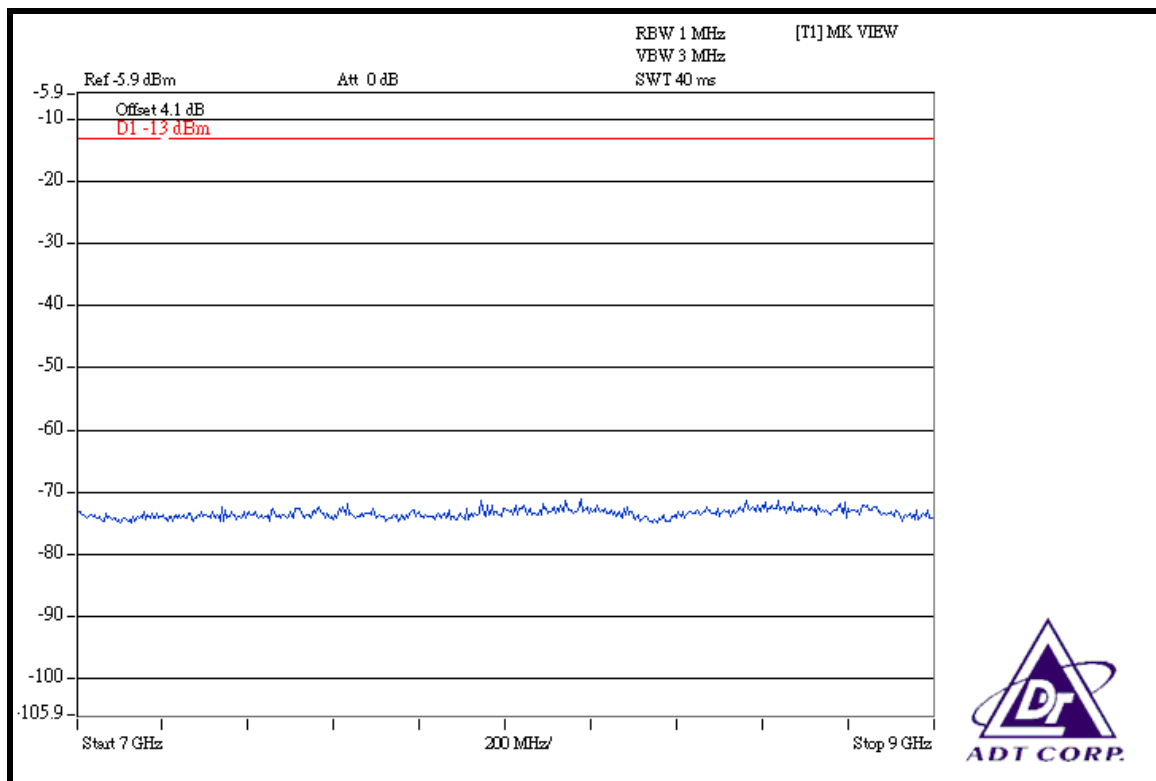

4.6 RADIATED EMISSION MEASUREMENT (BELOW 1GHz)

4.6.1 LIMITS OF RADIATED EMISSION MEASUREMENT

In the FCC 24.238(a), On any frequency outside a licensee's frequency block within USPCS spectrum, the power of any emission shall be attenuated below the transmitter power (P) by at least $43 + 10 \log (P)$ dB. The emission limit equal to -13 dBm. So the limit of emission is the same absolute specified line.

LIMIT (dBm)	EQUIVALENT FIELD STRENGTH AT 3m (dBuV/m) (NOTE)
-13	82.22

NOTE: The following formula is used to convert the equipment radiated power to field strength.

$$E = [1000000\sqrt{(30P)}] / 3 \text{ uV/m, where P is Watts.}$$



4.6.2 TEST INSTRUMENTS

DESCRIPTION & MANUFACTURER	MODEL NO.	SERIAL NO.	CALIBRATED UNTIL
Test Receiver ROHDE & SCHWARZ	ESI7	100033	Jun. 29, 2009
Spectrum Analyzer Agilent	FSP	100041	Apr. 21, 2009
BILOG Antenna SCHWARZBECK	VULB9168	9168-160	May, 01, 2009
HORN Antenna SCHWARZBECK	9120D	9120D-209	Jun. 23, 2009
HORN Antenna SCHWARZBECK	BBHA 9170	BBHA9170243	Dec. 24, 2008
Preamplifier Agilent	8447D	2944A10633	Oct. 28, 2008
Preamplifier Agilent	8449B	3008A01964	Oct. 23, 2008
RF signal cable HUBER+SUHNNER	SUCOFLEX 104	283402/4	Dec. 06, 2008
RF signal cable HUBER+SUHNNER	SUCOFLEX 104	251644/4	Dec. 06, 2008
Software ADT.	ADT_Radiated_V7.6	NA	NA
Antenna Tower inn-co GmbH	MA 4000	013303	NA
Antenna Tower Controller inn-co GmbH	CO2000	017303	NA
Turn Table ADT.	TT100.	TT93021703	NA
Turn Table Controller ADT.	SC100.	SC93021703	NA

- NOTE:**
1. The calibration interval of the above test instruments is 12 months and the calibrations are traceable to NML/ROC and NIST/USA.
 2. The test was performed in HwaYa Chamber 3.
 3. The horn antenna and HP preamplifier (model: 8449B) are used only for the measurement of emission frequency above 1GHz if tested.
 4. The FCC Site Registration No. is 988962.
 5. The IC Site Registration No. is IC3789B-3.

4.6.3 TEST PROCEDURES

- a. The EUT was placed on the top of a rotating table 0.8 meters above the ground. The table was rotated 360 degrees to determine the position of the highest radiation.
- b. The EUT was set 3 meters away from the receiving antenna, which was mounted on antenna tower and its position at 0.8 m above the ground.
- c. For each suspected emission, the EUT was arranged to its worst case and the rotatable table was turned from 0 degrees to 360 degrees to find the maximum reading and recorded the value.
- d. Repeat step a ~ c for horizontal polarization.

NOTE: The resolution bandwidth of spectrum analyzer is 1 MHz and the video bandwidth is 3 MHz.

4.6.4 DEVIATION FROM TEST STANDARD

No deviation

4.6.5 TEST SETUP

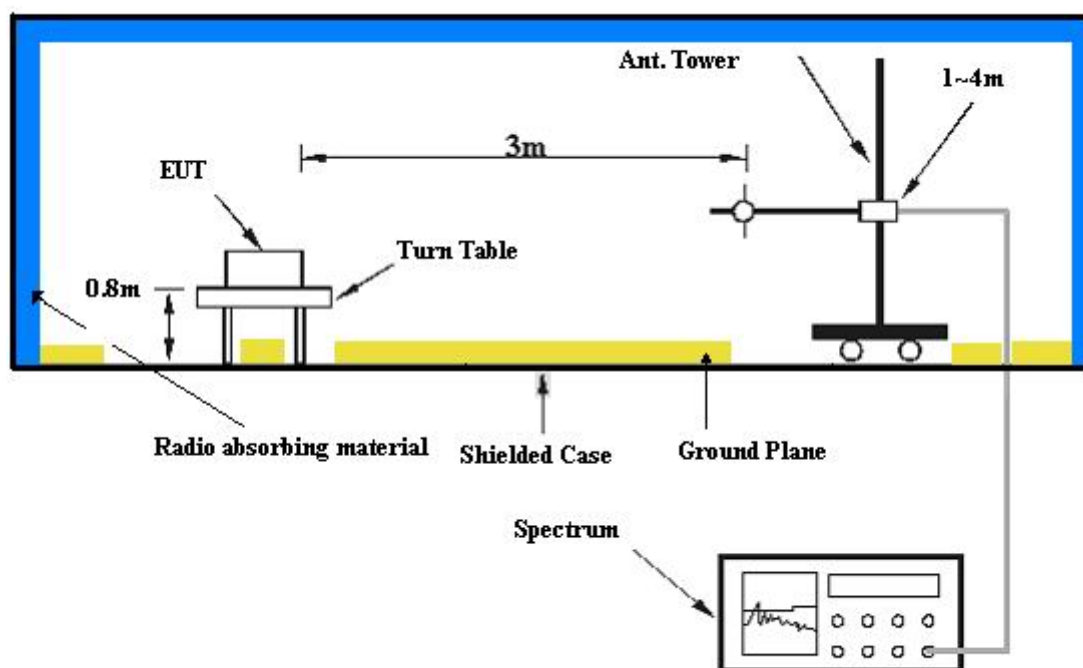

For the actual test configuration, please refer to the attached file (Test Setup Photo).

4.6.6 EUT OPERATING CONDITIONS

- a. The EUT makes a phone call to the communication simulator.
- b. The communication simulator station system controlled an EUT to export maximum output power under transmission mode and specific channel frequency.

4.6.7 TEST RESULTS

FOR GSM BAND:

MODE	TX channel 128	DETECTOR FUNCTION	Peak
FREQUENCY RANGE	Below 1000 MHz	INPUT POWER	120Vac, 60 Hz
ENVIRONMENTAL CONDITIONS	24deg. C, 64%RH, 991hPa	TESTED BY	Match Tsui

ANTENNA POLARITY & TEST DISTANCE: HORIZONTAL AT 3 M								
No.	Freq. (MHz)	Emission Level (dBuV/m)	Limit (dBuV/m)	Margin (dB)	Antenna Height (m)	Table Angle (Degree)	Raw Value (dBuV)	Correction Factor (dB/m)
1	90.26	47.55	82.22	-34.67	2.00 H	328	39.18	8.38
2	96.09	41.15	82.22	-41.07	2.00 H	322	30.62	10.53
3	655.93	41.72	82.22	-40.50	1.50 H	166	16.48	25.24
4	865.87	38.70	82.22	-43.52	1.00 H	19	9.60	29.10
5	883.37	39.36	82.22	-42.86	1.00 H	199	9.85	29.51
6	931.96	39.79	82.22	-42.43	1.00 H	52	9.54	30.25
7	961.12	40.06	82.22	-42.16	1.00 H	250	9.52	30.54
8	974.73	40.78	82.22	-41.44	1.50 H	43	10.13	30.66

ANTENNA POLARITY & TEST DISTANCE: VERTICAL AT 3 M								
No.	Freq. (MHz)	Emission Level (dBuV/m)	Limit (dBuV/m)	Margin (dB)	Antenna Height (m)	Table Angle (Degree)	Raw Value (dBuV)	Correction Factor (dB/m)
1	39.72	43.36	82.22	-38.86	1.00 V	214	28.05	15.32
2	92.20	38.62	82.22	-43.60	2.50 V	58	29.53	9.10
3	265.21	39.75	82.22	-42.47	1.50 V	277	25.33	14.42
4	655.93	38.64	82.22	-43.58	1.00 V	106	13.40	25.24
5	780.34	40.86	82.22	-41.36	1.00 V	37	13.51	27.35
6	840.60	40.13	82.22	-42.09	1.00 V	10	11.62	28.51
7	865.87	39.74	82.22	-42.48	1.00 V	34	10.64	29.10
8	896.97	40.03	82.22	-42.19	2.00 V	145	10.20	29.83
9	910.58	39.55	82.22	-42.67	1.50 V	358	9.53	30.02
10	965.01	40.47	82.22	-41.75	1.00 V	187	9.89	30.57
11	994.17	40.80	82.22	-41.42	1.00 V	325	9.99	30.82

NOTE:

1. Emission level (dBuV/m) = Raw Value (dBuV) + Correction Factor (dB).
2. Correction Factor (dB/m) = Antenna Factor (dB/m) + Cable Factor (dB).
3. The other emission levels were very low against the limit.
4. Margin value = Emission level – Limit value.
5. This is valid for all 3 channels.



FOR WCDMA BAND:

MODE	TX channel 4132	DETECTOR FUNCTION	Peak
FREQUENCY RANGE	Below 1000 MHz	INPUT POWER	120Vac, 60 Hz
ENVIRONMENTAL CONDITIONS	24deg. C, 64%RH, 991hPa	TESTED BY	Match Tsui

ANTENNA POLARITY & TEST DISTANCE: HORIZONTAL AT 3 M								
No.	Freq. (MHz)	Emission Level (dBuV/m)	Limit (dBuV/m)	Margin (dB)	Antenna Height (m)	Table Angle (Degree)	Raw Value (dBuV)	Correction Factor (dB/m)
1	90.26	48.69	82.22	-33.53	2.00 H	343	40.31	8.38
2	655.93	41.49	82.22	-40.73	1.50 H	136	16.25	25.24
3	780.34	38.26	82.22	-43.96	1.00 H	19	10.91	27.35
4	871.70	38.80	82.22	-43.42	1.50 H	67	9.56	29.24
5	900.86	39.41	82.22	-42.81	2.00 H	25	9.50	29.91
6	914.47	40.08	82.22	-42.14	1.00 H	262	10.02	30.06
7	966.95	40.44	82.22	-41.78	1.50 H	214	9.85	30.59
8	984.45	40.53	82.22	-41.69	2.00 H	97	9.80	30.74

ANTENNA POLARITY & TEST DISTANCE: VERTICAL AT 3 M								
No.	Freq. (MHz)	Emission Level (dBuV/m)	Limit (dBuV/m)	Margin (dB)	Antenna Height (m)	Table Angle (Degree)	Raw Value (dBuV)	Correction Factor (dB/m)
1	39.72	44.00	82.22	-38.22	1.00 V	274	28.69	15.32
2	90.26	40.04	82.22	-42.18	2.50 V	76	31.66	8.38
3	224.39	40.69	82.22	-41.53	1.50 V	10	28.00	12.69
4	780.34	40.97	82.22	-41.25	1.00 V	25	13.62	27.35
5	834.77	52.45	82.22	-29.77	1.00 V	10	24.08	28.37
6	875.59	38.81	82.22	-43.41	1.00 V	277	9.48	29.33
7	896.97	39.43	82.22	-42.79	1.50 V	121	9.60	29.83
8	930.02	39.70	82.22	-42.52	1.50 V	355	9.47	30.23
9	963.07	40.65	82.22	-41.57	2.50 V	313	10.09	30.56
10	998.06	40.49	82.22	-41.73	1.00 V	286	9.64	30.85

NOTE:

1. Emission level (dBuV/m) = Raw Value (dBuV) + Correction Factor (dB).
2. Correction Factor (dB/m) = Antenna Factor (dB/m) + Cable Factor (dB).
3. The other emission levels were very low against the limit.
4. Margin value = Emission level – Limit value.
5. This is valid for all 3 channels.

4.7 RADIATED EMISSION MEASUREMENT (ABOVE 1GHz)

4.7.1 LIMITS OF RADIATED EMISSION MEASUREMENT

In the FCC 22.917 (a), On any frequency outside a licensee's frequency block within GSM spectrum, the power of any emission shall be attenuated below the transmitter power (P) by at least $43 + 10 \log (P)$ dB. The emission limit equal to -13dBm .



4.7.2 TEST INSTRUMENTS

DESCRIPTION & MANUFACTURER	MODEL NO.	SERIAL NO.	CALIBRATED UNTIL
Test Receiver ROHDE & SCHWARZ	ESI7	100033	Jun. 29, 2009
Spectrum Analyzer Agilent	FSP	100041	Apr. 21, 2009
BILOG Antenna SCHWARZBECK	VULB9168	9168-160	May, 01, 2009
HORN Antenna SCHWARZBECK	9120D	9120D-209	Jun. 23, 2009
HORN Antenna SCHWARZBECK	BBHA 9170	BBHA9170243	Dec. 24, 2008
Preamplifier Agilent	8447D	2944A10633	Oct. 28, 2008
Preamplifier Agilent	8449B	3008A01964	Oct. 23, 2008
RF signal cable HUBER+SUHNNER	SUCOFLEX 104	283402/4	Dec. 06, 2008
RF signal cable HUBER+SUHNNER	SUCOFLEX 104	251644/4	Dec. 06, 2008
Software ADT.	ADT_Radiated_V7.6	NA	NA
Antenna Tower inn-co GmbH	MA 4000	013303	NA
Antenna Tower Controller inn-co GmbH	CO2000	017303	NA
Turn Table ADT.	TT100.	TT93021703	NA
Turn Table Controller ADT.	SC100.	SC93021703	NA

- NOTE:**
1. The calibration interval of the above test instruments is 12 months and the calibrations are traceable to NML/ROC and NIST/USA.
 2. The test was performed in HwaYa Chamber 3.
 3. The horn antenna and HP preamplifier (model: 8449B) are used only for the measurement of emission frequency above 1GHz if tested.
 4. The FCC Site Registration No. is 988962.
 5. The IC Site Registration No. is IC3789B-3.

4.7.3 TEST PROCEDURES

- a. The EUT was placed on the top of a rotating table 0.8 meters above the ground. The table was rotated 360 degrees to determine the position of the highest radiation.
- b. The EUT was set 3 meters away from the receiving antenna, which was mounted on antenna tower and its position at 0.8 m above the ground.
- c. For each suspected emission, the EUT was arranged to its worst case and the rotatable table was turned from 0 degrees to 360 degrees to find the maximum reading and recorded the value.
- d. The EUT is replaced by a horn antenna connected to a signal generator tuned to the frequency of emission.
- e. The signal generator level has to be adjusted to have the same emission nature.
- f. The radiated power can be calculated via the factor and antenna gain.
- g. Repeat step a ~ f for horizontal polarization.

NOTE: The resolution bandwidth of spectrum analyzer is 1 MHz and the video bandwidth is 3 MHz.

4.7.4 DEVIATION FROM TEST STANDARD

No deviation

4.7.5 TEST SETUP

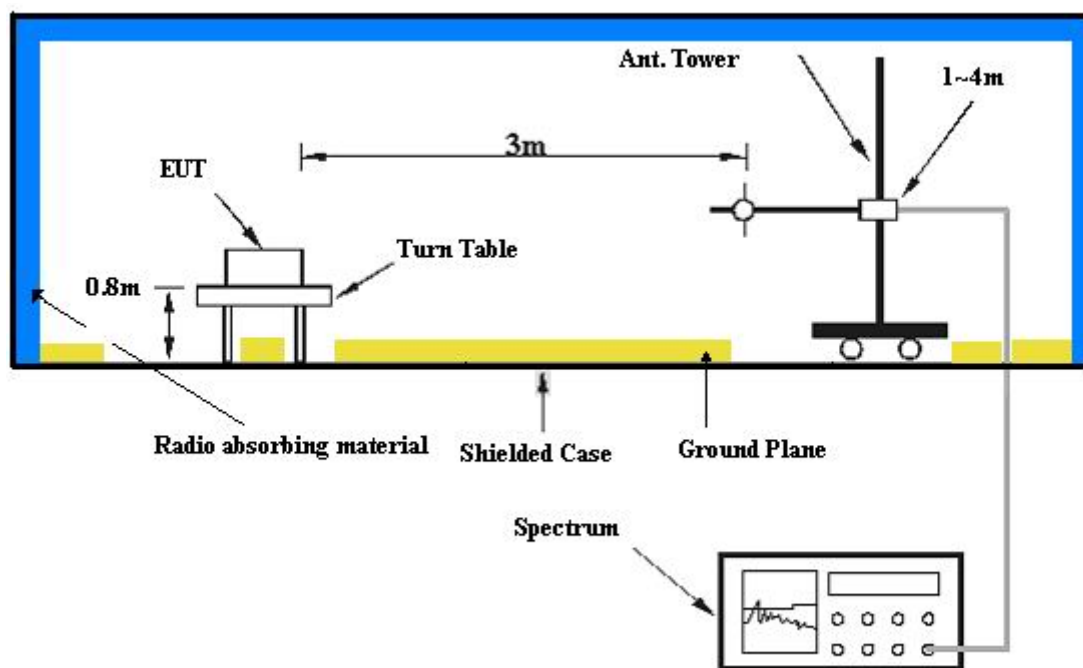

For the actual test configuration, please refer to the attached file (Test Setup Photo).

4.7.6 EUT OPERATING CONDITIONS

- The EUT makes a phone call to the communication simulator.
- The communication simulator station system controlled an EUT to export maximum output power under transmission mode and specific channel frequency.



4.7.7 TEST RESULTS

FOR GSM BAND:

MODE	TX channel 128	FREQUENCY RANGE	Above 1000 MHz
INPUT POWER	120Vac, 60 Hz	ENVIRONMENTAL CONDITIONS	25deg. C, 65%RH, 991hPa
TESTED BY	Brad Wu		

ANTENNA POLARITY & TEST DISTANCE: HORIZONTAL AT 3 M						
No.	Freq. (MHz)	Emission Level (dBUV)	Limit (dBm)	S.G Power Value (dBm)	Correction Factor (dB)	Power Value (dBm)
1	1648.40	53.86	-13.00	-51.98	10.12	-41.86
2	2472.60	59.92	-13.00	-47.34	11.49	-35.85

ANTENNA POLARITY & TEST DISTANCE: VERTICAL AT 3 M						
No.	Freq. (MHz)	Emission Level (dBUV)	Limit (dBm)	S.G Power Value (dBm)	Correction Factor (dB)	Power Value (dBm)
1	1648.40	53.15	-13.00	-52.71	10.12	-42.59
2	2472.60	51.07	-13.00	-56.17	11.49	-44.68

NOTE: Power Value (dBum) = S.G Power Value (dBm) + Correction Factor (dB).



MODE	TX channel 190	FREQUENCY RANGE	Above 1000 MHz
INPUT POWER	120Vac, 60 Hz	ENVIRONMENTAL CONDITIONS	25deg. C, 65%RH, 991hPa
TESTED BY	Brad Wu		

ANTENNA POLARITY & TEST DISTANCE: HORIZONTAL AT 3 M						
No.	Freq. (MHz)	Emission Level (dBuV)	Limit (dBm)	S.G Power Value (dBm)	Correction Factor (dB)	Power Value (dBm)
1	1673.20	56.02	-13.00	-49.81	10.12	-39.69
2	2509.80	63.16	-13.00	-44.35	11.49	-32.86

ANTENNA POLARITY & TEST DISTANCE: VERTICAL AT 3 M						
No.	Freq. (MHz)	Emission Level (dBuV)	Limit (dBm)	S.G Power Value (dBm)	Correction Factor (dB)	Power Value (dBm)
1	1673.20	55.80	-13.00	-49.87	10.12	-39.75
2	2509.80	55.50	-13.00	-51.70	11.49	-40.21

NOTE: Power Value (dBum) = S.G Power Value (dBm) + Correction Factor (dB).



MODE	TX channel 251	FREQUENCY RANGE	Above 1000 MHz
INPUT POWER	120Vac, 60 Hz	ENVIRONMENTAL CONDITIONS	25deg. C, 65%RH, 991hPa
TESTED BY	Brad Wu		

ANTENNA POLARITY & TEST DISTANCE: HORIZONTAL AT 3 M						
No.	Freq. (MHz)	Emission Level (dBuV)	Limit (dBm)	S.G Power Value (dBm)	Correction Factor (dB)	Power Value (dBm)
1	1697.60	54.58	-13.00	-51.42	10.17	-41.25
2	2546.40	65.30	-13.00	-41.85	11.49	-30.36

ANTENNA POLARITY & TEST DISTANCE: VERTICAL AT 3 M						
No.	Freq. (MHz)	Emission Level (dBuV)	Limit (dBm)	S.G Power Value (dBm)	Correction Factor (dB)	Power Value (dBm)
1	1697.60	55.82	-13.00	-50.41	10.17	-40.24
2	2546.40	57.51	-13.00	49.95	11.49	-38.46

NOTE: Power Value (dBum) = S.G Power Value (dBm) + Correction Factor (dB).



FOR WCDMA BAND:

MODE	TX channel 4132	FREQUENCY RANGE	Above 1000 MHz
INPUT POWER	120Vac, 60 Hz	ENVIRONMENTAL CONDITIONS	25deg. C, 65%RH, 991hPa
TESTED BY	Brad Wu		

ANTENNA POLARITY & TEST DISTANCE: HORIZONTAL AT 3 M						
No.	Freq. (MHz)	Emission Level (dBuV)	Limit (dBm)	S.G Power Value (dBm)	Correction Factor (dB)	Power Value (dBm)
1	1652.80	44.05	-13.00	-61.75	10.12	-51.63
2	2479.20	45.38	-13.00	-61.74	11.49	-50.25

ANTENNA POLARITY & TEST DISTANCE: VERTICAL AT 3 M						
No.	Freq. (MHz)	Emission Level (dBuV)	Limit (dBm)	S.G Power Value (dBm)	Correction Factor (dB)	Power Value (dBm)
1	1652.80	40.50	-13.00	-65.38	10.12	-55.26
2	2479.20	40.20	-13.00	-63.18	11.49	-51.69

NOTE: Power Value (dBum) = S.G Power Value (dBm) + Correction Factor (dB).



MODE	TX channel 4182	FREQUENCY RANGE	Above 1000 MHz
INPUT POWER	120Vac, 60 Hz	ENVIRONMENTAL CONDITIONS	25deg. C, 65%RH, 991hPa
TESTED BY	Brad Wu		

ANTENNA POLARITY & TEST DISTANCE: HORIZONTAL AT 3 M						
No.	Freq. (MHz)	Emission Level (dBuV)	Limit (dBm)	S.G Power Value (dBm)	Correction Factor (dB)	Power Value (dBm)
1	1672.80	43.68	-13.00	-62.24	10.12	-52.12
2	2509.20	42.73	-13.00	-64.55	11.49	-53.06

ANTENNA POLARITY & TEST DISTANCE: VERTICAL AT 3 M						
No.	Freq. (MHz)	Emission Level (dBuV)	Limit (dBm)	S.G Power Value (dBm)	Correction Factor (dB)	Power Value (dBm)
1	1672.80	44.87	-13.00	-60.97	10.12	-50.85
2	2509.20	48.62	-13.00	-58.80	11.49	-47.31

NOTE: Power Value (dBum) = S.G Power Value (dBm) + Correction Factor (dB).



MODE	TX channel 4233	FREQUENCY RANGE	Above 1000 MHz
INPUT POWER	120Vac, 60 Hz	ENVIRONMENTAL CONDITIONS	25deg. C, 65%RH, 991hPa
TESTED BY	Brad Wu		

ANTENNA POLARITY & TEST DISTANCE: HORIZONTAL AT 3 M						
No.	Freq. (MHz)	Emission Level (dBuV)	Limit (dBm)	S.G Power Value (dBm)	Correction Factor (dB)	Power Value (dBm)
1	1693.20	43.28	-13.00	-62.73	10.17	-52.56
2	2539.80	45.18	-13.00	-61.92	11.49	-50.43
3	3386.40	43.16	-13.00	-65.38	12.56	-52.82

ANTENNA POLARITY & TEST DISTANCE: VERTICAL AT 3 M						
No.	Freq. (MHz)	Emission Level (dBuV)	Limit (dBm)	S.G Power Value (dBm)	Correction Factor (dB)	Power Value (dBm)
1	1693.20	45.29	-13.00	-60.61	10.17	-50.44
2	2539.80	44.59	-13.00	-62.79	11.49	-51.30

NOTE: Power Value (dBum) = S.G Power Value (dBm) + Correction Factor (dB).



5 PHOTOGRAPHS OF THE TEST CONFIGURATION

Please refer to the attached file (Test Setup Photo).



6 INFORMATION ON THE TESTING LABORATORIES

We, ADT Corp., were founded in 1988 to provide our best service in EMC, Radio, Telecom and Safety consultation. Our laboratories are accredited and approved by the following approval agencies according to ISO/IEC 17025.

USA	FCC, UL
GERMANY	TUV Rheinland
JAPAN	VCCI
NORWAY	NEMKO
CANADA	INDUSTRY CANADA , CSA
R.O.C.	TAF, BSMI, NCC
NETHERLANDS	Telefication
SINGAPORE	GOST-ASIA (MOU)
RUSSIA	CERTIS (MOU)

Copies of accreditation certificates of our laboratories obtained from approval agencies can be downloaded from our web site: www.adt.com.tw/index.5/phtml.
If you have any comments, please feel free to contact us at the following:

Linko EMC/RF Lab:
Tel: 886-2-26052180
Fax: 886-2-26051924

Hsin Chu EMC/RF Lab:
Tel: 886-3-5935343
Fax: 886-3-5935342

Hwa Ya EMC/RF/Safety/Telecom Lab:
Tel: 886-3-3183232
Fax: 886-3-3185050

Web Site: www.adt.com.tw

The address and road map of all our labs can be found in our web site also.



7 APPENDIX A – MODIFICATIONS RECORDERS FOR ENGINEERING CHANGES TO THE EUT BY THE LAB

No any modifications are made to the EUT by the lab during the test.

---END---