



FCC TEST REPORT (FOR BLUETOOTH)

REPORT NO.: RF970711L09-3

MODEL NO.: SEDN100

RECEIVED: Jul. 11, 2008

TESTED: Jul. 21 ~ Jul. 22, 2008

ISSUED: Aug. 04, 2008

APPLICANT: HTC Corporation

ADDRESS: No. 23, Xinghua Rd., Taoyuan City, Taiwan, R.O.C.

ISSUED BY: Advance Data Technology Corporation

LAB ADDRESS: No. 47, 14th Ling, Chia Pau Tsuen, Lin Kou Hsiang, Taipei Hsien 244, Taiwan, R.O.C.

TEST LOCATION: No. 19, Hwa Ya 2nd Rd, Wen Hwa Tsuen, Kwei Shan Hsiang, Taoyuan Hsien 333, Taiwan, R.O.C.

This test report consists of 82 pages in total. It may be duplicated completely for legal use with the approval of the applicant. It should not be reproduced except in full, without the written approval of our laboratory. The client should not use it to claim product endorsement by TAF or any government agencies. The test results in the report only apply to the tested sample.





Table of Contents

1.	CERTIFICATION.....	4
2.	SUMMARY OF TEST RESULTS	5
2.1	MEASUREMENT UNCERTAINTY.....	6
3.	GENERAL INFORMATION.....	7
3.1	GENERAL DESCRIPTION OF EUT	7
3.2	DESCRIPTION OF TEST MODES	9
3.2.1	CONFIGURATION OF SYSTEM UNDER TEST	10
3.2.2	TEST MODE APPLICABILITY AND TESTED CHANNEL DETAIL	11
3.3	GENERAL DESCRIPTION OF APPLIED STANDARDS	13
3.4	DESCRIPTION OF SUPPORT UNITS	14
4.	TEST TYPES AND RESULTS	15
4.1	RADIATED EMISSION MEASUREMENT	15
4.1.1	LIMITS OF RADIATED EMISSION MEASUREMENT.....	15
4.1.2	TEST INSTRUMENTS.....	16
4.1.3	TEST PROCEDURES	17
4.1.4	DEVIATION FROM TEST STANDARD.....	17
4.1.5	TEST SETUP.....	18
4.1.6	EUT OPERATING CONDITIONS	18
4.1.7	TEST RESULTS	19
4.2	CONDUCTED EMISSION MEASUREMENT	29
4.2.1	LIMITS OF CONDUCTED EMISSION MEASUREMENT.....	29
4.2.2	TEST INSTRUMENTS.....	29
4.2.3	TEST PROCEDURES	30
4.2.4	DEVIATION FROM TEST STANDARD.....	30
4.2.5	TEST SETUP.....	31
4.2.6	EUT OPERATING CONDITIONS	31
4.2.7	TEST RESULTS	32
4.3	NUMBER OF HOPPING FREQUENCY USED	38
4.3.1	LIMITS OF HOPPING FREQUENCY USED	38
4.3.2	TEST INSTRUMENTS.....	38
4.3.3	TEST PROCEDURES	38
4.3.4	DEVIATION FROM TEST STANDARD.....	39
4.3.5	TEST SETUP.....	39
4.3.6	TEST RESULTS	39
4.4	DWELL TIME ON EACH CHANNEL	42
4.4.1	LIMIT OF DWELL TIME USED.....	42
4.4.2	TEST INSTRUMENTS.....	42
4.4.3	TEST PROCEDURES	42
4.4.4	DEVIATION FROM TEST STANDARD.....	42
4.4.5	TEST SETUP.....	43
4.4.6	TEST RESULTS	43
4.5	CHANNEL BANDWIDTH.....	51
4.5.1	LIMITS OF CHANNEL BANDWIDTH	51
4.5.2	TEST INSTRUMENTS.....	51
4.5.3	TEST PROCEDURE.....	51
4.5.4	DEVIATION FROM TEST STANDARD.....	51



4.5.5	TEST SETUP	52
4.5.6	EUT OPERATING CONDITION.....	52
4.5.7	TEST RESULTS	52
4.6	HOPPING CHANNEL SEPARATION.....	58
4.6.1	LIMIT OF HOPPING CHANNEL SEPARATION	58
4.6.2	TEST INSTRUMENTS.....	58
4.6.3	TEST PROCEDURES	58
4.6.4	DEVIATION FROM TEST STANDARD.....	59
4.6.5	TEST SETUP	59
4.6.6	TEST RESULTS	59
4.7	MAXIMUM PEAK OUTPUT POWER.....	65
4.7.1	LIMITS OF MAXIMUM PEAK OUTPUT POWER MEASUREMENT	65
4.7.2	TEST INSTRUMENTS.....	65
4.7.3	TEST PROCEDURES	65
4.7.4	DEVIATION FROM TEST STANDARD.....	65
4.7.5	TEST SETUP	66
4.7.6	EUT OPERATING CONDITION.....	66
4.7.7	TEST RESULTS	66
4.8	BAND EDGES MEASUREMENT	72
4.8.1	LIMITS OF BAND EDGES MEASUREMENT	72
4.8.2	TEST INSTRUMENTS.....	72
4.8.3	TEST PROCEDURE.....	72
4.8.4	DEVIATION FROM TEST STANDARD.....	72
4.8.5	EUT OPERATING CONDITION.....	72
4.8.6	TEST RESULTS	73
4.9	ANTENNA REQUIREMENT	79
4.9.1	STANDARD APPLICABLE	79
4.9.2	ANTENNA CONNECTED CONSTRUCTION	79
5.	PHOTOGRAPHS OF THE TEST CONFIGURATION.....	80
6.	INFORMATION ON THE TESTING LABORATORIES	81
7.	APPENDIX A - MODIFICATIONS RECORDERS FOR ENGINEERING CHANGES TO THE EUT BY THE LAB.....	82



1. CERTIFICATION

PRODUCT: Pocket PC Phone
MODEL: SEDN100
APPLICANT: HTC Corporation
TESTED: Jul. 21 ~ Jul. 22, 2008
TEST SAMPLE: ENGINEERING SAMPLE
STANDARDS: **FCC Part 15, Subpart C (Section 15.247),**
ANSI C63.4-2003

The above equipment (model: SEDN100) has been tested by **Advance Data Technology Corporation**, and found compliance with the requirement of the above standards. The test record, data evaluation & Equipment Under Test (EUT) configurations represented herein are true and accurate accounts of the measurements of the sample's EMC characteristics under the conditions specified in this report.

PREPARED BY : Wendy Liao , **DATE:** Aug. 04, 2008
Wendy Liao / Senior Specialist

TECHNICAL ACCEPTANCE : Long Chen , **DATE:** Aug. 04, 2008
Responsible for RF
Long Chen / Senior Engineer

APPROVED BY : Gary Chang , **DATE:** Aug. 04, 2008
Gary Chang / Assistant Manager

2. SUMMARY OF TEST RESULTS

The EUT has been tested according to the following specifications:

APPLIED STANDARD: FCC Part 15, Subpart C			
STANDARD SECTION	TEST TYPE AND LIMIT	RESULT	REMARK
15.207	AC Power Conducted Emission	PASS	Meet the requirement of limit Minimum passing margin is -12.48dB at 2.074MHz.
15.247(a)(1)(iii)	Number of Hopping Frequency Used Spec.: At least 15 channels	PASS	Meet the requirement of limit.
15.247(a)(1)(iii)	Dwell Time on Each Channel Spec.: Max. 0.4 second within 31.6 second	PASS	Meet the requirement of limit.
15.247(a)(1)	1. Hopping Channel Separation Spec.: Min. 25 kHz or $\frac{2}{3} * 20$ dB bandwidth, whichever is greater 2. Spectrum Bandwidth of a Frequency Hopping Sequence Spread Spectrum System	PASS	Meet the requirement of limit.
15.247(b)	Maximum Peak Output Power Spec.: max. 21dBm	PASS	Meet the requirement of limit.
15.247(d)	Transmitter Radiated Emissions Spec.: Table 15.209	PASS	Meet the requirement of limit Minimum passing margin is -3.26dB at 101.84MHz.
15.247(d)	Band Edge Measurement	PASS	Meet the requirement of limit.

NOTE: If The Frequency Hopping System operating in 2400-2483.5MHz band and the output power less than 125mW. The hopping channel carrier frequencies separated by a minimum of 25kHz or two-thirds of the 20dB bandwidth of hopping channel whichever is greater.

2.1 MEASUREMENT UNCERTAINTY

Where relevant, the following measurement uncertainty levels have been estimated for tests performed on the EUT as specified in CISPR 16-4-2:

MEASUREMENT	FREQUENCY	UNCERTAINTY
Conducted emissions	9kHz ~ 30MHz	2.44 dB
Radiated emissions	30MHz ~ 200MHz	2.93 dB
	200MHz ~ 1000MHz	2.95 dB
	1GHz ~ 18GHz	2.26 dB
	18GHz ~ 40GHz	1.94 dB

This uncertainty represents an expanded uncertainty expressed at approximately the 95% confidence level using a coverage factor of $k=2$.

3. GENERAL INFORMATION

3.1 GENERAL DESCRIPTION OF EUT

EUT	Pocket PC Phone
MODEL NO.	SEDN100
FCC ID	NM8SEDN100
POWER SUPPLY	3.7Vdc from rechargeable lithium battery 5.0Vdc from power adapter 5.0Vdc from host equipment
MODULATION TYPE	Wireless LAN: CCK, DQPSK, DBPSK for DSSS 64QAM, 16QAM, QPSK, BPSK for OFDM Bluetooth: GFSK, $\pi/4$ -DQPSK, 8DPSK
MODULATION TECHNOLOGY	DSSS, OFDM, FHSS
TRANSFER RATE	Wireless LAN: 802.11b: 11/5.5/2/1Mbps 802.11g: 54/48/36/24/18/12/9/6Mbps Bluetooth: 1/2/3Mbps
FREQUENCY RANGE	2400 ~ 2483.5MHz
NUMBER OF CHANNEL	Wireless LAN: 11 Bluetooth: 79
CHANNEL SPACING	Wireless LAN: 5MHz Bluetooth: 1MHz
OUTPUT POWER	Wireless LAN: 113.240mW Bluetooth: 0.933mW
ANTENNA TYPE	Wireless LAN: PIFA antenna with 1dBi gain Bluetooth: PIFA antenna with 1dBi gain
DATA CABLE	1.28m shielded USB cable without core
I/O PORTS	Refer to user's manual
ACCESSORY DEVICES	Adapter, Battery, earphone (1.50m non-shielded cable without core)

NOTE:

1. The EUT is a Pocket PC Phone. The functions of EUT listed as below:

	TEST STANDARD	REFERENCE REPORT
WLAN 802.11b/g	FCC Part 15	RF970711L09-2
BLUETOOTH		RF970502L07-3
CDMA 850 / WCDMA 850	FCC Part 22	RF970502L07
CDMA 1900 / WCDMA 1900	FCC Part 24	RF970502L07-1

2. The communicated functions of EUT listed as below:

		GSM850MHz	PCS1900MHz	WCDMA850MHz	WCDMA1900MHz	With 802.11b/g WLAN + Bluetooth 2.0 w EDR
2G	GSM	√	√			
	GPRS	√	√			
	EDGE	√	√			
3G	WCDMA			√	√	
	Release 5 HSDPA			√	√	

3. The EUT has lithium batteries listed as below:

BATTERY :	
BRAND:	HTC
MODEL:	TRIN160
RATING:	3.7Vdc, 1500mAh

4. The EUT was operated with following power adapters:

ADAPTER A :	
BRAND:	PHIHONG
MODEL:	PSAA05A-050
INPUT:	100-240Vac, 200mA, 50-60Hz, 13-20VA
OUTPUT:	5Vdc, 1A
POWER LINE:	1.8m non-shielded cable without core

ADAPTER B :	
BRAND:	DELTA ELECTRONICS. INC.
MODEL:	ADP-5FH B
INPUT:	100-240Vac, 0.2A, 50-60Hz
OUTPUT:	5Vdc, 1A
POWER LINE:	1.8m non-shielded cable without core

5. The above EUT information was declared by manufacturer and for more detailed features description, please refer to the manufacturer's specifications or User's Manual.

3.2 DESCRIPTION OF TEST MODES

79 channels are provided to this EUT:

CHANNEL	FREQ. (MHz)	CHANNEL	FREQ. (MHz)	CHANNEL	FREQ. (MHz)	CHANNEL	FREQ. (MHz)
0	2402	20	2422	40	2442	60	2462
1	2403	21	2423	41	2443	61	2463
2	2404	22	2424	42	2444	62	2464
3	2405	23	2425	43	2445	63	2465
4	2406	24	2426	44	2446	64	2466
5	2407	25	2427	45	2447	65	2467
6	2408	26	2428	46	2448	66	2468
7	2409	27	2429	47	2449	67	2469
8	2410	28	2430	48	2450	68	2470
9	2411	29	2431	49	2451	69	2471
10	2412	30	2431	50	2452	70	2472
11	2413	31	2433	51	2453	71	2473
12	2414	32	2434	52	2454	72	2474
13	2415	33	2435	53	2455	73	2475
14	2416	34	2436	54	2456	74	2476
15	2417	35	2437	55	2457	75	2477
16	2418	36	2438	56	2458	76	2478
17	2419	37	2439	57	2459	77	2479
18	2420	38	2440	58	2460	78	2480
19	2421	39	2441	59	2461		

3.2.1 CONFIGURATION OF SYSTEM UNDER TEST

TEST MODE A

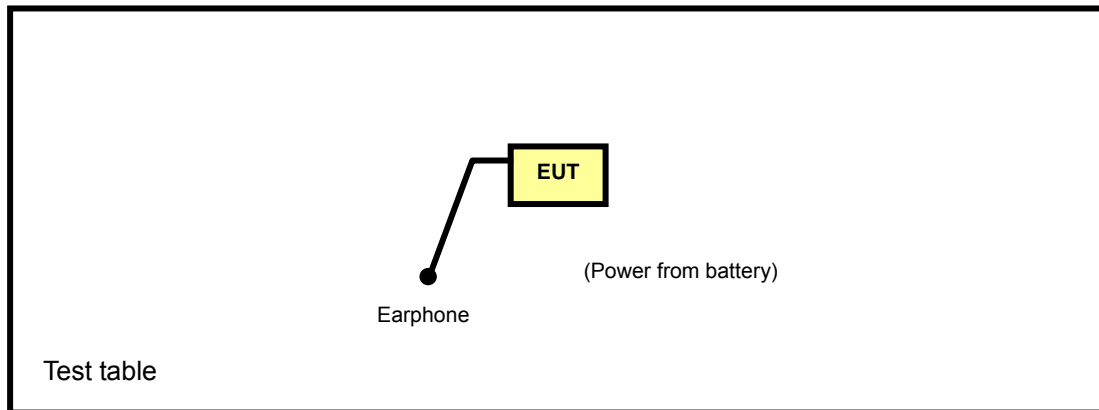

TEST MODE B & C

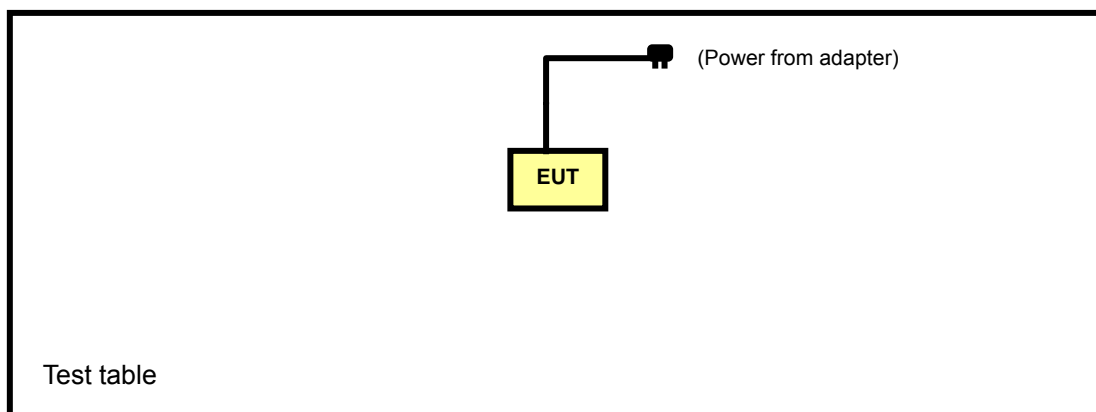

TEST MODE D

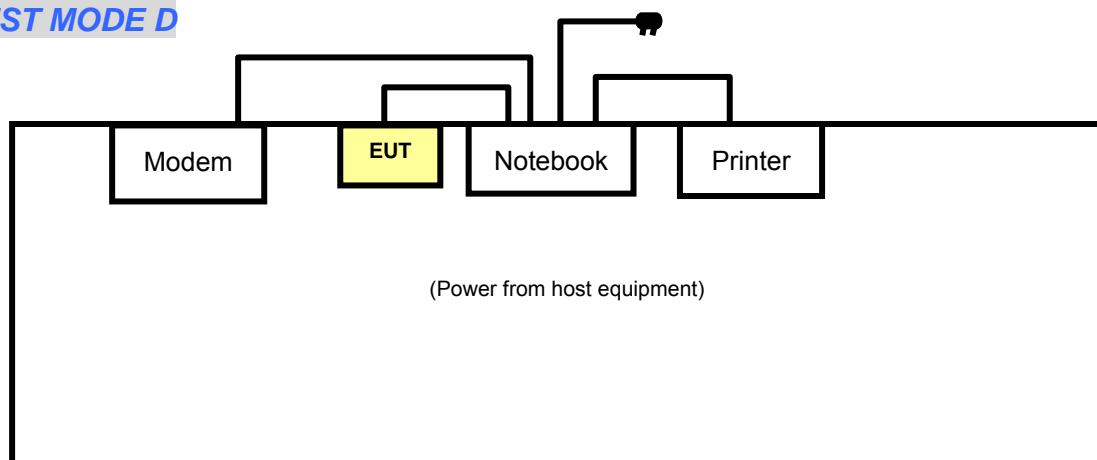

3.2.2 TEST MODE APPLICABILITY AND TESTED CHANNEL DETAIL

EUT CONFIGURE MODE	APPLICABLE TO				DESCRIPTION
	RE \geq 1G	RE $<$ 1G	PLC	APCM	
A	-	√	-	-	Power from battery
B	-	√	√	-	Power from adapter B
C	-	√	√	-	Power from adapter A
D	√	√	√	√	Power from host equipment

Where **PLC**: Power Line Conducted Emission **RE $<$ 1G**: Radiated Emission below 1GHz
RE \geq 1G: Radiated Emission above 1GHz **APCM**: Antenna Port Conducted Measurement

NOTE: “-“ means no effect.

RADIATED EMISSION TEST (ABOVE 1 GHz):

- Pre-Scan has been conducted to determine the worst-case mode from all possible combinations between available modulations, packet type, XYZ axis and antenna ports (if EUT with antenna diversity architecture) .
- Following channel(s) was (were) selected for the final test as listed below.

EUT CONFIGURE MODE	AVAILABLE CHANNEL	TESTED CHANNEL	MODULATION TECHNOLOGY	MODULATION TYPE	PACKET TYPE	AXIS
D	0 to 78	0, 39, 78	FHSS	GFSK	DH5	Z
D	0 to 78	0, 39, 78	FHSS	8DPSK	DH5	Z

RADIATED EMISSION TEST (BELOW 1 GHz):

- Pre-Scan has been conducted to determine the worst-case mode from all possible combinations between available modulations, packet type, XYZ axis and antenna ports (if EUT with antenna diversity architecture) .
- Following channel(s) was (were) selected for the final test as listed below.

EUT CONFIGURE MODE	AVAILABLE CHANNEL	TESTED CHANNEL	MODULATION TECHNOLOGY	MODULATION TYPE	PACKET TYPE	AXIS
A	0 to 78	0	FHSS	GFSK	DH5	Z
B	0 to 78	0	FHSS	GFSK	DH5	Z
C	0 to 78	0	FHSS	GFSK	DH5	Z
D	0 to 78	0	FHSS	GFSK	DH5	Z

POWER LINE CONDUCTED EMISSION TEST:

- Pre-Scan has been conducted to determine the worst-case mode from all possible combinations between available modulations, packet type and antenna ports (if EUT with antenna diversity architecture) .
- Following channel(s) was (were) selected for the final test as listed below.

EUT CONFIGURE MODE	AVAILABLE CHANNEL	TESTED CHANNEL	MODULATION TECHNOLOGY	MODULATION TYPE	PACKET TYPE
B	0 to 78	0	FHSS	GFSK	DH5
C	0 to 78	0	FHSS	GFSK	DH5
D	0 to 78	0	FHSS	GFSK	DH5

BANDEDGE MEASUREMENT:

- Pre-Scan has been conducted to determine the worst-case mode from all possible combinations between available modulations, packet type and antenna ports (if EUT with antenna diversity architecture) .
- Following channel(s) was (were) selected for the final test as listed below.

EUT CONFIGURE MODE	AVAILABLE CHANNEL	TESTED CHANNEL	MODULATION TECHNOLOGY	MODULATION TYPE	PACKET TYPE
D	0 to 78	0, 78	FHSS	GFSK	DH5
D	0 to 78	0, 78	FHSS	8DPSK	DH5

ANTENNA PORT CONDUCTED MEASUREMENT:

- Pre-Scan has been conducted to determine the worst-case mode from all possible combinations between available modulations, packet type and antenna ports (if EUT with antenna diversity architecture) .
- Following channel(s) was (were) selected for the final test as listed below.

EUT CONFIGURE MODE	AVAILABLE CHANNEL	TESTED CHANNEL	MODULATION TECHNOLOGY	MODULATION TYPE	PACKET TYPE
D	0 to 78	0, 39, 78	FHSS	GFSK	DH5
D	0 to 78	0, 39, 78	FHSS	8DPSK	DH5



3.3 GENERAL DESCRIPTION OF APPLIED STANDARDS

The EUT is a RF Product. According to the specifications of the manufacturer, it must comply with the requirements of the following standards:

FCC Part 15, Subpart C. (15.247)

ANSI C63.4-2003

All test items have been performed and recorded as per the above standards.

NOTE: The EUT is also considered as a kind of computer peripheral, because the connection to computer is necessary for typical use. It has been verified to comply with the requirements of FCC Part 15, Subpart B, Class B (DoC). The test report has been issued separately.



3.4 DESCRIPTION OF SUPPORT UNITS

The EUT has been tested as an independent unit together with other necessary accessories or support units. The following support units or accessories were used to form a representative test configuration during the tests.

NO.	PRODUCT	BRAND	MODEL NO.	SERIAL NO.	FCC ID
1	NOTEBOOK COMPUTER	DELL	PP05L	12130898320	E2K24CLNS
2	PRINTER	EPSON	LQ-300+	DCGY054146	FCC DoC Approved
3	MODEM	ACEEX	1414V/3	0401008260	IFAXDM1414

NO.	SIGNAL CABLE DESCRIPTION OF THE ABOVE SUPPORT UNITS
1	1.28m shielded USB cable without core
2	1.8m braid shielded wire, DB25 connector, w/o core.
3	1.2m braid shielded wire, DB25 & DB9 connector, w/o core.

NOTE: All power cords of the above support units are non shielded (1.8m).

4. TEST TYPES AND RESULTS

4.1 RADIATED EMISSION MEASUREMENT

4.1.1 LIMITS OF RADIATED EMISSION MEASUREMENT

Emissions radiated outside of the specified bands, shall be according to the general radiated limits in 15.209 as following:

FREQUENCIES (MHz)	FIELD STRENGTH (microvolts/meter)	MEASUREMENT DISTANCE (meters)
0.009 ~ 0.490	2400/F(kHz)	300
0.490 ~ 1.705	24000/F(kHz)	30
1.705 ~ 30.0	30	30
30 ~ 88	100	3
88 ~ 216	150	3
216 ~ 960	200	3
Above 960	500	3

NOTE:

1. The lower limit shall apply at the transition frequencies.
2. Emission level (dBuV/m) = 20 log Emission level (uV/m).
3. As shown in 15.35(b), for frequencies above 1000MHz, the field strength limits are based on average detector, however, the peak field strength of any emission shall not exceed the maximum permitted average limits, specified above by more than 20dB under any condition of modulation.



4.1.2 TEST INSTRUMENTS

DESCRIPTION & MANUFACTURER	MODEL NO.	SERIAL NO.	CALIBRATED UNTIL
Test Receiver ROHDE & SCHWARZ	ESIB7	100212	May. 27, 2009
Spectrum Analyzer ROHDE & SCHWARZ	FSP40	100269	Aug. 05, 2008
BILOG Antenna SCHWARZBECK	VULB9168	9168-156	Apr. 24, 2009
HORN Antenna SCHWARZBECK	BBHA 9120 D	9120D-563	Jul. 30, 2008
HORN Antenna SCHWARZBECK	BBHA 9170	BBHA9170242	Jan. 06, 2009
Preamplifier Agilent	8449B	3008A01911	Sep. 10, 2008
Preamplifier Agilent	8447D	2944A10634	Dec. 12, 2008
RF signal cable HUBER+SUHNER	SUCOFLEX 104	274039/223650	Nov. 07, 2008
RF signal cable Worken	8D-FB	Cable-HYCH9-01	Aug. 09, 2008
Software	ADT_Radiated_V7.6	NA	NA
Antenna Tower EMCO	2070/2080	512.835.4684	NA
Turn Table EMCO	2087-2.03	NA	NA
Antenna Tower & Turn Table Controller EMCO	2090	NA	NA
Turn Table Controller ADT.	SC100.	SC93021703	NA

- NOTE:**
1. The calibration interval of the above test instruments is 12 months and the calibrations are traceable to NML/ROC and NIST/USA.
 2. The test was performed in HwaYa Chamber 9.
 3. The horn antenna and HP preamplifier (model: 8449B) are used only for the measurement of emission frequency above 1GHz if tested.
 4. The FCC Site Registration No. is 215374.
 5. The IC Site Registration No. is IC3789B-9.

4.1.3 TEST PROCEDURES

- a. The EUT was placed on the top of a rotating table 0.8 meters above the ground at a 3 meter semi-anechoic chamber. The table was rotated 360 degrees to determine the position of the highest radiation.
- b. The EUT was set 3 meters away from the interference-receiving antenna, which was mounted on the top of a variable-height antenna tower.
- c. The antenna is a broadband antenna, and its height is varied from one meter to four meters above the ground to determine the maximum value of the field strength. Both horizontal and vertical polarizations of the antenna are set to make the measurement.
- d. For each suspected emission, the EUT was arranged to its worst case and then the antenna was tuned to heights from 1 meter to 4 meters and the rotatable table was turned from 0 degrees to 360 degrees to find the maximum reading.
- e. The test-receiver system was set to Peak Detect Function and Specified Bandwidth with Maximum Hold Mode.
- f. If the emission level of the EUT in peak mode was lower than the limit specified, then testing could be stopped and the peak values of the EUT would be reported. Otherwise the emissions would be re-tested one by one using peak, quasi-peak or average method as specified and then reported in a data sheet.

NOTE:

1. The resolution bandwidth and video bandwidth of test receiver/spectrum analyzer is 120kHz for Quasi-peak detection at frequency below 1GHz.
2. The resolution bandwidth of test receiver/spectrum analyzer is 1 MHz and video bandwidth is 3MHz for Peak detection at frequency above 1GHz.
3. All modes of operation were investigated and the worst-case emissions are reported.

4.1.4 DEVIATION FROM TEST STANDARD

No deviation

4.1.5 TEST SETUP

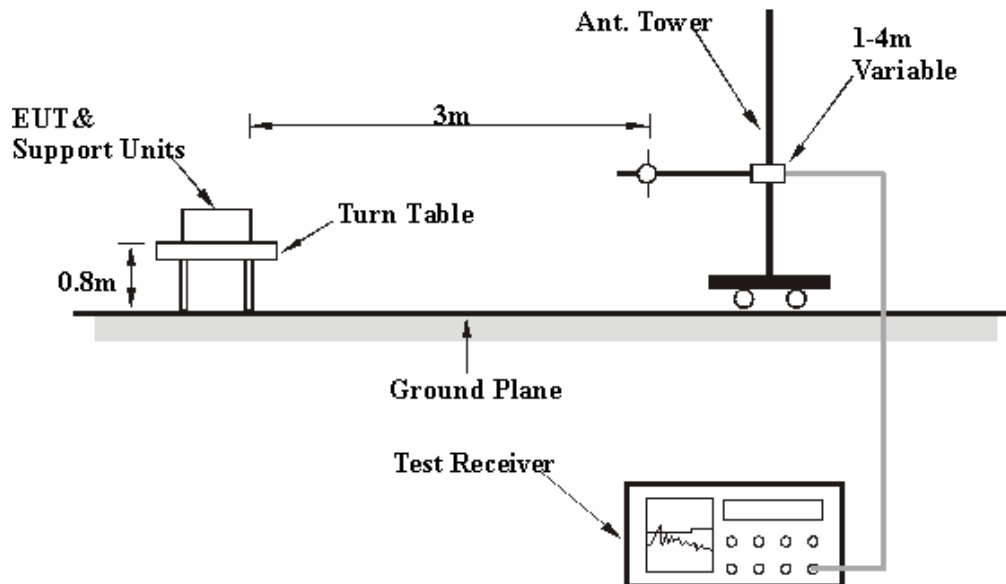

For the actual test configuration, please refer to the attached file (Test Setup Photo).

4.1.6 EUT OPERATING CONDITIONS

TEST MODE A, B & C

- Placed the EUT on a testing table.
- Use the software to control the EUT under transmission condition continuously at specific channel frequency.

TEST MODE D

- Connected the EUT to notebook and placed on a testing table.
- The notebook system ran a test program (provided by manufacturer) to enable EUT under transmission condition continuously at specific channel frequency.
- The necessary accessories enable the system in full functions.

4.1.7 TEST RESULTS

GFSK MODULATION

EUT TEST CONDITION		MEASUREMENT DETAIL	
CHANNEL	Channel 0	FREQUENCY RANGE	1 ~ 25GHz
INPUT POWER (SYSTEM)	120Vac, 60 Hz	DETECTOR FUNCTION	Peak (PK) Average (AV)
ENVIRONMENTAL CONDITIONS	27deg. C, 67%RH 999hPa	TESTED BY	Kevin Liang

ANTENNA POLARITY & TEST DISTANCE: HORIZONTAL AT 3 M								
NO.	FREQ. (MHz)	EMISSION LEVEL (dBuV/m)	LIMIT (dBuV/m)	MARGIN (dB)	ANTENNA HEIGHT (m)	TABLE ANGLE (Degree)	RAW VALUE (dBuV)	CORRECTION FACTOR (dB/m)
1	2390.00	41.41 PK	74.00	-32.59	1.17 H	359	7.93	33.48
2	2390.00	29.14 AV	54.00	-24.86	1.17 H	359	-4.34	33.48
3	*2402.00	93.57 PK			1.17 H	359	60.10	33.47
4	*2402.00	63.47 AV			1.17 H	359	30.00	33.47
5	4904.00	47.57 PK	74.00	-26.43	1.12 H	238	8.04	39.52
6	4904.00	17.47 AV	54.00	-36.53	1.12 H	238	-22.06	39.52

ANTENNA POLARITY & TEST DISTANCE: VERTICAL AT 3 M								
NO.	FREQ. (MHz)	EMISSION LEVEL (dBuV/m)	LIMIT (dBuV/m)	MARGIN (dB)	ANTENNA HEIGHT (m)	TABLE ANGLE (Degree)	RAW VALUE (dBuV)	CORRECTION FACTOR (dB/m)
1	2390.00	42.54 PK	74.00	-31.46	1.10 V	360	9.06	33.48
2	2390.00	29.54 AV	54.00	-24.46	1.10 V	360	-3.94	33.48
3	*2402.00	96.08 PK			1.10 V	14	62.61	33.47
4	*2402.00	65.98 AV			1.10 V	14	32.51	33.47
5	4804.00	48.26 PK	74.00	-25.74	1.29 V	177	8.97	39.29
6	4804.00	18.16 AV	54.00	-35.84	1.29 V	177	-21.13	39.29

- REMARKS:**
1. Emission level (dBuV/m) = Raw Value (dBuV) + Correction Factor (dB/m).
 2. Correction Factor (dB/m) = Antenna Factor (dB/m) + Cable Factor (dB).
 3. The other emission levels were very low against the limit.
 4. Margin value = Emission level – Limit value.
 5. “ * “: Fundamental frequency.
 6. The DH5 packet was the worse case duty cycle for a transmit dwell time on a channel, based upon bluetooth theory the transmitter is on 0.625 * 5 per 296.25 ms per channel. Therefore, the duty cycle correlation factor be equal to: $20\log(3.125 / 100) = -30.1$ dB.
 7. Average value = peak reading + $20\log(\text{duty cycle})$.

EUT TEST CONDITION		MEASUREMENT DETAIL	
CHANNEL	Channel 39	FREQUENCY RANGE	1 ~ 25GHz
INPUT POWER (SYSTEM)	120Vac, 60 Hz	DETECTOR FUNCTION	Peak (PK) Average (AV)
ENVIRONMENTAL CONDITIONS	27deg. C, 67%RH 999hPa	TESTED BY	Kevin Liang

ANTENNA POLARITY & TEST DISTANCE: HORIZONTAL AT 3 M								
NO.	FREQ. (MHz)	EMISSION LEVEL (dBuV/m)	LIMIT (dBuV/m)	MARGIN (dB)	ANTENNA HEIGHT (m)	TABLE ANGLE (Degree)	RAW VALUE (dBuV)	CORRECTION FACTOR (dB/m)
1	*2441.00	93.80 PK			1.13 H	329	60.33	33.47
2	*2441.00	63.70 AV			1.13 H	329	30.23	33.47
3	4882.00	47.65 PK	74.00	-26.35	1.20 H	116	8.19	39.47
4	4882.00	17.55 AV	54.00	-36.45	1.20 H	116	-21.91	39.47
ANTENNA POLARITY & TEST DISTANCE: VERTICAL AT 3 M								
NO.	FREQ. (MHz)	EMISSION LEVEL (dBuV/m)	LIMIT (dBuV/m)	MARGIN (dB)	ANTENNA HEIGHT (m)	TABLE ANGLE (Degree)	RAW VALUE (dBuV)	CORRECTION FACTOR (dB/m)
1	*2441.00	96.82 PK			1.58 V	20	63.35	33.47
2	*2441.00	66.72 AV			1.58 V	20	33.25	33.47
3	4882.00	48.47 PK	74.00	-25.53	1.29 V	114	9.01	39.47
4	4882.00	18.37 AV	54.00	-35.63	1.29 V	114	-21.09	39.47

- REMARKS:**
- Emission level (dBuV/m) = Raw Value (dBuV) + Correction Factor (dB/m).
 - Correction Factor (dB/m) = Antenna Factor (dB/m) + Cable Factor (dB).
 - The other emission levels were very low against the limit.
 - Margin value = Emission level – Limit value.
 - * *: Fundamental frequency.
 - The DH5 packet was the worse case duty cycle for a transmit dwell time on a channel, based upon bluetooth theory the transmitter is on $0.625 * 5$ per 296.25 ms per channel. Therefore, the duty cycle correlation factor be equal to: $20\log(3.125 / 100) = -30.1$ dB.
 - Average value = peak reading + $20\log(\text{duty cycle})$.

EUT TEST CONDITION		MEASUREMENT DETAIL	
CHANNEL	Channel 78	FREQUENCY RANGE	1 ~ 25GHz
INPUT POWER (SYSTEM)	120Vac, 60 Hz	DETECTOR FUNCTION	Peak (PK) Average (AV)
ENVIRONMENTAL CONDITIONS	27deg. C, 67%RH 999hPa	TESTED BY	Kevin Liang

ANTENNA POLARITY & TEST DISTANCE: HORIZONTAL AT 3 M								
NO.	FREQ. (MHz)	EMISSION LEVEL (dBuV/m)	LIMIT (dBuV/m)	MARGIN (dB)	ANTENNA HEIGHT (m)	TABLE ANGLE (Degree)	RAW VALUE (dBuV)	CORRECTION FACTOR (dB/m)
1	*2480.00	94.74 PK			1.00 H	321	61.27	33.47
2	*2480.00	64.64 AV			1.00 H	321	31.17	33.47
3	2483.50	36.80 PK	74.00	-37.20	1.00 H	321	3.33	33.47
4	2483.50	6.70 AV	54.00	-47.30	1.00 H	321	-26.77	33.47
5	4960.00	48.25 PK	74.00	-25.75	1.15 H	61	8.52	39.73
6	4960.00	18.15 AV	54.00	-35.85	1.15 H	61	-21.58	39.73
ANTENNA POLARITY & TEST DISTANCE: VERTICAL AT 3 M								
NO.	FREQ. (MHz)	EMISSION LEVEL (dBuV/m)	LIMIT (dBuV/m)	MARGIN (dB)	ANTENNA HEIGHT (m)	TABLE ANGLE (Degree)	RAW VALUE (dBuV)	CORRECTION FACTOR (dB/m)
1	*2480.00	96.79 PK			1.28 V	16	63.32	33.47
2	*2480.00	66.69 AV			1.28 V	16	33.22	33.47
3	2483.50	40.67 PK	74.00	-33.33	1.28 V	16	7.20	33.47
4	2483.50	10.57 AV	54.00	-43.43	1.28 V	16	-22.90	33.47
5	4960.00	47.71 PK	74.00	-26.29	1.27 V	256	7.98	39.73
6	4960.00	17.61 AV	54.00	-36.39	1.27 V	256	-22.12	39.73

- REMARKS:**
1. Emission level (dBuV/m) = Raw Value (dBuV) + Correction Factor (dB/m).
 2. Correction Factor (dB/m) = Antenna Factor (dB/m) + Cable Factor (dB).
 3. The other emission levels were very low against the limit.
 4. Margin value = Emission level – Limit value.
 5. “ * “: Fundamental frequency.
 6. The DH5 packet was the worse case duty cycle for a transmit dwell time on a channel, based upon bluetooth theory the transmitter is on 0.625 * 5 per 296.25 ms per channel. Therefore, the duty cycle correlation factor be equal to: $20\log(3.125 / 100) = -30.1$ dB.
 7. Average value = peak reading + $20\log(\text{duty cycle})$.

8DPSK MODULATION

EUT TEST CONDITION		MEASUREMENT DETAIL	
CHANNEL	Channel 0	FREQUENCY RANGE	1 ~ 25GHz
INPUT POWER (SYSTEM)	120Vac, 60 Hz	DETECTOR FUNCTION	Peak (PK) Average (AV)
ENVIRONMENTAL CONDITIONS	27deg. C, 67%RH 999hPa	TESTED BY	Kevin Liang

ANTENNA POLARITY & TEST DISTANCE: HORIZONTAL AT 3 M								
NO.	FREQ. (MHz)	EMISSION LEVEL (dBuV/m)	LIMIT (dBuV/m)	MARGIN (dB)	ANTENNA HEIGHT (m)	TABLE ANGLE (Degree)	RAW VALUE (dBuV)	CORRECTION FACTOR (dB/m)
1	2390.00	43.43 PK	74.00	-30.57	1.17 H	0	9.95	33.48
2	2390.00	29.05 AV	54.00	-24.95	1.17 H	0	-4.43	33.48
3	*2402.00	90.72 PK			1.17 H	0	57.25	33.47
4	*2402.00	60.62 AV			1.17 H	0	27.15	33.47
5	4804.00	47.47 PK	74.00	-26.53	1.36 H	52	8.18	39.29
6	4804.00	17.37 AV	54.00	-36.63	1.36 H	52	-21.92	39.29
ANTENNA POLARITY & TEST DISTANCE: VERTICAL AT 3 M								
NO.	FREQ. (MHz)	EMISSION LEVEL (dBuV/m)	LIMIT (dBuV/m)	MARGIN (dB)	ANTENNA HEIGHT (m)	TABLE ANGLE (Degree)	RAW VALUE (dBuV)	CORRECTION FACTOR (dB/m)
1	2390.00	45.44 PK	74.00	-28.56	1.09 V	13	11.96	33.48
2	2390.00	29.84 AV	54.00	-24.16	1.09 V	13	-3.64	33.48
3	*2402.00	93.21 PK			1.09 V	13	59.74	33.47
4	*2402.00	63.11 AV			1.09 V	13	29.64	33.47
5	4804.00	48.26 PK	74.00	-25.74	1.33 V	128	8.97	39.29
6	4804.00	18.16 AV	54.00	-35.84	1.33 V	128	-21.13	39.29

- REMARKS:**
1. Emission level (dBuV/m) = Raw Value (dBuV) + Correction Factor (dB/m).
 2. Correction Factor (dB/m) = Antenna Factor (dB/m) + Cable Factor (dB).
 3. The other emission levels were very low against the limit.
 4. Margin value = Emission level – Limit value.
 5. “ * “: Fundamental frequency.
 6. The DH5 packet was the worse case duty cycle for a transmit dwell time on a channel, based upon bluetooth theory the transmitter is on 0.625 * 5 per 296.25 ms per channel. Therefore, the duty cycle correlation factor be equal to: $20\log(3.125 / 100) = -30.1$ dB.
 7. Average value = peak reading + $20\log(\text{duty cycle})$.

EUT TEST CONDITION		MEASUREMENT DETAIL	
CHANNEL	Channel 39	FREQUENCY RANGE	1 ~ 25GHz
INPUT POWER (SYSTEM)	120Vac, 60 Hz	DETECTOR FUNCTION	Peak (PK) Average (AV)
ENVIRONMENTAL CONDITIONS	27deg. C, 67%RH 999hPa	TESTED BY	Kevin Liang

ANTENNA POLARITY & TEST DISTANCE: HORIZONTAL AT 3 M								
NO.	FREQ. (MHz)	EMISSION LEVEL (dBuV/m)	LIMIT (dBuV/m)	MARGIN (dB)	ANTENNA HEIGHT (m)	TABLE ANGLE (Degree)	RAW VALUE (dBuV)	CORRECTION FACTOR (dB/m)
1	*2441.00	92.12 PK			1.19 H	209	58.65	33.47
2	*2441.00	62.02 AV			1.19 H	209	28.55	33.47
3	4882.00	47.18 PK	74.00	-26.82	1.36 H	257	7.71	39.47
4	4882.00	17.08 AV	54.00	-36.92	1.36 H	257	-22.38	39.47
ANTENNA POLARITY & TEST DISTANCE: VERTICAL AT 3 M								
NO.	FREQ. (MHz)	EMISSION LEVEL (dBuV/m)	LIMIT (dBuV/m)	MARGIN (dB)	ANTENNA HEIGHT (m)	TABLE ANGLE (Degree)	RAW VALUE (dBuV)	CORRECTION FACTOR (dB/m)
1	*2441.00	94.22 PK			1.05 V	43	60.75	33.47
2	*2441.00	64.12 AV			1.05 V	43	30.65	33.47
3	4882.00	48.82 PK	74.00	-25.18	1.17 V	234	9.36	39.47
4	4882.00	18.72 AV	54.00	-35.28	1.17 V	234	-20.74	39.47

- REMARKS:**
- Emission level (dBuV/m) = Raw Value (dBuV) + Correction Factor (dB/m).
 - Correction Factor (dB/m) = Antenna Factor (dB/m) + Cable Factor (dB).
 - The other emission levels were very low against the limit.
 - Margin value = Emission level – Limit value.
 - * *: Fundamental frequency.
 - The DH5 packet was the worse case duty cycle for a transmit dwell time on a channel, based upon bluetooth theory the transmitter is on $0.625 * 5$ per 296.25 ms per channel. Therefore, the duty cycle correlation factor be equal to: $20\log(3.125 / 100) = -30.1$ dB.
 - Average value = peak reading + $20\log(\text{duty cycle})$.

EUT TEST CONDITION		MEASUREMENT DETAIL	
CHANNEL	Channel 78	FREQUENCY RANGE	1 ~ 25GHz
INPUT POWER (SYSTEM)	120Vac, 60 Hz	DETECTOR FUNCTION	Peak (PK) Average (AV)
ENVIRONMENTAL CONDITIONS	27deg. C, 67%RH 999hPa	TESTED BY	Kevin Liang

ANTENNA POLARITY & TEST DISTANCE: HORIZONTAL AT 3 M								
NO.	FREQ. (MHz)	EMISSION LEVEL (dBuV/m)	LIMIT (dBuV/m)	MARGIN (dB)	ANTENNA HEIGHT (m)	TABLE ANGLE (Degree)	RAW VALUE (dBuV)	CORRECTION FACTOR (dB/m)
1	*2480.00	91.67 PK			1.18 H	0	58.20	33.47
2	*2480.00	61.57 AV			1.18 H	0	28.10	33.47
3	2483.50	38.25 PK	74.00	-35.75	1.18 H	0	4.78	33.47
4	2483.50	8.15 AV	54.00	-45.85	1.18 H	0	-25.32	33.47
5	4960.00	47.70 PK	74.00	-26.30	1.18 H	0	7.97	39.73
6	4960.00	17.60 AV	54.00	-36.40	1.18 H	0	-22.13	39.73
ANTENNA POLARITY & TEST DISTANCE: VERTICAL AT 3 M								
NO.	FREQ. (MHz)	EMISSION LEVEL (dBuV/m)	LIMIT (dBuV/m)	MARGIN (dB)	ANTENNA HEIGHT (m)	TABLE ANGLE (Degree)	RAW VALUE (dBuV)	CORRECTION FACTOR (dB/m)
1	*2480.00	93.84 PK			1.05 V	43	60.37	33.47
2	*2480.00	63.74 AV			1.05 V	43	30.27	33.47
3	2483.50	41.31 PK	74.00	-32.69	1.05 V	43	7.84	33.47
4	2483.50	11.21 AV	54.00	-42.79	1.05 V	43	-22.26	33.47
5	4960.00	49.06 PK	74.00	-24.94	1.29 V	195	9.33	39.73
6	4960.00	18.96 AV	54.00	-35.04	1.29 V	195	-20.77	39.73

- REMARKS:**
1. Emission level (dBuV/m) = Raw Value (dBuV) + Correction Factor (dB/m).
 2. Correction Factor (dB/m) = Antenna Factor (dB/m) + Cable Factor (dB).
 3. The other emission levels were very low against the limit.
 4. Margin value = Emission level – Limit value.
 5. “ * “: Fundamental frequency.
 6. The DH5 packet was the worse case duty cycle for a transmit dwell time on a channel, based upon bluetooth theory the transmitter is on 0.625 * 5 per 296.25 ms per channel. Therefore, the duty cycle correlation factor be equal to: $20\log(3.125 / 100) = -30.1$ dB.
 7. Average value = peak reading + $20\log(\text{duty cycle})$.

BELOW 1GHz WORST-CASE DATA : GFSK MODULATION

EUT TEST CONDITION		MEASUREMENT DETAIL	
CHANNEL	Channel 0	FREQUENCY RANGE	Below 1000MHz
INPUT POWER (SYSTEM)	120Vac, 60 Hz	DETECTOR FUNCTION	Quasi-Peak
ENVIRONMENTAL CONDITIONS	27deg. C, 67%RH 999hPa	TESTED BY	Antony Lee
TEST MODE	A		

ANTENNA POLARITY & TEST DISTANCE: HORIZONTAL AT 3 M								
NO.	FREQ. (MHz)	EMISSION LEVEL (dBuV/m)	LIMIT (dBuV/m)	MARGIN (dB)	ANTENNA HEIGHT (m)	TABLE ANGLE (Degree)	RAW VALUE (dBuV)	CORRECTION FACTOR (dB/m)
1	84.34	35.06 QP	40.00	-4.94	2.00 H	26	26.53	8.53
2	230.16	24.32 QP	46.00	-21.68	1.50 H	125	12.43	11.89
3	269.05	19.04 QP	46.00	-26.96	1.00 H	10	5.96	13.09
4	582.08	22.60 QP	46.00	-23.40	1.50 H	37	1.52	21.08
5	821.23	23.55 QP	46.00	-22.45	1.00 H	175	-1.57	25.12
6	945.66	27.71 QP	46.00	-18.29	1.00 H	210	1.42	26.29
ANTENNA POLARITY & TEST DISTANCE: VERTICAL AT 3 M								
NO.	FREQ. (MHz)	EMISSION LEVEL (dBuV/m)	LIMIT (dBuV/m)	MARGIN (dB)	ANTENNA HEIGHT (m)	TABLE ANGLE (Degree)	RAW VALUE (dBuV)	CORRECTION FACTOR (dB/m)
1	84.34	35.55 QP	40.00	-4.45	1.00 V	121	27.02	8.53
2	162.11	23.08 QP	43.50	-20.42	2.00 V	43	9.57	13.52
3	173.78	23.64 QP	43.50	-19.86	1.00 V	253	10.95	12.69
4	241.83	29.09 QP	46.00	-16.91	1.00 V	10	16.67	12.41
5	821.23	23.65 QP	46.00	-22.35	1.50 V	175	-1.47	25.12
6	955.38	32.60 QP	46.00	-13.40	1.50 V	1	6.24	26.36

- REMARKS:**
1. Emission level (dBuV/m) = Raw Value (dBuV) + Correction Factor (dB/m).
 2. Correction Factor (dB/m) = Antenna Factor (dB/m) + Cable Factor (dB).
 3. The other emission levels were very low against the limit.
 4. Margin value = Emission level – Limit value.

EUT TEST CONDITION		MEASUREMENT DETAIL	
CHANNEL	Channel 0	FREQUENCY RANGE	Below 1000MHz
INPUT POWER (SYSTEM)	120Vac, 60 Hz	DETECTOR FUNCTION	Quasi-Peak
ENVIRONMENTAL CONDITIONS	27deg. C, 67%RH 999hPa	TESTED BY	Antony Lee
TEST MODE	B		

ANTENNA POLARITY & TEST DISTANCE: HORIZONTAL AT 3 M								
NO.	FREQ. (MHz)	EMISSION LEVEL (dBuV/m)	LIMIT (dBuV/m)	MARGIN (dB)	ANTENNA HEIGHT (m)	TABLE ANGLE (Degree)	RAW VALUE (dBuV)	CORRECTION FACTOR (dB/m)
1	131.00	27.18 QP	43.50	-16.32	1.50 H	280	15.02	12.16
2	158.22	23.42 QP	43.50	-20.08	1.50 H	67	9.72	13.70
3	241.83	24.05 QP	46.00	-21.95	1.25 H	226	11.63	12.41
4	278.77	23.41 QP	46.00	-22.59	1.00 H	268	10.16	13.25
5	543.19	26.47 QP	46.00	-19.53	1.00 H	187	6.32	20.15
6	945.66	29.36 QP	46.00	-16.64	2.00 H	121	3.07	26.29
ANTENNA POLARITY & TEST DISTANCE: VERTICAL AT 3 M								
NO.	FREQ. (MHz)	EMISSION LEVEL (dBuV/m)	LIMIT (dBuV/m)	MARGIN (dB)	ANTENNA HEIGHT (m)	TABLE ANGLE (Degree)	RAW VALUE (dBuV)	CORRECTION FACTOR (dB/m)
1	35.73	30.56 QP	40.00	-9.44	1.00 V	10	18.39	12.17
2	162.11	23.47 QP	43.50	-20.03	2.00 V	79	9.95	13.52
3	241.83	29.45 QP	46.00	-16.55	1.00 V	73	17.03	12.41
4	698.74	26.85 QP	46.00	-19.15	1.50 V	187	4.37	22.47
5	908.72	32.13 QP	46.00	-13.87	1.00 V	298	6.20	25.93
6	945.66	32.46 QP	46.00	-13.54	1.50 V	118	6.18	26.29

- REMARKS:**
1. Emission level (dBuV/m) = Raw Value (dBuV) + Correction Factor (dB/m).
 2. Correction Factor (dB/m) = Antenna Factor (dB/m) + Cable Factor (dB).
 3. The other emission levels were very low against the limit.
 4. Margin value = Emission level – Limit value.

EUT TEST CONDITION		MEASUREMENT DETAIL	
CHANNEL	Channel 0	FREQUENCY RANGE	Below 1000MHz
INPUT POWER (SYSTEM)	120Vac, 60 Hz	DETECTOR FUNCTION	Quasi-Peak
ENVIRONMENTAL CONDITIONS	27deg. C, 67%RH 999hPa	TESTED BY	Antony Lee
TEST MODE	C		

ANTENNA POLARITY & TEST DISTANCE: HORIZONTAL AT 3 M								
NO.	FREQ. (MHz)	EMISSION LEVEL (dBuV/m)	LIMIT (dBuV/m)	MARGIN (dB)	ANTENNA HEIGHT (m)	TABLE ANGLE (Degree)	RAW VALUE (dBuV)	CORRECTION FACTOR (dB/m)
1	131.00	25.91 QP	43.50	-17.59	1.50 H	223	13.75	12.16
2	173.78	24.43 QP	43.50	-19.07	1.25 H	262	11.74	12.69
3	543.19	25.50 QP	46.00	-20.50	1.00 H	10	5.35	20.15
4	599.58	31.88 QP	46.00	-14.12	1.00 H	262	10.38	21.50
5	698.74	32.86 QP	46.00	-13.14	1.00 H	262	10.39	22.47
6	947.60	29.02 QP	46.00	-16.98	1.25 H	322	2.71	26.31
ANTENNA POLARITY & TEST DISTANCE: VERTICAL AT 3 M								
NO.	FREQ. (MHz)	EMISSION LEVEL (dBuV/m)	LIMIT (dBuV/m)	MARGIN (dB)	ANTENNA HEIGHT (m)	TABLE ANGLE (Degree)	RAW VALUE (dBuV)	CORRECTION FACTOR (dB/m)
1	33.79	31.32 QP	40.00	-8.68	1.00 V	10	19.19	12.13
2	107.67	23.36 QP	43.50	-20.14	1.25 V	148	13.11	10.25
3	132.95	19.97 QP	43.50	-23.53	1.50 V	337	7.75	12.23
4	241.83	29.10 QP	46.00	-16.90	1.00 V	244	16.69	12.41
5	782.34	25.05 QP	46.00	-20.95	2.00 V	250	0.55	24.50
6	945.66	33.82 QP	46.00	-12.18	1.00 V	307	7.54	26.29

- REMARKS:**
1. Emission level (dBuV/m) = Raw Value (dBuV) + Correction Factor (dB/m).
 2. Correction Factor (dB/m) = Antenna Factor (dB/m) + Cable Factor (dB).
 3. The other emission levels were very low against the limit.
 4. Margin value = Emission level – Limit value.

EUT TEST CONDITION		MEASUREMENT DETAIL	
CHANNEL	Channel 0	FREQUENCY RANGE	Below 1000MHz
INPUT POWER (SYSTEM)	120Vac, 60 Hz	DETECTOR FUNCTION	Quasi-Peak
ENVIRONMENTAL CONDITIONS	27deg. C, 67%RH 999hPa	TESTED BY	Antony Lee
TEST MODE	D		

ANTENNA POLARITY & TEST DISTANCE: HORIZONTAL AT 3 M								
NO.	FREQ. (MHz)	EMISSION LEVEL (dBuV/m)	LIMIT (dBuV/m)	MARGIN (dB)	ANTENNA HEIGHT (m)	TABLE ANGLE (Degree)	RAW VALUE (dBuV)	CORRECTION FACTOR (dB/m)
1	101.84	38.59 QP	43.50	-4.91	1.50 H	115	29.05	9.54
2	214.61	33.90 QP	43.50	-9.60	1.00 H	127	22.70	11.20
3	399.31	31.31 QP	46.00	-14.69	1.00 H	55	15.33	15.98
4	533.47	28.44 QP	46.00	-17.56	2.00 H	355	8.52	19.92
5	599.58	31.26 QP	46.00	-14.74	1.50 H	109	9.76	21.50
6	817.34	31.66 QP	46.00	-14.34	1.50 H	172	6.57	25.09
ANTENNA POLARITY & TEST DISTANCE: VERTICAL AT 3 M								
NO.	FREQ. (MHz)	EMISSION LEVEL (dBuV/m)	LIMIT (dBuV/m)	MARGIN (dB)	ANTENNA HEIGHT (m)	TABLE ANGLE (Degree)	RAW VALUE (dBuV)	CORRECTION FACTOR (dB/m)
1	101.84	40.24 QP	43.50	-3.26	1.00 V	124	30.71	9.54
2	189.33	31.58 QP	43.50	-11.92	1.00 V	127	20.12	11.46
3	399.31	30.91 QP	46.00	-15.09	1.50 V	118	14.93	15.98
4	531.53	28.40 QP	46.00	-17.60	1.00 V	76	8.53	19.87
5	757.06	29.76 QP	46.00	-16.24	1.50 V	10	5.86	23.89
6	932.05	36.45 QP	46.00	-9.55	1.00 V	184	10.30	26.15

- REMARKS:**
1. Emission level (dBuV/m) = Raw Value (dBuV) + Correction Factor (dB/m).
 2. Correction Factor (dB/m) = Antenna Factor (dB/m) + Cable Factor (dB).
 3. The other emission levels were very low against the limit.
 4. Margin value = Emission level – Limit value.

4.2 CONDUCTED EMISSION MEASUREMENT

4.2.1 LIMITS OF CONDUCTED EMISSION MEASUREMENT

FREQUENCY OF EMISSION (MHz)	CONDUCTED LIMIT (dB μ V)	
	Quasi-peak	Average
0.15 ~ 0.5	66 to 56	56 to 46
0.5 ~ 5	56	46
5 ~ 30	60	50

- NOTE:**
1. The lower limit shall apply at the transition frequencies.
 2. The limit decreases in line with the logarithm of the frequency in the range of 0.15 to 0.50 MHz.
 3. All emanations from a class A/B digital device or system, including any network of conductors and apparatus connected thereto, shall not exceed the level of field strengths specified above.

4.2.2 TEST INSTRUMENTS

DESCRIPTION & MANUFACTURER	MODEL NO.	SERIAL NO.	CALIBRATED UNTIL
Test Receiver ROHDE & SCHWARZ	ESCS30	100288	Sep. 21, 2008
RF signal cable Woken	5D-FB	Cable-HYCO2-01	Jan. 03, 2009
LISN ROHDE & SCHWARZ	ESH2-Z5	100100	Jan. 06, 2009
LISN SCHWARZBECK	ESH3-Z5	100311	Jun. 30, 2009
Software ADT	ADT_Cond_V3	NA	NA

- NOTE:**
1. The calibration interval of the above test instruments is 12 months and the calibrations are traceable to NML/ROC and NIST/USA.
 2. The test was performed in HwaYa Shielded Room 2.
 3. The VCCI Site Registration No. is C-2047.

4.2.3 TEST PROCEDURES

- a. The EUT was placed 0.4 meters from the conducting wall of the shielded room with EUT being connected to the power mains through a line impedance stabilization network (LISN). Other support units were connected to the power mains through another LISN. The two LISNs provide 50 ohm/ 50uH of coupling impedance for the measuring instrument.
- b. Both lines of the power mains connected to the EUT were checked for maximum conducted interference.
- c. The frequency range from 150kHz to 30MHz was searched. Emission levels under (Limit - 20dB) was not recorded.

4.2.4 DEVIATION FROM TEST STANDARD

No deviation

4.2.5 TEST SETUP

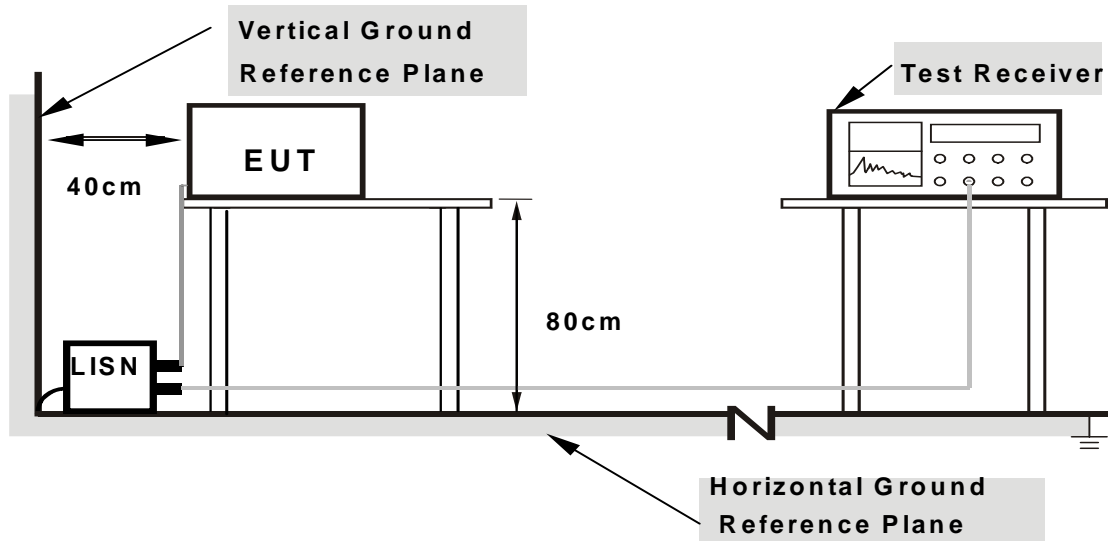

- Note:**
- 1.Support units were connected to second LISN.
 - 2.Both of LISNs (AMN) are 80 cm from EUT and at least 80 from other units and other metal planes

For the actual test configuration, please refer to the attached file (Test Setup Photo).

4.2.6 EUT OPERATING CONDITIONS

Same as 4.1.6.

4.2.7 TEST RESULTS

CONDUCTED WORST CASE DATA_8DPSK MODULATION

EUT TEST CONDITION		MEASUREMENT DETAIL	
CHANNEL	Channel 0	PHASE	Line 1
MODULATION TYPE	GFSK	6dB BANDWIDTH	9 kHz
ENVIRONMENTAL CONDITIONS	27deg. C, 66%RH, 991hPa	INPUT POWER (SYSTEM)	120Vac, 60 Hz
TESTED BY	Dean Wang	TEST MODE	B

No	Freq. [MHz]	Corr. Factor (dB)	Reading Value [dB (uV)]		Emission Level [dB (uV)]		Limit [dB (uV)]		Margin (dB)	
			Q.P.	AV.	Q.P.	AV.	Q.P.	AV.	Q.P.	AV.
1	0.184	0.13	32.23	-	32.36	-	64.31	54.31	-31.95	-
2	0.366	0.14	37.31	-	37.45	-	58.59	48.59	-21.14	-
3	0.490	0.14	39.31	-	39.45	-	56.17	46.17	-16.72	-
4	2.074	0.27	43.25	-	43.52	-	56.00	46.00	-12.48	-
5	2.380	0.29	42.87	-	43.16	-	56.00	46.00	-12.84	-
6	18.066	1.14	31.78	-	32.92	-	60.00	50.00	-27.08	-

- REMARKS:**
1. Q.P. and AV. are abbreviations of quasi-peak and average individually.
 2. "-": The Quasi-peak reading value also meets average limit and measurement with the average detector is unnecessary.
 3. The emission levels of other frequencies were very low against the limit.
 4. Margin value = Emission level - Limit value
 5. Correction factor = Insertion loss + Cable loss
 6. Emission Level = Correction Factor + Reading Value.

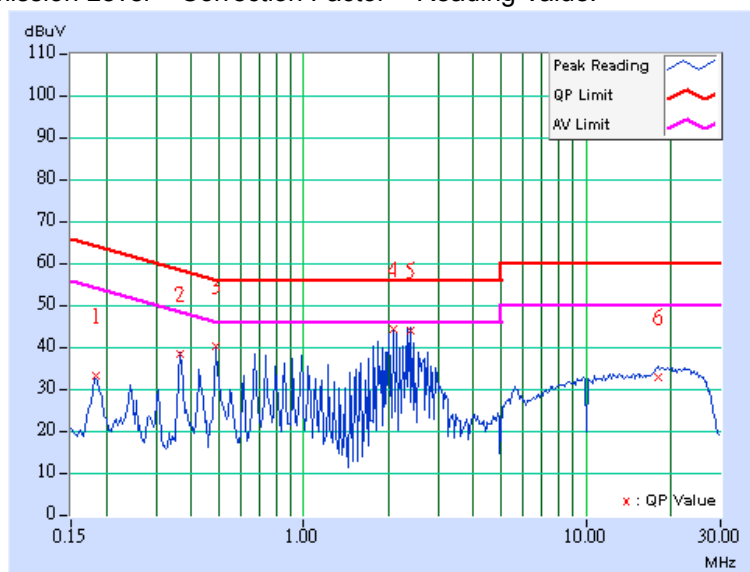

EUT TEST CONDITION		MEASUREMENT DETAIL	
CHANNEL	Channel 0	PHASE	Line 2
MODULATION TYPE	GFSK	6dB BANDWIDTH	9 kHz
ENVIRONMENTAL CONDITIONS	27deg. C, 66%RH, 991hPa	INPUT POWER (SYSTEM)	120Vac, 60 Hz
TESTED BY	Dean Wang	TEST MODE	B

No	Freq. [MHz]	Corr. Factor (dB)	Reading Value [dB (uV)]		Emission Level [dB (uV)]		Limit [dB (uV)]		Margin (dB)	
			Q.P.	AV.	Q.P.	AV.	Q.P.	AV.	Q.P.	AV.
1	0.183	0.14	34.21	-	34.35	-	64.34	54.34	-29.99	-
2	0.367	0.15	34.49	-	34.64	-	58.56	48.56	-23.92	-
3	0.490	0.15	37.40	-	37.55	-	56.17	46.17	-18.62	-
4	2.076	0.27	41.34	-	41.61	-	56.00	46.00	-14.39	-
5	2.382	0.29	41.26	-	41.55	-	56.00	46.00	-14.45	-
6	22.591	0.99	31.34	-	32.33	-	60.00	50.00	-27.67	-

- REMARKS:**
1. Q.P. and AV. are abbreviations of quasi-peak and average individually.
 2. "-": The Quasi-peak reading value also meets average limit and measurement with the average detector is unnecessary.
 3. The emission levels of other frequencies were very low against the limit.
 4. Margin value = Emission level - Limit value
 5. Correction factor = Insertion loss + Cable loss
 6. Emission Level = Correction Factor + Reading Value.

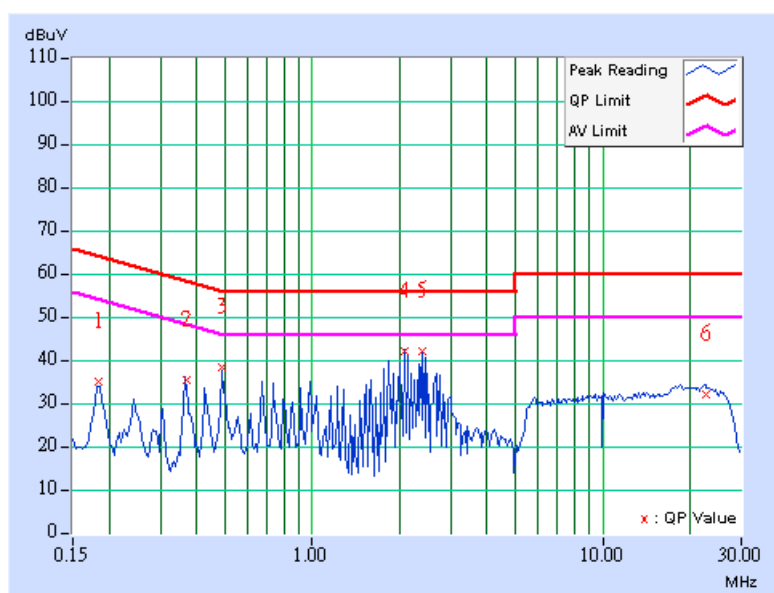

EUT TEST CONDITION		MEASUREMENT DETAIL	
CHANNEL	Channel 0	PHASE	Line 1
MODULATION TYPE	GFSK	6dB BANDWIDTH	9 kHz
ENVIRONMENTAL CONDITIONS	27deg. C, 66%RH, 991hPa	INPUT POWER (SYSTEM)	120Vac, 60 Hz
TESTED BY	Dean Wang	TEST MODE	C

No	Freq. [MHz]	Corr. Factor (dB)	Reading Value [dB (uV)]		Emission Level [dB (uV)]		Limit [dB (uV)]		Margin (dB)	
			Q.P.	AV.	Q.P.	AV.	Q.P.	AV.	Q.P.	AV.
1	0.280	0.13	37.12	-	37.25	-	60.81	50.81	-23.56	-
2	0.363	0.14	44.31	-	44.45	-	58.66	48.66	-14.21	-
3	0.416	0.14	38.95	-	39.09	-	57.53	47.53	-18.44	-
4	0.560	0.15	38.39	-	38.54	-	56.00	46.00	-17.46	-
5	2.023	0.26	37.28	-	37.54	-	56.00	46.00	-18.46	-
6	7.203	0.54	35.48	-	36.02	-	60.00	50.00	-23.98	-

- REMARKS:**
1. Q.P. and AV. are abbreviations of quasi-peak and average individually.
 2. "-": The Quasi-peak reading value also meets average limit and measurement with the average detector is unnecessary.
 3. The emission levels of other frequencies were very low against the limit.
 4. Margin value = Emission level - Limit value
 5. Correction factor = Insertion loss + Cable loss
 6. Emission Level = Correction Factor + Reading Value.

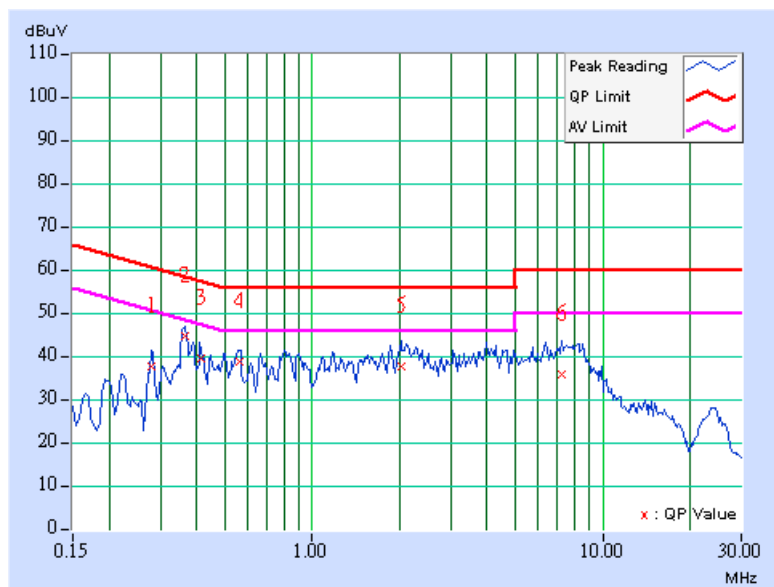

EUT TEST CONDITION		MEASUREMENT DETAIL	
CHANNEL	Channel 0	PHASE	Line 2
MODULATION TYPE	GFSK	6dB BANDWIDTH	9 kHz
ENVIRONMENTAL CONDITIONS	27deg. C, 66%RH, 991hPa	INPUT POWER (SYSTEM)	120Vac, 60 Hz
TESTED BY	Dean Wang	TEST MODE	C

No	Freq.	Corr.	Reading Value		Emission Level		Limit		Margin	
	[MHz]	Factor (dB)	[dB (uV)]		[dB (uV)]		[dB (uV)]		(dB)	
			Q.P.	AV.	Q.P.	AV.	Q.P.	AV.	Q.P.	AV.
1	0.224	0.14	37.44	-	37.58	-	62.66	52.66	-25.08	-
2	0.363	0.15	42.37	-	42.52	-	58.66	48.66	-16.14	-
3	0.416	0.15	39.78	-	39.93	-	57.54	47.54	-17.60	-
4	0.810	0.17	36.97	-	37.14	-	56.00	46.00	-18.86	-
5	2.285	0.28	37.54	-	37.82	-	56.00	46.00	-18.18	-
6	7.637	0.51	32.25	-	32.76	-	60.00	50.00	-27.24	-

- REMARKS:**
1. Q.P. and AV. are abbreviations of quasi-peak and average individually.
 2. "-": The Quasi-peak reading value also meets average limit and measurement with the average detector is unnecessary.
 3. The emission levels of other frequencies were very low against the limit.
 4. Margin value = Emission level - Limit value
 5. Correction factor = Insertion loss + Cable loss
 6. Emission Level = Correction Factor + Reading Value.

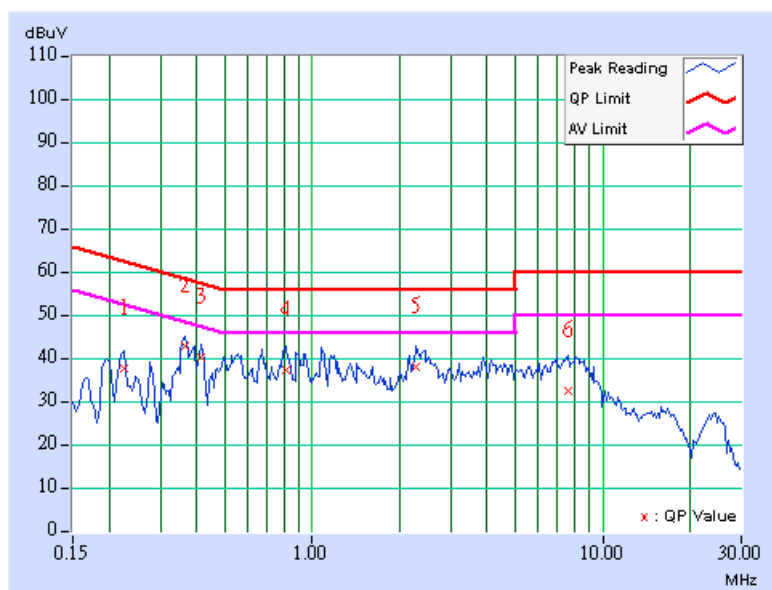

EUT TEST CONDITION		MEASUREMENT DETAIL	
CHANNEL	Channel 0	PHASE	Line 1
MODULATION TYPE	GFSK	6dB BANDWIDTH	9 kHz
ENVIRONMENTAL CONDITIONS	27deg. C, 66%RH, 991hPa	INPUT POWER (SYSTEM)	120Vac, 60 Hz
TESTED BY	Dean Wang	TEST MODE	D

No	Freq. [MHz]	Corr. Factor (dB)	Reading Value [dB (uV)]		Emission Level [dB (uV)]		Limit [dB (uV)]		Margin (dB)	
			Q.P.	AV.	Q.P.	AV.	Q.P.	AV.	Q.P.	AV.
1	0.158	0.13	40.09	-	40.22	-	65.58	55.58	-25.36	-
2	0.224	0.13	41.50	-	41.63	-	62.66	52.66	-21.03	-
3	0.240	0.13	38.38	-	38.51	-	62.09	52.09	-23.58	-
4	1.469	0.21	26.12	-	26.33	-	56.00	46.00	-29.67	-
5	1.945	0.26	28.57	-	28.83	-	56.00	46.00	-27.17	-
6	9.441	0.60	34.08	-	34.68	-	60.00	50.00	-25.32	-

- REMARKS:**
1. Q.P. and AV. are abbreviations of quasi-peak and average individually.
 2. "-": The Quasi-peak reading value also meets average limit and measurement with the average detector is unnecessary.
 3. The emission levels of other frequencies were very low against the limit.
 4. Margin value = Emission level - Limit value
 5. Correction factor = Insertion loss + Cable loss
 6. Emission Level = Correction Factor + Reading Value.

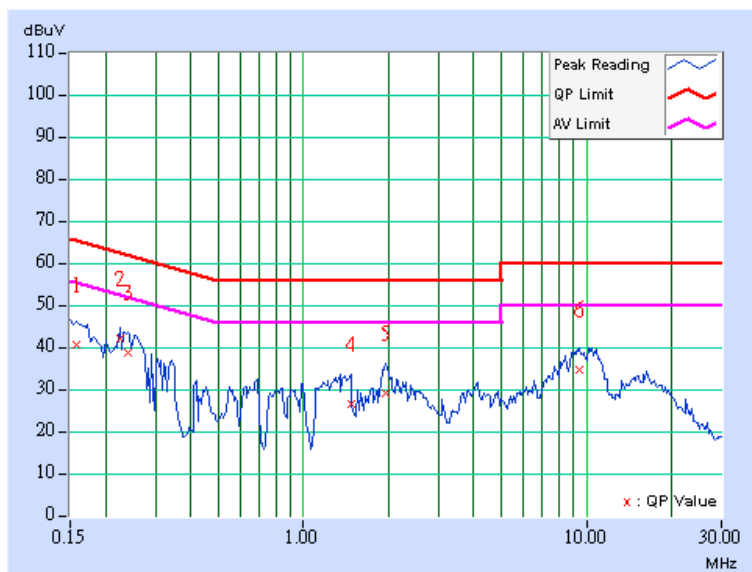

EUT TEST CONDITION		MEASUREMENT DETAIL	
CHANNEL	Channel 0	PHASE	Line 2
MODULATION TYPE	GFSK	6dB BANDWIDTH	9 kHz
ENVIRONMENTAL CONDITIONS	27deg. C, 66%RH, 991hPa	INPUT POWER (SYSTEM)	120Vac, 60 Hz
TESTED BY	Dean Wang	TEST MODE	D

No	Freq. [MHz]	Corr. Factor (dB)	Reading Value [dB (uV)]		Emission Level [dB (uV)]		Limit [dB (uV)]		Margin (dB)	
			Q.P.	AV.	Q.P.	AV.	Q.P.	AV.	Q.P.	AV.
1	0.172	0.14	42.72	-	42.86	-	64.84	54.84	-21.98	-
2	0.220	0.14	39.36	-	39.50	-	62.81	52.81	-23.31	-
3	0.236	0.14	38.87	-	39.01	-	62.24	52.24	-23.23	-
4	0.685	0.16	30.70	-	30.86	-	56.00	46.00	-25.14	-
5	1.902	0.25	28.13	-	28.38	-	56.00	46.00	-27.62	-
6	8.879	0.54	33.66	-	34.20	-	60.00	50.00	-25.80	-

- REMARKS:**
1. Q.P. and AV. are abbreviations of quasi-peak and average individually.
 2. "-": The Quasi-peak reading value also meets average limit and measurement with the average detector is unnecessary.
 3. The emission levels of other frequencies were very low against the limit.
 4. Margin value = Emission level - Limit value
 5. Correction factor = Insertion loss + Cable loss
 6. Emission Level = Correction Factor + Reading Value.

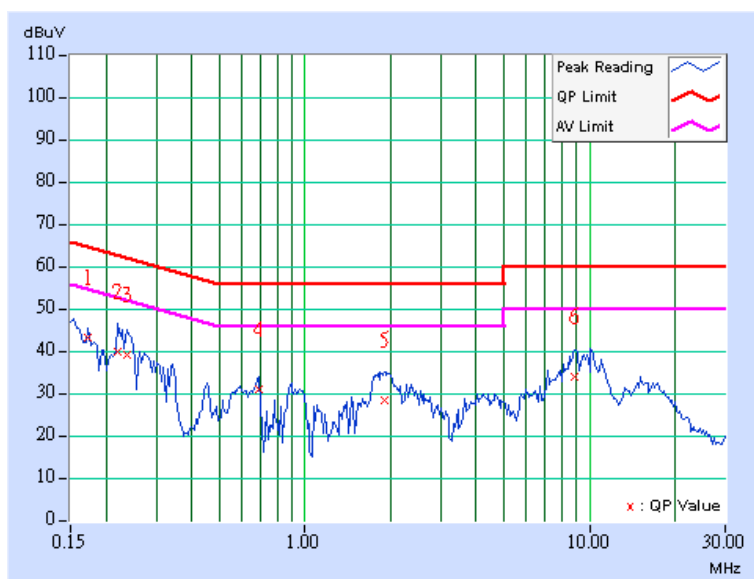



4.3 NUMBER OF HOPPING FREQUENCY USED

4.3.1 LIMITS OF HOPPING FREQUENCY USED

At least 15 channels frequencies, and should be equally spaced.

4.3.2 TEST INSTRUMENTS

DESCRIPTION & MANUFACTURER	MODEL NO.	SERIAL NO.	CALIBRATED UNTIL
SPECTRUM ANALYZER	FSP40	100040	Jul. 03, 2009

NOTE: The calibration interval of the above test instruments is 12 months. And the calibrations are traceable to NML/ROC and NIST/USA.

4.3.3 TEST PROCEDURES

- a. Check the calibration of the measuring instrument (SA) using either an internal calibrator or a known signal from an external generator.
- b. Turn on the EUT and connect its antenna terminal to measurement via a low loss cable. Then set it to any one measured frequency within its operating range and make sure the instrument is operated in its linear range.
- c. Set the SA on MaxHold Mode, and then keep the EUT in hopping mode. Record all the signals from each channel until each one has been recorded.
- d. Set the SA on View mode and then plot the result on SA screen.
- e. Repeat above procedures until all frequencies measured were complete.

4.3.4 DEVIATION FROM TEST STANDARD

No deviation.

4.3.5 TEST SETUP

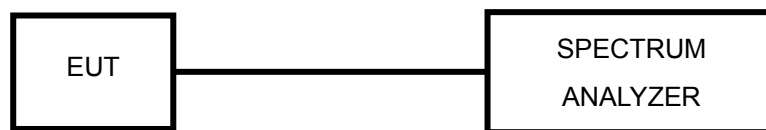

4.3.6 TEST RESULTS

There are 79 hopping frequencies in the hopping mode. Please refer to next two pages for the test result. On the plots, it shows that the hopping frequencies are equally spaced.

GFSK MODULATION

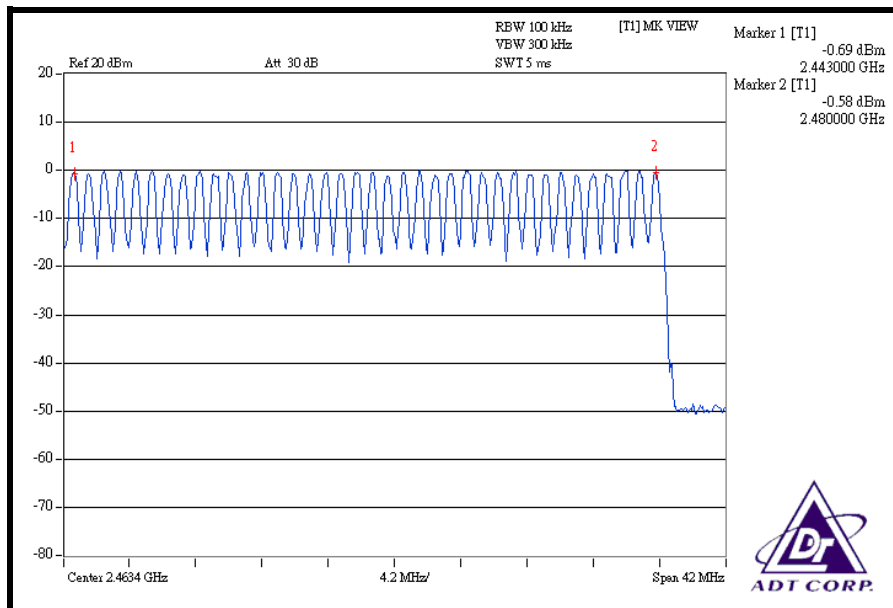
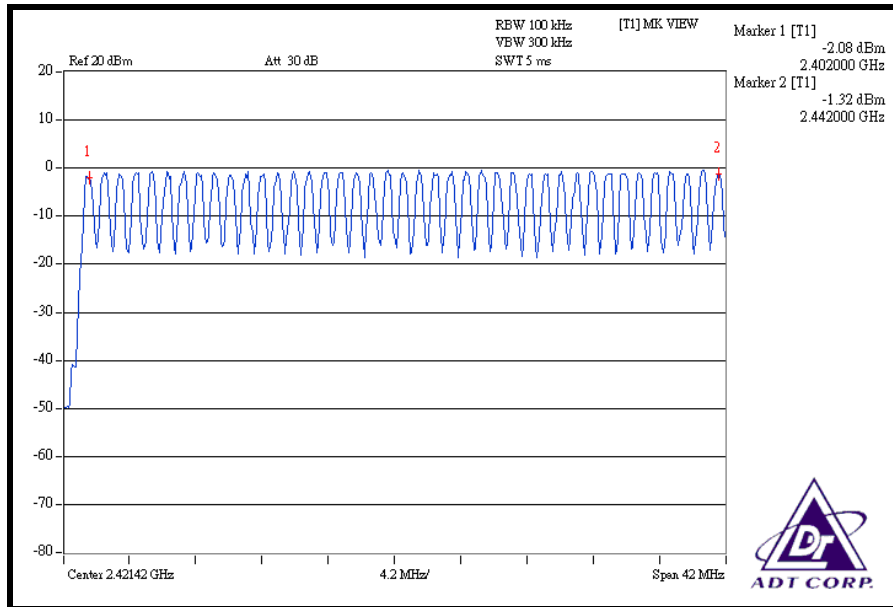

8DPSK MODULATION

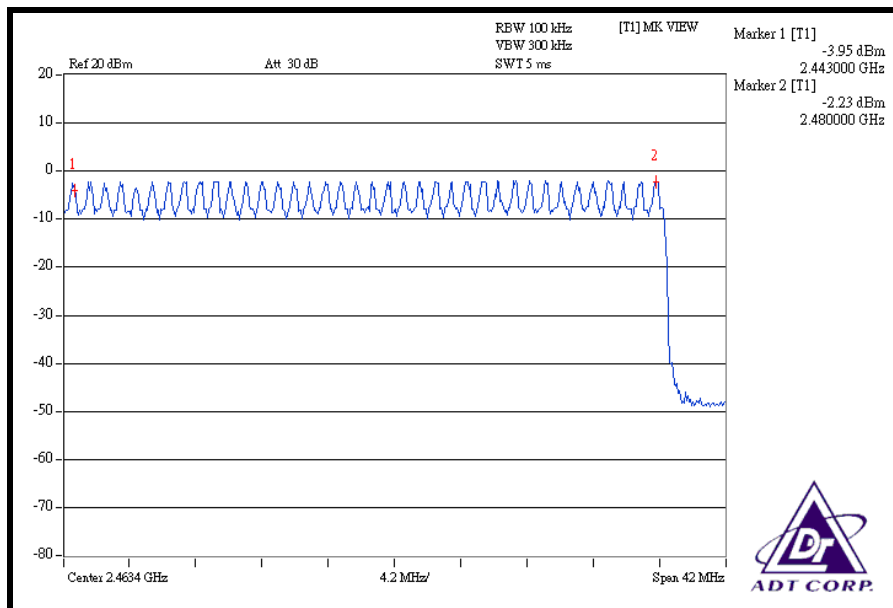
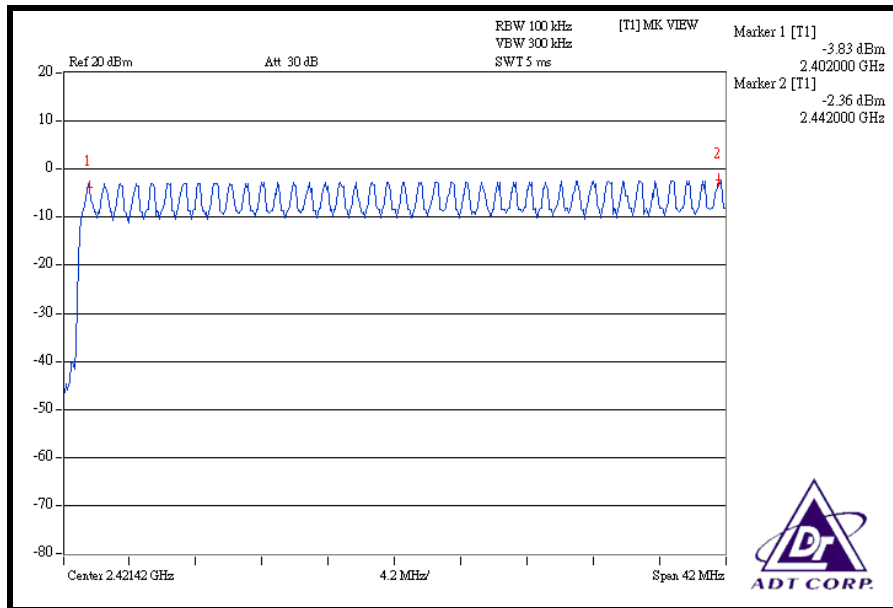



4.4 DWELL TIME ON EACH CHANNEL

4.4.1 LIMIT OF DWELL TIME USED

The average time of occupancy on any channel shall not be greater than 0.4 seconds within a period of 0.4 seconds multiplied by the number of hopping channels employed.

4.4.2 TEST INSTRUMENTS

DESCRIPTION & MANUFACTURER	MODEL NO.	SERIAL NO.	CALIBRATED UNTIL
SPECTRUM ANALYZER	FSP40	100040	Jul. 03, 2009

NOTES: The calibration interval of the above test instruments is 12 months. And the calibrations are traceable to NML/ROC and NIST/USA.

4.4.3 TEST PROCEDURES

- a. Check the calibration of the measuring instrument (SA) using either an internal calibrator or a known signal from an external generator.
- b. Turn on the EUT and connect its antenna terminal to measurement via a low loss cable. Then set it to any one measured frequency within its operating range and make sure the instrument is operated in its linear range.
- c. Adjust the center frequency of SA on any frequency be measured and set SA to zero span mode. And then, set RBW and VBW of spectrum analyzer to proper value.
- d. Measure the time duration of one transmission on the measured frequency. And then plot the result with time difference of this time duration.
- e. Repeat above procedures until all different time-slot modes have been completed.

4.4.4 DEVIATION FROM TEST STANDARD

No deviation.

4.4.5 TEST SETUP

Same as 4.3.5.

4.4.6 TEST RESULTS

GFSK MODULATION

Mode	Number of transmission in a 31.6 (79Hopping*0.4)	Length of transmission time (msec)	Result (msec)	Limit (msec)
DH1	50 (times / 5 sec) * 6.32 = 316.00 times	0.456	144.096	400
DH3	25 (times / 5 sec) * 6.32 = 158.00 times	1.728	273.024	400
DH5	18 (times / 5 sec) * 6.32 = 113.76 times	2.970	337.867	400

NOTE: Test plots of the transmitting time slot are shown on next 3 pages.

DH1

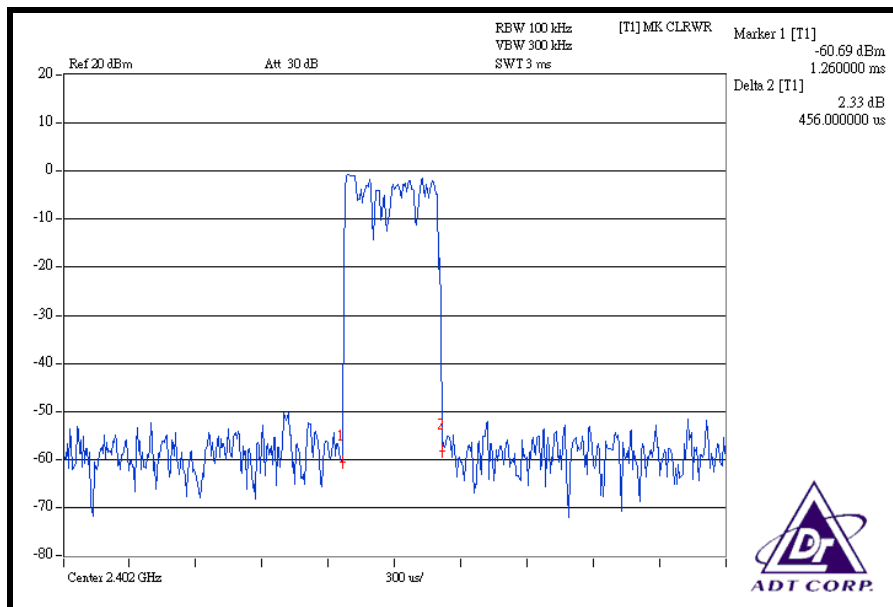
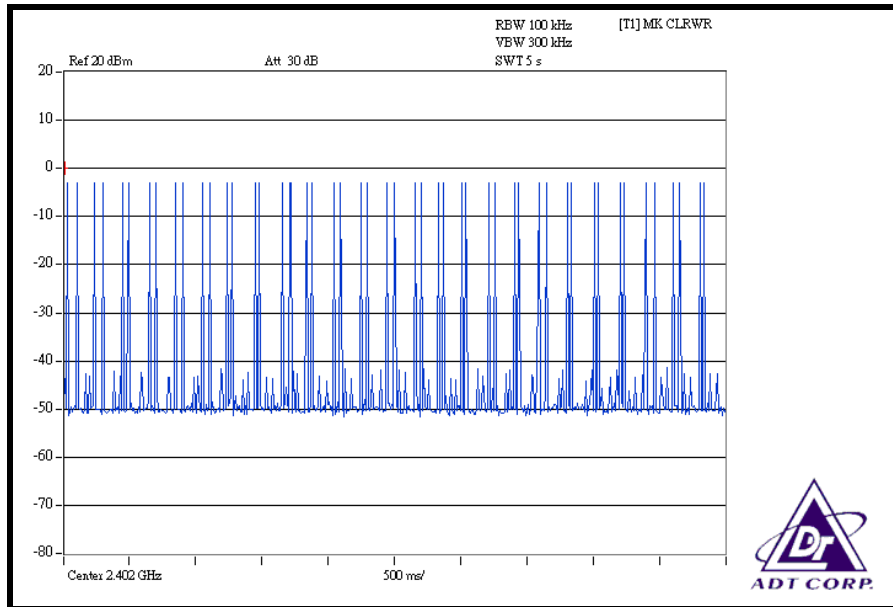

DH3

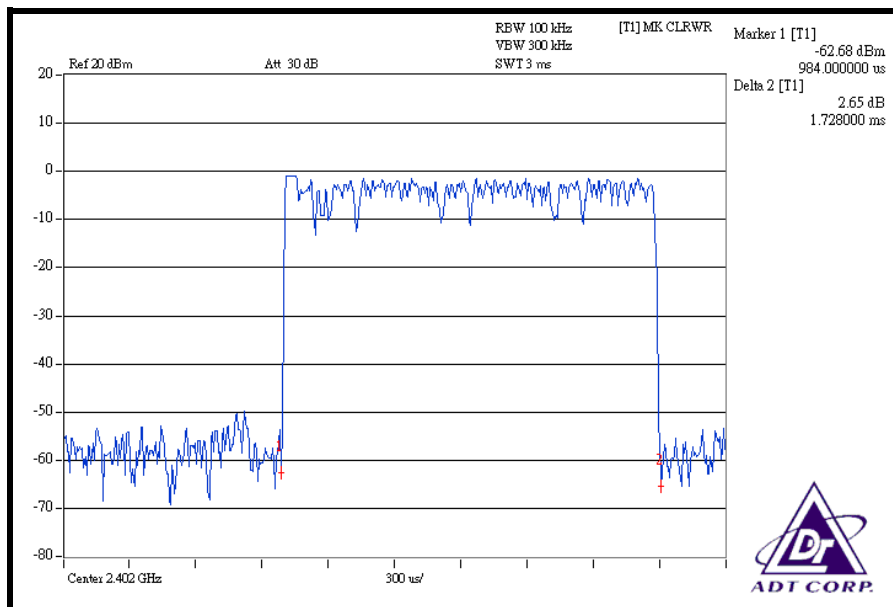
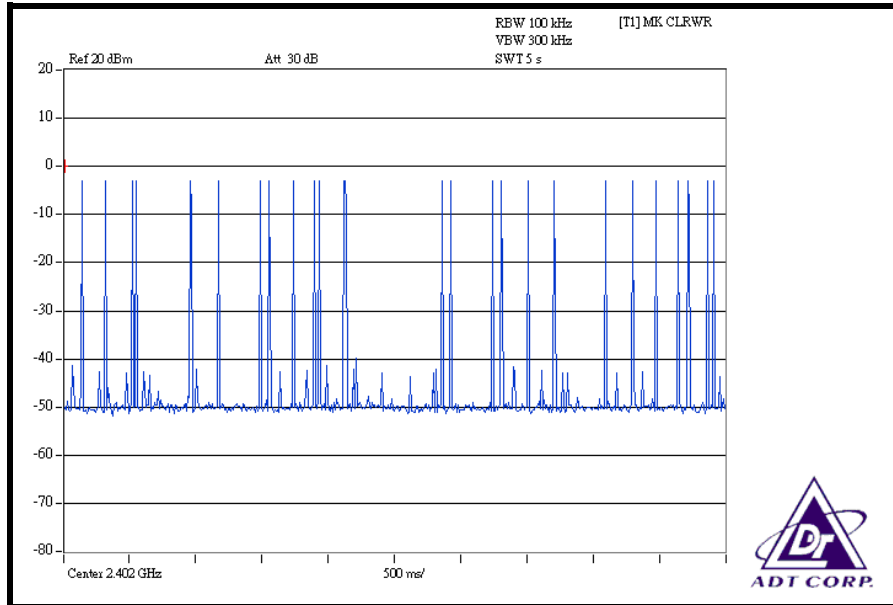

DH5

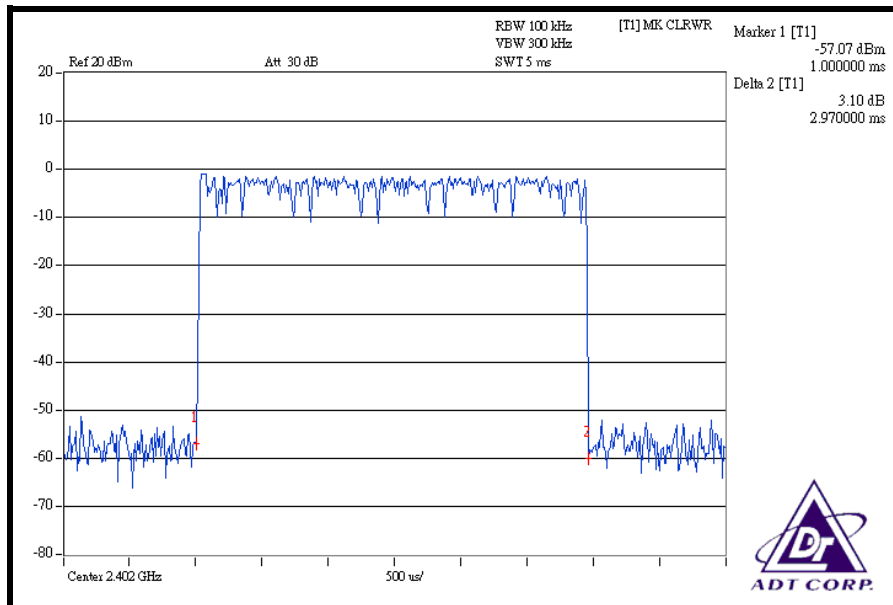
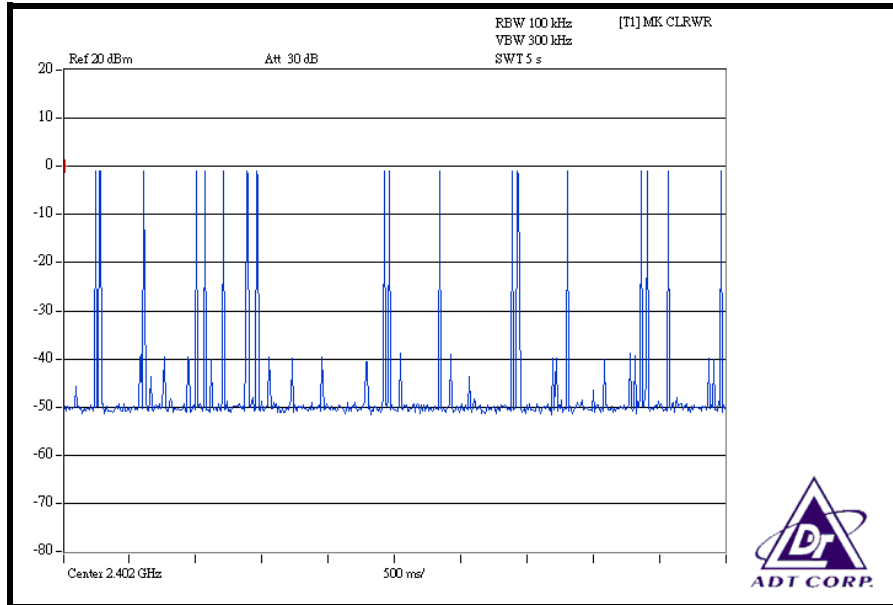

8DPSK MODULATION

Mode	Number of transmission in a 31.6 (79Hopping*0.4)	Length of transmission time (msec)	Result (msec)	Limit (msec)
DH1	$50 \text{ (times / 5 sec)} * 6.32 = 316.00 \text{ times}$	0.474	149.784	400
DH3	$27 \text{ (times / 5 sec)} * 6.32 = 170.64 \text{ times}$	1.734	295.890	400
DH5	$16 \text{ (times / 5 sec)} * 6.32 = 101.12 \text{ times}$	2.990	302.349	400

NOTE: Test plots of the transmitting time slot are shown on next 3 pages.

DH1

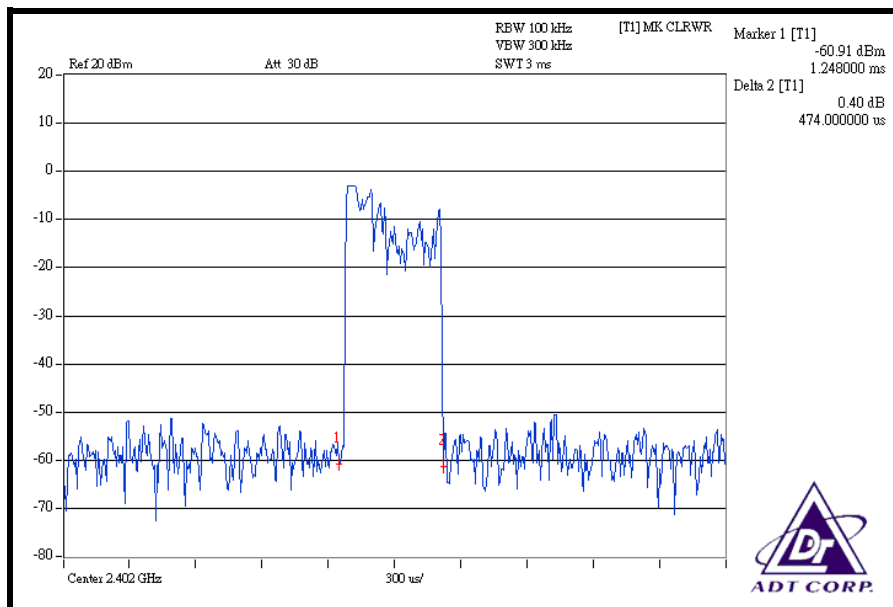
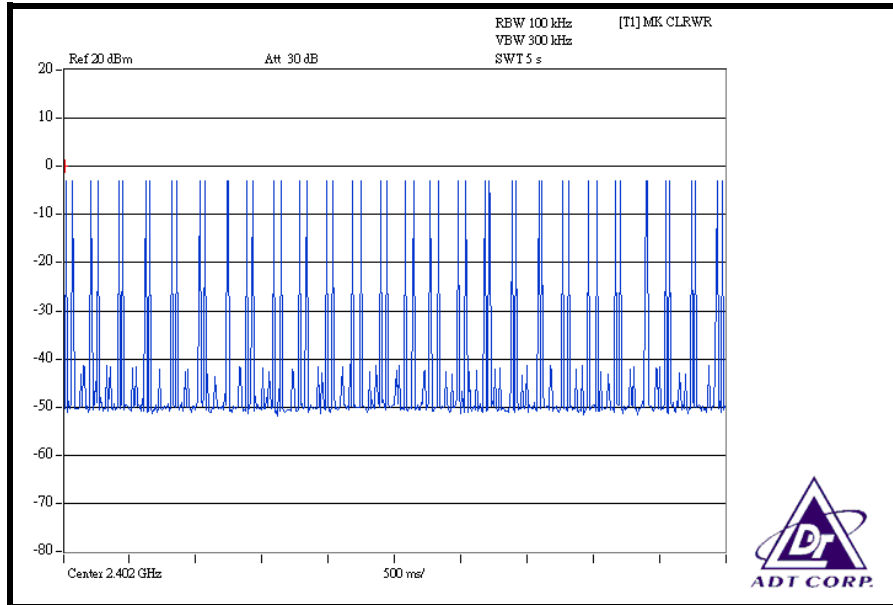

DH3

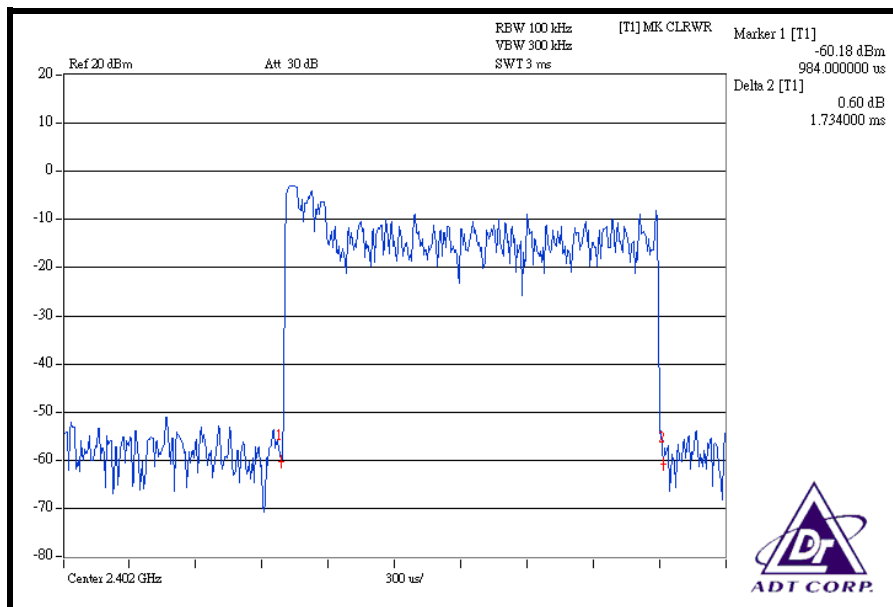
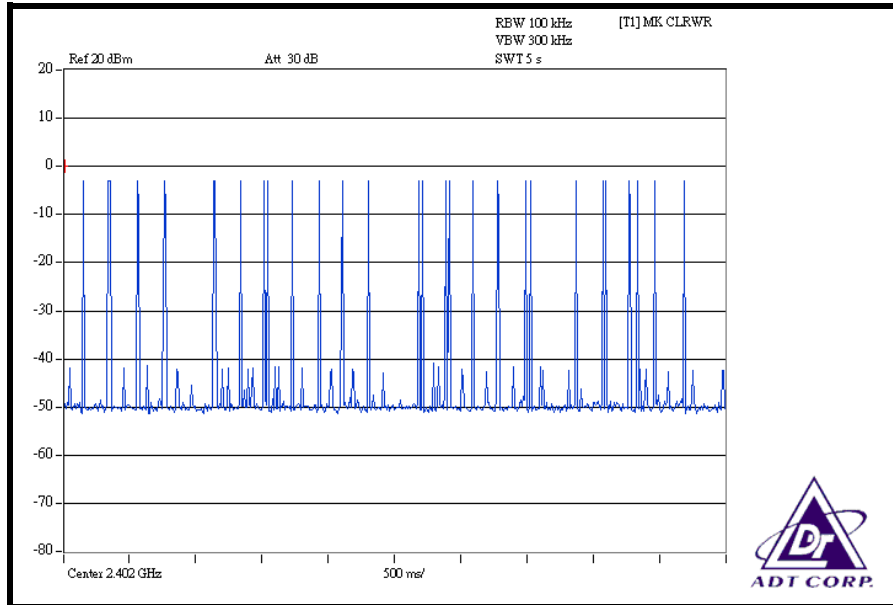

DH5

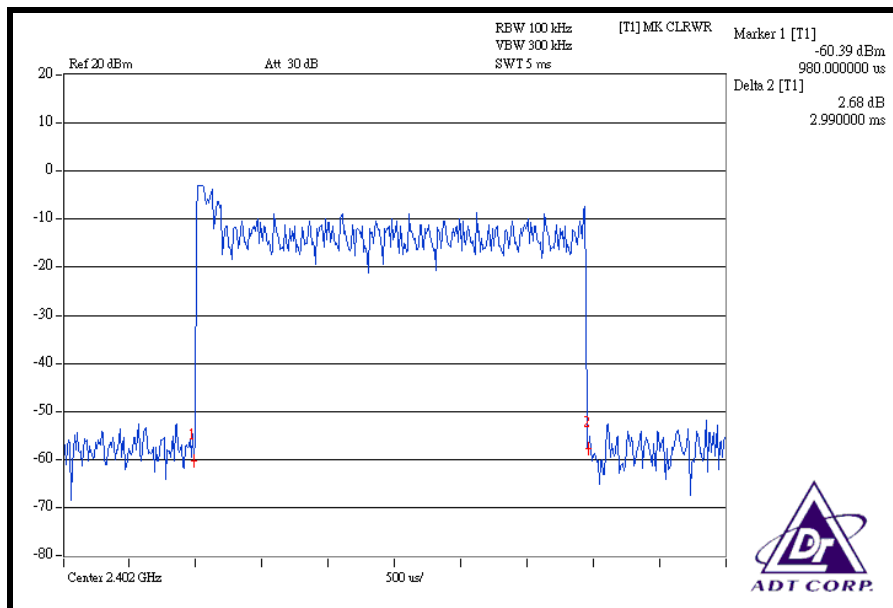
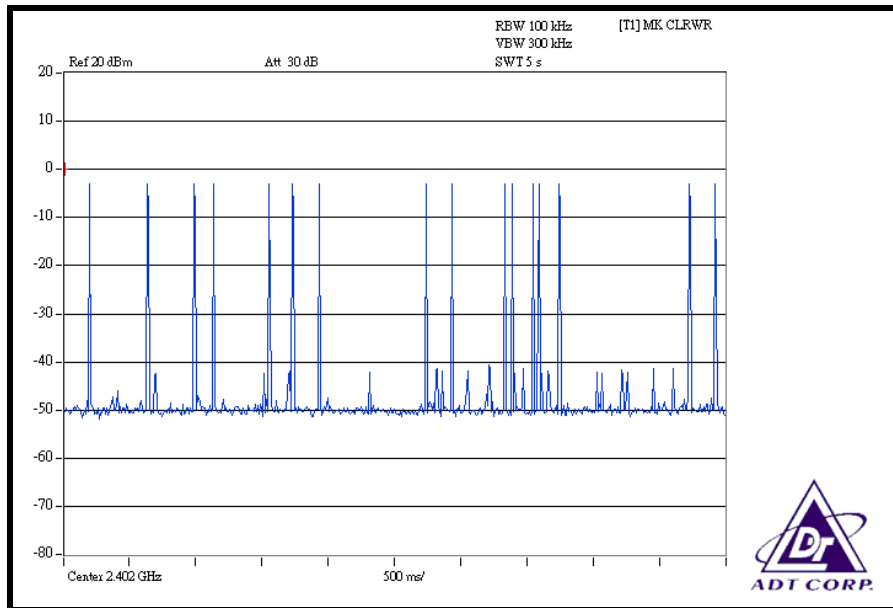



4.5 CHANNEL BANDWIDTH

4.5.1 LIMITS OF CHANNEL BANDWIDTH

For frequency hopping system operating in the 2400-2483.5MHz, If the 20dB bandwidth of hopping channel is greater than 25kHz, two-thirds 20dB bandwidth of hopping channel shall be a minimum limit for the hopping channel separation.

4.5.2 TEST INSTRUMENTS

DESCRIPTION & MANUFACTURER	MODEL NO.	SERIAL NO.	CALIBRATED UNTIL
SPECTRUM ANALYZER	FSP40	100040	Jul. 03, 2009

NOTE: The calibration interval of the above test instruments is 12 months. And the calibrations are traceable to NML/ROC and NIST/USA.

4.5.3 TEST PROCEDURE

- a. Check the calibration of the measuring instrument using either an internal calibrator or a known signal from an external generator.
- b. Turn on the EUT and connect it to measurement instrument. Then set it to any one convenient frequency within its operating range. Set a reference level on the measuring instrument equal to the highest peak value.
- c. Measure the frequency difference of two frequencies that were attenuated 20dB from the reference level. Record the frequency difference as the emission bandwidth.
- d. Repeat above procedures until all frequencies measured were complete.

4.5.4 DEVIATION FROM TEST STANDARD

No deviation.



4.5.5 TEST SETUP

Same as 4.3.5.

4.5.6 EUT OPERATING CONDITION

The software provided by client enabled the EUT to transmit and receive data at lowest, middle and highest channel frequencies individually.

4.5.7 TEST RESULTS

GFSK MODULATION

MODULATION TYPE	GFSK	ENVIRONMENTAL CONDITIONS	25deg. C, 65%RH, 991hPa
INPUT POWER (SYSTEM)	120Vac, 60 Hz	TESTED BY	Brad Wu

CHANNEL	CHANNEL FREQUENCY (MHz)	20dB BANDWIDTH (MHz)
0	2402	0.952
39	2441	0.811
78	2480	0.856

CH 0

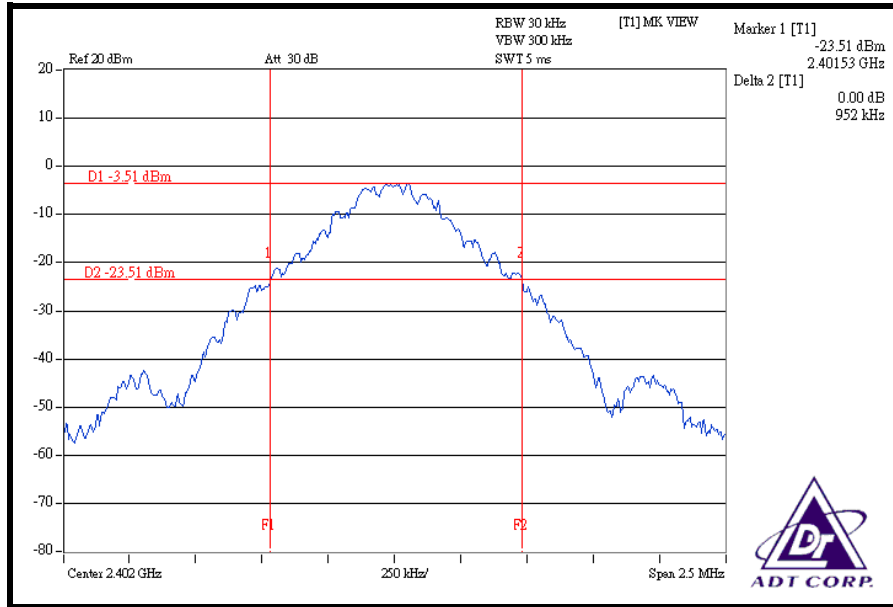

CH 39

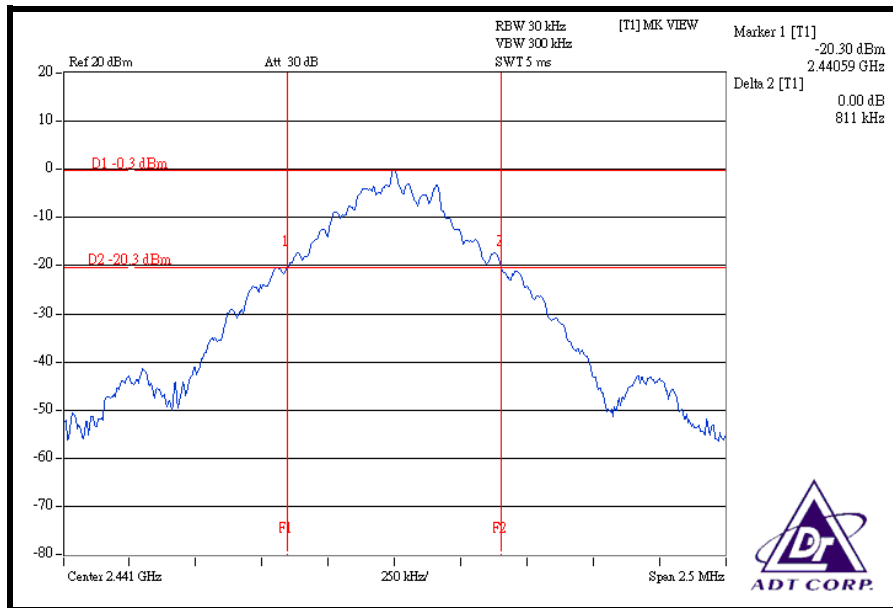

CH 78

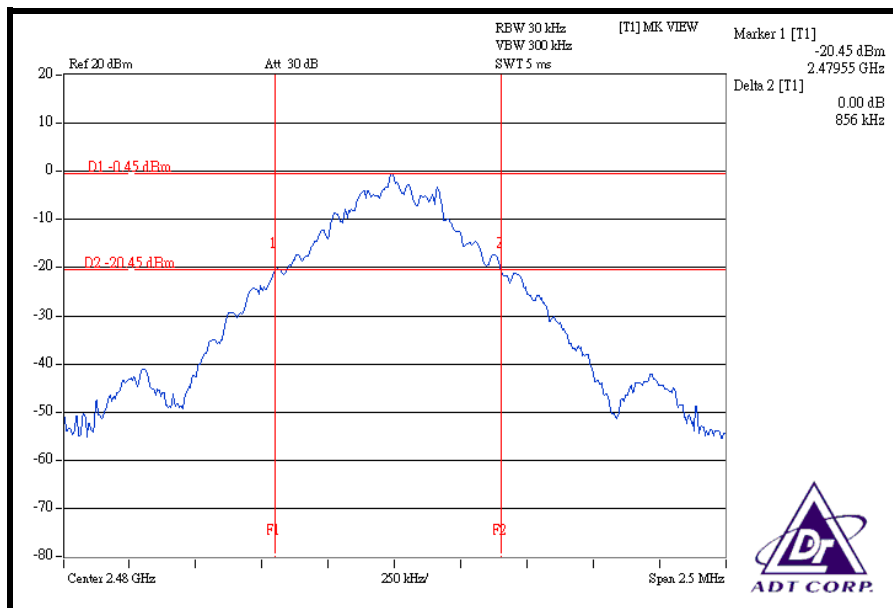



8DPSK MODULATION

MODULATION TYPE	8DPSK	ENVIRONMENTAL CONDITIONS	25deg. C, 65%RH, 991hPa
INPUT POWER (SYSTEM)	120Vac, 60 Hz	TESTED BY	Brad Wu

CHANNEL	CHANNEL FREQUENCY (MHz)	20dB BANDWIDTH (MHz)
0	2402	1.200
39	2441	1.240
78	2480	1.190

CH 0

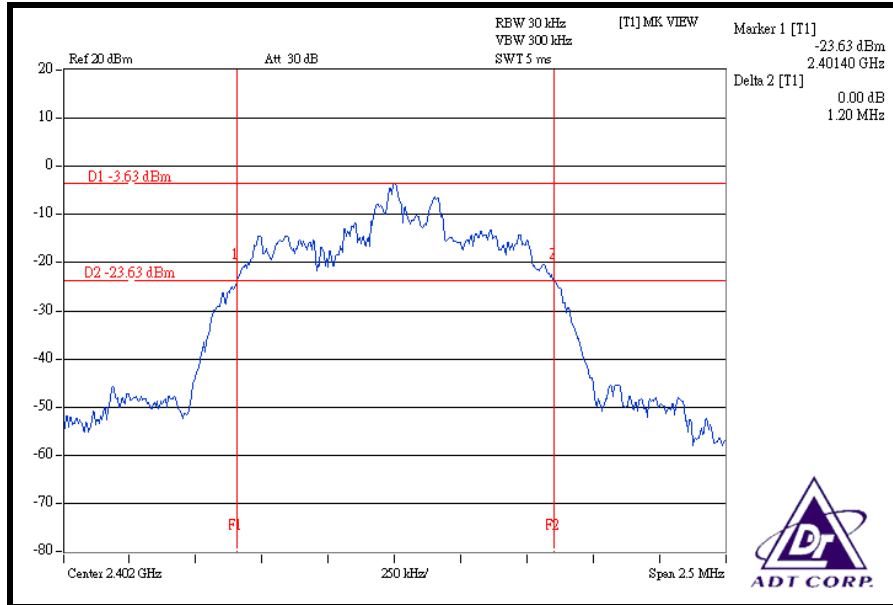

CH 39

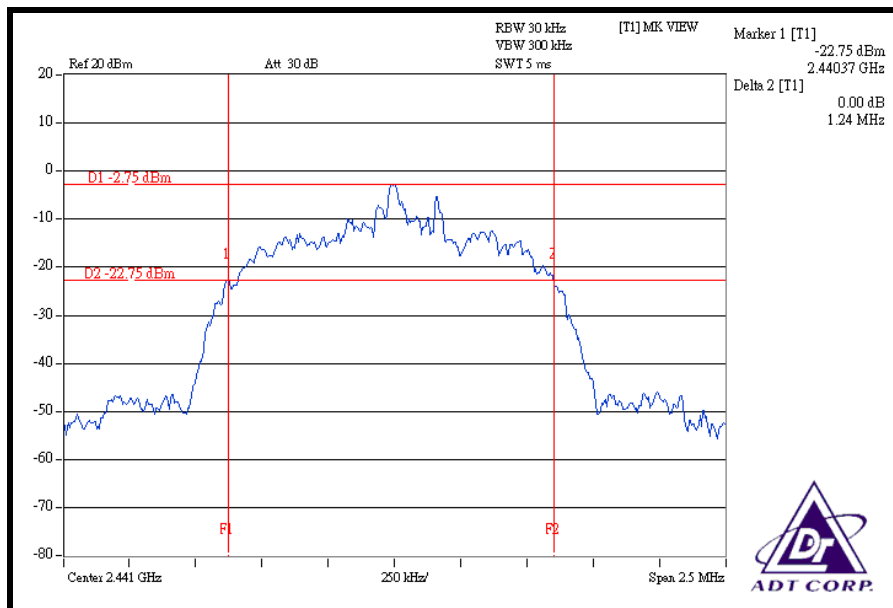

CH 78

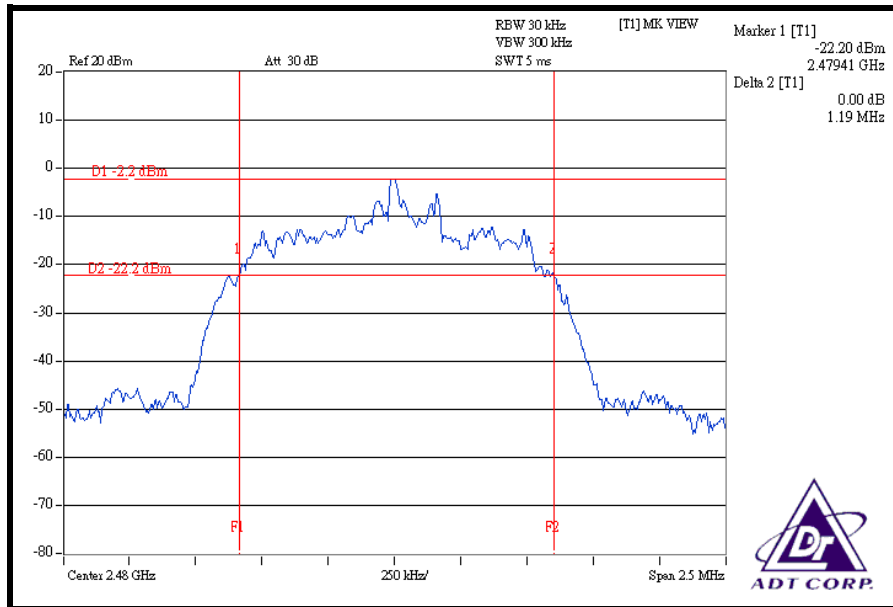



4.6 HOPPING CHANNEL SEPARATION

4.6.1 LIMIT OF HOPPING CHANNEL SEPARATION

At least 25kHz or two-third of 20dB hopping channel bandwidth (whichever is greater).

4.6.2 TEST INSTRUMENTS

DESCRIPTION & MANUFACTURER	MODEL NO.	SERIAL NO.	CALIBRATED UNTIL
SPECTRUM ANALYZER	FSP40	100040	Jul. 03, 2009

NOTES: The calibration interval of the above test instruments is 12 months. And the calibrations are traceable to NML/ROC and NIST/USA.

4.6.3 TEST PROCEDURES

1. Check the calibration of the measuring instrument using either an internal calibrator or a known signal from an external generator.
2. Turn on the EUT and connect it to measurement instrument. Then set it to any one convenient frequency within its operating range.
3. By using the MaxHold function record the separation of two adjacent channels.
4. Measure the frequency difference of these two adjacent channels by SA MARK function. And then plot the result on SA screen.
5. Repeat above procedures until all frequencies measured were complete.



4.6.4 DEVIATION FROM TEST STANDARD

No deviation.

4.6.5 TEST SETUP

Same as 4.3.5

4.6.6 TEST RESULTS

GFSK MODULATION

MODULATION TYPE	GFSK	ENVIRONMENTAL CONDITIONS	25deg. C, 65%RH, 991hPa
INPUT POWER (SYSTEM)	120Vac, 60 Hz	TESTED BY	Brad Wu

CHANNEL	FREQUENCY (MHz)	ADJACENT CHANNEL SEPARATION (MHz)	20dB BANDWIDTH (MHz)	MINIMUM LIMIT (MHz)	PASS / FAIL
0	2402	1.000	0.952	0.635	PASS
39	2441	1.010	0.811	0.541	PASS
78	2480	1.010	0.856	0.571	PASS

NOTE: The minimum limit is two-third 20dB bandwidth. Test results please refer to next two pages.

CH 0

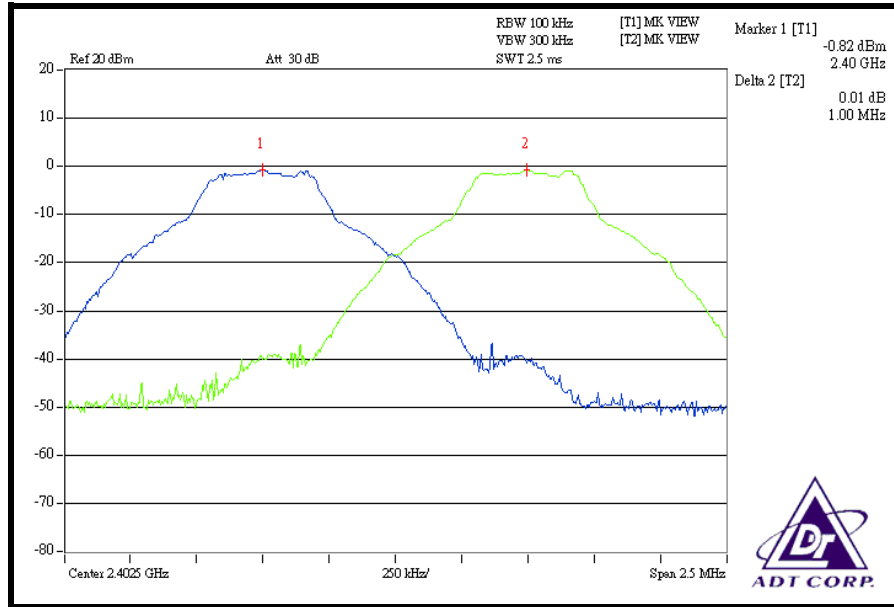

CH 39

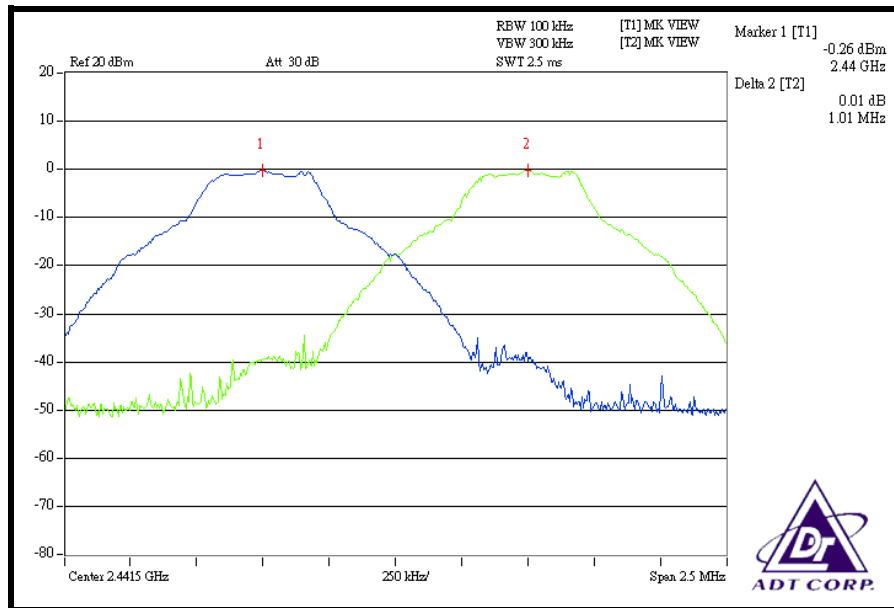

CH 78

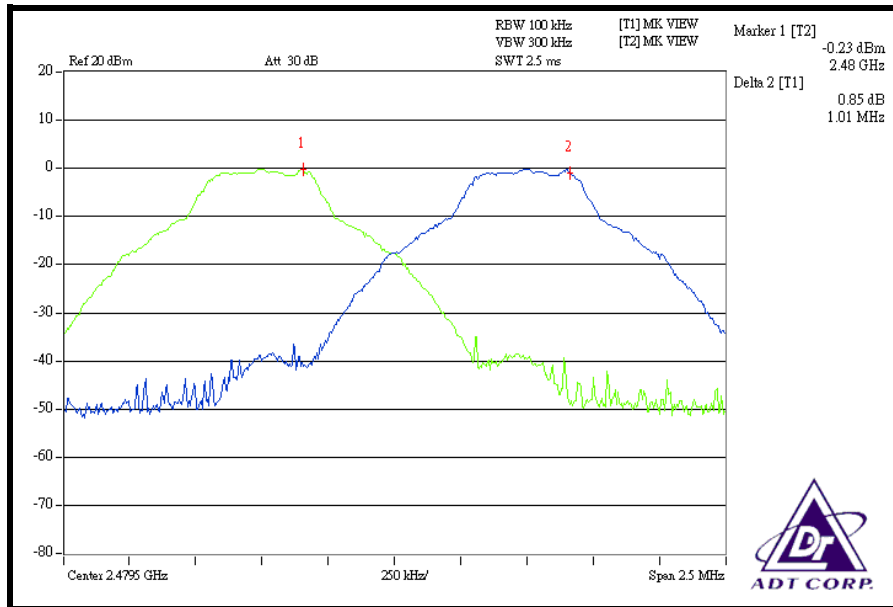



8DPSK MODULATION

MODULATION TYPE	8DPSK	ENVIRONMENTAL CONDITIONS	25deg. C, 65%RH, 991hPa
INPUT POWER (SYSTEM)	120Vac, 60 Hz	TESTED BY	Brad Wu

CHANNEL	FREQUENCY (MHz)	ADJACENT CHANNEL SEPARATION (MHz)	20dB BANDWIDTH (MHz)	MINIMUM LIMIT (MHz)	PASS / FAIL
0	2402	1.000	1.200	0.800	PASS
39	2441	1.010	1.240	0.827	PASS
78	2480	1.010	1.190	0.793	PASS

NOTE: The minimum limit is two-third 20dB bandwidth. Test results please refer to next two pages.

CH 0

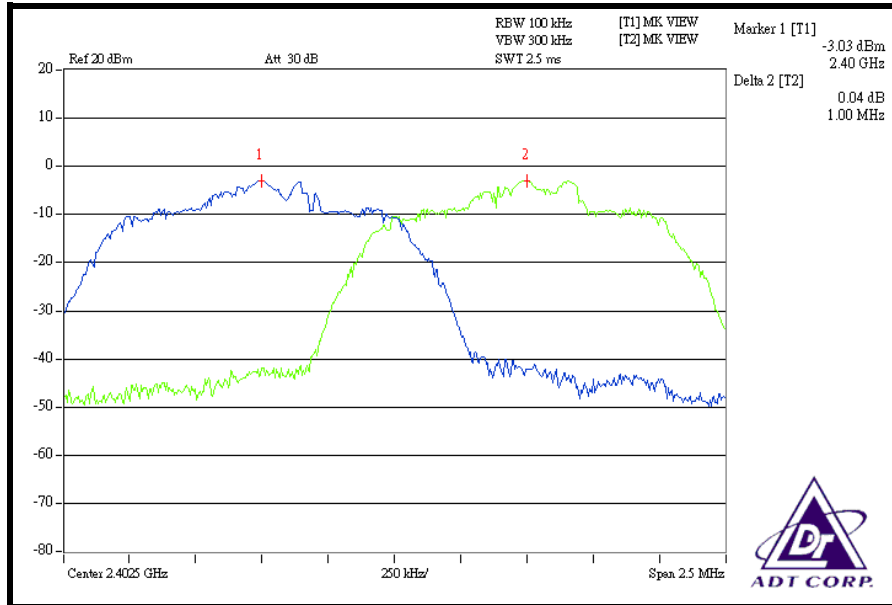

CH 39

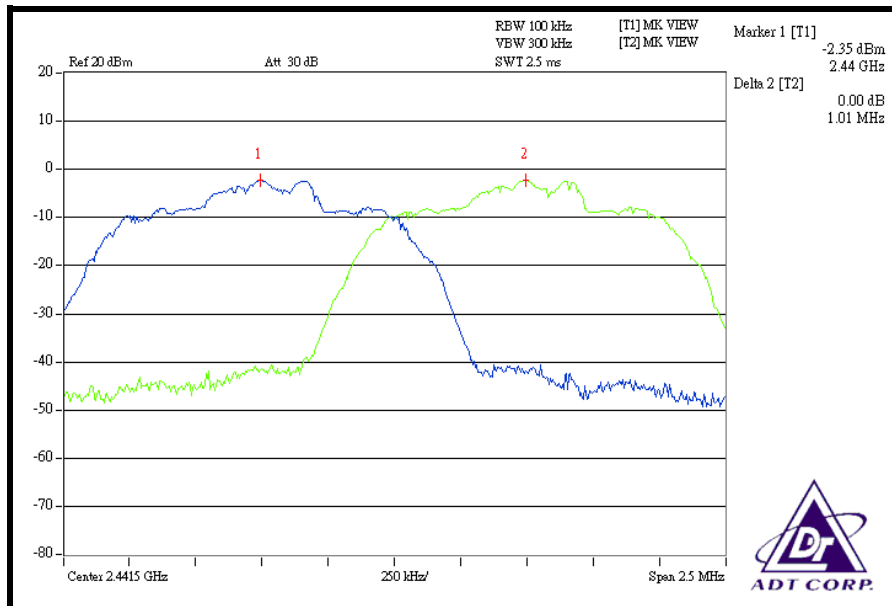

CH 78

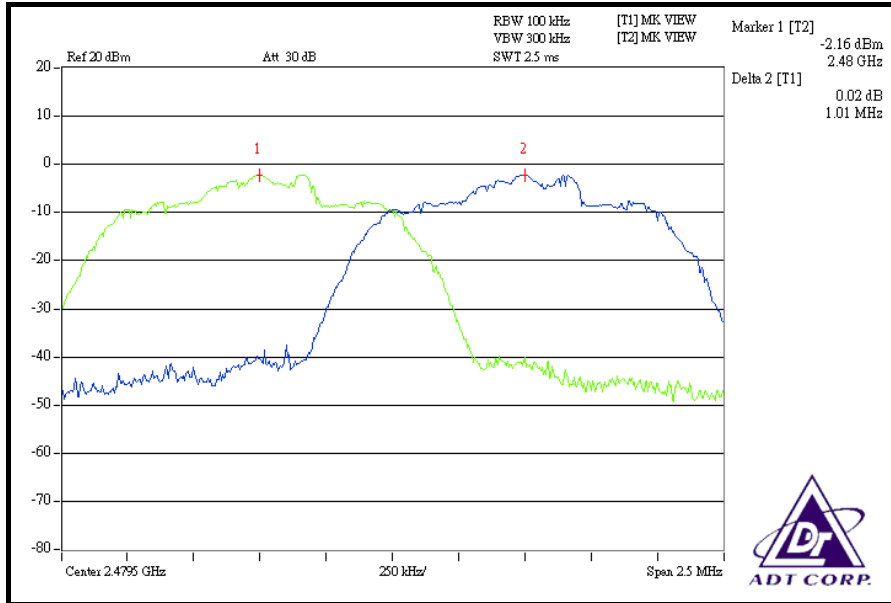



4.7 MAXIMUM PEAK OUTPUT POWER

4.7.1 LIMITS OF MAXIMUM PEAK OUTPUT POWER MEASUREMENT

The Maximum Peak Output Power Measurement is 125mW.

4.7.2 TEST INSTRUMENTS

DESCRIPTION & MANUFACTURER	MODEL NO.	SERIAL NO.	CALIBRATED UNTIL
SPECTRUM ANALYZER	FSP40	100040	Jul. 03, 2009

NOTE: The calibration interval of the above test instruments is 12 months and the calibrations are traceable to NML/ROC and NIST/USA.

4.7.3 TEST PROCEDURES

- a. Check the calibration of the measuring instrument using either an internal calibrator or a known signal from an external generator.
- b. Turn on the EUT and connect it to measurement instrument. Then set it to any one convenient frequency within its operating range. Set a reference level on the measuring instrument equal to the highest peak value.
- c. The center frequency of the spectrum analyzer is set to the fundamental frequency and using 3MHz RBW and 10 MHz VBW.
- d. Measure the captured power within the band and recording the plot.
- e. Repeat above procedures until all frequencies required were complete.

4.7.4 DEVIATION FROM TEST STANDARD

No deviation



4.7.5 TEST SETUP

Same as 4.3.5.

4.7.6 EUT OPERATING CONDITION

The software provided by client enabled the EUT to transmit and receive data at lowest, middle and highest channel frequencies individually.

4.7.7 TEST RESULTS

GFSK MODULATION

MODULATION TYPE	GFSK	ENVIRONMENTAL CONDITIONS	25deg. C, 65%RH, 991hPa
INPUT POWER (SYSTEM)	120Vac, 60 Hz	TESTED BY	Brad Wu

CHANNEL	CHANNEL FREQUENCY (MHz)	PEAK POWER OUTPUT (mW)	PEAK POWER OUTPUT (dBm)	PEAK POWER LIMIT (mW)	PASS/FAIL
0	2402	0.805	-0.94	125	PASS
39	2441	0.920	-0.36	125	PASS
78	2480	0.933	-0.30	125	PASS

CH 0

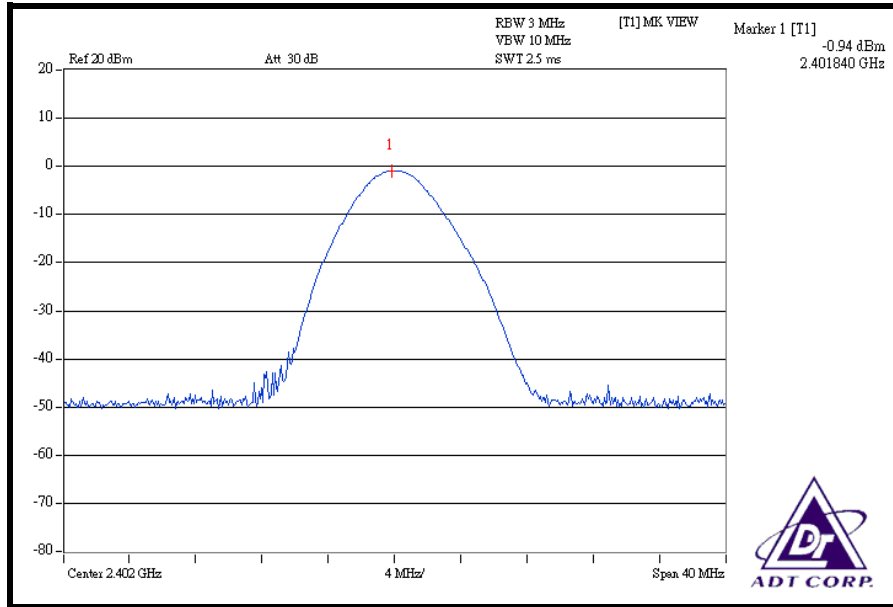

CH 39

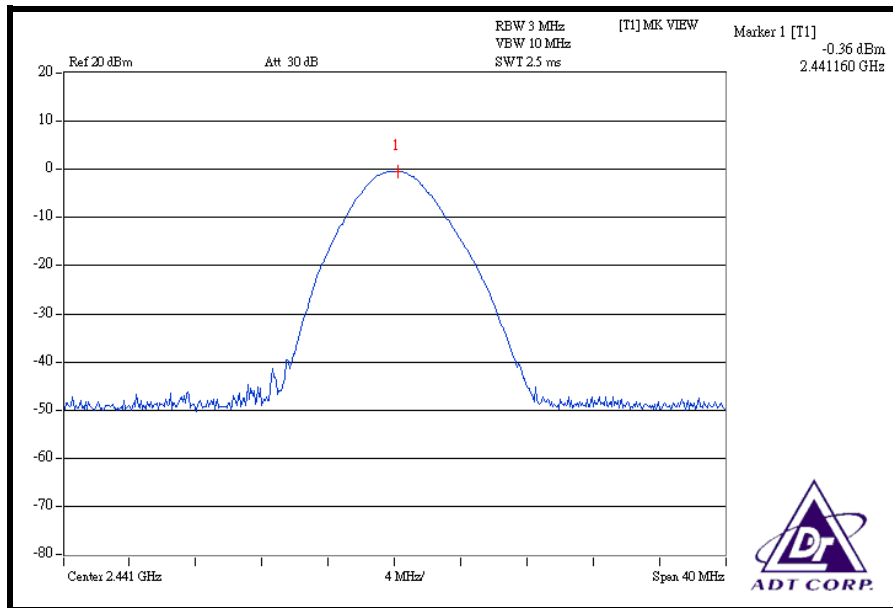

CH 78

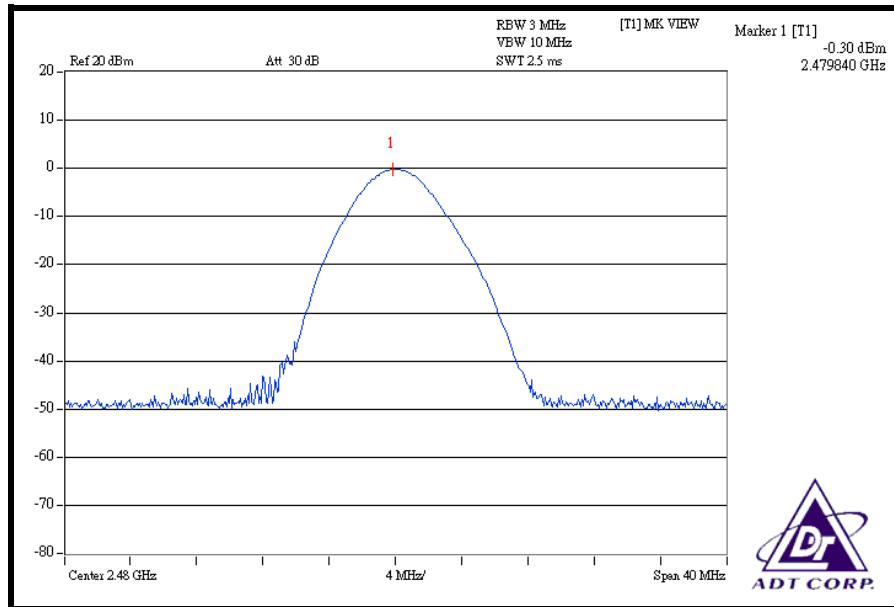



8DPSK MODULATION

MODULATION TYPE	8DPSK	ENVIRONMENTAL CONDITIONS	25deg. C, 65%RH, 991hPa
INPUT POWER (SYSTEM)	120Vac, 60 Hz	TESTED BY	Brad Wu

CHANNEL	CHANNEL FREQUENCY (MHz)	PEAK POWER OUTPUT (mW)	PEAK POWER OUTPUT (dBm)	PEAK POWER LIMIT (mW)	PASS/FAIL
0	2402	0.483	-3.16	125	PASS
39	2441	0.560	-2.52	125	PASS
78	2480	0.592	-2.28	125	PASS

CH 0

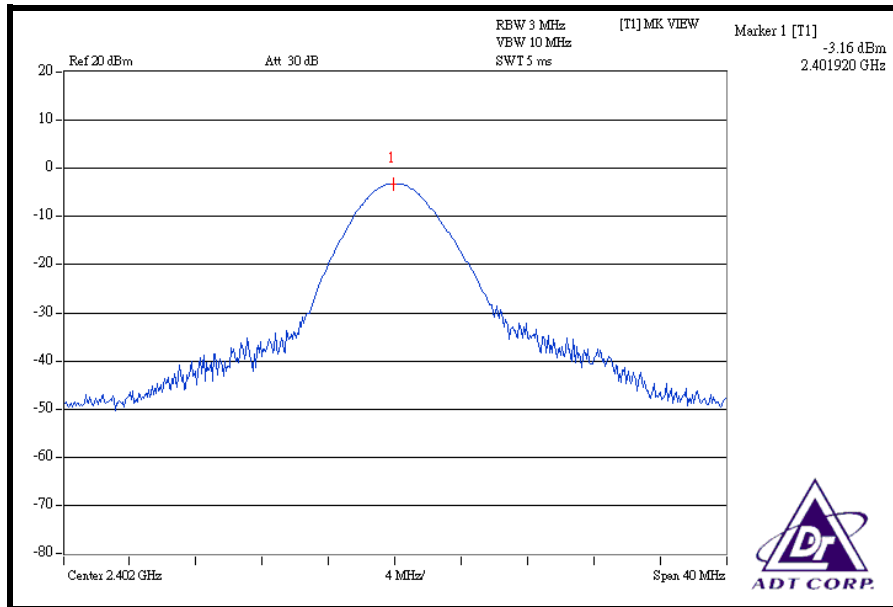

CH 39

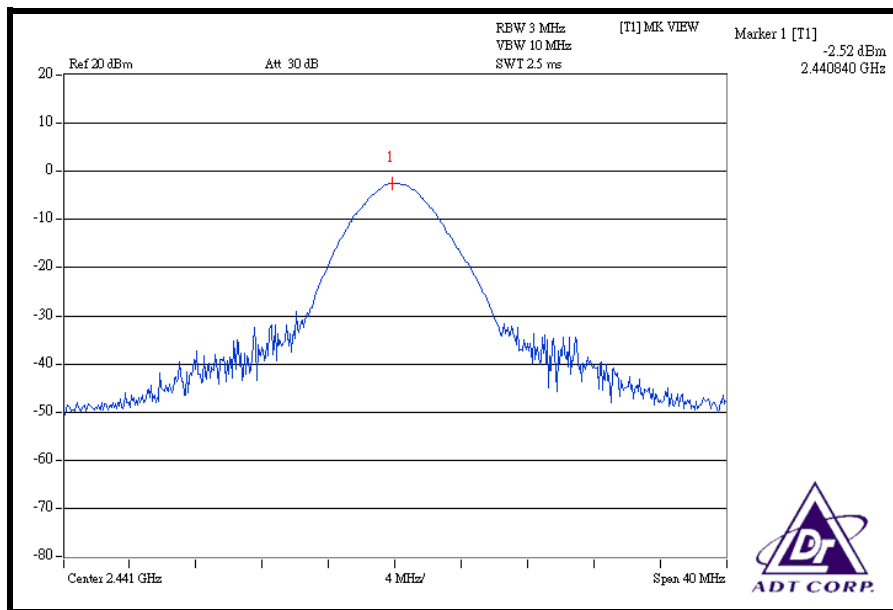

CH 78

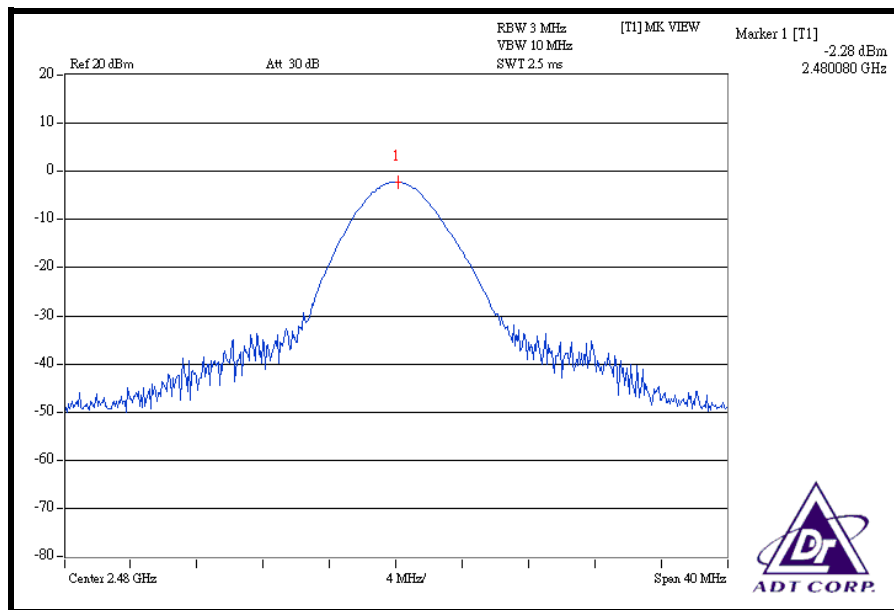



4.8 BAND EDGES MEASUREMENT

4.8.1 LIMITS OF BAND EDGES MEASUREMENT

Below -20dB of the highest emission level of operating band (in 100KHz RBW).

4.8.2 TEST INSTRUMENTS

DESCRIPTION & MANUFACTURER	MODEL NO.	SERIAL NO.	CALIBRATED UNTIL
SPECTRUM ANALYZER	FSP40	100040	Jul. 03, 2009

NOTES: The calibration interval of the above test instruments is 12 months. And the calibrations are traceable to NML/ROC and NIST/USA.

4.8.3 TEST PROCEDURE

The transmitter output was connected to the spectrum analyzer via a low lose cable. Set both RBW and VBW of spectrum analyzer to 100 kHz with suitable frequency span including 100 MHz bandwidth from band edge. The band edges was measured and recorded.

4.8.4 DEVIATION FROM TEST STANDARD

No deviation.

4.8.5 EUT OPERATING CONDITION

The software provided by client enabled the EUT to transmit and receive data at lowest and highest channel frequencies individually.

4.8.6 TEST RESULTS

The spectrum plots are attached on the following 8 images. D1 line indicates the highest level, D2 line indicates the 20dB offset below D1. It shows compliance with the requirement in part 15.247(d).

GFSK MODULATION

NOTE 1: The band edge emission plot on the next page shows 47.38dBc between carrier maximum power and local maximum emission in restrict band (2.33820GHz). The emission of carrier strength list in the test result of channel 0 at the item 4.2.7 is 96.08dBuV/m (Peak), so the maximum field strength in restrict band is $96.08 - 47.38 = 48.70$ dBuV/m, which is under 74 dBuV/m limit.

Average value = $48.70 - 30.10 = 18.60$ dBuV/m, which is under 54dBuV/m limit.

*The DH5 packet was the worse case duty cycle for a transmit dwell time on a channel, based upon bluetooth theory the transmitter is on $0.625 * 5$ per 296.25 ms per channel. Therefore, the duty cycle correction factor be equal to: $20\log(3.125/100) = -30.1$ dB.

Average value = peak reading – 30.1

NOTE 2: The band edge emission plot on the next second page shows 48.49dBc between carrier maximum power and local maximum emission in restrict band (2.49100GHz). The emission of carrier strength list in the test result of channel 78 at the item 4.2.7 is 96.79dBuV/m (Peak), so the maximum field strength in restrict band is $96.79 - 48.49 = 48.30$ dBuV/m, which is under 74 dBuV/m limit.

Average value = $48.30 - 30.10 = 18.20$ dBuV/m, which is under 54dBuV/m limit.

*The DH5 packet was the worse case duty cycle for a transmit dwell time on a channel, based upon bluetooth theory the transmitter is on $0.625 * 5$ per 296.25 ms per channel. Therefore, the duty cycle correction factor be equal to: $20\log(3.125/100) = -30.1$ dB.

Average value = peak reading – 30.1

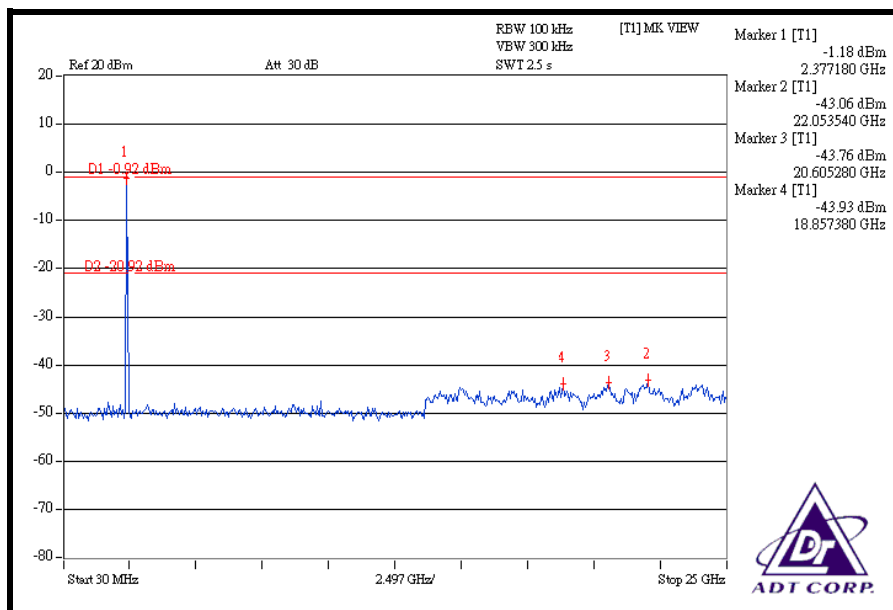
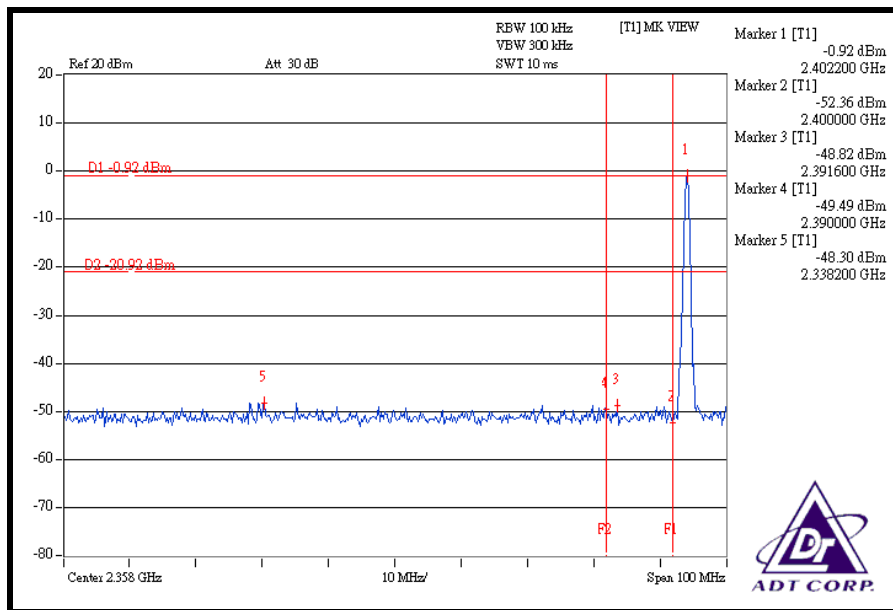

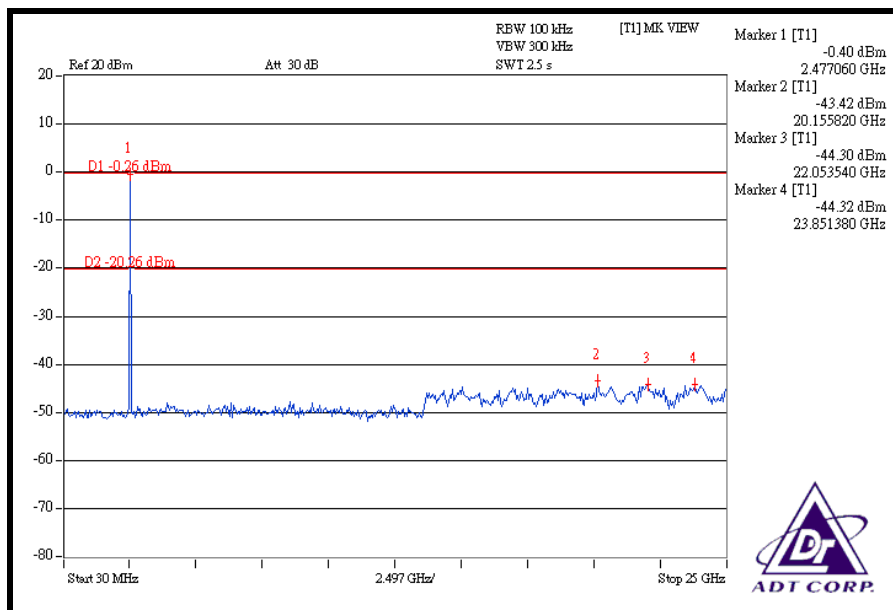
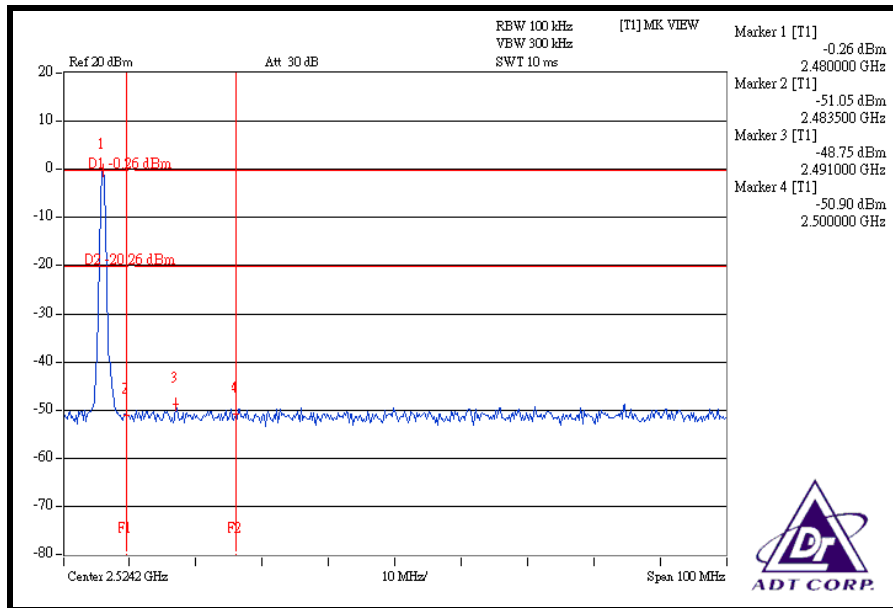

8DPSK MODULATION

NOTE 1: The band edge emission plot on the next page shows 44.71dBc between carrier maximum power and local maximum emission in restrict band (2.36720GHz). The emission of carrier strength list in the test result of channel 0 at the item 4.2.7 is 93.21dBuV/m (Peak), so the maximum field strength in restrict band is $93.21 - 44.71 = 48.50$ dBuV/m, which is under 74 dBuV/m limit.

Average value = $48.50 - 30.10 = 18.40$ dBuV/m, which is under 54dBuV/m limit.

*The DH5 packet was the worse case duty cycle for a transmit dwell time on a channel, based upon bluetooth theory the transmitter is on $0.625 * 5$ per 296.25 ms per channel. Therefore, the duty cycle be equal to: $20\log(3.125/100) = -30.1$ dB.

Average value = peak reading – 30.1

NOTE 2: The band edge emission plot on the next second page shows 43.42dBc between carrier maximum power and local maximum emission in restrict band (2.48680GHz). The emission of carrier strength list in the test result of channel 78 at the item 4.2.7 is 93.84dBuV/m (Peak), so the maximum field strength in restrict band is $93.84 - 43.42 = 50.42$ dBuV/m, which is under 74 dBuV/m limit.

Average value = $50.42 - 30.10 = 20.32$ dBuV/m, which is under 54dBuV/m limit.

*The DH5 packet was the worse case duty cycle for a transmit dwell time on a channel, based upon bluetooth theory the transmitter is on $0.625 * 5$ per 296.25 ms per channel. Therefore, the duty cycle be equal to: $20\log(3.125/100) = -30.1$ dB.

Average value = peak reading – 30.1

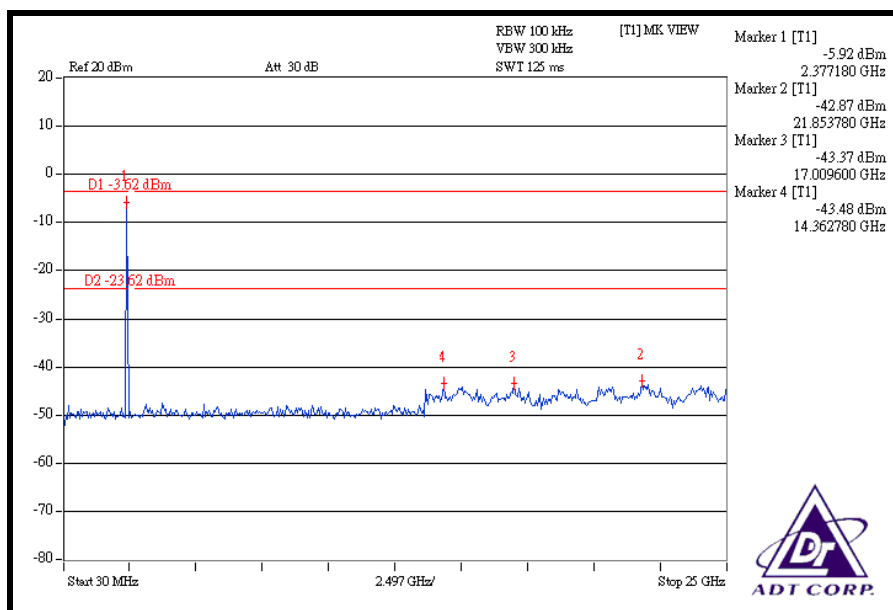
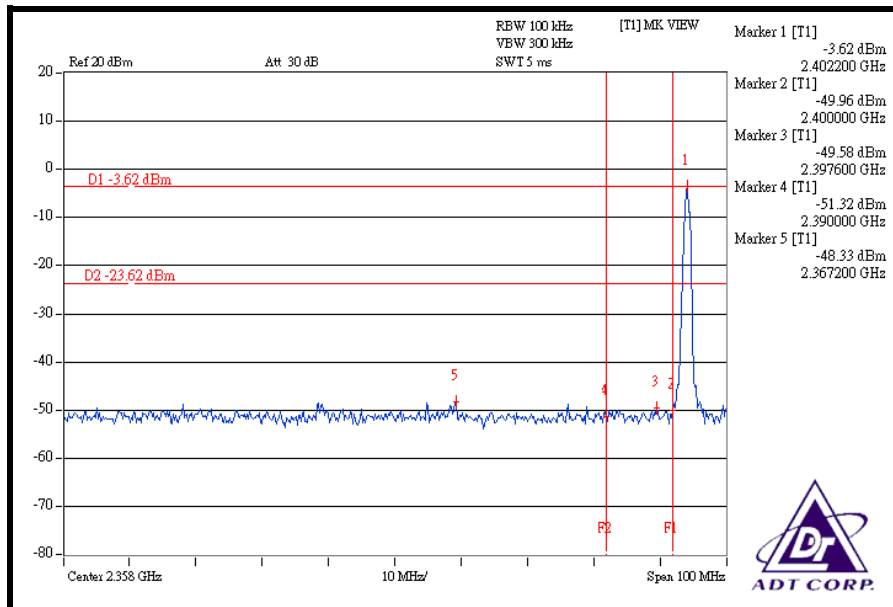

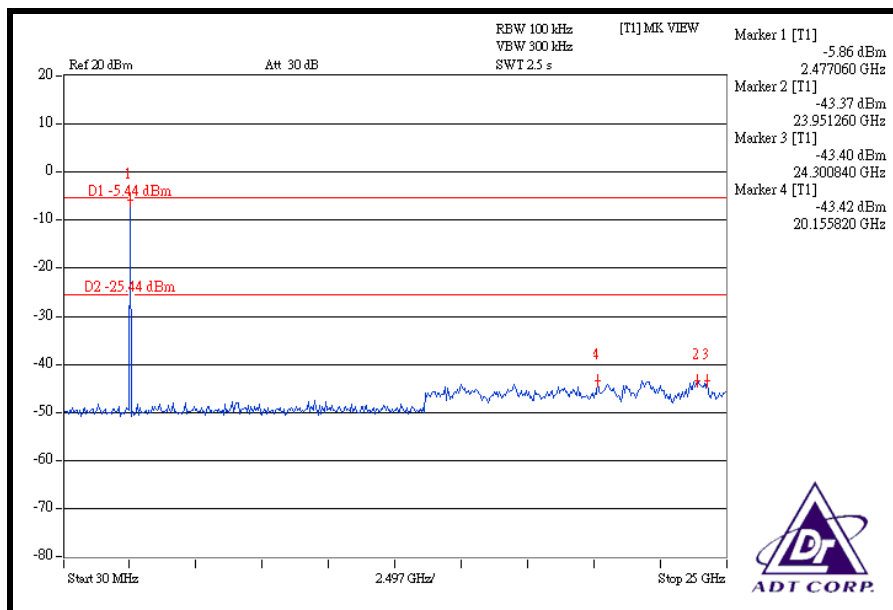
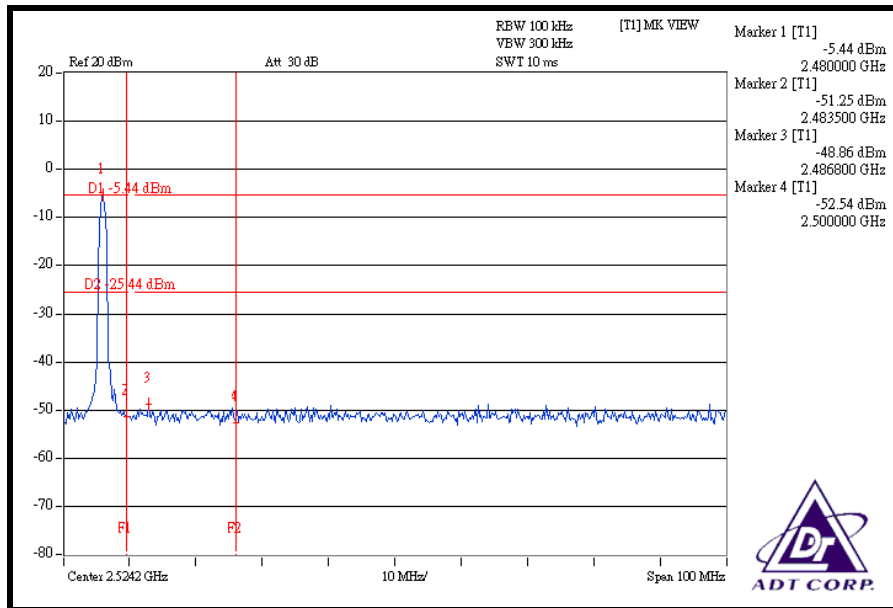



4.9 ANTENNA REQUIREMENT

4.9.1 STANDARD APPLICABLE

For intentional device, according to FCC 47 CFR Section 15.203, an intentional radiator shall be designed to ensure that no antenna other than that furnished by the responsible party shall be used with the device.

And according to FCC 47 CFR Section 15.247 (b), if transmitting antennas of directional gain greater than 6dBi are used, the power shall be reduced by the amount in dB that the directional gain of the antenna exceeds 6dBi.

4.9.2 ANTENNA CONNECTED CONSTRUCTION

The antenna used in this product is PIFA antenna without antenna connector. The maximum gain of this antenna is 1dBi.



5. PHOTOGRAPHS OF THE TEST CONFIGURATION

Please refer to the attached file (Test Setup Photo).



6. INFORMATION ON THE TESTING LABORATORIES

We, ADT Corp., were founded in 1988 to provide our best service in EMC, Radio, Telecom and Safety consultation. Our laboratories are accredited and approved by the following approval agencies according to ISO/IEC 17025.

USA	FCC, UL
Germany	TUV Rheinland
Japan	VCCI
Norway	NEMKO
Canada	INDUSTRY CANADA , CSA
R.O.C.	TAF, BSMI, NCC
Netherlands	Telefication
Singapore	GOST-ASIA(MOU)
Russia	CERTIS(MOU)

Copies of accreditation certificates of our laboratories obtained from approval agencies can be downloaded from our web site:

www.adt.com.tw/index.5/phtml. If you have any comments, please feel free to contact us at the following:

Linko EMC/RF Lab:

Tel: 886-2-26052180

Fax: 886-2-26051924

Hsin Chu EMC/RF Lab:

Tel: 886-3-5935343

Fax: 886-3-5935342

Hwa Ya EMC/RF/Safety Telecom Lab:

Tel: 886-3-3183232

Fax: 886-3-3185050

Web Site: www.adt.com.tw

The address and road map of all our labs can be found in our web site also.



7. APPENDIX A - MODIFICATIONS RECORDERS FOR ENGINEERING CHANGES TO THE EUT BY THE LAB

No any modifications are made to the EUT by the lab during the test.

---END---