



# Hearing Aid Compatibility (HAC) RF Emissions Test Report

for

**HTC Corporation**

on the

**Smart phone**

**Report Number : HA8D1718A**  
**Trade Name : HTC**  
**Model Name : ROSE130**  
**FCC ID : NM8RSB**  
**Date of Testing : Dec. 22, 2008 ~ Jan. 17, 2009**  
**Date of Report : Jan. 22, 2009**

- **Results Summary : M Category = M3 (ANSI C63.19-2006)**
- The test results refer exclusively to the presented test model/sample only.
- Without written approval of SPORTON International Inc., the test report shall not be reproduced except in full.
- Report Version: Rev.03

**SPORTON International Inc.**

**No. 52, Hwa Ya 1<sup>st</sup> Rd., Hwa Ya Technology Park, Kwei-Shan Hsiang, Tao Yuan Hsien, Taiwan, R.O.C.**



## Table of Contents

- 1. **Statement of Compliance** .....3
- 2. **Administration Data** .....4
  - 2.1 Testing Laboratory .....4
  - 2.2 Detail of Applicant.....4
  - 2.3 Detail of Manufacturer .....4
  - 2.4 Application Details .....4
- 3. **General Information** .....5
  - 3.1 Description of Device Under Test (DUT).....5
  - 3.2 Applied Standards .....6
  - 3.4 Test Conditions .....7
    - 3.4.1 Ambient Condition .....7
    - 3.4.2 Test Configuration.....7
- 4. **Hearing Aid Compliance (HAC)**.....8
  - 4.1 Introduction.....8
- 5. **HAC Measurement Setup** .....9
  - 5.1 DASY4 E-Field and H-Field Probe System .....10
  - 5.2 System Specification .....10
    - 5.2.1 ER3DV6 E-Field Probe Description .....10
    - 5.2.2 H3DV6 H-Field Probe Description .....10
    - 5.2.3 Probe Tip Description .....11
  - 5.3 DATA Acquisition Electronics (DAE) .....13
  - 5.4 Robot.....13
  - 5.5 Measurement Server .....13
  - 5.6 Phone Positioner .....14
    - 5.6.1 Test Arch Phantom .....15
  - 5.7 Data Storage and Evaluation .....16
    - 5.7.1 Data Storage.....16
    - 5.7.2 Data Evaluation .....16
  - 5.8 Test Equipment List .....18
- 6. **Uncertainty Assessment** .....19
- 7. **HAC Measurement Evaluation** .....21
  - 7.1 Purpose of System Performance check .....21
  - 7.2 System Setup .....21
  - 7.3 Validation Results .....23
- 8. **RF Field Probe Modulation Factor**.....24
- 9. **Description for DUT Testing Position**.....28
- 10. **RF Emissions Test Procedure**.....29
- 11. **HAC Test Results** .....30
  - 11.1 Conducted Power .....30
  - 11.2 E-Field Emission.....30
  - 11.3 H-Field Emission .....31
- 12. **References**.....32

- Appendix A - System Performance Check Data
- Appendix B - HAC Measurement Data
- Appendix C - Calibration Date
- Appendix D - Product Photographs
- Appendix E - Setup Photographs



1. Statement of Compliance

The Hearing Aid Compliance (HAC) maximum results found during testing for the **HTC Corporation Smart phone HTC ROSE130** are as follows (with expanded uncertainty ±29.4% for E-field and ±21.8% for H-field):

DUT Slide Mode	Band	E-Field (V/m)	M Rating	H-Field (A/m)	M Rating
Slide Off	GSM850	190.5	M3	0.171	M4
	GSM1900	75.7	M3	0.078	M4
	WCDMA Band V	62.9	M4	0.08	M4
	WCDMA Band II	30.4	M4	0.043	M4
Slide Right	GSM850	196.6	M3	0.166	M4
	GSM1900	48.5	M3	0.08	M4
	WCDMA Band V	60.9	M4	0.07	M4
	WCDMA Band II	22.3	M4	0.023	M4

They are in compliance with HAC limits specified in guidelines FCC 47 CFR §20.19 and ANSI Standard ANSI C63.19 for HAC Rated category M3.

Results Summary : M Category = M3 (ANSI C63.19-2006)

Approved by

Roy Wu  
Manager



## 2. Administration Data

### 2.1 Testing Laboratory

**Company Name :** Sporton International Inc.  
**Department :** Antenna Design/SAR  
**Address :** No.52, Hwa-Ya 1<sup>st</sup> RD., Hwa Ya Technology Park, Kwei-Shan Hsiang,  
TaoYuan Hsien, Taiwan, R.O.C.  
**Telephone Number :** 886-3-327-3456  
**Fax Number :** 886-3-328-4978

### 2.2 Detail of Applicant

**Company Name :** HTC Corporation  
**Address :** No. 23, Xinghua Rd., Taoyuan City, Taoyuan County 330, Taiwan,  
R.O.C.

### 2.3 Detail of Manufacturer

**Company Name :** HTC Corporation  
**Address:** No. 23, Xinghua Rd., Taoyuan City, Taoyuan County 330, Taiwan,  
R.O.C.

### 2.4 Application Details

**Date of reception of application:** Dec. 17, 2008  
**Start of test :** Dec. 22, 2008  
**End of test :** Jan. 17, 2009



### 3. General Information

#### 3.1 Description of Device Under Test (DUT)

Product Feature & Specification	
<b>DUT Type :</b>	Smart phone
<b>Trade Name :</b>	HTC
<b>Model Name :</b>	ROSE130
<b>FCC ID :</b>	NM8RSB
<b>Tx Frequency :</b>	GSM850 : 824 MHz ~ 849 MHz GSM1900 : 1850 MHz ~ 1910 MHz WCDMA Band V : 824 MHz ~ 849 MHz WCDMA Band II : 1850 MHz ~ 1910 MHz WLAN : 2400 ~ 2483.5 MHz Bluetooth : 2400 MHz ~ 2483.5 MHz
<b>Rx Frequency :</b>	GSM850 : 869 MHz ~ 894 MHz GSM1900 : 1930 MHz ~ 1990 MHz WCDMA Band V : 869 MHz ~ 894 MHz WCDMA Band II : 1930 MHz ~ 1990 MHz WLAN : 2400 ~ 2483.5 MHz Bluetooth : 2400 MHz ~ 2483.5 MHz
<b>Maximum Output Power to Antenna :</b>	GSM850 : 32.98 dBm GSM1900 : 30.32 dBm WCDMA Band V : 22.41 dBm WCDMA Band II : 22.11 dBm
<b>Antenna Type :</b>	GSM / WCDMA : Fixed Internal WLAN / Bluetooth : Mono-pole
<b>Antenna Gain :</b>	GSM / GPRS / EDGE 850 MHz : -2.5 dBi GSM / GPRS / EDGE 1900 MHz : 1.5 dBi WCDMA Band V : -2.5 dBi WCDMA Band II : 1.5 dBi
<b>HW Version :</b>	A05
<b>SW Version :</b>	1.62.442
<b>Type of Modulation :</b>	GSM : GMSK WCDMA : QPSK WLAN : DSSS / OFDM Bluetooth : GFSK
<b>DUT Stage :</b>	Identical Prototype

**Note:** This device does not support V.O.I.P.. It means that the functions of WLAN and Bluetooth do not have voice capability in the held to ear mode.

**3.2 Applied Standards**

The ANSI Standard ANSI C63.19:2006 represents performance requirements for acceptable interoperability of hearing aids with wireless communications devices. When these parameters are met, a hearing aid operates acceptably in close proximity to a wireless communications device.

The following AWF factors shall be used for the standard transmission protocols:

Standard	Technology	AWF (dB)
TIA/EIA/IS-2000	CDMA	0
TIA/EIA-136	TDMA (50 Hz)	0
J-STD-007	GSM (217)	-5
T1/T1P1/3GPP	UMTS (WCDMA)	0
iDENTM	TDMA (22 and 11 Hz)	0

**Table 3.1 Articulation Weighting Factor (AWF)**

Category	Telephone RF Parameters				
	AWF	E-Field Emissions		H-Field Emissions	
<b>&lt; 960 MHz</b>					
Category M1	0	631.0 – 1122.0	V/m	1.91 – 3.39	A/m
	-5	473.2 – 841.4	V/m	1.43 – 2.54	A/m
Category M2	0	354.8 – 631.0	V/m	1.07 – 1.91	A/m
	-5	266.1 – 473.2	V/m	0.80 – 1.43	A/m
Category M3	0	199.5 – 354.8	V/m	0.6 – 1.07	A/m
	-5	149.6 – 266.1	V/m	0.45 – 0.80	A/m
Category M4	0	< 199.5	V/m	< 0.60	A/m
	-5	< 149.6	V/m	< 0.45	A/m
<b>&gt; 960 MHz</b>					
Category M1	0	199.5 – 354.8	V/m	0.60 – 1.07	A/m
	-5	149.6 – 266.1	V/m	0.45 – 0.80	A/m
Category M2	0	112.2 – 199.5	V/m	0.34 – 0.60	A/m
	-5	84.1 – 149.6	V/m	0.25 – 0.45	A/m
Category M3	0	63.1 – 112.2	V/m	0.19 – 0.34	A/m
	-5	47.3 – 84.1	V/m	0.14 – 0.25	A/m
Category M4	0	< 63.1	V/m	< 0.19	A/m
	-5	< 47.3	V/m	< 0.14	A/m

**Table 3.2 Telephone near-field categories in linear units**



**3.4 Test Conditions**

**3.4.1 Ambient Condition**

Ambient Temperature (°C)	20-24
Humidity (%)	<60 %

**3.4.2 Test Configuration**

The device was controlled by using a base station emulator R&S CMU200. Communication between the device and the emulator was established by air link.

Measurements were performed on the lowest, middle and highest channels for all bands.

The DUT was set from the emulator to radiate maximum output power during all tests.



## ***4. Hearing Aid Compliance (HAC)***

### ***4.1 Introduction***

The federal communication commission (FCC) adopted ANSI C63.19 as HAC test standard.



## 5. HAC Measurement Setup

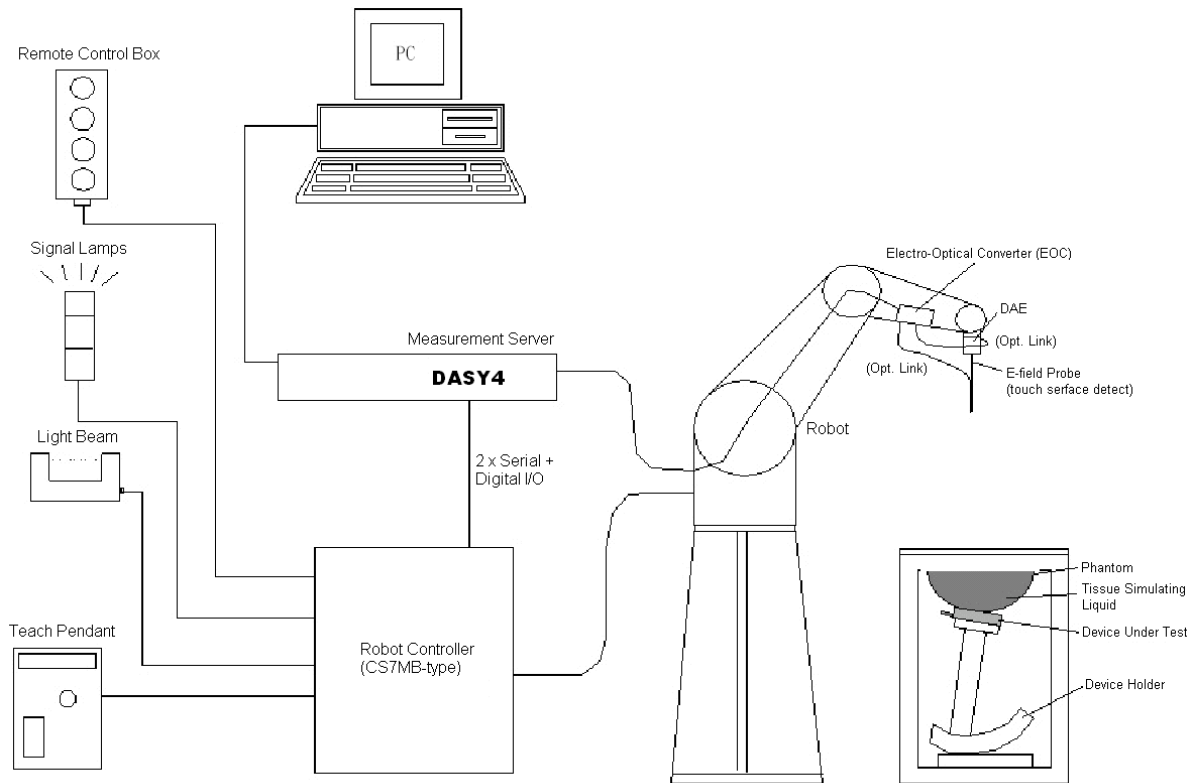

**Fig. 5.1 DASY4 system**

The DASY4 system for performance compliance tests is illustrated above graphically. This system consists of the following items:

- A standard high precision 6-axis robot with controller, a teach pendant and software
- A data acquisition electronic (DAE) attached to the robot arm extension
- A dosimetric probe equipped with an optical surface detector system
- The electro-optical converter (EOC) performs the conversion between optical and electrical signals
- A measurement server performs the time critical tasks such as signal filtering, control of the robot operation and fast movement interrupts.
- A probe alignment unit which improves the accuracy of the probe positioning
- A computer operating Windows XP
- DASY4 software
- Remote control with teach pendant and additional circuitry for robot safety such as warning lamps, etc.
- The SAM twin phantom
- A device holder
- Dipole for evaluating the proper functioning of the system
- Arch Phantom

Some of the components are described in details in the following sub-sections.

**5.1 DASY4 E-Field and H-Field Probe System**

The HAC measurement is conducted with the dosimetric probe ER3DV6 and H3DV6 (manufactured by SPEAG). The probe is specially designed and calibrated. This probe has a built in optical surface detection system to prevent from collision with DUT.

**5.2 System Specification**

**5.2.1 ER3DV6 E-Field Probe Description**

<b>Construction</b>	One dipole parallel, two dipoles normal to probe axis Built-in shielding against static charges
<b>Calibration</b>	In air from 100 MHz to 3.0 GHz (absolute accuracy $\pm 6.0\%$ , $k=2$ )
<b>Frequency</b>	100 MHz to 6 GHz; Linearity: $\pm 2.0$ dB (100 MHz to 3 GHz)
<b>Directivity</b>	$\pm 0.2$ dB in air (rotation around probe axis) $\pm 0.4$ dB in air (rotation normal to probe axis)
<b>Dynamic Range</b>	2 V/m to 1000 V/m (M3 or better device readings fall well below diode compression point)
<b>Linearity</b>	$\pm 0.2$ dB
<b>Dimensions</b>	Overall length: 330 mm (Tip: 16 mm) Tip diameter: 8 mm (Body: 12 mm) Distance from probe tip to dipole centers: 2.5 mm



**Fig. 5.2  
E-field Free-space Probe**

**5.2.2 H3DV6 H-Field Probe Description**

<b>Construction</b>	Three concentric loop sensors with 3.8 mm loop diameters Resistively loaded detector diodes for linear response Built-in shielding against static charges
<b>Frequency</b>	200 MHz to 3 GHz (absolute accuracy $\pm 6.0\%$ , $k=2$ ); Output linearized
<b>Directivity</b>	$\pm 0.25$ dB (spherical isotropy error)
<b>Dynamic Range</b>	10 m A/m to 2 A/m at 1 GHz (M3 or better device readings fall well below diode compression point)
<b>Dimensions</b>	Overall length: 330 mm (Tip: 40 mm) Tip diameter: 6 mm (Body: 12 mm) Distance from probe tip to dipole centers: 3 mm
<b>E-Field Interference</b>	< 10% at 3 GHz (for plane wave)



**Fig. 5.3  
H-field Free-space Probe**

### 5.2.3 Probe Tip Description

HAC field measurements take place in the close near field with high gradients. Increasing the measuring distance from the source will generally decrease the measured field values (in case of the validation dipole approx. 10% per mm).

Magnetic field sensors are measuring the integral of the H-field across their sensor area surrounded by the loop. They are calibrated in a precise, homogeneous field. When measuring a gradient field, the result will be very close to the field in the center of the loop which is equivalent to the value of a homogeneous field equivalent to the center value. But it will be different from the field at the field at the border of the loop.

Consequently, two sensors with different loop diameters – both calibrated ideally – would give different results when measuring from the edge of the probe sensor elements. The behavior for electrically small E-field sensors is equivalent. See below for distance plots from a WD which show the conservative nature of field readings at the probe element center vs. measurements at the sensor end:

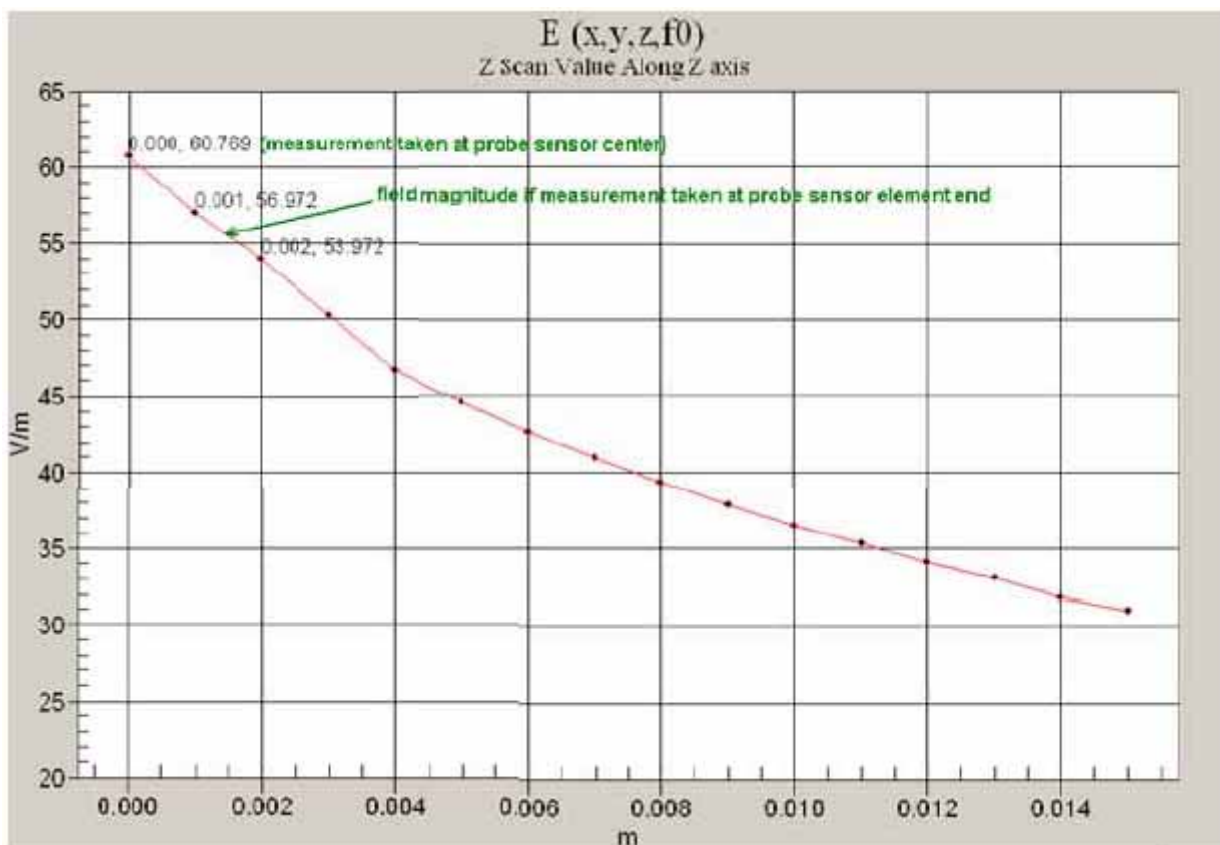
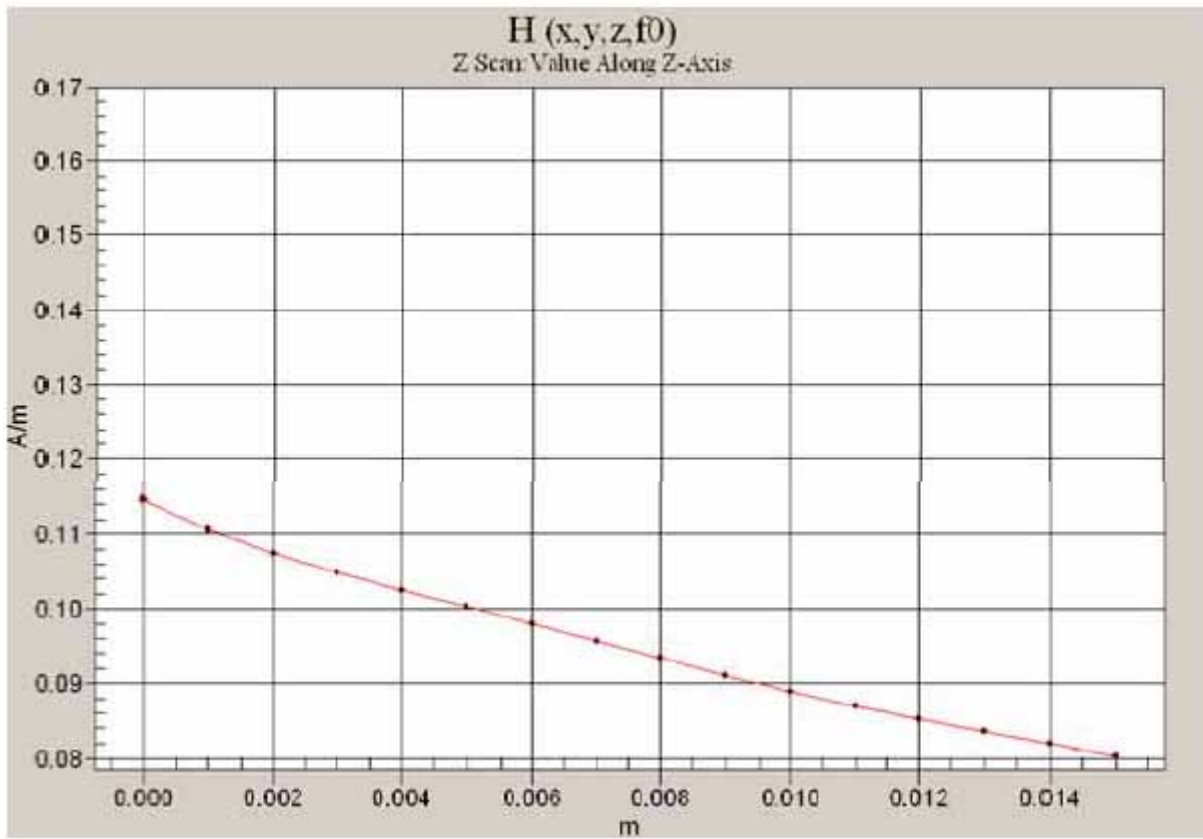

Fig. 5.4 Z-Axis Scan at maximum point above a typical wireless device for E-field



**Fig. 5.5 Z-Axis Scan at maximum point above a typical wireless device for H-field**

The magnetic field loops of the H3D probes are concentric, with the center 3mm from the tip for H3DV6.

Their radius is 1.9 mm.

The electric field probes have a more irregular internal geometry because it is physically not possible to have the 3 orthogonal sensors situated with the same center. The effect of the different sensor centers is accounted for in the HAC uncertainty budget (“sensor displacement”). Their geometric center is at 2.5 mm from the tip, and the element ends are 1.1 mm closer to the tip.

Where:

Peak Field = Peak field (in dB V/m or dB A/m)

Raw = Raw field measurement from the measurement system (in V/m or A/m).

PMF = Probe Modulation Factor (in Linear units). See Chapter 8 of test report.

### **5.3 DATA Acquisition Electronics (DAE)**

The data acquisition electronics (DAE3) consists of a highly sensitive electrometer-grade preamplifier with auto-zeroing, a channel and gain-switching multiplexer, a fast 16 bit AD-converter and a command decoder and control logic unit. Transmission to the measurement server is accomplished through an optical downlink for data and status information as well as an optical uplink for commands and the clock.

The mechanical probe mounting device includes two different sensor systems for frontal and sideways probe contacts. They are used for mechanical surface detection and probe collision detection.

The input impedance of the DAE3 is 200M Ohm; the inputs are symmetrical and floating. Common mode rejection is above 80dB.

### **5.4 Robot**

The DASY4 system uses the high precision robots RX90BL type out of the newer series from Stäubli SA (France). For the 6-axis controller DASY4 system, the CS7MB robot controller version from Stäubli is used. The RX robot series have many features that are important for our application:

- High precision (repeatability 0.02 mm)
- High reliability (industrial design)
- Jerk-free straight movements
- Low ELF interference (the closed metallic construction shields against motor control fields)
- 6-axis controller

### **5.5 Measurement Server**

The DASY4 measurement server is based on a PC/104 CPU board with  
166 MHz CPU  
32 MB chipset and  
64 MB RAM.

Communication with  
the DAE3 electronic box  
the 16-bit AD-converter system for optical detection and digital I/O interface.

The measurement server performs all the real-time data evaluation for field measurements and surface detection, controls robot movements and handles safety operations.

### 5.6 Phone Positioner

The phone positioner shown in Fig. 5.8 is used to adjust DUT to the suitable position.



**Fig. 5.6 Phone Positioner**

5.6.1 Test Arch Phantom

Construction	Enables easy and well defined positioning of the phone and validation dipoles as well as simple teaching of the robot.
Dimensions	370 x 370 x 370 mm



Fig. 5.7 Test Arch Phantom

## 5.7 Data Storage and Evaluation

### 5.7.1 Data Storage

The DASY4 software stores the assessed data from the data acquisition electronics as raw data (in microvolt readings from the probe sensors), together with all the necessary software parameters for the data evaluation (probe calibration data, and device frequency and modulation data) in measurement files with the extension .DA4. The post-processing software evaluates the desired unit and format for output each time the data is visualized or exported. This allows verification of the complete software setup even after the measurement and allows correction of erroneous parameter settings.

### 5.7.2 Data Evaluation

The DASY4 post-processing software (SEMCAD) automatically executes the following procedures to calculate the field units from the microvolt readings at the probe connector. The parameters used in the evaluation are stored in the configuration modules of the software :

<b>Probe parameters :</b>	- Sensitivity	Norm <sub>i</sub> , a <sub>i,0</sub> , a <sub>i,1</sub> , a <sub>i,2</sub>
	- Conversion factor	ConvF <sub>i</sub>
	- Diode compression point	dcp <sub>i</sub>
<b>Device parameters :</b>	- Frequency	f
	- Crest factor	cf
<b>Media parameters :</b>	- Conductivity	
	- Density	

These parameters must be set correctly in the software. They can be found in the component documents or they can be imported into the software from the configuration files issued for the DASY components. In the direct measuring mode of the multimeter option, the parameters of the actual system setup are used. In the scan visualization and export modes, the parameters stored in the corresponding document files are used.

The first step of the evaluation is a linearization of the filtered input signal to account for the compression characteristics of the detector diode. The compensation depends on the input signal, the diode type and the DC-transmission factor from the diode to the evaluation electronics. If the exciting field is pulsed, the crest factor of the signal must be known to correctly compensate for peak power. The formula for each channel can be given as :

$$V_i = U_i + U_i^2 \cdot \frac{cf}{dcp_i}$$

with  $V_i =$  compensated signal of channel  $i$  ( $i = x, y, z$ )  
 $U_i =$  input signal of channel  $i$  ( $i = x, y, z$ )  
 $cf =$  crest factor of exciting field (DASY parameter)  
 $dcp_i =$  diode compression point (DASY parameter)



From the compensated input signals, the primary field data for each channel can be evaluated :

$$\text{E-field probes : } E_i = \sqrt{\frac{V_i}{\text{Norm}_i \text{Conv}F}}$$

$$\text{H-field probes : } H_i = \sqrt{V_i \frac{a_{i0} + a_{i1}f + a_{i2}f^2}{f}}$$

with  $V_i$  = compensated signal of channel  $i$  ( $i = x, y, z$ )  
 $\text{Norm}_i$  = sensor sensitivity of channel  $i$  ( $i = x, y, z$ )  
 $\mu \text{ V}/(\text{V}/\text{m})^2$  for E-field Probes  
 $\text{Conv}F$  = sensitivity enhancement in solution  
 $a_{ij}$  = sensor sensitivity factors for H-field probes  
 $f$  = carrier frequency [GHz]  
 $E_i$  = electric field strength of channel  $i$  in V/m  
 $H_i$  = magnetic field strength of channel  $i$  in A/m

The RSS value of the field components gives the total field strength (Hermitian magnitude) :

$$E_{tot} = \sqrt{E_x^2 + E_y^2 + E_z^2}$$

The primary field data are used to calculate the derived field units.

The power flow density is calculated assuming the excitation field to be a free space field.

$$P_{pwe} = \frac{E_{tot}^2}{3770} \quad \text{or} \quad P_{pwe} = H_{tot}^2 \cdot 37.7$$

with  $P_{pwe}$  = equivalent power density of a plane wave in mW/cm<sup>2</sup>  
 $E_{tot}$  = total electric field strength in V/m  
 $H_{tot}$  = total magnetic field strength in A/m

The measurement/integration time per point, as specified by the system manufacturer is >500 ms.

The signal response time is evaluated as the time required by the system to reach 90% of the expected final value after an on/off switch of the power source with an integration time of 500 ms and a probe response time of <5 ms. In the current implementation, DASY4 waits longer than 100 ms after having reached the grid point before starting a measurement, i.e., the response time uncertainty is negligible.

If the device under test does not emit a CW signal, the integration time applied to measure the electric field at a specific point may introduce additional uncertainties due to the discretization. The tolerances for the different systems had the worst-case of 2.6%.



**5.8 Test Equipment List**

Manufacturer	Name of Equipment	Type/Model	Serial Number	Calibration	
				Last Cal.	Due Date
SPEAG	Isotropic E-Filed Probe	ER3DV6	2358	Jan. 28, 2008	Jan. 27, 2009
SPEAG	Isotropic H-Filed Probe	H3DV6	6184	Jan. 28, 2008	Jan. 27, 2009
SPEAG	835MHz Calibration Dipole	CD835V3	1045	Sep. 25, 2007	Sep. 24, 2009
SPEAG	1880MHz Calibration Dipole	CD1880V3	1038	Sep. 27, 2007	Sep. 26, 2009
SPEAG	Data Acquisition Electronics	DAE3	577	Nov. 12, 2008	Nov. 11, 2009
SPEAG	Data Acquisition Electronics	DAE4	778	Sep. 22, 2008	Sep. 21, 2009
SPEAG	Test Arch Phantom	N/A	N/A	NCR	NCR
SPEAG	Phone Positoiner	N/A	N/A	NCR	NCR

**Table 5.1 Test Equipment List**

**6. Uncertainty Assessment**

The component of uncertainty may generally be categorized according to the methods used to evaluate them. The evaluation of uncertainty by the statistical analysis of a series of observations is termed a Type A evaluation of uncertainty. The evaluation of uncertainty by means other than the statistical analysis of a series of observation is termed a Type B evaluation of uncertainty. Each component of uncertainty, however evaluated, is represented by an estimated standard deviation, termed standard uncertainty, which is determined by the positive square root of the estimated variance.

A Type A evaluation of standard uncertainty may be based on any valid statistical method for treating data. This includes calculating the standard deviation of the mean of a series of independent observations; using the method of least squares to fit a curve to the data in order to estimate the parameter of the curve and their standard deviations; or carrying out an analysis of variance in order to identify and quantify random effects in certain kinds of measurement.

A type B evaluation of standard uncertainty is typically based on scientific judgment using all of the relevant information available. These may include previous measurement data, experience and knowledge of the behavior and properties of relevant materials and instruments, manufacture’s specification, data provided in calibration reports and uncertainties assigned to reference data taken from handbooks. Broadly speaking, the uncertainty is either obtained from an outdoor source or obtained from an assumed distribution, such as the normal distribution, rectangular or triangular distributions indicated in Table 7.1

Uncertainty Distributions	Normal	Rectangular	Triangular	U-shape
<b>Multiplying factor<sup>(a)</sup></b>	1/k <sup>(b)</sup>	1/ 3	1/ 6	1/ 2

(a) standard uncertainty is determined as the product of the multiplying factor and the estimated range of variations in the measured quantity

(b) is the coverage factor

**Table 6.1 Multiplying Factions for Various Distributions**

The combined standard uncertainty of the measurement result represents the estimated standard deviation of the result. It is obtained by combining the individual standard uncertainties of both Type A and Type B evaluation using the usual “root-sum-squares” (RSS) methods of combining standard deviations by taking the positive square root of the estimated variances.

Expanded uncertainty is a measure of uncertainty that defines an interval about the measurement result within which the measured value is confidently believed to lie. It is obtained by multiplying the combined standard uncertainty by a coverage factor. Typically, the coverage factor ranges from 2 to 3. Using a coverage factor allows the true value of a measured quantity to be specified with a defined probability within the specified uncertainty range. For purpose of this document, a coverage factor two is used, which corresponds to confidence interval of about 95 %. The DASY4 uncertainty Budget is showed in Table 6.2.



Error Description	Uncertainty Value (± %)	Probability Distribution	Divisor	(Ci) E	(Ci) H	Std. Unc. E	Std. Unc. H
<b>Measurement System</b>							
Probe Calibration	± 5.1	Normal	1	1	1	± 5.1	± 5.1
Axial Isotropy	± 4.7	Rectangular	√3	1	1	± 2.7	± 2.7
Sensor Displacement	± 16.5	Rectangular	√3	1	0.145	± 9.5	± 1.4
Boundary Effect	± 2.4	Rectangular	√3	1	1	± 1.4	± 1.4
Linearity	± 4.7	Rectangular	√3	1	1	± 2.7	± 2.7
Scaling to Peak Envelope Power	± 2.0	Rectangular	√3	1	1	± 1.2	± 1.2
System Detection Limit	± 1.0	Rectangular	√3	1	1	± 0.6	± 0.6
Readout Electronics	± 0.3	Normal	1	1	1	± 0.3	± 0.3
Response Time	± 0.8	Rectangular	√3	1	1	± 0.5	± 0.5
Integration Time	± 2.6	Rectangular	√3	1	1	± 1.5	± 1.5
RF Ambient Conditions	± 3.0	Rectangular	√3	1	1	± 1.7	± 1.7
RF Reflections	± 12.0	Rectangular	√3	1	1	± 6.9	± 6.9
Probe Positioner	± 1.2	Rectangular	√3	1	0.67	± 0.7	± 0.5
Probe Positioning	± 4.7	Rectangular	√3	1	0.67	± 2.7	± 1.8
Extrap. and Interpolation	± 1.0	Rectangular	√3	1	1	± 0.6	± 0.6
<b>Test Sample Related</b>							
Device Positioning Vertical	± 4.7	Rectangular	√3	1	0.67	± 2.7	± 1.8
Device Positioning Lateral	± 1.0	Rectangular	√3	1	1	± 0.6	± 0.6
Device Holder and Phantom	± 2.4	Rectangular	√3	1	1	± 1.4	± 1.4
Power Drift	± 5.0	Rectangular	√3	1	1	± 2.9	± 2.9
<b>Phantom and Setup Related</b>							
Phantom Thickness	± 2.4	Rectangular	√3	1	0.67	± 1.4	± 0.9
<b>Combined Standard Uncertainty</b>						<b>± 14.7</b>	<b>± 10.9</b>
<b>Coverage Factor for 95 %</b>		<b>K=2</b>					
<b>Expanded uncertainty (Coverage factor = 2)</b>						<b>± 29.4</b>	<b>± 21.8</b>

Table 6.2 Uncertainty Budget of DASY4

## **7. HAC Measurement Evaluation**

Each DASY4 system is equipped with one or more system validation kits. These units, together with the predefined measurement procedures within the DASY4 software, enable the user to conduct the system performance check and system validation. System validation kit includes a dipole, tripod holder to fix it underneath the test Arch and a corresponding distance holder.

### **7.1 Purpose of System Performance check**

The system performance check verifies that the system operates within its specifications. System and operator errors can be detected and corrected. It is recommended that the system performance check be performed prior to any usage of the system in order to guarantee reproducible results. The system performance check uses normal HAC measurements in a simplified setup with a well characterized source. This setup was selected to give a high sensitivity to all parameters that might fail or vary over time. The system check does not intend to replace the calibration of the components, but indicates situations where the system uncertainty is exceeded due to drift or failure.

### **7.2 System Setup**

In the simplified setup for system evaluation, the DUT is replaced by a calibrated dipole and the power source is replaced by a continuous wave which comes from a signal generator at frequency 835 and 1880 MHz. The calibrated dipole must be placed beneath the flat phantom section of the ARC with the correct distance holder. The equipment setup is shown below:

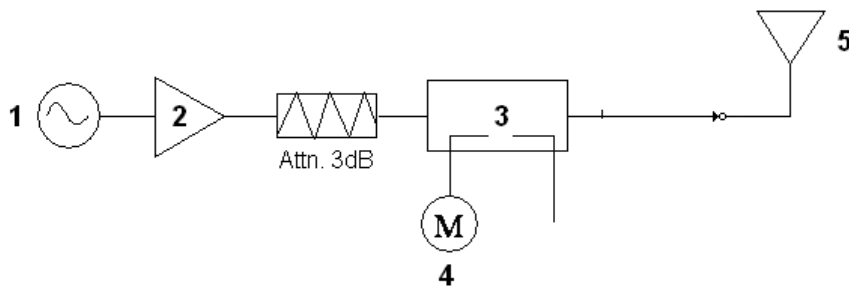

**Fig. 7.1 System Setup of System Evaluation**

1. Signal Generator
2. Amplifier
3. Directional Coupler
4. Power Meter
5. 835 or 1880 MHz Dipole

The output power on dipole port must be calibrated to 20dBm (100mW) before dipole is connected.



**Fig 7.2 Dipole Setup**



7.3 Validation Results

Frequency (MHz)	Input Power (dBm)	E-field Result (V/m)	Target Field (V/m)	Deviation (%)	Measurement date
835	20.00	175.70	167.1	5.15	Dec. 22, 2008
835	20.00	174.80	167.1	4.61	Dec. 27, 2008
835	20.00	168.50	167.1	0.84	Jan. 17, 2009
1880	20.00	147.70	138.9	6.34	Dec. 22, 2008
1880	20.00	148.45	138.9	6.88	Dec. 27, 2008
1880	20.00	146.50	138.9	5.47	Jan. 17, 2009
Frequency (MHz)	Input Power (dBm)	H-field Result (A/m)	Target Field (A/m)	Deviation (%)	Measurement date
835	20.00	0.459	0.453	1.32	Dec. 23, 2008
835	20.00	0.455	0.453	0.44	Dec. 27, 2008
835	20.00	0.515	0.453	13.69	Jan. 17, 2009
1880	20.00	0.497	0.471	5.52	Dec. 27, 2008
1880	20.00	0.545	0.471	15.71	Jan. 17, 2009

Table 7.1 System Validation

Remark: Deviation = ((E or H-field Result) - (Target field)) / (Target field) \* 100%

The table above indicates the system performance check can meet the variation criterion, ±25%.

**8. RF Field Probe Modulation Factor**

A calibration shall be made of the modulation response of the probe and its instrumentation chain. This calibration shall be performed with the field probe, attached to the instrumentation that is to be used with it during the measurement. The response of the probe system to a CW field at the frequency(s) of interest is compared to its response to a modulated signal with equal peak amplitude. The field level of the test signals shall be more than 10 dB above the ambient level and the noise floor of the instrumentation being used. The ratio of the CW reading to that taken with a modulated field shall be applied to the readings taken of modulated fields of the specified type.

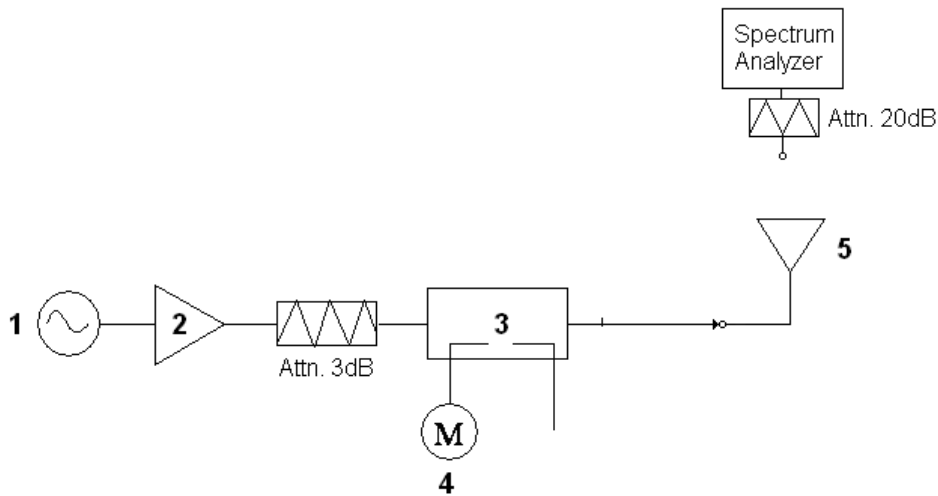

**Fig. 8.1 System Calibration**

This was done using the following procedure:

1. Fixing the probe in a set location relative to a field generating device.
2. Illuminate the probe with a CW signal at the intended measurement frequency.
3. Record the reading of the probe measurement system of the CW signal.
4. Determine the level of the CW signal being used to drive the field generating device.
5. Substitute a signal using the same modulation as that used by the intended WD for the CW signal.
6. Set the peak amplitude during transmission of the modulated signal to equal the amplitude of the CW signal.
7. Record the reading of the probe measurement system of the modulated signal.
8. The ratio of the CW to modulated signal reading is the modulation factor.
9. Repeat 2~8 steps at intended measurement frequency for both E and H field probe.





**PMF Measurement Summary:**

**For GSM**

Frequency	Functions	E-field	H-field	PMF	
		V/m	A/m	E-field	H-field
835MHz	CW	755	2.05	-	-
835MHz	AM	468	1.65	1.613	1.242
835MHz	GSM	286	1.444	2.640	1.420
1880MHz	CW	532.7	1.753	-	-
1880MHz	AM	330.8	1.471	1.610	1.192
1880MHz	GSM	199.9	1.47	2.665	1.193

**For WCDMA**

Frequency	Functions	E-field	H-field	PMF	
		V/m	A/m	E-field	H-field
835MHz	CW	277	0.572	-	-
835MHz	AM	186.4	0.411	1.486	1.392
835MHz	WCDMA	282.3	0.691	0.981	0.828
1880MHz	CW	196.6	0.645	-	-
1880MHz	AM	131.7	0.512	1.493	1.260
1880MHz	WCDMA	187.6	1.095	1.048	0.589



### Zero span Spectrum Plots for RF Field Probe Modulation Factor For GSM

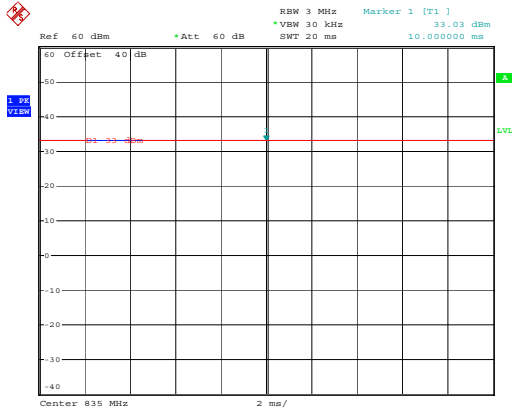

2nd comment ...  
Date: 1.SEP.2008 18:41:04

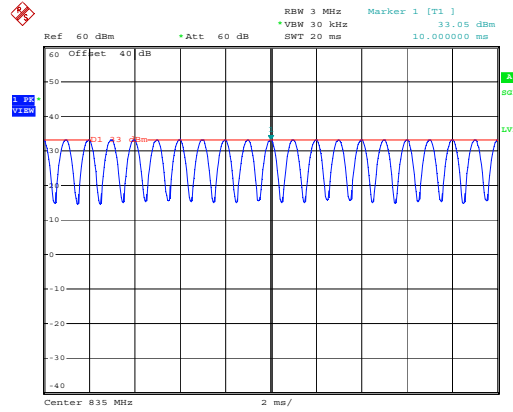

2nd comment ...  
Date: 1.SEP.2008 19:23:40

#### 835MHz - CW

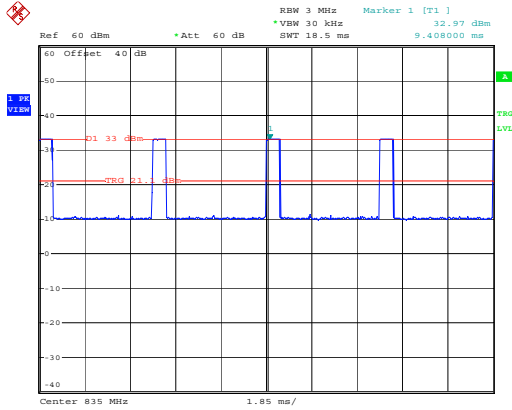

2nd comment ...  
Date: 1.SEP.2008 19:45:01

#### 835MHz - 80% AM

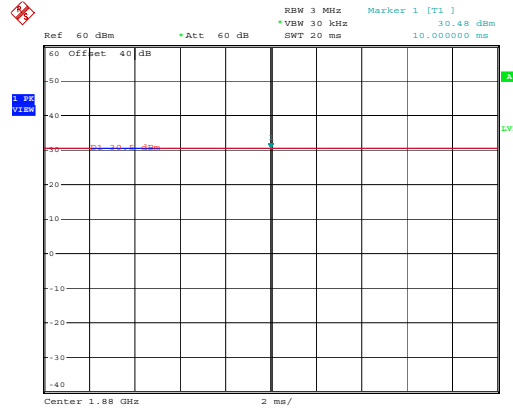

2nd comment ...  
Date: 1.SEP.2008 21:45:45

#### 835MHz - GSM

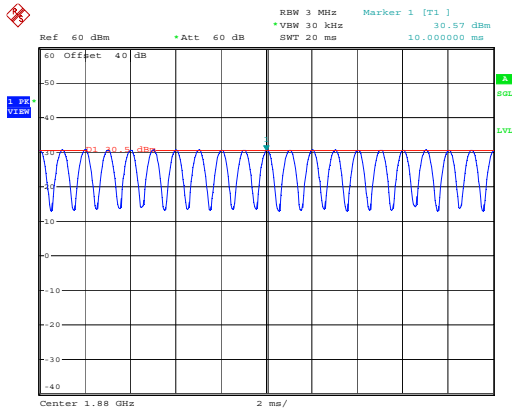

2nd comment ...  
Date: 1.SEP.2008 21:39:00

#### 1880MHz - CW

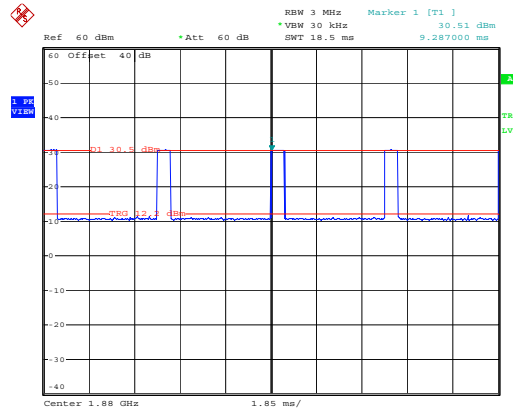

2nd comment ...  
Date: 1.SEP.2008 22:01:57

#### 1880MHz - 80% AM

#### 1880MHz - GSM



For WCDMA

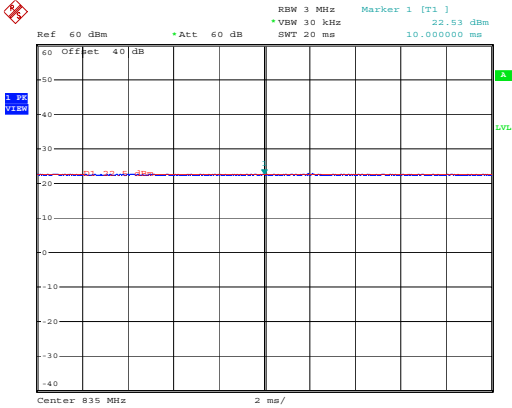

2nd comment ...  
Date: 1.SEP.2008 23:51:06

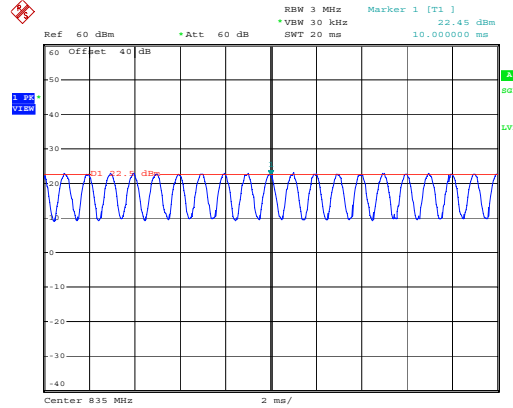

2nd comment ...  
Date: 2.SEP.2008 00:05:56

835MHz - CW

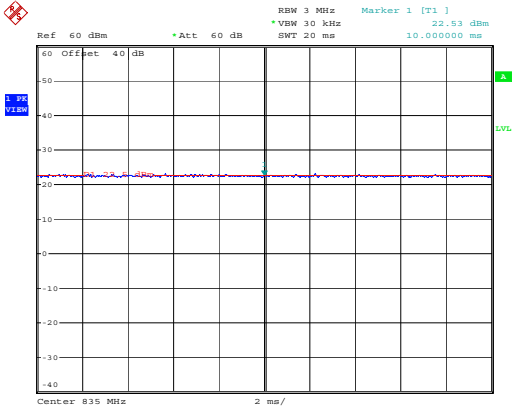

2nd comment ...  
Date: 2.SEP.2008 00:14:22

835MHz - 80% AM

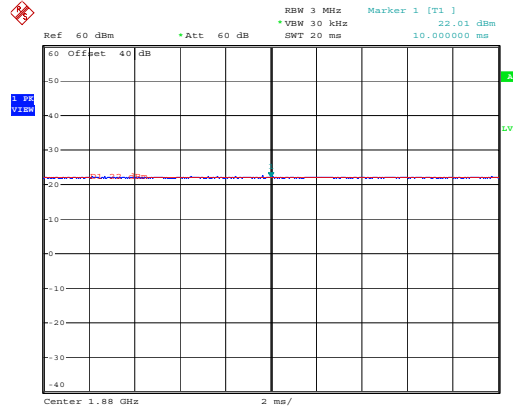

2nd comment ...  
Date: 2.SEP.2008 00:27:31

835MHz - WCDMA

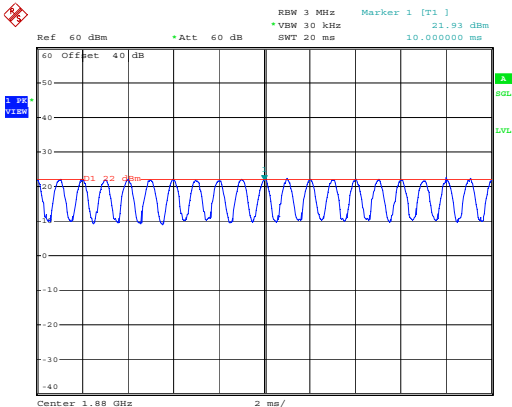

2nd comment ...  
Date: 2.SEP.2008 00:48:04

1880MHz - CW

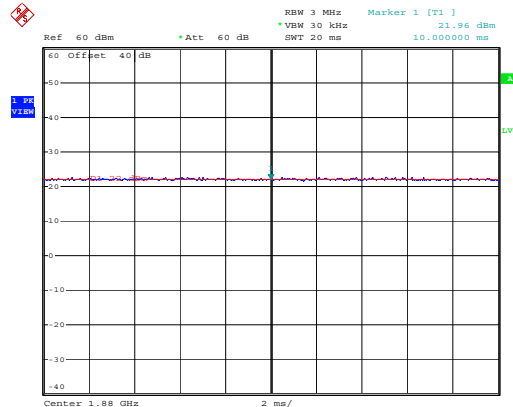

2nd comment ...  
Date: 2.SEP.2008 01:01:27

1880MHz - 80% AM

1880MHz - WCDMA

### 9. Description for DUT Testing Position

The DUT was put on device holder and adjusted to the accurate and reliable position. Figure 9.1 illustrate the references and reference plane that shall be used in a typical DUT emissions measurement. The principle of this section is applied to DUT with similar geometry.

- The grid is 5 cm by 5 cm area that is divided into 9 evenly sized blocks or sub-grids.
- The grid is centered on the audio frequency output transducer of the DUT.
- The grid is in a reference plane, which is defined as the planar area that contains the highest point in the area of the phone that normally rests against the user’s ear. It is parallel to the centerline of the receiver area of the phone and is defined by the points of the receiver-end of the DUT handset, which, in normal handset use, rest against the ear.
- The measurement plane is parallel to, and 1.0 cm in front of, the reference plane.



**Figure 9.1: A typical DUT reference and plane for HAC measurements**

Setup photographs please refer to Appendix E.



## **10. RF Emissions Test Procedure**

The following illustrate a typical RF emissions test scan over a wireless communications device:

1. Proper operation of the field probe, probe measurement system, other instrumentation, and the positioning system was confirmed.
2. DUT is positioned in its intended test position, acoustic output point of the device perpendicular to the field probe.
3. The DUT operation for maximum rated RF output power was configured and confirmed with the base station simulator, at the test channel and other normal operating parameters as intended for the test. The battery was ensured to be fully charged before each test.
4. The center sub-grid was centered over the center of the acoustic output (also audio band magnetic output, if applicable). The DUT audio output was positioned tangent (as physically possible) to the measurement plane.
5. A surface calibration was performed before each setup change to ensure repeatable spacing and proper maintenance of the measurement plane using the test Arch.
6. The measurement system measured the field strength at the reference location.
7. Measurements at 5 mm increments in the 5 x 5 cm region were performed and recorded. A 360° rotation about the azimuth axis at the maximum interpolated position was measured. For the worst-case condition, the peak reading from this rotation was used in re-evaluating the HAC category.
8. The system performed a drift evaluation by measuring the field at the reference location.
9. Steps 1-8 were done for both the E and H-Field measurements.

**11. HAC Test Results**

**11.1 Conducted Power**

Band	GSM 850			GSM 1900		
Channel	128	189	251	512	661	810
GSM	32.42	32.73	32.98	29.83	30.19	30.32

Band	WCDMA Band V			WCDMA Band II		
Channel	4132	4182	4233	9262	9400	9538
12.2K	22.29	22.30	22.41	21.47	21.79	22.11

Unit: dBm

**11.2 E-Field Emission**

**<DUT Slide Off Mode>**

Mode	Channel	Frequency (MHz)	Modulation Type	PMF	Peak Field (V/m)	M-Rating
GSM850	128	824.2	GMSK	2.640	138.8	M4
	189	836.4	GMSK	2.640	182.2	M3
	<b>251</b>	<b>848.8</b>	<b>GMSK</b>	<b>2.640</b>	<b>190.5</b>	<b>M3</b>
GSM1900	512	1850.2	GMSK	2.665	70.8	M3
	<b>661</b>	<b>1880.0</b>	<b>GMSK</b>	<b>2.665</b>	<b>75.7</b>	<b>M3</b>
	810	1909.8	GMSK	2.665	75.0	M3
WCDMA Band V	4132	826.4	QPSK	0.981	56.0	M4
	4182	836.4	QPSK	0.981	59.4	M4
	<b>4233</b>	<b>846.6</b>	<b>QPSK</b>	<b>0.981</b>	<b>62.9</b>	<b>M4</b>
WCDMA Band II	<b>9262</b>	<b>1852.4</b>	<b>QPSK</b>	<b>1.048</b>	<b>30.4</b>	<b>M4</b>
	9400	1880.0	QPSK	1.048	29.7	M4
	9538	1907.6	QPSK	1.048	27.3	M4

**<DUT Slide Right Mode>**

Mode	Channel	Frequency (MHz)	Modulation Type	PMF	Peak Field (V/m)	M-Rating
GSM850	128	824.2	GMSK	2.640	132.2	M4
	189	836.4	GMSK	2.640	161.2	M3
	<b>251</b>	<b>848.8</b>	<b>GMSK</b>	<b>2.640</b>	<b>196.6</b>	<b>M3</b>
GSM1900	<b>512</b>	<b>1850.2</b>	<b>GMSK</b>	<b>2.665</b>	<b>48.5</b>	<b>M3</b>
	661	1880.0	GMSK	2.665	42.8	M4
	810	1909.8	GMSK	2.665	43.6	M4
WCDMA Band V	4132	826.4	QPSK	0.981	49.3	M4
	4182	836.4	QPSK	0.981	56.6	M4
	<b>4233</b>	<b>846.6</b>	<b>QPSK</b>	<b>0.981</b>	<b>60.9</b>	<b>M4</b>
WCDMA Band II	<b>9262</b>	<b>1852.4</b>	<b>QPSK</b>	<b>1.048</b>	<b>22.3</b>	<b>M4</b>
	9400	1880.0	QPSK	1.048	22.0	M4
	9538	1907.6	QPSK	1.048	20.2	M4

11.3 H-Field Emission

<DUT Slide Off Mode>

Mode	Chan.	Freq. (MHz)	Modulation Type	PMF	Peak Field (V/m)	M-Rating
GSM850	128	824.2	GMSK	1.420	0.121	M4
	189	836.4	GMSK	1.420	0.138	M4
	<b>251</b>	<b>848.8</b>	<b>GMSK</b>	<b>1.420</b>	<b>0.171</b>	<b>M4</b>
GSM1900	512	1850.2	GMSK	1.193	0.076	M4
	661	1880.0	GMSK	1.193	0.076	M4
	<b>810</b>	<b>1909.8</b>	<b>GMSK</b>	<b>1.193</b>	<b>0.078</b>	<b>M4</b>
WCDMA Band V	4132	826.4	QPSK	0.828	0.071	M4
	4182	836.4	QPSK	0.828	0.075	M4
	<b>4233</b>	<b>846.6</b>	<b>QPSK</b>	<b>0.828</b>	<b>0.08</b>	<b>M4</b>
WCDMA Band II	<b>9262</b>	<b>1852.4</b>	<b>QPSK</b>	<b>0.589</b>	<b>0.043</b>	<b>M4</b>
	9400	1880.0	QPSK	0.589	0.043	M4
	9538	1907.6	QPSK	0.589	0.039	M4

<DUT Slide Right Mode>

Mode	Chan.	Freq. (MHz)	Modulation Type	PMF	Peak Field (V/m)	M-Rating
GSM850	128	824.2	GMSK	1.420	0.110	M4
	189	836.4	GMSK	1.420	0.135	M4
	<b>251</b>	<b>848.8</b>	<b>GMSK</b>	<b>1.420</b>	<b>0.166</b>	<b>M4</b>
GSM1900	<b>512</b>	<b>1850.2</b>	<b>GMSK</b>	<b>1.193</b>	<b>0.08</b>	<b>M4</b>
	661	1880.0	GMSK	1.193	0.063	M4
	810	1909.8	GMSK	1.193	0.06	M4
WCDMA Band V	4132	826.4	QPSK	0.828	0.054	M4
	4182	836.4	QPSK	0.828	0.063	M4
	<b>4233</b>	<b>846.6</b>	<b>QPSK</b>	<b>0.828</b>	<b>0.07</b>	<b>M4</b>
WCDMA Band II	9262	1852.4	QPSK	0.589	0.022	M4
	<b>9400</b>	<b>1880.0</b>	<b>QPSK</b>	<b>0.589</b>	<b>0.023</b>	<b>M4</b>
	9538	1907.6	QPSK	0.589	0.02	M4

**Remark:**

1. The output power is adjusted to maximum level during RF Emission testing.
2. This device does not support V.O.I.P.. It means that the functions of WLAN and Bluetooth do not have voice capability in the held to ear mode.
3. Test Engineer: Robert Liu, Eric Huang, and Jason Wang



## **12. References**

- [1] ANSI C63.19-2006, “American National Standard for Methods of Measurement of Compatibility between Wireless Communications Devices and Hearing Aids”
- [2] DASY4 System Hand book.





### Appendix A - System Performance Check Data

Test Laboratory: Sporton International Inc. SAR/HAC Testing Lab

Date: 2008/12/22

HAC\_E\_Dipole\_835\_20081222

DUT: HAC-Dipole 835 MHz

Communication System: CW; Frequency: 835 MHz; Duty Cycle: 1:1  
Medium: Air Medium parameters used:  $\sigma = 0$  mho/m,  $\epsilon_r = 1$ ;  $\rho = 1000$  kg/m<sup>3</sup>  
Ambient Temperature : 22.8 °C

DASY4 Configuration:

- Probe: ER3DV6 - SN2358; ConvF(1, 1, 1); Calibrated: 2008/1/28
- Sensor-Surface: (Fix Surface)
- Electronics: DAE3 Sn577; Calibrated: 2008/11/12
- Phantom: HAC Test Arch 4.6; Type: SD HAC P01 BA
- Measurement SW: DASY4, V4.7 Build 71; Postprocessing SW: SEMCAD, V1.8 Build 184

**E Scan - ER probe center 10mm above CD835 Dipole/Hearing Aid Compatibility Test (41x361x1):** Measurement grid:  
dx=5mm, dy=5mm  
Probe Modulation Factor = 1.00  
Device Reference Point: 0.000, 0.000, 353.7 mm  
Reference Value = 60.1 V/m; Power Drift = -0.010 dB  
**Average value of Total = (184.3 + 167.1) / 2 = 175.7 V/m**

Peak E-field in V/m

Grid 1 <b>180.3 M4</b>	Grid 2 <b>184.3 M4</b>	Grid 3 <b>175.8 M4</b>
Grid 4 <b>88.3 M4</b>	Grid 5 <b>94.1 M4</b>	Grid 6 <b>92.3 M4</b>
Grid 7 <b>161.0 M4</b>	Grid 8 <b>167.1 M4</b>	Grid 9 <b>163.5 M4</b>

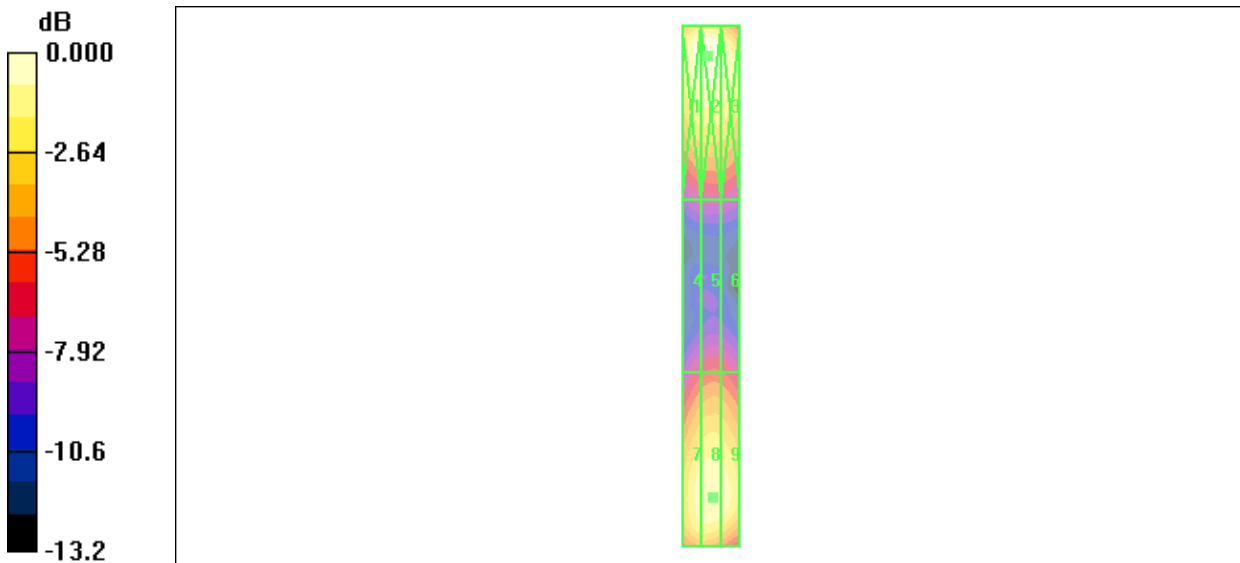

0 dB = 184.3V/m



Test Laboratory: Sporton International Inc. SAR/HAC Testing Lab

Date: 2008/12/27

HAC\_E\_Dipole\_835\_20081227

DUT: HAC-Dipole 835 MHz

Communication System: CW; Frequency: 835 MHz; Duty Cycle: 1:1
Medium: Air Medium parameters used: sigma = 0 mho/m, epsilon\_r = 1; rho = 1000 kg/m^3
Ambient Temperature : 22.6 C

DASY4 Configuration:

- Probe: ER3DV6 - SN2358; ConvF(1, 1, 1); Calibrated: 2008/1/28
- Sensor-Surface: (Fix Surface)
- Electronics: DAE3 Sn577; Calibrated: 2008/11/12
- Phantom: HAC Test Arch 4.6; Type: SD HAC P01 BA
- Measurement SW: DASY4, V4.7 Build 71; Postprocessing SW: SEMCAD, V1.8 Build 184

E Scan - ER probe center 10mm above CD835 Dipole/Hearing Aid Compatibility Test (41x361x1): Measurement grid:
dx=5mm, dy=5mm
Probe Modulation Factor = 1.00
Device Reference Point: 0.000, 0.000, 353.7 mm
Reference Value = 59.4 V/m; Power Drift = 0.035 dB
Average value of Total = (179.9 + 169.7) / 2 = 174.8 V/m

Peak E-field in V/m

Table with 3 columns (Grid 1-3, Grid 4-6, Grid 7-9) and 3 rows of peak E-field values in V/m.

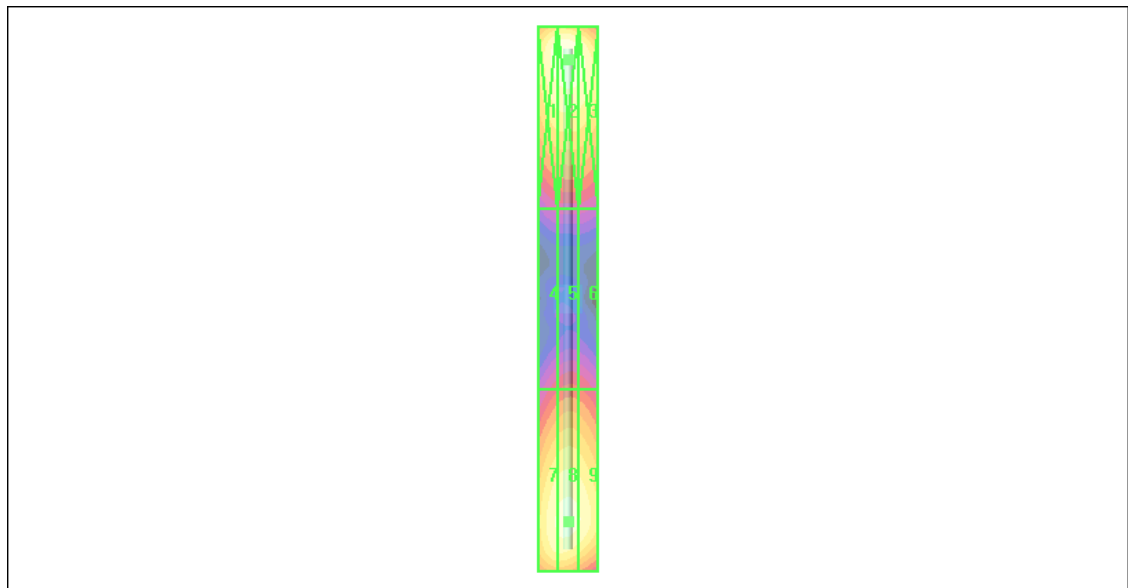
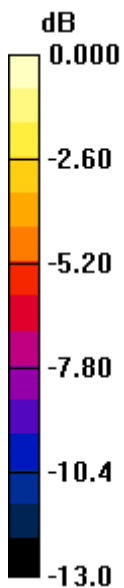

0 dB = 179.9V/m



Test Laboratory: Sporton International Inc. SAR/HAC Testing Lab

Date: 2009/1/17

HAC\_E\_Dipole\_835\_20090117

DUT: HAC-Dipole 835 MHz

Communication System: CW; Frequency: 835 MHz; Duty Cycle: 1:1
Medium: Air Medium parameters used: sigma = 0 mho/m, epsilon\_r = 1; rho = 1000 kg/m^3
Ambient Temperature : 22.5 C

DASY4 Configuration:

- Probe: ER3DV6 - SN2358; ConvF(1, 1, 1); Calibrated: 2008/1/28
- Sensor-Surface: (Fix Surface)
- Electronics: DAE4 Sn778; Calibrated: 2008/9/22
- Phantom: HAC Test Arch 4.6; Type: SD HAC P01 BA
- Measurement SW: DASY5, V5.0 Build 120; SEMCAD X Version 13.2 Build 87

E Scan - ER probe center 10mm above CD835 Dipole/Hearing Aid Compatibility Test (41x361x1): Measurement grid:
dx=5mm, dy=5mm
Probe Modulation Factor = 1
Device Reference Point: 0, 0, 353.7 mm
Reference Value = 57.3 V/m; Power Drift = -0.016 dB
Average value of Total = (172.9 + 164.1) / 2 = 168.5 V/m

Peak E-field in V/m

Table with 3 columns (Grid 1-3, Grid 4-6, Grid 7-9) and 3 rows of peak E-field values in V/m.

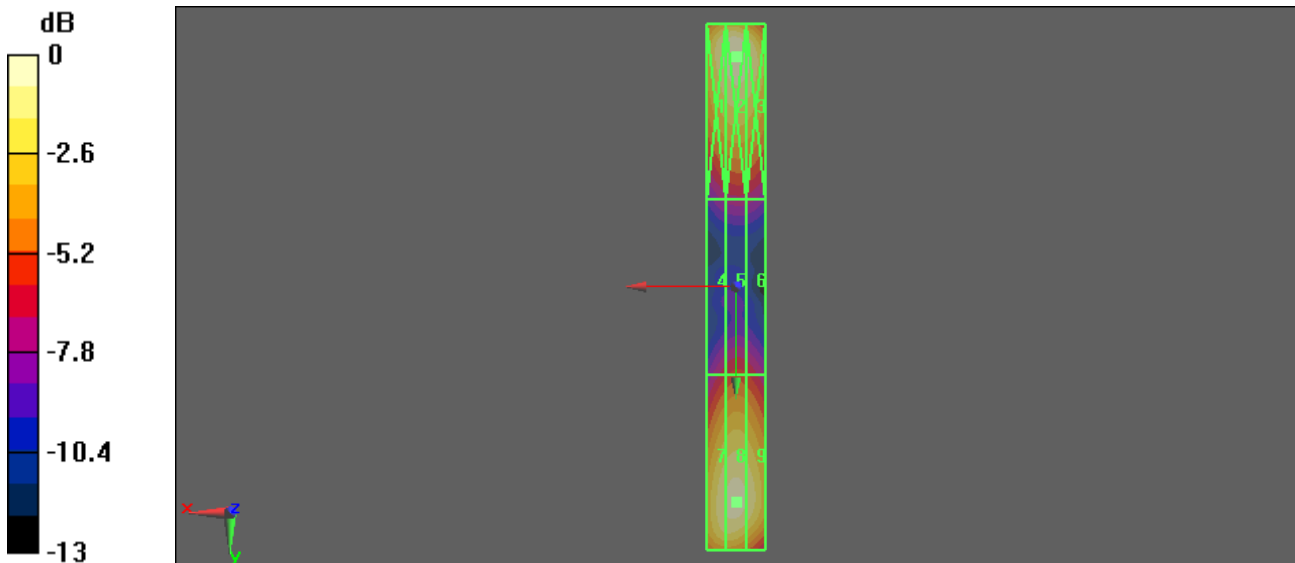

0 dB = 172.9V/m



Test Laboratory: Sporton International Inc. SAR/HAC Testing Lab

Date: 2008/12/22

HAC\_E\_Dipole\_1880\_20081222

DUT: HAC Dipole 1880 MHz

Communication System: CW; Frequency: 1880 MHz; Duty Cycle: 1:1
Medium: Air Medium parameters used: sigma = 0 mho/m, epsilon\_r = 1; rho = 1000 kg/m^3
Ambient Temperature : 22.7 C

DASY4 Configuration:

- Probe: ER3DV6 - SN2358; ConvF(1, 1, 1); Calibrated: 2008/1/28
- Sensor-Surface: (Fix Surface)
- Electronics: DAE3 Sn577; Calibrated: 2008/11/12
- Phantom: HAC Test Arch 4.6; Type: SD HAC P01 BA
- Measurement SW: DASY4, V4.7 Build 71; Postprocessing SW: SEMCAD, V1.8 Build 184

E Scan - ER probe center 10mm above CD1880 Dipole/Hearing Aid Compatibility Test (41x181x1): Measurement
grid: dx=5mm, dy=5mm
Probe Modulation Factor = 1.00
Device Reference Point: 0.000, 0.000, 353.7 mm
Reference Value = 71.8 V/m; Power Drift = 0.011 dB
Average value of Total = (147.5 + 147.9) / 2 = 147.7 V/m

Peak E-field in V/m

Table with 3 columns (Grid 1-3, Grid 4-6, Grid 7-9) and 3 rows of peak E-field values in V/m.

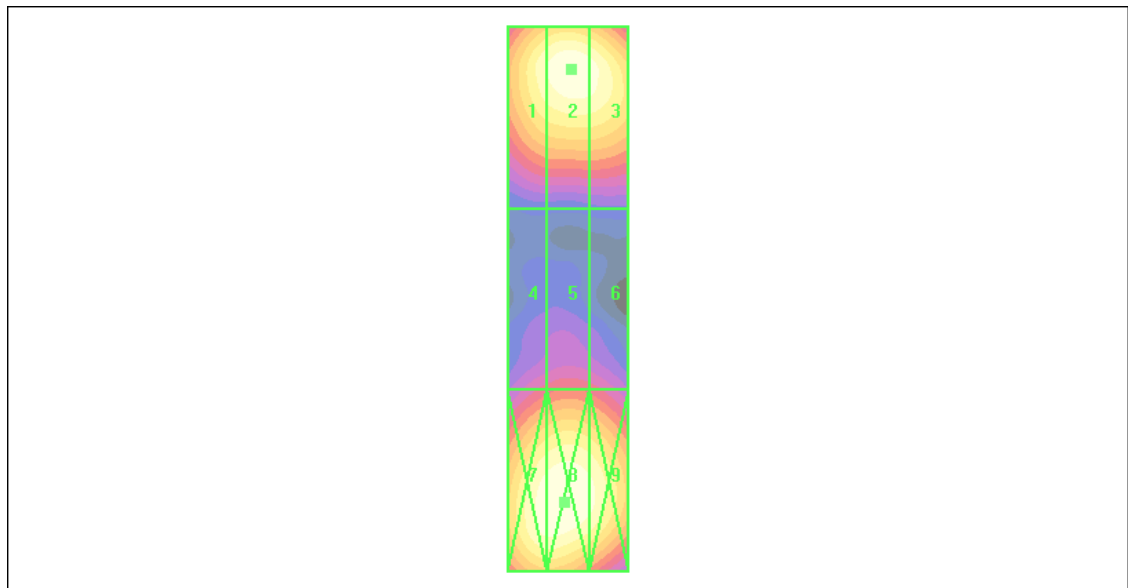
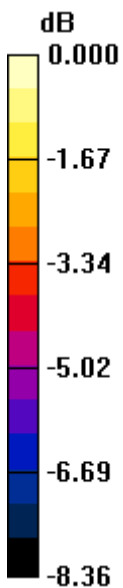

0 dB = 147.9V/m



Test Laboratory: Sporton International Inc. SAR/HAC Testing Lab

Date: 2008/12/27

HAC\_E\_Dipole\_1880\_20081227

DUT: HAC Dipole 1880 MHz

Communication System: CW; Frequency: 1880 MHz; Duty Cycle: 1:1
Medium: Air Medium parameters used: sigma = 0 mho/m, epsilon\_r = 1; rho = 1000 kg/m^3
Ambient Temperature : 22.6 C

DASY4 Configuration:

- Probe: ER3DV6 - SN2358; ConvF(1, 1, 1); Calibrated: 2008/1/28
- Sensor-Surface: (Fix Surface)
- Electronics: DAE3 Sn577; Calibrated: 2008/11/12
- Phantom: HAC Test Arch 4.6; Type: SD HAC P01 BA
- Measurement SW: DASY4, V4.7 Build 71; Postprocessing SW: SEMCAD, V1.8 Build 184

E Scan - ER probe center 10mm above CD1880 Dipole/Hearing Aid Compatibility Test (41x181x1): Measurement
grid: dx=5mm, dy=5mm
Probe Modulation Factor = 1.00
Device Reference Point: 0.000, 0.000, 353.7 mm
Reference Value = 72.1 V/m; Power Drift = -0.005 dB
Average value of Total = (148.2 + 148.7) / 2 = 148.45 V/m

Peak E-field in V/m

Table with 3 columns (Grid 1-3, Grid 4-6, Grid 7-9) and 3 rows of peak E-field values in V/m.

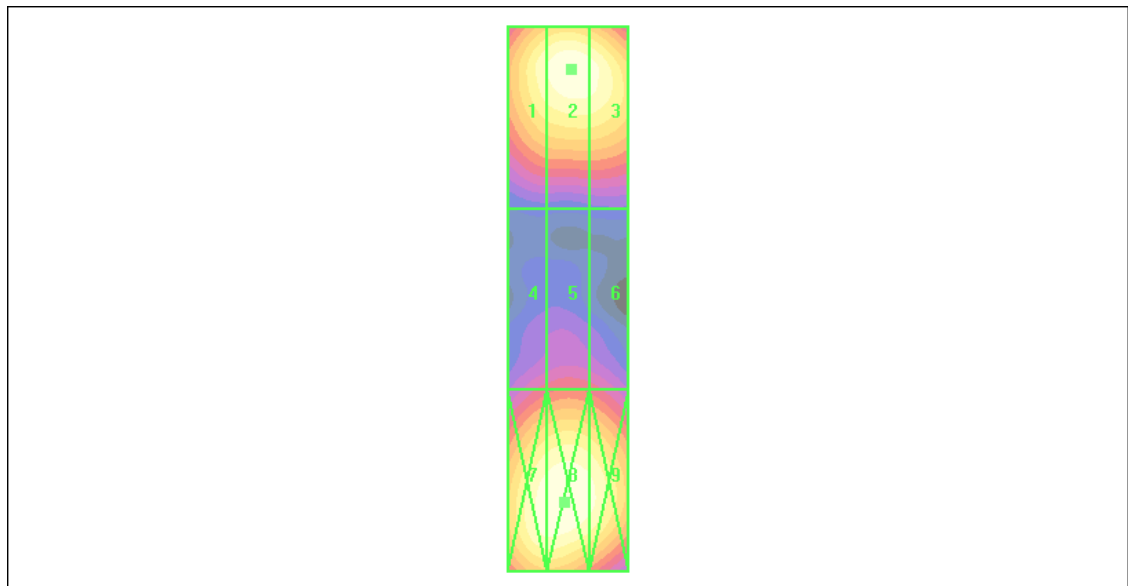
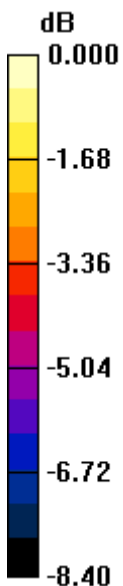

0 dB = 148.7V/m



Test Laboratory: Sporton International Inc. SAR/HAC Testing Lab

Date: 2009/1/17

HAC\_E\_Dipole\_1880\_20090117

DUT: HAC Dipole 1880 MHz

Communication System: CW; Frequency: 1880 MHz;Duty Cycle: 1:1
Medium: Air Medium parameters used: sigma = 0 mho/m, epsilon\_r = 1; rho = 1000 kg/m^3
Ambient Temperature : 22.7

DASY4 Configuration:

- Probe: ER3DV6 - SN2358; ConvF(1, 1, 1); Calibrated: 2008/1/28
- Sensor-Surface: (Fix Surface)
- Electronics: DAE4 Sn778; Calibrated: 2008/9/22
- Phantom: HAC Test Arch 4.6; Type: SD HAC P01 BA
- Measurement SW: DASY5, V5.0 Build 120; SEMCAD X Version 13.2 Build 87

E Scan - ER probe center 10mm above CD1880 Dipole/Hearing Aid Compatibility Test (41x181x1): Measurement

grid: dx=5mm, dy=5mm
Probe Modulation Factor = 1
Device Reference Point: 0, 0, 353.7 mm
Reference Value = 71.5 V/m; Power Drift = 0.00361 dB
Average value of Total = (146.4 + 146.6) / 2 = 146.5 V/m

Peak E-field in V/m

Table with 3 rows and 3 columns showing Peak E-field in V/m for Grids 1 through 9. Grid 2 and Grid 8 are highlighted in yellow.

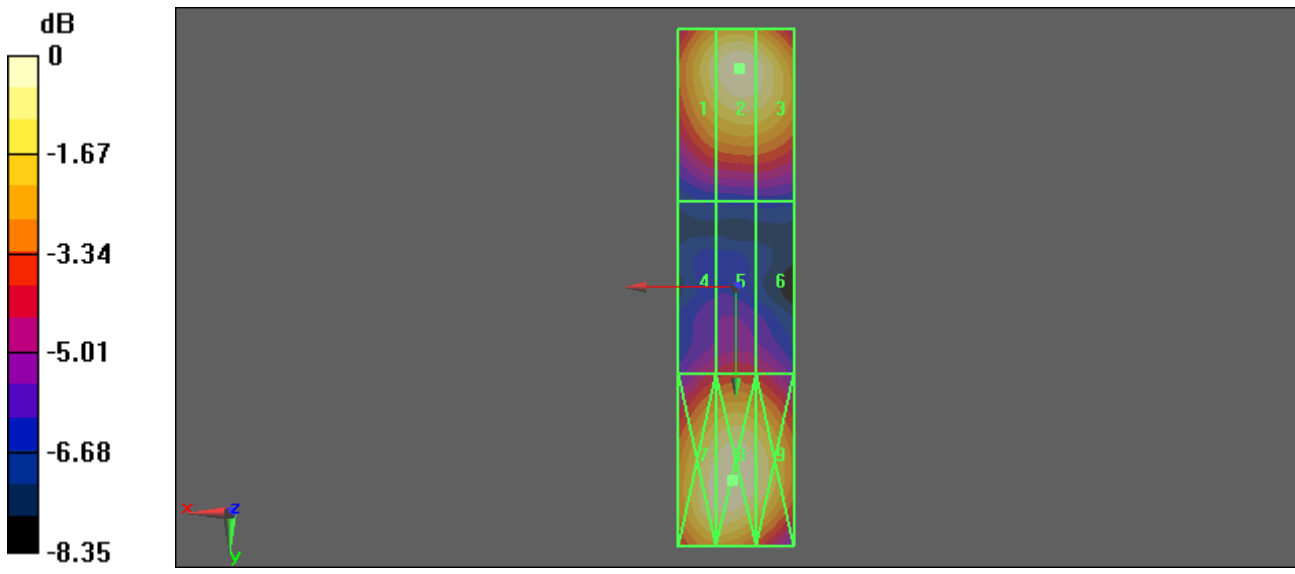

0 dB = 146.6V/m



Test Laboratory: Sporton International Inc. SAR/HAC Testing Lab

Date: 2008/12/23

HAC\_H\_Dipole\_835\_20081223

DUT: HAC-Dipole 835 MHz

Communication System: CW; Frequency: 835 MHz; Duty Cycle: 1:1
Medium: Air Medium parameters used: sigma = 0 mho/m, epsilon\_r = 1; rho = 1 kg/m^3
Ambient Temperature : 22.9 C

DASY4 Configuration:

- Probe: H3DV6 - SN6184; ; Calibrated: 2008/1/28
- Sensor-Surface: (Fix Surface)
- Electronics: DAE3 Sn577; Calibrated: 2008/11/12
- Phantom: HAC Test Arch 4.6; Type: SD HAC P01 BA
- Measurement SW: DASY4, V4.7 Build 71; Postprocessing SW: SEMCAD, V1.8 Build 184

H Scan - HSDV6 probe center 10mm above CD835 Dipole/Hearing Aid Compatibility Test (41x361x1):

Measurement grid: dx=5mm, dy=5mm
Probe Modulation Factor = 1.00
Device Reference Point: 0.000, 0.000, 353.7 mm
Reference Value = 0.447 A/m; Power Drift = -0.050 dB
Maximum value of Total = 0.459 A/m

Peak H-field in A/m

Table with 3 columns (Grid 1-3, Grid 4-6, Grid 7-9) and 3 rows of peak H-field values in A/m, with Grid 5 highlighted as the maximum value of 0.459 M4.

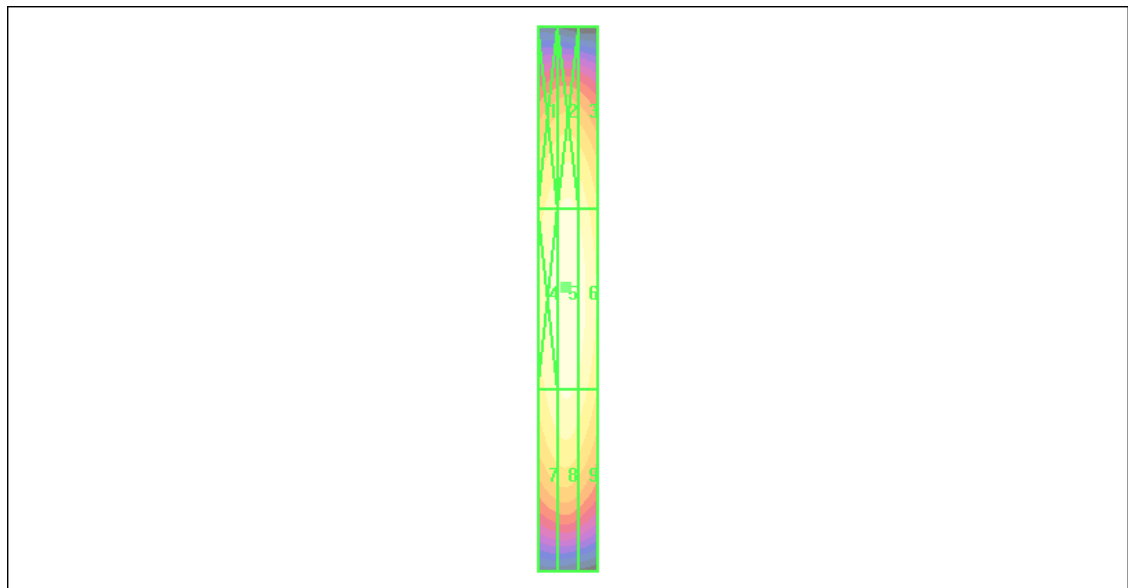
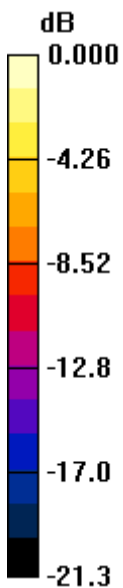

0 dB = 0.459A/m



Test Laboratory: Sporton International Inc. SAR/HAC Testing Lab

Date: 2008/12/27

HAC\_H\_Dipole\_835\_20081227

DUT: HAC-Dipole 835 MHz

Communication System: CW; Frequency: 835 MHz; Duty Cycle: 1:1
Medium: Air Medium parameters used: sigma = 0 mho/m, epsilon\_r = 1; rho = 1 kg/m^3
Ambient Temperature : 22.7 C

DASY4 Configuration:

- Probe: H3DV6 - SN6184; ; Calibrated: 2008/1/28
- Sensor-Surface: (Fix Surface)
- Electronics: DAE3 Sn577; Calibrated: 2008/11/12
- Phantom: HAC Test Arch 4.6; Type: SD HAC P01 BA
- Measurement SW: DASY4, V4.7 Build 71; Postprocessing SW: SEMCAD, V1.8 Build 184

H Scan - H3DV6 probe center 10mm above CD835 Dipole/Hearing Aid Compatibility Test (41x361x1): Measurement
grid: dx=5mm, dy=5mm
Probe Modulation Factor = 1.00
Device Reference Point: 0.000, 0.000, 353.7 mm
Reference Value = 0.442 A/m; Power Drift = -0.010 dB
Maximum value of Total = 0.455 A/m

Peak H-field in A/m

Table with 3 columns (Grid 1-3, Grid 4-6, Grid 7-9) and 3 rows of peak H-field values in A/m, with Grid 5 highlighted as 0.455 M4.

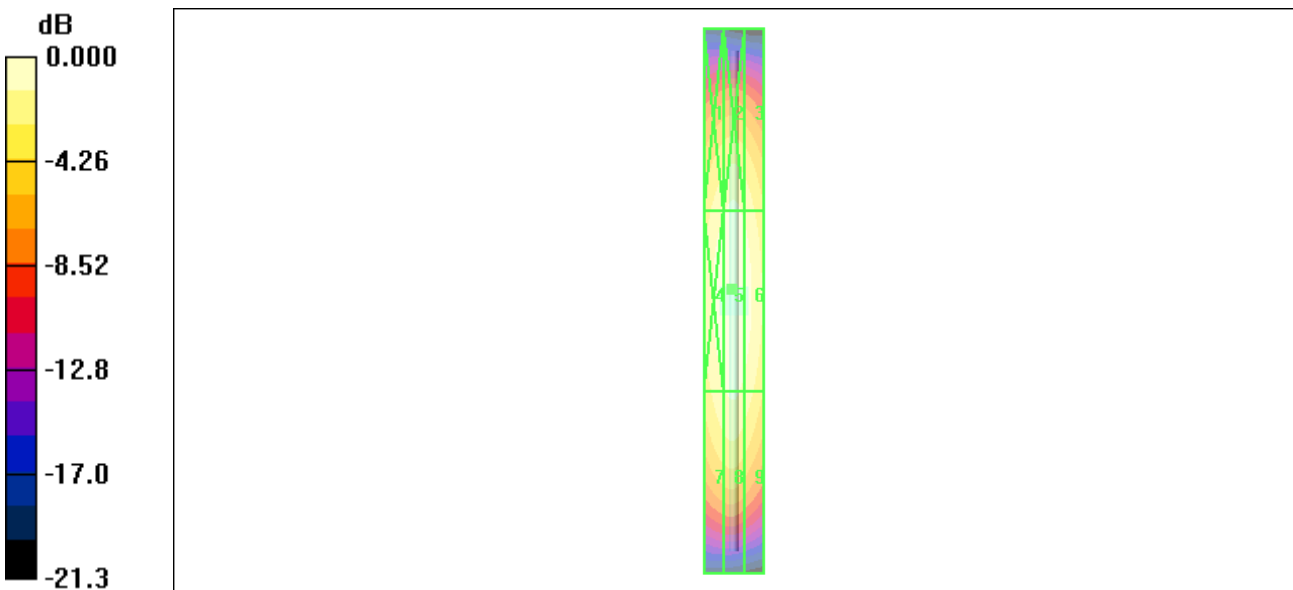

0 dB = 0.455A/m





Test Laboratory: Sporton International Inc. SAR/HAC Testing Lab

Date: 2009/1/17

HAC\_H\_Dipole\_835\_20090117

DUT: HAC-Dipole 835 MHz

Communication System: CW; Frequency: 835 MHz;Duty Cycle: 1:1
Medium: Air Medium parameters used: sigma = 0 mho/m, epsilon\_r = 1; rho = 1 kg/m^3
Ambient Temperature : 22.6

DASY4 Configuration:

- Probe: H3DV6 - SN6184; ; Calibrated: 2008/1/28
- Sensor-Surface: (Fix Surface)
- Electronics: DAE4 Sn778; Calibrated: 2008/9/22
- Phantom: HAC Test Arch 4.6; Type: SD HAC P01 BA
- Measurement SW: DASY5, V5.0 Build 120; SEMCAD X Version 13.2 Build 87

H Scan - H3DV6 probe center 10mm above CD835 Dipole/Hearing Aid Compatibility Test (41x361x1): Measurement
grid: dx=5mm, dy=5mm
Probe Modulation Factor = 1
Device Reference Point: 0, 0, 353.7 mm
Reference Value = 0.500 A/m; Power Drift = -0.00977 dB
Maximum value of Total = 0.515 A/m

Peak H-field in A/m

Table with 3 columns (Grid 1-3, Grid 4-6, Grid 7-9) and 3 rows of peak H-field values in A/m. Grid 5 has the highest value of 0.515 M4.

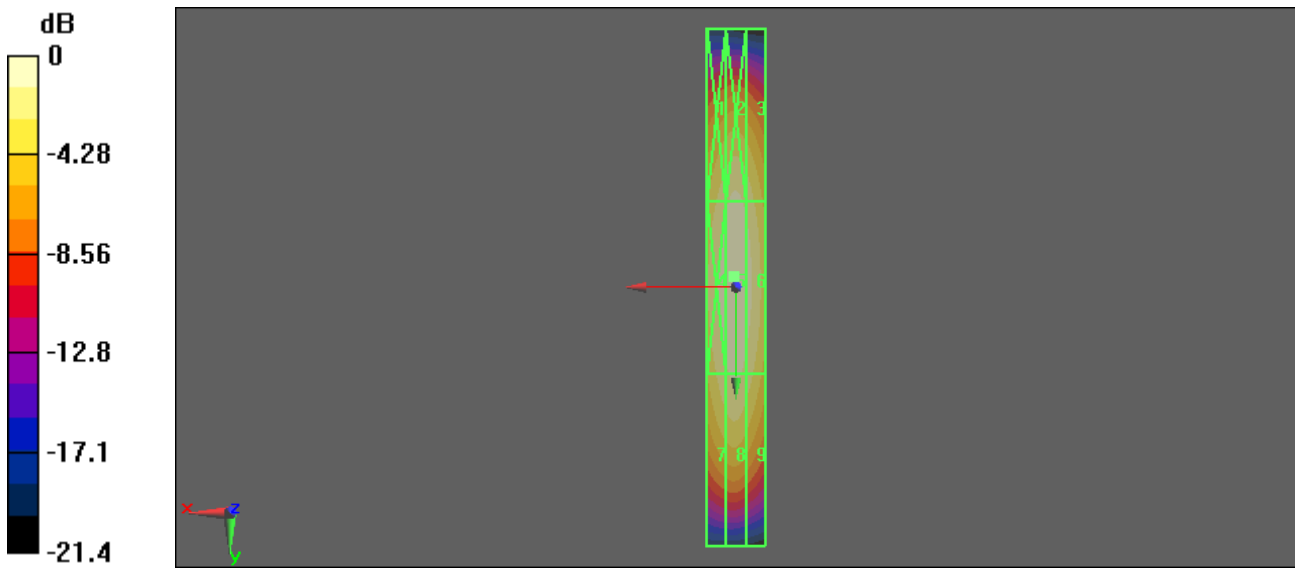

0 dB = 0.515A/m



Test Laboratory: Sporton International Inc. SAR/HAC Testing Lab

Date: 2008/12/27

HAC\_H\_Dipole\_1880\_20081227

DUT: HAC Dipole 1880 MHz

Communication System: CW; Frequency: 1880 MHz; Duty Cycle: 1:1
Medium: Air Medium parameters used: sigma = 0 mho/m, epsilon\_r = 1; rho = 1 kg/m^3
Ambient Temperature : 22.6

DASY4 Configuration:

- Probe: H3DV6 - SN6184; ; Calibrated: 2008/1/28
- Sensor-Surface: (Fix Surface)
- Electronics: DAE3 Sn577; Calibrated: 2008/11/12
- Phantom: HAC Test Arch 4.6; Type: SD HAC P01 BA
- Measurement SW: DASY4, V4.7 Build 71; Postprocessing SW: SEMCAD, V1.8 Build 184

H Scan - HSDV6 probe center 10mm above CD1880 Dipole/Hearing Aid Compatibility Test (41x181x1):

Measurement grid: dx=5mm, dy=5mm
Probe Modulation Factor = 1.00
Device Reference Point: 0.000, 0.000, 353.7 mm
Reference Value = 0.485 A/m; Power Drift = -0.008 dB
Maximum value of Total = 0.497 A/m

Peak H-field in A/m

Table with 3 columns (Grid 1-3, Grid 4-6, Grid 7-9) and 3 rows of peak H-field values in A/m, with Grid 5 highlighted as the maximum value of 0.497 M2.

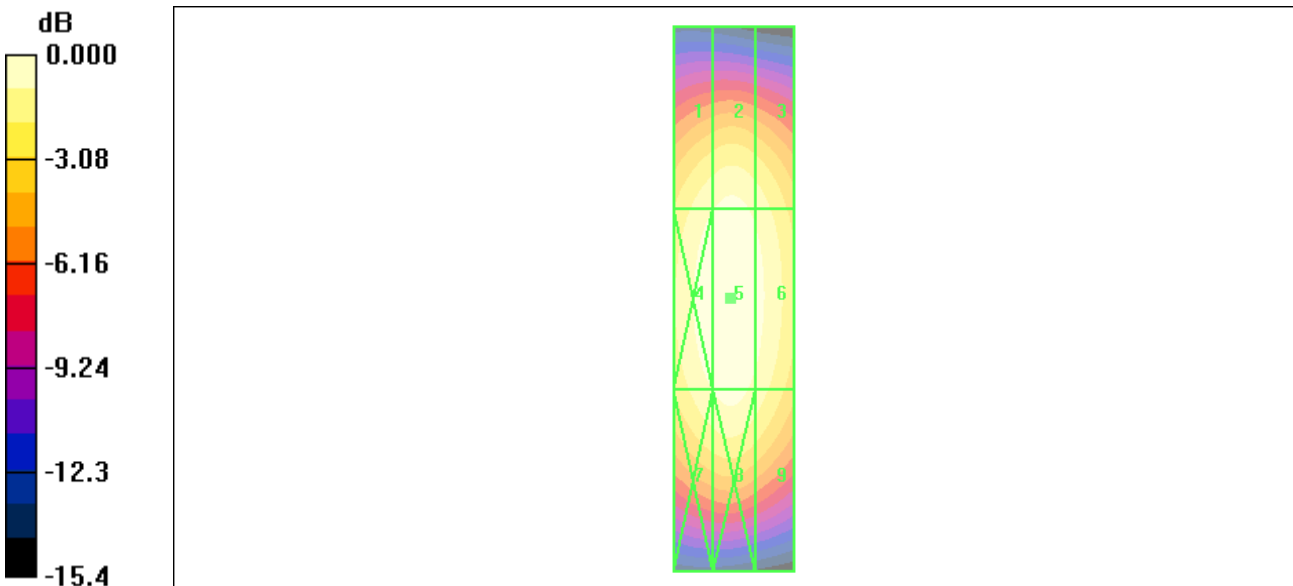

0 dB = 0.497A/m



Test Laboratory: Sporton International Inc. SAR/HAC Testing Lab

Date: 2009/1/17

HAC\_H\_Dipole\_1880\_20090117

DUT: HAC Dipole 1880 MHz

Communication System: CW; Frequency: 1880 MHz; Duty Cycle: 1:1
Medium: Air Medium parameters used: sigma = 0 mho/m, epsilon\_r = 1; rho = 1 kg/m^3
Ambient Temperature : 22.5

DASY4 Configuration:

- Probe: H3DV6 - SN6184; ; Calibrated: 2008/1/28
- Sensor-Surface: (Fix Surface)
- Electronics: DAE4 Sn778; Calibrated: 2008/9/22
- Phantom: HAC Test Arch 4.6; Type: SD HAC P01 BA
- Measurement SW: DASY5, V5.0 Build 120; SEMCAD X Version 13.2 Build 87

H Scan - HSDV6 probe center 10mm above CD1880 Dipole/Hearing Aid Compatibility Test (41x181x1):

Measurement grid: dx=5mm, dy=5mm
Probe Modulation Factor = 1
Device Reference Point: 0, 0, 353.7 mm
Reference Value = 0.533 A/m; Power Drift = -0.00744 dB
Maximum value of Total = 0.545 A/m

Peak H-field in A/m

Table with 3 columns (Grid 1-3, Grid 4-6, Grid 7-9) and 3 rows of peak H-field values in A/m, with Grid 5 highlighted as 0.545 M2.

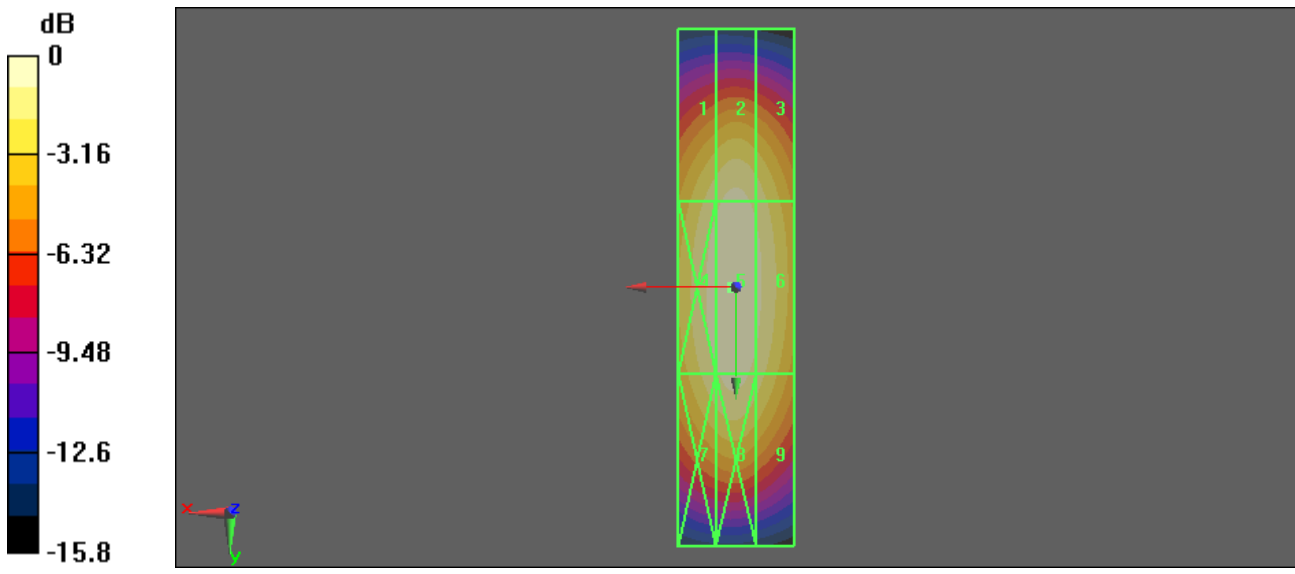

0 dB = 0.545A/m



### Appendix B - HAC Measurement Data

Test Laboratory: Sporton International Inc. SAR/HAC Testing Lab

Date: 2008/12/22

HAC\_E\_GSM850 Ch128\_Slide Off

DUT: 8D1718

Communication System: GSM850; Frequency: 824.2 MHz; Duty Cycle: 1:8.3  
Medium: Air Medium parameters used:  $\sigma = 0$  mho/m,  $\epsilon_r = 1$ ;  $\rho = 1000$  kg/m<sup>3</sup>  
Ambient Temperature : 22.8 °C

DASY4 Configuration:

- Probe: ER3DV6 - SN2358; ConvF(1, 1, 1); Calibrated: 2008/1/28
- Sensor-Surface: (Fix Surface)
- Electronics: DAE3 Sn577; Calibrated: 2008/11/12
- Phantom: HAC Test Arch 4.6; Type: SD HAC P01 BA;
- Measurement SW: DASY4, V4.7 Build 71; Postprocessing SW: SEMCAD, V1.8 Build 184

**Ch128/Hearing Aid Compatibility Test (101x101x1):** Measurement grid: dx=5mm, dy=5mm  
 Maximum value of peak Total field = 138.8 V/m  
 Probe Modulation Factor = 2.64  
 Device Reference Point: 0.000, 0.000, 353.7 mm  
 Reference Value = 57.0 V/m; Power Drift = -0.164 dB  
 Test Arch Compensation is Applied.  
**Hearing Aid Near-Field Category: M4 (AWF -5 dB)**

Peak E-field in V/m

Grid 1 <b>123.1 M4</b>	Grid 2 <b>140.3 M4</b>	Grid 3 <b>139.2 M4</b>
Grid 4 <b>116.4 M4</b>	Grid 5 <b>138.8 M4</b>	Grid 6 <b>138.7 M4</b>
Grid 7 <b>112.1 M4</b>	Grid 8 <b>134.0 M4</b>	Grid 9 <b>133.2 M4</b>

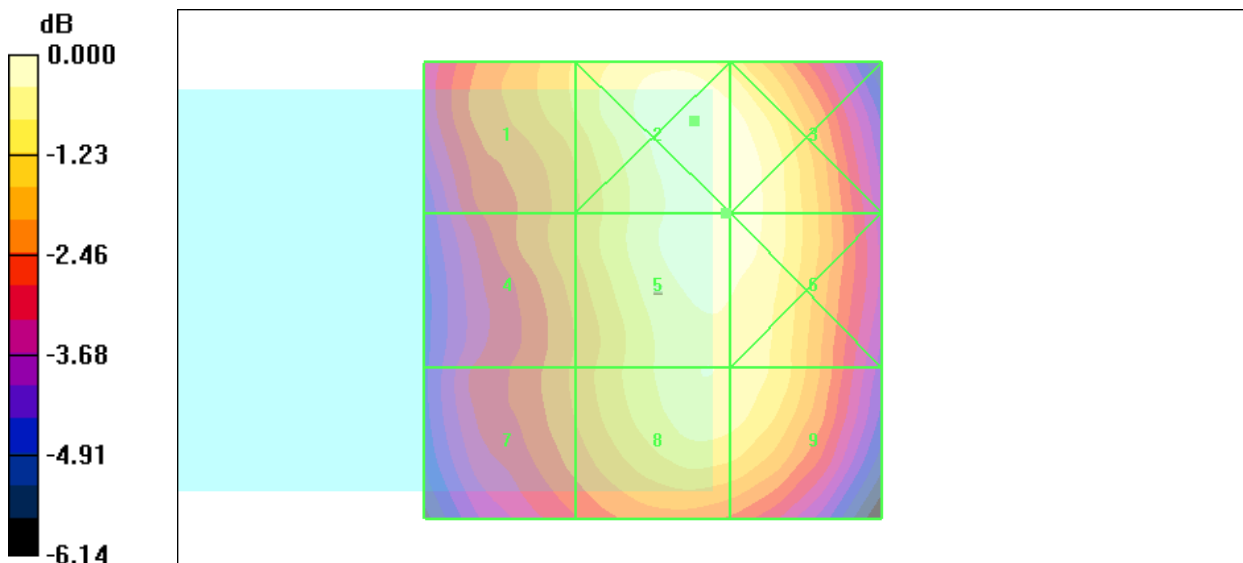

0 dB = 140.3V/m



Test Laboratory: Sporton International Inc. SAR/HAC Testing Lab

Date: 2008/12/22

HAC\_E\_GSM850 Ch189\_Slide Off

DUT: 8D1718

Communication System: GSM850; Frequency: 836.4 MHz; Duty Cycle: 1:8.3
Medium: Air Medium parameters used: sigma = 0 mho/m, epsilon\_r = 1; rho = 1000 kg/m^3
Ambient Temperature : 22.8 C

DASY4 Configuration:

- Probe: ER3DV6 - SN2358; ConvF(1, 1, 1); Calibrated: 2008/1/28
- Sensor-Surface: (Fix Surface)
- Electronics: DAE3 Sn577; Calibrated: 2008/11/12
- Phantom: HAC Test Arch 4.6; Type: SD HAC P01 BA;
- Measurement SW: DASY4, V4.7 Build 71; Postprocessing SW: SEMCAD, V1.8 Build 184

Ch189/Hearing Aid Compatibility Test (101x101x1): Measurement grid: dx=5mm, dy=5mm

Maximum value of peak Total field = 182.2 V/m

Probe Modulation Factor = 2.64

Device Reference Point: 0.000, 0.000, 353.7 mm

Reference Value = 74.9 V/m; Power Drift = -0.050 dB

Test Arch Compensation is Applied.

Hearing Aid Near-Field Category: M3 (AWF -5 dB)

Peak E-field in V/m

Table with 3 columns (Grid 1-3, Grid 4-6, Grid 7-9) and 3 rows of peak E-field values in V/m.

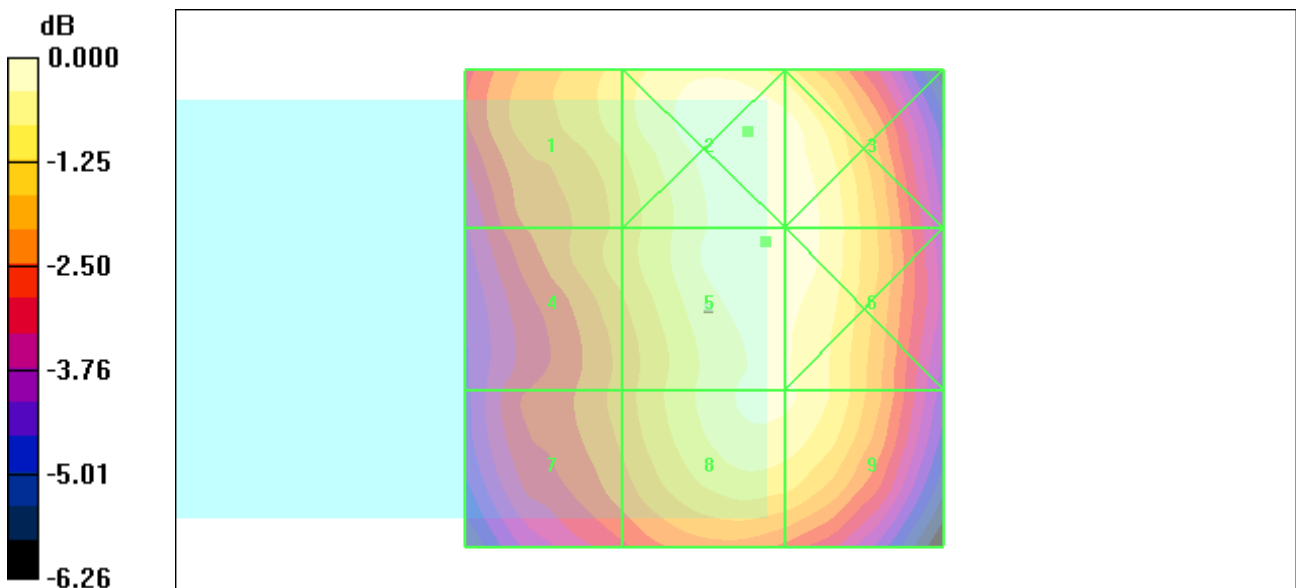

0 dB = 183.4V/m



Test Laboratory: Sporton International Inc. SAR/HAC Testing Lab

Date: 2008/12/22

HAC\_E\_GSM850 Ch251\_Slide Off

DUT: 8D1718

Communication System: GSM850; Frequency: 848.8 MHz; Duty Cycle: 1:8.3
Medium: Air Medium parameters used: sigma = 0 mho/m, epsilon\_r = 1; rho = 1000 kg/m^3
Ambient Temperature : 22.8 C

DASY4 Configuration:

- Probe: ER3DV6 - SN2358; ConvF(1, 1, 1); Calibrated: 2008/1/28
- Sensor-Surface: (Fix Surface)
- Electronics: DAE3 Sn577; Calibrated: 2008/11/12
- Phantom: HAC Test Arch 4.6; Type: SD HAC P01 BA;
- Measurement SW: DASY4, V4.7 Build 71; Postprocessing SW: SEMCAD, V1.8 Build 184

Ch251/Hearing Aid Compatibility Test (101x101x1): Measurement grid: dx=5mm, dy=5mm

Maximum value of peak Total field = 190.5 V/m

Probe Modulation Factor = 2.64

Device Reference Point: 0.000, 0.000, 353.7 mm

Reference Value = 82.0 V/m; Power Drift = -0.611 dB

Test Arch Compensation is Applied.

Hearing Aid Near-Field Category: M3 (AWF -5 dB)

Peak E-field in V/m

Table with 3 columns (Grid 1-3, Grid 4-6, Grid 7-9) and 3 rows of peak E-field values in M3.

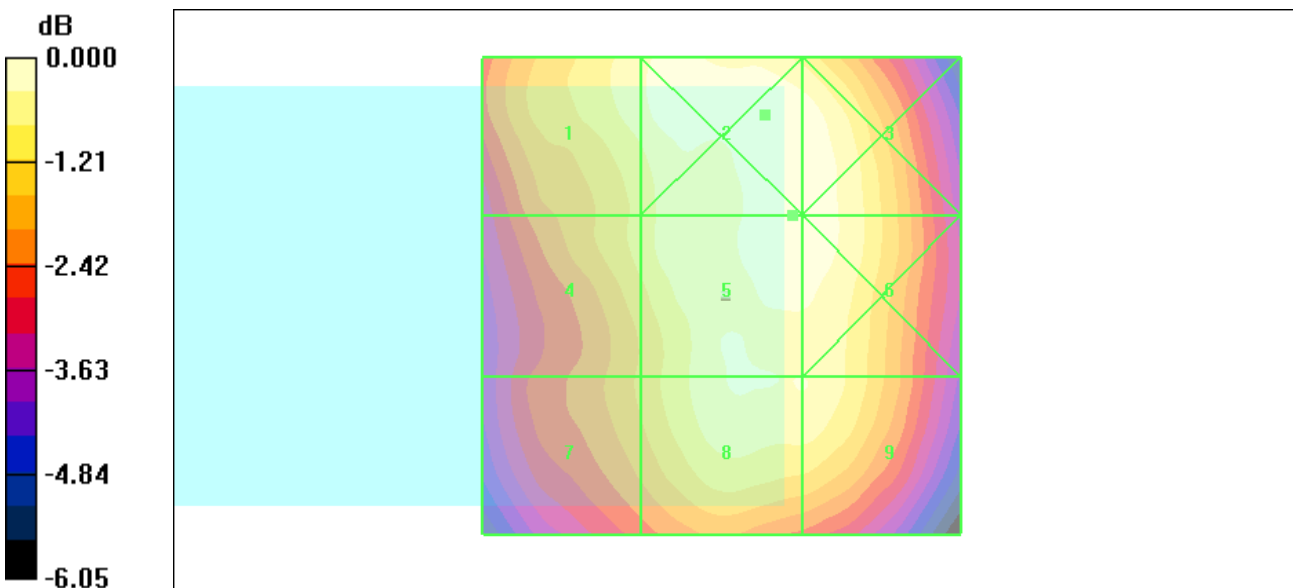

0 dB = 192.5V/m



Test Laboratory: Sporton International Inc. SAR/HAC Testing Lab

Date: 2008/12/22

HAC\_E\_GSM1900 Ch512\_Slide Off

DUT: 8D1718

Communication System: PCS; Frequency: 1850.2 MHz; Duty Cycle: 1:8.3
Medium: Air Medium parameters used: sigma = 0 mho/m, epsilon\_r = 1; rho = 1000 kg/m^3
Ambient Temperature : 22.8

DASY4 Configuration:

- Probe: ER3DV6 - SN2358; ConvF(1, 1, 1); Calibrated: 2008/1/28
- Sensor-Surface: (Fix Surface)
- Electronics: DAE3 Sn577; Calibrated: 2008/11/12
- Phantom: HAC Test Arch 4.6; Type: SD HAC P01 BA;
- Measurement SW: DASY4, V4.7 Build 71; Postprocessing SW: SEMCAD, V1.8 Build 184

Ch512/Hearing Aid Compatibility Test (101x101x1): Measurement grid: dx=5mm, dy=5mm

Maximum value of peak Total field = 70.8 V/m

Probe Modulation Factor = 2.67

Device Reference Point: 0.000, 0.000, 353.7 mm

Reference Value = 14.7 V/m; Power Drift = -0.129 dB

Test Arch Compensation is Applied.

Hearing Aid Near-Field Category: M3 (AWF -5 dB)

Peak E-field in V/m

Table with 3 columns (Grid 1-3, Grid 4-6, Grid 7-9) and 3 rows of peak E-field values in V/m, including categories like M3 and M4.

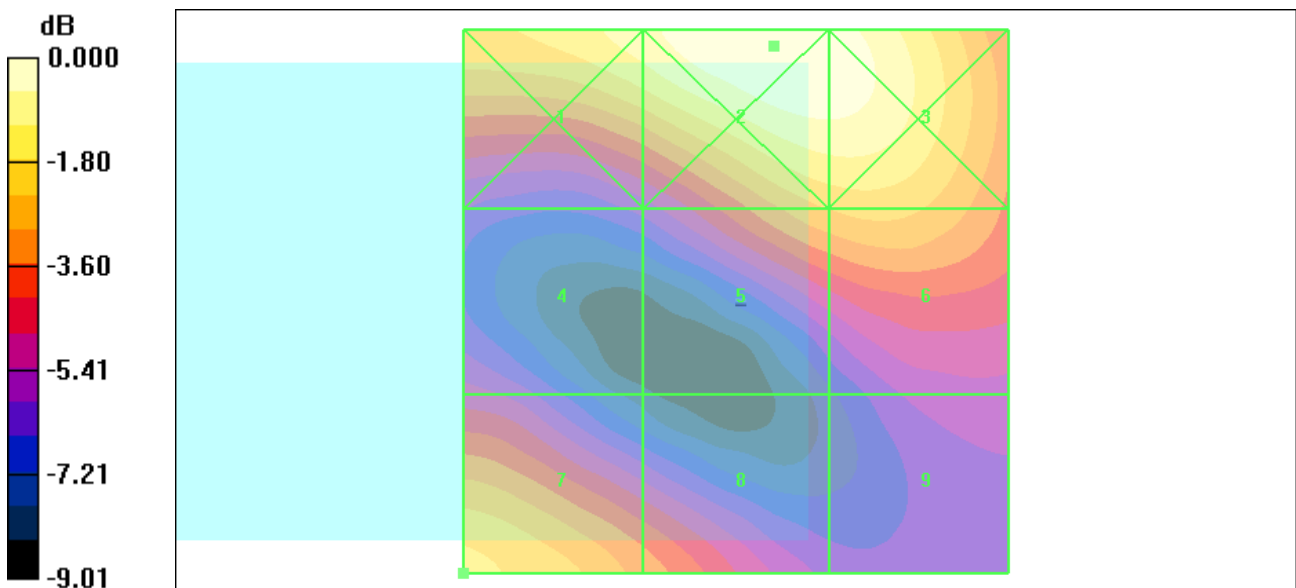

0 dB = 84.6V/m



Test Laboratory: Sporton International Inc. SAR/HAC Testing Lab

Date: 2008/12/22

HAC\_E\_GSM1900 Ch661\_Slide Off

DUT: 8D1718

Communication System: PCS; Frequency: 1880 MHz;Duty Cycle: 1:8.3
Medium: Air Medium parameters used: sigma = 0 mho/m, epsilon\_r = 1; rho = 1000 kg/m^3
Ambient Temperature : 22.8

DASY4 Configuration:

- Probe: ER3DV6 - SN2358; ConvF(1, 1, 1); Calibrated: 2008/1/28
- Sensor-Surface: (Fix Surface)
- Electronics: DAE3 Sn577; Calibrated: 2008/11/12
- Phantom: HAC Test Arch 4.6; Type: SD HAC P01 BA;
- Measurement SW: DASY4, V4.7 Build 71; Postprocessing SW: SEMCAD, V1.8 Build 184

Ch661/Hearing Aid Compatibility Test (101x101x1): Measurement grid: dx=5mm, dy=5mm

Maximum value of peak Total field = 75.7 V/m

Probe Modulation Factor = 2.67

Device Reference Point: 0.000, 0.000, 353.7 mm

Reference Value = 15.2 V/m; Power Drift = -0.068 dB

Test Arch Compensation is Applied.

Hearing Aid Near-Field Category: M3 (AWF -5 dB)

Peak E-field in V/m

Table with 3 columns (Grid 1-3, Grid 4-6, Grid 7-9) and 3 rows of peak E-field values in V/m.

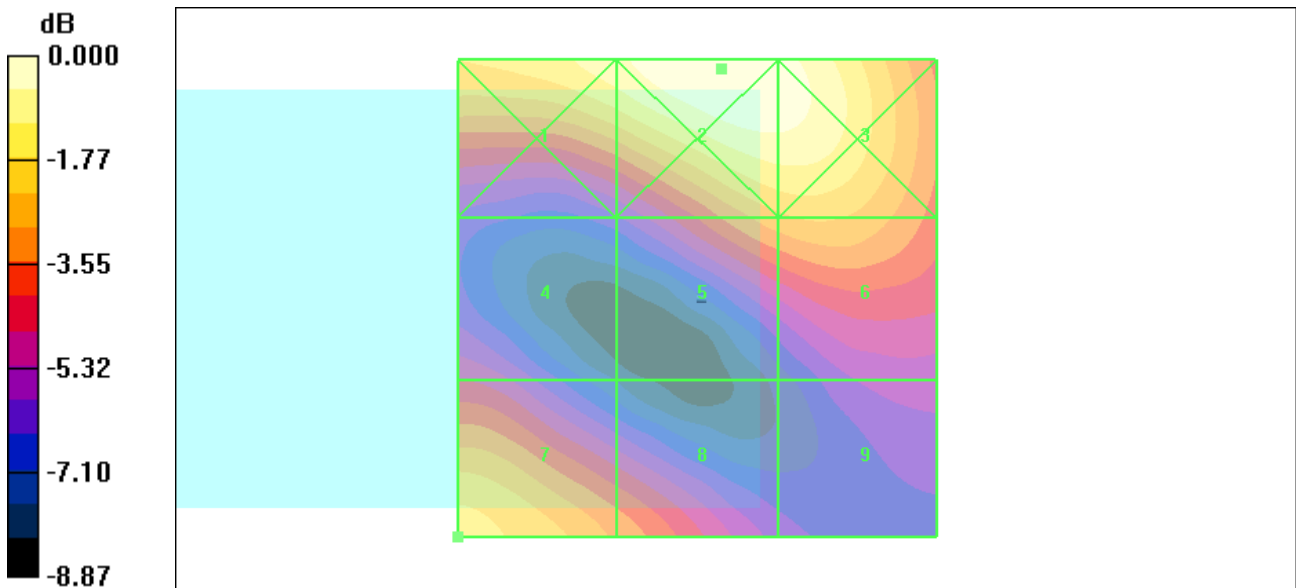

0 dB = 89.7V/m





Test Laboratory: Sporton International Inc. SAR/HAC Testing Lab

Date: 2008/12/22

HAC\_E\_GSM1900 Ch810\_Slide Off

DUT: 8D1718

Communication System: PCS; Frequency: 1909.8 MHz; Duty Cycle: 1:8.3
Medium: Air Medium parameters used: sigma = 0 mho/m, epsilon\_r = 1; rho = 1000 kg/m^3
Ambient Temperature : 22.8

DASY4 Configuration:

- Probe: ER3DV6 - SN2358; ConvF(1, 1, 1); Calibrated: 2008/1/28
- Sensor-Surface: (Fix Surface)
- Electronics: DAE3 Sn577; Calibrated: 2008/11/12
- Phantom: HAC Test Arch 4.6; Type: SD HAC P01 BA;
- Measurement SW: DASY4, V4.7 Build 71; Postprocessing SW: SEMCAD, V1.8 Build 184

Ch810/Hearing Aid Compatibility Test (101x101x1): Measurement grid: dx=5mm, dy=5mm

Maximum value of peak Total field = 75.0 V/m

Probe Modulation Factor = 2.67

Device Reference Point: 0.000, 0.000, 353.7 mm

Reference Value = 13.8 V/m; Power Drift = -0.108 dB

Test Arch Compensation is Applied.

Hearing Aid Near-Field Category: M3 (AWF -5 dB)

Peak E-field in V/m

Table with 3 columns (Grid 1-3, Grid 4-6, Grid 7-9) and 3 rows of peak E-field values in V/m.

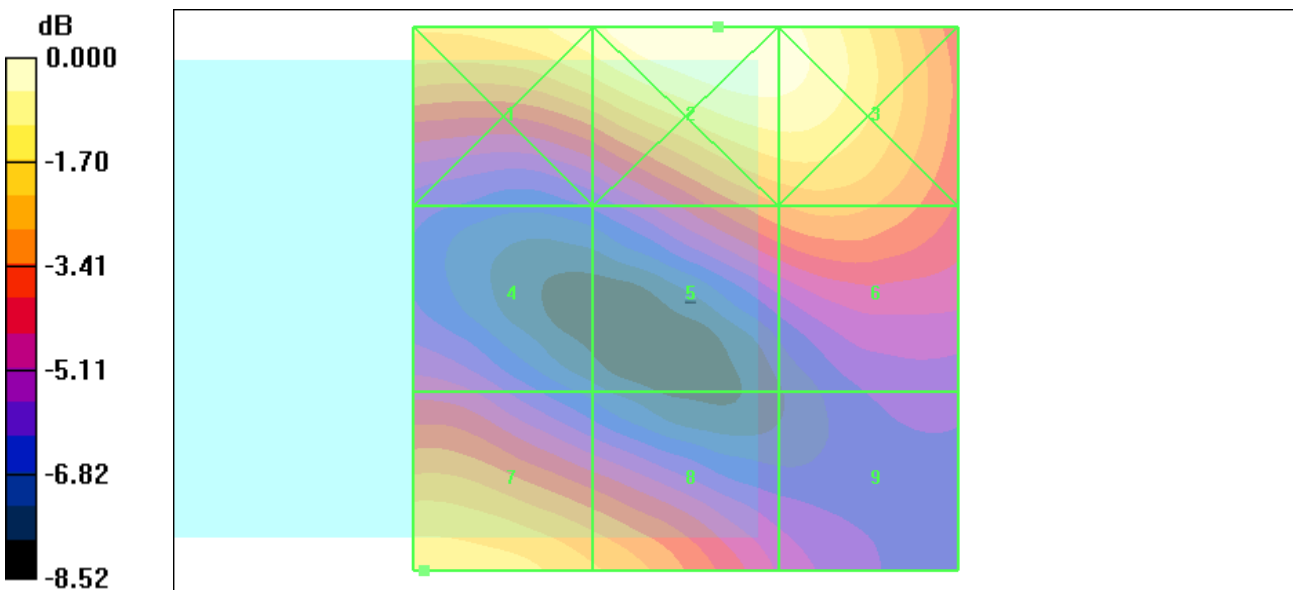

0 dB = 87.9V/m



Test Laboratory: Sporton International Inc. SAR/HAC Testing Lab

Date: 2008/12/27

HAC\_E\_WCDMA850 Ch4132\_Slide Off

DUT: 8D1718

Communication System: WCDMA; Frequency: 826.4 MHz; Duty Cycle: 1:1
Medium: Air Medium parameters used: sigma = 0 mho/m, epsilon\_r = 1; rho = 1000 kg/m^3
Ambient Temperature : 22.7

DASY4 Configuration:

- Probe: ER3DV6 - SN2358; ConvF(1, 1, 1); Calibrated: 2008/1/28
- Sensor-Surface: (Fix Surface)
- Electronics: DAE3 Sn577; Calibrated: 2008/11/12
- Phantom: HAC Test Arch 4.6; Type: SD HAC P01 BA
- Measurement SW: DASY4, V4.7 Build 71; Postprocessing SW: SEMCAD, V1.8 Build 184

Ch4132/Hearing Aid Compatibility Test (101x101x1): Measurement grid: dx=5mm, dy=5mm

Maximum value of peak Total field = 56.0 V/m

Probe Modulation Factor = 0.981

Device Reference Point: 0.000, 0.000, 353.7 mm

Reference Value = 60.8 V/m; Power Drift = -0.024 dB

Test Arch Compensation is Applied.

Hearing Aid Near-Field Category: M4 (AWF 0 dB)

Peak E-field in V/m

Table with 3 columns (Grid 1-3, Grid 4-6, Grid 7-9) and 3 rows of peak E-field values in M4.

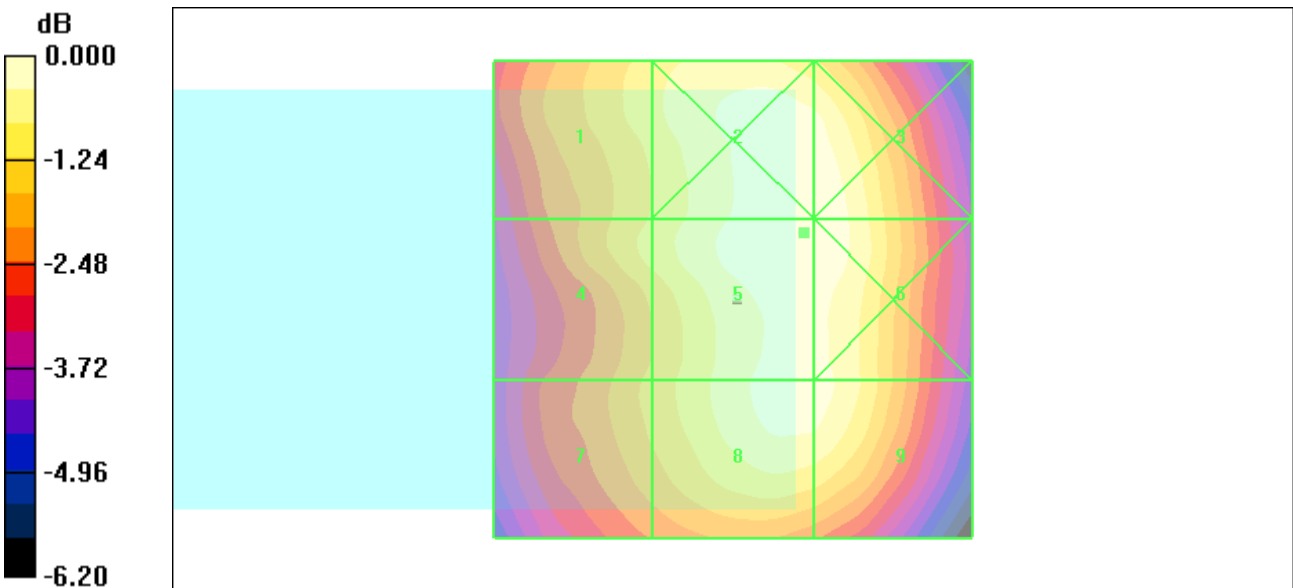

0 dB = 56.0V/m



Test Laboratory: Sporton International Inc. SAR/HAC Testing Lab

Date: 2008/12/27

HAC\_E\_WCDMA850 Ch4182\_Slide Off

DUT: 8D1718

Communication System: WCDMA; Frequency: 836.4 MHz; Duty Cycle: 1:1
Medium: Air Medium parameters used: sigma = 0 mho/m, epsilon\_r = 1; rho = 1000 kg/m^3
Ambient Temperature : 22.5

DASY4 Configuration:

- Probe: ER3DV6 - SN2358; ConvF(1, 1, 1); Calibrated: 2008/1/28
- Sensor-Surface: (Fix Surface)
- Electronics: DAE3 Sn577; Calibrated: 2008/11/12
- Phantom: HAC Test Arch 4.6; Type: SD HAC P01 BA
- Measurement SW: DASY4, V4.7 Build 71; Postprocessing SW: SEMCAD, V1.8 Build 184

Ch4182/Hearing Aid Compatibility Test (101x101x1): Measurement grid: dx=5mm, dy=5mm

Maximum value of peak Total field = 59.4 V/m

Probe Modulation Factor = 0.981

Device Reference Point: 0.000, 0.000, 353.7 mm

Reference Value = 63.7 V/m; Power Drift = -0.011 dB

Test Arch Compensation is Applied.

Hearing Aid Near-Field Category: M4 (AWF 0 dB)

Peak E-field in V/m

Table with 3 columns (Grid 1-3, Grid 4-6, Grid 7-9) and 3 rows of peak E-field values in M4.

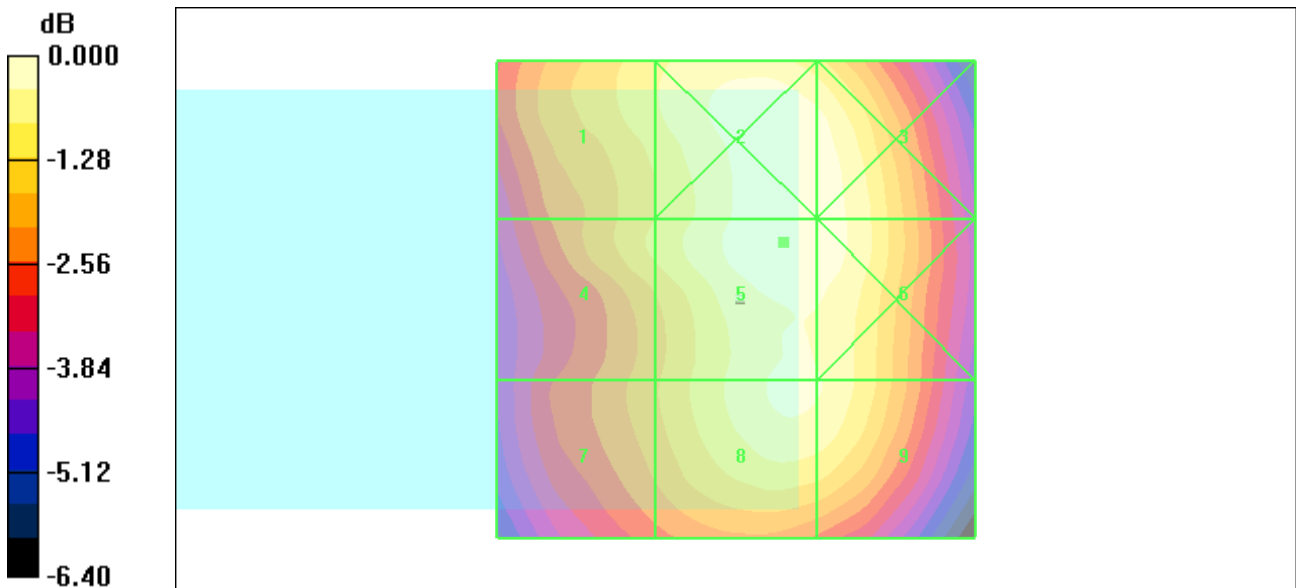

0 dB = 59.4V/m



Test Laboratory: Sporton International Inc. SAR/HAC Testing Lab

Date: 2008/12/27

HAC\_E\_WCDMA850 Ch4233\_Slide Off

DUT: 8D1718

Communication System: WCDMA; Frequency: 846.6 MHz; Duty Cycle: 1:1
Medium: Air Medium parameters used: sigma = 0 mho/m, epsilon\_r = 1; rho = 1000 kg/m^3
Ambient Temperature : 22.6

DASY4 Configuration:

- Probe: ER3DV6 - SN2358; ConvF(1, 1, 1); Calibrated: 2008/1/28
- Sensor-Surface: (Fix Surface)
- Electronics: DAE3 Sn577; Calibrated: 2008/11/12
- Phantom: HAC Test Arch 4.6; Type: SD HAC P01 BA
- Measurement SW: DASY4, V4.7 Build 71; Postprocessing SW: SEMCAD, V1.8 Build 184

Ch4233/Hearing Aid Compatibility Test (101x101x1): Measurement grid: dx=5mm, dy=5mm

Maximum value of peak Total field = 62.9 V/m

Probe Modulation Factor = 0.981

Device Reference Point: 0.000, 0.000, 353.7 mm

Reference Value = 67.0 V/m; Power Drift = 0.018 dB

Test Arch Compensation is Applied.

Hearing Aid Near-Field Category: M4 (AWF 0 dB)

Peak E-field in V/m

Table with 3 columns (Grid 1-3, Grid 4-6, Grid 7-9) and 3 rows of peak E-field values in M4.

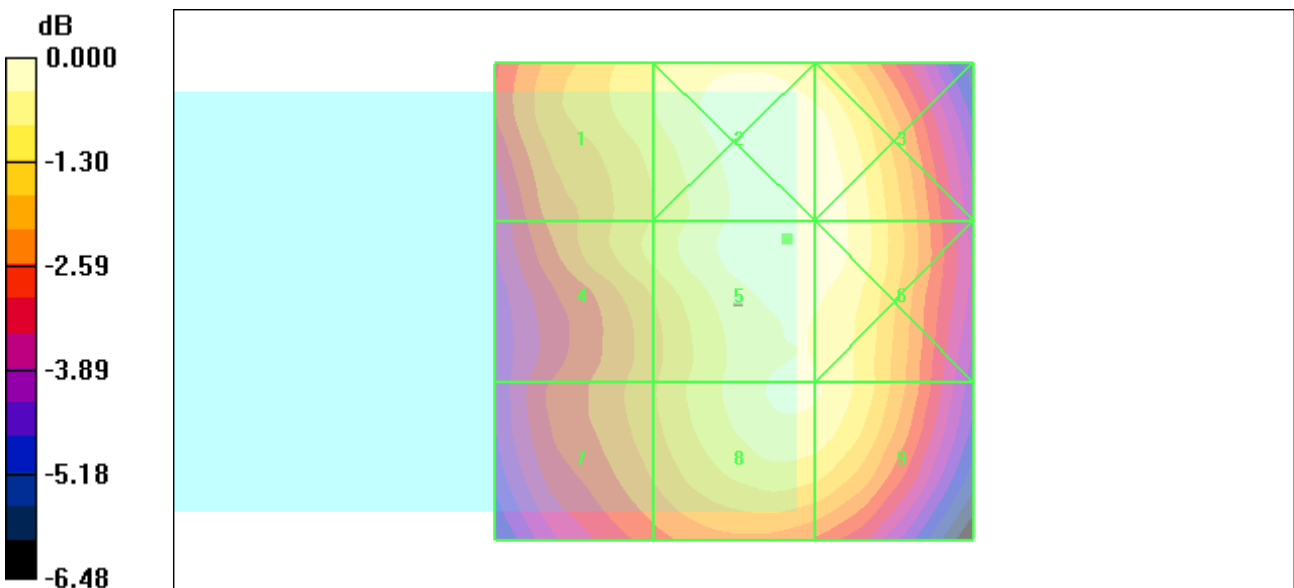

0 dB = 62.9V/m



Test Laboratory: Sporton International Inc. SAR/HAC Testing Lab

Date: 2008/12/27

HAC\_E\_WCDMA1900 Ch9262\_Slide Off

DUT: 8D1718

Communication System: WCDMA; Frequency: 1852.4 MHz; Duty Cycle: 1:1
Medium: Air Medium parameters used: sigma = 0 mho/m, epsilon\_r = 1; rho = 1000 kg/m^3
Ambient Temperature : 22.6

DASY4 Configuration:

- Probe: ER3DV6 - SN2358; ConvF(1, 1, 1); Calibrated: 2008/1/28
- Sensor-Surface: (Fix Surface)
- Electronics: DAE3 Sn577; Calibrated: 2008/11/12
- Phantom: HAC Test Arch 4.6; Type: SD HAC P01 BA
- Measurement SW: DASY4, V4.7 Build 71; Postprocessing SW: SEMCAD, V1.8 Build 184

Ch9262/Hearing Aid Compatibility Test (101x101x1): Measurement grid: dx=5mm, dy=5mm

Maximum value of peak Total field = 30.4 V/m

Probe Modulation Factor = 1.05

Device Reference Point: 0.000, 0.000, 353.7 mm

Reference Value = 17.3 V/m; Power Drift = 0.166 dB

Test Arch Compensation is Applied.

Hearing Aid Near-Field Category: M4 (AWF 0 dB)

Peak E-field in V/m

Table with 3 columns (Grid 1-3, Grid 4-6, Grid 7-9) and 3 rows of peak E-field values in M4.

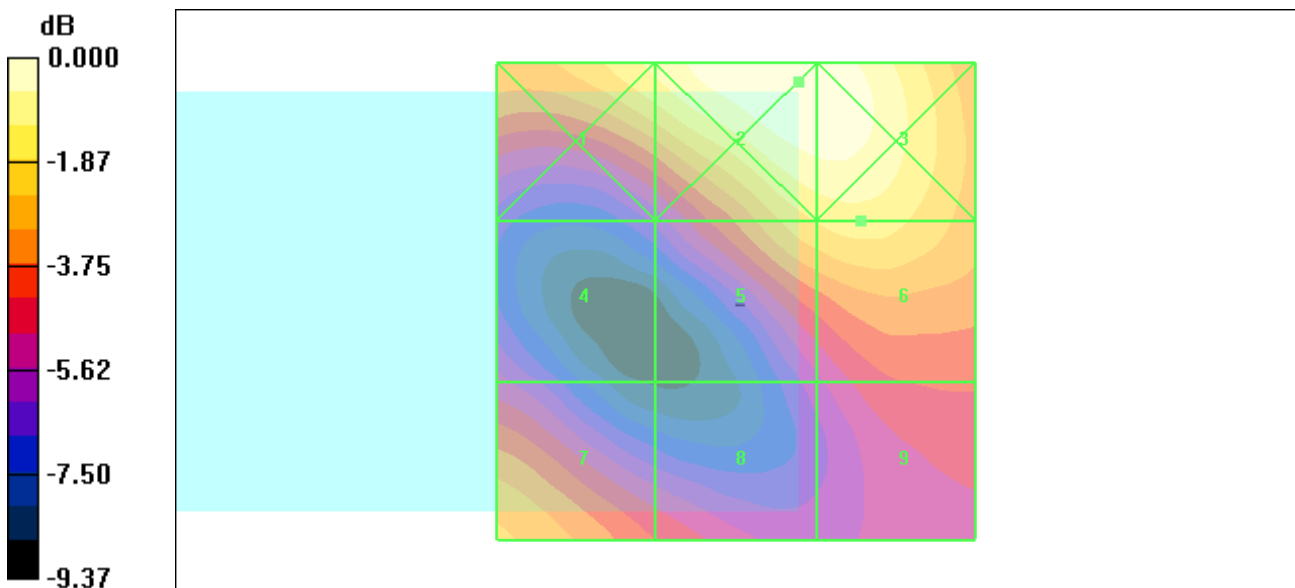

0 dB = 36.3V/m



Test Laboratory: Sporton International Inc. SAR/HAC Testing Lab

Date: 2008/12/27

HAC\_E\_WCDMA1900 Ch9400\_Slide Off

DUT: 8D1718

Communication System: WCDMA; Frequency: 1880 MHz; Duty Cycle: 1:1
Medium: Air Medium parameters used: sigma = 0 mho/m, epsilon\_r = 1; rho = 1000 kg/m^3
Ambient Temperature : 22.6

DASY4 Configuration:

- Probe: ER3DV6 - SN2358; ConvF(1, 1, 1); Calibrated: 2008/1/28
- Sensor-Surface: (Fix Surface)
- Electronics: DAE3 Sn577; Calibrated: 2008/11/12
- Phantom: HAC Test Arch 4.6; Type: SD HAC P01 BA
- Measurement SW: DASY4, V4.7 Build 71; Postprocessing SW: SEMCAD, V1.8 Build 184

Ch9400/Hearing Aid Compatibility Test (101x101x1): Measurement grid: dx=5mm, dy=5mm

Maximum value of peak Total field = 29.7 V/m

Probe Modulation Factor = 1.05

Device Reference Point: 0.000, 0.000, 353.7 mm

Reference Value = 15.6 V/m; Power Drift = -0.009 dB

Test Arch Compensation is Applied.

Hearing Aid Near-Field Category: M4 (AWF 0 dB)

Peak E-field in V/m

Table with 3 columns (Grid 1-3, Grid 4-6, Grid 7-9) and 3 rows of peak E-field values in M4.

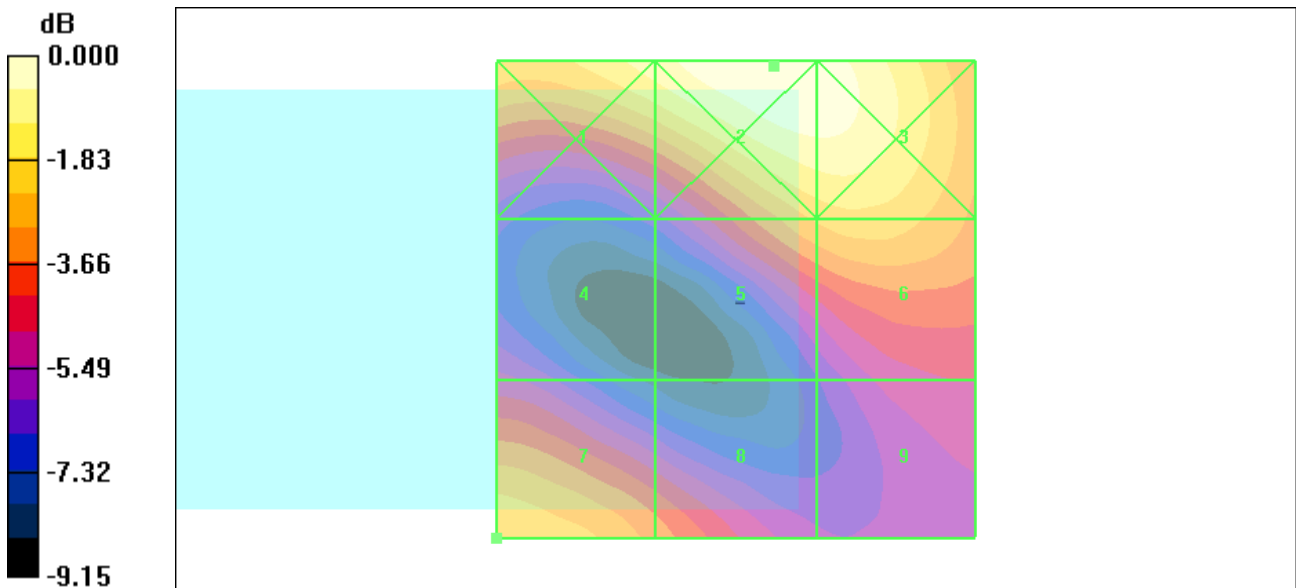

0 dB = 37.0V/m



Test Laboratory: Sporton International Inc. SAR/HAC Testing Lab

Date: 2008/12/27

HAC\_E\_WCDMA1900 Ch9538\_Slide Off

DUT: 8D1718

Communication System: WCDMA; Frequency: 1907.6 MHz; Duty Cycle: 1:1
Medium: Air Medium parameters used: sigma = 0 mho/m, epsilon\_r = 1; rho = 1000 kg/m^3
Ambient Temperature : 22.7

DASY4 Configuration:

- Probe: ER3DV6 - SN2358; ConvF(1, 1, 1); Calibrated: 2008/1/28
- Sensor-Surface: (Fix Surface)
- Electronics: DAE3 Sn577; Calibrated: 2008/11/12
- Phantom: HAC Test Arch 4.6; Type: SD HAC P01 BA
- Measurement SW: DASY4, V4.7 Build 71; Postprocessing SW: SEMCAD, V1.8 Build 184

Ch9538/Hearing Aid Compatibility Test (101x101x1): Measurement grid: dx=5mm, dy=5mm
Maximum value of peak Total field = 27.3 V/m
Probe Modulation Factor = 1.05
Device Reference Point: 0.000, 0.000, 353.7 mm
Reference Value = 15.5 V/m; Power Drift = -0.268 dB
Test Arch Compensation is Applied.
Hearing Aid Near-Field Category: M4 (AWF 0 dB)

Peak E-field in V/m

Table with 3 columns (Grid 1-3, Grid 4-6, Grid 7-9) and 3 rows of peak E-field values in M4.

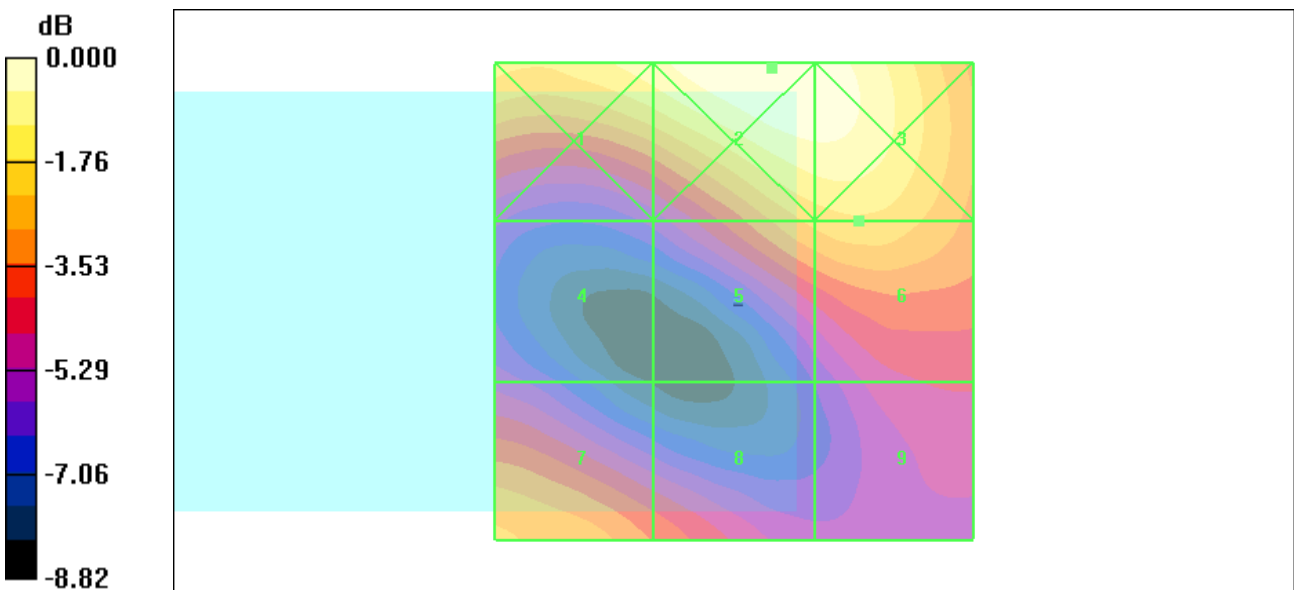

0 dB = 33.8V/m



Test Laboratory: Sporton International Inc. SAR/HAC Testing Lab

Date: 2009/1/16

HAC\_E\_GSM850 Ch128\_Slide Right

DUT: 8D1718

Communication System: GSM850; Frequency: 824.2 MHz; Duty Cycle: 1:8.3
Medium: Air Medium parameters used: sigma = 0 mho/m, epsilon\_r = 1; rho = 1000 kg/m^3
Ambient Temperature : 22.6

DASY5 Configuration:

- Probe: ER3DV6 - SN2358; ConvF(1, 1, 1); Calibrated: 2008/1/28
- Sensor-Surface: (Fix Surface)
- Electronics: DAE4 Sn778; Calibrated: 2008/9/22
- Phantom: HAC Test Arch 4.6; Type: SD HAC P01 BA;
- Measurement SW: DASY5, V5.0 Build 120; SEMCAD X Version 13.2 Build 87

Ch128/Hearing Aid Compatibility Test (101x101x1): Measurement grid: dx=5mm, dy=5mm

Maximum value of peak Total field = 132.2 V/m

Probe Modulation Factor = 2.64

Device Reference Point: 0, 0, 353.7 mm

Reference Value = 53.8 V/m; Power Drift = -0.252 dB

Test Arch Compensation is Applied.

Hearing Aid Near-Field Category: M4 (AWF -5 dB)

Peak E-field in V/m

Table with 3 columns (Grid 1-3) and 3 rows (Grid 4-6) showing peak E-field values in V/m. Grid 5 has the highest value of 132.2 M4.

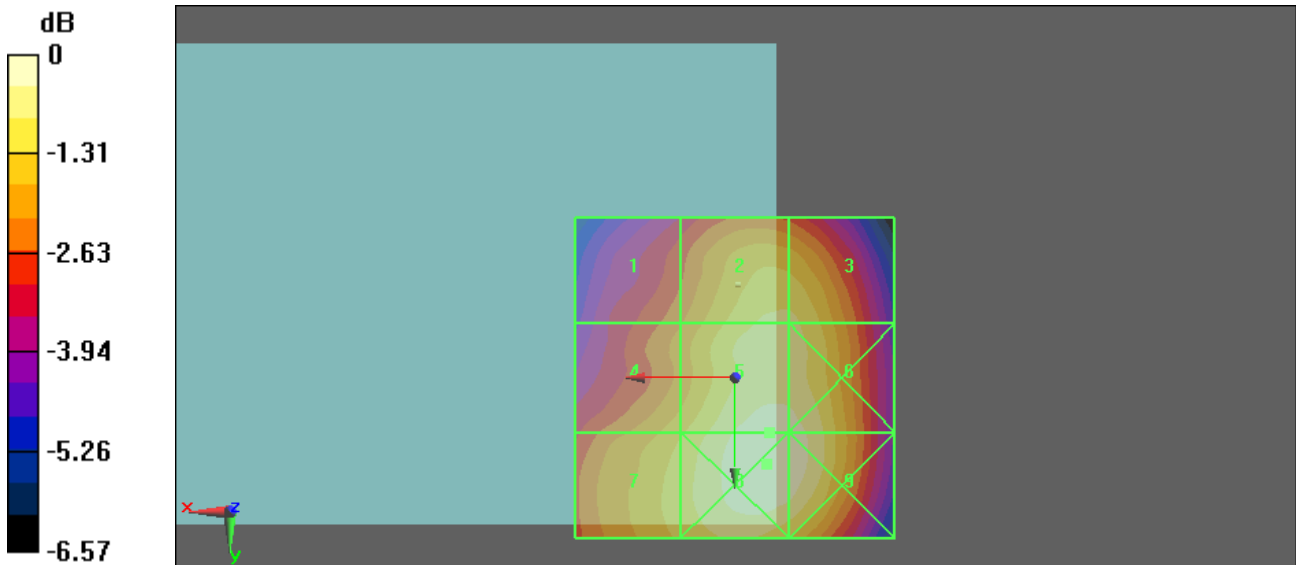

0 dB = 134.3V/m





Test Laboratory: Sporton International Inc. SAR/HAC Testing Lab

Date: 2009/1/17

HAC\_E\_GSM850 Ch189\_Slide Right

DUT: 8D1718

Communication System: GSM850; Frequency: 836.4 MHz; Duty Cycle: 1:8.3
Medium: Air Medium parameters used: sigma = 0 mho/m, epsilon\_r = 1; rho = 1000 kg/m^3
Ambient Temperature : 22.5

DASY5 Configuration:

- Probe: ER3DV6 - SN2358; ConvF(1, 1, 1); Calibrated: 2008/1/28
- Sensor-Surface: (Fix Surface)
- Electronics: DAE4 Sn778; Calibrated: 2008/9/22
- Phantom: HAC Test Arch 4.6; Type: SD HAC P01 BA;
- Measurement SW: DASY5, V5.0 Build 120; SEMCAD X Version 13.2 Build 87

Ch189/Hearing Aid Compatibility Test (101x101x1): Measurement grid: dx=5mm, dy=5mm

Maximum value of peak Total field = 161.2 V/m

Probe Modulation Factor = 2.64

Device Reference Point: 0, 0, 353.7 mm

Reference Value = 64 V/m; Power Drift = -0.015 dB

Test Arch Compensation is Applied.

Hearing Aid Near-Field Category: M3 (AWF -5 dB)

Peak E-field in V/m

Table with 3 columns (Grid 1-3, Grid 4-6, Grid 7-9) and 3 rows of peak E-field values in V/m.

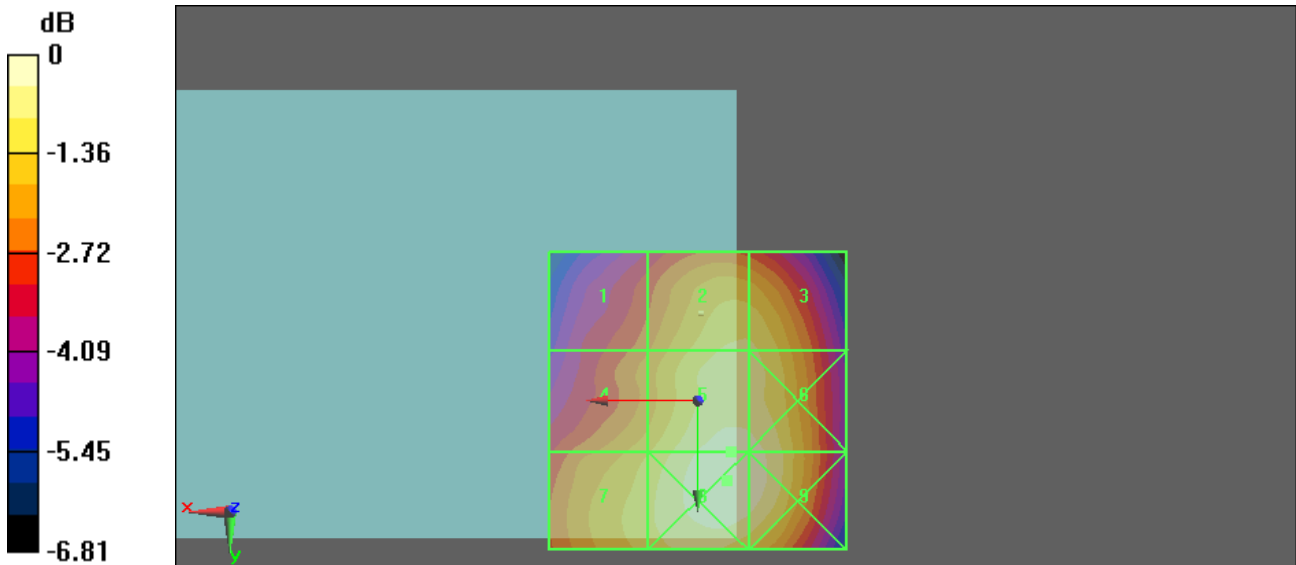

0 dB = 164.3V/m



Test Laboratory: Sporton International Inc. SAR/HAC Testing Lab

Date: 2009/1/17

HAC\_E\_GSM850 Ch251\_Slide Right

DUT: 8D1718

Communication System: GSM850; Frequency: 848.8 MHz; Duty Cycle: 1:8.3
Medium: Air Medium parameters used: sigma = 0 mho/m, epsilon\_r = 1; rho = 1000 kg/m^3
Ambient Temperature : 22.5

DASY5 Configuration:

- Probe: ER3DV6 - SN2358; ConvF(1, 1, 1); Calibrated: 2008/1/28
- Sensor-Surface: (Fix Surface)
- Electronics: DAE4 Sn778; Calibrated: 2008/9/22
- Phantom: HAC Test Arch 4.6; Type: SD HAC P01 BA;
- Measurement SW: DASY5, V5.0 Build 120; SEMCAD X Version 13.2 Build 87

Ch251/Hearing Aid Compatibility Test (101x101x1): Measurement grid: dx=5mm, dy=5mm

Maximum value of peak Total field = 196.6 V/m
Probe Modulation Factor = 2.64
Device Reference Point: 0, 0, 353.7 mm
Reference Value = 77.9 V/m; Power Drift = -0.017 dB
Test Arch Compensation is Applied.

Hearing Aid Near-Field Category: M3 (AWF -5 dB)

Peak E-field in V/m

Table with 3 columns (Grid 1-3, Grid 4-6, Grid 7-9) and 3 rows of peak E-field values in M3.

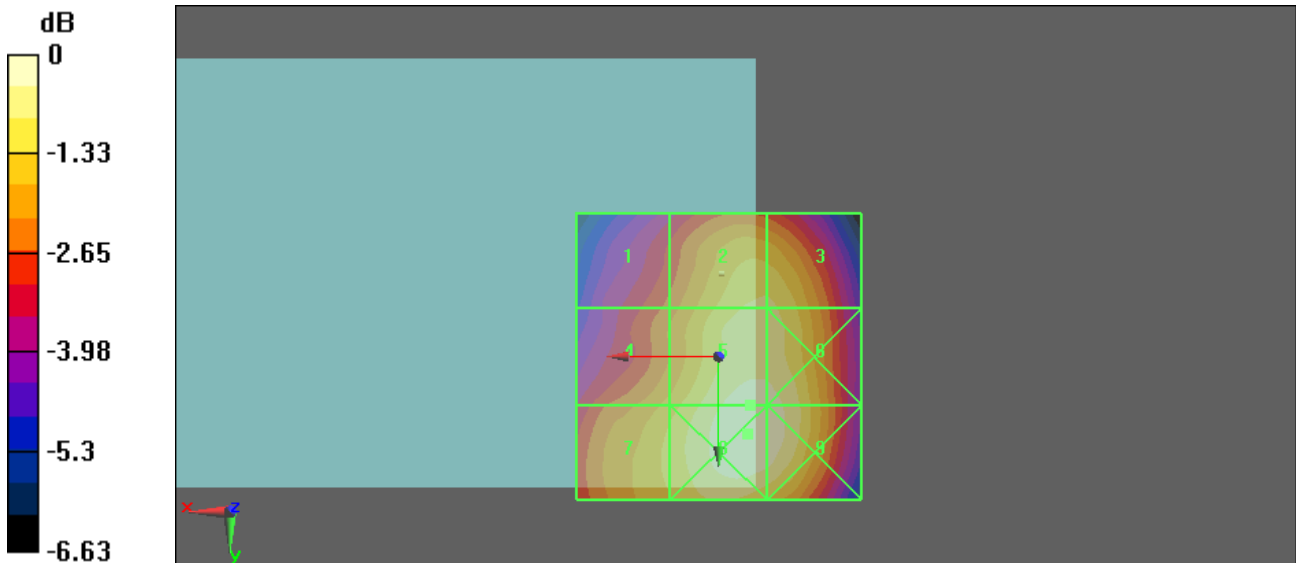

0 dB = 199.7V/m



Test Laboratory: Sporton International Inc. SAR/HAC Testing Lab

Date: 2009/1/17

HAC\_E\_GSM1900 Ch512\_Slide Right

DUT: 8D1718

Communication System: PCS; Frequency: 1850.2 MHz;Duty Cycle: 1:8.3
Medium: Air Medium parameters used: sigma = 0 mho/m, epsilon\_r = 1; rho = 1000 kg/m^3
Ambient Temperature : 22.5

DASY5 Configuration:

- Probe: ER3DV6 - SN2358; ConvF(1, 1, 1); Calibrated: 2008/1/28
- Sensor-Surface: (Fix Surface)
- Electronics: DAE4 Sn778; Calibrated: 2008/9/22
- Phantom: HAC Test Arch 4.6; Type: SD HAC P01 BA;
- Measurement SW: DASY5, V5.0 Build 120; SEMCAD X Version 13.2 Build 87

Ch512/Hearing Aid Compatibility Test (101x101x1): Measurement grid: dx=5mm, dy=5mm

Maximum value of peak Total field = 48.5 V/m

Probe Modulation Factor = 2.67

Device Reference Point: 0, 0, 353.7 mm

Reference Value = 15.6 V/m; Power Drift = -1.6 dB

Test Arch Compensation is Applied.

Hearing Aid Near-Field Category: M3 (AWF -5 dB)

Peak E-field in V/m

Table with 3 columns (Grid 1-3, Grid 4-6, Grid 7-9) and 3 rows of peak E-field values in V/m.

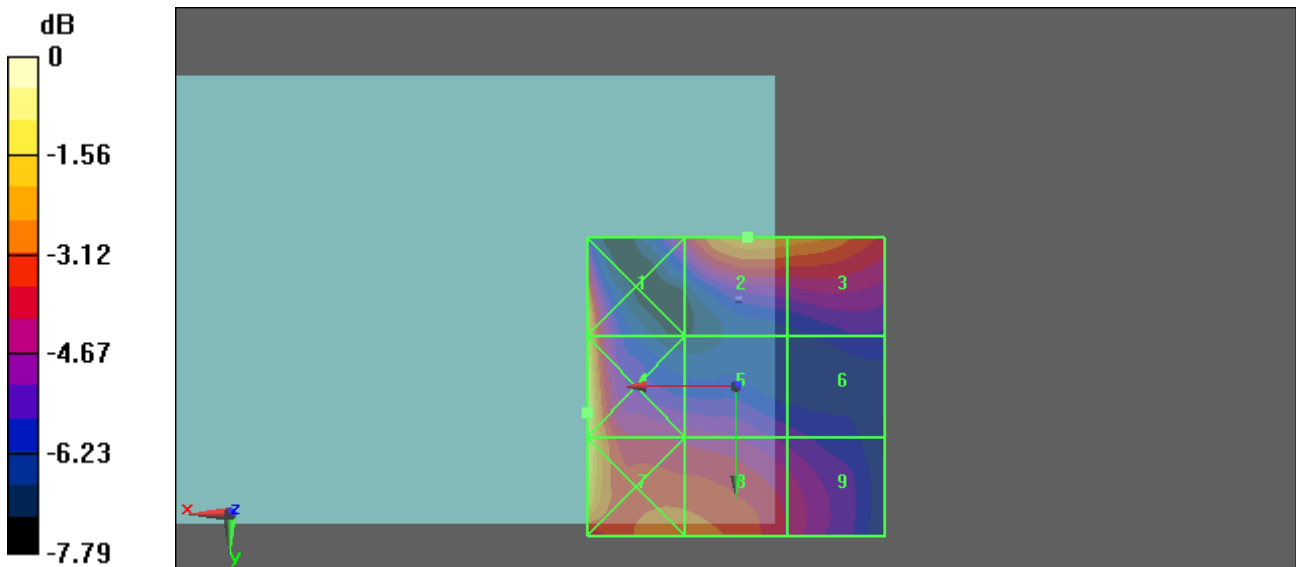

0 dB = 61.9V/m



Test Laboratory: Sporton International Inc. SAR/HAC Testing Lab

Date: 2009/1/17

HAC\_E\_GSM1900 Ch661\_Slide Right

DUT: 8D1718

Communication System: PCS; Frequency: 1880 MHz;Duty Cycle: 1:8.3
Medium: Air Medium parameters used: sigma = 0 mho/m, epsilon\_r = 1; rho = 1000 kg/m^3
Ambient Temperature : 22.5

DASY5 Configuration:

- Probe: ER3DV6 - SN2358; ConvF(1, 1, 1); Calibrated: 2008/1/28
- Sensor-Surface: (Fix Surface)
- Electronics: DAE4 Sn778; Calibrated: 2008/9/22
- Phantom: HAC Test Arch 4.6; Type: SD HAC P01 BA;
- Measurement SW: DASY5, V5.0 Build 120; SEMCAD X Version 13.2 Build 87

Ch661/Hearing Aid Compatibility Test (101x101x1): Measurement grid: dx=5mm, dy=5mm

Maximum value of peak Total field = 42.8 V/m
Probe Modulation Factor = 2.67
Device Reference Point: 0, 0, 353.7 mm
Reference Value = 13 V/m; Power Drift = -0.00773 dB
Test Arch Compensation is Applied.

Hearing Aid Near-Field Category: M4 (AWF -5 dB)

Peak E-field in V/m

Table with 3 columns (Grid 1-3, Grid 4-6, Grid 7-9) and 3 rows of peak E-field values in M4.

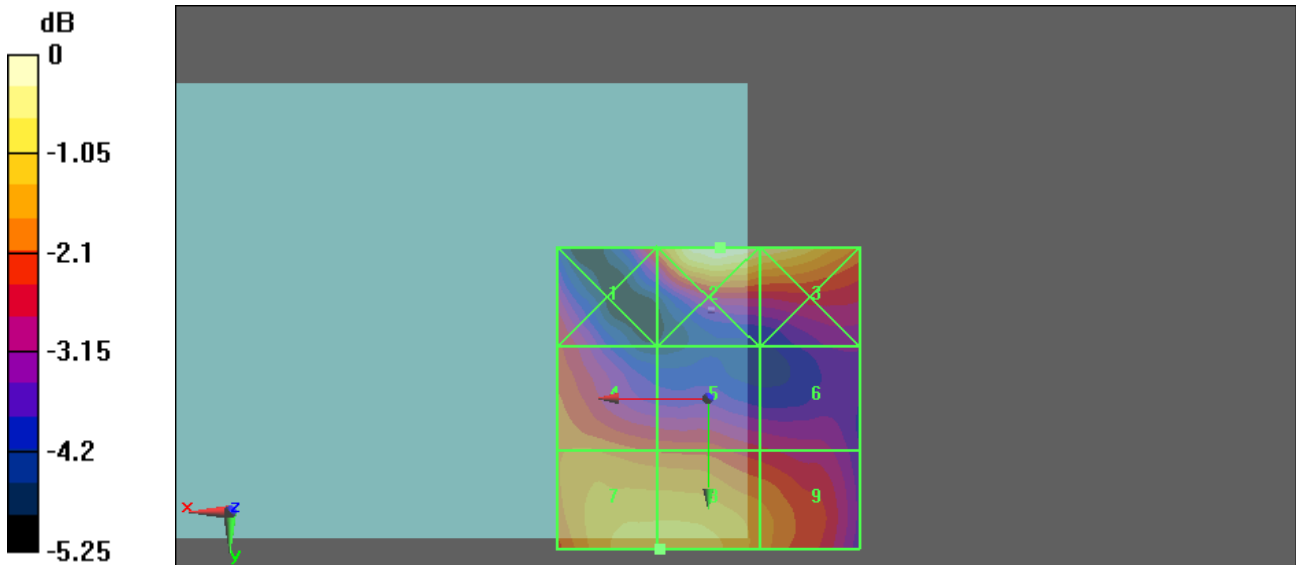

0 dB = 46.4V/m



Test Laboratory: Sporton International Inc. SAR/HAC Testing Lab

Date: 2009/1/17

HAC\_E\_GSM1900 Ch810\_Slide Right

DUT: 8D1718

Communication System: PCS; Frequency: 1909.8 MHz; Duty Cycle: 1:8.3
Medium: Air Medium parameters used: sigma = 0 mho/m, epsilon\_r = 1; rho = 1000 kg/m^3
Ambient Temperature : 22.5

DASY5 Configuration:

- Probe: ER3DV6 - SN2358; ConvF(1, 1, 1); Calibrated: 2008/1/28
- Sensor-Surface: (Fix Surface)
- Electronics: DAE4 Sn778; Calibrated: 2008/9/22
- Phantom: HAC Test Arch 4.6; Type: SD HAC P01 BA;
- Measurement SW: DASY5, V5.0 Build 120; SEMCAD X Version 13.2 Build 87

Ch810/Hearing Aid Compatibility Test (101x101x1): Measurement grid: dx=5mm, dy=5mm

Maximum value of peak Total field = 43.6 V/m

Probe Modulation Factor = 2.67

Device Reference Point: 0, 0, 353.7 mm

Reference Value = 14.2 V/m; Power Drift = 0.059 dB

Test Arch Compensation is Applied.

Hearing Aid Near-Field Category: M4 (AWF -5 dB)

Peak E-field in V/m

Table with 3 columns (Grid 1-3, Grid 4-6, Grid 7-9) and 3 rows of peak E-field values in M4.

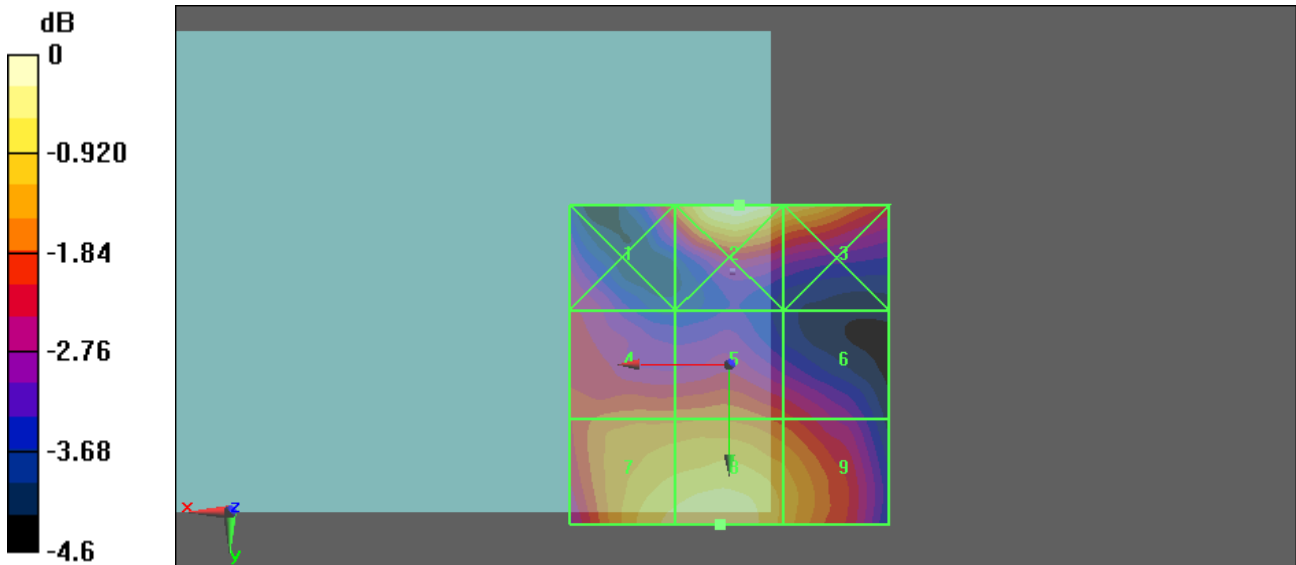

0 dB = 45.1V/m



Test Laboratory: Sporton International Inc. SAR/HAC Testing Lab

Date: 2009/1/17

HAC\_E\_WCDMA850 Ch4132\_Slide Right

DUT: 8D1718

Communication System: WCDMA; Frequency: 826.4 MHz; Duty Cycle: 1:1
Medium: Air Medium parameters used: sigma = 0 mho/m, epsilon\_r = 1; rho = 1000 kg/m^3
Ambient Temperature : 22.5

DASY5 Configuration:

- Probe: ER3DV6 - SN2358; ConvF(1, 1, 1); Calibrated: 2008/1/28
- Sensor-Surface: (Fix Surface)
- Electronics: DAE4 Sn778; Calibrated: 2008/9/22
- Phantom: HAC Test Arch 4.6; Type: SD HAC P01 BA;
- Measurement SW: DASY5, V5.0 Build 120; SEMCAD X Version 13.2 Build 87

Ch4132/Hearing Aid Compatibility Test (101x101x1): Measurement grid: dx=5mm, dy=5mm

Maximum value of peak Total field = 49.3 V/m

Probe Modulation Factor = 0.981

Device Reference Point: 0, 0, 353.7 mm

Reference Value = 53.1 V/m; Power Drift = 0.040 dB

Test Arch Compensation is Applied.

Hearing Aid Near-Field Category: M4 (AWF 0 dB)

Peak E-field in V/m

Table with 3 columns (Grid 1-3, Grid 4-6, Grid 7-9) and 3 rows of peak E-field values in V/m, ranging from 39.2 M4 to 49.8 M4.

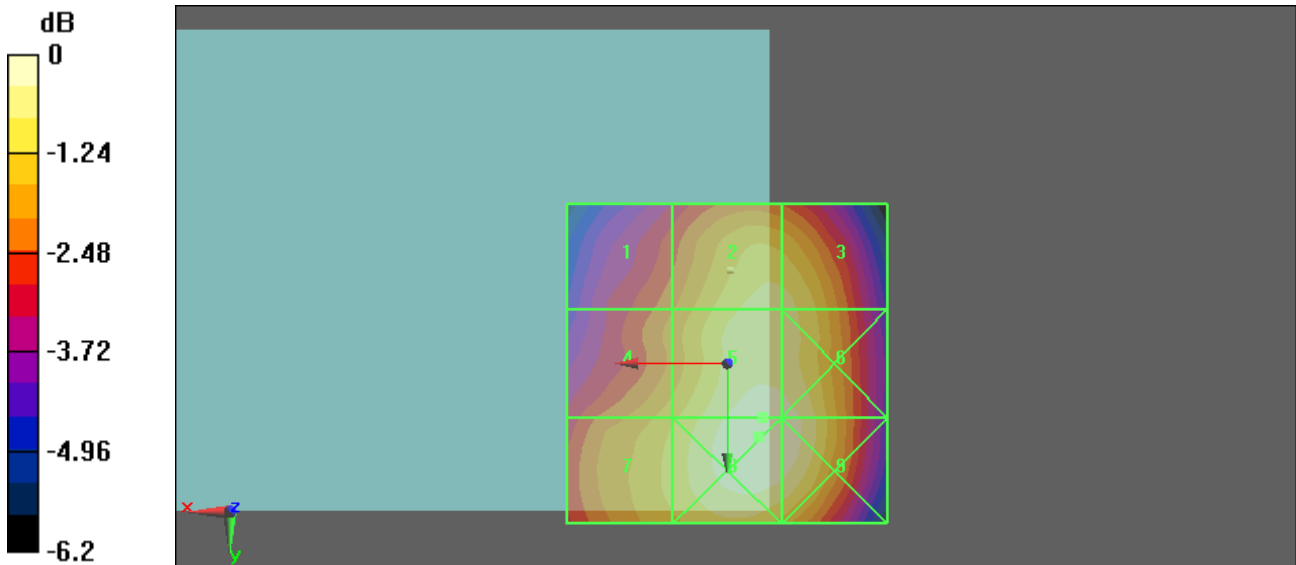

0 dB = 49.8V/m



Test Laboratory: Sporton International Inc. SAR/HAC Testing Lab

Date: 2009/1/17

HAC\_E\_WCDMA850 Ch4182\_Slide Right

DUT: 8D1718

Communication System: WCDMA; Frequency: 836.4 MHz; Duty Cycle: 1:1
Medium: Air Medium parameters used: sigma = 0 mho/m, epsilon\_r = 1; rho = 1000 kg/m^3
Ambient Temperature : 22.6

DASY5 Configuration:

- Probe: ER3DV6 - SN2358; ConvF(1, 1, 1); Calibrated: 2008/1/28
- Sensor-Surface: (Fix Surface)
- Electronics: DAE4 Sn778; Calibrated: 2008/9/22
- Phantom: HAC Test Arch 4.6; Type: SD HAC P01 BA;
- Measurement SW: DASY5, V5.0 Build 120; SEMCAD X Version 13.2 Build 87

Ch4182/Hearing Aid Compatibility Test (101x101x1): Measurement grid: dx=5mm, dy=5mm

Maximum value of peak Total field = 56.6 V/m
Probe Modulation Factor = 0.981
Device Reference Point: 0, 0, 353.7 mm
Reference Value = 60.8 V/m; Power Drift = 0.000177 dB
Test Arch Compensation is Applied.

Hearing Aid Near-Field Category: M4 (AWF 0 dB)

Peak E-field in V/m

Table with 3 columns (Grid 1-3, Grid 4-6, Grid 7-9) and 3 rows of peak E-field values in M4 units.

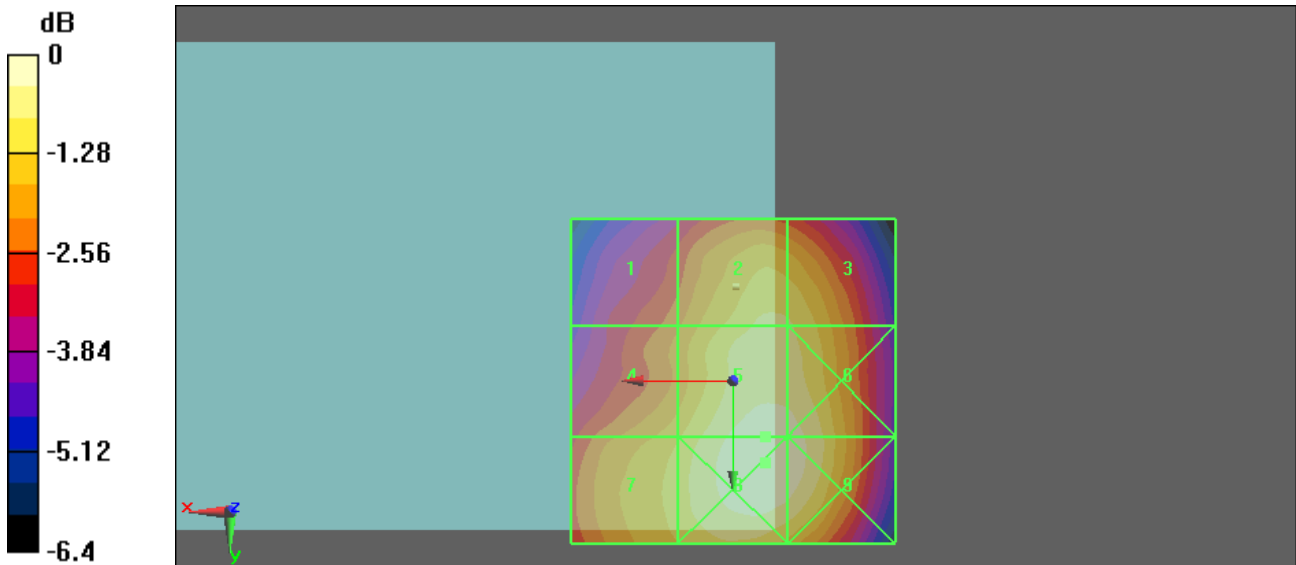

0 dB = 57.2V/m



Test Laboratory: Sporton International Inc. SAR/HAC Testing Lab

Date: 2009/1/17

HAC\_E\_WCDMA850 Ch4233\_Slide Right

DUT: 8D1718

Communication System: WCDMA; Frequency: 846.6 MHz; Duty Cycle: 1:1
Medium: Air Medium parameters used: sigma = 0 mho/m, epsilon\_r = 1; rho = 1000 kg/m^3
Ambient Temperature : 22.5

DASY5 Configuration:

- Probe: ER3DV6 - SN2358; ConvF(1, 1, 1); Calibrated: 2008/1/28
- Sensor-Surface: (Fix Surface)
- Electronics: DAE4 Sn778; Calibrated: 2008/9/22
- Phantom: HAC Test Arch 4.6; Type: SD HAC P01 BA;
- Measurement SW: DASY5, V5.0 Build 120; SEMCAD X Version 13.2 Build 87

Ch4233/Hearing Aid Compatibility Test (101x101x1): Measurement grid: dx=5mm, dy=5mm

Maximum value of peak Total field = 60.9 V/m
Probe Modulation Factor = 0.981
Device Reference Point: 0, 0, 353.7 mm
Reference Value = 65.2 V/m; Power Drift = 0.028 dB
Test Arch Compensation is Applied.

Hearing Aid Near-Field Category: M4 (AWF 0 dB)

Peak E-field in V/m

Table with 3 columns (Grid 1-3, Grid 4-6, Grid 7-9) and 3 rows of peak E-field values in V/m, such as 47.5 M4, 56.6 M4, 56.4 M4, etc.

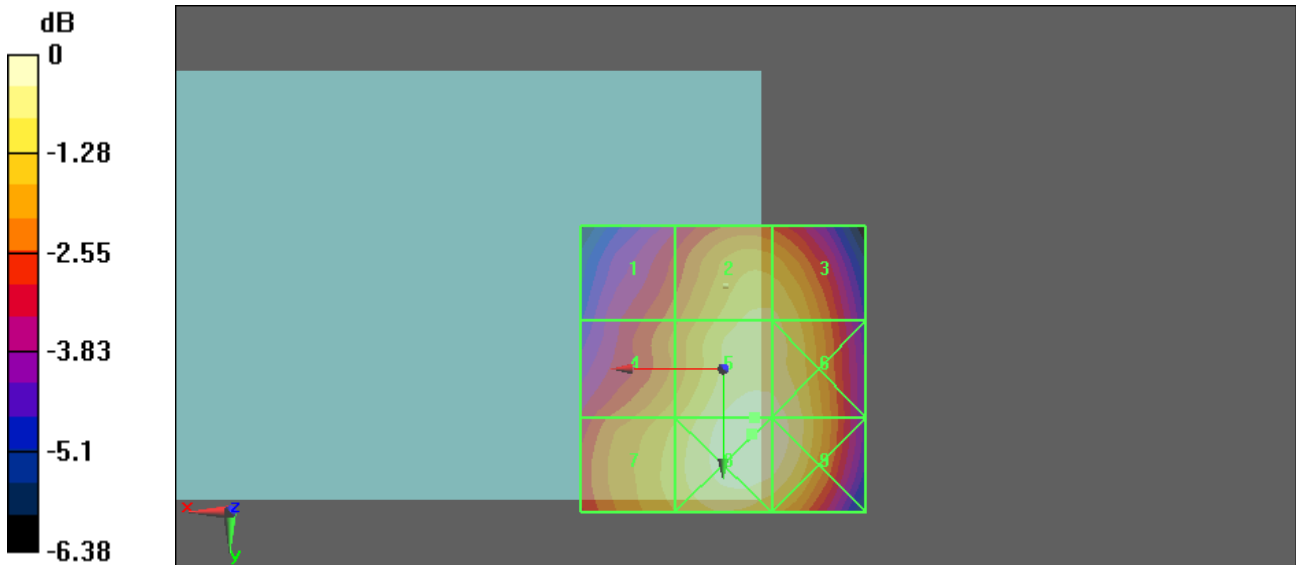

0 dB = 61.5V/m





Test Laboratory: Sporton International Inc. SAR/HAC Testing Lab

Date: 2009/1/17

HAC\_E\_WCDMA1900 Ch9262\_Slide Right

DUT: 8D1718

Communication System: WCDMA; Frequency: 1852.4 MHz; Duty Cycle: 1:1
Medium: Air Medium parameters used: sigma = 0 mho/m, epsilon\_r = 1; rho = 1000 kg/m^3
Ambient Temperature : 22.6

DASY5 Configuration:

- Probe: ER3DV6 - SN2358; ConvF(1, 1, 1); Calibrated: 2008/1/28
- Sensor-Surface: (Fix Surface)
- Electronics: DAE4 Sn778; Calibrated: 2008/9/22
- Phantom: HAC Test Arch 4.6; Type: SD HAC P01 BA;
- Measurement SW: DASY5, V5.0 Build 120; SEMCAD X Version 13.2 Build 87

Ch9262/Hearing Aid Compatibility Test (101x101x1): Measurement grid: dx=5mm, dy=5mm

Maximum value of peak Total field = 22.3 V/m

Probe Modulation Factor = 1.05

Device Reference Point: 0, 0, 353.7 mm

Reference Value = 11 V/m; Power Drift = -0.164 dB

Test Arch Compensation is Applied.

Hearing Aid Near-Field Category: M4 (AWF 0 dB)

Peak E-field in V/m

Table with 3 columns (Grid 1-3, Grid 4-6, Grid 7-9) and 3 rows of peak E-field values in M4.

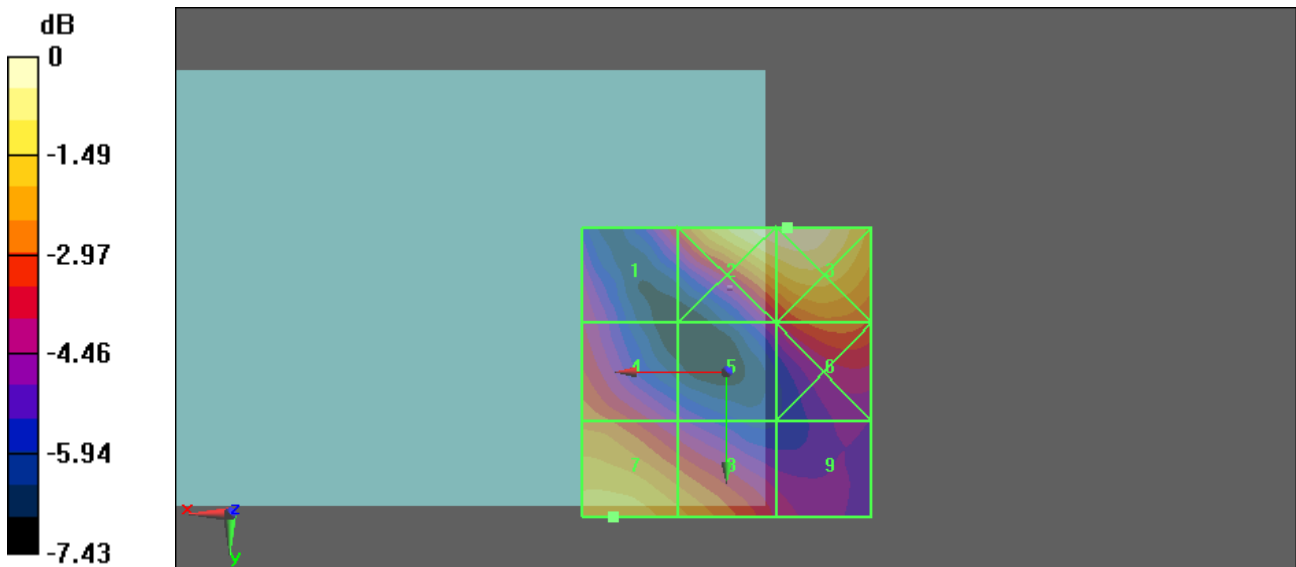

0 dB = 25.7V/m



Test Laboratory: Sporton International Inc. SAR/HAC Testing Lab

Date: 2009/1/17

HAC\_E\_WCDMA1900 Ch9400\_Slide Right

DUT: 8D1718

Communication System: WCDMA; Frequency: 1880 MHz; Duty Cycle: 1:1
Medium: Air Medium parameters used: sigma = 0 mho/m, epsilon\_r = 1; rho = 1000 kg/m^3
Ambient Temperature : 22.5

DASY5 Configuration:

- Probe: ER3DV6 - SN2358; ConvF(1, 1, 1); Calibrated: 2008/1/28
- Sensor-Surface: (Fix Surface)
- Electronics: DAE4 Sn778; Calibrated: 2008/9/22
- Phantom: HAC Test Arch 4.6; Type: SD HAC P01 BA;
- Measurement SW: DASY5, V5.0 Build 120; SEMCAD X Version 13.2 Build 87

Ch9400/Hearing Aid Compatibility Test (101x101x1): Measurement grid: dx=5mm, dy=5mm

Maximum value of peak Total field = 22 V/m
Probe Modulation Factor = 1.05
Device Reference Point: 0, 0, 353.7 mm
Reference Value = 11 V/m; Power Drift = -0.066 dB
Test Arch Compensation is Applied.

Hearing Aid Near-Field Category: M4 (AWF 0 dB)

Peak E-field in V/m

Table with 3 columns (Grid 1-3, Grid 4-6, Grid 7-9) and 3 rows of peak E-field values in M4.

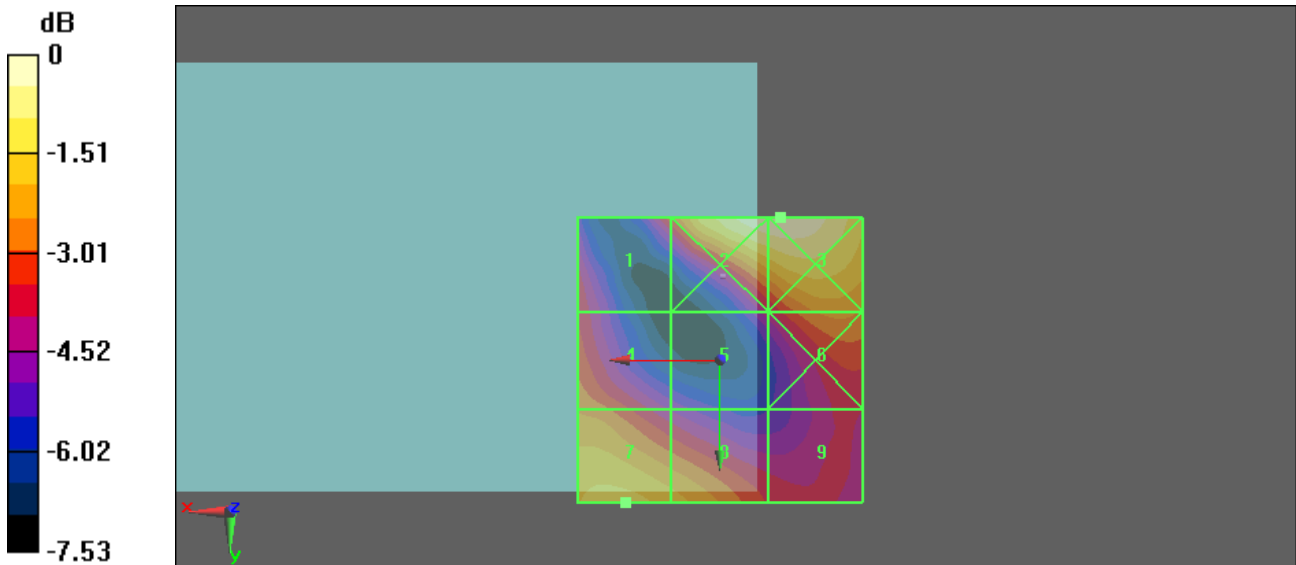

0 dB = 25.6V/m



Test Laboratory: Sporton International Inc. SAR/HAC Testing Lab

Date: 2009/1/17

HAC\_E\_WCDMA1900 Ch9538\_Slide Right

DUT: 8D1718

Communication System: WCDMA; Frequency: 1907.6 MHz;Duty Cycle: 1:1
Medium: Air Medium parameters used: sigma = 0 mho/m, epsilon\_r = 1; rho = 1000 kg/m^3
Ambient Temperature : 22.5

DASY5 Configuration:

- Probe: ER3DV6 - SN2358; ConvF(1, 1, 1); Calibrated: 2008/1/28
- Sensor-Surface: (Fix Surface)
- Electronics: DAE4 Sn778; Calibrated: 2008/9/22
- Phantom: HAC Test Arch 4.6; Type: SD HAC P01 BA;
- Measurement SW: DASY5, V5.0 Build 120; SEMCAD X Version 13.2 Build 87

Ch9538/Hearing Aid Compatibility Test (101x101x1): Measurement grid: dx=5mm, dy=5mm

Maximum value of peak Total field = 20.2 V/m

Probe Modulation Factor = 1.05

Device Reference Point: 0, 0, 353.7 mm

Reference Value = 10.7 V/m; Power Drift = 0.114 dB

Test Arch Compensation is Applied.

Hearing Aid Near-Field Category: M4 (AWF 0 dB)

Peak E-field in V/m

Table with 3 rows and 3 columns showing peak E-field values for Grid 1 through Grid 9. Values range from 14.8 M4 to 23 M4.

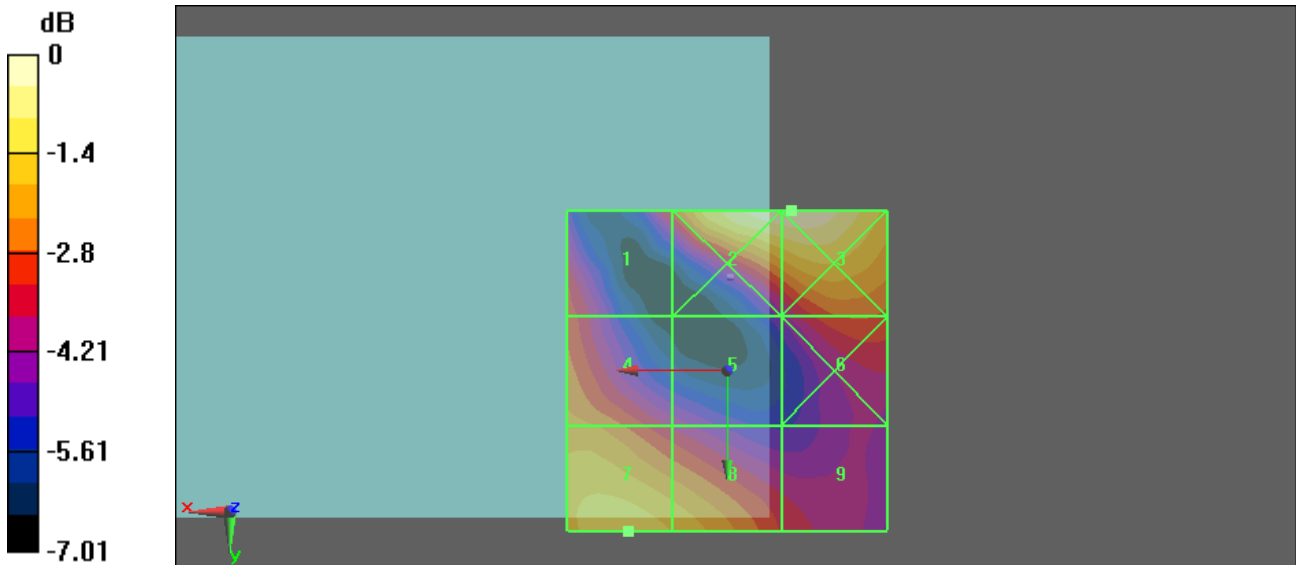

0 dB = 23V/m



Test Laboratory: Sporton International Inc. SAR/HAC Testing Lab

Date: 2008/12/23

HAC\_H\_GSM850 Ch128\_Slide Off

DUT: 8D1718

Communication System: GSM850; Frequency: 824.2 MHz; Duty Cycle: 1:8.3
Medium: Air Medium parameters used: sigma = 0 mho/m, epsilon\_r = 1; rho = 1 kg/m^3
Ambient Temperature : 22.9 C

DASY4 Configuration:

- Probe: H3DV6 - SN6184; ; Calibrated: 2008/1/28
- Sensor-Surface: (Fix Surface)
- Electronics: DAE3 Sn577; Calibrated: 2008/11/12
- Phantom: HAC Test Arch 4.6; Type: SD HAC P01 BA;
- Measurement SW: DASY4, V4.7 Build 71; Postprocessing SW: SEMCAD, V1.8 Build 184

Ch128/Hearing Aid Compatibility Test (101x101x1): Measurement grid: dx=5mm, dy=5mm

Maximum value of peak Total field = 0.121 A/m

Probe Modulation Factor = 1.42

Device Reference Point: 0.000, 0.000, 353.7 mm

Reference Value = 0.041 A/m; Power Drift = 0.002 dB

Hearing Aid Near-Field Category: M4 (AWF -5 dB)

Peak H-field in A/m

Table with 3 columns (Grid 1-3, Grid 4-6, Grid 7-9) and 3 rows of peak H-field values in A/m, such as 0.123 M4, 0.087 M4, 0.052 M4, etc.

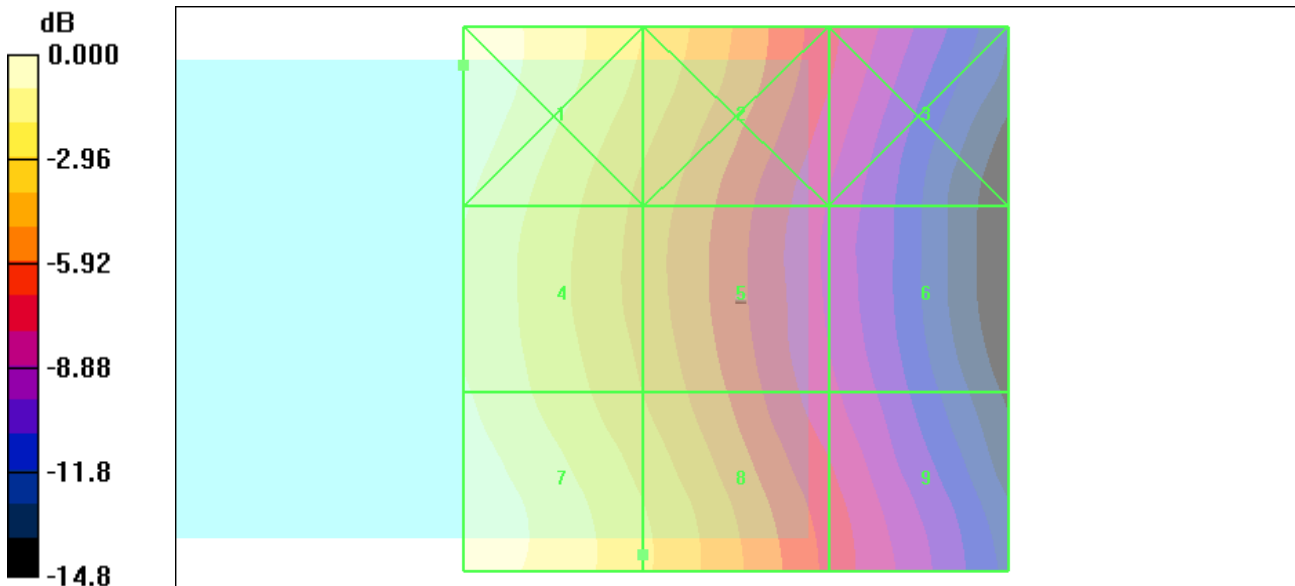

0 dB = 0.123A/m



Test Laboratory: Sporton International Inc. SAR/HAC Testing Lab

Date: 2008/12/23

HAC\_H\_GSM850 Ch189\_Slide Off

DUT: 8D1718

Communication System: GSM850; Frequency: 836.4 MHz; Duty Cycle: 1:8.3
Medium: Air Medium parameters used: sigma = 0 mho/m, epsilon\_r = 1; rho = 1 kg/m^3
Ambient Temperature : 23.0 C

DASY4 Configuration:

- Probe: H3DV6 - SN6184; ; Calibrated: 2008/1/28
- Sensor-Surface: (Fix Surface)
- Electronics: DAE3 Sn577; Calibrated: 2008/11/12
- Phantom: HAC Test Arch 4.6; Type: SD HAC P01 BA;
- Measurement SW: DASY4, V4.7 Build 71; Postprocessing SW: SEMCAD, V1.8 Build 184

Ch189/Hearing Aid Compatibility Test (101x101x1): Measurement grid: dx=5mm, dy=5mm

Maximum value of peak Total field = 0.138 A/m

Probe Modulation Factor = 1.42

Device Reference Point: 0.000, 0.000, 353.7 mm

Reference Value = 0.046 A/m; Power Drift = -0.016 dB

Hearing Aid Near-Field Category: M4 (AWF -5 dB)

Peak H-field in A/m

Table with 3 columns (Grid 1-3, Grid 4-6, Grid 7-9) and 3 rows of peak H-field values in A/m, such as 0.141 M4, 0.100 M4, 0.059 M4, etc.

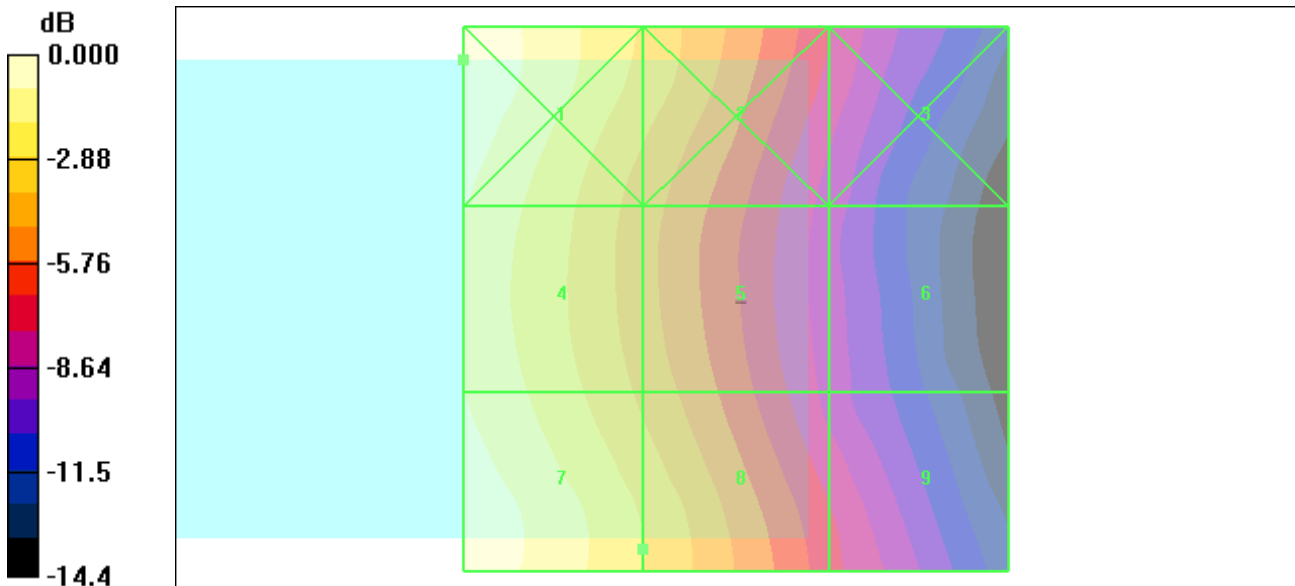

0 dB = 0.141A/m



Test Laboratory: Sporton International Inc. SAR/HAC Testing Lab

Date: 2008/12/23

HAC\_H\_GSM850 Ch251\_Slide Off

DUT: 8D1718

Communication System: GSM850; Frequency: 848.8 MHz; Duty Cycle: 1:8.3
Medium: Air Medium parameters used: sigma = 0 mho/m, epsilon\_r = 1; rho = 1 kg/m^3
Ambient Temperature : 22.9 C

DASY4 Configuration:

- Probe: H3DV6 - SN6184; ; Calibrated: 2008/1/28
- Sensor-Surface: (Fix Surface)
- Electronics: DAE3 Sn577; Calibrated: 2008/11/12
- Phantom: HAC Test Arch 4.6; Type: SD HAC P01 BA;
- Measurement SW: DASY4, V4.7 Build 71; Postprocessing SW: SEMCAD, V1.8 Build 184

Ch251/Hearing Aid Compatibility Test (101x101x1): Measurement grid: dx=5mm, dy=5mm
Maximum value of peak Total field = 0.171 A/m
Probe Modulation Factor = 1.42
Device Reference Point: 0.000, 0.000, 353.7 mm
Reference Value = 0.058 A/m; Power Drift = -0.010 dB
Hearing Aid Near-Field Category: M4 (AWF -5 dB)

Peak H-field in A/m

Table with 3 columns (Grid 1-3, Grid 4-6, Grid 7-9) and 3 rows of peak H-field values in A/m.

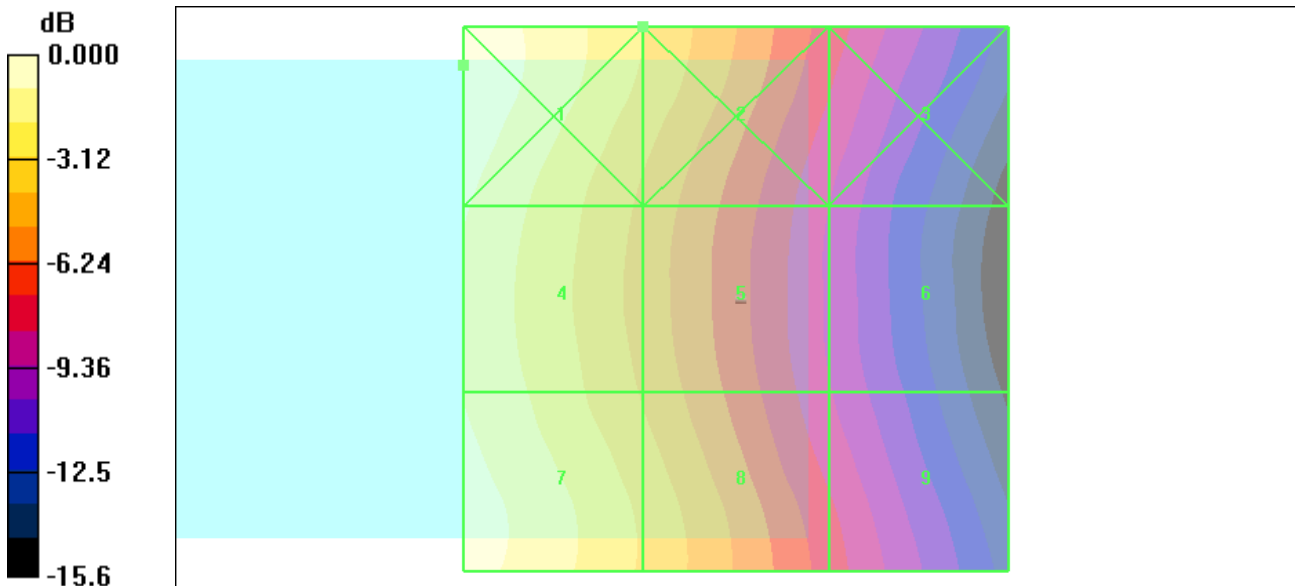

0 dB = 0.179A/m



Test Laboratory: Sporton International Inc. SAR/HAC Testing Lab

Date: 2008/12/27

HAC\_H\_GSM1900 Ch512\_Slide Off

DUT: 8D1718

Communication System: PCS; Frequency: 1850.2 MHz; Duty Cycle: 1:8,3
Medium: Air Medium parameters used: sigma = 0 mho/m, epsilon\_r = 1; rho = 1 kg/m^3
Ambient Temperature : 22.6

DASY4 Configuration:

- Probe: H3DV6 - SN6184; ; Calibrated: 2008/1/28
- Sensor-Surface: (Fix Surface)
- Electronics: DAE3 Sn577; Calibrated: 2008/11/12
- Phantom: HAC Test Arch 4.6; Type: SD HAC P01 BA
- Measurement SW: DASY4, V4.7 Build 71; Postprocessing SW: SEMCAD, V1.8 Build 184

Ch512/Hearing Aid Compatibility Test (101x101x1): Measurement grid: dx=5mm, dy=5mm

Maximum value of peak Total field = 0.076 A/m

Probe Modulation Factor = 1.19

Device Reference Point: 0.000, 0.000, 353.7 mm

Reference Value = 0.061 A/m; Power Drift = 0.081 dB

Hearing Aid Near-Field Category: M4 (AWF -5 dB)

Peak H-field in A/m

Table with 3 columns (Grid 1-3, Grid 4-6, Grid 7-9) and 3 rows of peak H-field values in A/m.

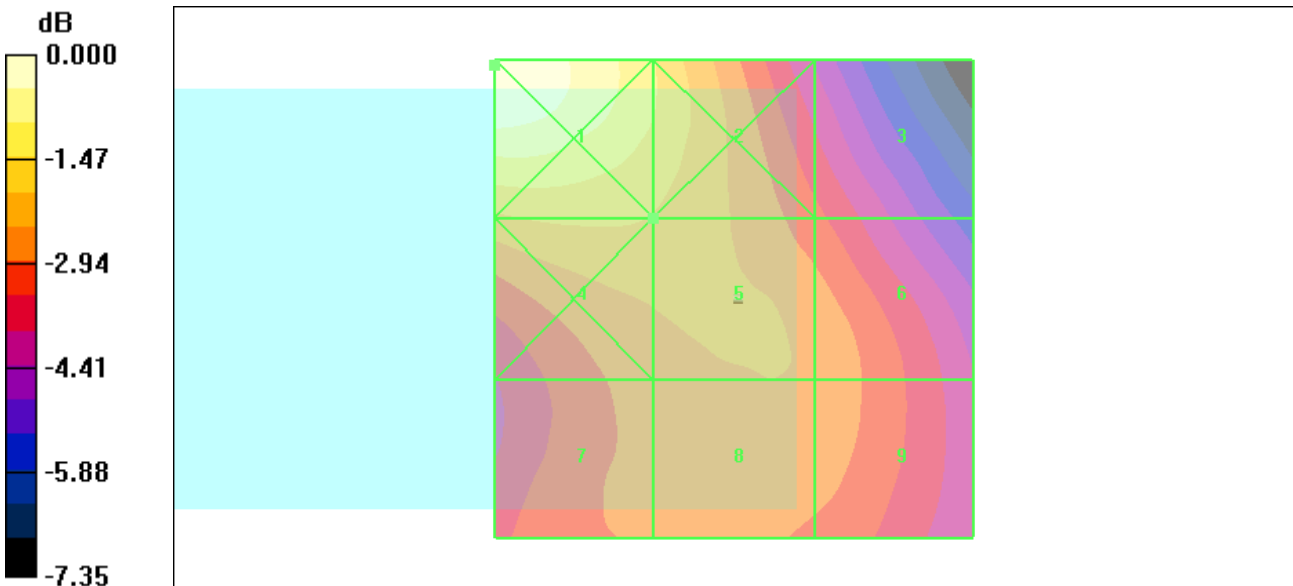

0 dB = 0.095A/m



Test Laboratory: Sporton International Inc. SAR/HAC Testing Lab

Date: 2008/12/27

HAC\_H\_GSM1900 Ch661\_Slide Off

DUT: 8D1718

Communication System: PCS; Frequency: 1880 MHz;Duty Cycle: 1:8.3
Medium: Air Medium parameters used: sigma = 0 mho/m, epsilon\_r = 1; rho = 1 kg/m^3
Ambient Temperature : 22.5

DASY4 Configuration:

- Probe: H3DV6 - SN6184; ; Calibrated: 2008/1/28
- Sensor-Surface: (Fix Surface)
- Electronics: DAE3 Sn577; Calibrated: 2008/11/12
- Phantom: HAC Test Arch 4.6; Type: SD HAC P01 BA
- Measurement SW: DASY4, V4.7 Build 71; Postprocessing SW: SEMCAD, V1.8 Build 184

Ch661/Hearing Aid Compatibility Test (101x101x1): Measurement grid: dx=5mm, dy=5mm

Maximum value of peak Total field = 0.076 A/m

Probe Modulation Factor = 1.19

Device Reference Point: 0.000, 0.000, 353.7 mm

Reference Value = 0.064 A/m; Power Drift = -0.061 dB

Hearing Aid Near-Field Category: M4 (AWF -5 dB)

Peak H-field in A/m

Table with 3 columns (Grid 1-3, Grid 4-6, Grid 7-9) and 3 rows of peak H-field values in A/m, such as 0.100 M4, 0.086 M4, 0.072 M4, etc.

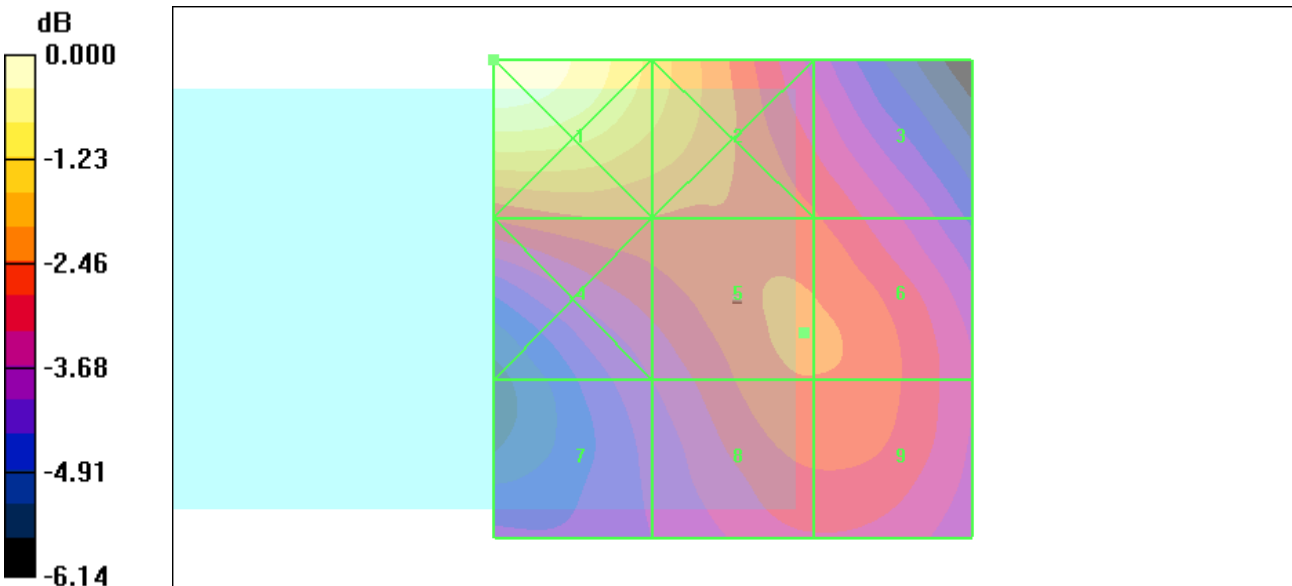

0 dB = 0.100A/m





Test Laboratory: Sporton International Inc. SAR/HAC Testing Lab

Date: 2008/12/27

HAC\_H\_GSM1900 Ch810\_Slide Off

DUT: 8D1718

Communication System: PCS; Frequency: 1909.8 MHz; Duty Cycle: 1:8,3
Medium: Air Medium parameters used: sigma = 0 mho/m, epsilon\_r = 1; rho = 1 kg/m^3
Ambient Temperature : 22.6

DASY4 Configuration:

- Probe: H3DV6 - SN6184; ; Calibrated: 2008/1/28
- Sensor-Surface: (Fix Surface)
- Electronics: DAE3 Sn577; Calibrated: 2008/11/12
- Phantom: HAC Test Arch 4.6; Type: SD HAC P01 BA
- Measurement SW: DASY4, V4.7 Build 71; Postprocessing SW: SEMCAD, V1.8 Build 184

Ch810/Hearing Aid Compatibility Test (101x101x1): Measurement grid: dx=5mm, dy=5mm

Maximum value of peak Total field = 0.078 A/m

Probe Modulation Factor = 1.19

Device Reference Point: 0.000, 0.000, 353.7 mm

Reference Value = 0.063 A/m; Power Drift = 0.040 dB

Hearing Aid Near-Field Category: M4 (AWF -5 dB)

Peak H-field in A/m

Table with 3 columns (Grid 1-3, Grid 4-6, Grid 7-9) and 3 rows of peak H-field values in A/m, such as 0.101 M4, 0.084 M4, 0.074 M4, etc.

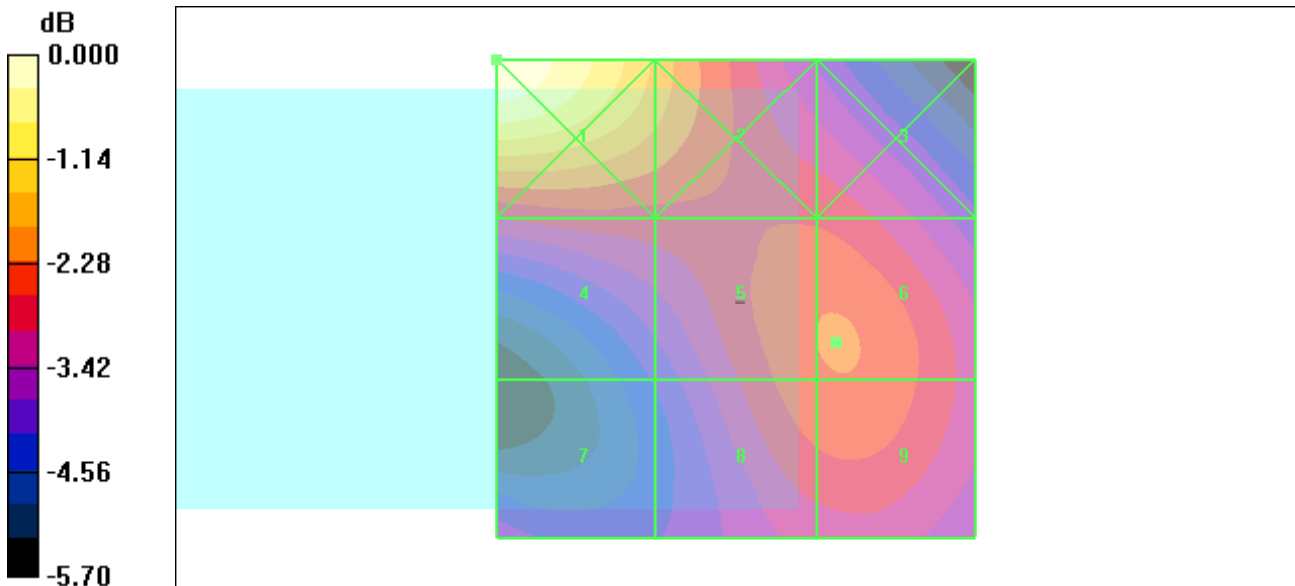

0 dB = 0.101A/m



Test Laboratory: Sporton International Inc. SAR/HAC Testing Lab

Date: 2008/12/27

HAC\_H\_WCDMA850 Ch4132\_Slide Off

DUT: 8D1718

Communication System: WCDMA; Frequency: 826.4 MHz; Duty Cycle: 1:1
Medium: Air Medium parameters used: sigma = 0 mho/m, epsilon\_r = 1; rho = 1 kg/m^3
Ambient Temperature : 22.7

DASY4 Configuration:

- Probe: H3DV6 - SN6184; ; Calibrated: 2008/1/28
- Sensor-Surface: (Fix Surface)
- Electronics: DAE3 Sn577; Calibrated: 2008/11/12
- Phantom: HAC Test Arch 4.6; Type: SD HAC P01 BA
- Measurement SW: DASY4, V4.7 Build 71; Postprocessing SW: SEMCAD, V1.8 Build 184

Ch4132/Hearing Aid Compatibility Test (101x101x1): Measurement grid: dx=5mm, dy=5mm
Maximum value of peak Total field = 0.071 A/m
Probe Modulation Factor = 0.828
Device Reference Point: 0.000, 0.000, 353.7 mm
Reference Value = 0.043 A/m; Power Drift = 0.133 dB
Hearing Aid Near-Field Category: M4 (AWF 0 dB)

Peak H-field in A/m

Table with 3 columns (Grid 1-3, Grid 4-6, Grid 7-9) and 3 rows of peak H-field values in A/m, such as 0.071 M4, 0.051 M4, 0.030 M4, etc.

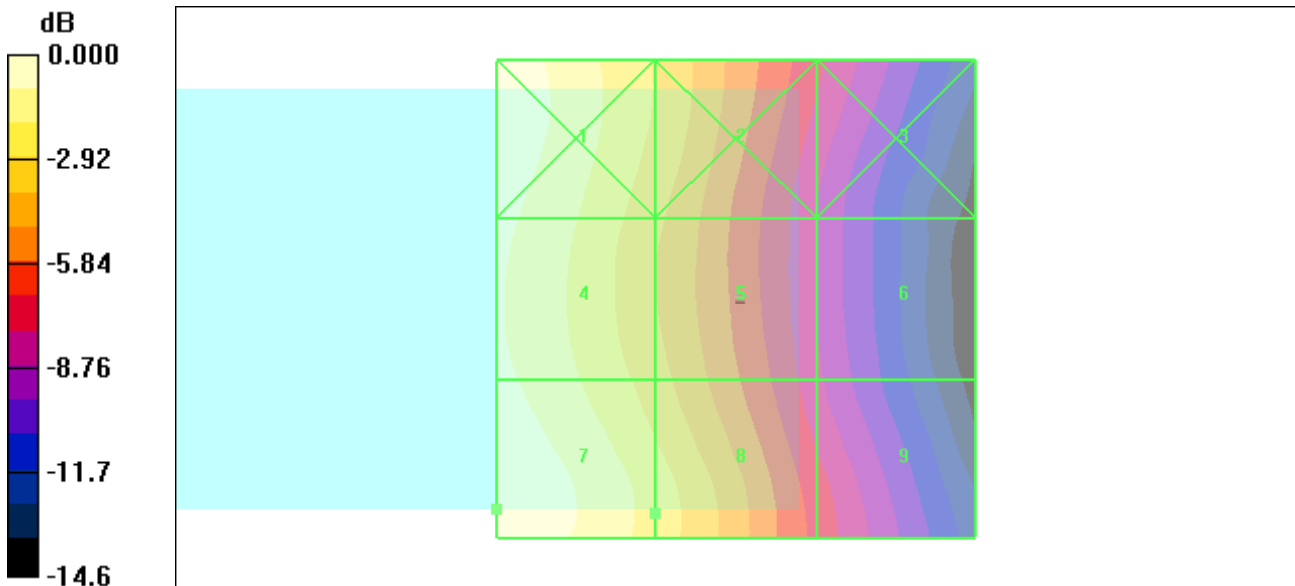

0 dB = 0.071A/m



Test Laboratory: Sporton International Inc. SAR/HAC Testing Lab

Date: 2008/12/27

HAC\_H\_WCDMA850 Ch4182\_Slide Off

DUT: 8D1718

Communication System: WCDMA; Frequency: 836.4 MHz; Duty Cycle: 1:1
Medium: Air Medium parameters used: sigma = 0 mho/m, epsilon\_r = 1; rho = 1 kg/m^3
Ambient Temperature : 22.7

DASY4 Configuration:

- Probe: H3DV6 - SN6184; ; Calibrated: 2008/1/28
- Sensor-Surface: (Fix Surface)
- Electronics: DAE3 Sn577; Calibrated: 2008/11/12
- Phantom: HAC Test Arch 4.6; Type: SD HAC P01 BA;
- Measurement SW: DASY4, V4.7 Build 71; Postprocessing SW: SEMCAD, V1.8 Build 184

Ch4182/Hearing Aid Compatibility Test (101x101x1): Measurement grid: dx=5mm, dy=5mm

Maximum value of peak Total field = 0.075 A/m

Probe Modulation Factor = 0.828

Device Reference Point: 0.000, 0.000, 353.7 mm

Reference Value = 0.044 A/m; Power Drift = 0.121 dB

Hearing Aid Near-Field Category: M4 (AWF 0 dB)

Peak H-field in A/m

Table with 3 columns (Grid 1-3, Grid 4-6, Grid 7-9) and 3 rows of peak H-field values in A/m, such as 0.074 M4, 0.055 M4, 0.032 M4, etc.

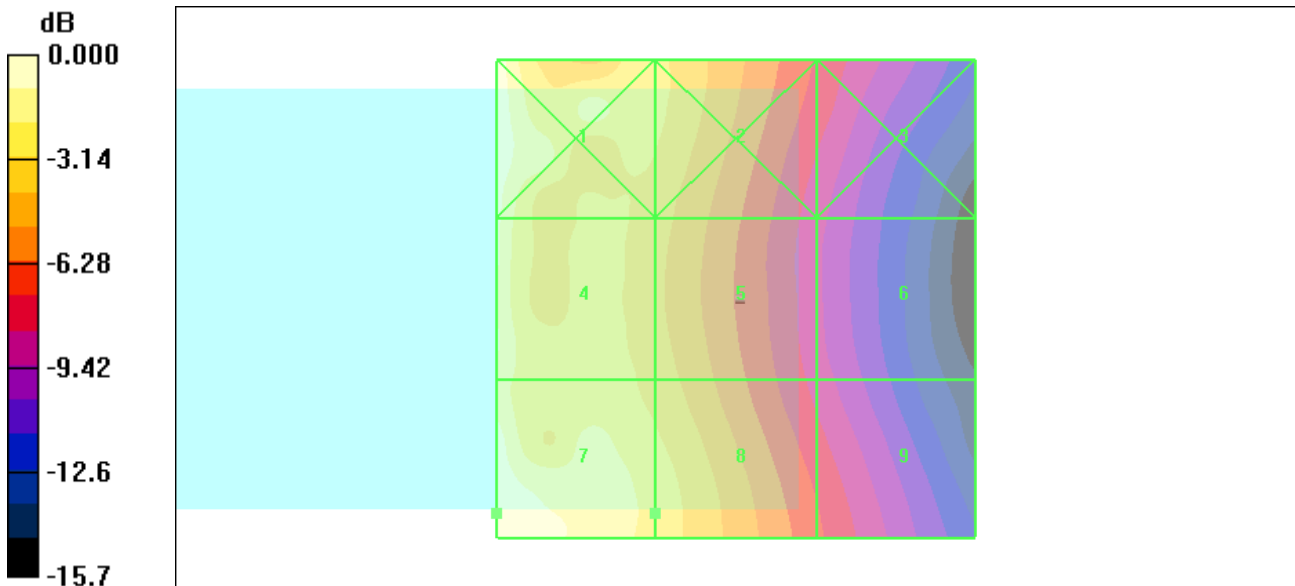

0 dB = 0.075A/m



Test Laboratory: Sporton International Inc. SAR/HAC Testing Lab

Date: 2008/12/27

HAC\_H\_WCDMA850 Ch4233\_Slide Off

DUT: 8D1718

Communication System: WCDMA; Frequency: 846.6 MHz; Duty Cycle: 1:1
Medium: Air Medium parameters used: sigma = 0 mho/m, epsilon\_r = 1; rho = 1 kg/m^3
Ambient Temperature : 22.5

DASY4 Configuration:

- Probe: H3DV6 - SN6184; ; Calibrated: 2008/1/28
- Sensor-Surface: (Fix Surface)
- Electronics: DAE3 Sn577; Calibrated: 2008/11/12
- Phantom: HAC Test Arch 4.6; Type: SD HAC P01 BA
- Measurement SW: DASY4, V4.7 Build 71; Postprocessing SW: SEMCAD, V1.8 Build 184

Ch4233/Hearing Aid Compatibility Test (101x101x1): Measurement grid: dx=5mm, dy=5mm
Maximum value of peak Total field = 0.080 A/m
Probe Modulation Factor = 0.828
Device Reference Point: 0.000, 0.000, 353.7 mm
Reference Value = 0.050 A/m; Power Drift = 0.055 dB
Hearing Aid Near-Field Category: M4 (AWF 0 dB)

Peak H-field in A/m

Table with 3 columns (Grid 1-3, Grid 4-6, Grid 7-9) and 3 rows of field strength values in A/m.

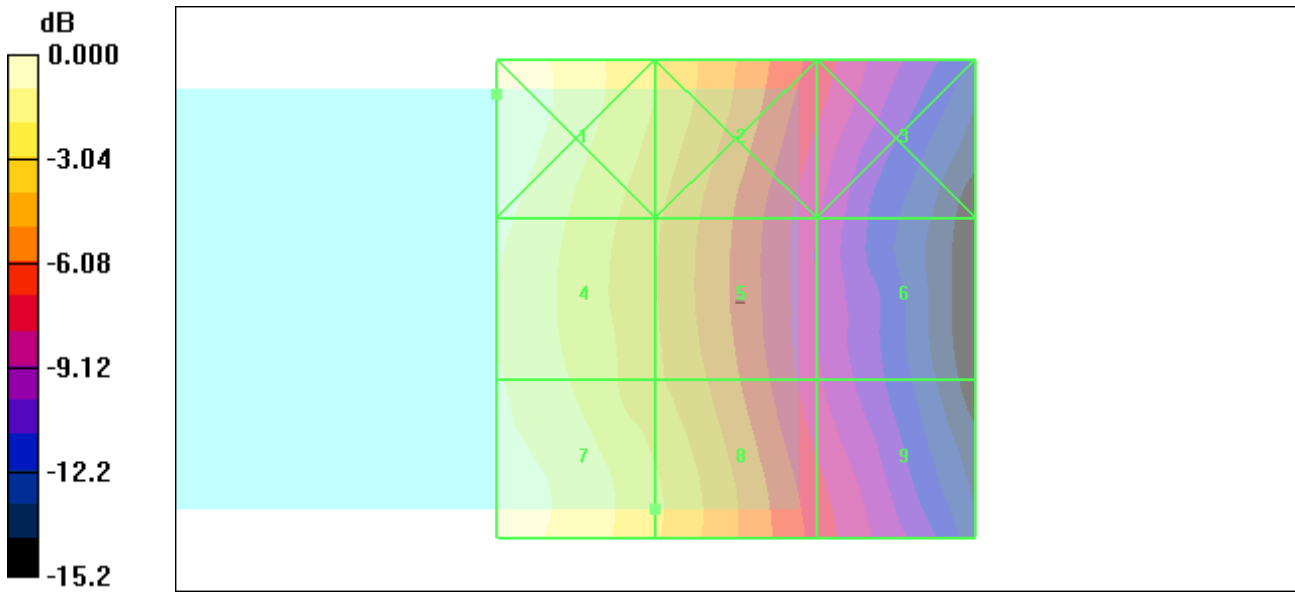

0 dB = 0.084A/m



Test Laboratory: Sporton International Inc. SAR/HAC Testing Lab

Date: 2008/12/27

HAC\_H\_WCDMA1900 Ch9262\_Slide Off

DUT: 8D1718

Communication System: WCDMA; Frequency: 1852.4 MHz; Duty Cycle: 1:1
Medium: Air Medium parameters used: sigma = 0 mho/m, epsilon\_r = 1; rho = 1 kg/m^3
Ambient Temperature : 22.5

DASY4 Configuration:

- Probe: H3DV6 - SN6184; ; Calibrated: 2008/1/28
- Sensor-Surface: (Fix Surface)
- Electronics: DAE3 Sn577; Calibrated: 2008/11/12
- Phantom: HAC Test Arch 4.6; Type: SD HAC P01 BA
- Measurement SW: DASY4, V4.7 Build 71; Postprocessing SW: SEMCAD, V1.8 Build 184

Ch9262/Hearing Aid Compatibility Test (101x101x1): Measurement grid: dx=5mm, dy=5mm

Maximum value of peak Total field = 0.043 A/m

Probe Modulation Factor = 0.589

Device Reference Point: 0.000, 0.000, 353.7 mm

Reference Value = 0.072 A/m; Power Drift = 0.015 dB

Hearing Aid Near-Field Category: M4 (AWF 0 dB)

Peak H-field in A/m

Table with 3 columns (Grid 1-3, Grid 4-6, Grid 7-9) and 3 rows of peak H-field values in A/m, such as 0.054 M4, 0.047 M4, 0.039 M4, etc.

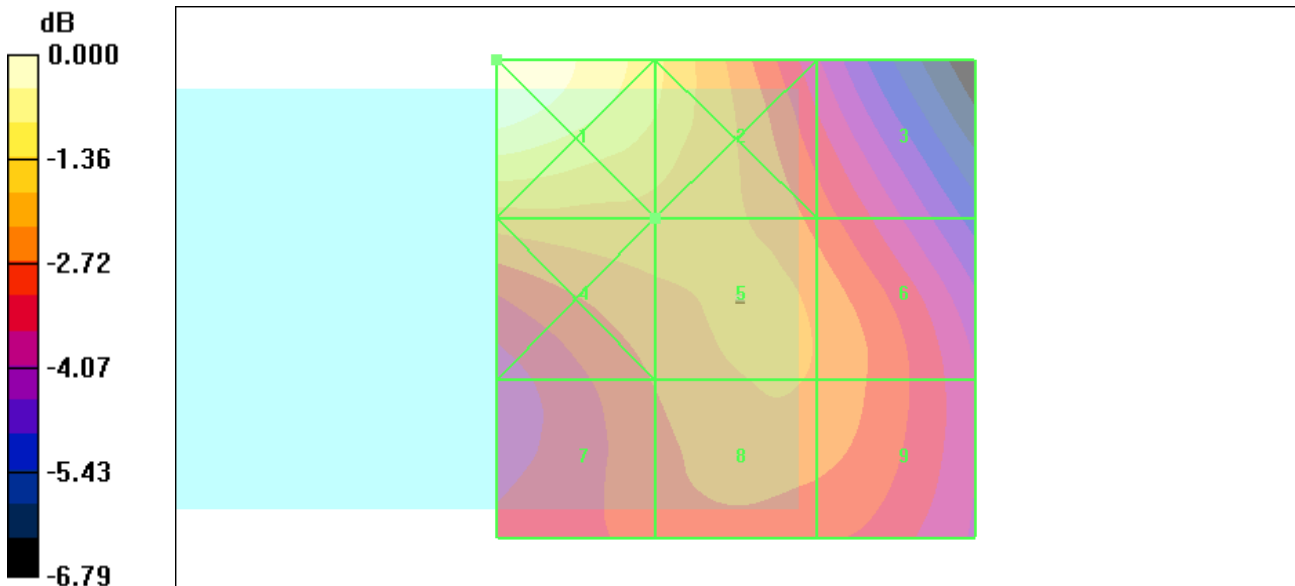

0 dB = 0.054A/m



Test Laboratory: Sporton International Inc. SAR/HAC Testing Lab

Date: 2008/12/27

HAC\_H\_WCDMA1900 Ch9400\_Slide Off

DUT: 8D1718

Communication System: WCDMA; Frequency: 1880 MHz;Duty Cycle: 1:1
Medium: Air Medium parameters used: sigma = 0 mho/m, epsilon\_r = 1; rho = 1 kg/m^3
Ambient Temperature : 22.6

DASY4 Configuration:

- Probe: H3DV6 - SN6184; ; Calibrated: 2008/1/28
- Sensor-Surface: (Fix Surface)
- Electronics: DAE3 Sn577; Calibrated: 2008/11/12
- Phantom: HAC Test Arch 4.6; Type: SD HAC P01 BA
- Measurement SW: DASY4, V4.7 Build 71; Postprocessing SW: SEMCAD, V1.8 Build 184

Ch9400/Hearing Aid Compatibility Test (101x101x1): Measurement grid: dx=5mm, dy=5mm

Maximum value of peak Total field = 0.043 A/m

Probe Modulation Factor = 0.589

Device Reference Point: 0.000, 0.000, 353.7 mm

Reference Value = 0.073 A/m; Power Drift = -0.194 dB

Hearing Aid Near-Field Category: M4 (AWF 0 dB)

Peak H-field in A/m

Table with 3 columns (Grid 1-3, Grid 4-6, Grid 7-9) and 3 rows of peak H-field values in A/m, such as 0.056 M4, 0.048 M4, 0.041 M4, etc.

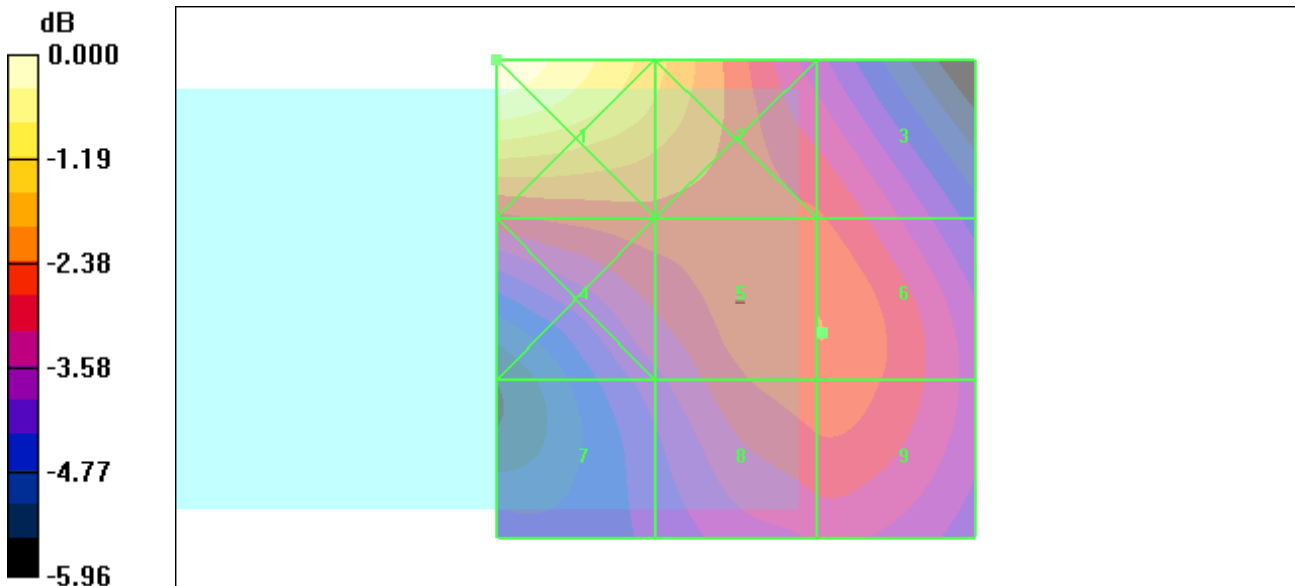

0 dB = 0.056A/m



Test Laboratory: Sporton International Inc. SAR/HAC Testing Lab

Date: 2008/12/27

HAC\_H\_WCDMA1900 Ch9538\_Slide Off

DUT: 8D1718

Communication System: WCDMA; Frequency: 1907.6 MHz; Duty Cycle: 1:1
Medium: Air Medium parameters used: sigma = 0 mho/m, epsilon\_r = 1; rho = 1 kg/m^3
Ambient Temperature : 22.6

DASY4 Configuration:

- Probe: H3DV6 - SN6184; ; Calibrated: 2008/1/28
- Sensor-Surface: (Fix Surface)
- Electronics: DAE3 Sn577; Calibrated: 2008/11/12
- Phantom: HAC Test Arch 4.6; Type: SD HAC P01 BA
- Measurement SW: DASY4, V4.7 Build 71; Postprocessing SW: SEMCAD, V1.8 Build 184

Ch9538/Hearing Aid Compatibility Test (101x101x1): Measurement grid: dx=5mm, dy=5mm

Maximum value of peak Total field = 0.039 A/m

Probe Modulation Factor = 0.589

Device Reference Point: 0.000, 0.000, 353.7 mm

Reference Value = 0.063 A/m; Power Drift = 0.009 dB

Hearing Aid Near-Field Category: M4 (AWF 0 dB)

Peak H-field in A/m

Table with 3 columns (Grid 1-3, Grid 4-6, Grid 7-9) and 3 rows of peak H-field values in A/m, such as 0.050 M4, 0.042 M4, 0.037 M4, etc.

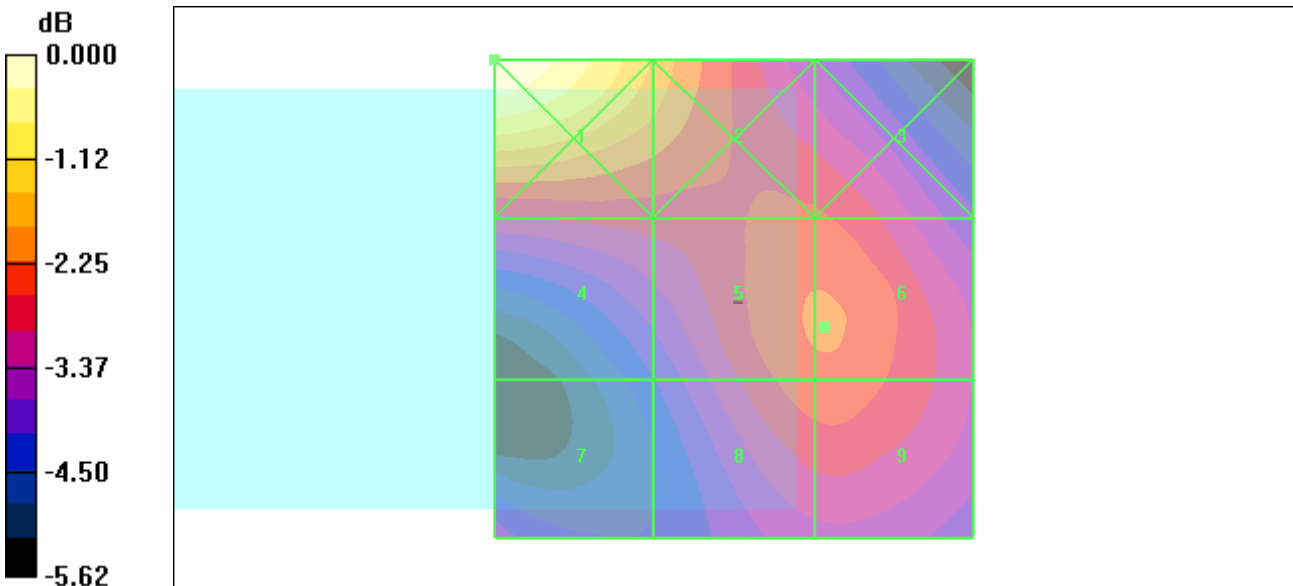

0 dB = 0.050A/m



Test Laboratory: Sporton International Inc. SAR/HAC Testing Lab

Date: 2009/1/17

HAC\_H\_GSM850 Ch128\_Slide Right

DUT: 8D1718

Communication System: GSM850; Frequency: 824.2 MHz; Duty Cycle: 1:8.3
Medium: Air Medium parameters used: sigma = 0 mho/m, epsilon\_r = 1; rho = 1 kg/m^3
Ambient Temperature : 22.6

DASY5 Configuration:

- Probe: H3DV6 - SN6184; ; Calibrated: 2008/1/28
- Sensor-Surface: (Fix Surface)
- Electronics: DAE4 Sn778; Calibrated: 2008/9/22
- Phantom: HAC Test Arch 4.6; Type: SD HAC P01 BA;
- Measurement SW: DASY5, V5.0 Build 120; SEMCAD X Version 13.2 Build 87

Ch128/Hearing Aid Compatibility Test (101x101x1): Measurement grid: dx=5mm, dy=5mm

Maximum value of peak Total field = 0.110 A/m
Probe Modulation Factor = 1.42
Device Reference Point: 0, 0, 353.7 mm
Reference Value = 0.042 A/m; Power Drift = -0.012 dB
Hearing Aid Near-Field Category: M4 (AWF -5 dB)

Peak H-field in A/m

Table with 3 columns (Grid 1-3, Grid 4-6, Grid 7-9) and 3 rows of field strength values in A/m.

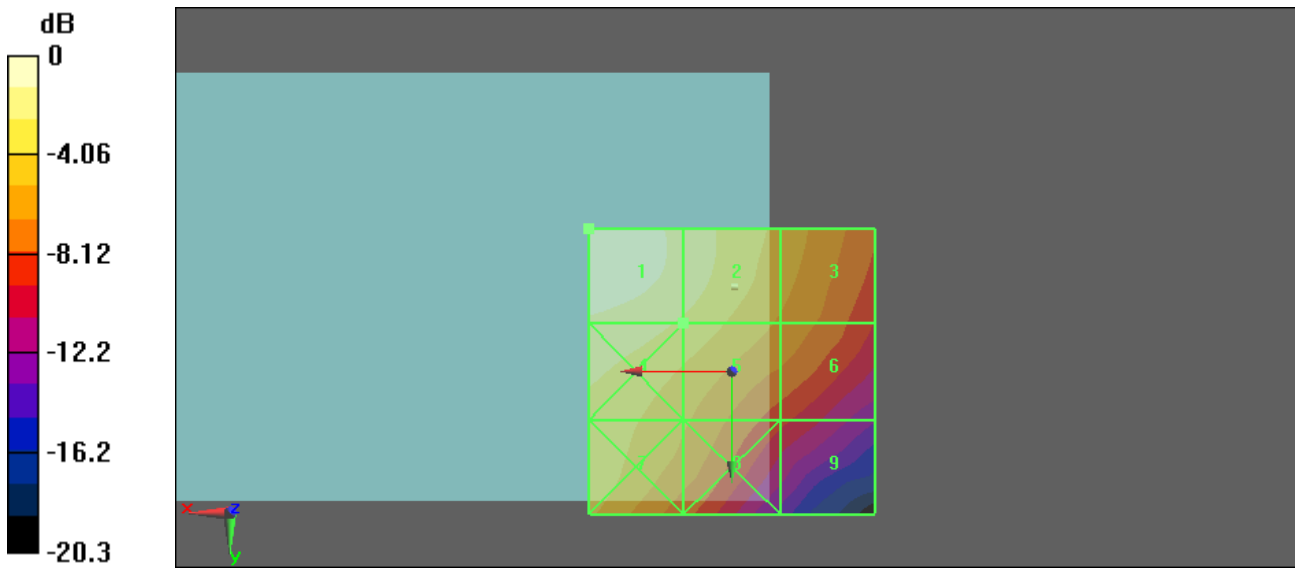

0 dB = 0.110A/m





Test Laboratory: Sporton International Inc. SAR/HAC Testing Lab

Date: 2009/1/17

HAC\_H\_GSM850 Ch189\_Slide Right

DUT: 8D1718

Communication System: GSM850; Frequency: 836.4 MHz; Duty Cycle: 1:8.3
Medium: Air Medium parameters used: sigma = 0 mho/m, epsilon\_r = 1; rho = 1 kg/m^3
Ambient Temperature : 22.5

DASY5 Configuration:

- Probe: H3DV6 - SN6184; ; Calibrated: 2008/1/28
- Sensor-Surface: (Fix Surface)
- Electronics: DAE4 Sn778; Calibrated: 2008/9/22
- Phantom: HAC Test Arch 4.6; Type: SD HAC P01 BA;
- Measurement SW: DASY5, V5.0 Build 120; SEMCAD X Version 13.2 Build 87

Ch189/Hearing Aid Compatibility Test (101x101x1): Measurement grid: dx=5mm, dy=5mm

Maximum value of peak Total field = 0.135 A/m
Probe Modulation Factor = 1.42
Device Reference Point: 0, 0, 353.7 mm
Reference Value = 0.053 A/m; Power Drift = 0.025 dB
Hearing Aid Near-Field Category: M4 (AWF -5 dB)

Peak H-field in A/m

Table with 3 columns (Grid 1-3, Grid 4-6, Grid 7-9) and 3 rows of field strength values in A/m.

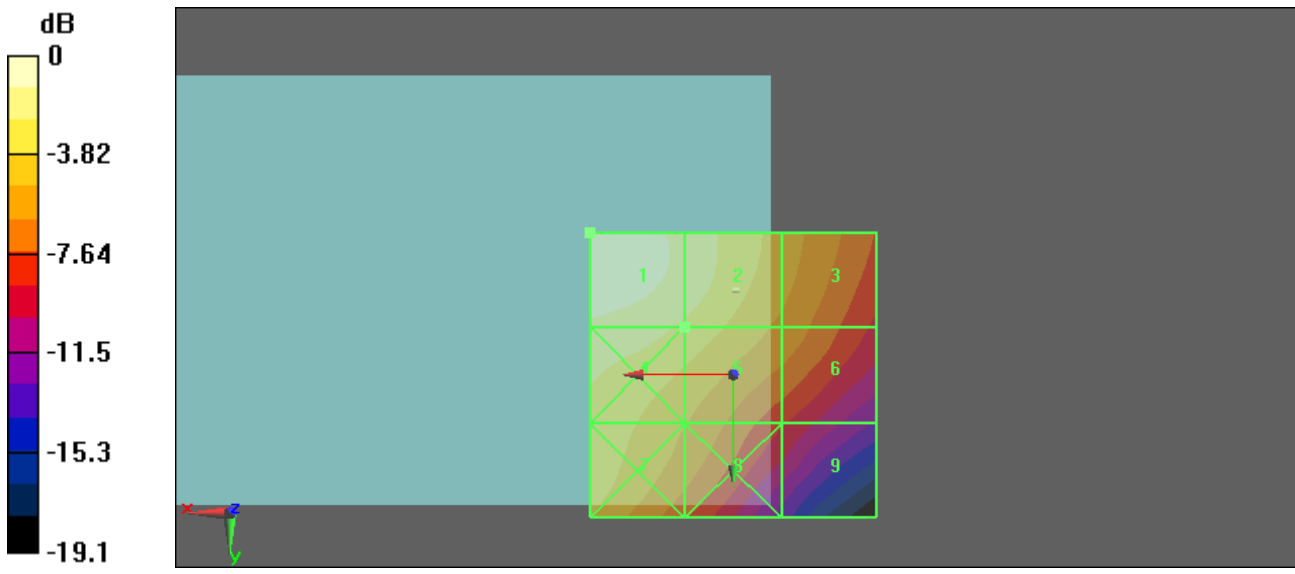

0 dB = 0.135A/m



Test Laboratory: Sporton International Inc. SAR/HAC Testing Lab

Date: 2009/1/17

HAC\_H\_GSM850 Ch251\_Slide Right

DUT: 8D1718

Communication System: GSM850; Frequency: 848.8 MHz; Duty Cycle: 1:8.3
Medium: Air Medium parameters used: sigma = 0 mho/m, epsilon\_r = 1; rho = 1 kg/m^3
Ambient Temperature : 22.5

DASY5 Configuration:

- Probe: H3DV6 - SN6184; ; Calibrated: 2008/1/28
- Sensor-Surface: (Fix Surface)
- Electronics: DAE4 Sn778; Calibrated: 2008/9/22
- Phantom: HAC Test Arch 4.6; Type: SD HAC P01 BA
- Measurement SW: DASY5, V5.0 Build 120; SEMCAD X Version 13.2 Build 87

Ch251/Hearing Aid Compatibility Test (101x101x1): Measurement grid: dx=5mm, dy=5mm

Maximum value of peak Total field = 0.166 A/m
Probe Modulation Factor = 1.42
Device Reference Point: 0, 0, 353.7 mm
Reference Value = 0.066 A/m; Power Drift = -0.035 dB
Hearing Aid Near-Field Category: M4 (AWF -5 dB)

Peak H-field in A/m

Table with 3 columns (Grid 1-3, Grid 4-6, Grid 7-9) and 3 rows of field strength values in A/m.

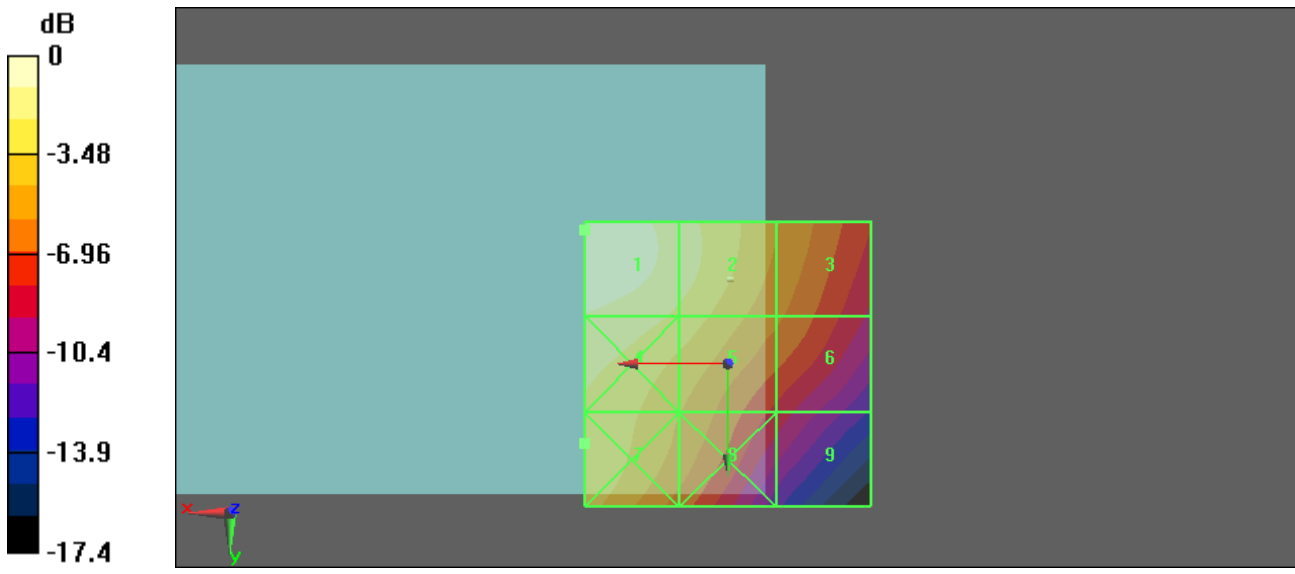

0 dB = 0.166A/m



Test Laboratory: Sporton International Inc. SAR/HAC Testing Lab

Date: 2009/1/17

HAC\_H\_GSM1900 Ch512\_Slide Right

DUT: 8D1718

Communication System: PCS; Frequency: 1850.2 MHz; Duty Cycle: 1:8.3
Medium: Air Medium parameters used: sigma = 0 mho/m, epsilon\_r = 1; rho = 1 kg/m^3
Ambient Temperature : 22.6

DASY5 Configuration:

- Probe: H3DV6 - SN6184; ; Calibrated: 2008/1/28
- Sensor-Surface: (Fix Surface)
- Electronics: DAE4 Sn778; Calibrated: 2008/9/22
- Phantom: HAC Test Arch 4.6; Type: SD HAC P01 BA
- Measurement SW: DASY5, V5.0 Build 120; SEMCAD X Version 13.2 Build 87

Ch512/Hearing Aid Compatibility Test (101x101x1): Measurement grid: dx=5mm, dy=5mm

Maximum value of peak Total field = 0.080 A/m

Probe Modulation Factor = 1.19

Device Reference Point: 0, 0, 353.7 mm

Reference Value = 0.048 A/m; Power Drift = -0.068 dB

Hearing Aid Near-Field Category: M4 (AWF -5 dB)

Peak H-field in A/m

Table with 3 columns (Grid 1-3, Grid 4-6, Grid 7-9) and 3 rows of peak H-field values in A/m.

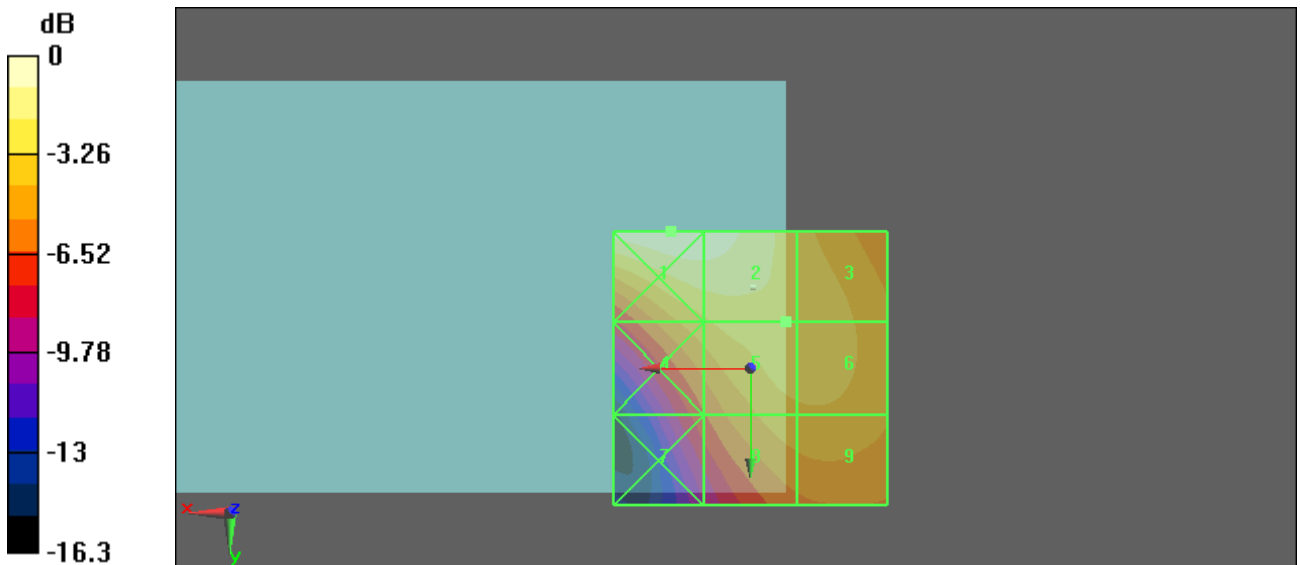

0 dB = 0.083A/m



Test Laboratory: Sporton International Inc. SAR/HAC Testing Lab

Date: 2009/1/17

HAC\_H\_GSM1900 Ch661\_Slide Right

DUT: 8D1718

Communication System: PCS; Frequency: 1880 MHz;Duty Cycle: 1:8.3
Medium: Air Medium parameters used: sigma = 0 mho/m, epsilon\_r = 1; rho = 1 kg/m^3
Ambient Temperature : 22.6

DASY5 Configuration:

- Probe: H3DV6 - SN6184; ; Calibrated: 2008/1/28
- Sensor-Surface: (Fix Surface)
- Electronics: DAE4 Sn778; Calibrated: 2008/9/22
- Phantom: HAC Test Arch 4.6; Type: SD HAC P01 BA
- Measurement SW: DASY5, V5.0 Build 120; SEMCAD X Version 13.2 Build 87

Ch661/Hearing Aid Compatibility Test (101x101x1): Measurement grid: dx=5mm, dy=5mm

Maximum value of peak Total field = 0.063 A/m

Probe Modulation Factor = 1.19

Device Reference Point: 0, 0, 353.7 mm

Reference Value = 0.047 A/m; Power Drift = -0.038 dB

Hearing Aid Near-Field Category: M4 (AWF -5 dB)

Peak H-field in A/m

Table with 3 columns (Grid 1-3, Grid 4-6, Grid 7-9) and 3 rows of field strength values in A/m.

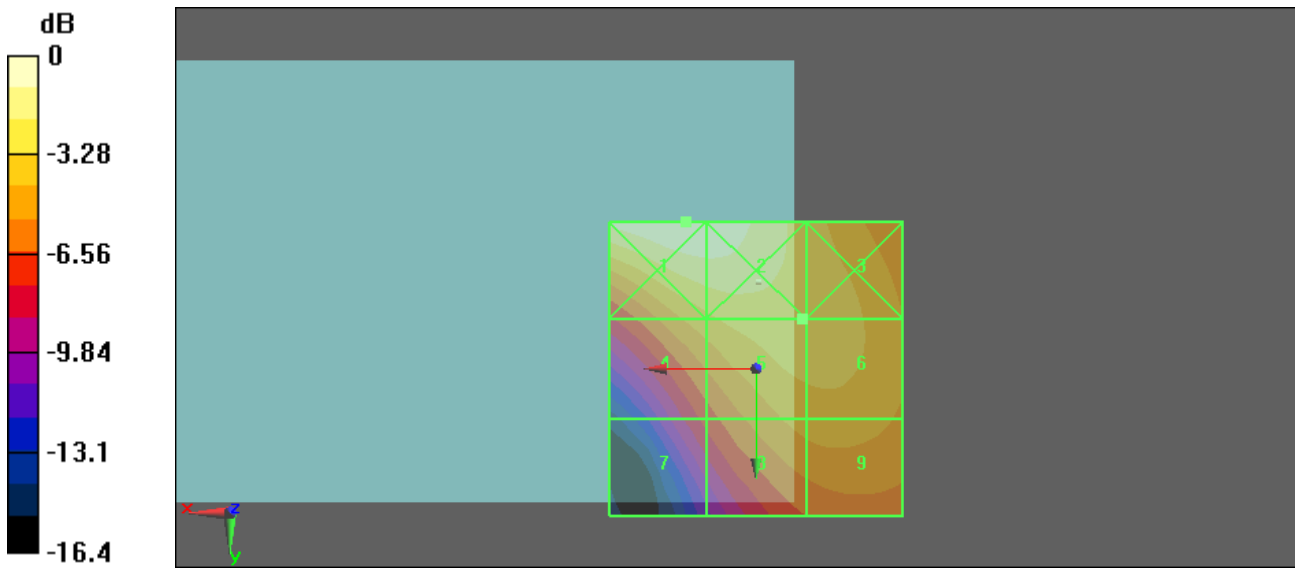

0 dB = 0.084A/m



Test Laboratory: Sporton International Inc. SAR/HAC Testing Lab

Date: 2009/1/17

HAC\_H\_GSM1900 Ch810\_Slide Right

DUT: 8D1718

Communication System: PCS; Frequency: 1909.8 MHz; Duty Cycle: 1:8,3
Medium: Air Medium parameters used: sigma = 0 mho/m, epsilon\_r = 1; rho = 1 kg/m^3
Ambient Temperature : 22.6

DASY5 Configuration:

- Probe: H3DV6 - SN6184; ; Calibrated: 2008/1/28
- Sensor-Surface: (Fix Surface)
- Electronics: DAE4 Sn778; Calibrated: 2008/9/22
- Phantom: HAC Test Arch 4.6; Type: SD HAC P01 BA
- Measurement SW: DASY5, V5.0 Build 120; SEMCAD X Version 13.2 Build 87

Ch810/Hearing Aid Compatibility Test (101x101x1): Measurement grid: dx=5mm, dy=5mm

Maximum value of peak Total field = 0.060 A/m
Probe Modulation Factor = 1.19
Device Reference Point: 0, 0, 353.7 mm
Reference Value = 0.043 A/m; Power Drift = 0.070 dB
Hearing Aid Near-Field Category: M4 (AWF -5 dB)

Peak H-field in A/m

Table with 3 columns (Grid 1-3, Grid 4-6, Grid 7-9) and 3 rows of peak H-field values in A/m.

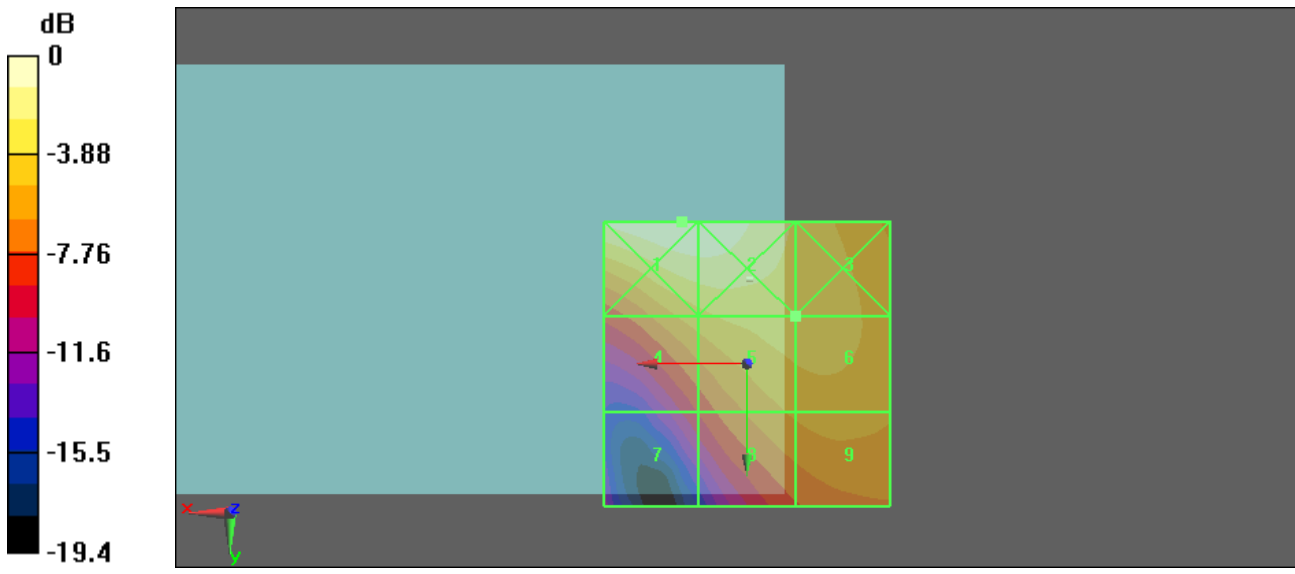

0 dB = 0.086A/m



Test Laboratory: Sporton International Inc. SAR/HAC Testing Lab

Date: 2009/1/17

HAC\_H\_WCDMA850 Ch4132\_Slide Right

DUT: 8D1718

Communication System: WCDMA; Frequency: 826.4 MHz; Duty Cycle: 1:1
Medium: Air Medium parameters used: sigma = 0 mho/m, epsilon\_r = 1; rho = 1 kg/m^3
Ambient Temperature : 22.5

DASY5 Configuration:

- Probe: H3DV6 - SN6184; ; Calibrated: 2008/1/28
- Sensor-Surface: (Fix Surface)
- Electronics: DAE4 Sn778; Calibrated: 2008/9/22
- Phantom: HAC Test Arch 4.6; Type: SD HAC P01 BA
- Measurement SW: DASY5, V5.0 Build 120; SEMCAD X Version 13.2 Build 87

Ch4132/Hearing Aid Compatibility Test (101x101x1): Measurement grid: dx=5mm, dy=5mm

Maximum value of peak Total field = 0.054 A/m
Probe Modulation Factor = 0.828
Device Reference Point: 0, 0, 353.7 mm
Reference Value = 0.034 A/m; Power Drift = 0.052 dB
Hearing Aid Near-Field Category: M4 (AWF 0 dB)

Peak H-field in A/m

Table with 3 columns (Grid 1-3, Grid 4-6, Grid 7-9) and 3 rows of peak H-field values in A/m.

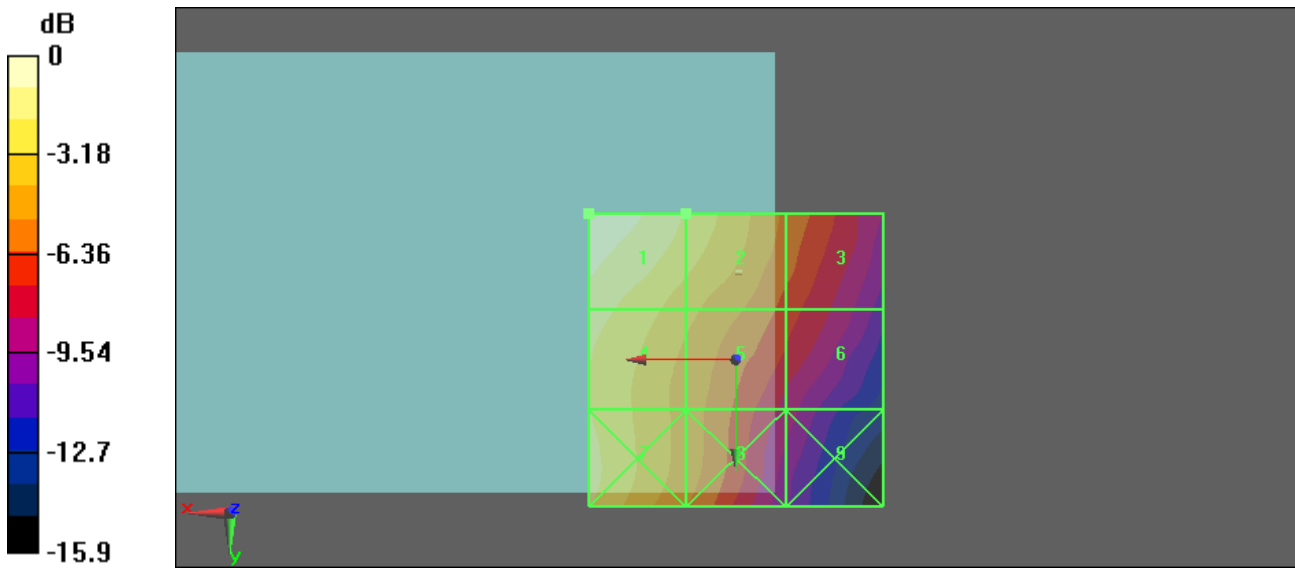

0 dB = 0.054A/m



Test Laboratory: Sporton International Inc. SAR/HAC Testing Lab

Date: 2009/1/17

HAC\_H\_WCDMA850 Ch4182\_Slide Right

DUT: 8D1718

Communication System: WCDMA; Frequency: 836.4 MHz; Duty Cycle: 1:1
Medium: Air Medium parameters used: sigma = 0 mho/m, epsilon\_r = 1; rho = 1 kg/m^3
Ambient Temperature : 22.6

DASY5 Configuration:

- Probe: H3DV6 - SN6184; ; Calibrated: 2008/1/28
- Sensor-Surface: (Fix Surface)
- Electronics: DAE4 Sn778; Calibrated: 2008/9/22
- Phantom: HAC Test Arch 4.6; Type: SD HAC P01 BA
- Measurement SW: DASY5, V5.0 Build 120; SEMCAD X Version 13.2 Build 87

Ch4182/Hearing Aid Compatibility Test (101x101x1): Measurement grid: dx=5mm, dy=5mm

Maximum value of peak Total field = 0.063 A/m
Probe Modulation Factor = 0.828
Device Reference Point: 0, 0, 353.7 mm
Reference Value = 0.040 A/m; Power Drift = -0.105 dB
Hearing Aid Near-Field Category: M4 (AWF 0 dB)

Peak H-field in A/m

Table with 3 columns (Grid 1-3, Grid 4-6, Grid 7-9) and 3 rows of field strength values in A/m.

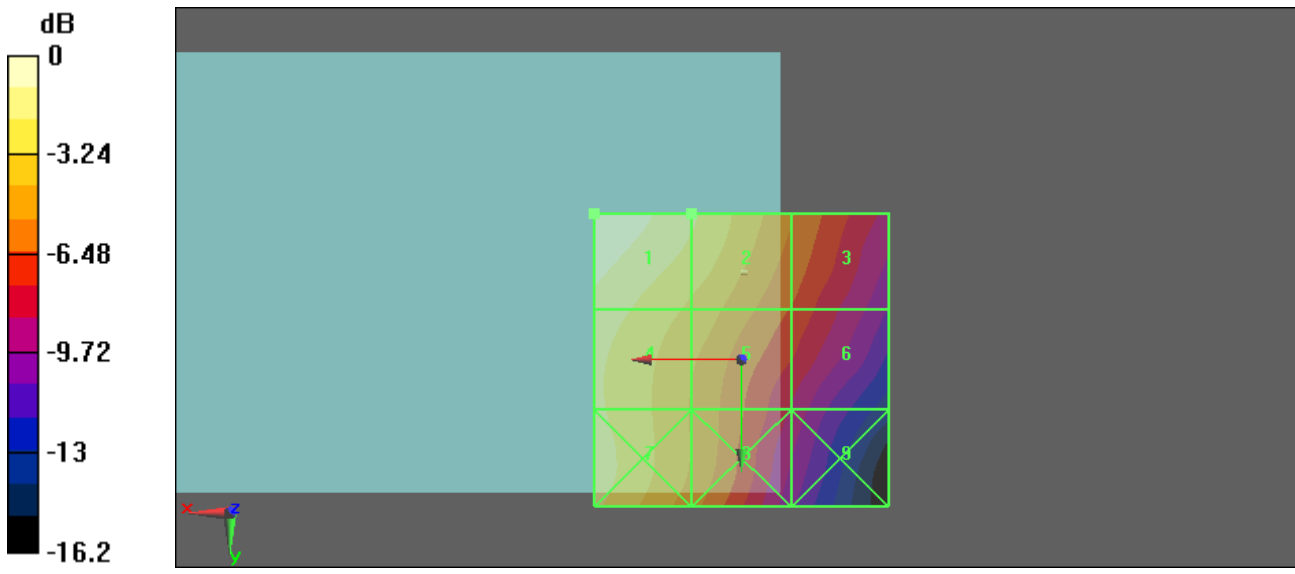

0 dB = 0.063A/m



Test Laboratory: Sporton International Inc. SAR/HAC Testing Lab

Date: 2009/1/17

HAC\_H\_WCDMA850 Ch4233\_Slide Right

DUT: 8D1718

Communication System: WCDMA; Frequency: 846.6 MHz; Duty Cycle: 1:1
Medium: Air Medium parameters used: sigma = 0 mho/m, epsilon\_r = 1; rho = 1 kg/m^3
Ambient Temperature : 22.5

DASY5 Configuration:

- Probe: H3DV6 - SN6184; ; Calibrated: 2008/1/28
- Sensor-Surface: (Fix Surface)
- Electronics: DAE4 Sn778; Calibrated: 2008/9/22
- Phantom: HAC Test Arch 4.6; Type: SD HAC P01 BA
- Measurement SW: DASY5, V5.0 Build 120; SEMCAD X Version 13.2 Build 87

Ch4233/Hearing Aid Compatibility Test (101x101x1): Measurement grid: dx=5mm, dy=5mm

Maximum value of peak Total field = 0.070 A/m
Probe Modulation Factor = 0.828
Device Reference Point: 0, 0, 353.7 mm
Reference Value = 0.046 A/m; Power Drift = 0.010 dB
Hearing Aid Near-Field Category: M4 (AWF 0 dB)

Peak H-field in A/m

Table with 3 columns (Grid 1-3, Grid 4-6, Grid 7-9) and 3 rows of peak H-field values in A/m.

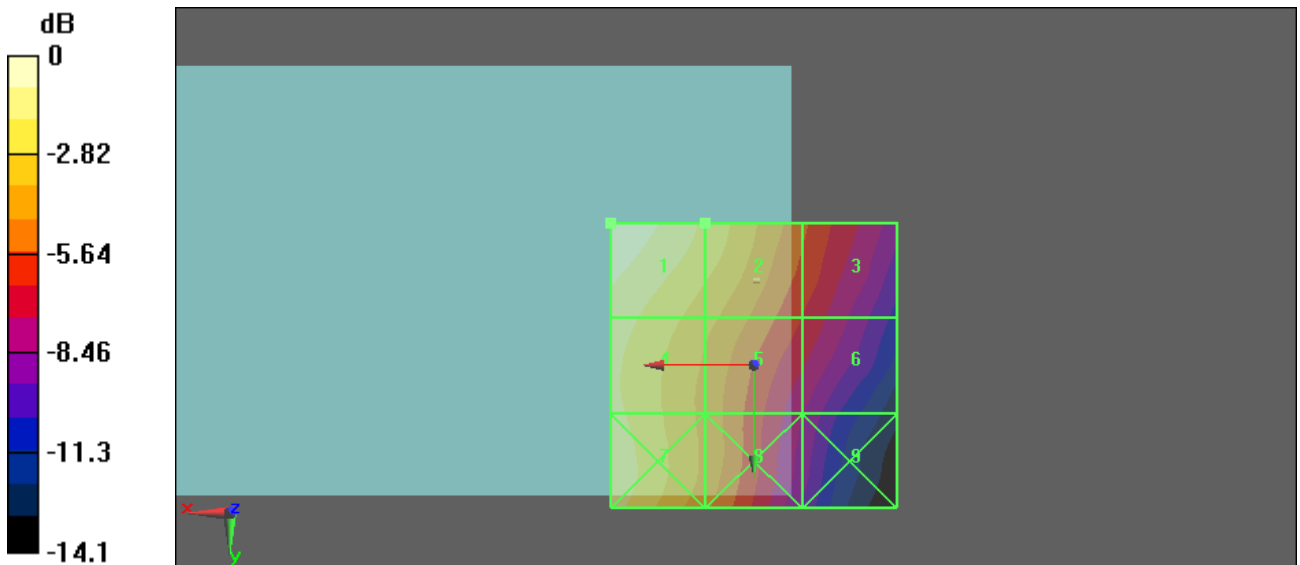

0 dB = 0.070A/m





Test Laboratory: Sporton International Inc. SAR/HAC Testing Lab

Date: 2009/1/17

HAC\_H\_WCDMA1900 Ch9262\_Slide Right

DUT: 8D1718

Communication System: WCDMA; Frequency: 1852.4 MHz; Duty Cycle: 1:1
Medium: Air Medium parameters used: sigma = 0 mho/m, epsilon\_r = 1; rho = 1 kg/m^3
Ambient Temperature : 22.6

DASY5 Configuration:

- Probe: H3DV6 - SN6184; ; Calibrated: 2008/1/28
- Sensor-Surface: (Fix Surface)
- Electronics: DAE4 Sn778; Calibrated: 2008/9/22
- Phantom: HAC Test Arch 4.6; Type: SD HAC P01 BA
- Measurement SW: DASY5, V5.0 Build 120; SEMCAD X Version 13.2 Build 87

Ch9262/Hearing Aid Compatibility Test (101x101x1): Measurement grid: dx=5mm, dy=5mm

Maximum value of peak Total field = 0.022 A/m
Probe Modulation Factor = 0.589
Device Reference Point: 0, 0, 353.7 mm
Reference Value = 0.032 A/m; Power Drift = -0.279 dB
Hearing Aid Near-Field Category: M4 (AWF 0 dB)

Peak H-field in A/m

Table with 3 columns (Grid 1-3, Grid 4-6, Grid 7-9) and 3 rows of peak H-field values in A/m.

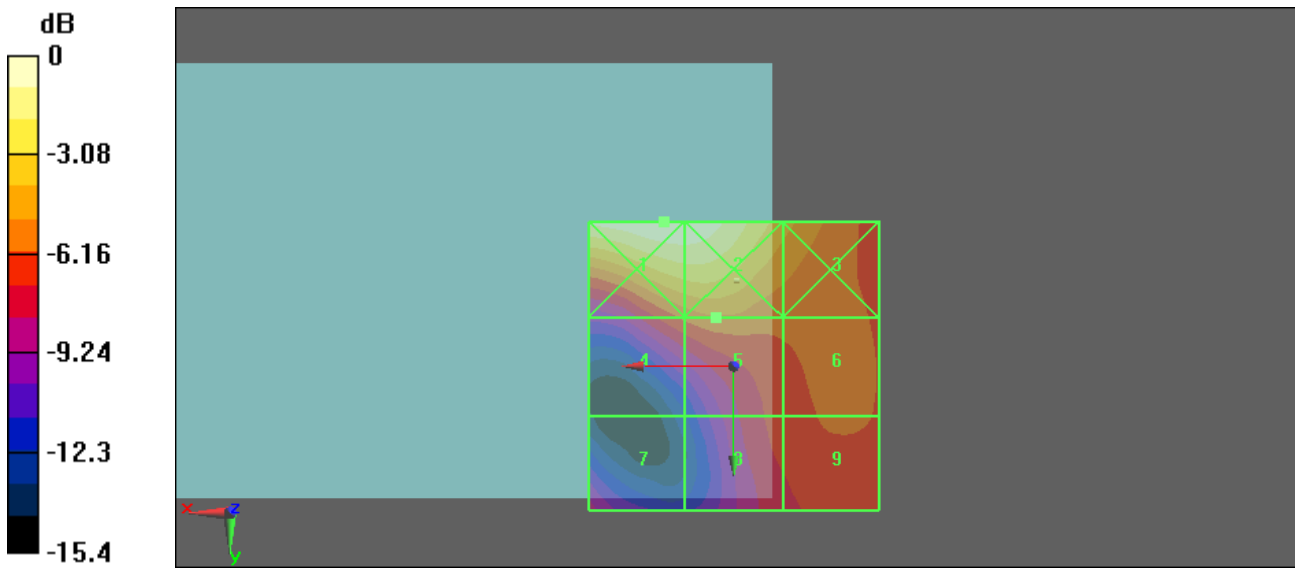

0 dB = 0.040A/m



Test Laboratory: Sporton International Inc. SAR/HAC Testing Lab

Date: 2009/1/17

HAC\_H\_WCDMA1900 Ch9400\_Slide Right

DUT: 8D1718

Communication System: WCDMA; Frequency: 1880 MHz; Duty Cycle: 1:1
Medium: Air Medium parameters used: sigma = 0 mho/m, epsilon\_r = 1; rho = 1 kg/m^3
Ambient Temperature : 22.6

DASY5 Configuration:

- Probe: H3DV6 - SN6184; ; Calibrated: 2008/1/28
- Sensor-Surface: (Fix Surface)
- Electronics: DAE4 Sn778; Calibrated: 2008/9/22
- Phantom: HAC Test Arch 4.6; Type: SD HAC P01 BA
- Measurement SW: DASY5, V5.0 Build 120; SEMCAD X Version 13.2 Build 87

Ch9400/Hearing Aid Compatibility Test (101x101x1): Measurement grid: dx=5mm, dy=5mm

Maximum value of peak Total field = 0.023 A/m
Probe Modulation Factor = 0.589
Device Reference Point: 0, 0, 353.7 mm
Reference Value = 0.029 A/m; Power Drift = 0.025 dB
Hearing Aid Near-Field Category: M4 (AWF 0 dB)

Peak H-field in A/m

Table with 3 columns (Grid 1-3, Grid 4-6, Grid 7-9) and 3 rows of peak H-field values in A/m.

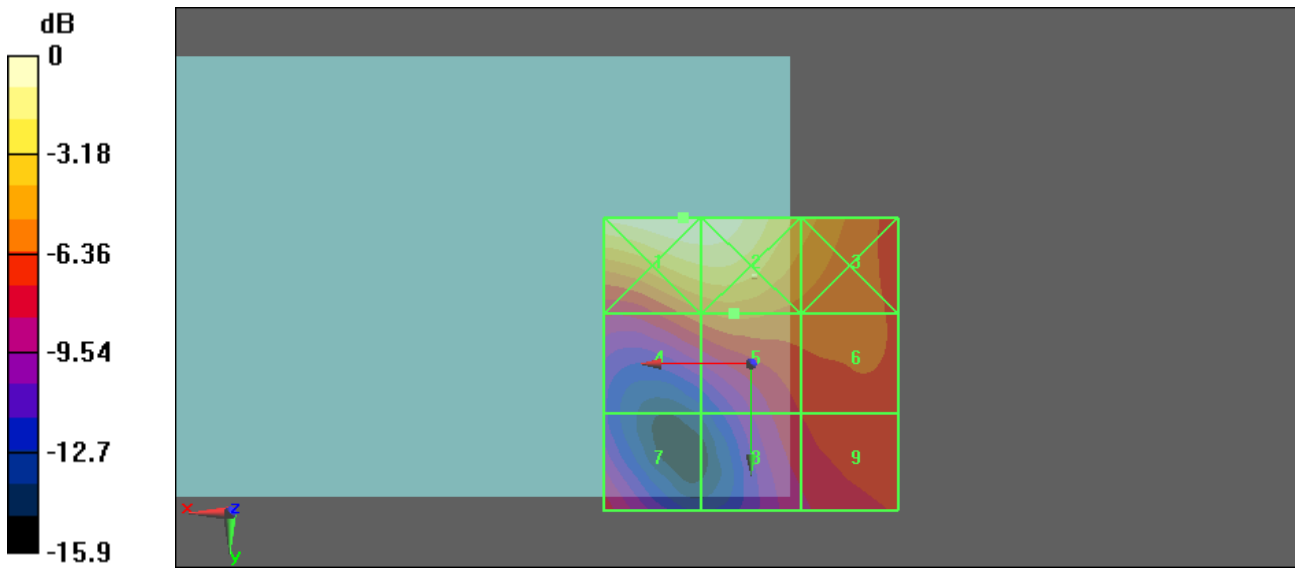

0 dB = 0.040A/m



Test Laboratory: Sporton International Inc. SAR/HAC Testing Lab

Date: 2009/1/17

HAC\_H\_WCDMA1900 Ch9538\_Slide Right

DUT: 8D1718

Communication System: WCDMA; Frequency: 1907.6 MHz; Duty Cycle: 1:1
Medium: Air Medium parameters used: sigma = 0 mho/m, epsilon\_r = 1; rho = 1 kg/m^3
Ambient Temperature : 22.6

DASY5 Configuration:

- Probe: H3DV6 - SN6184; ; Calibrated: 2008/1/28
- Sensor-Surface: (Fix Surface)
- Electronics: DAE4 Sn778; Calibrated: 2008/9/22
- Phantom: HAC Test Arch 4.6; Type: SD HAC P01 BA
- Measurement SW: DASY5, V5.0 Build 120; SEMCAD X Version 13.2 Build 87

Ch9538/Hearing Aid Compatibility Test (101x101x1): Measurement grid: dx=5mm, dy=5mm

Maximum value of peak Total field = 0.020 A/m
Probe Modulation Factor = 0.589
Device Reference Point: 0, 0, 353.7 mm
Reference Value = 0.024 A/m; Power Drift = -0.181 dB
Hearing Aid Near-Field Category: M4 (AWF 0 dB)

Peak H-field in A/m

Table with 3 columns (Grid 1-3, Grid 4-6, Grid 7-9) and 3 rows of field strength values in A/m.

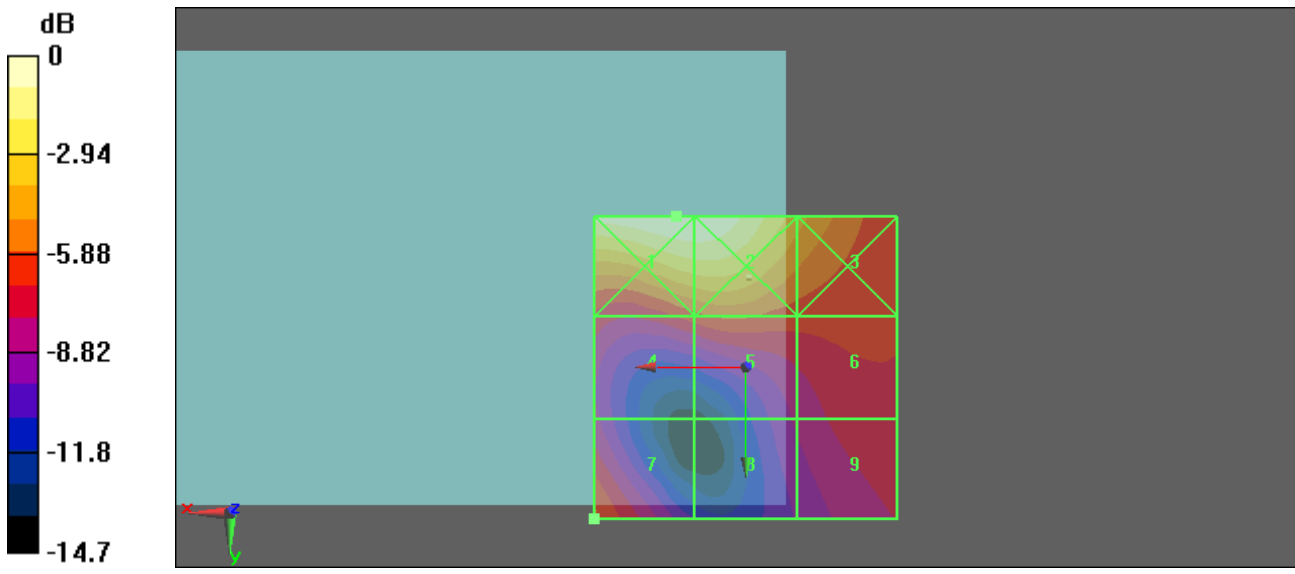

0 dB = 0.039A/m



### ***Appendix C – Calibration Data***

Please refer to the calibration certificates of DASY as below.



Calibration Laboratory of Schmid & Partner Engineering AG Zeughausstrasse 43, 8004 Zurich, Switzerland



S Schweizerischer Kalibrierdienst
C Service suisse d'etalonnage
S Servizio svizzero di taratura
S Swiss Calibration Service

Accredited by the Swiss Federal Office of Metrology and Accreditation The Swiss Accreditation Service is one of the signatories to the EA Multilateral Agreement for the recognition of calibration certificates

Accreditation No.: SCS 108

Client Sporton (Auden)

Certificate No: CD835V3-1045\_Sep07

CALIBRATION CERTIFICATE

Object CD835V3 - SN: 1045
Calibration procedure(s) QA CAL-20.v4 Calibration procedure for dipoles in air
Calibration date: September 25, 2007
Condition of the calibrated item In Tolerance

This calibration certificate documents the traceability to national standards, which realize the physical units of measurements (SI). All calibrations have been conducted in the closed laboratory facility: environment temperature (22 ± 3)°C and humidity < 70%.

Calibration Equipment used (M&TE critical for calibration)

Table with 4 columns: Primary Standards, ID #, Cal Date (Calibrated by, Certificate No.), Scheduled Calibration. Includes rows for Power meter EPM-442A, Power sensor HP 8481A, Probe ER3DV6, Probe H3DV6, DAE4, and Secondary Standards.

Calibrated by: Name Mike Meil, Function Laboratory Technician, Signature [Signature]
Approved by: Name Fin Bomholt, Function Technical Director, Signature [Signature]

Issued: September 27, 2007

This calibration certificate shall not be reproduced except in full without written approval of the laboratory.



Calibration Laboratory of  
Schmid & Partner  
Engineering AG  
Zeughausstrasse 43, 8004 Zurich, Switzerland



S Schweizerischer Kalibrierdienst  
C Service suisse d'étalonnage  
S Servizio svizzero di taratura  
S Swiss Calibration Service

Accredited by the Swiss Federal Office of Metrology and Accreditation  
The Swiss Accreditation Service is one of the signatories to the EA  
Multilateral Agreement for the recognition of calibration certificates

Accreditation No.: SCS 108

#### References

- [1] ANSI-C63.19-2006  
American National Standard for Methods of Measurement of Compatibility between Wireless Communications Devices and Hearing Aids.

#### Methods Applied and Interpretation of Parameters:

- *Coordinate System:* y-axis is in the direction of the dipole arms. z-axis is from the basis of the antenna (mounted on the table) towards its feed point between the two dipole arms. x-axis is normal to the other axes. In coincidence with standard [1], the measurement planes (probe sensor center) are selected to be at a distance of 10 mm above the top edge of the dipole arms.
- *Measurement Conditions:* Further details are available from the hardcopies at the end of the certificate. All figures stated in the certificate are valid at the frequency indicated. The forward power to the dipole connector is set with a calibrated power meter connected and monitored with an auxiliary power meter connected to a directional coupler. While the dipole under test is connected, the forward power is adjusted to the same level.
- *Antenna Positioning:* The dipole is mounted on a HAC Test Arch phantom using the matching dipole positioner with the arms horizontal and the feeding cable coming from the floor. The measurements are performed in a shielded room with absorbers around the setup to reduce the reflections. It is verified before the mounting of the dipole under the Test Arch phantom, that its arms are perfectly in a line. It is installed on the HAC dipole positioner with its arms parallel below the dielectric reference wire and able to move elastically in vertical direction without changing its relative position to the top center of the Test Arch phantom. The vertical distance to the probe is adjusted after dipole mounting with a DASY4 Surface Check job. Before the measurement, the distance between phantom surface and probe tip is verified. The proper measurement distance is selected by choosing the matching section of the HAC Test Arch phantom with the proper device reference point (upper surface of the dipole) and the matching grid reference point (tip of the probe) considering the probe sensor offset. The vertical distance to the probe is essential for the accuracy.
- *Feed Point Impedance and Return Loss:* These parameters are measured using a HP 8753E Vector Network Analyzer. The impedance is specified at the SMA connector of the dipole. The influence of reflections was eliminating by applying the averaging function while moving the dipole in the air, at least 70cm away from any obstacles.
- *E-field distribution:* E field is measured in the x-y-plane with an isotropic ER3D-field probe with 100 mW forward power to the antenna feed point. In accordance with [1], the scan area is 20mm wide, its length exceeds the dipole arm length (180 or 90mm). The sensor center is 10 mm (in z) above the top of the dipole arms. Two 3D maxima are available near the end of the dipole arms. Assuming the dipole arms are perfectly in one line, the average of these two maxima (in subgrid 2 and subgrid 8) is determined to compensate for any non-parallelity to the measurement plane as well as the sensor displacement. The E-field value stated as calibration value represents the maximum of the interpolated 3D-E-field, 10mm above the dipole surface.
- *H-field distribution:* H-field is measured with an isotropic H-field probe with 100mW forward power to the antenna feed point, in the x-y-plane. The scan area and sensor distance is equivalent to the E-field scan. The maximum of the field is available at the center (subgrid 5) above the feed point. The H-field value stated as calibration value represents the maximum of the interpolated H-field, 10mm above the dipole surface at the feed point.