



# HAC TEST REPORT

**Test Item: Summary Result HAC Category = M3**

**REPORT NO.:** HA970604L10

**MODEL NO.:** RAPH800

**RECEIVED:** Jun. 04, 2008

**TESTED:** Jun. 13, 2008

**ISSUED:** Jun. 17, 2008

**APPLICANT:** High Tech Computer Corp.

**ADDRESS:** 23, Hsin-Hua Rd., Taoyuan, 330, Taiwan, R.O.C.

**ISSUED BY:** Advance Data Technology Corporation

**LAB ADDRESS:** No. 47, 14<sup>th</sup> Ling, Chia Pau Tsuen, Lin Kou  
Hsiang 244, Taipei Hsien, Taiwan, R.O.C.

**TEST LOCATION:** No. 19, Hwa Ya 2<sup>nd</sup> Rd., Kwei Shan Hsiang,  
Taoyuan Hsien 333, Taiwan, R.O.C.

This test report consists of 33 pages in total except Appendix. It may be duplicated completely for legal use with the approval of the applicant. It should not be reproduced except in full, without the written approval of our laboratory. The client should not use it to claim product endorsement by any government agencies. The test results in the report only apply to the tested sample.



## TABLE OF CONTENTS

1.	CERTIFICATION .....	3
2.	GENERAL INFORMATION.....	4
2.1	GENERAL DESCRIPTION OF EUT .....	4
2.2	DESCRIPTION OF SUPPORT UNITS .....	4
2.3	GENERAL DESCRIPTION OF APPLIED STANDARDS.....	6
3.	GENERAL INFORMATION OF THE DASY4 SYSTEM .....	7
3.1.	GENERAL INFORMATION OF TEST EQUIPMENT.....	7
3.2.	TEST EQUIPMENT LIST.....	11
3.3.	MEASUREMENT UNCERTAINTY .....	12
3.4.	GENERAL DESCRIPTION OF THE HAC EVALUATION.....	13
4.	PERFORMANCE CATEGORIES .....	15
5.	SYSTEM CHECK.....	17
5.1.	VALIDATION STRUCTURE.....	17
5.2.	SYSTEM CHECK PROCEDURE.....	18
5.3.	VALIDATION RESULTS.....	19
6.	MODULATION FACTOR .....	20
6.1	MODULATION FACTOR TEST RESULTS.....	22
7.	RF EMISSION TEST PROCEDURES.....	26
7.1.	TEST INSTRUCTION .....	26
7.2.	TEST PROCEDURES .....	27
7.3.	DESCRIPTION OF TEST POSITION AND CONFIGURATIONS.....	28
7.4.	SUMMARY OF MEASURED HAC RESULTS.....	29
8.	INFORMATION ON THE TESTING LABORATORIES .....	33
	APPENDIX A: TEST CONFIGURATIONS AND TEST DATA	
	APPENDIX B: SYSTEM CERTIFICATE & CALIBRATION	
	APPENDIX E: TEST CONFIGURATIONS	



## 1. CERTIFICATION

**PRODUCT** : Pocket PC Phone

**MODEL NO.** : RAPH800

**APPLICANT** : High Tech Computer Corp.

**TESTED** : Jun. 13, 2008

**TEST SAMPLE** : Engineering sample

**STANDARDS** : **FCC Part 20.19**

ANSI PC63.19 2006

**TEST ITEM:** RF emissions

The above equipment (model no: RAPH800) have been tested by **Advance Data Technology Corporation**, and found compliance with the requirement of the above standards. The test record, data evaluation & Equipment Under Test (EUT) configurations represented herein are true and accurate accounts of the measurements of the sample's characteristics under the conditions specified in this report.

**PREPARED BY** : Wendy Liaw , **DATE:** Jun. 17, 2008  
Wendy Liaw / Senior Specialist

**TECHNICAL ACCEPTANCE** : James Fan , **DATE:** Jun. 17, 2008  
Responsible for RF James Fan / Engineer

**APPROVED BY** : Gary Chang , **DATE:** Jun. 17, 2008  
Gary Chang / Assistant Manager

## 2. GENERAL INFORMATION

### 2.1 GENERAL DESCRIPTION OF EUT

<b>PRODUCT</b>	Pocket PC Phone
<b>MODEL NO.</b>	RAPH800
<b>FCC ID</b>	NM8RAPH800
<b>POWER SUPPLY</b>	3.7Vdc from rechargeable lithium battery 5.0Vdc from power adapter 5.0Vdc from host equipment
<b>CLASSIFICATION</b>	Portable device, production unit
<b>MODULATION TYPE</b>	OQPSK, HPSK
<b>FREQUENCY RANGE</b>	Tx: 824.2 ~ 848.8MHz / Rx: 869.2 ~ 893.8MHz (CDMA850) Tx: 1850.2 ~ 1909.8MHz / Rx: 1930.2 ~ 1989.8MHz (CDMA1900)
<b>CHANNEL FREQUENCIES UNDER TEST AND ITS CONDUCTED OUTPUT POWER</b>	CDMA850: 24.06dBm / 824.70MHz for channel 1013 24.28dBm / 836.50MHz for channel 384 24.41dBm / 848.30MHz for channel 777 CDMA1900: 24.12dBm / 1851.25MHz for channel 25 24.23dBm / 1880.00MHz for channel 600 24.45dBm / 1908.75MHz for channel 1175
<b>HAC RATE CATEGORY</b>	M3
<b>ANTENNA TYPE</b>	PIFA antenna with 0dBi gain for CDMA850 PIFA antenna with 1dBi gain for CDMA1900
<b>DATA CABLE</b>	1.25m shielded USB cable without core 0.1m shielded USB 4-in-1 cable without core
<b>I/O PORTS</b>	Refer to user's manual
<b>ACCESSORY DEVICES</b>	Adapter, Battery, Earphone (Brand: hTC, model: HS S300, 1.9m), Pouch

#### NOTE:

- The EUT is a CDMA850/CDMA1900 (1XEVD0) Pocket PC Phone with wireless LAN and bluetooth functions.
- The communicated functions of EUT listed as below:

		850MHz	1900MHz	With WLAN 802.11b/g + BT 2.0 with EDR + AGPS
3G	CDMA	V	V	
	1*EVDO	V	V	
	1*RTT	V	V	
	IS-95A/B	V	V	

3. The EUT has Li-ion battery listed as below:

<b>BRAND:</b>	hTC
<b>MODEL:</b>	DIAM171
<b>RATING:</b>	3.7Vdc, 1340mAh

4. The EUT was operated with following power adapter:

<b>BRAND:</b>	hTC
<b>MODEL:</b>	TC P300
<b>INPUT:</b>	100-240Vac, 0.2A, 50-60Hz
<b>OUTPUT:</b>	5Vdc, 1A

5. The MEID code listed as below:

A1000007*****
---------------

6. The EUT used the same antenna for Wireless LAN & Bluetooth function, but the two functions can not work at the same time.

7. The above EUT information was declared by manufacturer and for more detailed features description, please refer to the manufacturer's specifications or User's Manual.



## 2.2 DESCRIPTION OF SUPPORT UNITS

The EUT has been tested as an independent unit together with other necessary accessories or support units. The following support units or accessories were used to form a representative test configuration during the tests.

NO.	PRODUCT	BRAND	MODEL NO.	SERIAL NO.	CALIBRATED UNTIL
1	Universal Radio Communication Tester	R&S	CMU200	101372	Nov. 25, 2008

NO.	SIGNAL CABLE DESCRIPTION OF THE ABOVE SUPPORT UNITS
1	NA

**NOTE:** All power cords of the above support units are non shielded (1.8m).

## 2.3 GENERAL DESCRIPTION OF APPLIED STANDARDS

According to the specifications of the manufacturer, this product must comply with the requirements of the following standards:

**FCC Part 20.19**

**ANSI PC63.19 – 2006**

All test items have been performed and recorded as per the above standards.



### 3. GENERAL INFORMATION OF THE DASY4 SYSTEM

#### 3.1. GENERAL INFORMATION OF TEST EQUIPMENT

**DASY4 (software 4.7 Build 53)** consists of high precision robot, probe alignment sensor, phantom, robot controller, controlled measurement server and near-field probe. The robot includes six axes that can move to the precision position of the DASY4 software defined. The DASY4 software can define the area that is detected by the probe. The robot is connected to controlled box. Controlled measurement server is connected to the controlled robot box. The DAE includes amplifier, signal multiplexing, AD converter, offset measurement and surface detection. It is connected to the Electro-optical coupler (ECO). The ECO performs the conversion from the optical into digital electric signal of the DAE and transfers data to the PC.

#### ER3DV6 E-FIELD PROBE

<b>CONSTRUCTION</b>	One dipole parallel, two dipoles normal to probe axis Built-in shielding against static charges
<b>CALIBRATION</b>	In air from 100MHz to 3.0GHz (absolute accuracy $\pm 6.0\%$ , $k = 2$ )
<b>FREQUENCY</b>	100MHz to > 6GHz; Linearity: $\pm 0.2\text{dB}$ (100MHz to 3GHz)
<b>DIRECTIVITY</b>	$\pm 0.2\text{dB}$ in air (rotation around probe axis) $\pm 0.4\text{dB}$ in air (rotation normal to probe axis)
<b>DYNAMIC RANGE</b>	2V/m to > 1000V/m (M3 or better device readings fall well below diode compression point) Linearity: $\pm 0.2\text{dB}$
<b>DIMENSIONS</b>	Overall length: 330mm (Tip: 16mm) Tip diameter: 8mm (Body: 12mm) Distance from probe tip to dipole centers: 2.5mm

### H3DV6 H-FIELD PROBE

<b>CONSTRUCTION</b>	Three concentric loop sensors with 3.8mm loop diameters Resistively loaded detector diodes for linear response Built-in shielding against static charges
<b>FREQUENCY</b>	200MHz to 3GHz (absolute accuracy $\pm 6.0\%$ , $k = 2$ ); Output linearized
<b>DIRECTIVITY</b>	$\pm 0.25\text{dB}$ (spherical isotropy error)
<b>DYNAMIC RANGE</b>	10mA/m to 2A/m at 1GHz (M3 or better device readings fall well below diode compression point)
<b>DIMENSIONS</b>	Overall length: 330mm (Tip: 40mm) Tip diameter: 6mm (Body: 12mm) Distance from probe tip to dipole centers: 3mm
<b>E-FIELD INTERFERENCE</b>	< 10% at 3GHz (for plane wave)

**NOTE:** The Probe parameters have been calibrated by the SPEAG. Please reference "APPENDIX D" for the Calibration Certification Report.

### HAC ARCH

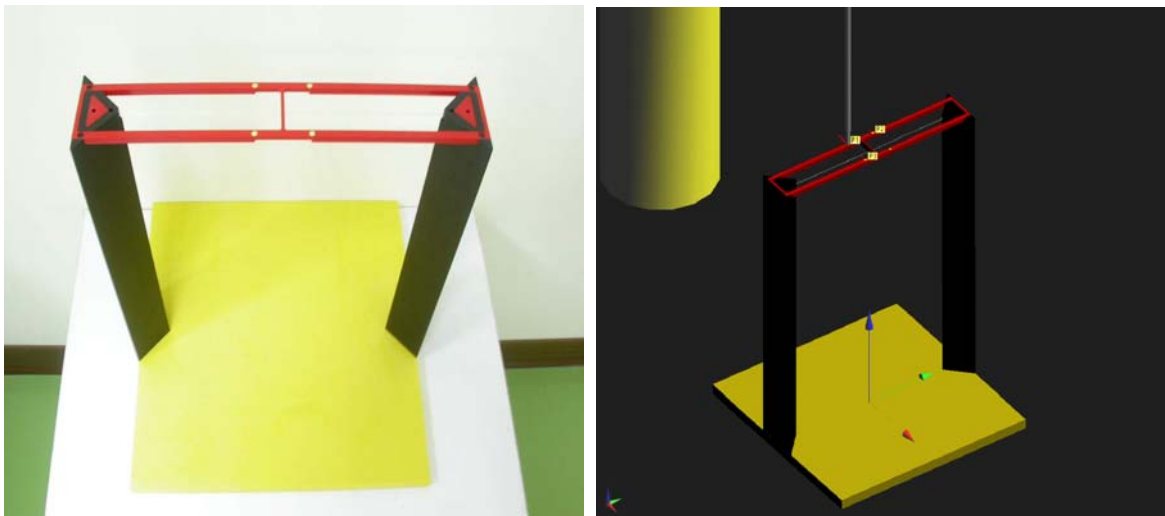

**DIMENSIONS** 370 x 370 x 370mm



## SYSTEM VALIDATION KITS:

- CD835V3**
- Frequency Band:** 800 ~ 960MHz (free space)
  - Return Loss:** > 15dB
  - Calibrated at:** 835MHz
  - Power Capability:** 50W continuous
  - Length & Height:** 166 x 330mm
- CD1880V3**
- Frequency Band:** 1710 ~ 2000MHz (free space)
  - Return Loss:** > 18dB
  - Calibrated at:** 1880MHz
  - Power Capability:** 50W continuous
  - Length & Height:** 80.8 x 330mm
- CD2450V3**
- Frequency Band:** 2250 ~ 2650MHz (free space)
  - Return Loss:** > 18dB
  - Calibrated at:** 2450MHz
  - Power Capability:** 50W continuous
  - Length & Height:** 60 x 330mm



## DEVICE HOLDER



**CONSTRUCTION** Supports accurate and reliable positioning of any phone effect on near field <math>\pm 0.5\text{dB}</math>

## DATA ACQUISITION ELECTRONICS ( DAE )



### CONSTRUCTION

The data acquisition electronics (DAE3) consists of a highly sensitive electrometer grade preamplifier with auto-zeroing, a channel and gain-switching multiplex, a fast 16 bit AD converter and a command decoder and control logic unit. Transmission to the measurement server is accomplished through an optical downlink for data and status information as well as an optical uplink for commands and the clock. The mechanical probe is mounting device includes two different sensor systems for frontal and sideways probe contacts. They are used for mechanical surface detection and probe collision detection. The input impedance of the DAE3 box is 200M $\Omega$ ; the inputs are symmetrical and floating. Common mode rejection is above 80dB.

### 3.2. TEST EQUIPMENT LIST

ITEM	NAME	BAND	TYPE	SERIES NO.	CALIBRATED UNTIL
1	SAM Phantom	S & P	SD HAC P01 BA	1034	NA
2	Robot Positioner	Staubli Unimation	NA	NA	NA
3	Signal Generator	Agilent	E8257C	MY43320668	Dec. 25, 2008
4	E-Field Probe	Speag	ER3DV6	2293	Jan. 22, 2009
5	H-Field Probe	Speag	H3DV6	6124	Jan. 22, 2009
6	DAE	Speag	DAE3 V1	510	Aug. 28, 2008
7	Validation Dipole	Speag	CD835V3	1041	May 13, 2010
			CD1880V3	1032	Jul. 17, 2008

**NOTE:** Before starting the measurement, all test equipment shall be warmed up for 30min.

### 3.3. MEASUREMENT UNCERTAINTY

HAC UNCERTAINTY BUDGET ACCORDING TO ANSI C63.19[1]							
ERROR DESCRIPTION	UNCERTAINTY VALUE	PROBABILITY DISTRIBUTION	DIVISOR	( Ci ) E	( Ci ) H	STD. UNC. E	STD. UNC. H
<b>MEASUREMENT SYSTEM</b>							
Probe calibration	±5.1%	Normal	1	1	1	±5.1%	±5.1%
Axial isotropy	±4.7%	Rectangular	√3	1	1	±2.7%	±2.7%
Sensor Displacement	±16.5%	Rectangular	√3	1	0.145	±9.5%	±1.4%
Boundary Effects	±2.4%	Rectangular	√3	1	1	±1.4%	±1.4%
Linearity	±4.7%	Rectangular	√3	1	1	±2.7%	±2.7%
Scaling to Peak Envelope Power	±2.0%	Rectangular	√3	1	1	±1.2%	±1.2%
System Detection Limit	±1.0%	Rectangular	√3	1	1	±0.6%	±0.6%
Readout Electronics	±0.3%	Rectangular	√3	1	1	±0.3%	±0.3%
Response Time	±0.8%	Rectangular	√3	1	1	±0.5%	±0.5%
Integration Time	±2.6%	Rectangular	√3	1	1	±1.5%	±1.5%
RF Ambient Condition	±3.0%	Rectangular	√3	1	1	±1.7%	±1.7%
RF Reflections	±12.0%	Rectangular	√3	1	1	±6.9%	±6.9%
Probe Positioner	±1.2%	Rectangular	√3	1	0.67	±0.7%	±0.5%
Probe Positioning	±4.7%	Rectangular	√3	1	0.67	±2.7%	±1.8%
Extrap. And Interpolation	±1.0%	Rectangular	√3	1	1	±0.6%	±0.6%
<b>TEST SAMPLE RELATED</b>							
Device Positioning Vertical	±4.7%	Rectangular	√3	1	0.67	±2.7%	±1.8%
Device Positioning Lateral	±1.0%	Rectangular	√3	1	1	±0.6%	±0.6%
Device Holder and Phantom	±2.4%	Rectangular	√3	1	1	±1.4%	±1.4%
Power Drift	±5.0%	Rectangular	√3	1	1	±2.9%	±2.9%
<b>PHANTOM AND SETUP RELATED</b>							
Phantom Thickness	±2.4%	Rectangular	√3	1	0.67	±1.4%	±0.9%
<b>COMBINED STD. UNCERTAINTY</b>						±14.7%	±10.9%
<b>EXPANDED STD. UNCERTAINTY ON POWER</b>						±29.4%	±21.8%
<b>EXPANDED STD. UNCERTAINTY ON FIELD</b>						±14.7%	±10.9%

**NOTE:** Worst-case uncertainty budget for HAC free field assessment according to ANSI C63.19 [1]. The budget is valid for the frequency range 800MHz ~ 3GHz and represents a worst-case analysis. For specific tests and configurations, the uncertainty could be considerably smaller.

### 3.4. GENERAL DESCRIPTION OF THE HAC EVALUATION

The DASY4 post-processing software (SEMCAD) automatically executes the following procedures to calculate the field units from the micro-volt readings at the probe connector. The parameters used in the evaluation are stored in the configuration modules of the software:

Probe parameters: - Sensitivity	Norm <sub>i</sub> , a <sub>i0</sub> , a <sub>i1</sub> , a <sub>i2</sub>
- Conversion factor	ConvF <sub>i</sub>
- Diode compression point	dcp <sub>i</sub>
Device parameters: - Frequency	F
- Crest factor	Cf

The first step of the evaluation is a linearization of the filtered input signal to account for the compression characteristics of the detector diode. The compensation depends on the input signal, the diode type and the DC-transmission factor from the diode to the evaluation electronics. If the exciting field is pulsed, the crest factor of the signal must be known to correctly compensate for peak power. The formula for each channel can be given as:

$$V_i = U_i + U_i^2 \cdot \frac{cf}{dcp_i}$$

V <sub>i</sub> = compensated signal of channel i	(i = x, y, z)
U <sub>i</sub> = input signal of channel i	(i = x, y, z)
Cf = crest factor of exciting field	(DASY parameter)
dcp <sub>i</sub> = diode compression point	(DASY parameter)

From the compensated input signals the primary field data for each channel can be evaluated:

$$\mathbf{E\text{-field probes: } E_i = \sqrt{\frac{V_i}{\text{Norm}_i \cdot \text{Conv}F}}$$

$$\mathbf{H\text{-field probes: } H_i = \sqrt{V_i} \cdot \frac{a_{i0} + a_{i1}f + a_{i2}f^2}{f}}$$

$V_i$  = compensated signal of channel  $i$  ( $i = x, y, z$ )

$\text{Norm}_i$  = sensor sensitivity of channel  $i$   $\mu\text{V}/(\text{V/m})^2$  for E-field Probes ( $i = x, y, z$ )

$\text{Conv}F$  = sensitivity enhancement in solution

$a_{ij}$  = sensor sensitivity factors for H-field probes

$F$  = carrier frequency [GHz]

$E_i$  = electric field strength of channel  $i$  in V/m

$H_i$  = magnetic field strength of channel  $i$  in A/m

The RSS value of the field components gives the total field strength (Hermitian magnitude):

$$E_{tot} = \sqrt{E_x^2 + E_y^2 + E_z^2}$$

The primary field data are used to calculate the derived field units.

$E$  = field strength in V/m

$E_{tot}$  = total field strength in V/m

**NOTE:** The signal response time is evaluated as the time required by the system to reach 90% of the expected final value after an on/off switch of the power source with an integration time of 500ms and a probe response time of < 5ms. In the current implementation, DASY4 waits longer than 100ms after having reached the grid point before starting a measurement, i.e., the response time uncertainty is negligible.

## 4. PERFORMANCE CATEGORIES

The ANSI Standard presents performance requirements for acceptable interoperability of hearing aids with wireless communications devices. When these parameters are met, a hearing aid operates acceptably in close proximity to a wireless communications device.

CATEGORY NEAR FIELD	TELEPHONE RF PARAMETERS < 960MHz				
	AWF	E-FIELD EMISSION CW (dBV/m)	E-FIELD EMISSION CW (V/m)	H-FIELD EMISSION CW (dBA/m)	H-FIELD EMISSION CW (A/m)
M1	0	56.0 to 61.0	631.0 to 1122.0	5.6 to 10.6	1.91 to 3.39
	-5	53.5 to 58.5	473.2 to 841.4	3.1 to 8.1	1.43 to 2.54
M2	0	51.0 to 56.0	354.8 to 631.0	0.6 to 5.6	1.07 to 1.91
	-5	48.5 to 53.5	266.1 to 473.2	-1.9 to 3.1	0.80 to 1.43
M3	0	46.0 to 51.0	199.5 to 354.8	-4.4 to 0.6	0.60 to 1.07
	-5	43.5 to 48.5	149.6 to 266.1	-6.9 to -1.9	0.45 to 0.80
M4	0	< 46.0	< 199.5	< -4.4	< 0.60
	-5	< 43.5	< 149.6	< -6.9	< 0.45

CATEGORY NEAR FIELD	TELEPHONE RF PARAMETERS > 960MHz				
	AWF	E-FIELD EMISSION CW (dBV/m)	E-FIELD EMISSION CW (V/m)	H-FIELD EMISSION CW (dBA/m)	H-FIELD EMISSION CW (A/m)
M1	0	46.0 to 51.0	199.5 to 354.8	-4.4 to 0.6	0.60 to 1.07
	-5	43.5 to 48.5	149.6 to 266.1	-6.9 to -1.9	0.45 to 0.80
M2	0	41.0 to 46.0	112.2 to 199.5	-9.4 to -4.4	0.34 to 0.60
	-5	48.5 to 53.5	84.1 to 149.6	-11.9 to -6.9	0.25 to 0.45
M3	0	36.0 to 41.0	63.1 to 112.2	-14.4 to -9.4	0.19 to 0.34
	-5	33.5 to 38.5	47.3 to 84.1	-16.9 to -11.9	0.14 to 0.25
M4	0	< 36.0	< 63.1	< -14.4	< 0.19
	-5	< 33.5	< 47.3	< -16.9	< 0.14



## ARTICULATION WEIGHING FACTOR (AWF)

The following AWF factors shall be used for the standard transmission protocols:

STANDARD	TECHNOLOGY	AWF (dB)
TIA/EIA/IS-2000	CDMA	0
TIA/EIA-136	TDMA (50Hz)	0
iDENTM	TDMA (22 and 11Hz)	0
J-STD-007	GSM (217)	-5
T1/T1P1/3GPP	UMTS (WCDMA)	0



## 5. SYSTEM CHECK

The measured values (E-field and H-field) were compared with the values provided by the probe manufacturer and must within the allowed tolerance of **25%**.

### 5.1. VALIDATION STRUCTURE

The input signal was an un-modulated continuous wave. The following points were taken into consideration in performing this check:

- Average Input Power  $P = 100\text{mW RMS}$  ( $20\text{dBm RMS}$ ) after adjustment for return loss
- The test fixture must meet the 2 wavelength separation criterion
- The proper measurement of the 1cm probe to dipole separation, which is measured from top surface of the dipole to the calibration reference point of the sensor, defined by the probe manufacturer is shown in the following diagram:

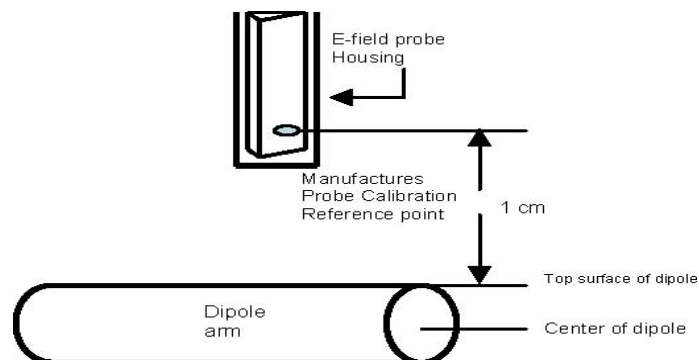

## 5.2. SYSTEM CHECK PROCEDURE

1. Before you start the system performance check, need only to tell the system with which components (probe type, validation dipole and HAC arch) are performing the system performance check; the system will take care of all parameters.

The system check configuration is shown in the following figure:

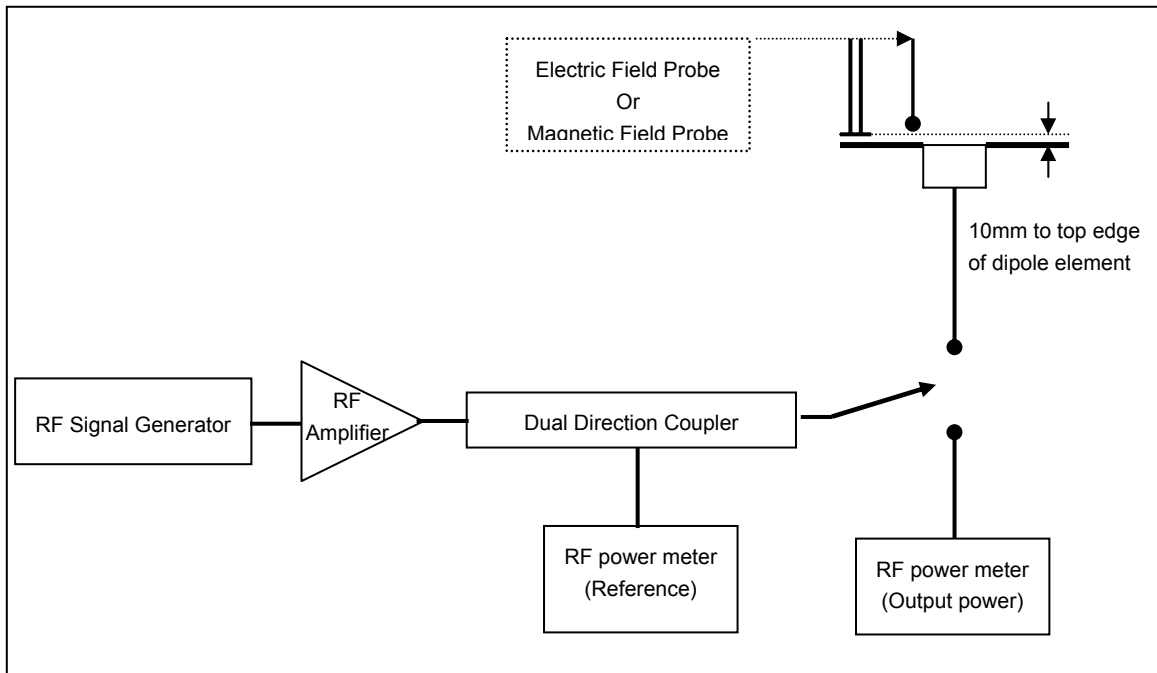

2. The dipole was energized with a 20dBm unmodulated continuous-wave signal.
3. The length of the dipole was scanned with both E-field and H-field probes and the maximum values for each were recorded.



### 5.3. VALIDATION RESULTS

SYSTEM CHECK						
TEST FREQUENCY (MHz)	BEGIN TEST SG POWER (mW)	REQUIRED E-FILED (V/m)	MEASURED E-FILED (V/m)	DEVIATION (%)	SEPARATION DISTANCE (mm)	TESTED DATE
835	100.0	161.7	160.3	-0.87	10	Jun. 13, 2008
1880	100.0	137.4	129.7	-5.60	10	Jun. 13, 2008
TEST FREQUENCY (MHz)	BEGIN TEST SG POWER (mW)	REQUIRED H-FILED (V/m)	MEASURED H-FILED (V/m)	DEVIATION (%)	SEPARATION DISTANCE (mm)	TESTED DATE
835	100.0	0.457	0.456	-0.22	10	Jun. 13, 2008
1880	100.0	0.454	0.437	-3.74	10	Jun. 13, 2008
<b>TESTED BY</b>	Sam Onn					

**NOTE:** Please see Appendix for the system validation test data.

## 6. MODULATION FACTOR

A calibration was made of the modulation response of the probe and its instrumentation chain. This calibration was performed with the field probe, attached to its instrumentation. The response of the probe system to a CW field at the frequency of interest is compared to its response to a modulated signal with equal peak amplitude to that of a CW signal. The field level of the test signals are ensured to be more than 10dB above the ambient level and the noise floor of the instrumentation being used. The ratio of the CW reading to that taken with a modulated reading was applied to the DUT measurements.

### **This was done using the following procedure:**

1. Fixing the probe in a set location relative to a field generating device, such as a reference dipole antenna, as illustrated in the system check procedure.
2. Illuminate the probe using the wireless device connected to the reference dipole with a test signal at the intended measurement frequency, Ensure there is sufficient field coupling between the probe and the antenna so the resulting reading is greater than 10dB above the probe system noise floor but within the systems operating range.
3. Record the amplitude applied to the antenna during transmission and the field strength measured by the E-field probe located near the tip of the dipole antenna.
4. Replace the wireless device with an RF signal generator producing an unmodulated CW signal and set to the wireless device operating frequency.
5. Set the amplitude of the unmodulated signal to equal that recorded from the wireless device.
6. Record the reading of the probe measurement system of the unmodulated signal.
7. The RF signal generator producing an 80%AM signal and set to the wireless device operating frequency. Set the amplitude of the signal to equal that recorded from the wireless device.



8. Record the reading of the probe measurement system of the 80%AM signal.
9. The ratio, in linear units, of the probe reading in Step 3) or 8) to the reading in Step 6) is the E-field modulation factor.
10. Steps 1-9 were repeated at all frequency bands and for both E and H field probes.

**NOTE:** The ratio of the CW to modulated signal reading is the modulation factor. The modulation factors obtained were applied to readings taken of the actual wireless device, in order to obtain an accurate peak field reading using the formula:

$$\text{Peak} = 20 \cdot \log(\text{Raw} \cdot \text{ProbeModulationFactor})$$



## 6.1 MODULATION FACTOR TEST RESULTS

TEST FREQUENCY (MHz)	PROTOCOL	REFERENCE LEVEL	MEASURED E-FILED (V/m)	E-FILED MODULATION FACTOR	TESTED DATE
836.5	CW	Refer to the next three plots	165.7	NA	Jun. 13, 2008
	80% AM		150.5	1.10	
	CDMA		171.1	0.97	
TEST FREQUENCY (MHz)	PROTOCOL	REFERENCE LEVEL	MEASURED H-FILED (A/m)	H-FILED MODULATION FACTOR	TESTED DATE
836.5	CW	Refer to the next three plots	0.468	NA	Jun. 13, 2008
	80% AM		0.475	0.99	
	CDMA		0.498	0.94	
<b>TESTED BY</b>	Sam Onn				

### CW SIGNAL:

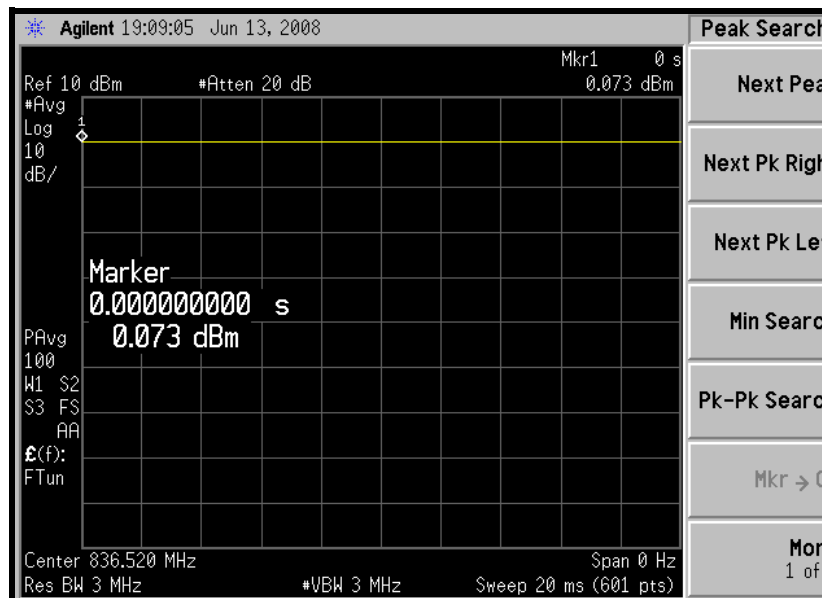

**80% AM SIGNAL:**

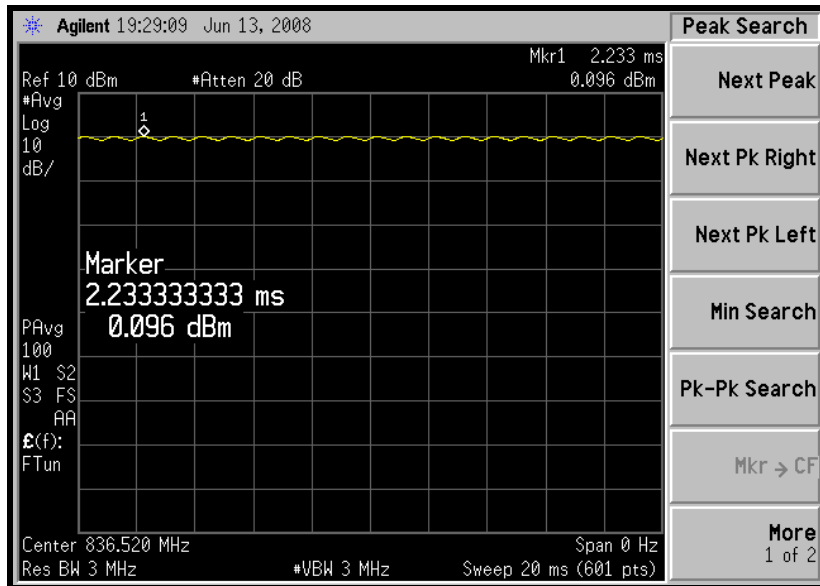

**CDMA SIGNAL:**

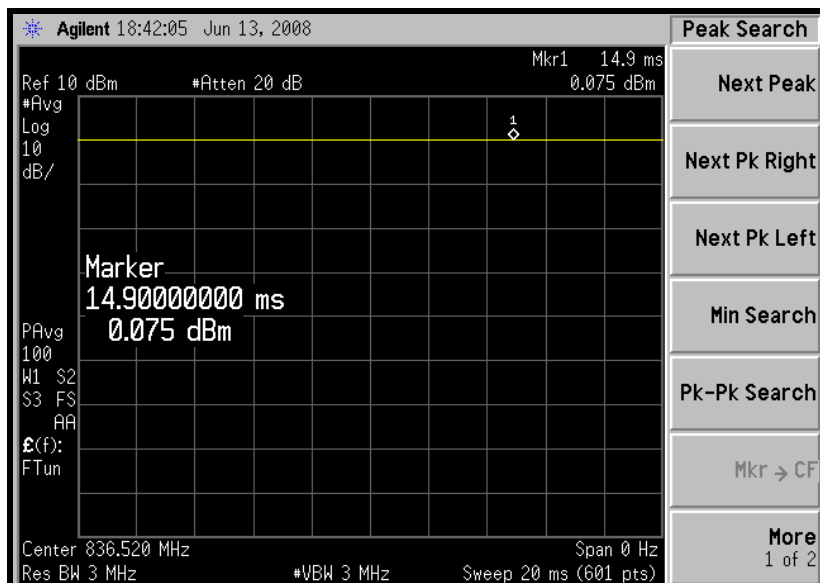



TEST FREQUENCY (MHz)	PROTOCOL	REFERENCE LEVEL	MEASURED E-FILED (V/m)	E-FILED MODULATION FACTOR	TESTED DATE
1880.0	CW	Refer to the next three plots	125.6	NA	Jun. 13, 2008
	80% AM		112.3	1.12	
	CDMA		128.4	0.98	
TEST FREQUENCY (MHz)	PROTOCOL	REFERENCE LEVEL	MEASURED H-FILED (A/m)	H-FILED MODULATION FACTOR	TESTED DATE
1880.0	CW	Refer to the next three plots	0.441	NA	Jun. 13, 2008
	80% AM		0.429	1.03	
	CDMA		0.473	0.93	
<b>TESTED BY</b>	Sam Onn				

**CW SIGNAL:**

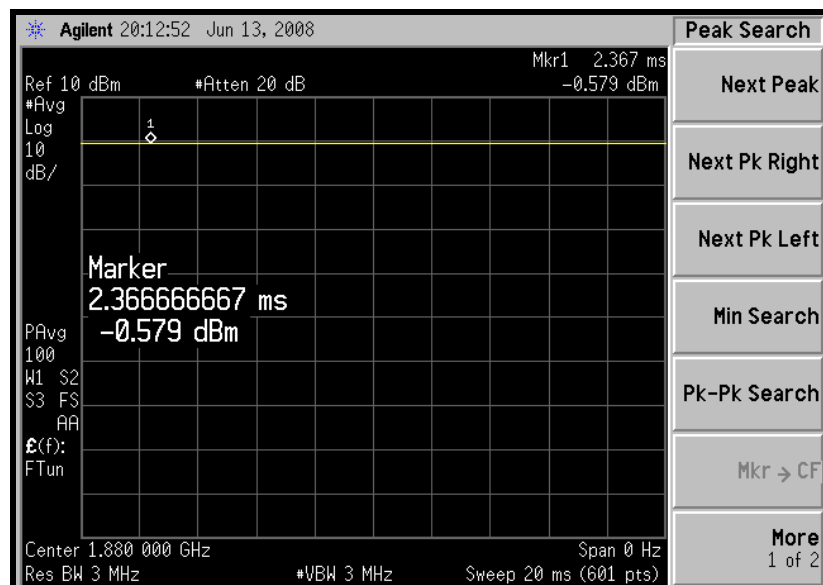



**80% AM SIGNAL:**

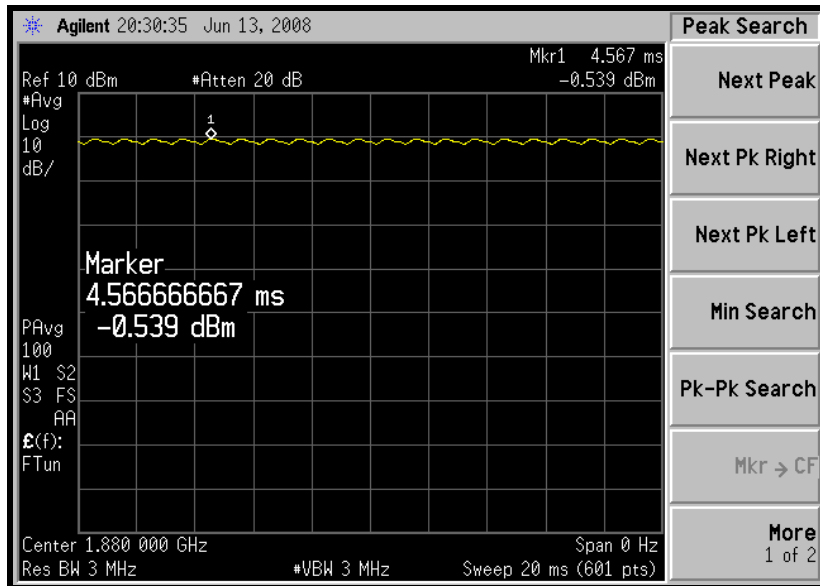

**CDMA SIGNAL:**

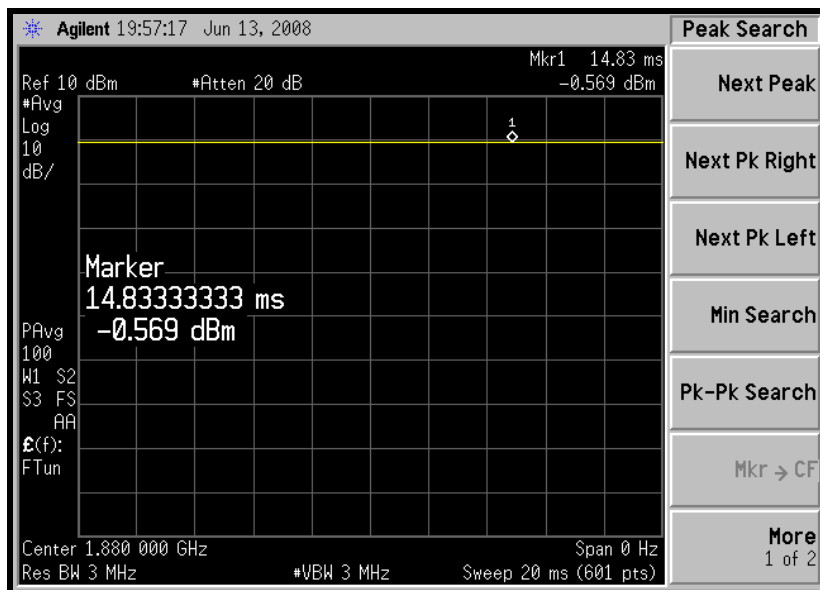

## 7. RF EMISSION TEST PROCEDURES

### 7.1. TEST INSTRUCTION

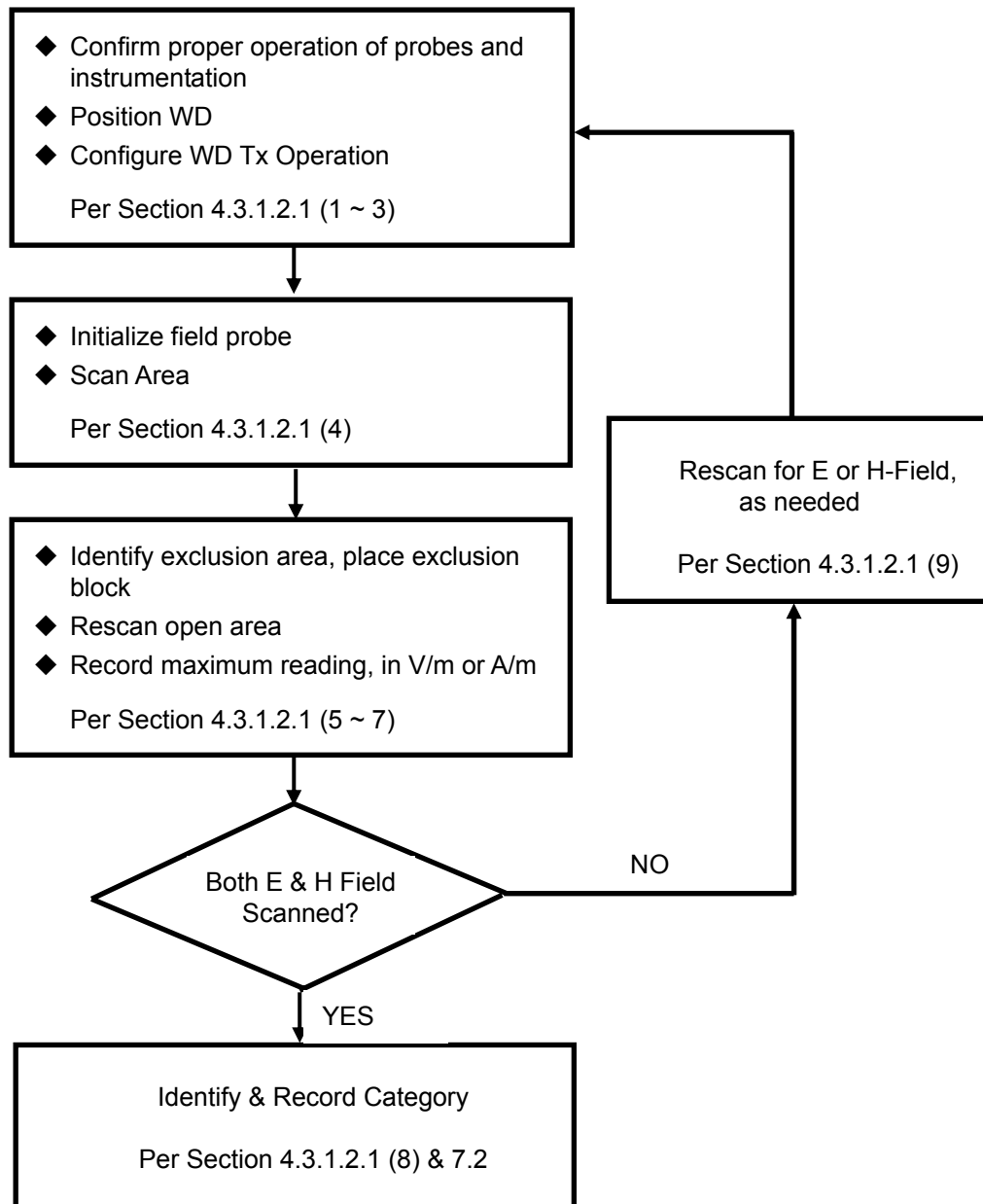

## 7.2. TEST PROCEDURES

The EUT (Pocket PC Phone) makes a phone call to the GSM base station. Establish the simulation communication configuration rather the actual communication. Then the EUT could continuous the transmission mode. Adjust the PCL of the base station could controlled the EUT to transmitted the maximum output power. The base station also could control the transmission channel.

The recommended procedure for assessing the RF emission value consists of the following steps:

1. Proper operation of the field probe, probe measurement system, other instrumentation, and the positioning system was confirmed.
  2. WD is positioned in its intended test position, acoustic output point of the device perpendicular to the field probe.
  3. The center sub-grid was centered over the center of the acoustic output (also audio band magnetic output, if applicable). The WD audio output was positioned tangent (as physically possible) to the measurement plane.
  4. A surface calibration was performed before each setup change to ensure repeatable spacing and proper maintenance of the measurement plane using the HAC arch.
  5. The measurement system measured the field strength at the reference location.
  6. Measurements at 2mm increments in the 5 x 5cm region were performed and recorded. A 360° rotation about the azimuth axis at the maximum interpolated position was measured. For the worst-case condition, the peak reading from this rotation was used in re-evaluating the HAC category.
  7. Steps 1-6 were done for both the E and H-Field measurements.
-

### 7.3. DESCRIPTION OF TEST POSITION AND CONFIGURATIONS

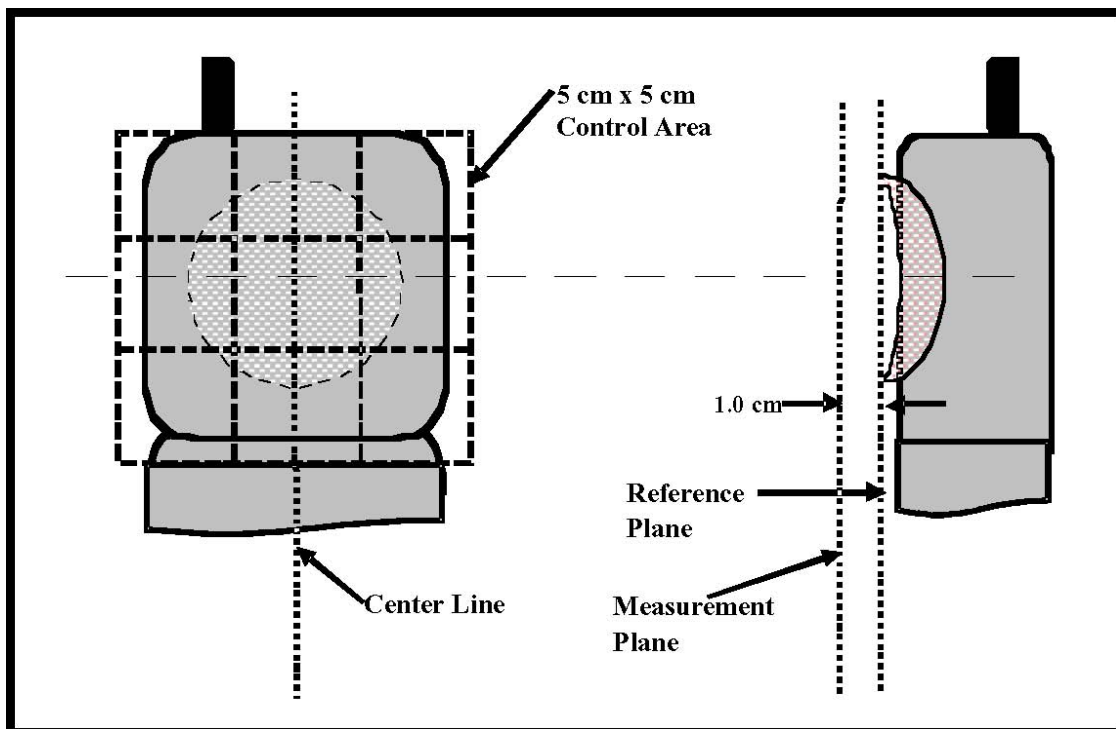

## 7.4. SUMMARY OF MEASURED HAC RESULTS

### E-FIELD EMISSION

<b>ENVIRONMENTAL CONDITION</b>			Air Temperature : 22.8°C, Humidity : 65%RH					
<b>TESTED BY</b>			Sam Onn		<b>DATE</b>		Jun. 13, 2008	
FREQ. (MHz)	CHAN.	MODE	CONDUCTED POWER (dBm)	DRIFT (dB)	MEASURED PMF	EXCLUDED CELLS	PEAK FIELD (V/m)	RATING
824.70 (Low)	1013	CDMA850	24.06	-0.077	0.97	6.8.9	50.7	M4
836.50 (Mid.)	384	CDMA850	24.28	-0.048		6.8.9	56.0	M4
848.30 (High)	777	CDMA850	24.41	-0.200		6.8.9	64.7	M4
848.30 (High)	777	CDMA850 (Light off)	24.41	-0.002		6.8.9	62.5	M4

**NOTE:**

1. The LCD back-light "ON" & battery A are the worst case for measurement.
2. Please see the Appendix A for the measured data and test plots.
3. The variation of the EUT conducted power measured before and after HAC testing should not over 5%.

<b>ENVIRONMENTAL CONDITION</b>			Air Temperature : 22.8°C, Humidity : 65%RH					
<b>TESTED BY</b>			Sam Onn		<b>DATE</b>		Jun. 13, 2008	
FREQ. (MHz)	CHAN.	MODE	CONDUCTED POWER (dBm)	DRIFT (dB)	MEASURED PMF	EXCLUDED CELLS	PEAK FIELD (V/m)	RATING
1851.25 (Low)	25	CDMA1900	24.12	-0.039	0.98	7.8.9	60.6	M4
1880.00 (Mid.)	600	CDMA1900	24.23	-0.007		7.8.9	65.0	M3
1908.75 (High)	1175	CDMA1900	24.45	-0.118		7.8.9	67.6	M3
1908.75 (High)	1175	CDMA1900 (Light off)	24.45	-0.002		7.8.9	64.0	M3

**NOTE:**

1. The LCD back-light "ON" & battery A are the worst case for measurement.
2. Please see the Appendix A for the measured data and test plots.
3. The variation of the EUT conducted power measured before and after HAC testing should not over 5%.



### H-FIELD EMISSION

<b>ENVIRONMENTAL CONDITION</b>		Air Temperature : 22.8°C, Humidity : 65%RH						
<b>TESTED BY</b>		Sam Onn			<b>DATE</b>		Jun. 13, 2008	
FREQ. (MHz)	CHAN.	MODE	CONDUCTED POWER (dBm)	DRIFT (dB)	MEASURED PMF	EXCLUDED CELLS	PEAK FIELD (A/m)	RATING
824.70 (Low)	1013	CDMA850	24.06	-0.067	0.94	2.3.6	0.159	M4
836.50 (Mid.)	384	CDMA850	24.28	-0.086		2.3.6	0.162	M4
848.30 (High)	777	CDMA850	24.41	-0.084		2.3.6	0.176	M4
848.30 (High)	777	CDMA850 (Light off)	24.41	-0.102		2.3.6	0.171	M4

**NOTE:**

1. The LCD back-light "ON" & battery A are the worst case for measurement.
2. Please see the Appendix A for the measured data and test plots.
3. The variation of the EUT conducted power measured before and after HAC testing should not over 5%.

<b>ENVIRONMENTAL CONDITION</b>		Air Temperature : 22.8°C, Humidity : 65%RH						
<b>TESTED BY</b>		Sam Onn			<b>DATE</b>	Jun. 13, 2008		
FREQ. (MHz)	CHAN.	MODE	CONDUCTED POWER (dBm)	DRIFT (dB)	MEASURED PMF	EXCLUDED CELLS	PEAK FIELD (A/m)	RATING
1851.25 (Low)	25	CDMA1900	24.12	-0.211	0.93	2.3.6	0.198	M3
1880.00 (Mid.)	600	CDMA1900	24.23	-0.124		2.3.6	0.221	M3
1908.75 (High)	1175	CDMA1900	24.45	-0.156		2.3.6	0.225	M3
1908.75 (High)	1175	CDMA1900 (Light off)	24.45	-0.137		2.3.6	0.227	M3

**NOTE:**

1. The LCD back-light "ON" & battery A are the worst case for measurement.
2. Please see the Appendix A for the measured data and test plots.
3. The variation of the EUT conducted power measured before and after HAC testing should not over 5%.





## 8. INFORMATION ON THE TESTING LABORATORIES

We, ADT Corp., were founded in 1988 to provide our best service in EMC, Radio, Telecom and Safety consultation. Our laboratories are accredited and approved by the following approval agencies according to ISO/IEC 17025.

<b>USA</b>	FCC, UL, A2LA
<b>GERMANY</b>	TUV Rheinland
<b>JAPAN</b>	VCCI
<b>NORWAY</b>	NEMKO
<b>CANADA</b>	INDUSTRY CANADA , CSA
<b>R.O.C.</b>	TAF, BSMI, NCC
<b>NETHERLANDS</b>	Telefication
<b>SINGAPORE</b>	GOST-ASIA (MOU)
<b>RUSSIA</b>	CERTIS (MOU)

Copies of accreditation certificates of our laboratories obtained from approval agencies can be downloaded from our web site:

[www.adt.com.tw/index.5/phtml](http://www.adt.com.tw/index.5/phtml). If you have any comments, please feel free to contact us at the following:

**Linko EMC/RF Lab:**

Tel: 886-2-26052180

Fax: 886-2-26051924

**Hsin Chu EMC/RF Lab:**

Tel: 886-3-5935343

Fax: 886-3-5935342

**Hwa Ya EMC/RF/Safety/Telecom Lab:**

Tel: 886-3-3183232

Fax: 886-3-3185050

**Web Site:** [www.adt.com.tw](http://www.adt.com.tw)

The address and road map of all our labs can be found in our web site also.

Test Laboratory: Advance Data Technology

### E-CDMA850-Ch1013

**DUT: Pocket PC Phone ; Type: RAPH800 ; Test Frequency: 824.7 MHz**

Communication System: CDMA ; Frequency: 824.7 MHz ; Duty Cycle: 1:1 Modulation type: OQPSK

Medium: Air Medium parameters used:  $\sigma = 0$  mho/m,  $\epsilon_r = 1$ ;  $\rho = 1000$  kg/m<sup>3</sup> ;

Phantom section: E Device Section ;

Measurement Standard: DASY4 (High Precision Assessment);

DASY4 Configuration:

- Probe: ER3DV6 - SN2293 ; ConvF(1, 1, 1) ; Calibrated: 2007/1/23

- Sensor-Surface: (Fix Surface)

- Electronics: DAE3 Sn510; Calibrated: 2007/8/29

- Phantom: HAC Test Arch; Type: SD HAC P01 BA;

- Measurement SW: DASY4, V4.7 Build 53; Postprocessing SW: SEMCAD, V1.8 Build 172

### E Scan - ER probe center 10mm above Device Reference Low Channel 1013/Hearing Aid Compatibility Test (101x101x1): Measurement grid: dx=5mm, dy=5mm

Maximum value of peak Total field = **50.7** V/m

Probe Modulation Factor = 0.970

Reference Value = 41.8 V/m; Power Drift = -0.077 dB

**Hearing Aid Near-Field Category: M4 (AWF 0 dB)**

Peak E-field in V/m

Grid 1	Grid 2	Grid 3
<b>27.9</b>	<b>44.2</b>	<b>46.5</b>
Grid 4	Grid 5	Grid 6
<b>33.1</b>	<b>50.7</b>	<b>51.4</b>
Grid 7	Grid 8	Grid 9
<b>42.0</b>	<b>53.1</b>	<b>53.1</b>

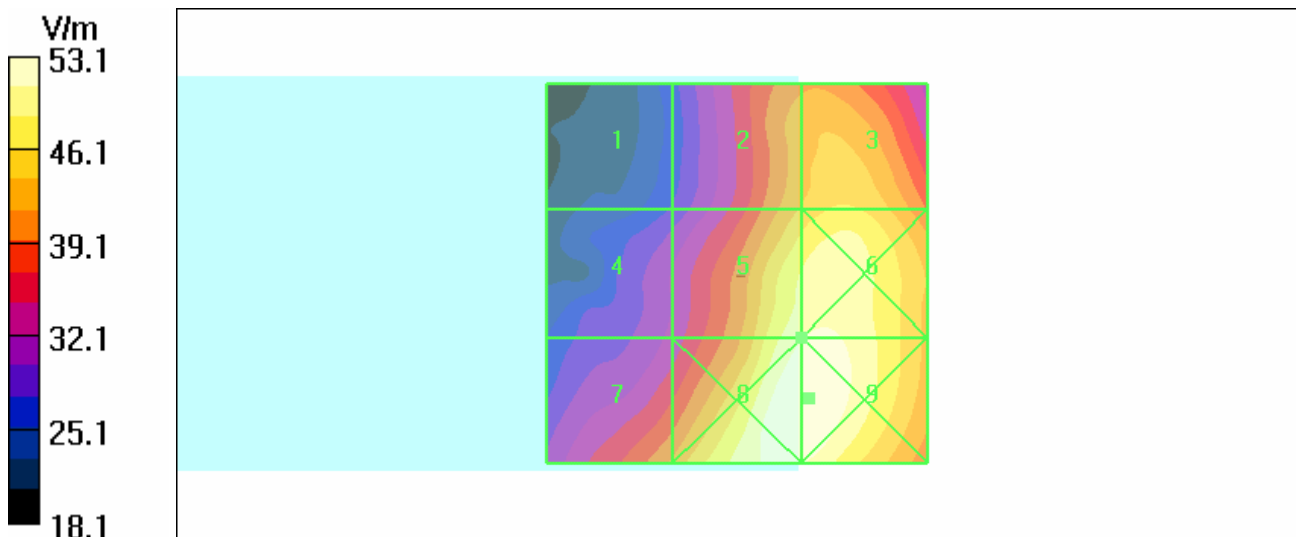

Test Laboratory: Advance Data Technology

**E-CDMA850-Ch384**

**DUT: Pocket PC Phone ; Type: RAPH800 ; Test Frequency: 836.5 MHz**

Communication System: CDMA ; Frequency: 836.5 MHz ; Duty Cycle: 1:1 Modulation type: OQPSK

Medium: Air Medium parameters used:  $\sigma = 0$  mho/m,  $\epsilon_r = 1$ ;  $\rho = 1000$  kg/m<sup>3</sup> ;

Phantom section: E Device Section ;

Measurement Standard: DASY4 (High Precision Assessment);

DASY4 Configuration:

- Probe: ER3DV6 - SN2293 ; ConvF(1, 1, 1) ; Calibrated: 2007/1/23

- Sensor-Surface: (Fix Surface)

- Electronics: DAE3 Sn510; Calibrated: 2007/8/29

- Phantom: HAC Test Arch; Type: SD HAC P01 BA;

- Measurement SW: DASY4, V4.7 Build 53; Postprocessing SW: SEMCAD, V1.8 Build 172

**E Scan - ER probe center 10mm above Device Reference Mid Channel 384/Hearing Aid Compatibility Test (101x101x1):** Measurement grid: dx=5mm, dy=5mm

Maximum value of peak Total field = **56.0** V/m

Probe Modulation Factor = 0.970

Reference Value = 47.6 V/m; Power Drift = -0.048 dB

**Hearing Aid Near-Field Category: M4 (AWF 0 dB)**

Peak E-field in V/m

Grid 1	Grid 2	Grid 3
<b>33.5</b>	<b>48.9</b>	<b>50.0</b>
Grid 4	Grid 5	Grid 6
<b>38.4</b>	<b>56.0</b>	<b>56.2</b>
Grid 7	Grid 8	Grid 9
<b>47.3</b>	<b>58.1</b>	<b>58.1</b>

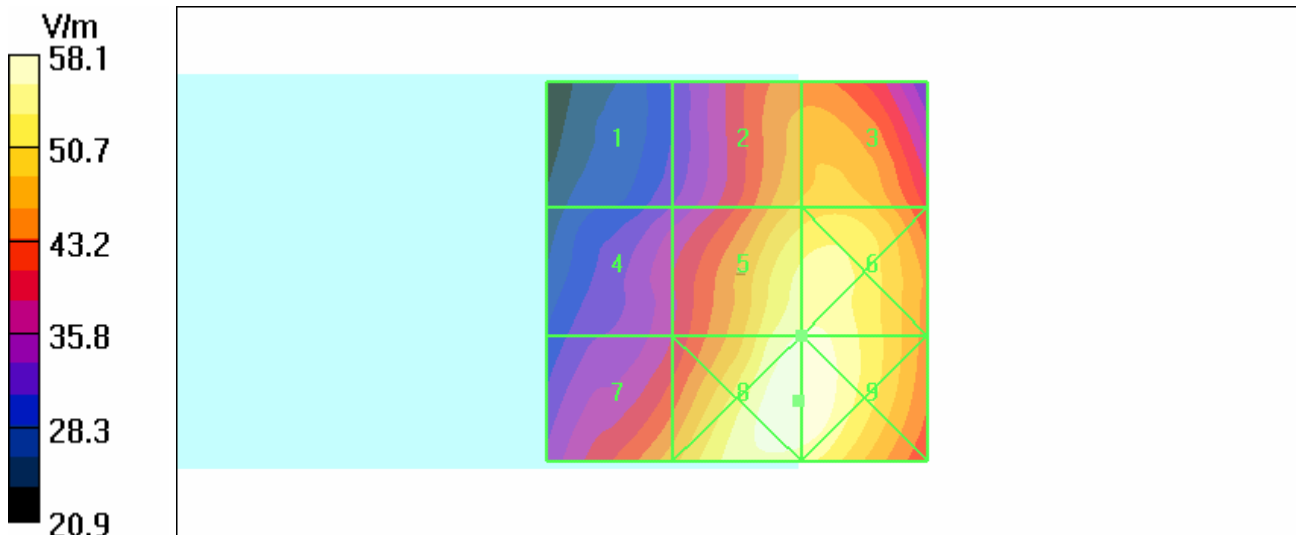

Test Laboratory: Advance Data Technology

**E-CDMA850-Ch777**

**DUT: Pocket PC Phone ; Type: RAPH800 ; Test Frequency: 848.3 MHz**

Communication System: CDMA ; Frequency: 848.3 MHz ; Duty Cycle: 1:1 Modulation type: OQPSK

Medium: Air Medium parameters used:  $\sigma = 0$  mho/m,  $\epsilon_r = 1$ ;  $\rho = 1000$  kg/m<sup>3</sup> ;

Phantom section: E Device Section ;

Measurement Standard: DASY4 (High Precision Assessment);

DASY4 Configuration:

- Probe: ER3DV6 - SN2293 ; ConvF(1, 1, 1) ; Calibrated: 2007/1/23

- Sensor-Surface: (Fix Surface)

- Electronics: DAE3 Sn510; Calibrated: 2007/8/29

- Phantom: HAC Test Arch; Type: SD HAC P01 BA;

- Measurement SW: DASY4, V4.7 Build 53; Postprocessing SW: SEMCAD, V1.8 Build 172

**E Scan - ER probe center 10mm above Device Reference High Channel 777/Hearing Aid Compatibility Test (101x101x1):** Measurement grid: dx=5mm, dy=5mm

Maximum value of peak Total field = **64.7** V/m

Probe Modulation Factor = 0.970

Reference Value = 56.8 V/m; Power Drift = -0.20 dB

**Hearing Aid Near-Field Category: M4 (AWF 0 dB)**

Peak E-field in V/m

Grid 1	Grid 2	Grid 3
<b>40.5</b>	<b>56.4</b>	<b>57.7</b>
Grid 4	Grid 5	Grid 6
<b>46.5</b>	<b>64.7</b>	<b>64.9</b>
Grid 7	Grid 8	Grid 9
<b>55.6</b>	<b>67.3</b>	<b>67.1</b>

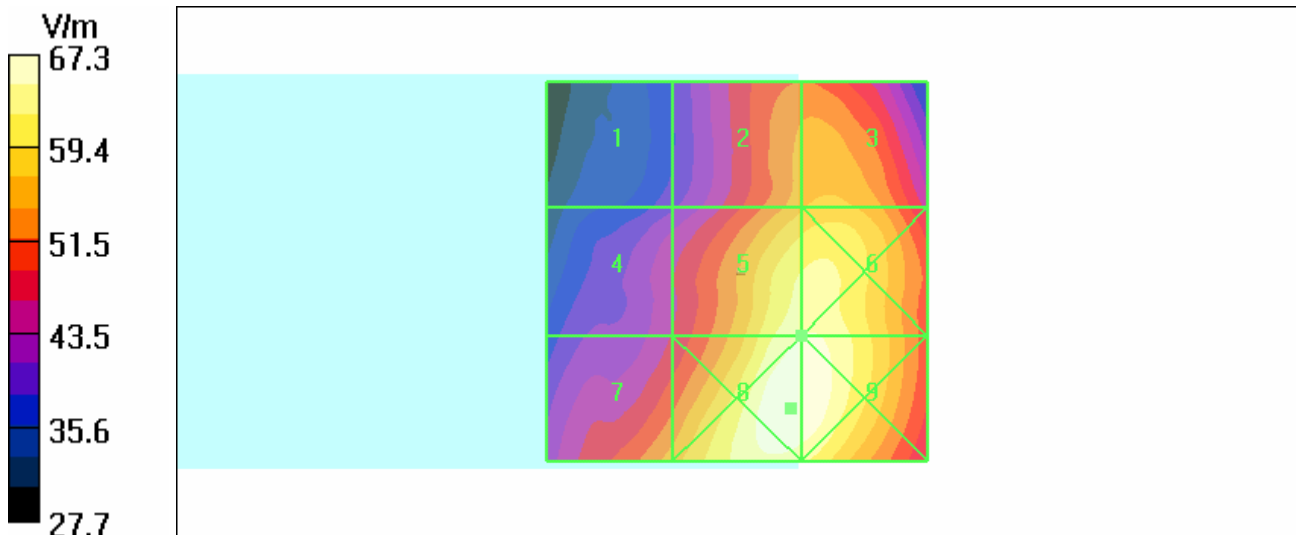

Test Laboratory: Advance Data Technology

**E-CDMA850-Ch777 (Light Off)**

**DUT: Pocket PC Phone ; Type: RAPH800 ; Test Frequency: 848.3 MHz**

Communication System: CDMA ; Frequency: 848.3 MHz ; Duty Cycle: 1:1 Modulation type: OQPSK

Medium: Air Medium parameters used:  $\sigma = 0$  mho/m,  $\epsilon_r = 1$ ;  $\rho = 1000$  kg/m<sup>3</sup> ;

Phantom section: E Device Section ;

Measurement Standard: DASY4 (High Precision Assessment);

DASY4 Configuration:

- Probe: ER3DV6 - SN2293 ; ConvF(1, 1, 1) ; Calibrated: 2007/1/23

- Sensor-Surface: (Fix Surface)

- Electronics: DAE3 Sn510; Calibrated: 2007/8/29

- Phantom: HAC Test Arch; Type: SD HAC P01 BA;

- Measurement SW: DASY4, V4.7 Build 53; Postprocessing SW: SEMCAD, V1.8 Build 172

**E Scan - ER probe center 10mm above Device Reference Mid Channel 777/Hearing Aid Compatibility Test (101x101x1):** Measurement grid: dx=5mm, dy=5mm

Maximum value of peak Total field = **62.5** V/m

Probe Modulation Factor = 0.970

Reference Value = 54.0 V/m; Power Drift = -0.002 dB

**Hearing Aid Near-Field Category: M4 (AWF 0 dB)**

Peak E-field in V/m

Grid 1	Grid 2	Grid 3
<b>38.4</b>	<b>54.9</b>	<b>55.7</b>
Grid 4	Grid 5	Grid 6
<b>44.1</b>	<b>62.5</b>	<b>62.8</b>
Grid 7	Grid 8	Grid 9
<b>53.2</b>	<b>65.0</b>	<b>64.9</b>

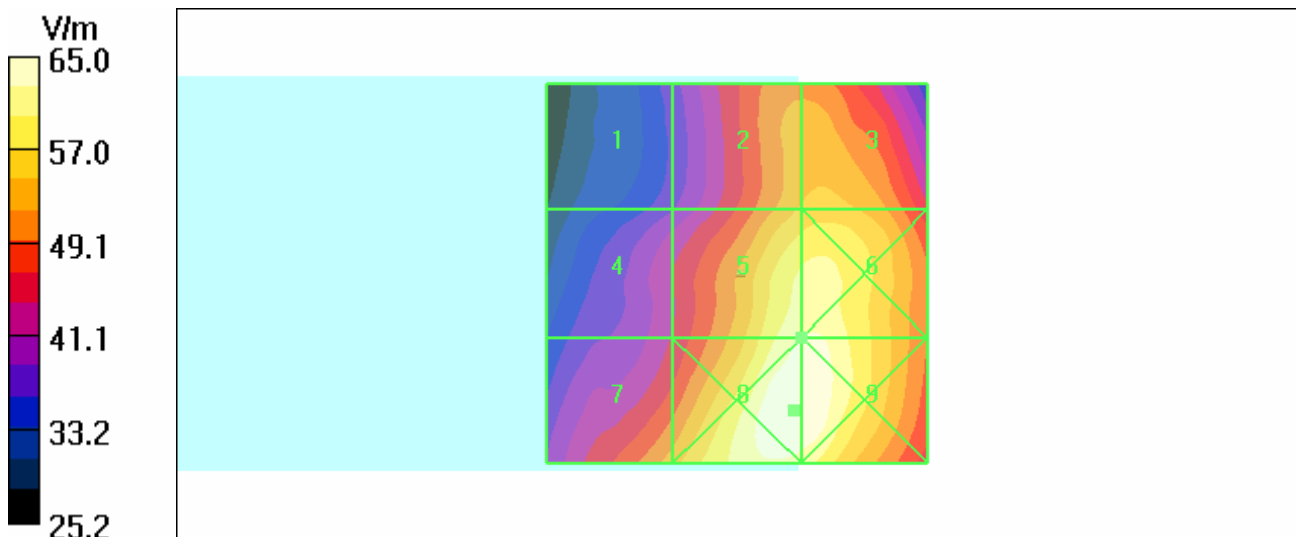

Test Laboratory: Advance Data Technology

**E-CDMA1900-Ch25**

**DUT: Pocket PC Phone ; Type: RAPH800 ; Test Frequency: 1851.25 MHz**

Communication System: CDMA ; Frequency: 1851.25 MHz ; Duty Cycle: 1:1 Modulation type: OQPSK

Medium: Air Medium parameters used:  $\sigma = 0$  mho/m,  $\epsilon_r = 1$ ;  $\rho = 1000$  kg/m<sup>3</sup> ;

Phantom section: E Device Section ;

Measurement Standard: DAS4 (High Precision Assessment);

DASY4 Configuration:

- Probe: ER3DV6 - SN2293 ; ConvF(1, 1, 1) ; Calibrated: 2007/1/23

- Sensor-Surface: (Fix Surface)

- Electronics: DAE3 Sn510; Calibrated: 2007/8/29

- Phantom: HAC Test Arch; Type: SD HAC P01 BA;

- Measurement SW: DAS4, V4.7 Build 53; Postprocessing SW: SEMCAD, V1.8 Build 172

**E Scan - ER probe center 10mm above Device Reference Low Channel 25/Hearing Aid Compatibility Test (101x101x1):** Measurement grid: dx=5mm, dy=5mm

Maximum value of peak Total field = **60.6** V/m

Probe Modulation Factor = 0.980

Reference Value = 35.1 V/m; Power Drift = -0.039 dB

**Hearing Aid Near-Field Category: M4 (AWF 0 dB)**

Peak E-field in V/m

Grid 1	Grid 2	Grid 3
<b>53.7</b>	<b>60.6</b>	<b>59.8</b>
Grid 4	Grid 5	Grid 6
<b>44.8</b>	<b>47.7</b>	<b>47.7</b>
Grid 7	Grid 8	Grid 9
<b>64.7</b>	<b>63.5</b>	<b>57.4</b>

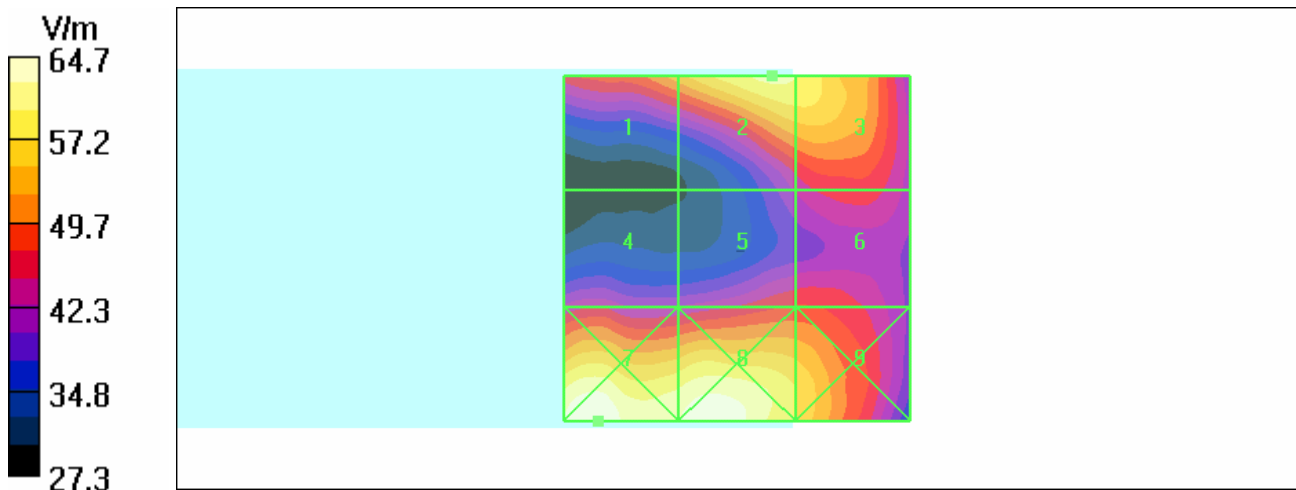

Test Laboratory: Advance Data Technology

**E-CDMA1900-Ch600**

**DUT: Pocket PC Phone ; Type: RAPH800 ; Test Frequency: 1880 MHz**

Communication System: CDMA ; Frequency: 1880 MHz ; Duty Cycle: 1:1 Modulation type: OQPSK

Medium: Air Medium parameters used:  $\sigma = 0$  mho/m,  $\epsilon_r = 1$ ;  $\rho = 1000$  kg/m<sup>3</sup> ;

Phantom section: E Device Section ;

Measurement Standard: DAS4 (High Precision Assessment);

DASY4 Configuration:

- Probe: ER3DV6 - SN2293 ; ConvF(1, 1, 1) ; Calibrated: 2007/1/23

- Sensor-Surface: (Fix Surface)

- Electronics: DAE3 Sn510; Calibrated: 2007/8/29

- Phantom: HAC Test Arch; Type: SD HAC P01 BA;

- Measurement SW: DAS4, V4.7 Build 53; Postprocessing SW: SEMCAD, V1.8 Build 172

**E Scan - ER probe center 10mm above Device Reference High Channel 1175/Hearing Aid Compatibility Test (101x101x1):** Measurement grid: dx=5mm, dy=5mm

Maximum value of peak Total field = **65.0** V/m

Probe Modulation Factor = 0.980

Reference Value = 37.2 V/m; Power Drift = -0.007 dB

**Hearing Aid Near-Field Category: M3 (AWF 0 dB)**

Peak E-field in V/m

Grid 1	Grid 2	Grid 3
<b>58.2</b>	<b>65.0</b>	<b>63.4</b>
Grid 4	Grid 5	Grid 6
<b>49.5</b>	<b>50.1</b>	<b>50.2</b>
Grid 7	Grid 8	Grid 9
<b>74.7</b>	<b>69.6</b>	<b>60.4</b>

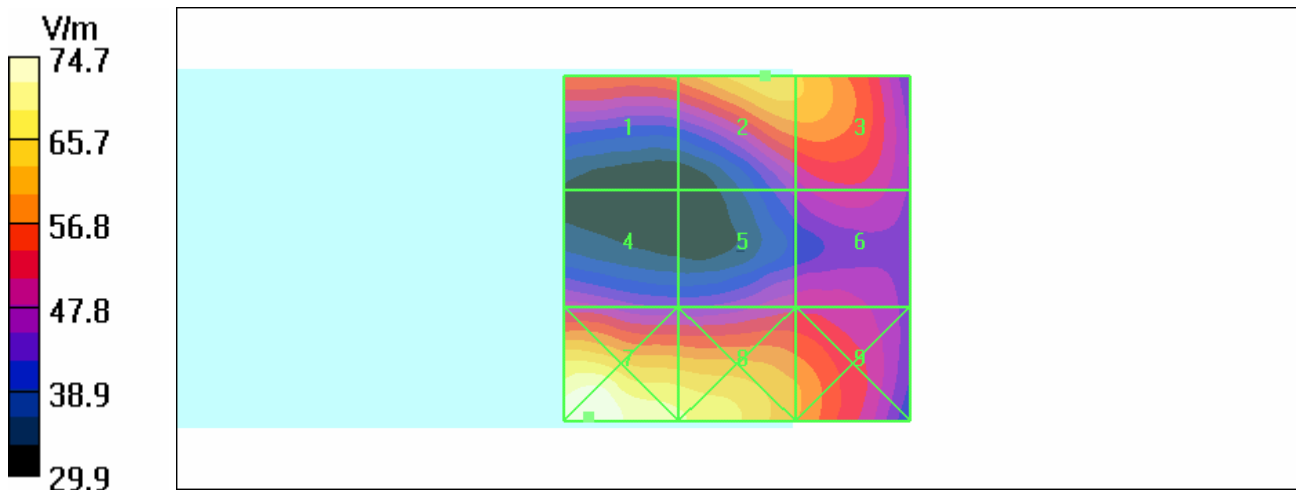

Test Laboratory: Advance Data Technology

### E-CDMA1900-Ch1175

**DUT: Pocket PC Phone ; Type: RAPH800 ; Test Frequency: 1908.75 MHz**

Communication System: CDMA ; Frequency: 1908.75 MHz ; Duty Cycle: 1:1 Modulation type: OQPSK

Medium: Air Medium parameters used:  $\sigma = 0$  mho/m,  $\epsilon_r = 1$ ;  $\rho = 1000$  kg/m<sup>3</sup> ;

Phantom section: E Device Section ;

Measurement Standard: DASY4 (High Precision Assessment);

DASY4 Configuration:

- Probe: ER3DV6 - SN2293 ; ConvF(1, 1, 1) ; Calibrated: 2007/1/23

- Sensor-Surface: (Fix Surface)

- Electronics: DAE3 Sn510; Calibrated: 2007/8/29

- Phantom: HAC Test Arch; Type: SD HAC P01 BA;

- Measurement SW: DASY4, V4.7 Build 53; Postprocessing SW: SEMCAD, V1.8 Build 172

### E Scan - ER probe center 10mm above Device Reference Mid Channel 600/Hearing Aid Compatibility Test (101x101x1): Measurement grid: dx=5mm, dy=5mm

Maximum value of peak Total field = **67.6** V/m

Probe Modulation Factor = 0.980

Reference Value = 40.1 V/m; Power Drift = -0.118 dB

**Hearing Aid Near-Field Category: M3 (AWF 0 dB)**

Peak E-field in V/m

Grid 1 <b>59.5</b>	Grid 2 <b>67.4</b>	Grid 3 <b>67.6</b>
Grid 4 <b>51.9</b>	Grid 5 <b>55.2</b>	Grid 6 <b>55.2</b>
Grid 7 <b>74.3</b>	Grid 8 <b>71.6</b>	Grid 9 <b>64.9</b>

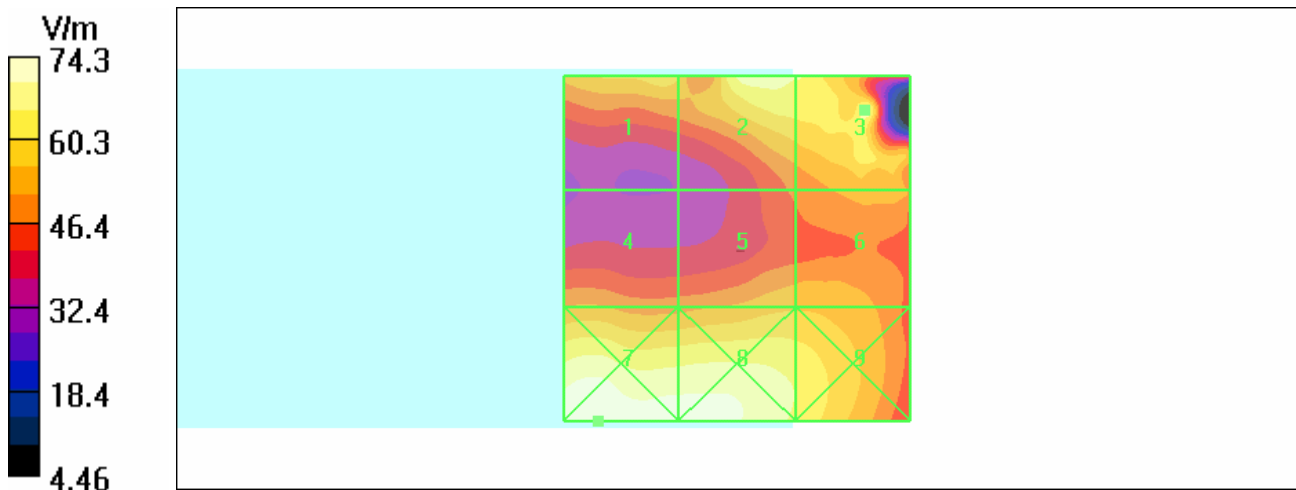



Test Laboratory: Advance Data Technology

**E-CDMA1900-Ch1175 Light Off**

**DUT: Pocket PC Phone ; Type: RAPH800 ; Test Frequency: 1908.75 MHz**

Communication System: CDMA ; Frequency: 1908.75 MHz ; Duty Cycle: 1:1 Modulation type: OQPSK

Medium: Air Medium parameters used:  $\sigma = 0$  mho/m,  $\epsilon_r = 1$ ;  $\rho = 1000$  kg/m<sup>3</sup> ;

Phantom section: E Device Section ;

Measurement Standard: DASY4 (High Precision Assessment);

DASY4 Configuration:

- Probe: ER3DV6 - SN2293 ; ConvF(1, 1, 1) ; Calibrated: 2007/1/23
- Sensor-Surface: (Fix Surface)
- Electronics: DAE3 Sn510; Calibrated: 2007/8/29
- Phantom: HAC Test Arch; Type: SD HAC P01 BA;
- Measurement SW: DASY4, V4.7 Build 53; Postprocessing SW: SEMCAD, V1.8 Build 172

**E Scan - ER probe center 10mm above Device Reference Hghd Channel 1175/Hearing**

**Aid Compatibility Test (101x101x1):** Measurement grid: dx=5mm, dy=5mm

Maximum value of peak Total field = **64.0** V/m

Probe Modulation Factor = 0.980

Reference Value = 33.1 V/m; Power Drift = -0.002 dB

**Hearing Aid Near-Field Category: M3 (AWF 0 dB)**

Peak E-field in V/m

Grid 1	Grid 2	Grid 3
<b>56.4</b>	<b>64.0</b>	<b>63.1</b>
Grid 4	Grid 5	Grid 6
<b>46.8</b>	<b>49.6</b>	<b>50.3</b>
Grid 7	Grid 8	Grid 9
<b>70.9</b>	<b>66.7</b>	<b>60.0</b>

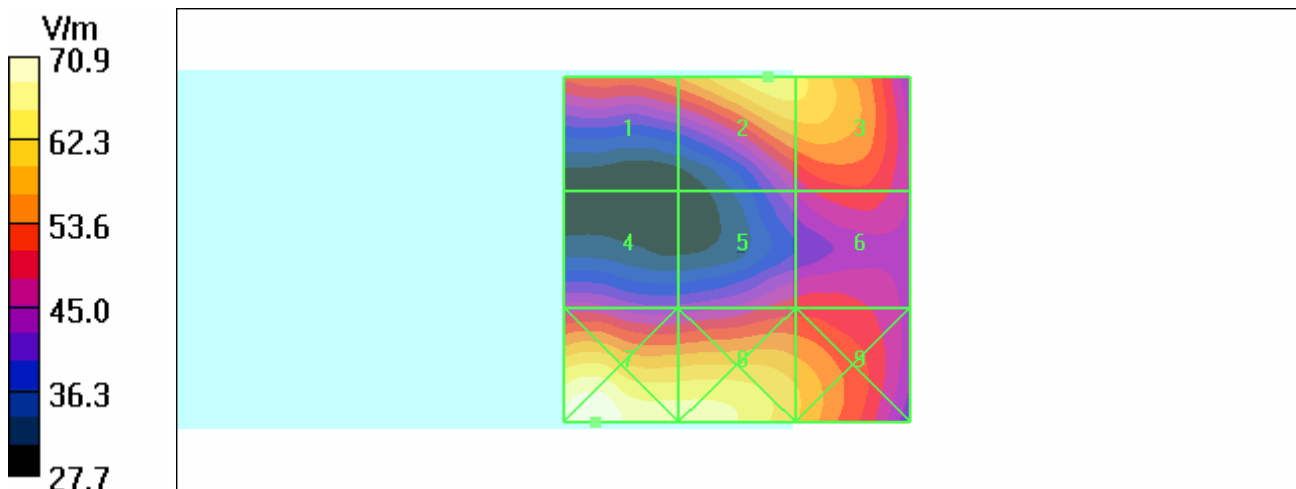

Test Laboratory: Advance Data Technology

### H-CDMA850-Ch1013

**DUT: Pocket PC Phone ; Type: RAPH800 ; Test Frequency: 824.7 MHz**

Communication System: CDMA ; Frequency: 824.7 MHz ; Duty Cycle: 1:1 Modulation type: OQPSK

Medium: Air Medium parameters used:  $\sigma = 0$  mho/m,  $\epsilon_r = 1$ ;  $\rho = 1$  kg/m<sup>3</sup> ;

Phantom section: H Device Section ;

Measurement Standard: DASY4 (High Precision Assessment);

DASY4 Configuration:

- Probe: H3DV6 - SN6124 ; ; Calibrated: 2007/1/23

- Sensor-Surface: (Fix Surface)

- Electronics: DAE3 Sn510; Calibrated: 2007/8/29

- Phantom: HAC Test Arch; Type: SD HAC P01 BA;

- Measurement SW: DASY4, V4.7 Build 53; Postprocessing SW: SEMCAD, V1.8 Build 172

### H Scan - ER probe center 10mm above Device Reference Low Channel 1013/Hearing Aid Compatibility Test (101x101x1): Measurement grid: dx=5mm, dy=5mm

Maximum value of peak Total field = **0.159** A/m

Probe Modulation Factor = 0.940

Reference Value = 0.153 A/m; Power Drift = -0.067 dB

**Hearing Aid Near-Field Category: M4 (AWF 0 dB)**

Peak H-field in A/m

Grid 1	Grid 2	Grid 3
<b>0.152</b>	<b>0.157</b>	<b>0.151</b>
Grid 4	Grid 5	Grid 6
<b>0.140</b>	<b>0.159</b>	<b>0.156</b>
Grid 7	Grid 8	Grid 9
<b>0.153</b>	<b>0.150</b>	<b>0.143</b>

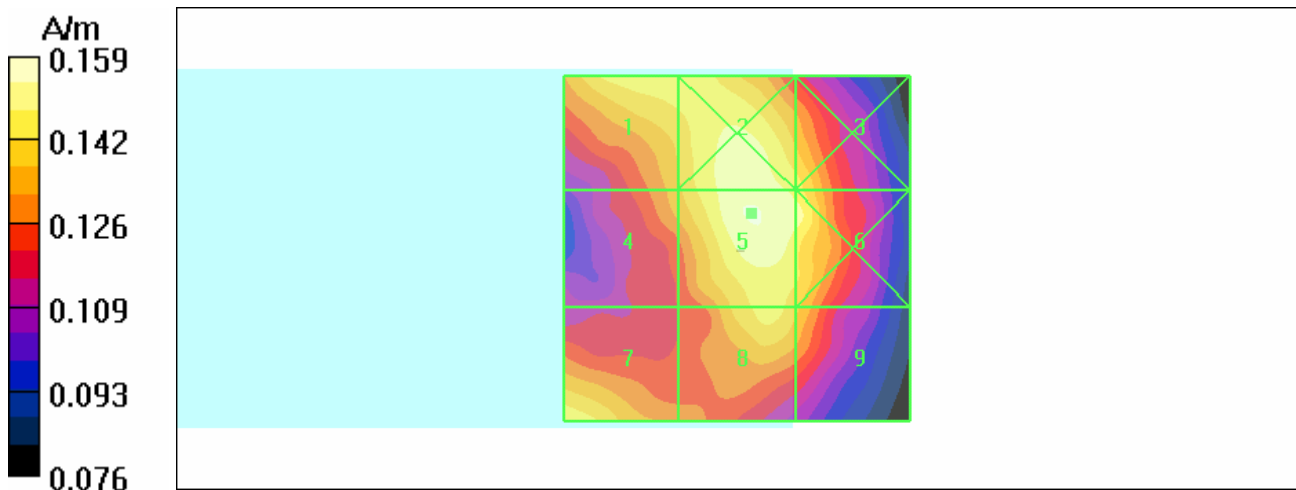

Test Laboratory: Advance Data Technology

### H-CDMA850-Ch384

**DUT: Pocket PC Phone ; Type: RAPH800 ; Test Frequency: 836.5 MHz**

Communication System: CDMA ; Frequency: 836.5 MHz ; Duty Cycle: 1:1 Modulation type: OQPSK

Medium: Air Medium parameters used:  $\sigma = 0$  mho/m,  $\epsilon_r = 1$ ;  $\rho = 1$  kg/m<sup>3</sup> ;

Phantom section: H Device Section ;

Measurement Standard: DASY4 (High Precision Assessment);

DASY4 Configuration:

- Probe: H3DV6 - SN6124 ; ; Calibrated: 2007/1/23

- Sensor-Surface: (Fix Surface)

- Electronics: DAE3 Sn510; Calibrated: 2007/8/29

- Phantom: HAC Test Arch; Type: SD HAC P01 BA;

- Measurement SW: DASY4, V4.7 Build 53; Postprocessing SW: SEMCAD, V1.8 Build 172

### H Scan - ER probe center 10mm above Device Reference Mid Channel 384/Hearing Aid Compatibility Test (101x101x1): Measurement grid: dx=5mm, dy=5mm

Maximum value of peak Total field = **0.162** A/m

Probe Modulation Factor = 0.940

Reference Value = 0.157 A/m; Power Drift = -0.086 dB

**Hearing Aid Near-Field Category: M4 (AWF 0 dB)**

Peak H-field in A/m

Grid 1	Grid 2	Grid 3
<b>0.154</b>	<b>0.160</b>	<b>0.153</b>
Grid 4	Grid 5	Grid 6
<b>0.142</b>	<b>0.162</b>	<b>0.158</b>
Grid 7	Grid 8	Grid 9
<b>0.155</b>	<b>0.153</b>	<b>0.145</b>

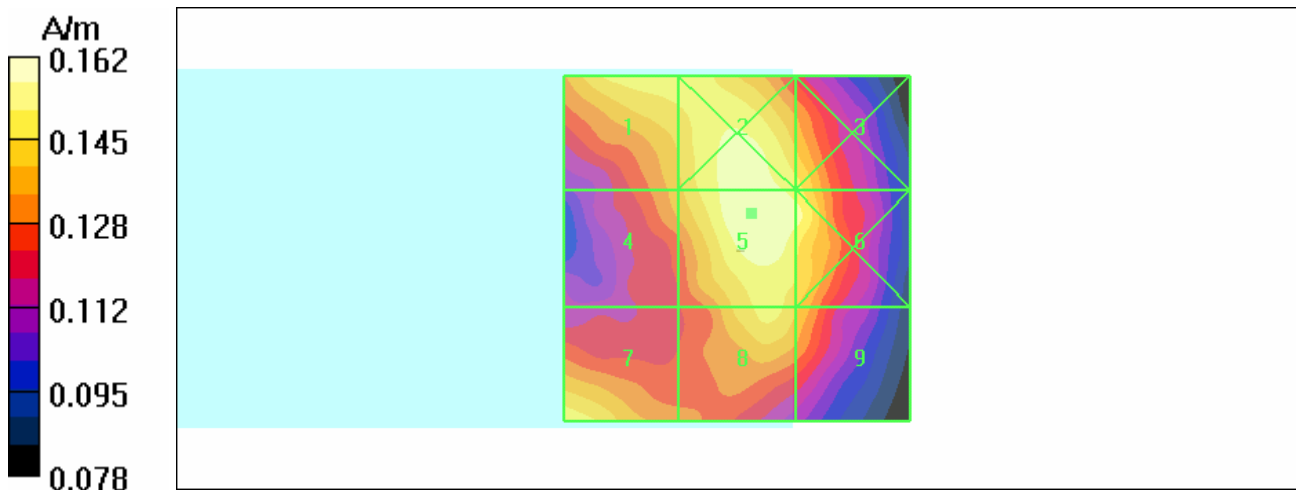

Test Laboratory: Advance Data Technology

### H-CDMA850-Ch777

**DUT: Pocket PC Phone ; Type: RAPH800 ; Test Frequency: 848.3 MHz**

Communication System: CDMA ; Frequency: 848.3 MHz ; Duty Cycle: 1:1 Modulation type: OQPSK

Medium: Air Medium parameters used:  $\sigma = 0$  mho/m,  $\epsilon_r = 1$ ;  $\rho = 1$  kg/m<sup>3</sup> ;

Phantom section: H Device Section ;

Measurement Standard: DASY4 (High Precision Assessment);

DASY4 Configuration:

- Probe: H3DV6 - SN6124 ; ; Calibrated: 2007/1/23

- Sensor-Surface: (Fix Surface)

- Electronics: DAE3 Sn510; Calibrated: 2007/8/29

- Phantom: HAC Test Arch; Type: SD HAC P01 BA;

- Measurement SW: DASY4, V4.7 Build 53; Postprocessing SW: SEMCAD, V1.8 Build 172

### H Scan - ER probe center 10mm above Device Reference High Channel 777/Hearing Aid Compatibility Test (101x101x1): Measurement grid: dx=5mm, dy=5mm

Maximum value of peak Total field = **0.176** A/m

Probe Modulation Factor = 0.940

Reference Value = 0.165 A/m; Power Drift = -0.084 dB

**Hearing Aid Near-Field Category: M4 (AWF 0 dB)**

Peak H-field in A/m

Grid 1	Grid 2	Grid 3
<b>0.166</b>	<b>0.174</b>	<b>0.163</b>
Grid 4	Grid 5	Grid 6
<b>0.155</b>	<b>0.176</b>	<b>0.167</b>
Grid 7	Grid 8	Grid 9
<b>0.158</b>	<b>0.156</b>	<b>0.151</b>

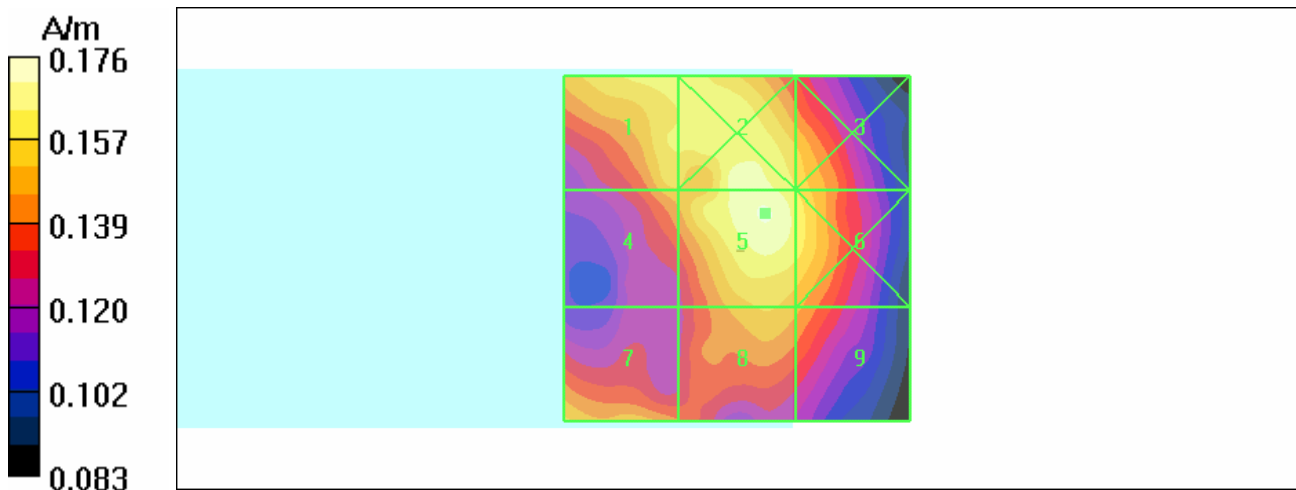

Test Laboratory: Advance Data Technology

### H-CDMA850-Ch777 Light Off

**DUT: Pocket PC Phone ; Type: RAPH800 ; Test Frequency: 848.3 MHz**

Communication System: CDMA ; Frequency: 848.3 MHz ; Duty Cycle: 1:1 Modulation type: OQPSK

Medium: Air Medium parameters used:  $\sigma = 0$  mho/m,  $\epsilon_r = 1$ ;  $\rho = 1$  kg/m<sup>3</sup> ;

Phantom section: H Device Section ;

Measurement Standard: DASY4 (High Precision Assessment);

DASY4 Configuration:

- Probe: H3DV6 - SN6124 ; ; Calibrated: 2007/1/23

- Sensor-Surface: (Fix Surface)

- Electronics: DAE3 Sn510; Calibrated: 2007/8/29

- Phantom: HAC Test Arch; Type: SD HAC P01 BA;

- Measurement SW: DASY4, V4.7 Build 53; Postprocessing SW: SEMCAD, V1.8 Build 172

### H Scan - ER probe center 10mm above Device Reference High Channel 777/Hearing Aid Compatibility Test (101x101x1): Measurement grid: dx=5mm, dy=5mm

Maximum value of peak Total field = **0.171** A/m

Probe Modulation Factor = 0.940

Reference Value = 0.162 A/m; Power Drift = -0.102 dB

**Hearing Aid Near-Field Category: M4 (AWF 0 dB)**

Peak H-field in A/m

Grid 1	Grid 2	Grid 3
<b>0.161</b>	<b>0.168</b>	<b>0.158</b>
Grid 4	Grid 5	Grid 6
<b>0.150</b>	<b>0.171</b>	<b>0.162</b>
Grid 7	Grid 8	Grid 9
<b>0.153</b>	<b>0.152</b>	<b>0.147</b>

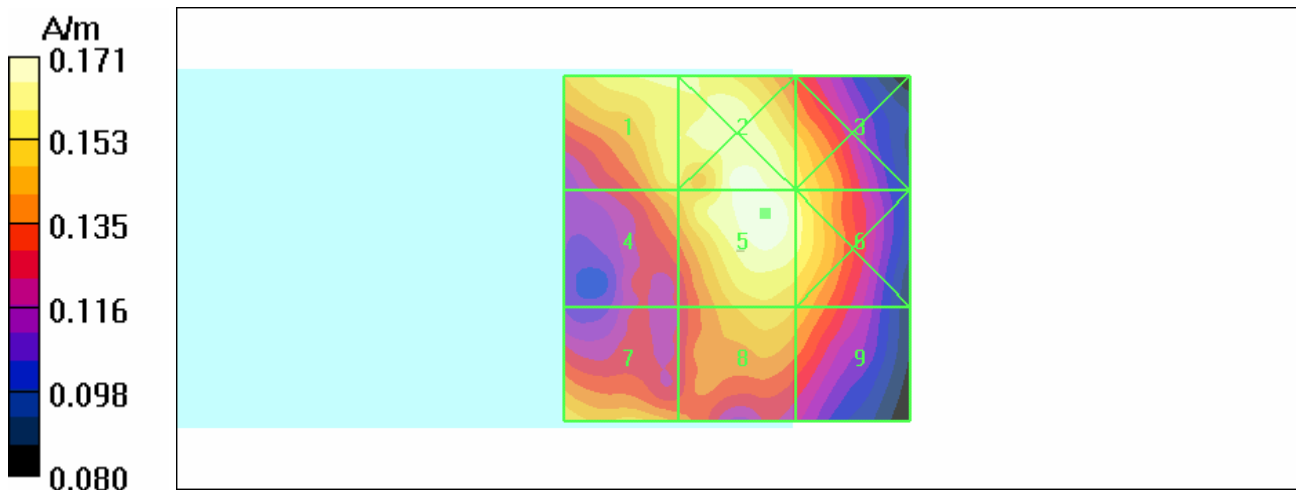

Test Laboratory: Advance Data Technology

### H-CDMA1900-Ch25

**DUT: Pocket PC Phone ; Type: RAPH800 ; Test Frequency: 1851.25 MHz**

Communication System: CDMA ; Frequency: 1851.25 MHz ; Duty Cycle: 1:1 Modulation type: OQPSK  
 Medium: Air Medium parameters used:  $\sigma = 0$  mho/m,  $\epsilon_r = 1$ ;  $\rho = 1$  kg/m<sup>3</sup> ;  
 Phantom section: H Device Section ;  
 Measurement Standard: DASY4 (High Precision Assessment);

DASY4 Configuration:

- Probe: H3DV6 - SN6124 ; ; Calibrated: 2007/1/23
- Sensor-Surface: (Fix Surface)
- Electronics: DAE3 Sn510; Calibrated: 2007/8/29
- Phantom: HAC Test Arch; Type: SD HAC P01 BA;
- Measurement SW: DASY4, V4.7 Build 53; Postprocessing SW: SEMCAD, V1.8 Build 172

### H Scan - ER probe center 10mm above Device Reference Low Channel 25/Hearing Aid Compatibility Test (101x101x1):

Measurement grid: dx=5mm, dy=5mm

Maximum value of peak Total field = **0.198** A/m

Probe Modulation Factor = 0.930

Reference Value = 0.210 A/m; Power Drift = -0.211 dB

**Hearing Aid Near-Field Category: M3 (AWF 0 dB)**

Peak H-field in A/m

Grid 1	Grid 2	Grid 3
<b>0.165</b>	<b>0.194</b>	<b>0.185</b>
Grid 4	Grid 5	Grid 6
<b>0.166</b>	<b>0.198</b>	<b>0.190</b>
Grid 7	Grid 8	Grid 9
<b>0.148</b>	<b>0.180</b>	<b>0.174</b>

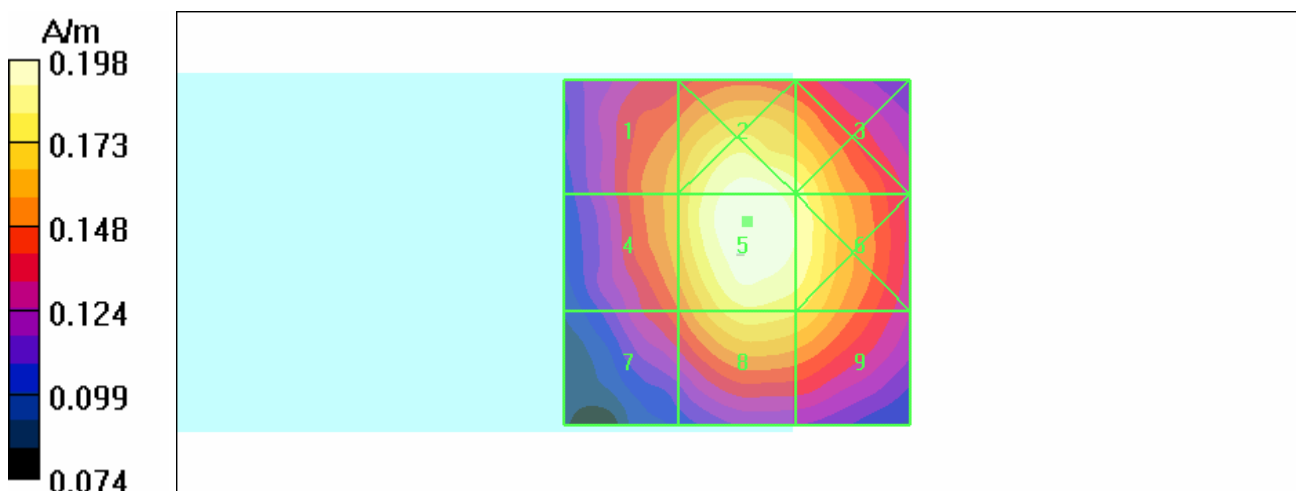

Test Laboratory: Advance Data Technology

### H-CDMA1900-Ch600

**DUT: Pocket PC Phone ; Type: RAPH800 ; Test Frequency: 1880 MHz**

Communication System: CDMA ; Frequency: 1880 MHz ; Duty Cycle: 1:1 Modulation type: OQPSK  
 Medium: Air Medium parameters used:  $\sigma = 0$  mho/m,  $\epsilon_r = 1$ ;  $\rho = 1$  kg/m<sup>3</sup> ;  
 Phantom section: H Device Section ;  
 Measurement Standard: DASY4 (High Precision Assessment);

DASY4 Configuration:

- Probe: H3DV6 - SN6124 ; ; Calibrated: 2007/1/23
- Sensor-Surface: (Fix Surface)
- Electronics: DAE3 Sn510; Calibrated: 2007/8/29
- Phantom: HAC Test Arch; Type: SD HAC P01 BA;
- Measurement SW: DASY4, V4.7 Build 53; Postprocessing SW: SEMCAD, V1.8 Build 172

### H Scan - ER probe center 10mm above Device Reference Mid Channel 600/Hearing Aid Compatibility Test (101x101x1):

Measurement grid: dx=5mm, dy=5mm

Maximum value of peak Total field = **0.221** A/m

Probe Modulation Factor = 0.930

Reference Value = 0.225 A/m; Power Drift = -0.124 dB

**Hearing Aid Near-Field Category: M3 (AWF 0 dB)**

Peak H-field in A/m

Grid 1	Grid 2	Grid 3
<b>0.188</b>	<b>0.217</b>	<b>0.204</b>
Grid 4	Grid 5	Grid 6
<b>0.189</b>	<b>0.221</b>	<b>0.208</b>
Grid 7	Grid 8	Grid 9
<b>0.166</b>	<b>0.197</b>	<b>0.188</b>

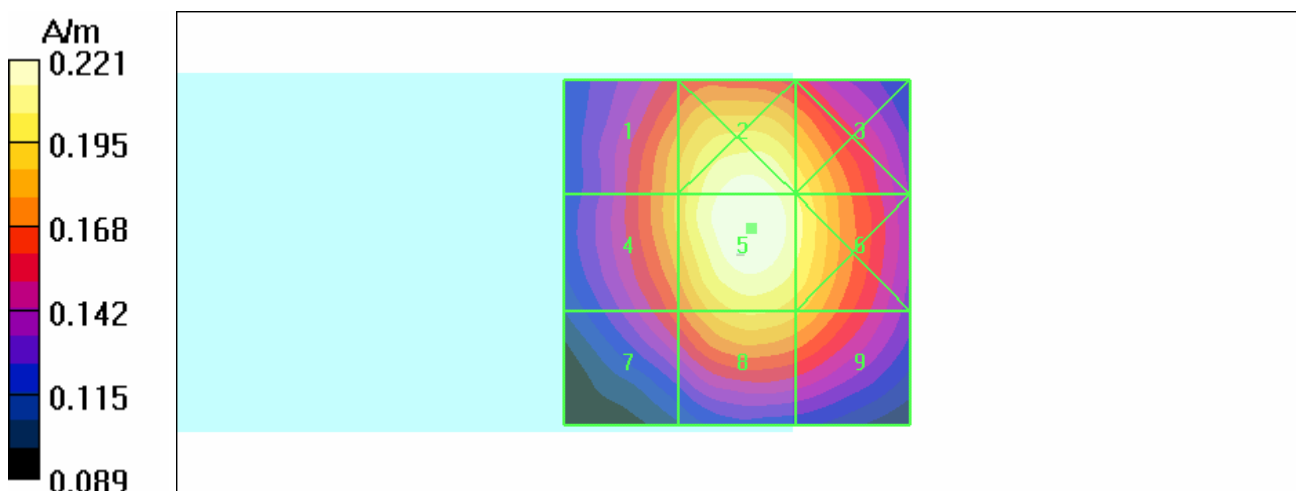

Test Laboratory: Advance Data Technology

### H-CDMA1900-Ch1175

**DUT: Pocket PC Phone ; Type: RAPH800 ; Test Frequency: 1908.75 MHz**

Communication System: CDMA ; Frequency: 1908.75 MHz ; Duty Cycle: 1:1 Modulation type: OQPSK  
 Medium: Air Medium parameters used:  $\sigma = 0$  mho/m,  $\epsilon_r = 1$ ;  $\rho = 1$  kg/m<sup>3</sup> ;  
 Phantom section: H Device Section ;  
 Measurement Standard: DAS4 (High Precision Assessment);

DASY4 Configuration:

- Probe: H3DV6 - SN6124 ; ; Calibrated: 2007/1/23
- Sensor-Surface: (Fix Surface)
- Electronics: DAE3 Sn510; Calibrated: 2007/8/29
- Phantom: HAC Test Arch; Type: SD HAC P01 BA;
- Measurement SW: DAS4, V4.7 Build 53; Postprocessing SW: SEMCAD, V1.8 Build 172

### H Scan - ER probe center 10mm above Device Reference High Channel 1175/Hearing Aid Compatibility Test (101x101x1):

Measurement grid: dx=5mm, dy=5mm

Maximum value of peak Total field = **0.225** A/m

Probe Modulation Factor = 0.930

Reference Value = 0.234 A/m; Power Drift = -0.156 dB

**Hearing Aid Near-Field Category: M3 (AWF 0 dB)**

Peak H-field in A/m

Grid 1	Grid 2	Grid 3
<b>0.190</b>	<b>0.221</b>	<b>0.208</b>
Grid 4	Grid 5	Grid 6
<b>0.191</b>	<b>0.225</b>	<b>0.212</b>
Grid 7	Grid 8	Grid 9
<b>0.172</b>	<b>0.203</b>	<b>0.194</b>

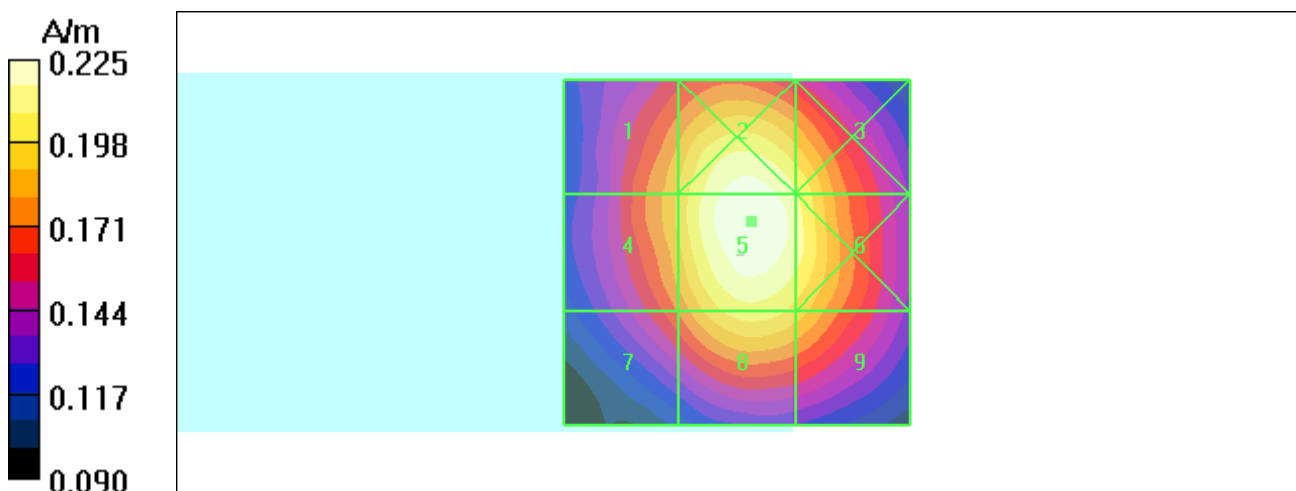



Test Laboratory: Advance Data Technology

### H-CDMA1900-Ch1175 Light Off

**DUT: Pocket PC Phone ; Type: RAPH800 ; Test Frequency: 1908.75 MHz**

Communication System: CDMA ; Frequency: 1908.75 MHz ; Duty Cycle: 1:1 Modulation type: OQPSK

Medium: Air Medium parameters used:  $\sigma = 0$  mho/m,  $\epsilon_r = 1$ ;  $\rho = 1$  kg/m<sup>3</sup> ;

Phantom section: H Device Section ;

Measurement Standard: DAS4 (High Precision Assessment);

DASY4 Configuration:

- Probe: H3DV6 - SN6124 ; ; Calibrated: 2007/1/23

- Sensor-Surface: (Fix Surface)

- Electronics: DAE3 Sn510; Calibrated: 2007/8/29

- Phantom: HAC Test Arch; Type: SD HAC P01 BA;

- Measurement SW: DAS4, V4.7 Build 53; Postprocessing SW: SEMCAD, V1.8 Build 172

### H Scan - ER probe center 10mm above Device Reference High Channel 1175/Hearing Aid Compatibility Test (101x101x1): Measurement grid: dx=5mm, dy=5mm

Maximum value of peak Total field = **0.227** A/m

Probe Modulation Factor = 0.930

Reference Value = 0.246 A/m; Power Drift = -0.137 dB

**Hearing Aid Near-Field Category: M3 (AWF 0 dB)**

Peak H-field in A/m

Grid 1	Grid 2	Grid 3
<b>0.194</b>	<b>0.223</b>	<b>0.207</b>
Grid 4	Grid 5	Grid 6
<b>0.195</b>	<b>0.227</b>	<b>0.216</b>
Grid 7	Grid 8	Grid 9
<b>0.180</b>	<b>0.210</b>	<b>0.200</b>

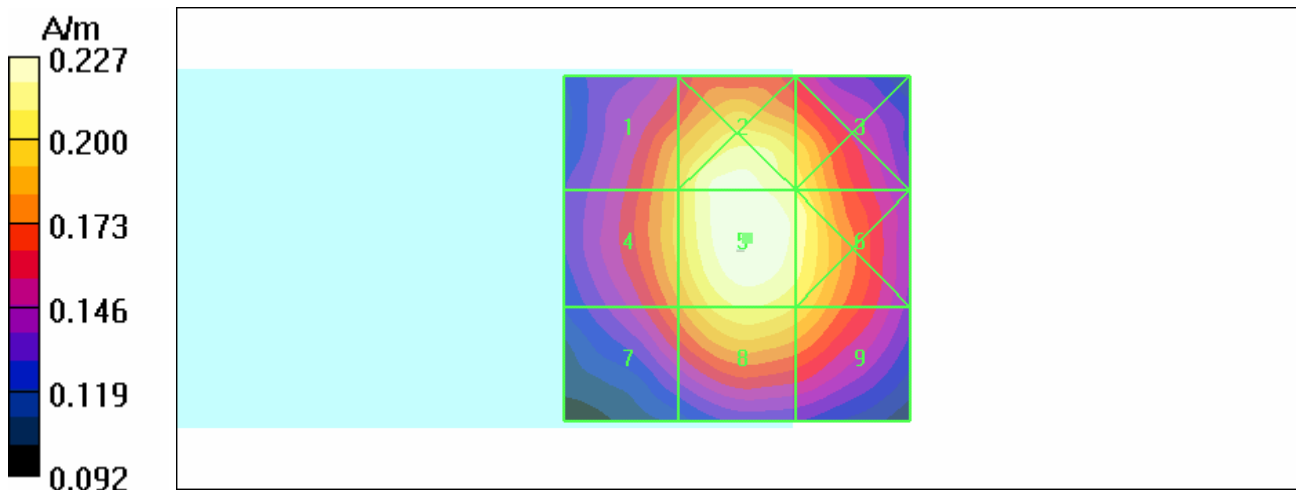

Test Laboratory: Advance Data Technology

**E-836.5MHz (WD)**

**DUT: HAC-Dipole 835 MHz ; Type: D835V3 ; Serial: 1041 ; Test Frequency: 836.5 MHz**

Communication System: CDMA ; Frequency: 836.5 MHz; Duty Cycle: 1:1; Modulation type: OQPSK  
 Medium: Air;Medium parameters used:  $\sigma = 0$  mho/m,  $\epsilon_r = 1$ ;  $\rho = 1000$  kg/m<sup>3</sup>  
 Phantom section: E Dipole Section Measurement Standard: DASY4 (High Precision Assessment);

DASY4 Configuration:

- Probe: ER3DV6 - SN2293 ; ConvF(1, 1, 1) ; Calibrated: 2007/1/23
- Sensor-Surface: (Fix Surface)
- Electronics: DAE3 Sn510; Calibrated: 2007/8/29
- Phantom: HAC Test Arch; Type: SD HAC P01 BA; Serial:
- Measurement SW: DASY4, V4.7 Build 53; Postprocessing SW: SEMCAD, V1.8 Build 172

**E Scan - ER probe center 10mm above CD835 Dipole/Hearing Aid Compatibility Test**

**(41x361x1):** Measurement grid: dx=5mm, dy=5mm

Maximum value of peak Total field = **171.1** V/m

Probe Modulation Factor = 1.00

Reference Value = 123.5 V/m; Power Drift = -0.138 dB

**Hearing Aid Near-Field Category: M4 (AWF 0 dB)**

Peak E-field in V/m

Grid 1	Grid 2	Grid 3
<b>161.7</b>	<b>171.1</b>	<b>168.8</b>
Grid 4	Grid 5	Grid 6
<b>84.2</b>	<b>90.2</b>	<b>88.9</b>
Grid 7	Grid 8	Grid 9
<b>160.6</b>	<b>170.3</b>	<b>167.3</b>

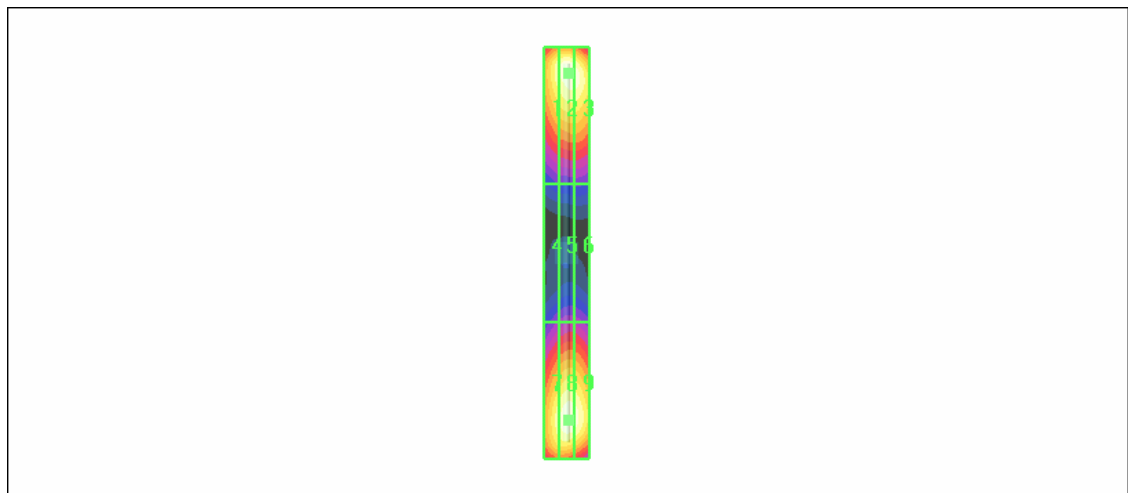
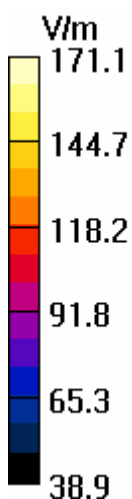

Test Laboratory: Advance Data Technology

**E-836.5MHz (CW)**

**DUT: HAC-Dipole 835 MHz ; Type: D835V3 ; Serial: 1041 ; Test Frequency: 836.5 MHz**

Communication System: CW ; Frequency: 836.5 MHz; Duty Cycle: 1:1; Modulation type: CW

Medium: Air;Medium parameters used:  $\sigma = 0$  mho/m,  $\epsilon_r = 1$ ;  $\rho = 1000$  kg/m<sup>3</sup>

Phantom section: E Dipole Section Measurement Standard: DAS4 (High Precision Assessment);

DASY4 Configuration:

- Probe: ER3DV6 - SN2293 ; ConvF(1, 1, 1) ; Calibrated: 2007/1/23
- Sensor-Surface: (Fix Surface)
- Electronics: DAE3 Sn510; Calibrated: 2007/8/29
- Phantom: HAC Test Arch; Type: SD HAC P01 BA; Serial:
- Measurement SW: DAS4, V4.7 Build 53; Postprocessing SW: SEMCAD, V1.8 Build 172

**E Scan - ER probe center 10mm above CD835 Dipole/Hearing Aid Compatibility Test**

**(41x361x1):** Measurement grid: dx=5mm, dy=5mm

Maximum value of peak Total field = **165.7** V/m

Probe Modulation Factor = 1.00

Reference Value = 121.3 V/m; Power Drift = -0.022 dB

**Hearing Aid Near-Field Category: M4 (AWF 0 dB)**

Peak E-field in V/m

Grid 1	Grid 2	Grid 3
<b>160.8</b>	<b>164.4</b>	<b>161.0</b>
Grid 4	Grid 5	Grid 6
<b>83.1</b>	<b>88.2</b>	<b>87.2</b>
Grid 7	Grid 8	Grid 9
<b>156.6</b>	<b>165.7</b>	<b>164.6</b>

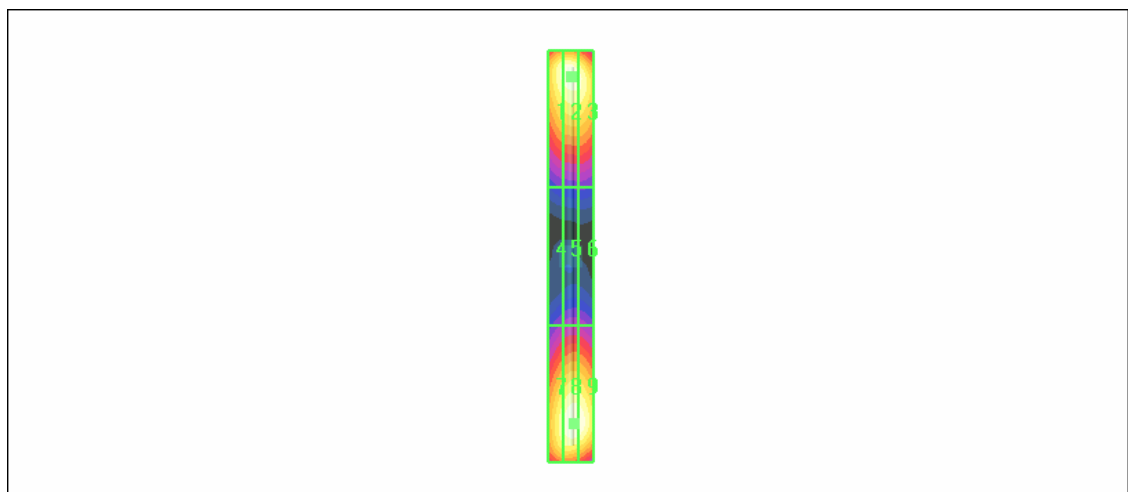
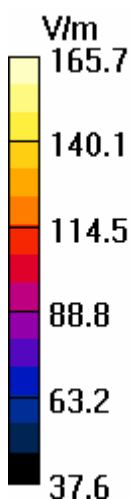

Test Laboratory: Advance Data Technology

**E-836.5MHz (AM 80%)**

**DUT: HAC-Dipole 835 MHz ; Type: D835V3 ; Serial: 1041 ; Test Frequency: 836.5 MHz**

Communication System: AM ; Frequency: 836.5 MHz; Duty Cycle: 1:1; Modulation type: AM  
 Medium: Air;Medium parameters used:  $\sigma = 0$  mho/m,  $\epsilon_r = 1$ ;  $\rho = 1000$  kg/m<sup>3</sup>

Phantom section: E Dipole Section Measurement Standard: DAS4 (High Precision Assessment);

DASY4 Configuration:

- Probe: ER3DV6 - SN2293 ; ConvF(1, 1, 1) ; Calibrated: 2007/1/23
- Sensor-Surface: (Fix Surface)
- Electronics: DAE3 Sn510; Calibrated: 2007/8/29
- Phantom: HAC Test Arch; Type: SD HAC P01 BA; Serial:
- Measurement SW: DAS4, V4.7 Build 53; Postprocessing SW: SEMCAD, V1.8 Build 172

**E Scan - ER probe center 10mm above CD835 Dipole/Hearing Aid Compatibility Test**

**(41x361x1):** Measurement grid: dx=5mm, dy=5mm

Maximum value of peak Total field = **150.5** V/m

Probe Modulation Factor = 1.00

Reference Value = 111.4 V/m; Power Drift = -0.038 dB

**Hearing Aid Near-Field Category: M4 (AWF 0 dB)**

Peak E-field in V/m

Grid 1	Grid 2	Grid 3
<b>146.6</b>	<b>149.7</b>	<b>148.6</b>
Grid 4	Grid 5	Grid 6
<b>78.6</b>	<b>82.5</b>	<b>81.7</b>
Grid 7	Grid 8	Grid 9
<b>145.7</b>	<b>150.5</b>	<b>149.8</b>

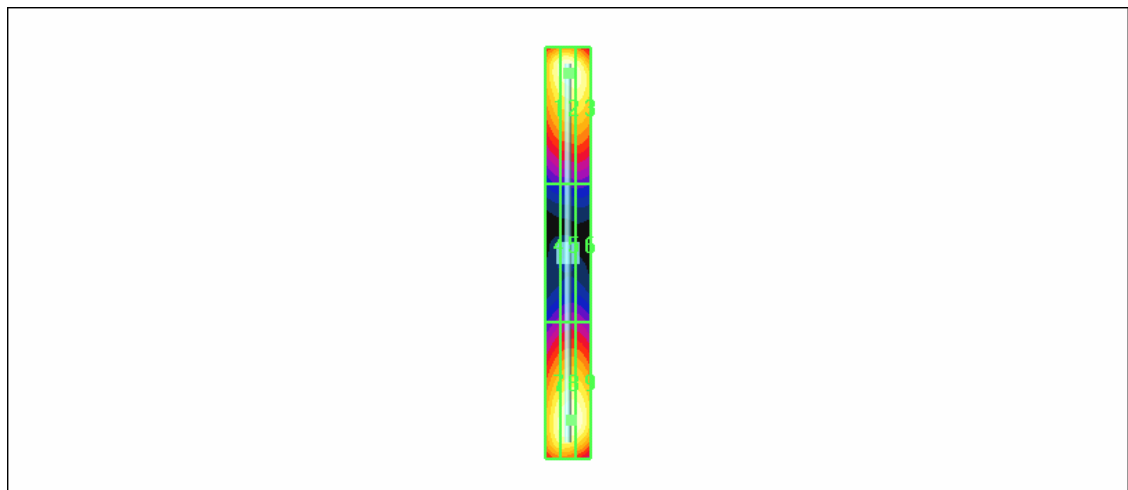
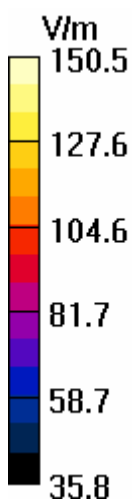

Test Laboratory: Advance Data Technology

**H-836.5MHz (WD)**

**DUT: HAC-Dipole 835 MHz ; Type: D835V3 ; Serial: 1041 ; Test Frequency: 836.6 MHz**

Communication System: CDMA ; Frequency: 836.6 MHz; Duty Cycle: 1:1; Modulation type: OQPSK  
 Medium: Air;Medium parameters used:  $\sigma = 0$  mho/m,  $\epsilon_r = 1$ ;  $\rho = 1$  kg/m<sup>3</sup>  
 Phantom section: H Dipole Section Measurement Standard: DAS4 (High Precision Assessment);

DASY4 Configuration:

- Probe: H3DV6 - SN6124 ; ; Calibrated: 2007/1/23
- Sensor-Surface: (Fix Surface)
- Electronics: DAE3 Sn510; Calibrated: 2007/8/29
- Phantom: HAC Test Arch; Type: SD HAC P01 BA; Serial:
- Measurement SW: DAS4, V4.7 Build 53; Postprocessing SW: SEMCAD, V1.8 Build 172

**H Scan - ER probe center 10mm above CD835 Dipole/Hearing Aid Compatibility Test**

**(41x361x1):** Measurement grid: dx=5mm, dy=5mm

Maximum value of peak Total field = **0.498** A/m

Probe Modulation Factor = 1.00

Reference Value = 0.522 A/m; Power Drift = -0.044 dB

**Hearing Aid Near-Field Category: M4 (AWF 0 dB)**

Peak H-field in A/m

Grid 1	Grid 2	Grid 3
<b>0.405</b>	<b>0.445</b>	<b>0.430</b>
Grid 4	<b>Grid 5</b>	Grid 6
<b>0.451</b>	<b>0.498</b>	<b>0.483</b>
Grid 7	Grid 8	Grid 9
<b>0.396</b>	<b>0.440</b>	<b>0.429</b>

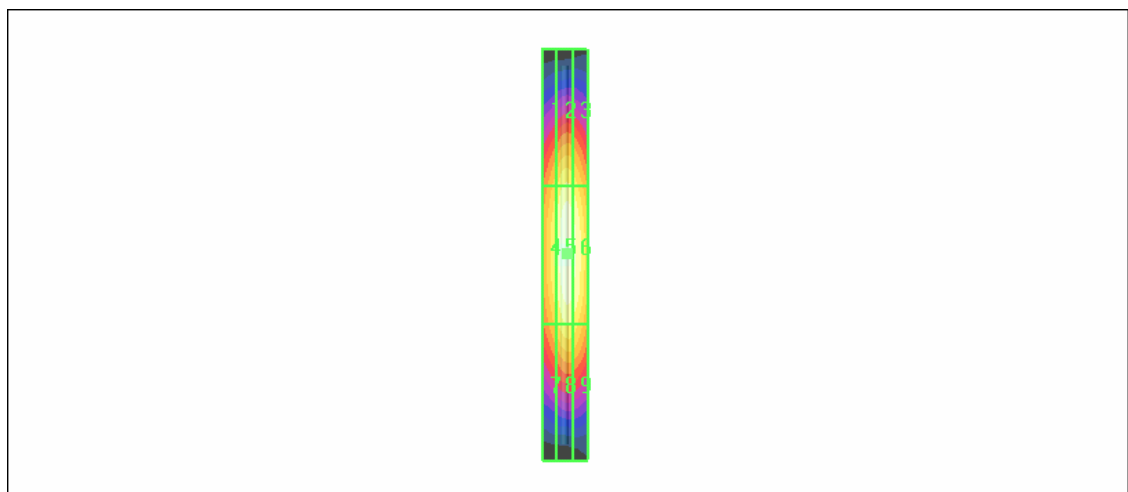
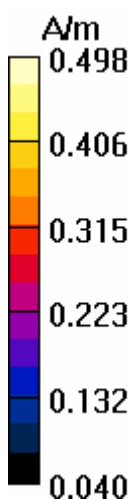

Test Laboratory: Advance Data Technology

**H-836.5MHz (CW)**

**DUT: HAC-Dipole 835 MHz ; Type: D835V3 ; Serial: 1041 ; Test Frequency: 836.5 MHz**

Communication System: CW ; Frequency: 836.5 MHz; Duty Cycle: 1:1; Modulation type: CW  
 Medium: Air;Medium parameters used:  $\sigma = 0$  mho/m,  $\epsilon_r = 1$ ;  $\rho = 1$  kg/m<sup>3</sup>

Phantom section: H Dipole Section Measurement Standard: DAS4 (High Precision Assessment);

DASY4 Configuration:

- Probe: H3DV6 - SN6124 ; ; Calibrated: 2007/1/23
- Sensor-Surface: (Fix Surface)
- Electronics: DAE3 Sn510; Calibrated: 2007/8/29
- Phantom: HAC Test Arch; Type: SD HAC P01 BA; Serial:
- Measurement SW: DAS4, V4.7 Build 53; Postprocessing SW: SEMCAD, V1.8 Build 172

**H Scan - ER probe center 10mm above CD835 Dipole/Hearing Aid Compatibility Test**

**(41x361x1):** Measurement grid: dx=5mm, dy=5mm

Maximum value of peak Total field = **0.468** A/m

Probe Modulation Factor = 1.00

Reference Value = 0.497 A/m; Power Drift = -0.009 dB

**Hearing Aid Near-Field Category: M4 (AWF 0 dB)**

Peak H-field in A/m

Grid 1	Grid 2	Grid 3
<b>0.383</b>	<b>0.420</b>	<b>0.408</b>
Grid 4	<b>Grid 5</b>	Grid 6
<b>0.427</b>	<b>0.468</b>	<b>0.458</b>
Grid 7	Grid 8	Grid 9
<b>0.375</b>	<b>0.415</b>	<b>0.408</b>

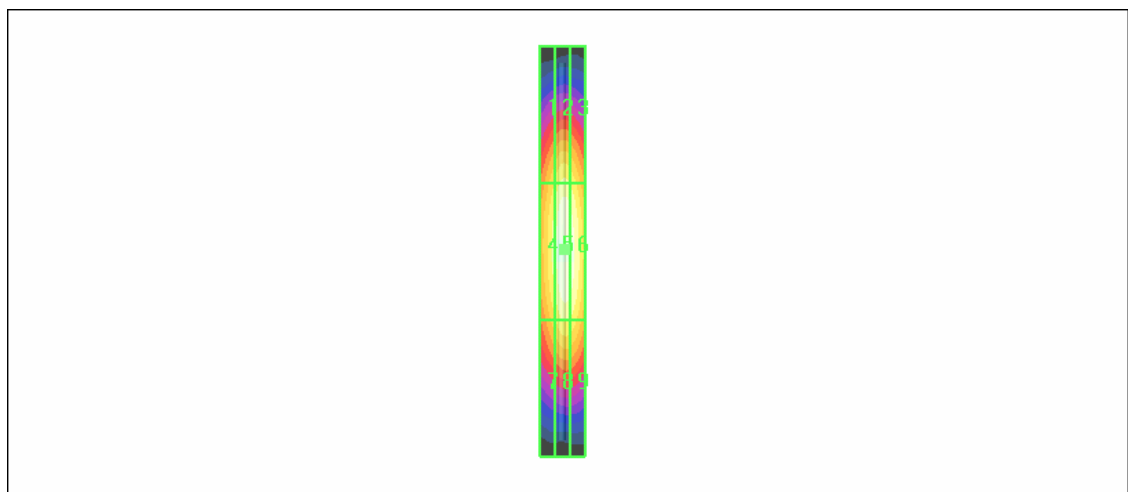
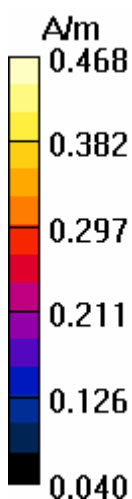

Test Laboratory: Advance Data Technology

**H-836.5MHz (AM 80%)**

**DUT: HAC-Dipole 835 MHz ; Type: D835V3 ; Serial: 1041 ; Test Frequency: 835 MHz**

Communication System: AM ; Frequency: 835 MHz; Duty Cycle: 1:1; Modulation type: AM

Medium: Air;Medium parameters used:  $\sigma = 0$  mho/m,  $\epsilon_r = 1$ ;  $\rho = 1$  kg/m<sup>3</sup>

Phantom section: H Dipole Section Measurement Standard: DASY4 (High Precision Assessment);

DASY4 Configuration:

- Probe: H3DV6 - SN6124 ; ; Calibrated: 2007/1/23
- Sensor-Surface: (Fix Surface)
- Electronics: DAE3 Sn510; Calibrated: 2007/8/29
- Phantom: HAC Test Arch; Type: SD HAC P01 BA; Serial:
- Measurement SW: DASY4, V4.7 Build 53; Postprocessing SW: SEMCAD, V1.8 Build 172

**H Scan - ER probe center 10mm above CD835 Dipole/Hearing Aid Compatibility Test**

**(41x361x1):** Measurement grid: dx=5mm, dy=5mm

Maximum value of peak Total field = **0.475** A/m

Probe Modulation Factor = 1.00

Reference Value = 0.502 A/m; Power Drift = -0.089 dB

**Hearing Aid Near-Field Category: M4 (AWF 0 dB)**

Peak H-field in A/m

Grid 1	Grid 2	Grid 3
<b>0.386</b>	<b>0.423</b>	<b>0.408</b>
Grid 4	<b>Grid 5</b>	Grid 6
<b>0.432</b>	<b>0.475</b>	<b>0.459</b>
Grid 7	Grid 8	Grid 9
<b>0.379</b>	<b>0.416</b>	<b>0.405</b>

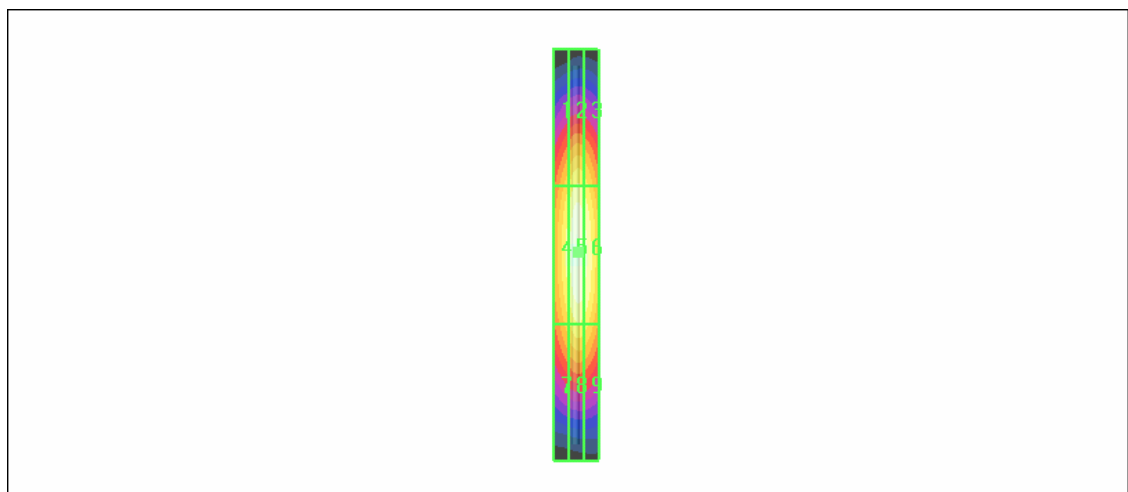
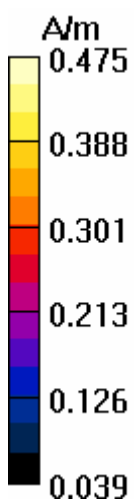

Test Laboratory: Advance Data Technology

**E-1880MHz (WD)**

**DUT: HAC Dipole 1880 MHz ; Type: CD1880V3 ; Serial: 1032 ; Test Frequency: 1880 MHz**

Communication System: CDMA ; Frequency: 1880 MHz; Duty Cycle: 1:1; Modulation type: OQPSK  
 Medium: Air;Medium parameters used:  $\sigma = 0$  mho/m,  $\epsilon_r = 1$ ;  $\rho = 1000$  kg/m<sup>3</sup>  
 Phantom section: E Dipole Section Measurement Standard: DASY4 (High Precision Assessment);

DASY4 Configuration:

- Probe: ER3DV6 - SN2293 ; ConvF(1, 1, 1) ; Calibrated: 2007/1/23
- Sensor-Surface: (Fix Surface)
- Electronics: DAE3 Sn510; Calibrated: 2007/8/29
- Phantom: HAC Test Arch; Type: SD HAC P01 BA; Serial:
- Measurement SW: DASY4, V4.7 Build 53; Postprocessing SW: SEMCAD, V1.8 Build 172

**E Scan - ER probe center 10mm above CD1880 Dipole/Hearing Aid Compatibility Test**

**(41x181x1):** Measurement grid: dx=5mm, dy=5mm

Maximum value of peak Total field = **128.4** V/m

Probe Modulation Factor = 1.00

Reference Value = 129.4 V/m; Power Drift = -0.059 dB

**Hearing Aid Near-Field Category: M2 (AWF 0 dB)**

Peak E-field in V/m

Grid 1	Grid 2	Grid 3
<b>124.8</b>	<b>128.4</b>	<b>124.9</b>
Grid 4	Grid 5	Grid 6
<b>82.8</b>	<b>88.3</b>	<b>87.2</b>
Grid 7	Grid 8	Grid 9
<b>121.5</b>	<b>128.4</b>	<b>126.7</b>

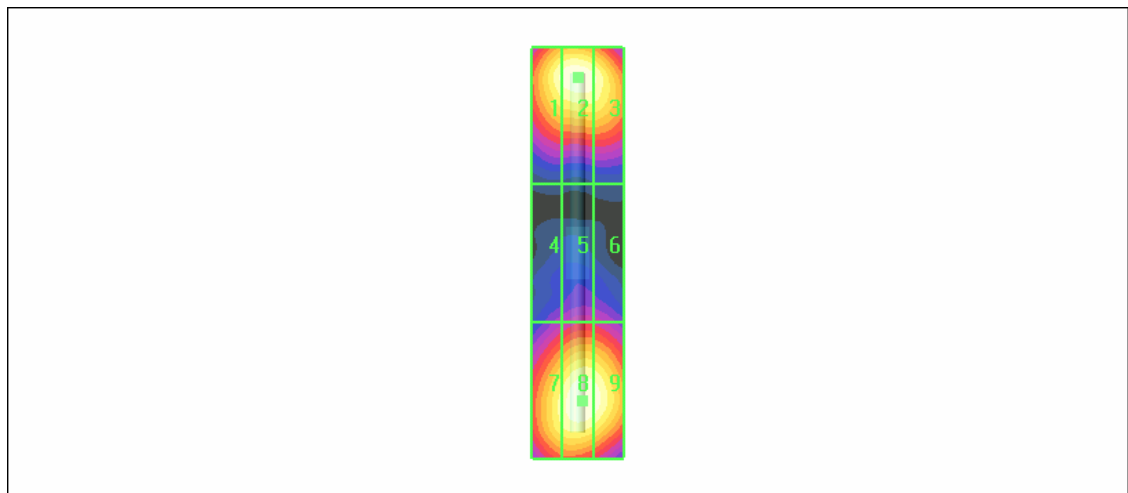
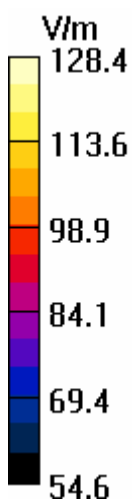



Test Laboratory: Advance Data Technology

**E-1880MHz (CW)**

**DUT: HAC Dipole 1880 MHz ; Type: CD1880V3 ; Serial: 1032 ; Test Frequency: 1880 MHz**

Communication System: CW ; Frequency: 1880 MHz; Duty Cycle: 1:1; Modulation type: CW  
 Medium: Air;Medium parameters used:  $\sigma = 0$  mho/m,  $\epsilon_r = 1$ ;  $\rho = 1000$  kg/m<sup>3</sup>  
 Phantom section: E Dipole Section Measurement Standard: DASY4 (High Precision Assessment);

DASY4 Configuration:

- Probe: ER3DV6 - SN2293 ; ConvF(1, 1, 1) ; Calibrated: 2007/1/23
- Sensor-Surface: (Fix Surface)
- Electronics: DAE3 Sn510; Calibrated: 2007/8/29
- Phantom: HAC Test Arch; Type: SD HAC P01 BA; Serial:
- Measurement SW: DASY4, V4.7 Build 53; Postprocessing SW: SEMCAD, V1.8 Build 172

**E Scan - ER probe center 10mm above CD1880 Dipole/Hearing Aid Compatibility Test**

**(41x181x1):** Measurement grid: dx=5mm, dy=5mm

Maximum value of peak Total field = **125.6** V/m

Probe Modulation Factor = 1.00

Reference Value = 127.3 V/m; Power Drift = -0.103 dB

**Hearing Aid Near-Field Category: M2 (AWF 0 dB)**

Peak E-field in V/m

Grid 1	Grid 2	Grid 3
<b>121.2</b>	<b>125.4</b>	<b>121.9</b>
Grid 4	Grid 5	Grid 6
<b>81.3</b>	<b>86.6</b>	<b>85.8</b>
Grid 7	Grid 8	Grid 9
<b>119.3</b>	<b>125.6</b>	<b>124.2</b>

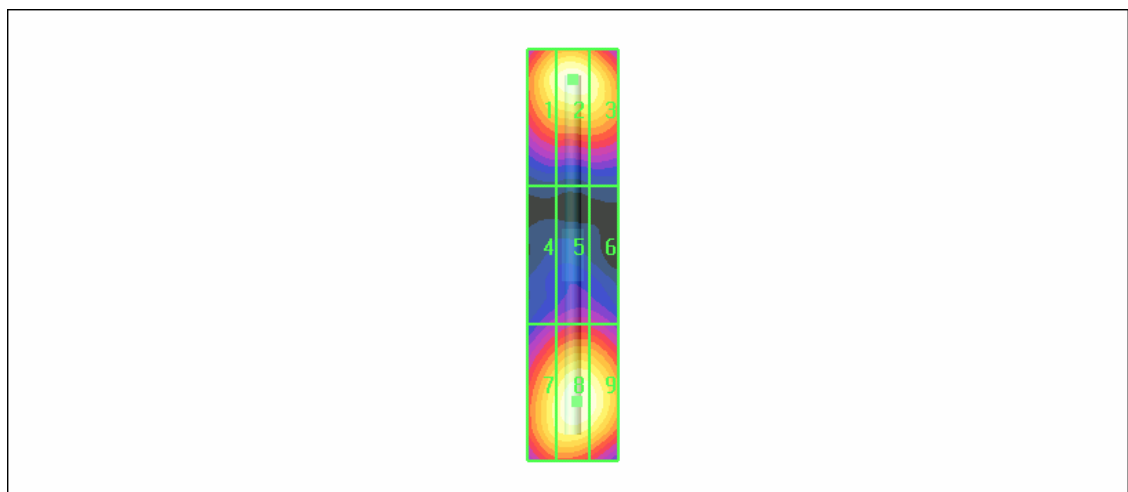
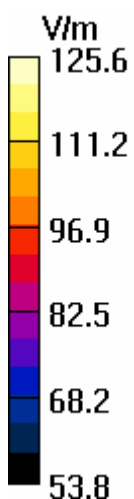

Test Laboratory: Advance Data Technology

**E-1880MHz (AM 80%)**

**DUT: HAC Dipole 1880 MHz ; Type: CD1880V3 ; Serial: 1032 ; Test Frequency: 1880 MHz**

Communication System: AM ; Frequency: 1880 MHz; Duty Cycle: 1:1; Modulation type: AM  
 Medium: Air;Medium parameters used:  $\sigma = 0$  mho/m,  $\epsilon_r = 1$ ;  $\rho = 1000$  kg/m<sup>3</sup>  
 Phantom section: E Dipole Section Measurement Standard: DASY4 (High Precision Assessment);

DASY4 Configuration:

- Probe: ER3DV6 - SN2293 ; ConvF(1, 1, 1) ; Calibrated: 2007/1/23
- Sensor-Surface: (Fix Surface)
- Electronics: DAE3 Sn510; Calibrated: 2007/8/29
- Phantom: HAC Test Arch; Type: SD HAC P01 BA; Serial:
- Measurement SW: DASY4, V4.7 Build 53; Postprocessing SW: SEMCAD, V1.8 Build 172

**E Scan - ER probe center 10mm above CD1880 Dipole/Hearing Aid Compatibility Test**

**(41x181x1):** Measurement grid: dx=5mm, dy=5mm

Maximum value of peak Total field = **112.3** V/m

Probe Modulation Factor = 1.00

Reference Value = 115.8 V/m; Power Drift = -0.076 dB

**Hearing Aid Near-Field Category: M2 (AWF 0 dB)**

Peak E-field in V/m

Grid 1	Grid 2	Grid 3
<b>109.8</b>	<b>112.2</b>	<b>108.8</b>
Grid 4	Grid 5	Grid 6
<b>73.7</b>	<b>77.6</b>	<b>77.0</b>
Grid 7	Grid 8	Grid 9
<b>107.8</b>	<b>112.3</b>	<b>111.7</b>

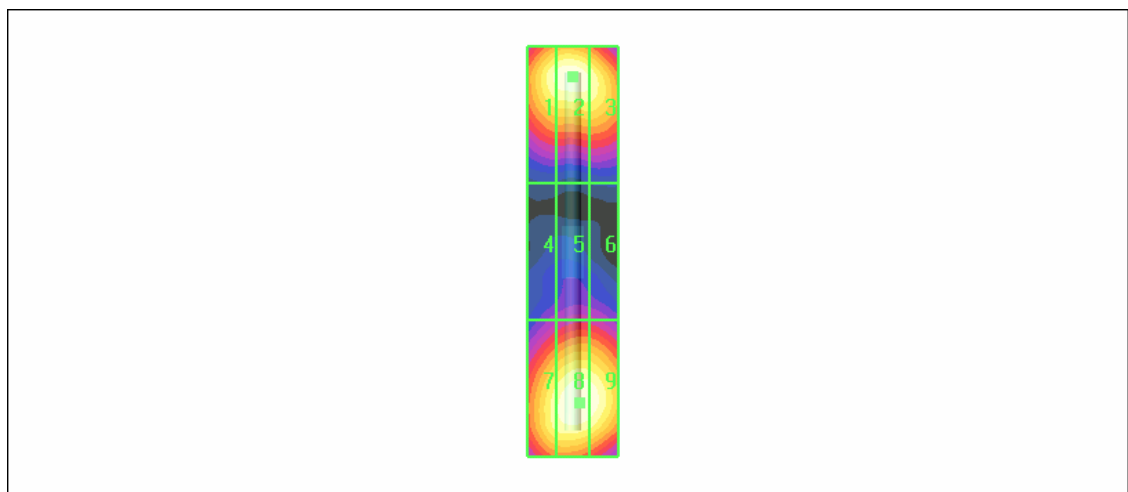
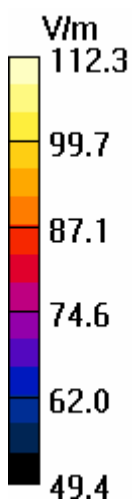

Test Laboratory: Advance Data Technology

**H-1880MHz (WD)**

**DUT: HAC Dipole 1880 MHz ; Type: CD1880V3 ; Serial: 1032 ; Test Frequency: 1880 MHz**

Communication System: CDMA ; Frequency: 1880 MHz; Duty Cycle: 1:1; Modulation type: OQPSK  
 Medium: Air; Medium parameters used:  $\sigma = 0$  mho/m,  $\epsilon_r = 1$ ;  $\rho = 1$  kg/m<sup>3</sup>  
 Phantom section: H Dipole Section Measurement Standard: DASy4 (High Precision Assessment);

DASY4 Configuration:

- Probe: H3DV6 - SN6124 ; ; Calibrated: 2007/1/23
- Sensor-Surface: (Fix Surface)
- Electronics: DAE3 Sn510; Calibrated: 2007/8/29
- Phantom: HAC Test Arch; Type: SD HAC P01 BA; Serial:
- Measurement SW: DASy4, V4.7 Build 53; Postprocessing SW: SEMCAD, V1.8 Build 172

**H Scan - ER probe center 10mm above CD1880 Dipole/Hearing Aid Compatibility Test**

**(41x181x1):** Measurement grid: dx=5mm, dy=5mm

Maximum value of peak Total field = **0.473** A/m

Probe Modulation Factor = 1.00

Reference Value = 0.499 A/m; Power Drift = -0.133 dB

**Hearing Aid Near-Field Category: M2 (AWF 0 dB)**

Peak H-field in A/m

Grid 1	Grid 2	Grid 3
<b>0.400</b>	<b>0.442</b>	<b>0.424</b>
Grid 4	<b>Grid 5</b>	Grid 6
<b>0.433</b>	<b>0.473</b>	<b>0.457</b>
Grid 7	Grid 8	Grid 9
<b>0.386</b>	<b>0.424</b>	<b>0.408</b>

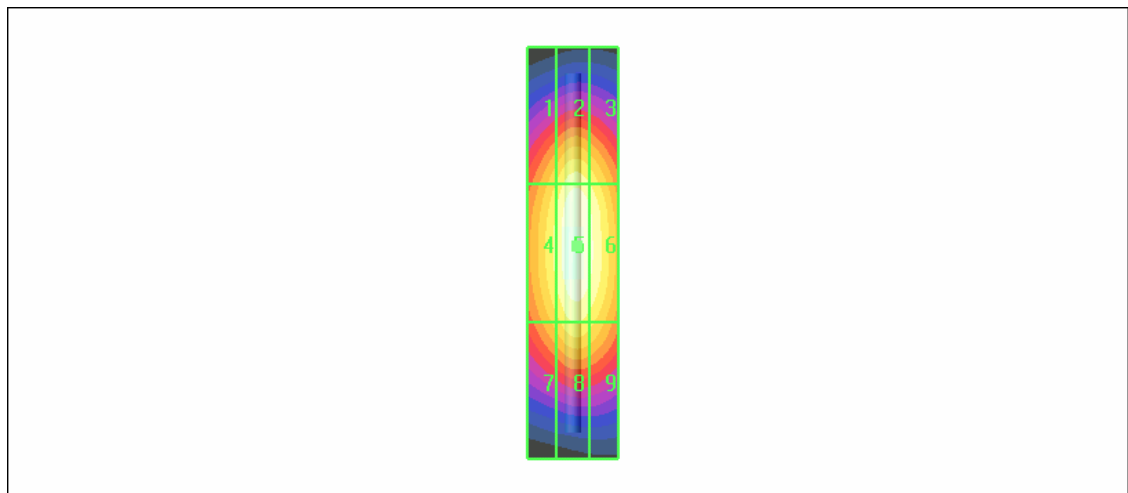
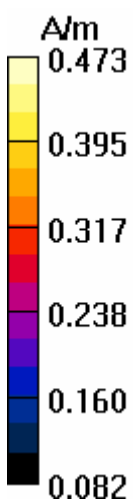

Test Laboratory: Advance Data Technology

**H-1880MHz (CW)**

**DUT: HAC Dipole 1880 MHz ; Type: CD1880V3 ; Serial: 1032 ; Test Frequency: 1880 MHz**

Communication System: CW ; Frequency: 1880 MHz; Duty Cycle: 1:1; Modulation type: CW  
 Medium: Air;Medium parameters used:  $\sigma = 0$  mho/m,  $\epsilon_r = 1$ ;  $\rho = 1$  kg/m<sup>3</sup>  
 Phantom section: H Dipole Section Measurement Standard: DASY4 (High Precision Assessment);

DASY4 Configuration:

- Probe: H3DV6 - SN6124 ; ; Calibrated: 2007/1/23
- Sensor-Surface: (Fix Surface)
- Electronics: DAE3 Sn510; Calibrated: 2007/8/29
- Phantom: HAC Test Arch; Type: SD HAC P01 BA; Serial:
- Measurement SW: DASY4, V4.7 Build 53; Postprocessing SW: SEMCAD, V1.8 Build 172

**H Scan - ER probe center 10mm above CD1880 Dipole/Hearing Aid Compatibility Test**

**(41x181x1):** Measurement grid: dx=5mm, dy=5mm

Maximum value of peak Total field = **0.441** A/m

Probe Modulation Factor = 1.00

Reference Value = 0.464 A/m; Power Drift = -0.002 dB

**Hearing Aid Near-Field Category: M2 (AWF 0 dB)**

Peak H-field in A/m

Grid 1	Grid 2	Grid 3
<b>0.375</b>	<b>0.412</b>	<b>0.400</b>
Grid 4	<b>Grid 5</b>	Grid 6
<b>0.406</b>	<b>0.441</b>	<b>0.430</b>
Grid 7	Grid 8	Grid 9
<b>0.365</b>	<b>0.395</b>	<b>0.388</b>

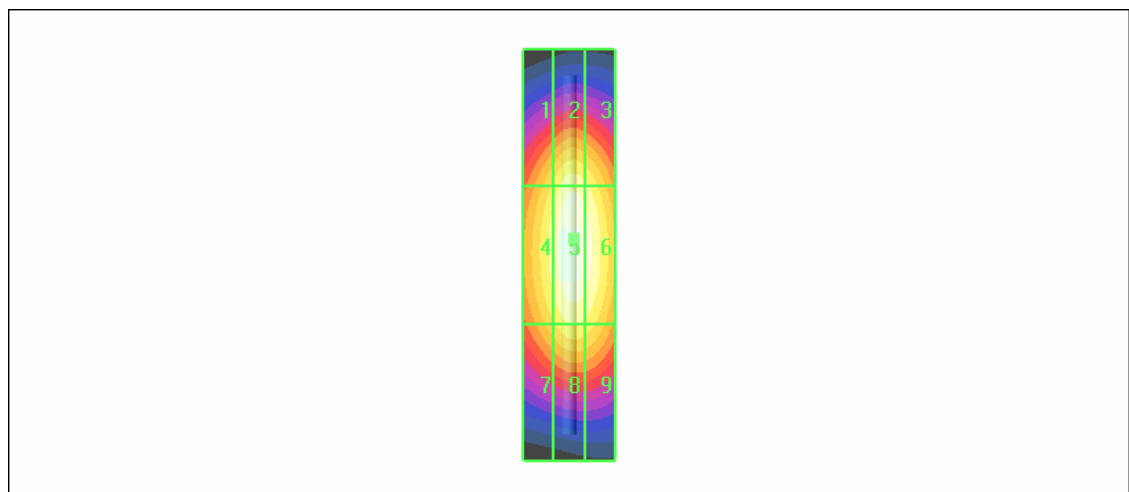
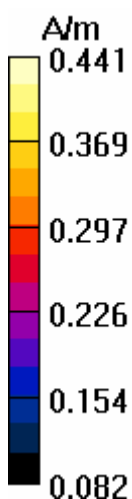

Test Laboratory: Advance Data Technology

**H-1880MHz (AM 80%)**

**DUT: HAC Dipole 1880 MHz ; Type: CD1880V3 ; Serial: 1032 ; Test Frequency: 1880 MHz**

Communication System: AM ; Frequency: 1880 MHz; Duty Cycle: 1:1; Modulation type: AM  
 Medium: Air;Medium parameters used:  $\sigma = 0$  mho/m,  $\epsilon_r = 1$ ;  $\rho = 1$  kg/m<sup>3</sup>  
 Phantom section: H Dipole Section Measurement Standard: DASY4 (High Precision Assessment);

DASY4 Configuration:

- Probe: H3DV6 - SN6124 ; ; Calibrated: 2007/1/23
- Sensor-Surface: (Fix Surface)
- Electronics: DAE3 Sn510; Calibrated: 2007/8/29
- Phantom: HAC Test Arch; Type: SD HAC P01 BA; Serial:
- Measurement SW: DASY4, V4.7 Build 53; Postprocessing SW: SEMCAD, V1.8 Build 172

**H Scan - ER probe center 10mm above CD1880 Dipole/Hearing Aid Compatibility Test**

**(41x181x1):** Measurement grid: dx=5mm, dy=5mm

Maximum value of peak Total field = **0.429** A/m

Probe Modulation Factor = 1.00

Reference Value = 0.451 A/m; Power Drift = -0.146 dB

**Hearing Aid Near-Field Category: M2 (AWF 0 dB)**

Peak H-field in A/m

Grid 1	Grid 2	Grid 3
<b>0.358</b>	<b>0.396</b>	<b>0.380</b>
Grid 4	Grid 5	Grid 6
<b>0.389</b>	<b>0.429</b>	<b>0.414</b>
Grid 7	Grid 8	Grid 9
<b>0.342</b>	<b>0.378</b>	<b>0.369</b>

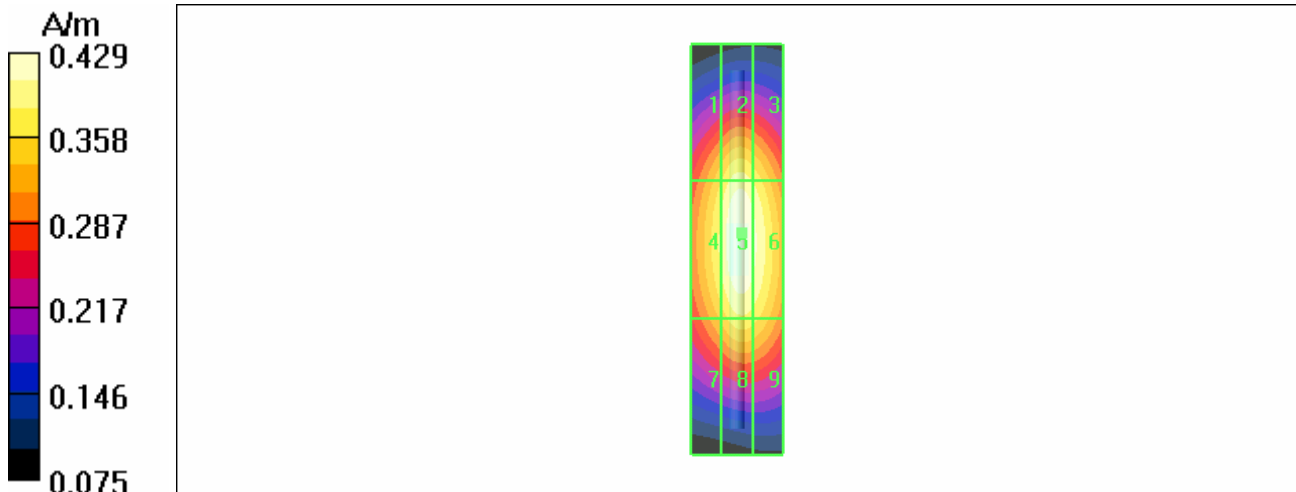

Test Laboratory: Advance Data Technology

**E-835MHz (System Validation)**

**DUT: HAC-Dipole 835 MHz ; Type: D835V3 ; Serial: 1041 ; Test Frequency: 835 MHz**

Communication System: CW ; Frequency: 835 MHz; Duty Cycle: 1:1; Modulation type: CW

Medium: Air;Medium parameters used:  $\sigma = 0$  mho/m,  $\epsilon_r = 1$ ;  $\rho = 1000$  kg/m<sup>3</sup>

Phantom section: E Dipole Section Measurement Standard: DASY4 (High Precision Assessment);

DASY4 Configuration:

- Probe: ER3DV6 - SN2293 ; ConvF(1, 1, 1) ; Calibrated: 2007/1/23
- Sensor-Surface: (Fix Surface)
- Electronics: DAE3 Sn510; Calibrated: 2007/8/29
- Phantom: HAC Test Arch; Type: SD HAC P01 BA; Serial:
- Measurement SW: DASY4, V4.7 Build 53; Postprocessing SW: SEMCAD, V1.8 Build 172

**E Scan - ER probe center 10mm above CD835 Dipole/Hearing Aid Compatibility Test**

**(41x361x1):** Measurement grid: dx=5mm, dy=5mm

Maximum value of peak Total field = **160.3** V/m

Probe Modulation Factor = 1.00

Reference Value = 117.7 V/m; Power Drift = -0.171 dB

**Hearing Aid Near-Field Category: M4 (AWF 0 dB)**

Peak E-field in V/m

Grid 1	Grid 2	Grid 3
<b>146.8</b>	<b>160.3</b>	<b>160.1</b>
Grid 4	Grid 5	Grid 6
<b>82.7</b>	<b>86.9</b>	<b>84.7</b>
Grid 7	Grid 8	Grid 9
<b>157.6</b>	<b>160.0</b>	<b>154.4</b>

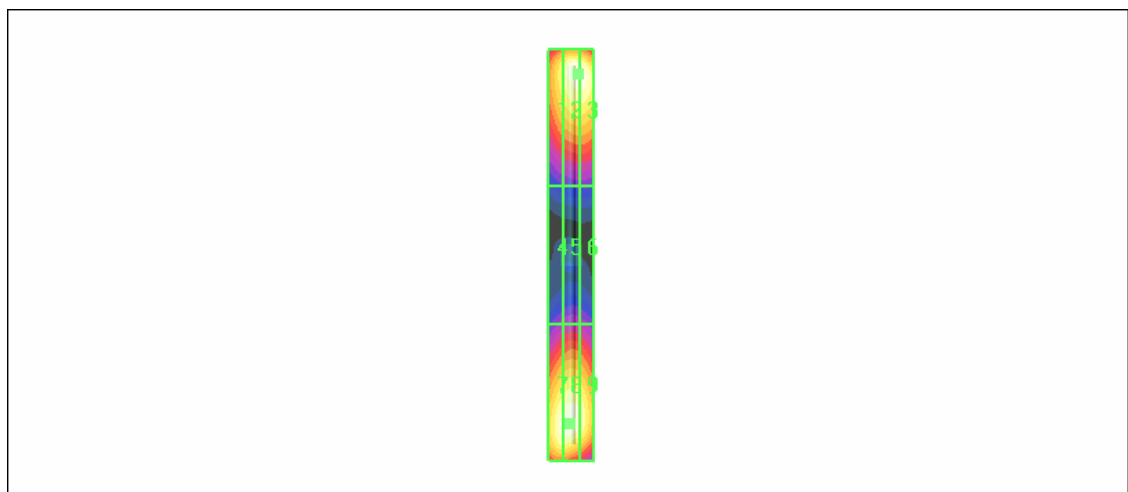
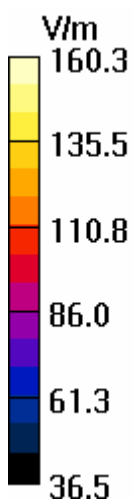

Test Laboratory: Advance Data Technology

**E-1880MHz (System Validation)**

**DUT: HAC Dipole 1880 MHz ; Type: CD1880V3 ; Serial: 1032 ; Test Frequency: 1880 MHz**

Communication System: CW ; Frequency: 1880 MHz; Duty Cycle: 1:1; Modulation type: CW  
 Medium: Air;Medium parameters used:  $\sigma = 0$  mho/m,  $\epsilon_r = 1$ ;  $\rho = 1000$  kg/m<sup>3</sup>  
 Phantom section: E Dipole Section Measurement Standard: DASY4 (High Precision Assessment);

DASY4 Configuration:

- Probe: ER3DV6 - SN2293 ; ConvF(1, 1, 1) ; Calibrated: 2007/1/23
- Sensor-Surface: (Fix Surface)
- Electronics: DAE3 Sn510; Calibrated: 2007/8/29
- Phantom: HAC Test Arch; Type: SD HAC P01 BA; Serial:
- Measurement SW: DASY4, V4.7 Build 53; Postprocessing SW: SEMCAD, V1.8 Build 172

**E Scan - ER probe center 10mm above CD1880 Dipole 2/Hearing Aid Compatibility Test**

**(41x181x1):** Measurement grid: dx=5mm, dy=5mm

Maximum value of peak Total field = **129.7** V/m

Probe Modulation Factor = 1.00

Reference Value = 129.6 V/m; Power Drift = -0.138 dB

**Hearing Aid Near-Field Category: M2 (AWF 0 dB)**

Peak E-field in V/m

Grid 1	Grid 2	Grid 3
<b>125.7</b>	<b>129.7</b>	<b>125.9</b>
Grid 4	Grid 5	Grid 6
<b>82.0</b>	<b>86.9</b>	<b>85.6</b>
Grid 7	Grid 8	Grid 9
<b>123.0</b>	<b>128.2</b>	<b>126.0</b>

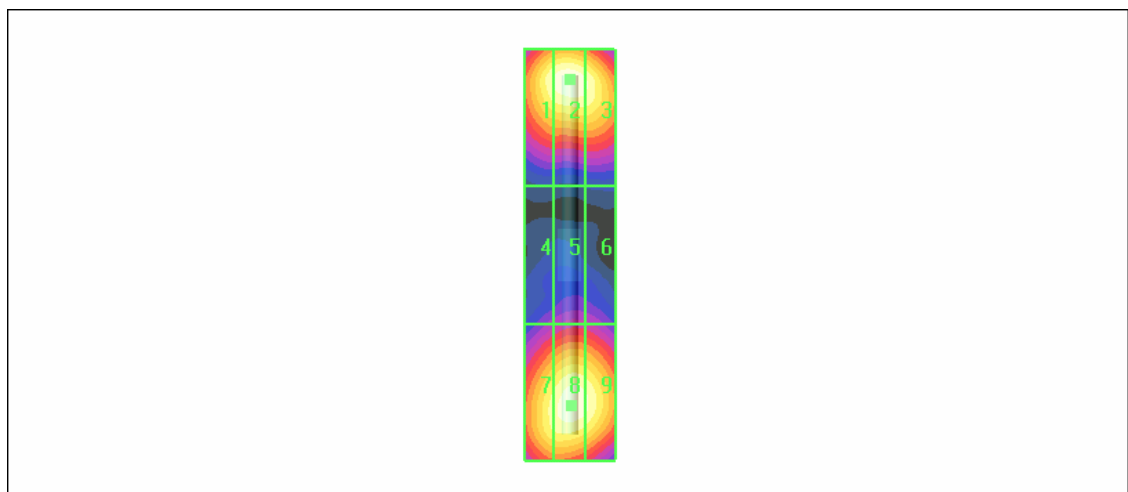
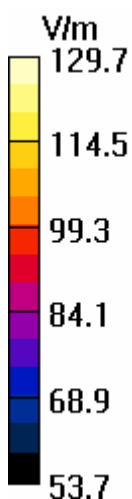

Test Laboratory: Advance Data Technology

**H-835MHz (System Validation)**

**DUT: HAC-Dipole 835 MHz ; Type: D835V3 ; Serial: 1041 ; Test Frequency: 835 MHz**

Communication System: CW ; Frequency: 835 MHz; Duty Cycle: 1:1; Modulation type: CW

Medium: Air;Medium parameters used:  $\sigma = 0$  mho/m,  $\epsilon_r = 1$ ;  $\rho = 1$  kg/m<sup>3</sup>

Phantom section: H Dipole Section Measurement Standard: DAS4 (High Precision Assessment);

DASY4 Configuration:

- Probe: H3DV6 - SN6124 ; ; Calibrated: 2007/1/23
- Sensor-Surface: (Fix Surface)
- Electronics: DAE3 Sn510; Calibrated: 2007/8/29
- Phantom: HAC Test Arch; Type: SD HAC P01 BA; Serial:
- Measurement SW: DAS4, V4.7 Build 53; Postprocessing SW: SEMCAD, V1.8 Build 172

**H Scan - ER probe center 10mm above CD835 Dipole/Hearing Aid Compatibility Test**

**(41x361x1):** Measurement grid: dx=5mm, dy=5mm

Maximum value of peak Total field = **0.456** A/m

Probe Modulation Factor = 1.00

Reference Value = 0.475 A/m; Power Drift = -0.215 dB

**Hearing Aid Near-Field Category: M4 (AWF 0 dB)**

Peak H-field in A/m

Grid 1	Grid 2	Grid 3
<b>0.366</b>	<b>0.406</b>	<b>0.395</b>
Grid 4	<b>Grid 5</b>	Grid 6
<b>0.414</b>	<b>0.456</b>	<b>0.448</b>
Grid 7	Grid 8	Grid 9
<b>0.367</b>	<b>0.408</b>	<b>0.401</b>

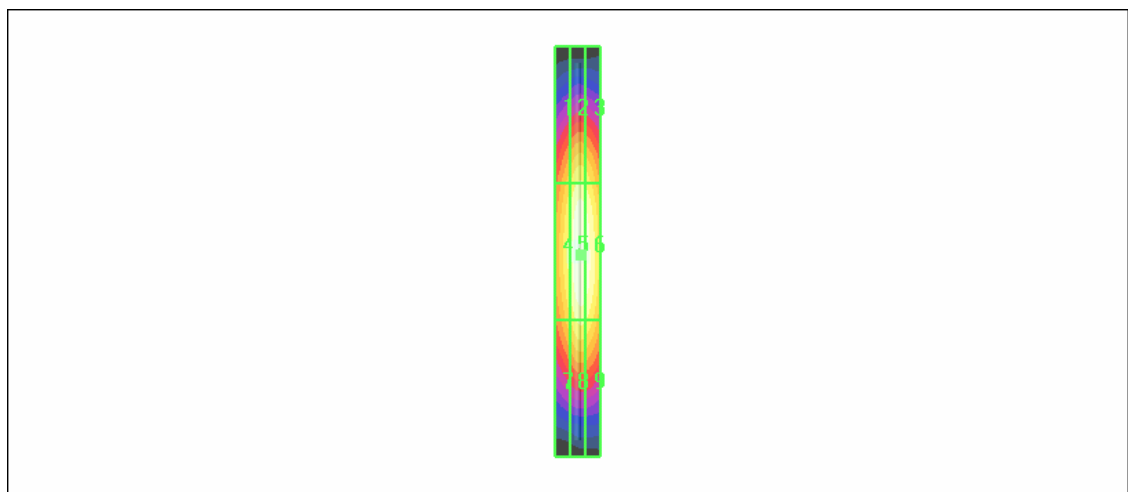
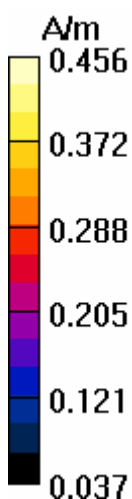



Test Laboratory: Advance Data Technology

**H-1880MHz (System Validation)**

**DUT: HAC Dipole 1880 MHz ; Type: CD1880V3 ; Serial: 1032 ; Test Frequency: 1880 MHz**

Communication System: CW ; Frequency: 1880 MHz; Duty Cycle: 1:1; Modulation type: CW  
 Medium: Air;Medium parameters used:  $\sigma = 0$  mho/m,  $\epsilon_r = 1$ ;  $\rho = 1$  kg/m<sup>3</sup>  
 Phantom section: H Dipole Section Measurement Standard: DAS4 (High Precision Assessment);

DASY4 Configuration:

- Probe: H3DV6 - SN6124 ; ; Calibrated: 2007/1/23
- Sensor-Surface: (Fix Surface)
- Electronics: DAE3 Sn510; Calibrated: 2007/8/29
- Phantom: HAC Test Arch; Type: SD HAC P01 BA; Serial:
- Measurement SW: DAS4, V4.7 Build 53; Postprocessing SW: SEMCAD, V1.8 Build 172

**H Scan - ER probe center 10mm above CD1880 Dipole/Hearing Aid Compatibility Test**

**(41x181x1):** Measurement grid: dx=5mm, dy=5mm

Maximum value of peak Total field = **0.437** A/m

Probe Modulation Factor = 1.00

Reference Value = 0.455 A/m; Power Drift = -0.104 dB

**Hearing Aid Near-Field Category: M2 (AWF 0 dB)**

Peak H-field in A/m

Grid 1	Grid 2	Grid 3
<b>0.369</b>	<b>0.407</b>	<b>0.397</b>
Grid 4	Grid 5	Grid 6
<b>0.401</b>	<b>0.437</b>	<b>0.427</b>
Grid 7	Grid 8	Grid 9
<b>0.361</b>	<b>0.394</b>	<b>0.387</b>

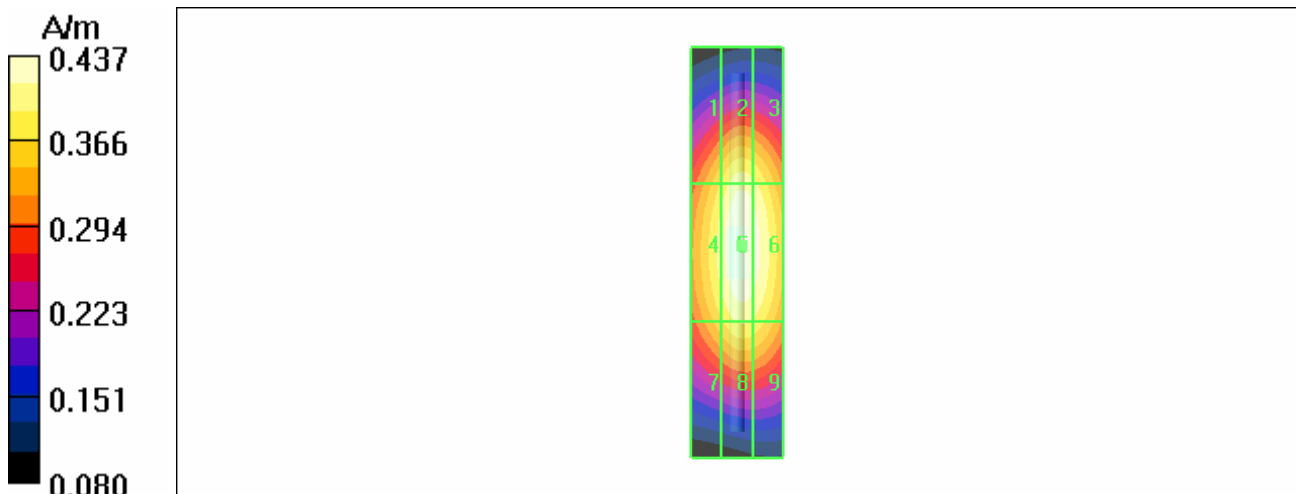



## **APPENDIX B: SYSTEM CERTIFICATE & CALIBRATION**

### **B1: E-FIELD PROBE**



Accredited by the Swiss Federal Office of Metrology and Accreditation  
The Swiss Accreditation Service is one of the signatories to the EA  
Multilateral Agreement for the recognition of calibration certificates

Accreditation No.: **SCS 108**

Client **ADT (Auden)**

Certificate No: **ER3-2293\_Jan07**

## CALIBRATION CERTIFICATE

Object **ER3DV6 - SN:2293**

Calibration procedure(s) **QA CAL-02.v4  
Calibration procedure for E-field probes optimized for close near field  
evaluations in air**

Calibration date: **January 23, 2007**

Condition of the calibrated item **In Tolerance**

This calibration certificate documents the traceability to national standards, which realize the physical units of measurements (SI).  
The measurements and the uncertainties with confidence probability are given on the following pages and are part of the certificate.

All calibrations have been conducted in the closed laboratory facility: environment temperature (22 ± 3)°C and humidity < 70%.

Calibration Equipment used (M&TE critical for calibration)

Primary Standards	ID #	Cal Date (Calibrated by, Certificate No.)	Scheduled Calibration
Power meter E4419B	GB41293874	5-Apr-06 (METAS, No. 251-00557)	Apr-07
Power sensor E4412A	MY41495277	5-Apr-06 (METAS, No. 251-00557)	Apr-07
Power sensor E4412A	MY41498087	5-Apr-06 (METAS, No. 251-00557)	Apr-07
Reference 3 dB Attenuator	SN: S5054 (3c)	10-Aug-06 (METAS, No. 217-00592)	Aug-07
Reference 20 dB Attenuator	SN: S5086 (20b)	4-Apr-06 (METAS, No. 251-00558)	Apr-07
Reference 30 dB Attenuator	SN: S5129 (30b)	10-Aug-06 (METAS, No. 217-00593)	Aug-07
Reference Probe ER3DV6	SN: 2328	2-Oct-06 (SPEAG, No. ER3-2328_Oct06)	Oct-07
DAE4	SN: 654	21-Jun-06 (SPEAG, No. DAE4-654_Jun06)	Jun-07
Secondary Standards	ID #	Check Date (in house)	Scheduled Check
RF generator HP 8648C	US3642U01700	4-Aug-99 (SPEAG, in house check Nov-05)	In house check: Nov-07
Network Analyzer HP 8753E	US37390585	18-Oct-01 (SPEAG, in house check Oct-06)	In house check: Oct-07

Calibrated by: **Katja Pokovic** (Name), **Technical Manager** (Function), *[Signature]* (Signature)

Approved by: **Niels Kuster** (Name), **Quality Manager** (Function), *[Signature]* (Signature)

Issued: January 23, 2007

This calibration certificate shall not be reproduced except in full without written approval of the laboratory.

**Calibration Laboratory of  
Schmid & Partner  
Engineering AG**  
Zeughausstrasse 43, 8004 Zurich, Switzerland



**S** Schweizerischer Kalibrierdienst  
**C** Service suisse d'étalonnage  
**S** Servizio svizzero di taratura  
**S** Swiss Calibration Service

Accredited by the Swiss Federal Office of Metrology and Accreditation  
The Swiss Accreditation Service is one of the signatories to the EA  
Multilateral Agreement for the recognition of calibration certificates

Accreditation No.: **SCS 108**

### Glossary:

NORM <sub>x,y,z</sub>	sensitivity in free space
DCP	diode compression point
Polarization $\varphi$	$\varphi$ rotation around probe axis
Polarization $\vartheta$	$\vartheta$ rotation around an axis that is in the plane normal to probe axis (at measurement center), i.e., $\vartheta = 0$ is normal to probe axis
Connector Angle	information used in DASY system to align probe sensor X to the robot coordinate system

### Calibration is Performed According to the Following Standards:

- IEEE Std 1309-1996, "IEEE Standard for calibration of electromagnetic field sensors and probes, excluding antennas, from 9 kHz to 40 GHz", 1996.

### Methods Applied and Interpretation of Parameters:

- NORM<sub>x,y,z</sub>*: Assessed for E-field polarization  $\vartheta = 0$  for XY sensors and  $\vartheta = 90$  for Z sensor ( $f \leq 900$  MHz in TEM-cell;  $f > 1800$  MHz: R22 waveguide).
- NORM(f)<sub>x,y,z</sub>* = *NORM<sub>x,y,z</sub>* \* *frequency\_response* (see Frequency Response Chart).
- DCP<sub>x,y,z</sub>*: DCP are numerical linearization parameters assessed based on the data of power sweep (no uncertainty required). DCP does not depend on frequency.
- Spherical isotropy (3D deviation from isotropy)*: in a locally homogeneous field realized using an open waveguide setup.
- Sensor Offset*: The sensor offset corresponds to the offset of virtual measurement center from the probe tip (on probe axis). No tolerance required.
- Connector Angle*: The angle is assessed using the information gained by determining the *NORM<sub>x</sub>* (no uncertainty required).

# Probe ER3DV6

## SN:2293

Manufactured:	October 1, 2002
Last calibrated:	September 22, 2005
Recalibrated:	January 23, 2007

Calibrated for DASY Systems

(Note: non-compatible with DASY2 system!)

**DASY - Parameters of Probe: ER3DV6 SN:2293**

Sensitivity in Free Space [ $\mu\text{V}/(\text{V}/\text{m})^2$ ]		Diode Compression <sup>A</sup>	
NormX	1.27 ± 10.1 % (k=2)	DCP X	95 mV
NormY	1.06 ± 10.1 % (k=2)	DCP Y	95 mV
NormZ	1.42 ± 10.1 % (k=2)	DCP Z	96 mV

## Frequency Correction

X	0.0
Y	0.0
Z	0.0

## Sensor Offset (Probe Tip to Sensor Center)

X	2.5 mm
Y	2.5 mm
Z	2.5 mm

## Connector Angle -12 °

**The reported uncertainty of measurement is stated as the standard uncertainty of measurement multiplied by the coverage factor k=2, which for a normal distribution corresponds to a coverage probability of approximately 95%.**

<sup>A</sup> numerical linearization parameter: uncertainty not required

## Frequency Response of E-Field

(TEM-Cell:ifi110 EXX, Waveguide R22)

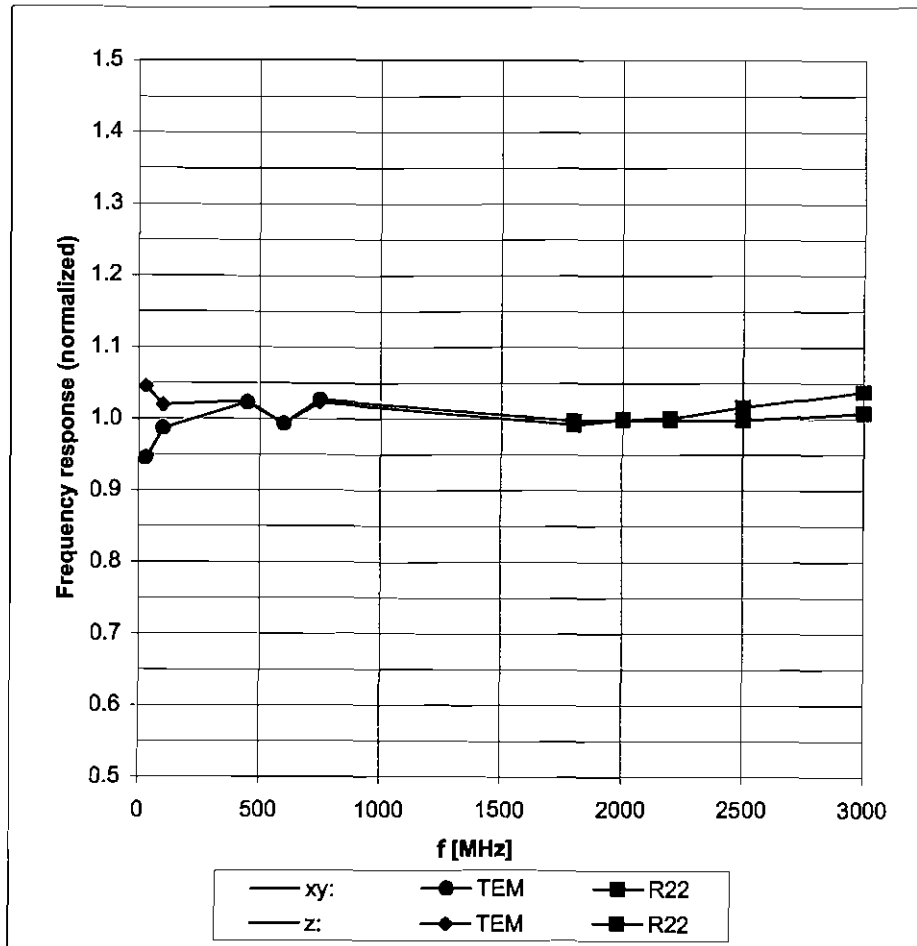

**Uncertainty of Frequency Response of E-field:  $\pm 6.3\%$  ( $k=2$ )**

### Receiving Pattern ( $\phi$ ), $\vartheta = 0^\circ$

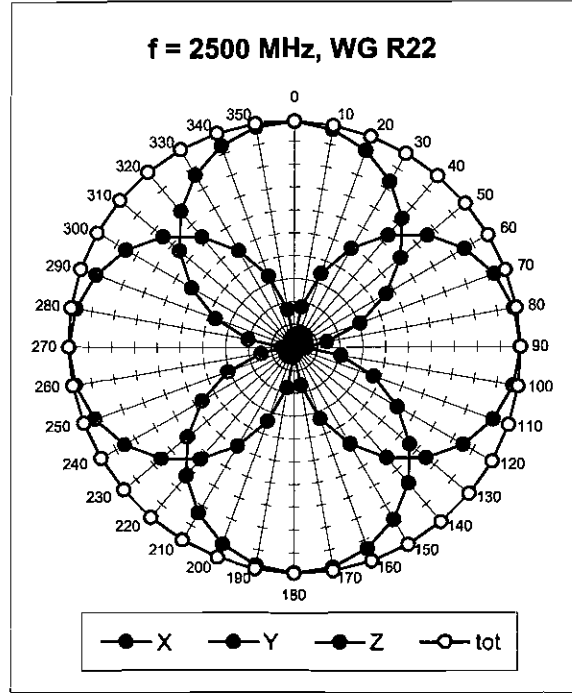
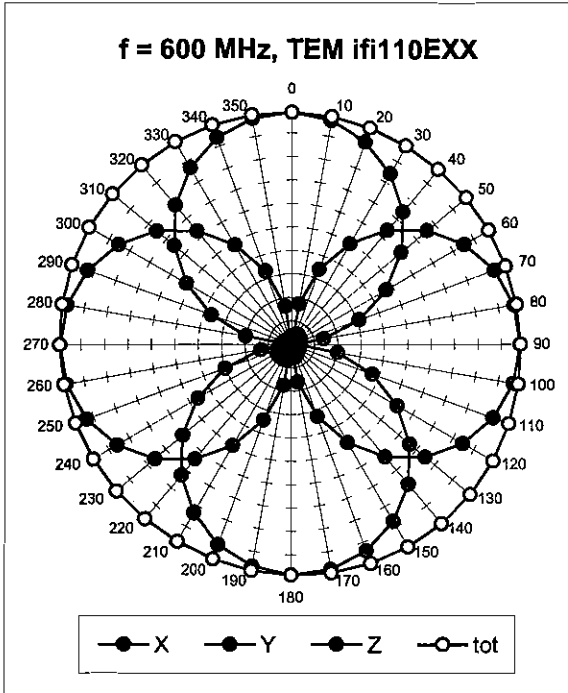

### Receiving Pattern ( $\phi$ ), $\vartheta = 90^\circ$

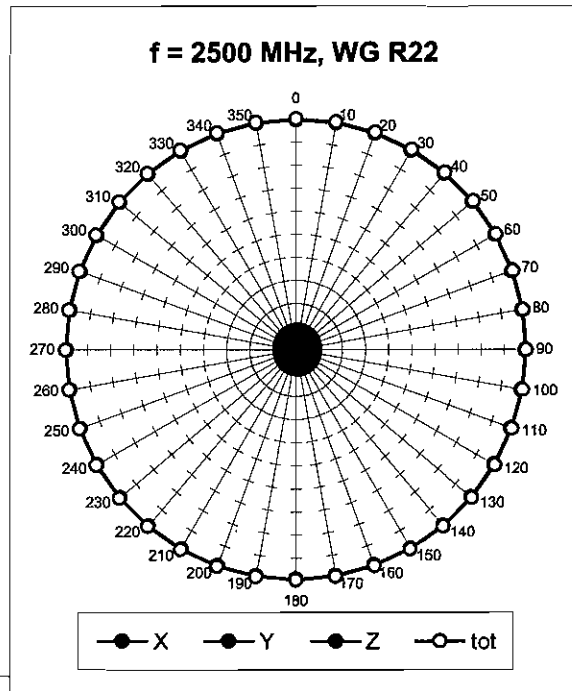
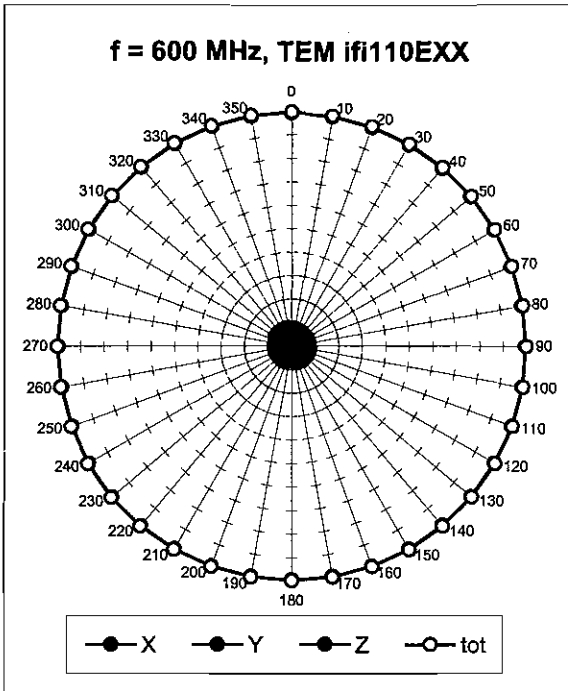



### Receiving Pattern ( $\phi$ ), $\vartheta = 0^\circ$

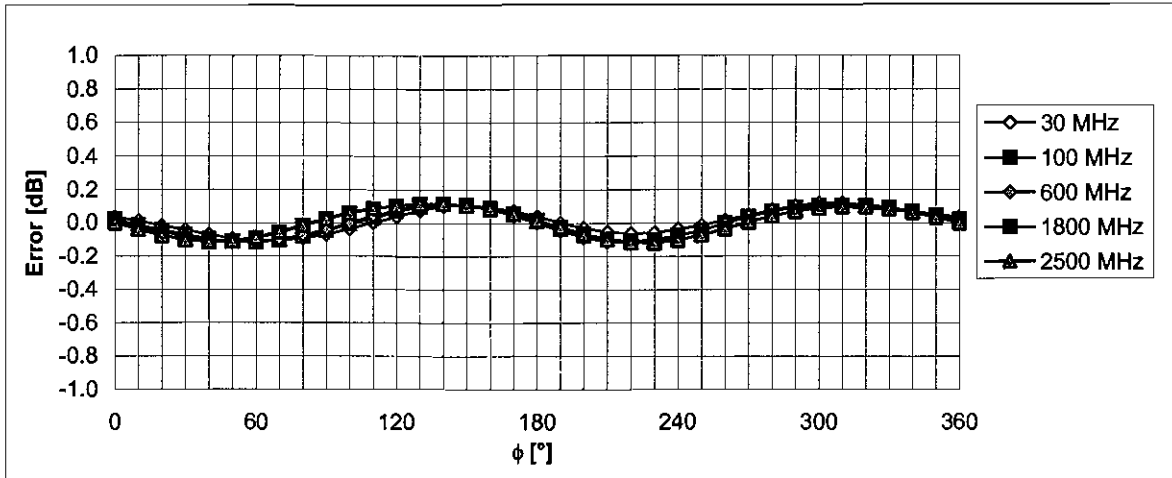

Uncertainty of Axial Isotropy Assessment:  $\pm 0.5\%$  ( $k=2$ )

### Receiving Pattern ( $\phi$ ), $\vartheta = 90^\circ$

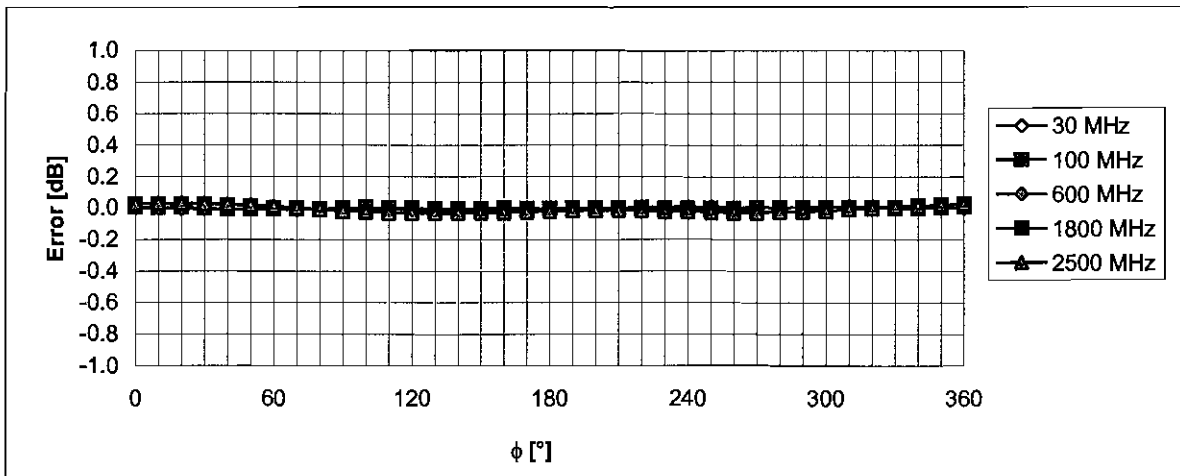

Uncertainty of Axial Isotropy Assessment:  $\pm 0.5\%$  ( $k=2$ )

### Dynamic Range f(E-field) (Waveguide R22, f = 1800 MHz)

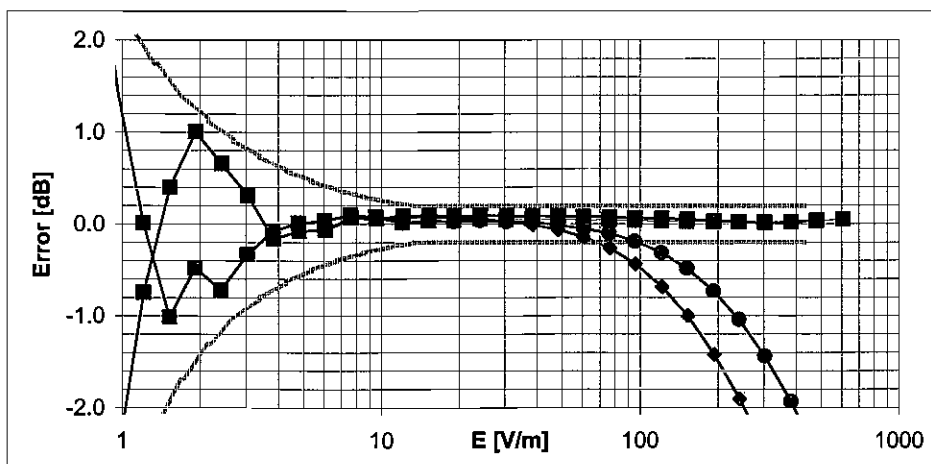
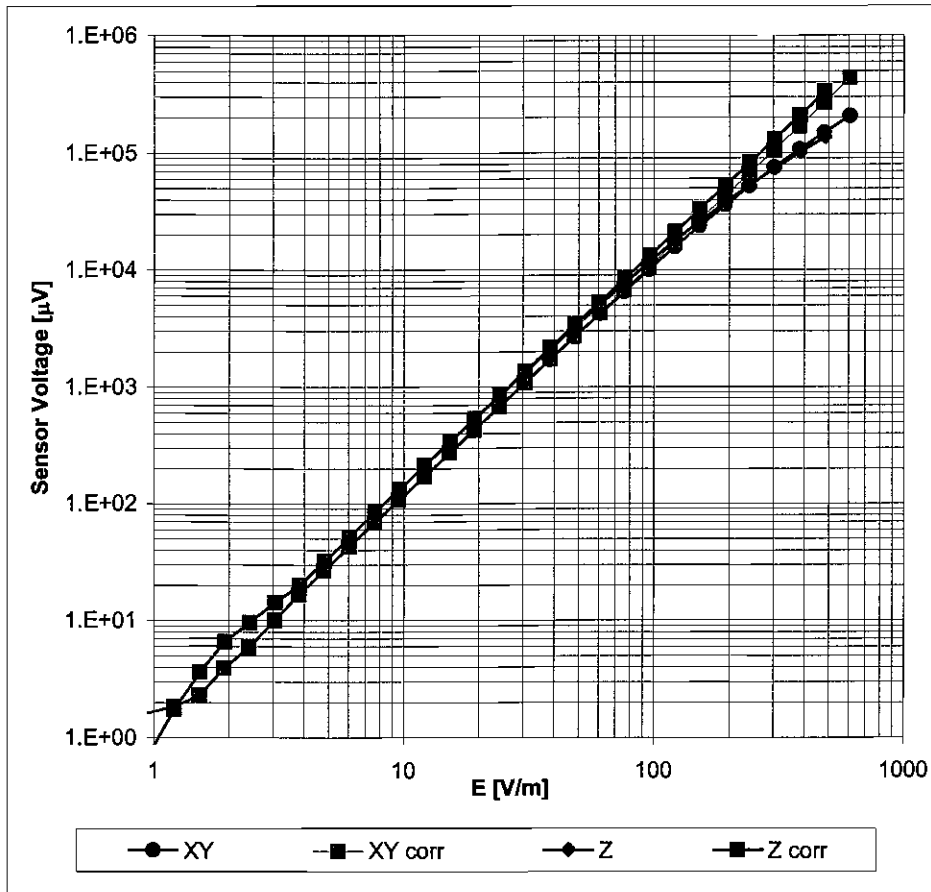

Uncertainty of Linearity Assessment:  $\pm 0.6\%$  (k=2)

### Deviation from Isotropy in Air Error ( $\phi, \vartheta$ ), $f = 900$ MHz

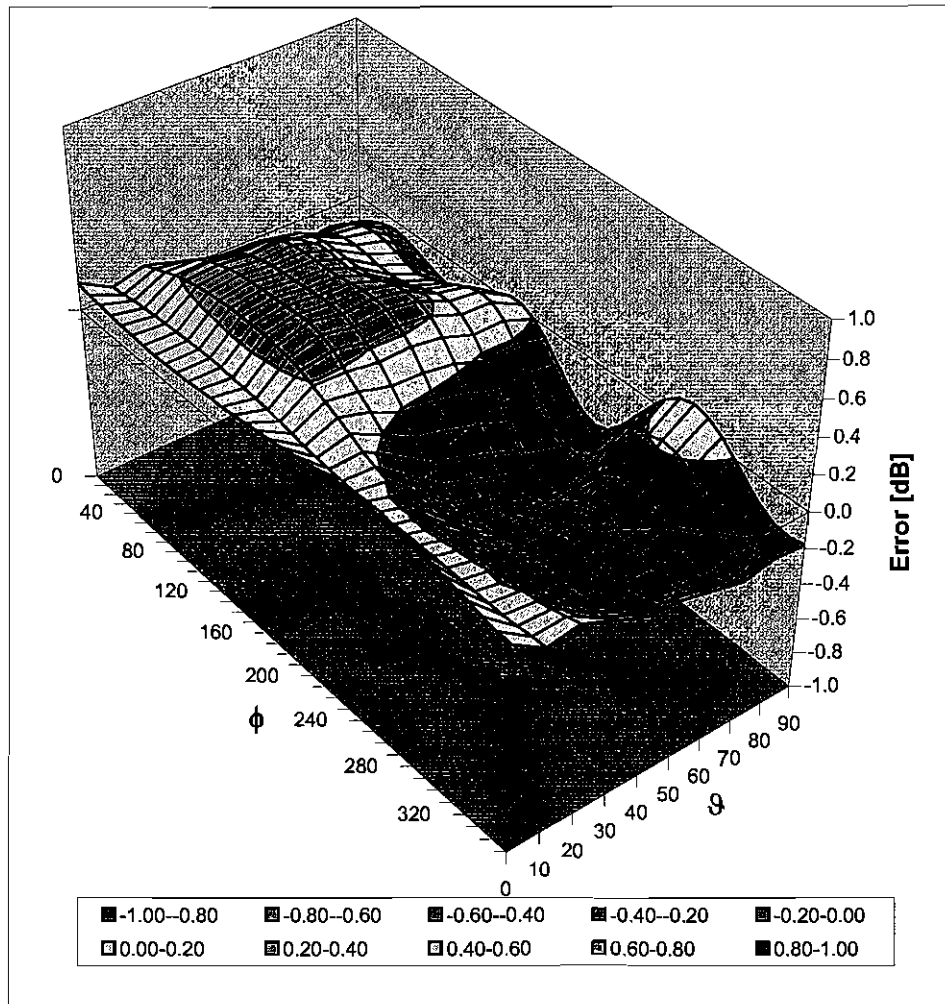

Uncertainty of Spherical Isotropy Assessment:  $\pm 2.6\%$  ( $k=2$ )



## **B2: H-FIELD PROBE**



Accredited by the Swiss Federal Office of Metrology and Accreditation  
The Swiss Accreditation Service is one of the signatories to the EA  
Multilateral Agreement for the recognition of calibration certificates

Accreditation No.: **SCS 108**

Client **ADT (Auden)**

Certificate No: **H3-6124\_Jan07**

## CALIBRATION CERTIFICATE

Object **H3DV6 - SN:6124**

Calibration procedure(s) **QA CAL-03-v4  
Calibration procedure for H-field probes optimized for close near field  
evaluations in air**

Calibration date: **January 23, 2007**

Condition of the calibrated item **In Tolerance**

This calibration certificate documents the traceability to national standards, which realize the physical units of measurements (SI).  
The measurements and the uncertainties with confidence probability are given on the following pages and are part of the certificate.

All calibrations have been conducted in the closed laboratory facility: environment temperature (22 ± 3)°C and humidity < 70%.

Calibration Equipment used (M&TE critical for calibration)

Primary Standards	ID #	Cal Date (Calibrated by, Certificate No.)	Scheduled Calibration
Power meter E4419B	GB41293874	5-Apr-06 (METAS, No. 251-00557)	Apr-07
Power sensor E4412A	MY41495277	5-Apr-06 (METAS, No. 251-00557)	Apr-07
Power sensor E4412A	MY41498087	5-Apr-06 (METAS, No. 251-00557)	Apr-07
Reference 3 dB Attenuator	SN: S5054 (3c)	10-Aug-06 (METAS, No. 217-00592)	Aug-07
Reference 20 dB Attenuator	SN: S5086 (20b)	4-Apr-06 (METAS, No. 251-00558)	Apr-07
Reference 30 dB Attenuator	SN: S5129 (30b)	10-Aug-06 (METAS, No. 217-00593)	Aug-07
Reference Probe H3DV6	SN: 6182	2-Oct-06 (SPEAG, No. H3-6182_Oct06)	Oct-07
DAE4	SN: 654	21-Jun-06 (SPEAG, No. DAE4-654_Jun06)	Jun-07

Secondary Standards	ID #	Check Date (in house)	Scheduled Check
RF generator HP 8648C	US3642U01700	4-Aug-99 (SPEAG, in house check Nov-05)	In house check: Nov-07
Network Analyzer HP 8753E	US37390585	18-Oct-01 (SPEAG, in house check Oct-06)	In house check: Oct-07

	Name	Function	Signature
Calibrated by:	Katja Pokovic	Technical Manager	
Approved by:	Niels Kuster	Quality Manager	

issued: January 23, 2007

This calibration certificate shall not be reproduced except in full without written approval of the laboratory.

**Calibration Laboratory of  
Schmid & Partner  
Engineering AG**  
Zeughausstrasse 43, 8004 Zurich, Switzerland



**S** Schweizerischer Kalibrierdienst  
**C** Service suisse d'étalonnage  
**S** Servizio svizzero di taratura  
**S** Swiss Calibration Service

Accredited by the Swiss Federal Office of Metrology and Accreditation  
The Swiss Accreditation Service is one of the signatories to the EA  
Multilateral Agreement for the recognition of calibration certificates

Accreditation No.: **SCS 108**

### Glossary:

NORM <sub>x,y,z</sub>	sensitivity in free space
DCP	diode compression point
Polarization $\varphi$	$\varphi$ rotation around probe axis
Polarization $\vartheta$	$\vartheta$ rotation around an axis that is in the plane normal to probe axis (at measurement center), i.e., $\vartheta = 0$ is normal to probe axis
Connector Angle	information used in DASY system to align probe sensor X to the robot coordinate system

### Calibration is Performed According to the Following Standards:

- IEEE Std 1309-1996, "IEEE Standard for calibration of electromagnetic field sensors and probes, excluding antennas, from 9 kHz to 40 GHz", 1996.

### Methods Applied and Interpretation of Parameters:

- $X, Y, Z_{a0a1a2}$ : Assessed for E-field polarization  $\vartheta = 90$  for XY sensors and  $\vartheta = 0$  for Z sensor ( $f \leq 900$  MHz in TEM-cell;  $f > 1800$  MHz: R22 waveguide).
- $X, Y, Z(f)_{a0a1a2} = X, Y, Z_{a0a1a2} * \text{frequency\_response}$  (see Frequency Response Chart).
- $DCP_{x,y,z}$ : DCP are numerical linearization parameters assessed based on the data of power sweep (no uncertainty required). DCP does not depend on frequency.
- Spherical isotropy (3D deviation from isotropy)*: in a locally homogeneous field realized using an open waveguide setup.
- Sensor Offset*: The sensor offset corresponds to the offset of virtual measurement center from the probe tip (on probe axis). No tolerance required.
- Connector Angle*: The angle is assessed using the information gained by determining the  $X_{a0a1a2}$  (no uncertainty required).

# Probe H3DV6

## SN:6124

Manufactured:	June 8, 2002
Last calibrated:	September 22, 2005
Recalibrated:	January 23, 2007

Calibrated for DASY Systems

(Note: non-compatible with DASY2 system!)

**DASY - Parameters of Probe: H3DV6 SN:6124**Sensitivity in Free Space [A/m /  $\sqrt{(\mu\text{V})}$ ]

	a0	a1	a2
X	2.679E-03	-9.856E-5	5.307E-5 $\pm$ 5.1 % (k=2)
Y	2.790E-03	-2.467E-4	3.051E-5 $\pm$ 5.1 % (k=2)
Z	3.037E-03	-1.907E-4	1.047E-5 $\pm$ 5.1 % (k=2)

Diode Compression<sup>1</sup>

DCP X	86 mV
DCP Y	86 mV
DCP Z	88 mV

## Sensor Offset

(Probe Tip to Sensor Center)

X	3.0 mm
Y	3.0 mm
Z	3.0 mm

Connector Angle -25 °

The reported uncertainty of measurement is stated as the standard uncertainty of measurement multiplied by the coverage factor k=2, which for a normal distribution corresponds to a coverage probability of approximately 95%.

<sup>1</sup> numerical linearization parameter: uncertainty not required



### Frequency Response of H-Field (TEM-Cell:ifi110, Waveguide R22)

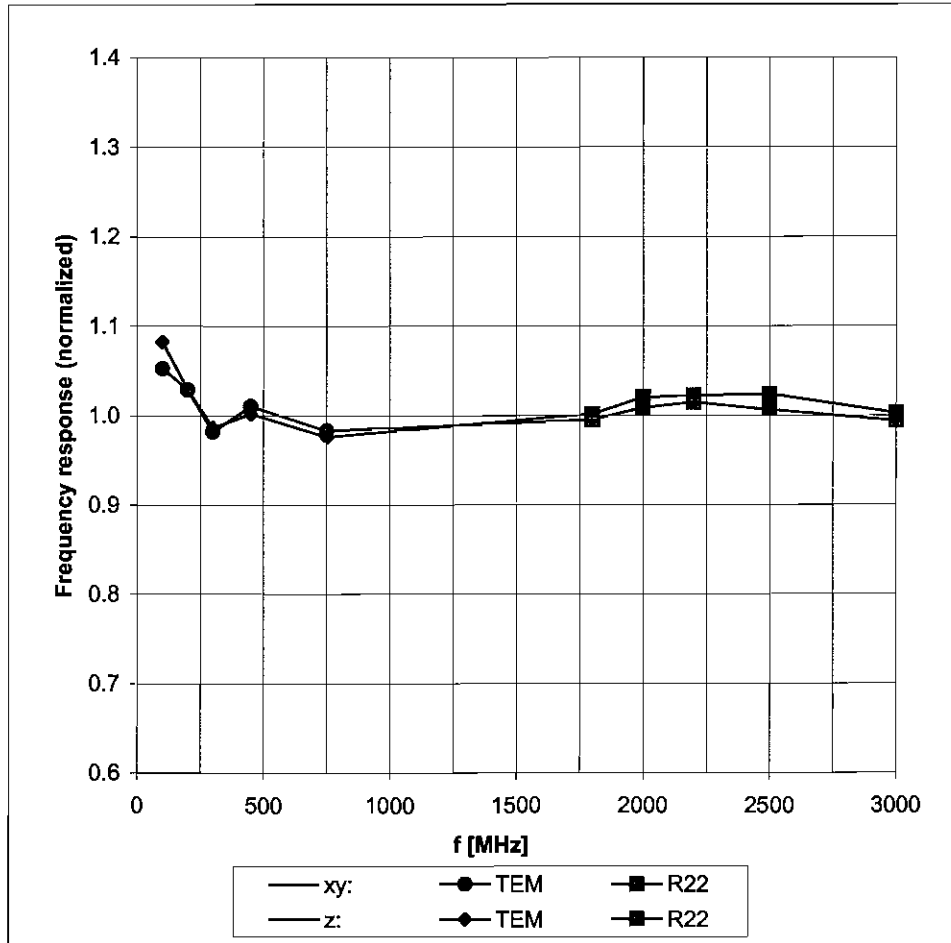

Uncertainty of Frequency Response of E-field:  $\pm 6.3\%$  (k=2)

### Receiving Pattern ( $\phi$ ), $\vartheta = 90^\circ$

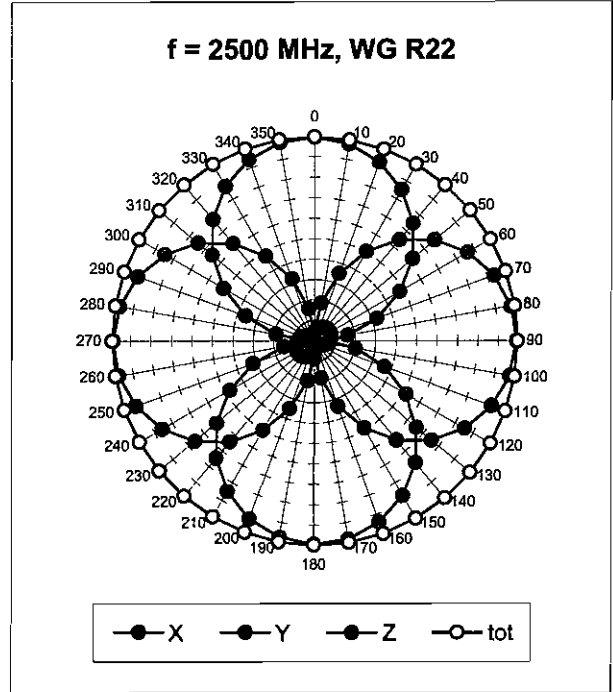
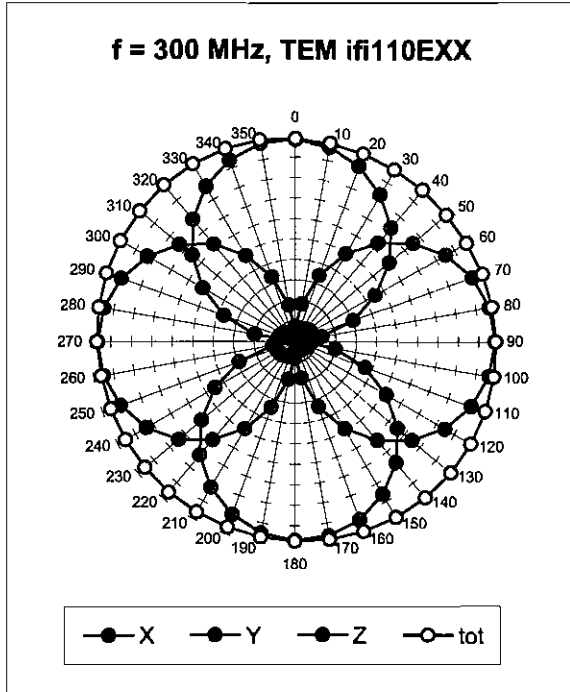

### Receiving Pattern ( $\phi$ ), $\vartheta = 0^\circ$

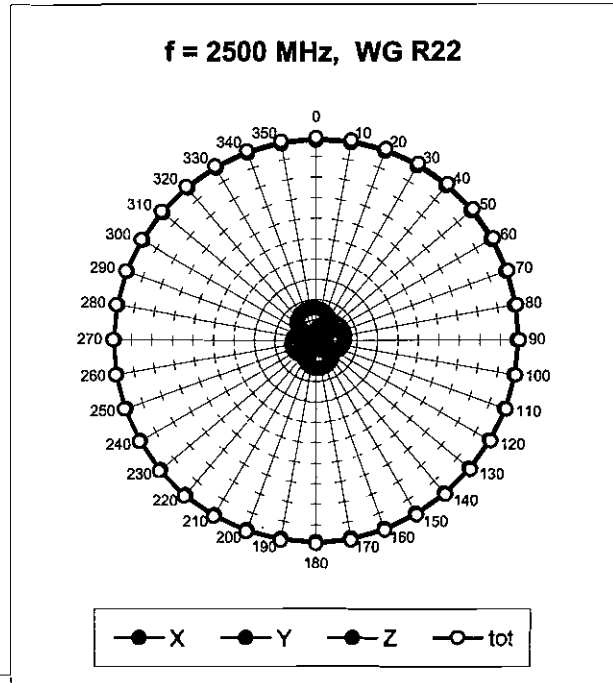
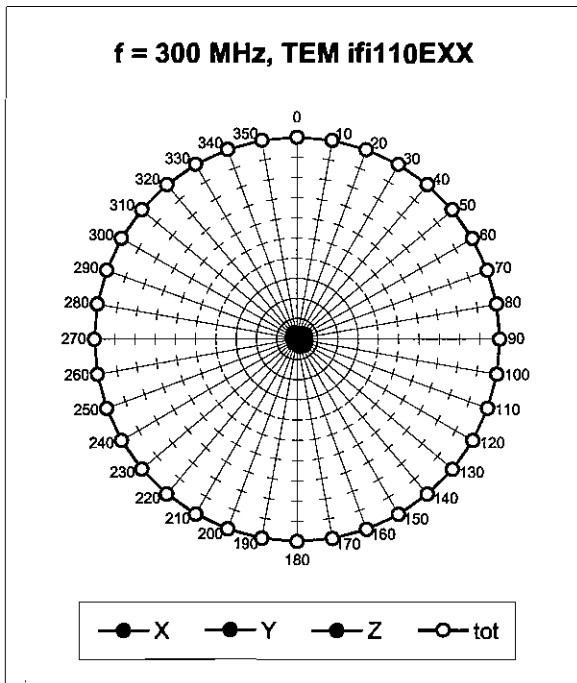

### Receiving Pattern ( $\phi$ ), $\vartheta = 90^\circ$

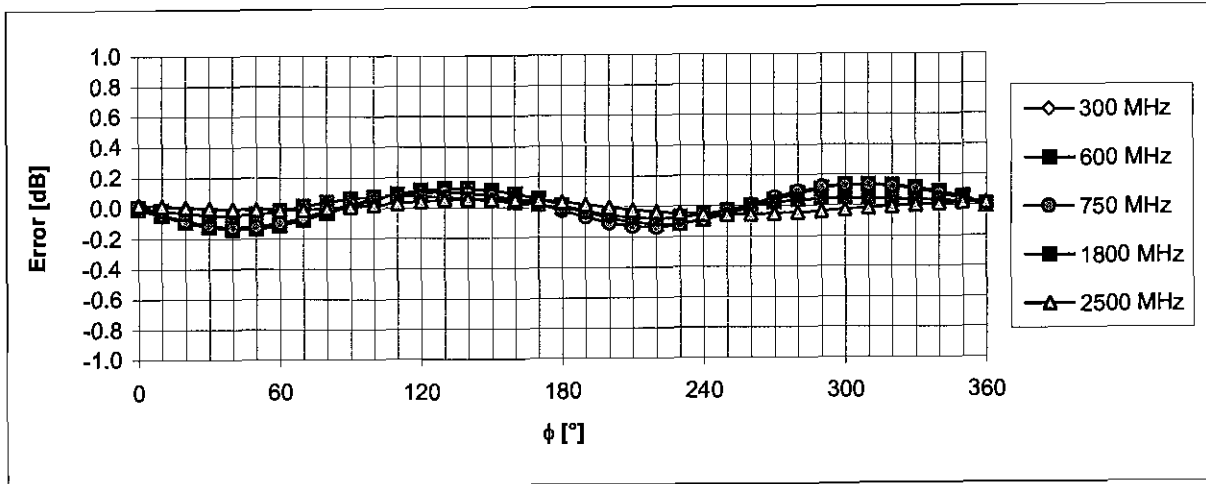

Uncertainty of Axial Isotropy Assessment:  $\pm 0.5\%$  ( $k=2$ )

### Receiving Pattern ( $\phi$ ), $\vartheta = 0^\circ$

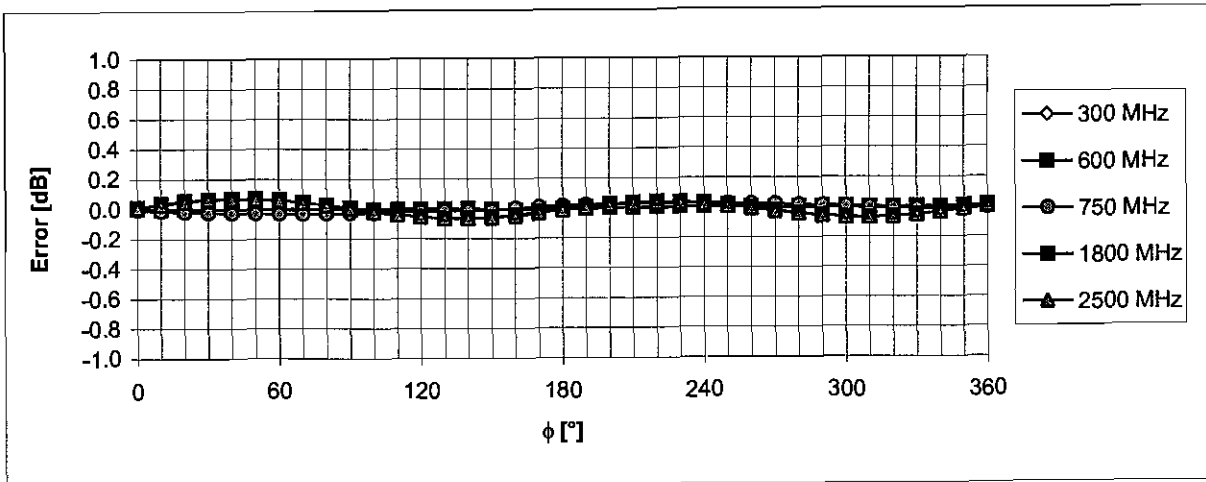

Uncertainty of Axial Isotropy Assessment:  $\pm 0.5\%$  ( $k=2$ )

### Dynamic Range f(H-field) (Waveguide R22, f = 1800 MHz)

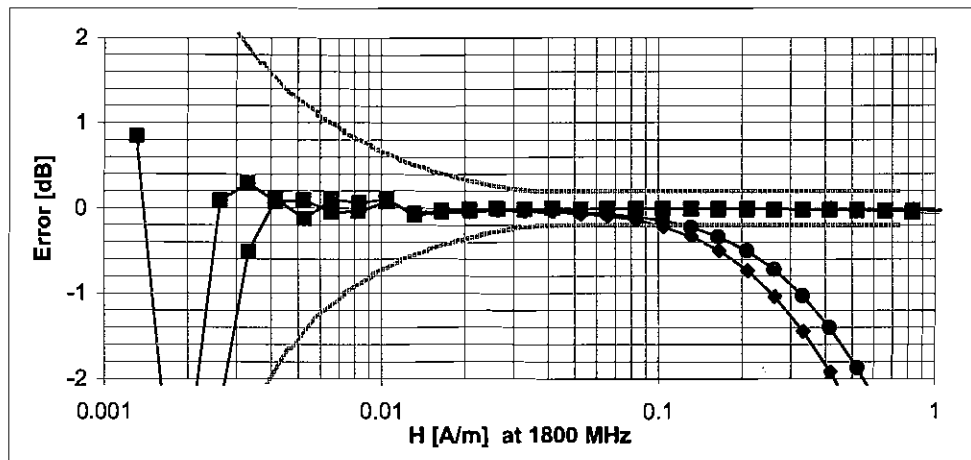
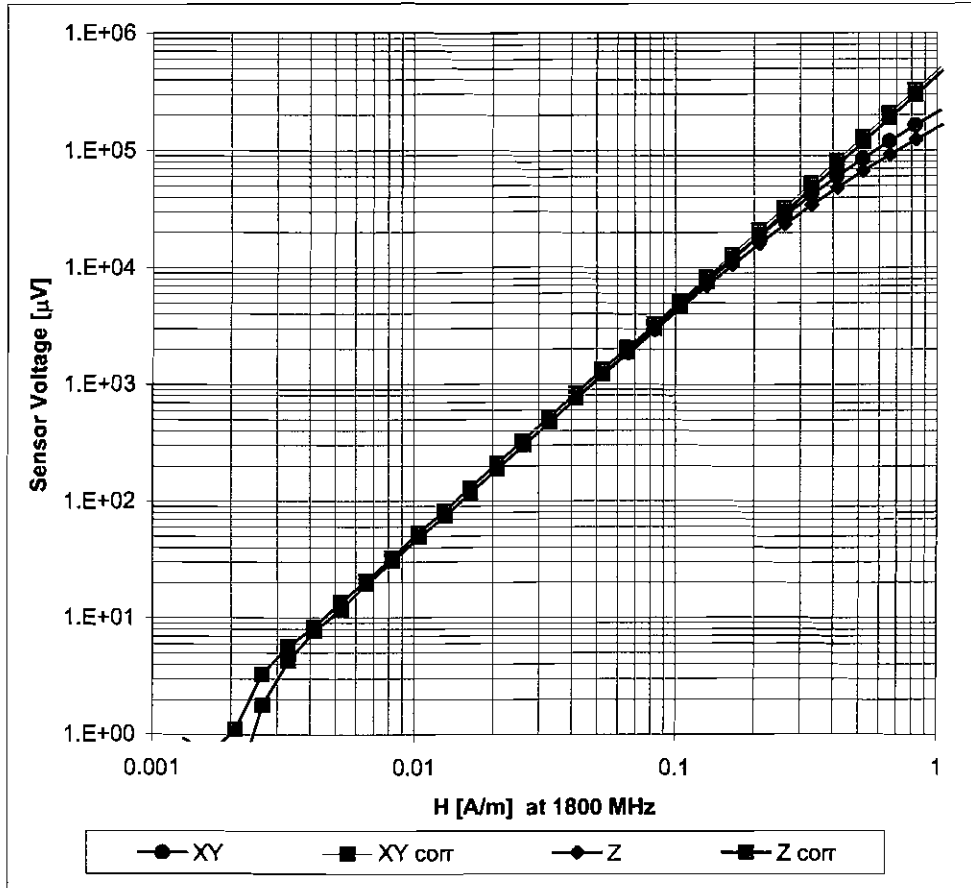

Uncertainty of Linearity Assessment:  $\pm 0.6\%$  (k=2)



**B3: DAE**



Accredited by the Swiss Federal Office of Metrology and Accreditation  
The Swiss Accreditation Service is one of the signatories to the EA  
Multilateral Agreement for the recognition of calibration certificates

Accreditation No.: **SCS 108**

Client **ADT (Auden)**

Certificate No: **DAE3-510\_Aug07**

## CALIBRATION CERTIFICATE

Object **DAE3 - SD.000 D03/AA - SN: 510**

Calibration procedure(s) **QA CAL-06 v12  
Calibration procedure for the data acquisition electronics (DAE)**

Calibration date: **August 29, 2007**

Condition of the calibrated item **In Tolerance**

This calibration certificate documents the traceability to national standards, which realize the physical units of measurements (SI).  
The measurements and the uncertainties with confidence probability are given on the following pages and are part of the certificate.

All calibrations have been conducted in the closed laboratory facility: environment temperature (22 ± 3)°C and humidity < 70%.

Calibration Equipment used (M&TE critical for calibration)

Primary Standards	ID #	Cal Date (Calibrated by, Certificate No.)	Scheduled Calibration
Fluke Process Calibrator Type 702	SN: 6295803	13-Oct-06 (Elcal AG, No: 5492)	Oct-07
Keithley Multimeter Type 2001	SN: 0810278	03-Oct-06 (Elcal AG, No: 5478)	Oct-07
Secondary Standards	ID #	Check Date (in house)	Scheduled Check
Calibrator Box V1.1	SE UMS 006 AB 1004	25-Jun-07 (SPEAG, in house check)	In house check Jun-08

Calibrated by: **Name** Dominique Steffen **Function** Technician **Signature**

Approved by: **Name** Fin Bornhoit **Function** R&D Director **Signature**

Issued: August 29, 2007

This calibration certificate shall not be reproduced except in full without written approval of the laboratory.



Accredited by the Swiss Federal Office of Metrology and Accreditation  
The Swiss Accreditation Service is one of the signatories to the EA  
Multilateral Agreement for the recognition of calibration certificates

Accreditation No.: **SCS 108**

## Glossary

**DAE** data acquisition electronics  
**Connector angle** information used in DASY system to align probe sensor X to the robot coordinate system.

## Methods Applied and Interpretation of Parameters

- *DC Voltage Measurement:* Calibration Factor assessed for use in DASY system by comparison with a calibrated instrument traceable to national standards. The figure given corresponds to the full scale range of the voltmeter in the respective range.
- *Connector angle:* The angle of the connector is assessed measuring the angle mechanically by a tool inserted. Uncertainty is not required.
- The following parameters contain technical information as a result from the performance test and require no uncertainty.
- *DC Voltage Measurement Linearity:* Verification of the Linearity at +10% and -10% of the nominal calibration voltage. Influence of offset voltage is included in this measurement.
- *Common mode sensitivity:* Influence of a positive or negative common mode voltage on the differential measurement.
- *Channel separation:* Influence of a voltage on the neighbor channels not subject to an input voltage.
- *AD Converter Values with inputs shorted:* Values on the internal AD converter corresponding to zero input voltage
- *Input Offset Measurement:* Output voltage and statistical results over a large number of zero voltage measurements.
- *Input Offset Current:* Typical value for information; Maximum channel input offset current, not considering the input resistance.
- *Input resistance:* DAE input resistance at the connector, during internal auto-zeroing and during measurement.
- *Low Battery Alarm Voltage:* Typical value for information. Below this voltage, a battery alarm signal is generated.
- *Power consumption:* Typical value for information. Supply currents in various operating modes.

## DC Voltage Measurement

A/D - Converter Resolution nominal

High Range: 1LSB = 6.1 $\mu$ V, full range = -100...+300 mV

Low Range: 1LSB = 61nV, full range = -1.....+3mV

DASY measurement parameters: Auto Zero Time: 3 sec; Measuring time: 3 sec

Calibration Factors	X	Y	Z
High Range	404.150 $\pm$ 0.1% (k=2)	404.218 $\pm$ 0.1% (k=2)	404.585 $\pm$ 0.1% (k=2)
Low Range	3.98817 $\pm$ 0.7% (k=2)	3.97339 $\pm$ 0.7% (k=2)	3.96897 $\pm$ 0.7% (k=2)

## Connector Angle

Connector Angle to be used in DASY system	42 $^{\circ}$ $\pm$ 1 $^{\circ}$
---	----------------------------------



## Appendix

### 1. DC Voltage Linearity

High Range	Input ( $\mu\text{V}$ )	Reading ( $\mu\text{V}$ )	Error (%)
Channel X + Input	200000	200000.7	0.00
Channel X + Input	20000	20006.63	0.03
Channel X - Input	20000	-19999.14	0.00
Channel Y + Input	200000	199999.5	0.00
Channel Y + Input	20000	20005.23	0.03
Channel Y - Input	20000	-20002.04	0.01
Channel Z + Input	200000	199999.6	0.00
Channel Z + Input	20000	20006.53	0.03
Channel Z - Input	20000	-20001.38	0.01

Low Range	Input ( $\mu\text{V}$ )	Reading ( $\mu\text{V}$ )	Error (%)
Channel X + Input	2000	2000	0.00
Channel X + Input	200	199.97	-0.01
Channel X - Input	200	-199.90	-0.05
Channel Y + Input	2000	2000.1	0.00
Channel Y + Input	200	199.64	-0.18
Channel Y - Input	200	-200.58	0.29
Channel Z + Input	2000	2000	0.00
Channel Z + Input	200	199.20	-0.40
Channel Z - Input	200	-200.81	0.41

### 2. Common mode sensitivity

DASY measurement parameters: Auto Zero Time: 3 sec; Measuring time: 3 sec

	Common mode Input Voltage (mV)	High Range Average Reading ( $\mu\text{V}$ )	Low Range Average Reading ( $\mu\text{V}$ )
Channel X	200	17.82	16.82
	- 200	-16.18	-16.83
Channel Y	200	14.68	14.20
	- 200	-15.70	-16.05
Channel Z	200	-8.25	-8.73
	- 200	8.01	8.08

### 3. Channel separation

DASY measurement parameters: Auto Zero Time: 3 sec; Measuring time: 3 sec

	Input Voltage (mV)	Channel X ( $\mu\text{V}$ )	Channel Y ( $\mu\text{V}$ )	Channel Z ( $\mu\text{V}$ )
Channel X	200	-	0.75	1.74
Channel Y	200	2.34	-	2.77
Channel Z	200	-1.43	0.25	-

#### 4. AD-Converter Values with inputs shorted

DASY measurement parameters: Auto Zero Time: 3 sec; Measuring time: 3 sec

	High Range (LSB)	Low Range (LSB)
Channel X	15893	16120
Channel Y	16114	16051
Channel Z	16081	16196

#### 5. Input Offset Measurement

DASY measurement parameters: Auto Zero Time: 3 sec; Measuring time: 3 sec

Input 10M $\Omega$

	Average ( $\mu$ V)	min. Offset ( $\mu$ V)	max. Offset ( $\mu$ V)	Std. Deviation ( $\mu$ V)
Channel X	-0.67	-1.71	-0.06	0.26
Channel Y	-1.04	-3.37	0.35	0.34
Channel Z	-1.26	-3.29	0.15	0.35

#### 6. Input Offset Current

Nominal Input circuitry offset current on all channels: <25fA

#### 7. Input Resistance

	Zeroing (MOhm)	Measuring (MOhm)
Channel X	0.2001	198.5
Channel Y	0.2001	199.2
Channel Z	0.2000	200.3

#### 8. Low Battery Alarm Voltage (verified during pre test)

Typical values	Alarm Level (VDC)
Supply (+ Vcc)	+7.9
Supply (- Vcc)	-7.6

#### 9. Power Consumption (verified during pre test)

Typical values	Switched off (mA)	Stand by (mA)	Transmitting (mA)
Supply (+ Vcc)	+0.0	+6	+14
Supply (- Vcc)	-0.01	-8	-9



## **B4: VALIDATION DIPOLE**



Accredited by the Swiss Accreditation Service (SAS)  
The Swiss Accreditation Service is one of the signatories to the EA  
Multilateral Agreement for the recognition of calibration certificates

Accreditation No.: **SCS 108**

Client **ADT (Auden)**

Certificate No: **CD835V3-1041\_May08**

## CALIBRATION CERTIFICATE

Object **CD835V3 - SN: 1041**

Calibration procedure(s) **QA CAL-20.v4  
Calibration procedure for dipoles in air**

Calibration date: **May 14, 2008**

Condition of the calibrated item **In Tolerance**

This calibration certificate documents the traceability to national standards, which realize the physical units of measurements (SI).  
All calibrations have been conducted in the closed laboratory facility: environment temperature ( $22 \pm 3$ )°C and humidity < 70%.

Calibration Equipment used (M&TE critical for calibration)

Primary Standards	ID #	Cal Date (Certificate No.)	Scheduled Calibration
Power meter EPM-442A	GB37480704	04-Oct-07 (No. 217-00736)	Oct-08
Power sensor HP 8481A	US37292783	04-Oct-07 (No. 217-00736)	Oct-08
Probe ER3DV6	SN: 2336	31-Dec-07 (No. ER3-2336_Dec07)	Dec-08
Probe H3DV6	SN: 6065	31-Dec-07 (No. H3-6065_-Dec07)	Dec-08
DAE4	SN: 781	2-Oct-07 (No. DAE4-781_Oct07)	Oct-08
Secondary Standards	ID #	Check Date (in house)	Scheduled Check
Power meter EPM-4419B	GB42420191	11-May-05 (in house check Oct -07)	In house check: Nov-08
Power sensor HP 8482A	US37295597	11-May-05 (in house check Oct -07)	In house check: Nov-08
Power sensor HP 8482H	3318A09450	08-Jan-02 (in house check Oct -07)	In house check: Nov-08
Network Analyzer HP 8753E	US37390585	18-Oct-01 (in house check Oct-07)	In house check: Nov-09
RF generator E4433B	MY 41310391	22-Nov-04 (in house check Oct-07)	In house check: Nov-09

Calibrated by: **Name: Mike Meili, Function: Laboratory Technician, Signature: *M. Meili***

Approved by: **Name: Fin Bornholt, Function: Technical Director, Signature: *F. Bornholt***

Issued: May 19, 2008

This calibration certificate shall not be reproduced except in full without written approval of the laboratory.



Accredited by the Swiss Accreditation Service (SAS)  
The Swiss Accreditation Service is one of the signatories to the EA  
Multilateral Agreement for the recognition of calibration certificates

Accreditation No.: **SCS 108**

## References

- [1] ANSI-C63.19-2006  
American National Standard for Methods of Measurement of Compatibility between Wireless Communications Devices and Hearing Aids.

## Methods Applied and Interpretation of Parameters:

- *Coordinate System:* y-axis is in the direction of the dipole arms. z-axis is from the basis of the antenna (mounted on the table) towards its feed point between the two dipole arms. x-axis is normal to the other axes. In coincidence with standard [1], the measurement planes (probe sensor center) are selected to be at a distance of 10 mm above the top edge of the dipole arms.
- *Measurement Conditions:* Further details are available from the hardcopies at the end of the certificate. All figures stated in the certificate are valid at the frequency indicated. The forward power to the dipole connector is set with a calibrated power meter connected and monitored with an auxiliary power meter connected to a directional coupler. While the dipole under test is connected, the forward power is adjusted to the same level.
- *Antenna Positioning:* The dipole is mounted on a HAC Test Arch phantom using the matching dipole positioner with the arms horizontal and the feeding cable coming from the floor. The measurements are performed in a shielded room with absorbers around the setup to reduce the reflections. It is verified before the mounting of the dipole under the Test Arch phantom, that its arms are perfectly in a line. It is installed on the HAC dipole positioner with its arms parallel below the dielectric reference wire and able to move elastically in vertical direction without changing its relative position to the top center of the Test Arch phantom. The vertical distance to the probe is adjusted after dipole mounting with a DASY4 Surface Check job. Before the measurement, the distance between phantom surface and probe tip is verified. The proper measurement distance is selected by choosing the matching section of the HAC Test Arch phantom with the proper device reference point (upper surface of the dipole) and the matching grid reference point (tip of the probe) considering the probe sensor offset. The vertical distance to the probe is essential for the accuracy.
- *Feed Point Impedance and Return Loss:* These parameters are measured using a HP 8753E Vector Network Analyzer. The impedance is specified at the SMA connector of the dipole. The influence of reflections was eliminating by applying the averaging function while moving the dipole in the air, at least 70cm away from any obstacles.
- *E-field distribution:* E field is measured in the x-y-plane with an isotropic ER3D-field probe with 100 mW forward power to the antenna feed point. In accordance with [1], the scan area is 20mm wide, its length exceeds the dipole arm length (180 or 90mm). The sensor center is 10 mm (in z) above the top of the dipole arms. Two 3D maxima are available near the end of the dipole arms. Assuming the dipole arms are perfectly in one line, the average of these two maxima (in subgrid 2 and subgrid 8) is determined to compensate for any non-parallelity to the measurement plane as well as the sensor displacement. The E-field value stated as calibration value represents the maximum of the interpolated 3D-E-field, 10mm above the dipole surface.
- *H-field distribution:* H-field is measured with an isotropic H-field probe with 100mW forward power to the antenna feed point, in the x-y-plane. The scan area and sensor distance is equivalent to the E-field scan. The maximum of the field is available at the center (subgrid 5) above the feed point. The H-field value stated as calibration value represents the maximum of the interpolated H-field, 10mm above the dipole surface at the feed point.

## 1 Measurement Conditions

DASY system configuration, as far as not given on page 1.

<b>DASY Version</b>	DASY4	V4.7 B71
<b>DASY PP Version</b>	SEMCAD	V1.8 B184
<b>Phantom</b>	HAC Test Arch	SD HAC P01 BA, #1070
<b>Distance Dipole Top - Probe Center</b>	10 mm	
<b>Scan resolution</b>	dx, dy = 5 mm	area = 20 x 180 mm
<b>Frequency</b>	<b>835 MHz ± 1 MHz</b>	
<b>Forward power at dipole connector</b>	20.0 dBm = 100mW	
<b>Input power drift</b>	< 0.05 dB	

## 2 Maximum Field values

<b>H-field 10 mm above dipole surface</b>	condition	<b>interpolated maximum</b>
Maximum measured	100 mW forward power	<b>0.456 A/m</b>

Uncertainty for H-field measurement: 8.2% (k=2)

<b>E-field 10 mm above dipole surface</b>	condition	<b>Interpolated maximum</b>
Maximum measured above high end-	100 mW forward power	164.3 V/m
Maximum measured above low end	100 mW forward power	160.9 V/m
Averaged maximum above arm	100 mW forward power	<b>162.6 V/m</b>

Uncertainty for E-field measurement: 12.8% (k=2)

## 3 Appendix

### 3.1 Antenna Parameters

<b>Frequency</b>	<b>Return Loss</b>	<b>Impedance</b>
800 MHz	15.6 dB	( 41.0 – j12.3 ) Ohm
<b>835 MHz</b>	<b>27.7 dB</b>	<b>( 50.0 + j4.1 ) Ohm</b>
900 MHz	17.6 dB	( 54.7 – j13.2 ) Ohm
950 MHz	18.2 dB	( 48.6 + j12.2 ) Ohm
960 MHz	13.8 dB	( 58.0 + j21.1 ) Ohm

### 3.2 Antenna Design and Handling

The calibration dipole has a symmetric geometry with a built-in two stub matching network, which leads to the enhanced bandwidth.

The dipole is built of standard semirigid coaxial cable. The internal matching line is open ended. The antenna is therefore open for DC signals.

Do not apply force to dipole arms, as they are liable to bend. The soldered connections near the feedpoint may be damaged. After excessive mechanical stress or overheating, check the impedance characteristics to ensure that the internal matching network is not affected.

After long term use with 40W radiated power, only a slight warming of the dipole near the feedpoint can be measured.

### 3.3 Measurement Sheets

#### 3.3.1 Return Loss and Smith Chart

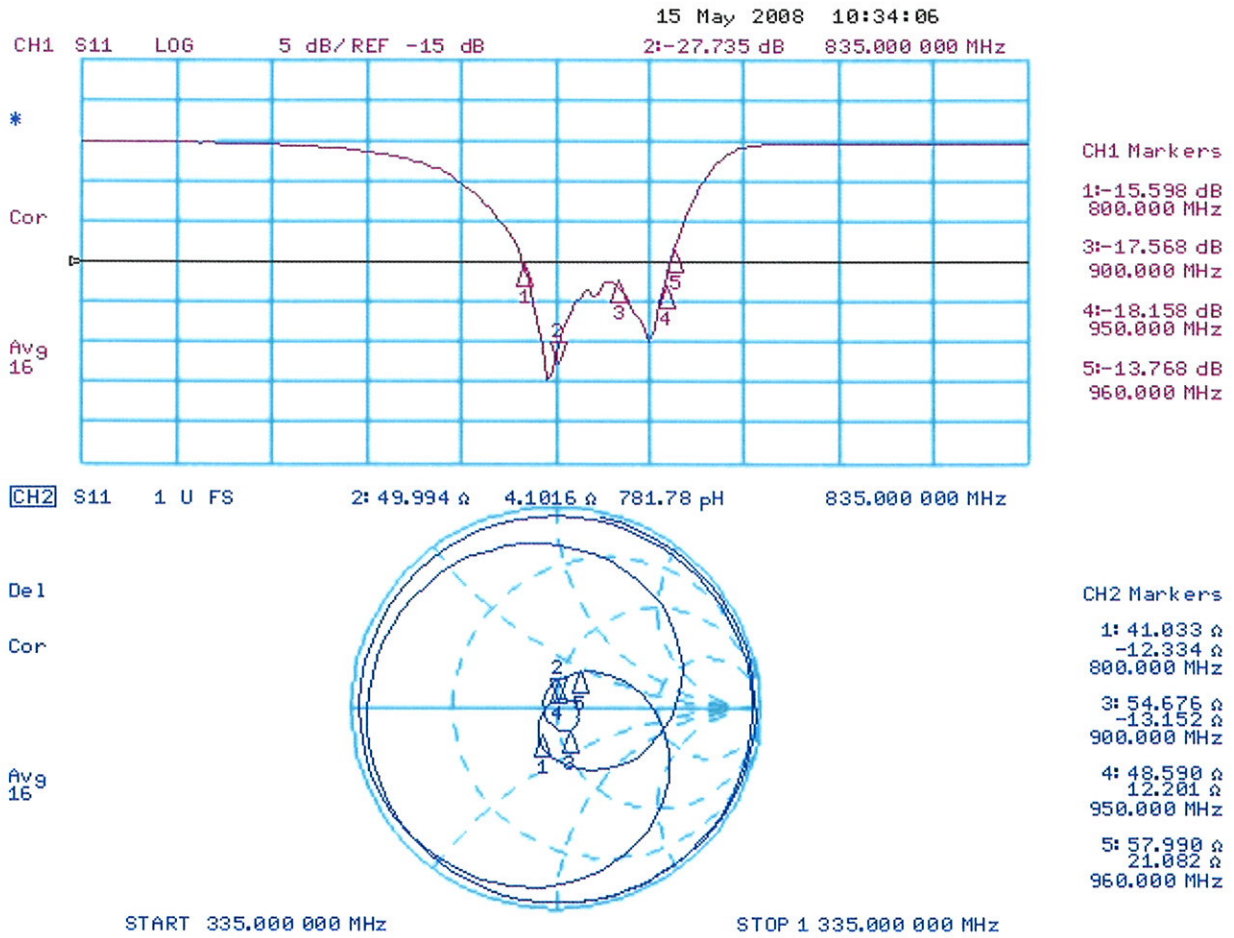

### 3.3.2 DASY4 H-field result

Date/Time: 13.05.2008 12:52:58

Test Laboratory: SPEAG Lab 2

**DUT: HAC-Dipole 835 MHz; Type: D835V3; Serial: 1041**

Communication System: CW; Frequency: 835 MHz; Duty Cycle: 1:1

Medium parameters used:  $\sigma = 0$  mho/m,  $\epsilon_r = 1$ ;  $\rho = 1000$  kg/m<sup>3</sup>

Phantom section: RF Section

Measurement Standard: DASY4 (High Precision Assessment)

DASY4 Configuration:

- Probe: H3DV6 - SN6065; Calibrated: 31.12.2007
- Sensor-Surface: (Fix Surface)
- Electronics: DAE4 Sn781; Calibrated: 02.10.2007
- Phantom: HAC Test Arch with AMCC; Type: SD HAC P01 BA; Serial: 1070
- Measurement SW: DASY4, V4.7 Build 71; Postprocessing SW: SEMCAD, V1.8 Build 184

**H Scan - measurement distance from the probe sensor center to CD835 Dipole = 10mm/Hearing Aid Compatibility Test (41x361x1):**

Measurement grid: dx=5mm, dy=5mm

Maximum value of peak Total field = 0.456 A/m

Probe Modulation Factor = 1.00

Device Reference Point: 0.000, 0.000, -6.30 mm

Reference Value = 0.485 A/m; Power Drift = -0.025 dB

**Hearing Aid Near-Field Category: M4 (AWF 0 dB)**

Peak H-field in A/m

Grid 1 <b>0.381</b> M4	Grid 2 <b>0.399</b> M4	Grid 3 <b>0.374</b> M4
Grid 4 <b>0.434</b> M4	Grid 5 <b>0.456</b> M4	Grid 6 <b>0.427</b> M4
Grid 7 <b>0.385</b> M4	Grid 8 <b>0.404</b> M4	Grid 9 <b>0.378</b> M4

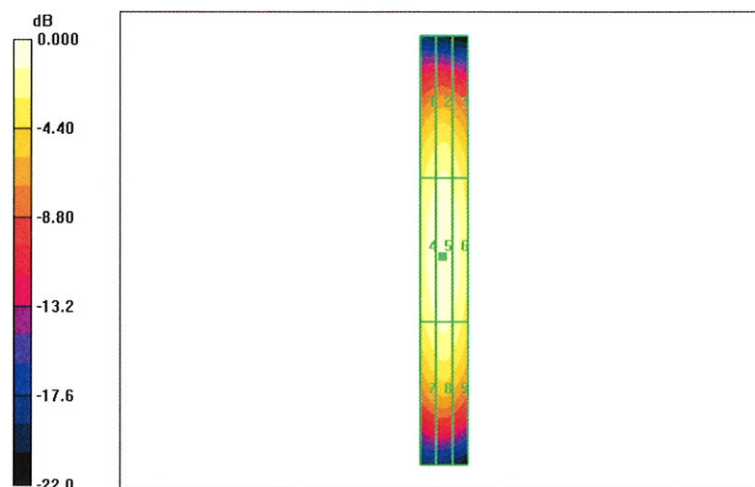

0 dB = 0.456A/m



### 3.3.3 DASY4 E-field result

Date/Time: 14.05.2008 11:32:24

Test Laboratory: SPEAG Lab 2

**DUT: HAC-Dipole 835 MHz; Type: D835V3; Serial: 1041**

Communication System: CW; Frequency: 835 MHz; Duty Cycle: 1:1

Medium parameters used:  $\sigma = 0$  mho/m,  $\epsilon_r = 1$ ;  $\rho = 1000$  kg/m<sup>3</sup>

Phantom section: E Dipole Section

Measurement Standard: DASY4 (High Precision Assessment)

DASY4 Configuration:

- Probe: ER3DV6 - SN2336; ConvF(1, 1, 1); Calibrated: 31.12.2007
- Sensor-Surface: (Fix Surface)
- Electronics: DAE4 Sn781; Calibrated: 02.10.2007
- Phantom: HAC Test Arch with Coil; Type: SD HAC P01 BA; Serial: 1070
- Measurement SW: DASY4, V4.7 Build 71; Postprocessing SW: SEMCAD, V1.8 Build 184

**E Scan - Sensor Center 10mm above CD835 Dipole/Hearing Aid Compatibility Test (41x361x1):**

Measurement grid: dx=5mm, dy=5mm

Maximum value of peak Total field = 164.3 V/m

Probe Modulation Factor = 1.00

Device Reference Point: 0.000, 0.000, 354.7 mm

Reference Value = 105.9 V/m; Power Drift = -0.005 dB

**Hearing Aid Near-Field Category: M4 (AWF 0 dB)**

Peak E-field in V/m

Grid 1 <b>155.7</b> M4	Grid 2 <b>160.9</b> M4	Grid 3 <b>157.3</b> M4
Grid 4 <b>85.3</b> M4	Grid 5 <b>88.0</b> M4	Grid 6 <b>85.7</b> M4
Grid 7 <b>157.9</b> M4	Grid 8 <b>164.3</b> M4	Grid 9 <b>159.0</b> M4

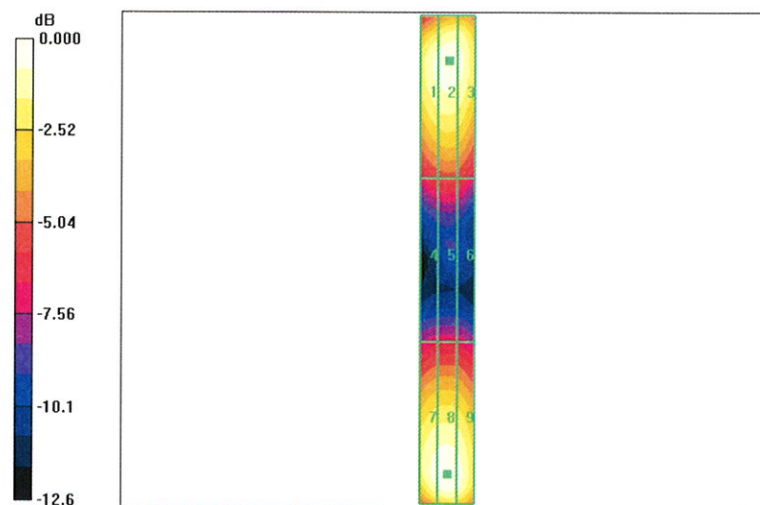

0 dB = 164.3V/m



Accredited by the Swiss Federal Office of Metrology and Accreditation  
The Swiss Accreditation Service is one of the signatories to the EA  
Multilateral Agreement for the recognition of calibration certificates

Accreditation No.: **SCS 108**

Client **ADT (Auden)**

Certificate No: **CD1880V3-1032\_Jul06**

## CALIBRATION CERTIFICATE

Object **CD1880V3 - SN: 1032**

Calibration procedure(s) **QA CAL-20.v4  
Calibration procedure for dipoles in air**

Calibration date: **July 18, 2006**

Condition of the calibrated item **In Tolerance**

This calibration certificate documents the traceability to national standards, which realize the physical units of measurements (SI).  
All calibrations have been conducted in the closed laboratory facility: environment temperature (22 ± 3)°C and humidity < 70%.

Calibration Equipment used (M&TE critical for calibration)

Primary Standards	ID #	Cal Date (Calibrated by, Certificate No.)	Scheduled Calibration
Power meter EPM-442A	GB37480704	04-Oct-05 (METAS, No. 251-00516)	Oct-06
Power sensor HP 8481A	US37292783	04-Oct-05 (METAS, No. 251-00516)	Oct-06
Reference 20 dB Attenuator	SN: 5086 (20g)	11-Aug-05 (METAS, No 251-00498)	Aug-06
Reference 10 dB Attenuator	SN: 5047.2 (10r)	11-Aug-05 (METAS, No 251-00498)	Aug-06
DAE4	SN: 660	1-Mar-06 (SPEAG, No. DAE4-660_Mar06)	Calibration, Mar-07
Probe ER3DV6	SN: 2336	20-Dec-05 (SPEAG, No. ER3-2336_Dec05)	Calibration, Dec-06
Probe H3DV6	SN: 6065	20-Dec-05 (SPEAG, No. H3-6065-Dec05)	Calibration, Dec-06

Secondary Standards	ID #	Check Date (in house)	Scheduled Check
Power meter EPM-4419B	GB43310788	12-Aug-03 (SPEAG, in house check Oct-05)	In house check: Oct-06
Power sensor HP 8481A	MY41093312	10-Aug-03 (SPEAG, in house check Oct-05)	In house check: Oct-07
Power sensor HP 8481A	MY41093315	10-Aug-03 (SPEAG, in house check Oct-05)	In house check: Oct-06
Network Analyzer HP 8753E	US37390585	18-Oct-01 (SPEAG, in house check Nov-05)	In house check: Nov-06
RF generator R&S SMT06	SN: 100005	26-Jul-04 (SPEAG, in house check Nov-05)	In house check: Nov-07

Calibrated by: **Mike Melli** Name: **Mike Melli** Function: **Laboratory Technician** Signature: *[Signature]*

Approved by: **Fin Bomholt** Name: **Fin Bomholt** Technical Director: *[Signature]*

Issued: July 20, 2006

This calibration certificate shall not be reproduced except in full without written approval of the laboratory.



Accredited by the Swiss Federal Office of Metrology and Accreditation  
The Swiss Accreditation Service is one of the signatories to the EA  
Multilateral Agreement for the recognition of calibration certificates

Accreditation No.: **SCS 108**

## References

- [1] ANSI-PC63.19-2001 (Draft 3.x, 2005)  
American National Standard for Methods of Measurement of Compatibility between Wireless Communications Devices and Hearing Aids.

## Methods Applied and Interpretation of Parameters:

- **Coordinate System:** y-axis is in the direction of the dipole arms. z-axis is from the basis of the antenna (mounted on the table) towards its feed point between the two dipole arms. x-axis is normal to the other axes. In coincidence with standard [1], the measurement planes (probe sensor center) are selected to be at a distance of 10 mm above the top edge of the dipole arms.
- **Measurement Conditions:** Further details are available from the hardcopies at the end of the certificate. All figures stated in the certificate are valid at the frequency indicated. The forward power to the dipole connector is set with a calibrated power meter connected and monitored with an auxiliary power meter connected to a directional coupler. While the dipole under test is connected, the forward power is adjusted to the same level.
- **Antenna Positioning:** The dipole is mounted on a HAC Test Arch phantom using the matching dipole positioner with the arms horizontal and the feeding cable coming from the floor. The measurements are performed in a shielded room with absorbers around the setup to reduce the reflections. It is verified before the mounting of the dipole under the Test Arch phantom, that its arms are perfectly in a line. It is installed on the HAC dipole positioner with its arms parallel below the dielectric reference wire and able to move elastically in vertical direction without changing its relative position to the top center of the Test Arch phantom. The vertical distance to the probe is adjusted after dipole mounting with a DASY4 Surface Check job. Before the measurement, the distance between phantom surface and probe tip is verified. The proper measurement distance is selected by choosing the matching section of the HAC Test Arch phantom with the proper device reference point (upper surface of the dipole) and the matching grid reference point (tip of the probe) considering the probe sensor offset. The vertical distance to the probe is essential for the accuracy.
- **Feed Point Impedance and Return Loss:** These parameters are measured using a HP 8753E Vector Network Analyzer. The impedance is specified at the SMA connector of the dipole. The influence of reflections was eliminated by applying the averaging function while moving the dipole in the air, at least 70cm away from any obstacles.
- **E-field distribution:** E field is measured in the x-y-plane with an isotropic ER3D-field probe with 100 mW forward power to the antenna feed point. In accordance with [1], the scan area is 20mm wide, its length exceeds the dipole arm length (180 or 90mm). The sensor center is 10 mm (in z) above the top of the dipole arms. Two 3D maxima are available near the end of the dipole arms. Assuming the dipole arms are perfectly in one line, the average of these two maxima (in subgrid 2 and subgrid 8) is determined to compensate for any non-parallelity to the measurement plane as well as the sensor displacement. The E-field value stated as calibration value represents the maximum of the interpolated 3D-E-field, 10mm above the dipole surface.
- **H-field distribution:** H-field is measured with an isotropic H-field probe with 100mW forward power to the antenna feed point, in the x-y-plane. The scan area and sensor distance is equivalent to the E-field scan. The maximum of the field is available at the center (subgrid 5) above the feed point. The H-field value stated as calibration value represents the maximum of the interpolated H-field, 10mm above the dipole surface at the feed point.

## 1 Measurement Conditions

DASY system configuration, as far as not given on page 1.

<b>DASY Version</b>	DASY4	V4.7B44
<b>DASY PP Version</b>	SEMCAD	V1.8 B171
<b>Phantom</b>	HAC Test Arch	SD HAC P01 BA, #1002
<b>Distance Dipole Top - Probe Center</b>	10 mm	
<b>Scan resolution</b>	dx, dy = 5 mm	area = 20 x 90 mm
<b>Frequency</b>	<b>1880 MHz ± 1 MHz</b>	
<b>Forward power at dipole connector</b>	20.0 dBm = 100mW	
<b>Input power drift</b>	< 0.05 dB	

## 2 Maximum Field values

<b>H-field 10 mm above dipole surface</b>	condition	<b>Interpolated maximum</b>
Maximum measured	100 mW forward power	<b>0.454 A/m</b>

Uncertainty for H-field measurement: 8.2% (k=2)

<b>E-field 10 mm above dipole surface</b>	condition	<b>Interpolated maximum</b>
Maximum measured above high end	100 mW forward power	137.4 V/m
Maximum measured above low end	100 mW forward power	132.5 V/m
Averaged maximum above arm	100 mW forward power	<b>135.0 V/m</b>

Uncertainty for E-field measurement: 12.8% (k=2)

## 3 Appendix

### 3.1 Antenna Parameters

<b>Frequency</b>	<b>Return Loss</b>	<b>Impedance</b>
1710 MHz	21.6 dB	( 50.3 + j8.4 ) Ohm
<b>1880 MHz</b>	<b>21.2 dB</b>	<b>( 51.9 + j8.7 ) Ohm</b>
1900 MHz	21.8 dB	( 54.0 + j7.5 ) Ohm
1950 MHz	26.8 dB	( 54.8 + j0.3 ) Ohm
2000 MHz	22.4 dB	( 43.3 + j2.3 ) Ohm

### 3.2 Antenna Design and Handling

The calibration dipole has a symmetric geometry with a built-in two stub matching network, which leads to the enhanced bandwidth.

The dipole is built of standard semirigid coaxial cable. The internal matching line is open ended. The antenna is therefore open for DC signals.

Do not apply force to dipole arms, as they are liable to bend. The soldered connections near the feedpoint may be damaged. After excessive mechanical stress or overheating, check the impedance characteristics to ensure that the internal matching network is not affected.

After long term use with 40W radiated power, only a slight warming of the dipole near the feedpoint can be measured.

### 3.3 Measurement Sheets

#### 3.3.1 Return Loss and Smith Chart

17 Jul 2006 09:07:35

CH1 S11 LOG 5 dB/REF -18 dB 2:-21.161 dB 1 880.000 000 MHz

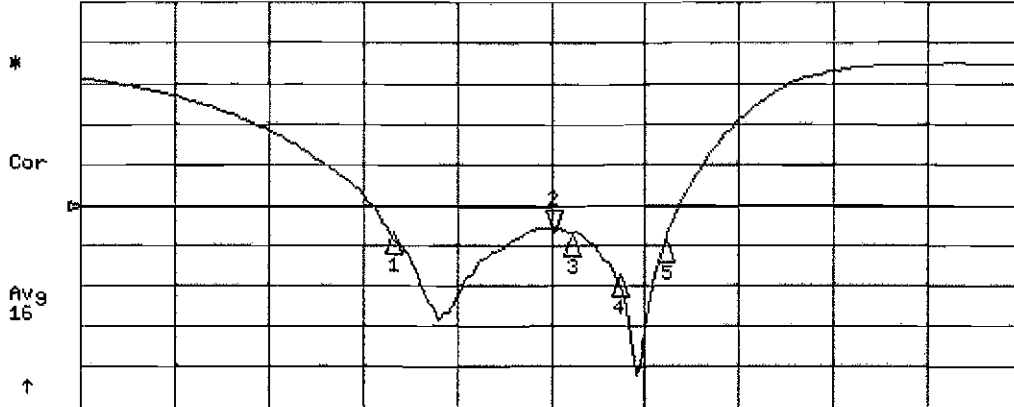

CH1 Markers

1:	-21.556 dB	1.71000 GHz
3:	-21.770 dB	1.90000 GHz
4:	-26.784 dB	1.95000 GHz
5:	-22.369 dB	2.00000 GHz

CH2 S11 1 U FS 2: 51.904  $\Omega$  8.7402  $\Omega$  739.92  $\mu$ H 1 880.000 000 MHz

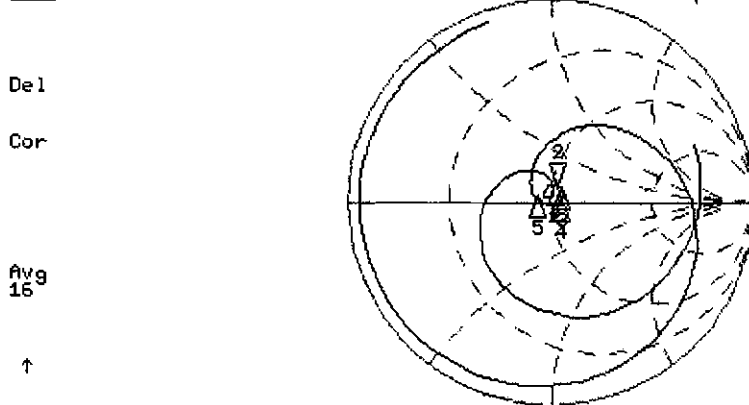

CH2 Markers

1:	50.342 $\Omega$	8.4043 $\Omega$	1.71000 GHz
3:	54.004 $\Omega$	7.5020 $\Omega$	1.90000 GHz
4:	54.791 $\Omega$	0.2500 $\Omega$	1.95000 GHz
5:	43.264 $\Omega$	2.2539 $\Omega$	2.00000 GHz

START 1 380.000 000 MHz

STOP 2 380.000 000 MHz

### 3.3.2 DASY4 H-field result

Date/Time: 7/18/2006 10:03:46 AM

Test Laboratory: SPEAG, Zurich, Switzerland

**DUT: HAC Dipole 1880 MHz; Type: CD1880V3; Serial: 1032**

Communication System: CW; Frequency: 1880 MHz; Duty Cycle: 1:1

Medium: Air

Medium parameters used:  $\sigma = 0$  mho/m,  $\epsilon_r = 1$ ;  $\rho = 1$  kg/m<sup>3</sup>

Phantom section: H Dipole Section

DASY4 Configuration:

- Probe: H3DV6 - SN6065; Calibrated: 12/20/2005
- Sensor-Surface: (Fix Surface)
- Electronics: DAE4 Sn660; Calibrated: 3/1/2006
- Phantom: HAC Test Arch 4.6; Type: SD HAC P01 BA; Serial: 1002
- Measurement SW: DASY4, V4.7 Build 44; Postprocessing SW: SEMCAD, V1.8 Build 171

**H Scan - Sensor Center 10mm above CD1880V3 Dipole/Hearing Aid Compatibility Test (41x181x1):**

Measurement grid: dx=5mm, dy=5mm

Maximum value of peak Total field = 0.454 A/m

Probe Modulation Factor = 1.00

Reference Value = 0.479 A/m; Power Drift = -0.002 dB

**Hearing Aid Near-Field Category: M2 (AWF 0 dB)**

Peak H-field in A/m

Grid 1	Grid 2	Grid 3
0.397	0.422	0.404
Grid 4	Grid 5	Grid 6
0.429	0.454	0.438
Grid 7	Grid 8	Grid 9
0.389	0.412	0.397

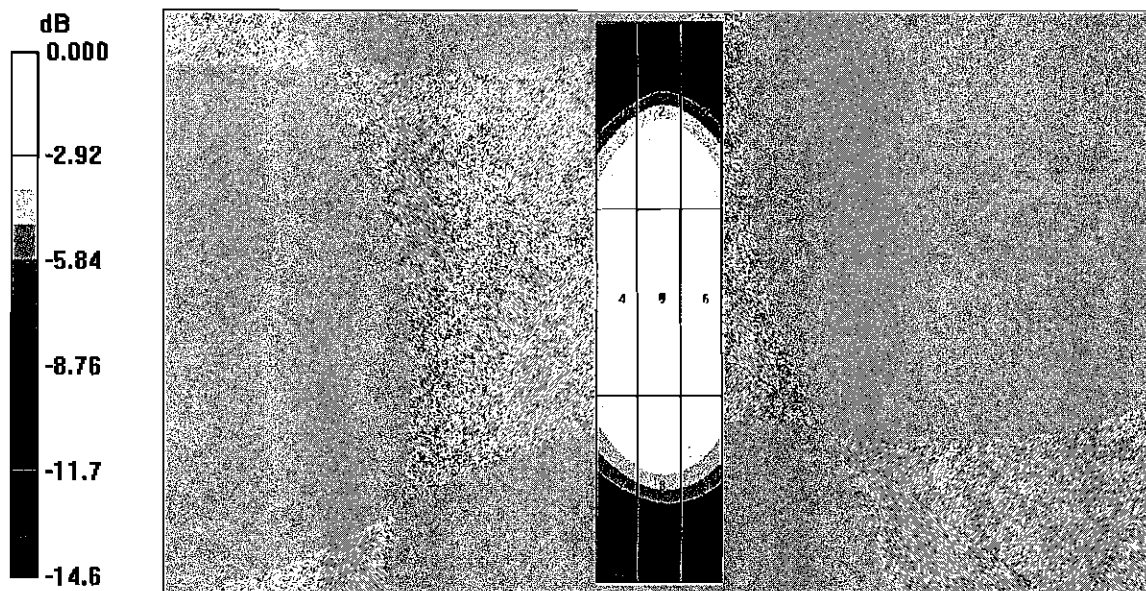

0 dB = 0.454A/m

**3.3.3 DASY4 E-Field result**

Date/Time: 7/18/2006 11:39:04 AM

Test Laboratory: SPEAG, Zurich, Switzerland

**DUT: HAC Dipole 1880 MHz; Type: CD1880V3; Serial: 1032**

Communication System: CW; Frequency: 1880 MHz; Duty Cycle: 1:1

Medium: Air

Medium parameters used:  $\sigma = 0$  mho/m,  $\epsilon_r = 1$ ;  $\rho = 1000$  kg/m<sup>3</sup>

Phantom section: E Dipole Section

DASY4 Configuration:

- Probe: ER3DV6 - SN2336; ConvF(1, 1, 1); Calibrated: 12/20/2005
- Sensor-Surface: (Fix Surface)
- Electronics: DAE4 Sn660; Calibrated: 3/1/2006
- Phantom: HAC Test Arch 4.6; Type: SD HAC P01 BA; Serial: 1002
- Measurement SW: DASY4, V4.7 Build 44; Postprocessing SW: SEMCAD, V1.8 Build 171

**E Scan - Sensor Center 10mm above CD1880V3 Dipole/Hearing Aid Compatibility Test (41x181x1):**

Measurement grid: dx=5mm, dy=5mm

Maximum value of peak Total field = 137.4 V/m

Probe Modulation Factor = 1.00

Reference Value = 132.3 V/m; Power Drift = -0.002 dB

Hearing Aid Near-Field Category: **M2 (AWF 0 dB)**

Peak E-field in V/m

Grid 1	Grid 2	Grid 3
132.8	137.4	131.7
Grid 4	Grid 5	Grid 6
87.6	90.7	88.7
Grid 7	Grid 8	Grid 9
130.6	132.5	127.8

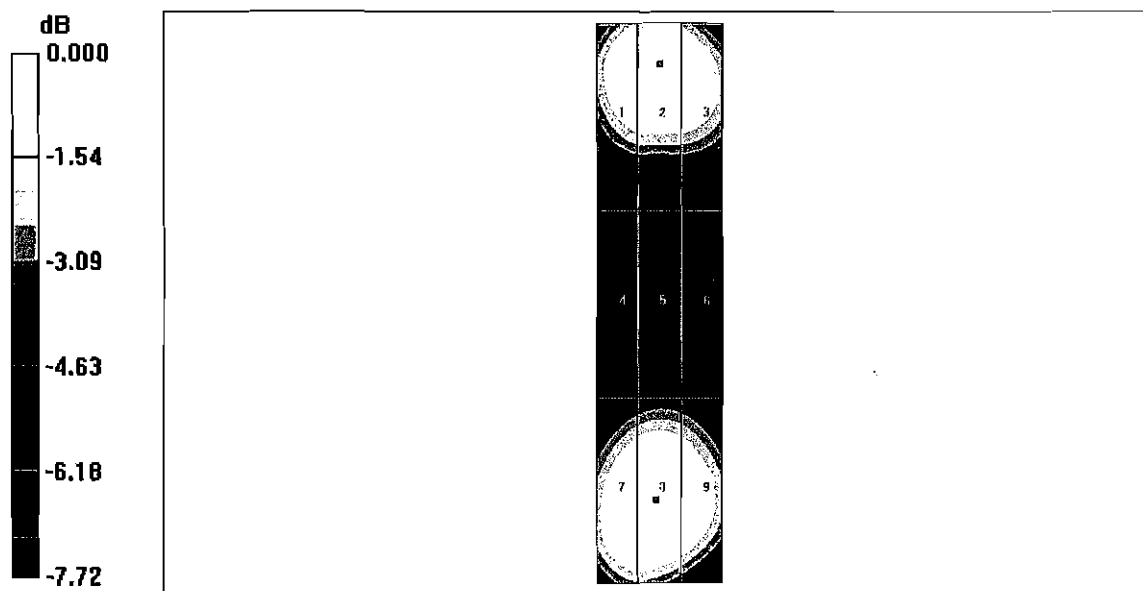

0 dB = 137.4V/m