

SAR TEST REPORT

(Mobile Phone)

REPORT NO.: SA970604L10

MODEL NO.: RAPH800

RECEIVED: Jun. 04, 2008

TESTED: Jun. 09 ~ Jun. 10, 2008

ISSUED: Jun. 17, 2008

APPLICANT: High Tech Computer Corp.

ADDRESS: No. 23, Xinghua Rd., Taoyuan City, 330, Taiwan,
R.O.C.

ISSUED BY: Advance Data Technology Corporation

LAB ADDRESS: No. 47, 14th Ling, Chia Pau Tsuen, Lin Kou Hsiang
244, Taipei Hsien, Taiwan, R.O.C.

TEST LOCATION: No. 19, Hwa Ya 2nd Rd., Wen Hwa Tsuen, Kwei
Shan Hsiang, Taoyuan Hsien 333, Taiwan, R.O.C.

This test report consists of 49 pages in total except Appendix. It may be duplicated completely for legal use with the approval of the applicant. It should not be reproduced except in full, without the written approval of our laboratory. The client should not use it to claim product endorsement by TAF, A2LA or any government agencies. The test results in the report only apply to the tested sample.





TABLE OF CONTENTS

1.	CERTIFICATION.....	3
2.	GENERAL INFORMATION.....	4
2.1	GENERAL DESCRIPTION OF EUT.....	4
2.2	GENERAL DESCRIPTION OF APPLIED STANDARDS.....	6
2.3	GENERAL INFORMATION OF THE SAR SYSTEM.....	9
2.4	GENERAL DESCRIPTION OF THE SPATIAL PEAK SAR EVALUATION.....	12
3.	DESCRIPTION OF SUPPORT UNITS.....	16
4.	DESCRIPTION OF TEST POSITION.....	17
4.1	DESCRIPTION OF TEST POSITION.....	17
4.2.1	TOUCH/CHEEK TEST POSITION.....	18
4.2.2	TILT TEST POSITION.....	19
4.2.3	BODY-WORN CONFIGURATION.....	19
4.2	DESCRIPTION OF TEST MODE.....	20
4.3	SUMMARY OF TEST RESULTS.....	21
5.	TEST RESULTS.....	23
5.1	TEST PROCEDURES.....	23
5.2	MEASURED SAR RESULTS.....	25
5.3	SAR LIMITS.....	31
5.4	RECIPES FOR TISSUE SIMULATING LIQUIDS.....	32
5.5	TEST EQUIPMENT FOR TISSUE PROPERTY.....	36
6.	SYSTEM VALIDATION.....	37
6.1	TEST EQUIPMENT.....	37
6.2	TEST PROCEDURE.....	38
6.3	VALIDATION RESULTS.....	40
6.4	SYSTEM VALIDATION UNCERTAINTIES.....	41
7.	MEASUREMENT SAR PROCEDURE UNCERTAINTIES.....	42
7.1	PROBE CALIBRATION UNCERTAINTY.....	42
7.2	ISOTROPY UNCERTAINTY.....	43
7.3	BOUNDARY EFFECT UNCERTAINTY.....	43
7.4	PROBE LINEARITY UNCERTAINTY.....	44
7.5	READOUT ELECTRONICS UNCERTAINTY.....	44
7.6	RESPONSE TIME UNCERTAINTY.....	44
7.7	INTEGRATION TIME UNCERTAINTY.....	45
7.8	PROBE POSITIONER MECHANICAL TOLERANCE.....	46
7.9	PROBE POSITIONING.....	46
7.10	PHANTOM UNCERTAINTY.....	47
7.11	DASY4 UNCERTAINTY BUDGET.....	48
8.	INFORMATION ON THE TESTING LABORATORIES.....	49
	APPENDIX A: TEST DATA	
	APPENDIX B: ADT SAR MEASUREMENT SYSTEM	
	APPENDIX C: PHOTOGRAPHS OF SYSTEM VALIDATION	
	APPENDIX D: SYSTEM CERTIFICATE & CALIBRATION	
	APPENDIX E: TEST CONFIGURATIONS	



1. CERTIFICATION

PRODUCT: Pocket PC Phone

MODEL: RAPH800

APPLICANT: High Tech Computer Corp.

TESTED: Jun. 09 ~ Jun. 10, 2008

TEST SAMPLE: ENGINEERING SAMPLE

STANDARDS: **FCC Part 2 (Section 2.1093)**

FCC OET Bulletin 65, Supplement C (01-01)

RSS-102

IEEE 1528-2003

The above equipment (model: RAPH800) have been tested by **Advance Data Technology Corporation**, and found compliance with the requirement of the above standards. The test record, data evaluation & Equipment Under Test (EUT) configurations represented herein are true and accurate accounts of the measurements of the sample's EMC characteristics under the conditions specified in this report.

PREPARED BY : Wendy Liao , **DATE:** Jun. 17, 2008
Wendy Liao / Senior Specialist

TECHNICAL ACCEPTANCE : James Fan , **DATE:** Jun. 17, 2008
Responsible for
RF
James Fan / Engineer

APPROVED BY : Gary Chang , **DATE:** Jun. 17, 2008
Gary Chang / Assistant Manager

2. GENERAL INFORMATION

2.1 GENERAL DESCRIPTION OF EUT

PRODUCT	Pocket PC Phone	
MODEL NO.	RAPH800	
FCC ID	NM8RAPH800	
POWER SUPPLY	3.7Vdc from rechargeable lithium battery 5.0Vdc from power adapter 5.0Vdc from host equipment	
CLASSIFICATION	Portable device, production unit	
MODULATION TYPE	OQPSK, HPSK	
FREQUENCY RANGE	824MHz ~ 849MHz ; 1850MHz ~ 1910MHz	
CHANNEL FREQUENCIES UNDER TEST AND ITS CONDUCTED OUTPUT POWER	SO55 RC3	CDMA850 band: 0.255W (24.06dBm) / 824.7MHz for channel 1013 0.268W (24.28dBm) / 836.5MHz for channel 384 0.276W (24.41dBm) / 848.3MHz for channel 777
	TDSO SO32 RC3	CDMA850 band: 0.237W (23.75dBm) / 824.7MHz for channel 1013 0.247W (23.92dBm) / 836.5MHz for channel 384 0.266W (24.25dBm) / 848.3MHz for channel 777
	1xEVDO	CDMA850 band: 0.247W (23.92dBm) / 836.5MHz for channel 384
	SO55 RC3	CDMA1900 band: 0.258W (24.12dBm) / 1851.25MHz for channel 25 0.265W (24.23dBm) / 1880.00MHz for channel 600 0.279W (24.45dBm) / 1908.75MHz for channel 1175
	TDSO SO32 RC3	CDMA1900 band: 0.243W (23.85dBm) / 1851.25MHz for channel 25 0.247W (23.93dBm) / 1880.00MHz for channel 600 0.262W (24.19dBm) / 1908.75MHz for channel 1175
	1xEVDO	CDMA1900 band: 0.267W (24.26dBm) / 1908.75MHz for channel 1175
MAX. AVERAGE SAR (1g)	Head: CDMA850 band: 0.577W/kg CDMA1900 band: 0.908W/kg	
	Body: CDMA850 band: 0.613W/kg CDMA1900 band: 0.734W/kg	
ANTENNA TYPE	PIFA antenna	
MAX. ANTENNA GAIN	850MHz: 0dBi	1900MHz: 1dBi
DATA CABLE	1.25m shielded USB cable without core	
	0.10m shielded 4-in-1 cable without core	

I/O PORTS	Refer to user's manual
ACCESSORY DEVICES	Adapter, Battery, Earphone (Brand: hTC, model: HS S300, 1.9m), Pouch

NOTE:

1. The EUT is an Pocket PC Phone. The functions of EUT listed as below:

	REFERENCE REPORT
CDMA 850 + CDMA 1900	SA970604L10
WLAN 802.11b/g	SA970604L10-1

2. The communicated functions of EUT listed as below:

		850MHz	1900MHz	With WLAN 802.11b/g + BT 2.0 with EDR + AGPS
3G	CDMA	V	V	
	1*EVDO	V	V	
	1*RTT	V	V	
	IS-95A/B	V	V	

3. The EUT has Li-ion battery listed as below:

BRAND:	hTC
MODEL:	DIAM171
RATING:	3.7Vdc, 1340mAh

4. The EUT was operated with following power adapter:

BRAND:	hTC
MODEL:	TC P300
INPUT:	100-240Vac, 0.2A, 50-60Hz
OUTPUT:	5Vdc, 1A

5. The MEID code listed as below:

A1000007*****

6. The above EUT information was declared by manufacturer and for more detailed features description, please refer to the manufacturer's specifications or User's Manual.

2.2 SAR MEASUREMENT CONDITIONS FOR CDMA

The following procedures were followed according to FCC “SAR Measurement Procedures 3G Devices”, Oct. 2007.

➤ Output Power Verification

Maximum output power is verified on the High, Middle and Low channels according to procedures in section 4.4.5.2 of 3GPP2 C.S0011/TIA-98-E. Results for at least steps 3, 4 and 10 of the power measurement procedures should be tabulated in the SAR report. Steps 3 and 4 should be measured using SO55 with power control bits in “All Up” condition. TDSO / SO32 may be used instead of SO55 for step 4. Step 10 should be measured using TDSO / SO32 with power control bits in the “Bits Hold” condition (i.e. alternative Up/Down Bits). All power measurements defined in C.S0011/TIA-98-E that are inapplicable to the DUT or cannot be measured due to technical or equipment limitations should be clearly identified in the test report.⁶

➤ Head SAR Measurement

SAR for head exposure configurations is measured in RC3 with the DUT configured to transmit at full rate using Loopback Service Option SO55. SAR for RC1 is not required when the maximum average output of each channel is less than ¼ dB higher than that measured in RC3. Otherwise, SAR is measured on the maximum output channel in RC1 using the exposure configuration that results in the highest SAR for that channel in RC3.

➤ Body SAR Measurements

SAR for body exposure configurations is measured in RC3 with the DUT configured to transmit at full rate on FCH with all other code channels disabled using TDSO / SO32. SAR for multiple code channels (FCH + SCHn) is not required when the maximum average output of each RF channel is less than ¼ dB higher than that measured with FCH only. Otherwise, SAR is measured on the maximum output channel (FCH + SCHn) with FCH at full rate and SCH0 enabled at 9600 bps using the exposure configuration that results in the highest SAR for that channel with FCH only.

When multiple code channels are enabled, the DUT output may shift by more than 0.5 dB and lead to higher SAR drifts and SCH dropouts. Body SAR in RC1 is not required when the maximum average output of each channel is less than ¼ dB higher than that measured in RC3. Otherwise, SAR is measured on the maximum output channel in RC1; with Loopback Service Option SO55, at full rate, using the body exposure configuration that results in the highest SAR for that channel in RC3.

➤ Handsets with Ev-Do

For handsets with Ev-Do capabilities, when the maximum average output of each channel in Rev. 0 is less than ¼ dB higher than that measured in RC3 (1x RTT), body



SAR for Ev-Do is not required. Otherwise, SAR for Rev. 0 is measured on the maximum output channel at **153.6 kbps** using the body exposure configuration that results in the highest SAR for that channel in RC3. SAR for Rev. A is not required when the maximum average output of each channel is less than that measured in Rev. 0 or less than ¼ dB higher than that measured in RC3. Otherwise, SAR is measured on the maximum output channel for Rev. A using a Reverse Data Channel payload size of 4096 bits and a Termination Target of 16 slots defined for Subtype 2 Physical Layer configurations. A Forward Traffic Channel data rate corresponding to the 2-slot version of 307.2 kbps with the ACK Channel transmitting in all slots should be configured in the downlink for both Rev. 0 and Rev. A.

CDMA 2000 CONDUCTED POWER													
CHAN.	FREQ. (MHz)	CDMA 2000	RAW VALUE (dBm)					CORR. FACTOR (dB)	OUTPUT POWER (dBm)				
		RC	SO2	SO55	TDSO SO32 (FCH)	TDSO SO32 (FCH+ SCH)	SO3		SO2	SO55	TDSO SO32 (FCH)	TDSO SO32 (FCH+ SCH)	SO3
1013	824.7	RC1	20.65	20.74	-	-	20.48	3.20	23.85	23.94	-	-	23.68
		RC3	20.76	20.86	20.55	20.47	20.51	3.20	23.96	24.06	23.75	23.67	23.71
384	836.5	RC1	20.85	20.92	-	-	20.52	3.20	24.05	24.12	-	-	23.72
		RC3	21.01	21.08	20.72	20.61	20.69	3.20	24.21	24.28	23.92	23.81	23.89
777	848.3	RC1	20.88	21.04	-	-	21.73	3.20	24.08	24.24	-	-	24.93
		RC3	21.09	21.21	21.05	20.83	20.91	3.20	24.29	24.41	24.25	24.03	24.11

CDMA 2000 CONDUCTED POWER													
CHAN.	FREQ. (MHz)	CDMA 2000	RAW VALUE (dBm)					CORR. FACTOR (dB)	OUTPUT POWER (dBm)				
		RC	SO2	SO55	TDSO SO32 (FCH)	TDSO SO32 (FCH+ SCH)	SO3		SO2	SO55	TDSO SO32 (FCH)	TDSO SO32 (FCH+ SCH)	SO3
25	1851.25	RC1	19.93	20.15	-	-	19.85	3.90	23.83	24.05	-	-	23.75
		RC3	20.05	20.22	19.95	19.86	19.92	3.90	23.95	24.12	23.85	23.76	23.82
600	1880.00	RC1	20.14	20.21	-	-	19.91	3.90	24.04	24.11	-	-	23.81
		RC3	20.23	20.33	20.03	19.99	20.02	3.90	24.13	24.23	23.93	23.89	23.92
1175	1908.75	RC1	20.42	20.45	-	-	20.13	3.90	24.32	24.35	-	-	24.03
		RC3	20.49	20.55	20.29	20.22	20.27	3.90	24.39	24.45	24.19	24.12	24.17



2.3 GENERAL DESCRIPTION OF APPLIED STANDARDS

According to the specifications of the manufacturer, this product must comply with the requirements of the following standards:

FCC 47 CFR Part 2 (2.1093)

FCC OET Bulletin 65, Supplement C (01- 01)

RSS-102

IEEE 1528-2003

All test items have been performed and recorded as per the above standards.



2.4 GENERAL INFORMATION OF THE SAR SYSTEM

DASY4 (software 4.7 Build 53) consists of high precision robot, probe alignment sensor, phantom, robot controller, controlled measurement server and near-field probe. The robot includes six axes that can move to the precision position of the DASY4 software defined. The DASY4 software can define the area that is detected by the probe. The robot is connected to controlled box. Controlled measurement server is connected to the controlled robot box. The DAE includes amplifier, signal multiplexing, AD converter, offset measurement and surface detection. It is connected to the Electro-optical coupler (ECO). The ECO performs the conversion from the optical into digital electric signal of the DAE and transfers data to the PC.

ET3DV6 ISOTROPIC E-FIELD PROBE (FREQUENCY BAND < 3GHz)

CONSTRUCTION	Symmetrical design with triangular core. Built-in optical fiber for surface detection system. Built-in shielding against static charges. PEEK enclosure material (resistant to organic solvents, e.g., glycoether).
FREQUENCY	10 MHz to 3 GHz; Linearity: ± 0.2 dB (30 MHz to 3 GHz)
DYNAMIC RANGE	5 μ W/g to > 100 mW/g; Linearity: ± 0.2 dB
OPTICAL SURFACE DETECTION	± 0.2 mm repeatability in air and clear liquids over diffuse reflecting surfaces
DIMENSIONS	Overall length: 330 mm (Tip Length: 16 mm) Tip diameter: 6.8 mm (Body diameter: 12 mm) Distance from probe tip to dipole centers: 2.7 mm
APPLICATION	General dosimetric measurements up to 3 GHz Fast automatic scanning in arbitrary phantoms (ET3DV6)

NOTE:

1. The Probe parameters have been calibrated by the SPEAG. Please reference "APPENDIX D" for the Calibration Certification Report.
2. For frequencies above 800 MHz, calibration in a rectangular wave-guide is used, because wave-guide size is manageable.
3. For frequencies below 800 MHz, temperature transfer calibration is used because the wave-guide size becomes relatively large.

TWIN SAM V4.0

CONSTRUCTION The shell corresponds to the specifications of the Specific Anthropomorphic Mannequin (SAM) phantom defined in IEEE 1528-2003, CENELEC 50361 and IEC 62209. It enables the dosimetric evaluation of left and right hand phone usage as well as body mounted usage at the flat phantom region. A cover prevents evaporation of the liquid. Reference markings on the phantom allow the complete setup of all predefined phantom positions and measurement grids by manually teaching three points with the robot.

SHELL THICKNESS 2 ± 0.2 mm

FILLING VOLUME Approx. 25 liters

DIMENSIONS Height: 810 mm; Length: 1000 mm; Width: 500 mm

SYSTEM VALIDATION KITS:

CONSTRUCTION	Symmetrical dipole with 1/4 balun Enables measurement of feedpoint impedance with NWA Matched for use near flat phantoms filled with brain simulating solutions Includes distance holder and tripod adaptor
CALIBRATION	Calibrated SAR value for specified position and input power at the flat phantom in brain simulating solutions
FREQUENCY	835 / 1900MHz
RETURN LOSS	> 20 dB at specified validation position
POWER CAPABILITY	> 100 W ($f < 1\text{GHz}$); > 40 W ($f > 1\text{GHz}$)
OPTIONS	Dipoles for other frequencies or solutions and other calibration conditions upon request

DEVICE HOLDER FOR SAM TWIN PHANTOM

CONSTRUCTION

The device holder for the Mobile Phone device is designed to cope with different positions given in the standard. It has two scales for the device rotation (with respect to the body axis) and the device inclination (with respect to the line between the ear reference points). The rotation centers for both scales is the ear reference point (ERP). Thus the device needs no repositioning when changing the angles. The holder has been made out of low-loss POM material having the following dielectric parameters: relative permittivity $\epsilon = 3$ and loss tangent $\delta = 0.02$. The amount of dielectric material has been reduced in the closest vicinity of the device, since measurements have suggested that the influence of the clamp on the test results could thus be lowered. The device holder for the portable device makes up of the polyethylene foam. The dielectric parameters of material close to the dielectric parameters of the air.

DATA ACQUISITION ELECTRONICS

CONSTRUCTION

The data acquisition electronics (DAE3) consists of a highly sensitive electrometer grade preamplifier with auto-zeroing, a channel and gain-switching multiplex, a fast 16 bit AD converter and a command decoder and control logic unit. Transmission to the measurement server is accomplished through an optical downlink for data and status information as well as an optical uplink for commands and the clock. The mechanical probe is mounting device includes two different sensor systems for frontal and sideways probe contacts. They are used for mechanical surface detection and probe collision detection. The input impedance of the DAE3 box is 200M Ω ; the inputs are symmetrical and floating. Common mode rejection is above 80 dB.

2.5 GENERAL DESCRIPTION OF THE SPATIAL PEAK SAR EVALUATION

The DASY4 post-processing software (SEMCAD) automatically executes the following procedures to calculate the field units from the micro-volt readings at the probe connector. The parameters used in the evaluation are stored in the configuration modules of the software:

Probe parameters:	- Sensitivity	Norm _i , a _{i0} , a _{i1} , a _{i2}
	- Conversion factor	ConvF _i
	- Diode compression point	dcp _i
Device parameters:	- Frequency	F
	- Crest factor	Cf
Media parameters:	- Conductivity	σ
	- Density	ρ

The first step of the evaluation is a linearization of the filtered input signal to account for the compression characteristics of the detector diode. The compensation depends on the input signal, the diode type and the DC-transmission factor from the diode to the evaluation electronics. If the exciting field is pulsed, the crest factor of the signal must be known to correctly compensate for peak power. The formula for each channel can be given as:

$$V_i = U_i + U_i^2 \cdot \frac{cf}{dcp_i}$$

V _i	=compensated signal of channel i	(i = x, y, z)
U _i	=input signal of channel I	(i = x, y, z)
Cf	=crest factor of exciting field	(DASY parameter)
dcp _i	=diode compression point	(DASY parameter)

From the compensated input signals the primary field data for each channel can be evaluated:

$$\text{E-field probes: } E_i = \sqrt{\frac{V_i}{\text{Norm}_i \cdot \text{Conv}F}}$$

$$\text{H-field probes: } H_i = \sqrt{V_i} \cdot \frac{a_{i0} + a_{i1}f + a_{i2}f^2}{f}$$

V_i = compensated signal of channel i ($i = x, y, z$)

Norm_i = sensor sensitivity of channel i $\mu\text{V}/(\text{V/m})^2$ for ($i = x, y, z$)
E-field Probes

$\text{Conv}F$ = sensitivity enhancement in solution

a_{ij} = sensor sensitivity factors for H-field probes

F = carrier frequency [GHz]

E_i = electric field strength of channel i in V/m

H_i = magnetic field strength of channel i in A/m

The RSS value of the field components gives the total field strength (Hermitian magnitude):

$$E_{tot} = \sqrt{E_x^2 + E_y^2 + E_z^2}$$

The primary field data are used to calculate the derived field units.

$$SAR = E_{tot}^2 \cdot \frac{\sigma}{\rho \cdot 1'000}$$

SAR = local specific absorption rate in mW/g

E_{tot} = total field strength in V/m

σ = conductivity in [mho/m] or [Siemens/m]

ρ = equivalent tissue density in g/cm³

Note that the density is set to 1, to account for actual head tissue density rather than the density of the tissue simulating liquid. The entire evaluation of the spatial peak values is performed within the Post-processing engine (SEMCAD). The system always gives the maximum values for the 1 g and 10 g cubes. The algorithm to find the cube with highest averaged SAR is divided into the following stages:

1. The extraction of the measured data (grid and values) from the Zoom Scan
2. The calculation of the SAR value at every measurement point based on all stored data (A/D values and measurement parameters)
3. The generation of a high-resolution mesh within the measured volume
4. The interpolation of all measured values from the measurement grid to the high-resolution grid
5. The extrapolation of the entire 3-D field distribution to the phantom surface over the distance from sensor to surface
6. The calculation of the averaged SAR within masses of 1 g and 10 g.

The probe is calibrated at the center of the dipole sensors that is located 1 to 2.7mm away from the probe tip. During measurements, the probe stops shortly above the phantom surface, depending on the probe and the surface detecting system. Both distances are included as parameters in the probe configuration file. The software always knows exactly how far away the measured point is from the surface. As the probe cannot directly measure at the surface, the values between the deepest measured point and the surface must be extrapolated. The angle between the probe axis and the surface normal line is less than 30 degree.

In the Area Scan, the gradient of the interpolation function is evaluated to find all the extreme of the SAR distribution. The uncertainty on the locations of the extreme is less than 1/20 of the grid size. Only local maximum within -2 dB of the global maximum are searched and passed for the Cube Scan measurement. In the Cube Scan, the interpolation function is used to extrapolate the Peak SAR from the lowest measurement points to the inner phantom surface (the extrapolation distance). The uncertainty increases with the extrapolation distance. To keep the uncertainty within 1% for the 1 g and 10 g cubes, the extrapolation distance should not be larger than 5mm.

The maximum search is automatically performed after each area scan measurement. It is based on splines in two or three dimensions. The procedure can find the maximum for most SAR distributions even with relatively large grid spacing. After the area scanning measurement, the probe is automatically moved to a position at the interpolated maximum. The following scan can directly use this position for reference, e.g., for a finer resolution grid or the cube evaluations. The 1g and 10g peak evaluations are only available for the predefined cube 7 x 7 x 7 scans. The routines are verified and optimized for the grid dimensions used in these cube measurements. The measured volume of 30 x 30 x 30mm contains about 30g of tissue. The first procedure is an extrapolation (incl. boundary correction) to get the points between the lowest measured plane and the surface. The next step uses 3D interpolation to get all points within the measured volume in a 1mm grid (42875 points). In the last step, a 1g cube is placed numerically into the volume and its averaged SAR is calculated. This cube is then moved around until the highest averaged SAR is found. If the highest SAR is found at the edge of the measured volume, the system will issue a warning: higher SAR values might be found outside of the measured volume. In that case the cube measurement can be repeated, using the new interpolated maximum as the center.



3. DESCRIPTION OF SUPPORT UNITS

The EUT has been tested as an independent unit together with other necessary accessories or support units. The following support units or accessories were used to form a representative test configuration during the tests.

NO.	PRODUCT	BRAND	MODEL NO.	SERIAL NO.	CALIBRATED UNTIL
1	Universal Radio Communication Tester	R&S	CMU200	101372	Nov. 25, 2008

NO.	SIGNAL CABLE DESCRIPTION OF THE ABOVE SUPPORT UNITS
1	NA

NOTE: All power cords of the above support units are non shielded (1.8m).

4. DESCRIPTION OF TEST POSITION

4.1 DESCRIPTION OF TEST POSITION

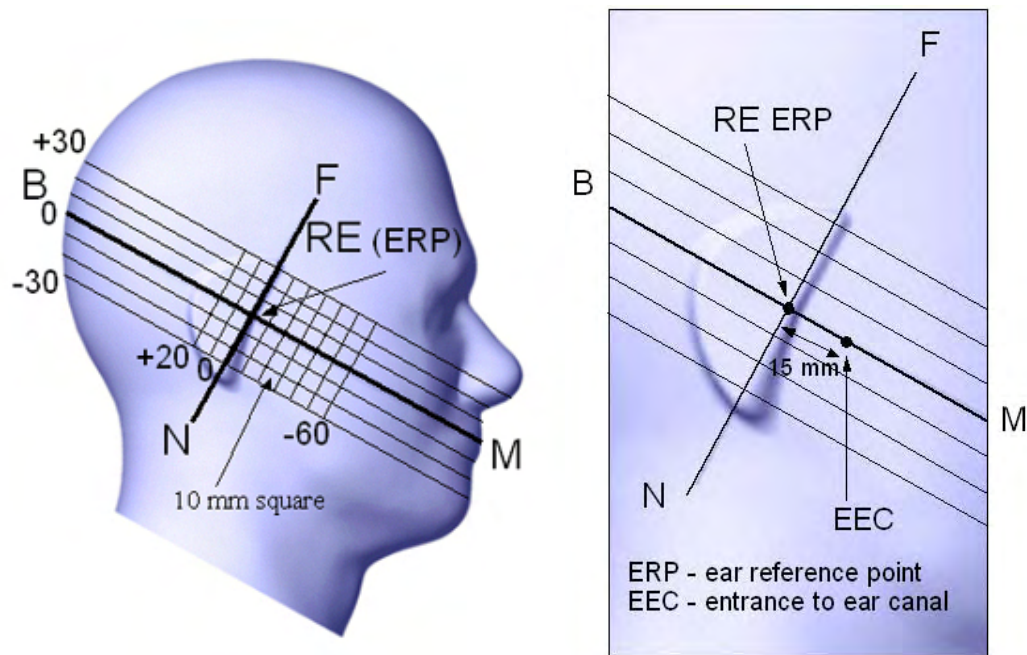

FIGURE 3.1

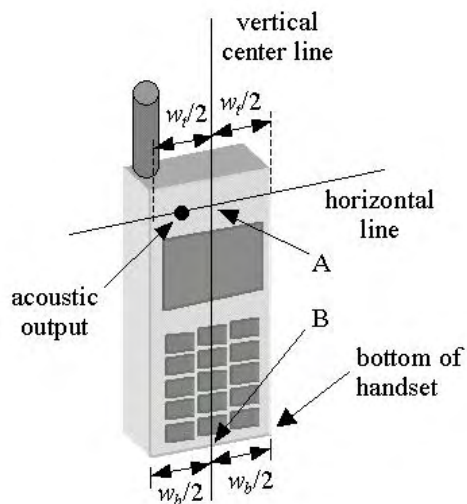

FIGURE 3.1a

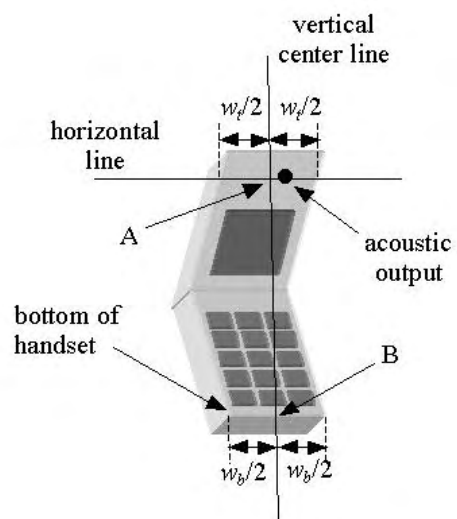
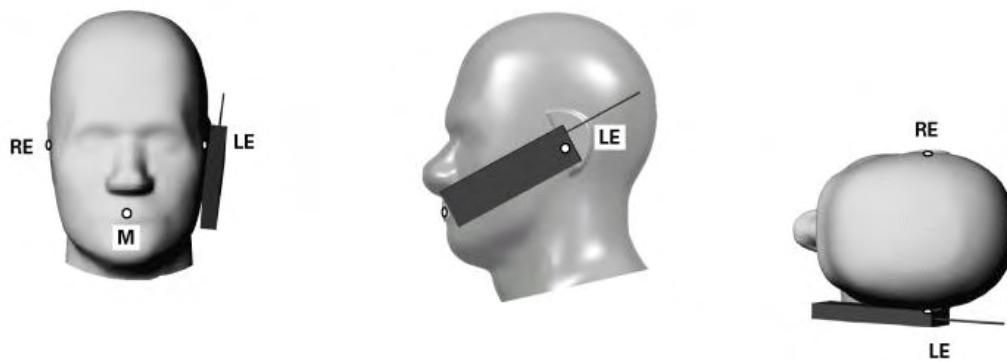

FIGURE 3.1b

4.2.1 TOUCH/CHEEK TEST POSITION

The head position in Figure 3.1, the ear reference points ERP are 15mm above entrance to ear canal along the B-M line. The line N-F (Neck-Front) is perpendicular to the B-M (Back Mouth) line. The handset device in Figure 3.1a and 3.1b, The vertical centerline pass through two points on the front side of handset: the midpoint of the width w_t of the handset at the level of the acoustic output (point A) and the midpoint of the width w_b of the bottom of the handset (point B). The vertical centerline is perpendicular to the horizontal line and pass through the center of the acoustic output. The point A touches the ERP and the vertical centerline of the handset is parallel to the B-M line. While maintaining the point A contact with the ear(ERP), rotate the handset about the line NF until any point on handset is in contact with the cheek of the phantom



TOUCH/CHEEK POSITION FIGURE

4.2.2 TILT TEST POSITION

Adjust the device in the cheek position. While maintaining a point of the handset contact in the ear, move the bottom of the handset away from the mouth by an angle of 15 degrees.



TILT POSITION FIGURE

4.2.3 BODY-WORN CONFIGURATION

The handset device attached the belt clip or the holster. The keypad face of the handset is against with the bottom of the flat phantom face and the bottom of the keypad face contact to the bottom of the flat phantom.

When multiple accessories that do not contain metallic components are supplied with the device, the device may be tested with only the accessory that dictates the closest spacing to the body. When multiple accessories that contain metallic components are supplied with the device, the device must be tested with each accessory that contains a unique metallic component. If multiple accessories share an identical metallic component (e.g., the same metallic belt-clip used with different holsters with no other metallic components), only accessory that dictates the closest spacing to the body must be tested.

4.2 DESCRIPTION OF TEST MODE

TEST MODE	COMMUNICATION MODE	MODULATION TYPE	ASSESSMENT POSITION	TESTED CHANNEL
1	CDMA 850	OQPSK	A / Cheek	1013, 384, 777
2		OQPSK	A / Tilt	1013, 384, 777
3		OQPSK	B / Cheek	1013, 384, 777
4		OQPSK	B / Tilt	1013, 384, 777
5		OQPSK	C : Body / Bottom	1013, 384, 777
6	1xEVDO 850	HPSK	C : Body / Bottom	384
7	CDMA 850	OQPSK	C : Body / Front	384
8	CDMA 1900	OQPSK	A / Cheek	25, 600, 1175
9		OQPSK	A / Tilt	25, 600, 1175
10		OQPSK	B / Cheek	25, 600, 1175
11		OQPSK	B / Tilt	25, 600, 1175
12		OQPSK	C : Body / Bottom	25, 600, 1175
13	1xEVDO 1900	HPSK	C : Body / Bottom	1175
14	CDMA 1900	OQPSK	C : Body / Front	1175

- NOTE:** 1. The combination is from the worst situation of each communication mode.
 2. Assessment position A: Right head position, B: Left head position, C: Body position, please refer to appendix E for the photo.

4.3 SUMMARY OF TEST RESULTS

PART OF ASSESSMENT	HEAD POSITION			
COMMUNICATION MODE	CDMA 850			
TEST MODE	1	2	3	4
	MEASURED VALUE OF 1g SAR (W/kg)			
	RIGHT		LEFT	
CHANNEL	CHEEK	TILT	CHEEK	TILT
1013	0.360	0.199	0.482	0.149
384	0.413	0.257	0.545	0.261
777	0.444	0.271	0.577	0.199

NOTE: The worst value of each communication mode has been marked by boldface.

PART OF ASSESSMENT	BODY POSITION		
COMMUNICATION MODE	CDMA 850		1XEVD0 850
TEST MODE	5	7	6
	MEASURED VALUE OF 1g SAR (W/kg)		
	BOTTOM	FRONT	BOTTOM
1013	0.513	-	-
384	0.613	0.278	0.607
777	0.559	-	-

NOTE: The worst value of each communication mode has been marked by boldface.

PART OF ASSESSMENT	HEAD POSITION				
COMMUNICATION MODE	CDMA 1900				
TEST MODE	8	9	12	10	11
	MEASURED VALUE OF 1g SAR (W/kg)				
	RIGHT			LEFT	
CHANNEL	CHEEK	TILT	CHEEK	TILT	
25	0.532	0.680	0.503	0.718	
600	0.613	0.853	0.559	0.842	
1175	0.676	0.908	0.656	0.847	

NOTE: The worst value of each communication mode has been marked by boldface.

PART OF ASSESSMENT	BODY POSITION		
COMMUNICATION MODE	CDMA 1900		1XEVDO 1900
TEST MODE	13	15	14
	MEASURED VALUE OF 1g SAR (W/kg)		
	BOTTOM	FRONT	BOTTOM
25	0.692	-	-
600	0.731	-	-
1175	0.734	0.226	0.694

NOTE: The worst value of each communication mode has been marked by boldface.

5. TEST RESULTS

5.1 TEST PROCEDURES

The EUT makes a phone call to the communication simulator station. Establish the simulation communication configuration rather the actual communication. Then the EUT could continuous the transmission mode. Adjust the PCL of the base station could controlled the EUT to transmitted the maximum output power. The base station also could control the transmission channel. The SAR value was calculated via the 3D spline interpolation algorithm that has been implemented in the software of DASY4 SAR measurement system manufactured and calibrated by SPEAG. According to the IEEE 1528 / EN 50361, the recommended procedure for assessing the peak spatial-average SAR value consists of the following steps:

- Power reference measurement
- Verification of the power reference measurement
- Area scan
- Zoom scan
- Power reference measurement

The area scan with 15mm x 15mm grid was performed for the highest spatial SAR location. Consist of 11 x 13 points while the scan size is the 150mm x 180mm. The zoom scan with 30mm x 30mm x 30mm volume was performed for SAR value averaged over 1g and 10g spatial volumes.



In the zoom scan, the distance between the measurement point at the probe sensor location (geometric center behind the probe tip) and the phantom surface is 4.0 mm and maintained at a constant distance of ± 1.0 mm during a zoom scan to determine peak SAR locations. The distance is 4mm between the first measurement point and the bottom surface of the phantom. The secondary measurement point to the bottom surface of the phantom is with 9mm separation distance. The cube size is 7 x 7 x 7 points consist of 343 points and the grid space is 5mm.

The measurement time is 0.5 s at each point of the zoom scan. The probe boundary effect compensation shall be applied during the SAR test. Because of the tip of the probe to the Phantom surface separated distances are longer than half a tip probe diameter.

In the area scan, the separation distance is 4mm between the each measurement point and the phantom surface. The scan size shall be included the transmission portion of the EUT. The measurement time is the same as the zoom scan. At last the reference power drift shall be less than $\pm 5\%$.

5.2 MEASURED SAR RESULTS

CDMA 850 BAND RIGHT HEAD POSITION

ENVIRONMENTAL CONDITION		Air Temperature : 23.6°C, Liquid Temperature : 22.8°C Humidity : 62%RH						
TESTED BY		Sam Onn			DATE		Jun. 09 ~ Jun. 10, 2008	
CHAN.	FREQ. (MHz)	MODULATION TYPE	CONDUCTED POWER (W)		POWER DRIFT (%)	DEVICE USE POWER	DEVICE TEST POSITION MODE	MEASURED 1g SAR (W/kg)
			BEGIN TEST	AFTER TEST				
1013	824.7 (Low)	OQPSK	0.255	0.253	-0.78	Standard Battery	1	0.360
384	836.5 (Mid.)	OQPSK	0.268	0.266	-0.75	Standard Battery	1	0.413
777	848.3 (High)	OQPSK	0.276	0.273	-1.09	Standard Battery	1	0.444
1013	824.7 (Low)	OQPSK	0.255	0.252	-1.18	Standard Battery	2	0.199
384	836.5 (Mid.)	OQPSK	0.268	0.265	-1.12	Standard Battery	2	0.257
777	848.3 (High)	OQPSK	0.276	0.272	-1.45	Standard Battery	2	0.271

NOTE:

1. Test configuration of each mode is described in section 3.
2. In this testing, the limit for General Population Spatial Peak averaged over **1g, 1.6W/kg**, is applied.
3. Please see the Appendix A for the data.
4. The variation of the EUT conducted power measured before and after SAR testing should not over 5%.

CDMA 850 BAND LEFT HEAD POSITION

ENVIRONMENTAL CONDITION		Air Temperature : 23.6°C, Liquid Temperature : 22.8°C Humidity : 62%RH						
TESTED BY		Sam Onn			DATE		Jun. 09 ~ Jun. 10, 2008	
CHAN.	FREQ. (MHz)	MODULATION TYPE	CONDUCTED POWER (W)		POWER DRIFT (%)	DEVICE USE POWER	DEVICE TEST POSITION MODE	MEASURED 1g SAR (W/kg)
			BEGIN TEST	AFTER TEST				
1013	824.7 (Low)	OQPSK	0.255	0.251	-1.57	Standard Battery	3	0.482
384	836.5 (Mid.)	OQPSK	0.268	0.264	-1.49	Standard Battery	3	0.545
777	848.3 (High)	OQPSK	0.276	0.271	-1.81	Standard Battery	3	0.577
1013	824.7 (Low)	OQPSK	0.255	0.250	-1.96	Standard Battery	4	0.149
384	836.5 (Mid.)	OQPSK	0.268	0.263	-1.87	Standard Battery	4	0.261
777	848.3 (High)	OQPSK	0.276	0.270	-2.17	Standard Battery	4	0.199

NOTE:

1. Test configuration of each mode is described in section 3.
2. In this testing, the limit for General Population Spatial Peak averaged over **1g, 1.6W/kg**, is applied.
3. Please see the Appendix A for the data.
4. The variation of the EUT conducted power measured before and after SAR testing should not over 5%.

CDMA 850 & 1 x EVDO 850 BAND BODY POSITION

ENVIRONMENTAL CONDITION		Air Temperature : 23.2°C, Liquid Temperature : 22.1°C Humidity : 65%RH						
TESTED BY		Sam Onn			DATE		Jun. 09 ~ Jun. 10, 2008	
CHAN.	FREQ. (MHz)	MODULATION TYPE	CONDUCTED POWER (W)		POWER DRIFT (%)	DEVICE USE POWER	DEVICE TEST POSITION MODE	MEASURED 1g SAR (W/kg)
			BEGIN TEST	AFTER TEST				
1013	824.7 (Low)	OQPSK	0.237	0.235	-0.84	Standard Battery	5	0.513
384	836.5 (Mid.)	OQPSK	0.247	0.244	-1.21	Standard Battery	5	0.613
777	848.3 (High)	OQPSK	0.266	0.262	-1.50	Standard Battery	5	0.559
384	836.5 (Mid.)	HPSK	0.247	0.243	-1.62	Standard Battery	6	0.607
384	836.5 (Mid.)	OQPSK	0.247	0.242	-2.02	Standard Battery	7	0.278

NOTE:

1. Test configuration of each mode is described in section 3.
2. In this testing, the limit for General Population Spatial Peak averaged over **1g, 1.6W/kg**, is applied.
3. Please see the Appendix A for the data.
4. The variation of the EUT conducted power measured before and after SAR testing should not over 5%.

CDMA 1900 BAND RIGHT HEAD POSITION

ENVIRONMENTAL CONDITION		Air Temperature : 23.4°C, Liquid Temperature : 22.1°C Humidity : 63%RH						
TESTED BY		Sam Onn			DATE		Jun. 10, 2008	
CHAN.	FREQ. (MHz)	MODULATION TYPE	CONDUCTED POWER (W)		POWER DRIFT (%)	DEVICE USE POWER	DEVICE TEST POSITION MODE	MEASURED 1g SAR (W/kg)
			BEGIN TEST	AFTER TEST				
25	1851.25 (Low)	OQPSK	0.258	0.256	-0.78	Standard Battery	8	0.532
600	1880.00 (Mid.)	OQPSK	0.265	0.262	-1.13	Standard Battery	8	0.613
1175	1908.75 (High)	OQPSK	0.279	0.275	-1.43	Standard Battery	8	0.676
25	1851.25 (Low)	OQPSK	0.258	0.255	-1.16	Standard Battery	9	0.680
600	1880.00 (Mid.)	OQPSK	0.265	0.261	-1.51	Standard Battery	9	0.853
1175	1908.75 (High)	OQPSK	0.279	0.274	-1.79	Standard Battery	9	0.908

NOTE:

1. Test configuration of each mode is described in section 3.
2. In this testing, the limit for General Population Spatial Peak averaged over **1g, 1.6W/kg**, is applied.
3. Please see the Appendix A for the data.
4. The variation of the EUT conducted power measured before and after SAR testing should not over 5%.

CDMA 1900 BAND LEFT HEAD POSITION

ENVIRONMENTAL CONDITION		Air Temperature : 23.4°C, Liquid Temperature : 22.1°C Humidity : 63%RH						
TESTED BY		Sam Onn			DATE		Jun. 10, 2008	
CHAN.	FREQ. (MHz)	MODULATION TYPE	CONDUCTED POWER (W)		POWER DRIFT (%)	DEVICE USE POWER	DEVICE TEST POSITION MODE	MEASURED 1g SAR (W/kg)
			BEGIN TEST	AFTER TEST				
25	1851.25 (Low)	OQPSK	0.258	0.254	-1.55	Standard Battery	10	0.503
600	1880.00 (Mid.)	OQPSK	0.265	0.260	-1.89	Standard Battery	10	0.559
1175	1908.75 (High)	OQPSK	0.279	0.273	-2.15	Standard Battery	10	0.656
25	1851.25 (Low)	OQPSK	0.258	0.253	-1.94	Standard Battery	11	0.718
600	1880.00 (Mid.)	OQPSK	0.265	0.259	-2.26	Standard Battery	11	0.842
1175	1908.75 (High)	OQPSK	0.279	0.272	-2.51	Standard Battery	11	0.847

NOTE:

1. Test configuration of each mode is described in section 3.
2. In this testing, the limit for General Population Spatial Peak averaged over **1g, 1.6W/kg**, is applied.
3. Please see the Appendix A for the data.
4. The variation of the EUT conducted power measured before and after SAR testing should not over 5%.



CDMA 1900 & 1 x EVDO 1900 BAND BODY POSITION

ENVIRONMENTAL CONDITION		Air Temperature : 23.9°C, Liquid Temperature : 22.7°C Humidity : 64%RH						
TESTED BY		Sam Onn			DATE		Jun. 10, 2008	
CHAN.	FREQ. (MHz)	MODULATION TYPE	CONDUCTED POWER (W)		POWER DRIFT (%)	DEVICE USE POWER	DEVICE TEST POSITION MODE	MEASURED 1g SAR (W/kg)
			BEGIN TEST	AFTER TEST				
25	1851.25 (Low)	OQPSK	0.243	0.241	-0.82	Standard Battery	12	0.692
600	1880.00 (Mid.)	OQPSK	0.247	0.244	-1.21	Standard Battery	12	0.731
1175	1908.75 (High)	OQPSK	0.262	0.258	-1.53	Standard Battery	12	0.734
1175	1908.75 (High)	HPSK	0.267	0.262	-1.87	Standard Battery	13	0.694
1175	1908.75 (High)	OQPSK	0.262	0.257	-1.91	Standard Battery	14	0.226

NOTE:

1. Test configuration of each mode is described in section 3.
2. In this testing, the limit for General Population Spatial Peak averaged over **1g, 1.6W/kg**, is applied.
3. Please see the Appendix A for the data.
4. The variation of the EUT conducted power measured before and after SAR testing should not over 5%.

5.3 SAR LIMITS

HUMAN EXPOSURE	SAR (W/kg)	
	(General Population / Uncontrolled Exposure Environment)	(Occupational / controlled Exposure Environment)
Spatial Average (whole body)	0.08	0.4
Spatial Peak (averaged over 1 g)	1.6	8.0
Spatial Peak (hands/wrists/feet/ankles averaged over 10 g)	4.0	20.0

NOTE:

1. This limits accord to 47 CFR 2.1093 – Safety Limit.
2. The EUT property been complied with the partial body exposure limit under the general population environment.

5.4 RECIPES FOR TISSUE SIMULATING LIQUIDS

For the measurement of the field distribution inside the SAM phantom, the phantom must be filled with 25 liters of tissue simulation liquid.

The following ingredients are used :

- **WATER-** Deionized water (pure H₂O), resistivity $\approx 16 \text{ M}$ - as basis for the liquid
- **SUGAR-** Refined sugar in crystals, as available in food shops - to reduce relative permittivity
- **SALT-** Pure NaCl - to increase conductivity
- **CELLULOSE-** Hydroxyethyl-cellulose, medium viscosity (75-125 mPa.s, 2% in water, 20_C),
CAS # 54290 - to increase viscosity and to keep sugar in solution
- **PRESERVATIVE-** Preventol D-7 Bayer AG, D-51368 Leverkusen, CAS # 55965-84-9 - to prevent the spread of bacteria and molds
- **DGMBE-** Diethylenglycol-monobuthyl ether (DGMBE), Fluka Chemie GmbH, CAS # 112-34-5 - to reduce relative permittivity

THE RECIPES FOR 835MHz SIMULATING LIQUID TABLE

INGREDIENT	HEAD SIMULATING LIQUID 835MHz (HSL-835)	MUSCLE SIMULATING LIQUID 835MHz (MSL-835)
Water	40.28%	50.07%
Cellulose	02.41%	NA
Salt	01.38%	0.94%
Preventtol D-7	00.18%	0.09%
Sugar	57.97%	48.2%
Dielectric Parameters at 22°C	f = 835MHz $\epsilon = 41.5 \pm 5\%$ $\sigma = 0.97 \pm 5\% \text{ S/m}$	f = 835MHz $\epsilon = 55.0 \pm 5\%$ $\sigma = 1.05 \pm 5\% \text{ S/m}$

THE RECIPES FOR 1900MHz SIMULATING LIQUID TABLE

INGREDIENT	HEAD SIMULATING LIQUID 1900MHz (HSL-1900)	MUSCLE SIMULATING LIQUID 1900MHz (MSL-1900)
Water	55.24%	70.16%
DGMBE	44.45%	29.44%
Salt	0.306%	00.39%
Dielectric Parameters at 22°C	f= 1900MHz $\epsilon = 40.0 \pm 5\%$ $\sigma = 1.40 \pm 5\% \text{ S/m}$	f= 1900MHz $\epsilon = 53.3 \pm 5\%$ $\sigma = 1.52 \pm 5\% \text{ S/m}$



Testing the liquids using the Agilent Network Analyzer E8358A and Agilent Dielectric Probe Kit 85070D. The testing procedure is following as

1. Turn Network Analyzer on and allow at least 30 min. warm up.
2. Mount dielectric probe kit so that interconnecting cable to Network Analyzer will not be moved during measurements or calibration.
3. Pour de-ionized water and measure water temperature ($\pm 1^\circ$).
4. Set water temperature in Agilent-Software (Calibration Setup).
5. Perform calibration.
6. Validate calibration with dielectric material of known properties (e.g. polished ceramic slab with $>8\text{mm}$ thickness $\epsilon' = 10.0$, $\epsilon'' = 0.0$). If measured parameters do not fit within tolerance, repeat calibration (± 0.2 for ϵ' : ± 0.1 for ϵ'').
7. Conductivity can be calculated from ϵ'' by $\sigma = \omega \epsilon_0 \epsilon'' = \epsilon'' f [\text{GHz}] / 18$.
8. Measure liquid shortly after calibration. Repeat calibration every hour.
9. Stir the liquid to be measured. Take a sample ($\sim 50\text{ml}$) with a syringe from the center of the liquid container.
10. Pour the liquid into a small glass flask. Hold the syringe at the bottom of the flask to avoid air bubbles.
11. Put the dielectric probe in the glass flask. Check that there are no air bubbles in front of the opening in the dielectric probe kit.
12. Perform measurements.
13. Adjust medium parameters in DASY4 for the frequencies necessary for the measurements ('Setup Config', select medium (e.g. Brain 900 MHz) and press 'Option'-button.

Select the current medium for the frequency of the validation (e.g. Setup Medium Brain 900 MHz).



FOR CDMA850 BAND SIMULATING LIQUID

LIQUID TYPE		HSL-835		MSL-835	
SIMULATING LIQUID TEMP.		22.8		22.1	
TESTED DATE		Jun. 09, 2008		Jun. 09, 2008	
TESTED BY		Sam Onn		Sam Onn	
FREQ. (MHz)	LIQUID PARAMETER	STANDARD VALUE	MEASUREMENT VALUE	STANDARD VALUE	MEASUREMENT VALUE
824.70	Permittivity (ϵ)	41.6	42.0	55.2	56.8
835.00		41.5	41.9	55.2	56.7
836.50		41.5	41.9	55.2	56.7
848.30		41.5	41.7	55.2	56.6
824.70	Conductivity (σ) S/m	0.90	0.92	0.97	1.00
835.00		0.90	0.93	0.97	1.01
836.50		0.90	0.94	0.97	1.01
848.30		0.91	0.95	0.99	1.02
Dielectric Parameters Required at 22°C		f= 835MHz $\epsilon= 41.5 \pm 5\%$ $\sigma= 0.97 \pm 5\% \text{ S/m}$		f= 835MHz $\epsilon= 55.0 \pm 5\%$ $\sigma= 1.05 \pm 5\% \text{ S/m}$	

FOR CDMA1900 BAND SIMULATING LIQUID

LIQUID TYPE		HSL-1900		MSL-1900	
SIMULATING LIQUID TEMP.		22.1		22.7	
TESTED DATE		Jun. 10, 2008		Jun. 10, 2008	
TESTED BY		Sam Onn		Sam Onn	
FREQ. (MHz)	LIQUID PARAMETER	STANDARD VALUE	MEASUREMENT VALUE	STANDARD VALUE	MEASUREMENT VALUE
1851.25	Permittivity (ϵ)	40.0	40.3	53.3	54.2
1880.00		40.0	40.2	53.3	54.1
1900.00		40.0	40.2	53.3	54.0
1908.75		40.0	40.1	53.3	54.0
1851.25	Conductivity (σ) S/m	1.40	1.35	1.52	1.51
1880.00		1.40	1.39	1.52	1.54
1900.00		1.40	1.42	1.52	1.57
1908.75		1.40	1.42	1.52	1.58
Dielectric Parameters Required at 22°C		f= 1900MHz $\epsilon= 40.0 \pm 5\%$ $\sigma= 1.40 \pm 5\%$ S/m		f= 1900MHz $\epsilon= 53.3 \pm 5\%$ $\sigma= 1.52 \pm 5\%$ S/m	

5.5 TEST EQUIPMENT FOR TISSUE PROPERTY

ITEM	NAME	BAND	TYPE	SERIES NO.	CALIBRATED UNTIL
1	Network Analyzer	Agilent	E8358A	US41480538	Nov. 11, 2008
2	Dielectric Probe	Agilent	85070D	US01440176	NA

NOTE:

1. Before testing the measurement, all test equipment shall have 30 min warm up.
2. The tolerance (k=1) specified by Agilent for general dielectric measurements, deriving from inaccuracies in the calibration data, analyzer drift, and random errors, are usually $\pm 2.5\%$ and $\pm 5\%$ for measured permittivity and conductivity, respectively. However, the tolerances for the conductivity is smaller for material with large loss tangents, i.e., less than $\pm 2.5\%$ (k=1). It can be substantially smaller if more accurate methods are applied.



6. SYSTEM VALIDATION

The system validation was performed in the flat phantom with equipment listed in the following table. Since the SAR value is calculated from the measured electric field, dielectric constant and conductivity of the body tissue and the SAR is proportional to the square of the electric field. So, the SAR value will be also proportional to the RF power input to the system validation dipole under the same test environment. In our system validation test, 250mW RF input power was used.

6.1 TEST EQUIPMENT

ITEM	NAME	BAND	TYPE	SERIES NO.	CALIBRATED UNTIL
1	SAM Phantom	S & P	QD000 P40 CA	TP-1150	NA
2	Signal Generator	Agilent	68247B	984703	May 26, 2009
3	E-Field Probe	S & P	ET3DV6	1790	Nov. 19, 2008
5	DAE	S & P	DAE3 V1	510	Aug. 28, 2008
6	Robot Positioner	Staubli Unimation	NA	NA	NA
7	Validation Dipole	S & P	D835V2	4d021	May 12, 2009
		S & P	D1900V2	5d022	Aug. 27, 2008

NOTE: Before starting the measurement, all test equipment shall be warmed up for 30min.

6.2 TEST PROCEDURE

Before you start the system performance check, need only to tell the system with which components (probe, medium, and device) are performing the system performance check; the system will take care of all parameters. The dipole must be placed beneath the flat phantom section of the SAM Twin Phantom with the correct distance holder in place. The distance holder should touch the phantom surface with a light pressure at the reference marking (little cross) and be oriented parallel to the long side of the phantom. Accurate positioning is not necessary, since the system will search for the peak SAR location, except that the dipole arms should be parallel to the surface. The device holder for the EUT can be left in place but should be rotated away from the dipole.

1.The "Power Reference Measurement" and "Power Drift Measurement" jobs are located at the beginning and end of the batch process. They measure the field drift at one single point in the liquid over the complete procedure. The indicated drift is mainly the variation of the amplifier output power. If it is too high (above ± 0.1 dB), the system performance check should be repeated; some amplifiers have very high drift during warm-up. A stable amplifier gives drift results in the DASY system below ± 0.02 dB.

2.The "Surface Check" job tests the optical surface detection system of the DASY system by repeatedly detecting the surface with the optical and mechanical surface detector and comparing the results. The output gives the detecting heights of both systems, the difference between the two systems and the standard deviation of the detection repeatability. Air bubbles or refraction in the liquid due to separation of the sugar-water mixture gives poor repeatability (above ± 0.1 mm). In that case it is better to abort the system performance check and stir the liquid. The difference between the optical surface detection and the actual surface depends on the probe and is specified with each probe. (It does not depend on the surface reflectivity or the probe angle to the surface within $\pm 30^\circ$.) However, varying breaking indices of different liquid compositions might also influence the distance. If the indicated difference varies from the actual setting, the probe parameter "optical surface

3. The "Area Scan" job measures the SAR above the dipole on a plane parallel to the surface. It is used to locate the approximate location of the peak SAR. The proposed scan uses large grid spacing for faster measurement; due to the symmetric field, the peak detection is reliable. If a finer graphic is desired, the grid spacing can be reduced. Grid spacing and orientation have no influence on the SAR result.

4. The "Zoom Scan" job measures the field in a volume around the peak SAR value assessed in the previous "Area Scan" job (for more information see the application note on SAR evaluation).

About the validation dipole positioning uncertainty, the constant and low loss dielectric spacer is used to establish the correct distance between the top surface of the dipole and the bottom surface of the phantom, the error component introduced by the uncertainty of the distance between the liquid (i.e., phantom shell) and the validation dipole in the DASY4 system is less than ± 0.1 mm.

$$SAR_{tolerance} [\%] = 100 \times \left(\frac{(a + d)^2}{a^2} - 1 \right)$$

As the closest distance is 10mm, the resulting tolerance $SAR_{tolerance} [\%]$ is <2%.

6.3 VALIDATION RESULTS

SYSTEM VALIDATION TEST OF SIMULATING LIQUID					
FREQUENCY (MHz)	REQUIRED SAR (mW/g)	MEASURED SAR (mW/g)	DEVIATION (%)	SEPARATION DISTANCE	TESTED DATE
HSL 835	2.31 (1g)	2.20	-4.76	15mm	Jun. 09 ~ Jun. 10, 2008
MSL 835	2.34 (1g)	2.25	-3.85	15mm	Jun. 09 ~ Jun. 10, 2008
HSL 1900	9.42 (1g)	9.42	0.00	10mm	Jun.10, 2008
MSL 1900	9.44 (1g)	9.35	-0.95	10mm	Jun.10, 2008
TESTED BY	Sam Onn				

NOTE: Please sees Appendix for the photo of system validation test.

6.4 SYSTEM VALIDATION UNCERTAINTIES

In the table below, the system validation uncertainty with respect to the analytically assessed SAR value of a dipole source as given in the IEEE 1528 standard is given. This uncertainty is smaller than the expected uncertainty for mobile phone measurements due to the simplified setup and the symmetric field distribution.

Error Description	Tolerance (±%)	Probability Distribution	Divisor	(C _i)		Standard Uncertainty (±%)		(v _i)
				(1g)	(10g)	(1g)	(10g)	
Measurement System								
Probe Calibration	4.8	Normal	1	1	1	4.8	4.8	∞
Axial Isotropy	4.7	Rectangular	$\sqrt{3}$	1	1	2.7	2.7	∞
Hemispherical Isotropy	0	Rectangular	$\sqrt{3}$	1	1	0	0	∞
Boundary effect	1.0	Rectangular	$\sqrt{3}$	1	1	0.6	0.6	∞
Linearity	4.7	Rectangular	$\sqrt{3}$	1	1	2.7	2.7	∞
System Detection Limit	1.0	Rectangular	$\sqrt{3}$	1	1	0.6	0.6	∞
Readout Electronics	1.0	Normal	1	1	1	1.0	1.0	∞
Response Time	0	Rectangular	$\sqrt{3}$	1	1	0	0	∞
Integration Time	0	Rectangular	$\sqrt{3}$	1	1	0	0	∞
RF Ambient Conditions	3.0	Rectangular	$\sqrt{3}$	1	1	1.7	1.7	∞
Probe Positioner	0.4	Rectangular	$\sqrt{3}$	1	1	0.2	0.2	∞
Probe positioning	2.9	Rectangular	$\sqrt{3}$	1	1	1.7	1.7	∞
Algorithms for Max. SAR Evaluation	1.0	Rectangular	$\sqrt{3}$	1	1	0.6	0.6	∞
Dipole								
Dipole Axis to Liquid Distance	2.0	Rectangular	$\sqrt{3}$	1	1	1.2	1.2	∞
Input power and SAR drift measurement	4.7	Rectangular	$\sqrt{3}$	1	1	2.7	2.7	∞
Phantom and Tissue Parameters								
Phantom Uncertainty	4.0	Rectangular	$\sqrt{3}$	1	1	2.3	2.3	∞
Liquid Conductivity (target)	5.0	Rectangular	$\sqrt{3}$	0.64	0.43	1.8	1.2	∞
Liquid Conductivity (measurement)	2.5	Normal	1	0.64	0.43	1.6	1.1	∞
Liquid Permittivity (target)	5.0	Rectangular	$\sqrt{3}$	0.6	0.49	1.7	1.4	∞
Liquid Permittivity (measurement)	2.5	Normal	1	0.6	0.49	1.5	1.2	∞
Combined Standard Uncertainty						8.4	8.1	∞
Coverage Factor for 95%						k _p =2		
Expanded Uncertainty (K=2)						16.8	16.2	

NOTE: About the system validation uncertainty assessment, please reference the section 7.

7. MEASUREMENT SAR PROCEDURE UNCERTAINTIES

The assessment of spatial peak SAR of the hand handheld devices is according to IEEE 1528. All testing situation shall be met below these requirements.

- The system is used by an experienced engineer who follows the manual and the guidelines taught during the training provided by SPEAG.
- The probe has been calibrated within the requested period and the stated uncertainty for the relevant frequency bands does not exceed 4.8% (k=1).
- The validation dipole has been calibrated within the requested period and the system performance check has been successful.
- The DAE unit has been calibrated within the within the requested period.
- The minimum distance between the probe sensor and inner phantom shell is selected to be between 4 and 5mm.
- The operational mode of the DUT is CW, CDMA, FDMA or TDMA (GSM, DCS, PCS, IS136 and PDC) and the measurement/integration time per point is >500 ms.
- The dielectric parameters of the liquid have been assessed using Agilent 85070D dielectric probe kit or a more accurate method.
- The dielectric parameters are within 5% of the target values.
- The DUT has been positioned as described in section 3.

7.1 PROBE CALIBRATION UNCERTAINTY

SPEAG conducts the probe calibration in compliance with international and national standards (e.g. IEEE 1528, EN 50361, IEC 62209, etc.) under ISO17025. The uncertainties are stated on the calibration certificate. For the most relevant frequency bands, these values do not exceed 4.8% (k=1). If evaluations of other bands are performed for which the uncertainty exceeds these values, the uncertainty tables given in the summary have to be revised accordingly.

7.2 ISOTROPY UNCERTAINTY

The axial isotropy tolerance accounts for probe rotation around its axis while the hemispherical isotropy error includes all probe orientations and field polarizations. These parameters are assessed by SPEAG during initial calibration. In 2001, SPEAG further tightened its quality controls and warrants that the maximal deviation from axial isotropy is ± 0.20 dB, while the maximum deviation of hemispherical isotropy is ± 0.40 dB, corresponding to $\pm 4.7\%$ and $\pm 9.6\%$, respectively. A weighting factor of c_p equal to 0.5 can be applied, since the axis of the probe deviates less than 30 degrees from the normal surface orientation.

7.3 BOUNDARY EFFECT UNCERTAINTY

The effect can be estimated according to the following error approximation formula

$$SAR_{tolerance} [\%] = SAR_{be} [\%] \times \frac{(d_{be} + d_{step})^2}{2d_{step}} \frac{e^{-\frac{d_{be}}{\delta/2}}}{\delta/2}$$

$$d_{be} + d_{step} < 10mm$$

The parameter d_{be} is the distance in mm between the surface and the closest measurement point used in the averaging process; d_{step} is the separation distance in mm between the first and second measurement points; δ is the minimum penetration depth in mm within the head tissue equivalent liquids (i.e., $\delta = 13.95$ mm at 3GHz); SAR_{be} is the deviation between the measured SAR value at the distance d_{be} from the boundary and the wave-guide analytical value $SAR_{ref.DASY4}$. DASY4 applies a boundary effect compensation algorithm according to IEEE 1528, which is possible since the axis of the probe never deviates more than 30 degrees from the normal surface orientation. $SAR_{be}[\%]$ is assessed during the calibration process and SPEAG warrants that the uncertainty at distances larger than 4mm is always less than 1%. In summary, the worst case boundary effect SAR tolerance[%] for scanning distances larger than 4mm is $< \pm 0.8\%$.

7.4 PROBE LINEARITY UNCERTAINTY

Field probe linearity uncertainty includes errors from the assessment and compensation of the diode compression effects for CW and pulsed signals with known duty cycles. This error is assessed using the procedure described in IEEE 1528. For SPEAG field probes, the measured difference between CW and pulsed signals, with pulse frequencies between 10 Hz and 1 kHz and duty cycles between 1 and 100, is $< \pm 0.20$ dB ($< \pm 4.7\%$).

7.5 READOUT ELECTRONICS UNCERTAINTY

All uncertainties related to the probe readout electronics (DAE unit), including the gain and linearity of the instrumentation amplifier, its loading effect on the probe, and accuracy of the signal conversion algorithm, have been assessed accordingly to IEEE 1528. The combination (root-sum-square RSS method) of these components results in an overall maximum error of $\pm 1.0\%$.

7.6 RESPONSE TIME UNCERTAINTY

The time response of the field probes is assessed by exposing the probe to a well-controlled electric field producing SAR larger than 2.0 W/kg at the tissue medium surface. The signal response time is evaluated as the time required by the system to reach 90% of the expected final value after an on/of switch of the power source. Analytically, it can be expressed as:

$$SAR_{tolerance} [\%] = 100 \times \left(\frac{T_m}{T_m + \tau e^{-T_m/\tau} - \tau} - 1 \right)$$

where T_m is 500 ms, i.e., the time between measurement samples, and τ the time constant. The response time τ of SPEAG's probes is < 5 ms. In the current implementation, DASY4 waits longer than 100 ms after having reached the grid point before starting a measurement, i.e., the response time uncertainty is negligible.

7.7 INTEGRATION TIME UNCERTAINTY

If the device under test does not emit a CW signal, the integration time applied to measure the electric field at a specific point may introduce additional uncertainties due to the discretization and can be assessed as follows

$$SAR_{tolerance} [\%] = 100 \times \sum_{all\ sub-frames} \frac{t_{frame}}{t_{integration}} \frac{slot_{idle}}{slot_{total}}$$

The tolerances for the different systems are given in Table 7.1, whereby the worst-case $SAR_{tolerance}$ is 2.6%.

System	$SAR_{tolerance} \%$
CW	0
CDMA*	0
WCDMA*	0
FDMA	0
IS-136	2.6
PDC	2.6
GSM/DCS/PCS	1.7
DECT	1.9
Worst-Case	2.6

TABLE 7.1

7.8 PROBE POSITIONER MECHANICAL TOLERANCE

The mechanical tolerance of the field probe positioner can introduce probe positioning uncertainties. The resulting SAR uncertainty is assessed by comparing the SAR obtained according to the specifications of the probe positioner with respect to the actual position defined by the geometric center of the probe sensors. The tolerance is determined as:

$$SAR_{tolerance} [\%] = 100 \times \frac{d_{ph}}{\delta/2}$$

The specified repeatability of the RX robot family used in DASY4 systems is $\pm 25 \mu\text{m}$. The absolute accuracy for short distance movements is better than $\pm 0.1\text{mm}$, i.e., the $SAR_{tolerance} [\%]$ is better than 1.5% (rectangular).

7.9 PROBE POSITIONING

The probe positioning procedures affect the tolerance of the separation distance between the probe tip and the phantom surface as:

$$SAR_{tolerance} [\%] = 100 \times \frac{d_{ph}}{\delta/2}$$

where d_{ph} is the maximum deviation of the distance between the probe tip and the phantom surface. The optical surface detection has a precision of better than 0.2 mm, resulting in an $SAR_{tolerance} [\%]$ of <2.9% (rectangular distribution). Since the mechanical detection provides better accuracy, 2.9% is a worst-case figure for DASY4 system.

7.10 PHANTOM UNCERTAINTY

The SAR measurement uncertainty due to SPEAG phantom shell production tolerances has been evaluated using

$$SAR_{tolerance} [\%] \cong 100 \times \frac{2d}{a}, \quad d \ll a$$

For a maximum deviation d of the inner and outer shell of the phantom from that specified in the CAD file of ± 0.2 mm, and a 10mm spacing a between source and tissue liquid, the calculated phantom uncertainty is $\pm 4.0\%$.

7.11 DASY4 UNCERTAINTY BUDGET

Error Description	Tolerance (±%)	Probability Distribution	Divisor	(C _i)		Standard Uncertainty (±%)		(v _i)
				(1g)	(10g)	(1g)	(10g)	
Measurement Equipment								
Probe Calibration	4.8	Normal	1	1	1	4.8	4.8	∞
Axial Isotropy	4.7	Rectangular	√3	1	1	1.9	1.9	∞
Hemispherical Isotropy	9.6	Rectangular	√3	1	1	3.9	3.9	∞
Boundary effect	1.0	Rectangular	√3	1	1	0.6	0.6	∞
Linearity	4.7	Rectangular	√3	1	1	2.7	2.7	∞
System Detection Limit	1.0	Rectangular	√3	1	1	0.6	0.6	∞
Readout Electronics	1.0	Normal	1	1	1	1.0	1.0	∞
Response Time	0.8	Normal	1	1	1	0.8	0.8	∞
Integration Time	2.6	Normal	1	1	1	2.6	2.6	∞
Noise	0.0	Normal	1	0	0	0	0	∞
Mechanical Constraints								
Scanning System	0.4	Rectangular	√3	1	1	0.2	0.2	∞
Phantom Shell	4.0	Rectangular	√3	1	1	2.3	2.3	∞
Probe Positioning	2.9	Rectangular	√3	1	1	1.7	1.7	∞
Device Positioning	2.9	Normal	1	1	1	2.9	2.9	875
Physical Parameters								
Liquid Conductivity (target)	5.0	Rectangular	√3	0.7	0.5	2	1.4	∞
Liquid Conductivity (measurement)	4.3	Rectangular	√3	0.7	0.5	1.7	1.2	∞
Liquid Permittivity (target)	5.0	Rectangular	√3	0.6	0.5	1.7	1.4	∞
Liquid Permittivity (measurement)	4.3	Rectangular	√3	0.6	0.5	1.5	1.2	∞
Power Drift	5	Rectangular	√3	1	1	2.9	2.9	∞
RF Ambient Conditions	3.0	Rectangular	√3	1	1	1.7	1.7	∞
Post-Processing								
Extrapolation and Integration	1	Rectangular	√3	1	1	0.6	0.6	∞
Combined Standard Uncertainty						9.9	9.7	
Coverage Factor for 95%						kp=2		
Expanded Uncertainty (K=2)						19.9	19.3	

TABLE 7.2

The table 7.2: Worst-Case uncertainty budget for DASY4 assessed according to IEEE 1528. The budget is valid for the frequency range 300MHz ~ 3GHz and represents a worst-case analysis. For specific tests and configurations, the uncertainty could be considerable smaller.



8. INFORMATION ON THE TESTING LABORATORIES

We, ADT Corp., were founded in 1988 to provide our best service in EMC, Radio, Telecom and Safety consultation. Our laboratories are accredited and approved by the following approval agencies according to ISO/IEC 17025.

USA	FCC, UL, A2LA
GERMANY	TUV Rheinland
JAPAN	VCCI
NORWAY	NEMKO
CANADA	INDUSTRY CANADA , CSA
R.O.C.	TAF, BSMI, NCC
NETHERLANDS	Telefication
SINGAPORE	GOST-ASIA (MOU)
RUSSIA	CERTIS (MOU)

Copies of accreditation certificates of our laboratories obtained from approval agencies can be downloaded from our web site:

www.adt.com.tw/index.5/phtml. If you have any comments, please feel free to contact us at the following:

Linko EMC/RF Lab:

Tel: 886-2-26052180

Fax: 886-2-26051924

Hsin Chu EMC/RF Lab:

Tel: 886-3-5935343

Fax: 886-3-5935342

Hwa Ya EMC/RF/Safety/Telecom Lab:

Tel: 886-3-3183232

Fax: 886-3-3185050

Web Site: www.adt.com.tw

The address and road map of all our labs can be found in our web site also.

APPENDIX A: TEST DATA

Liquid Level Photo

HSL 835MHz D=155mm



MSL 835MHz D=153mm

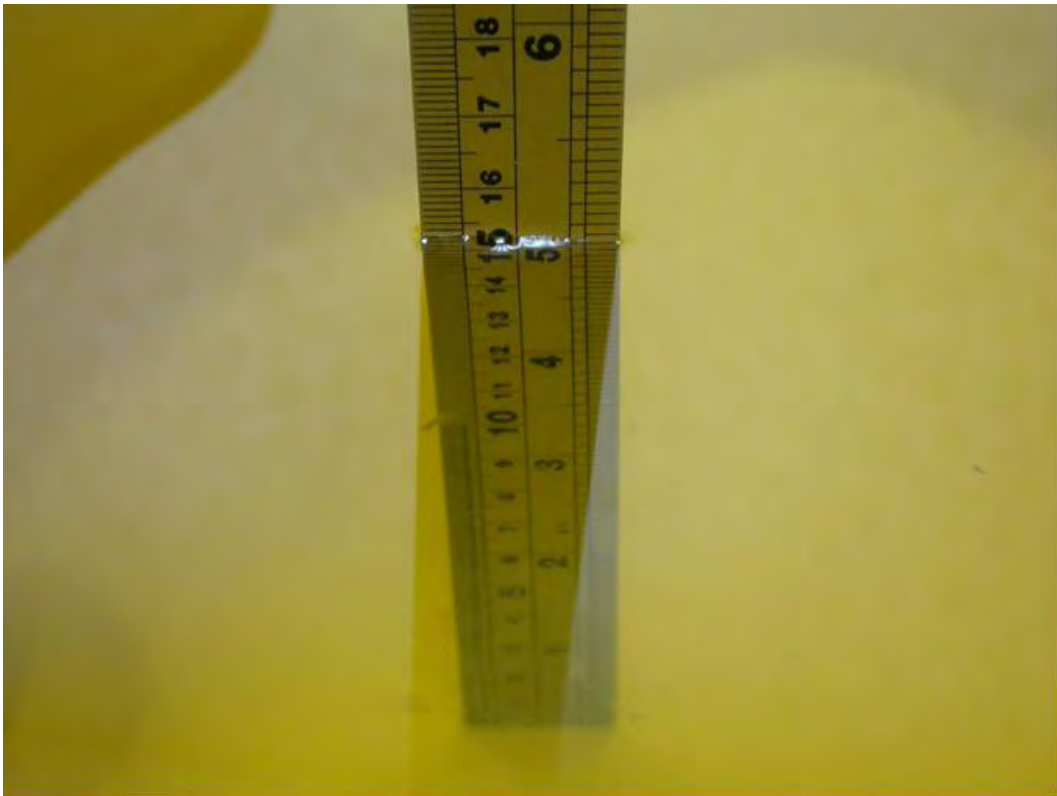

Test Laboratory: Advance Data Technology

M01-Right Head-Cheek-CDMA850-Ch1013

DUT: Pocket PC Phone ; Type: RAPH800 ; Test Frequency: 824.7 MHz

Communication System: CDMA ; Frequency: 824.7 MHz ; Duty Cycle: 1:1

Medium: HSL835 Medium parameters used: $f = 824.7$ MHz; $\sigma = 0.92$ mho/m; $\epsilon_r = 42$; $\rho = 1000$

kg/m³ ; Liquid level: 155 mm

Phantom section: Right Section ; DUT test position : Cheek ; Modulation type: OQPSK

Antenna type : monopole Antenna ; Air temp. : 23.6 degrees ; Liquid temp. : 22.8 degrees

DASY4 Configuration:

- Probe: ET3DV6 - SN1790 ; ConvF(6.65, 6.65, 6.65) ; Calibrated: 2007/11/20

- Sensor-Surface: 4mm (Mechanical Surface Detection)

- Electronics: DAE3 Sn510; Calibrated: 2007/8/29

- Phantom: SAM 12; Type: SAM V4.0; Serial: TP 1202

- Measurement SW: DASY4, V4.7 Build 53; Postprocessing SW: SEMCAD, V1.8 Build 172

Touch position - Low Channel 1013/Area Scan (6x10x1): Measurement grid: dx=15mm, dy=15mm

Maximum value of SAR (measured) = 0.389 mW/g

Touch position - Low Channel 1013/Zoom Scan (7x7x7) (7x7x7)/Cube 0: Measurement grid: dx=5mm, dy=5mm, dz=5mm

Reference Value = 16.4 V/m

Peak SAR (extrapolated) = 0.468 W/kg

SAR(1 g) = 0.360 mW/g; SAR(10 g) = 0.261 mW/g

Maximum value of SAR (measured) = 0.384 mW/g

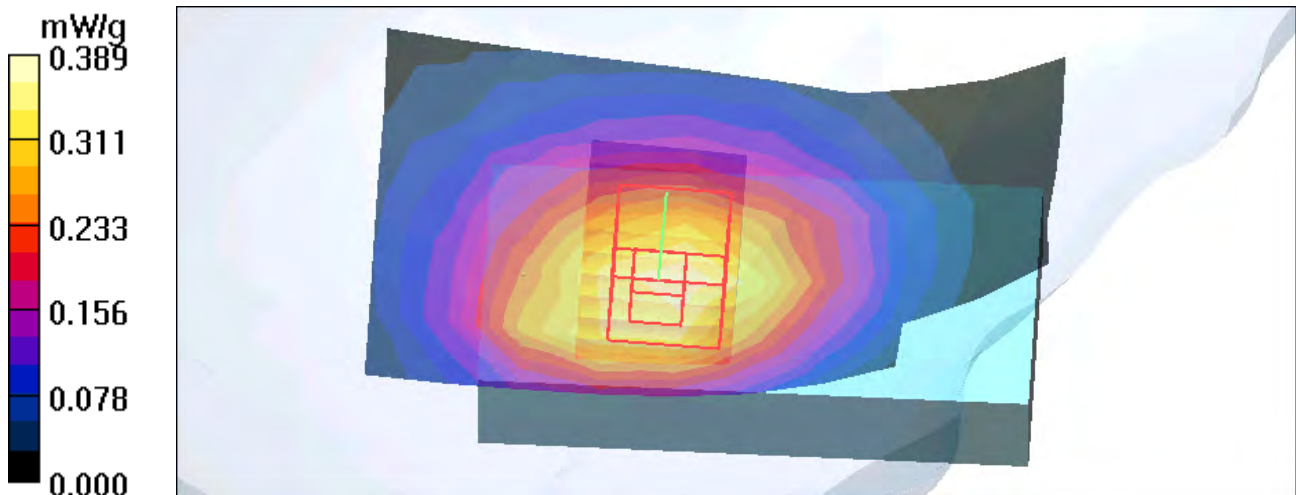

Test Laboratory: Advance Data Technology

M01-Right Head-Cheek-CDMA850-Ch384

DUT: Pocket PC Phone ; Type: RAPH800 ; Test Frequency: 836.5 MHz

Communication System: CDMA ; Frequency: 836.5 MHz ; Duty Cycle: 1:1

Medium: HSL835 Medium parameters used: $f = 836.5$ MHz; $\sigma = 0.94$ mho/m; $\epsilon_r = 41.9$; $\rho = 1000$

kg/m³ ; Liquid level: 155 mm

Phantom section: Right Section ; DUT test position : Cheek ; Modulation type: OQPSK

Antenna type : monopole Antenna ; Air temp. : 23.6 degrees ; Liquid temp. : 22.8 degrees

DASY4 Configuration:

- Probe: ET3DV6 - SN1790 ; ConvF(6.65, 6.65, 6.65) ; Calibrated: 2007/11/20

- Sensor-Surface: 4mm (Mechanical Surface Detection)

- Electronics: DAE3 Sn510; Calibrated: 2007/8/29

- Phantom: SAM 12; Type: SAM V4.0; Serial: TP 1202

- Measurement SW: DASY4, V4.7 Build 53; Postprocessing SW: SEMCAD, V1.8 Build 172

Touch position - Mid Channel 384/Area Scan (6x10x1): Measurement grid: dx=15mm, dy=15mm

Maximum value of SAR (measured) = 0.414 mW/g

Touch position - Mid Channel 384/Zoom Scan (7x7x7) (7x7x7)/Cube 0: Measurement grid: dx=5mm, dy=5mm, dz=5mm

Reference Value = 17.0 V/m

Peak SAR (extrapolated) = 0.537 W/kg

SAR(1 g) = 0.413 mW/g; SAR(10 g) = 0.294 mW/g

Maximum value of SAR (measured) = 0.443 mW/g

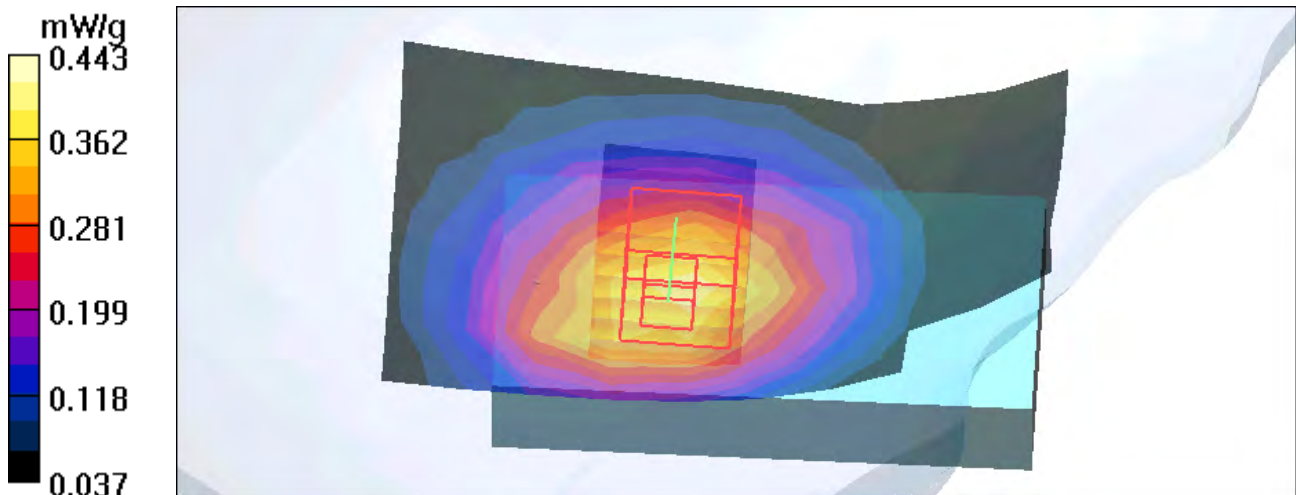

Test Laboratory: Advance Data Technology

M01-Right Head-Cheek-CDMA850-Ch777

DUT: Pocket PC Phone ; Type: RAPH800 ; Test Frequency: 848.3 MHz

Communication System: CDMA ; Frequency: 848.3 MHz ; Duty Cycle: 1:1

Medium: HSL835 Medium parameters used: $f = 848.8 \text{ MHz}$; $\sigma = 0.95 \text{ mho/m}$; $\epsilon_r = 41.7$; $\rho = 1000$

kg/m^3 ; Liquid level: 155 mm

Phantom section: Right Section ; DUT test position : Cheek ; Modulation type: OQPSK

Antenna type : monopole Antenna ; Air temp. : 23.6 degrees ; Liquid temp. : 22.8 degrees

DASY4 Configuration:

- Probe: ET3DV6 - SN1790 ; ConvF(6.65, 6.65, 6.65) ; Calibrated: 2007/11/20

- Sensor-Surface: 4mm (Mechanical Surface Detection)

- Electronics: DAE3 Sn510; Calibrated: 2007/8/29

- Phantom: SAM 12; Type: SAM V4.0; Serial: TP 1202

- Measurement SW: DASY4, V4.7 Build 53; Postprocessing SW: SEMCAD, V1.8 Build 172

Touch position - High Channel 777/Area Scan (6x10x1): Measurement grid: $dx=15\text{mm}$, $dy=15\text{mm}$

Maximum value of SAR (measured) = 0.455 mW/g

Touch position - High Channel 777/Zoom Scan (7x7x7) (7x7x7)/Cube 0: Measurement grid: $dx=5\text{mm}$, $dy=5\text{mm}$, $dz=5\text{mm}$

Reference Value = 17.4 V/m

Peak SAR (extrapolated) = 0.579 W/kg

SAR(1 g) = 0.444 mW/g; SAR(10 g) = 0.317 mW/g

Maximum value of SAR (measured) = 0.472 mW/g

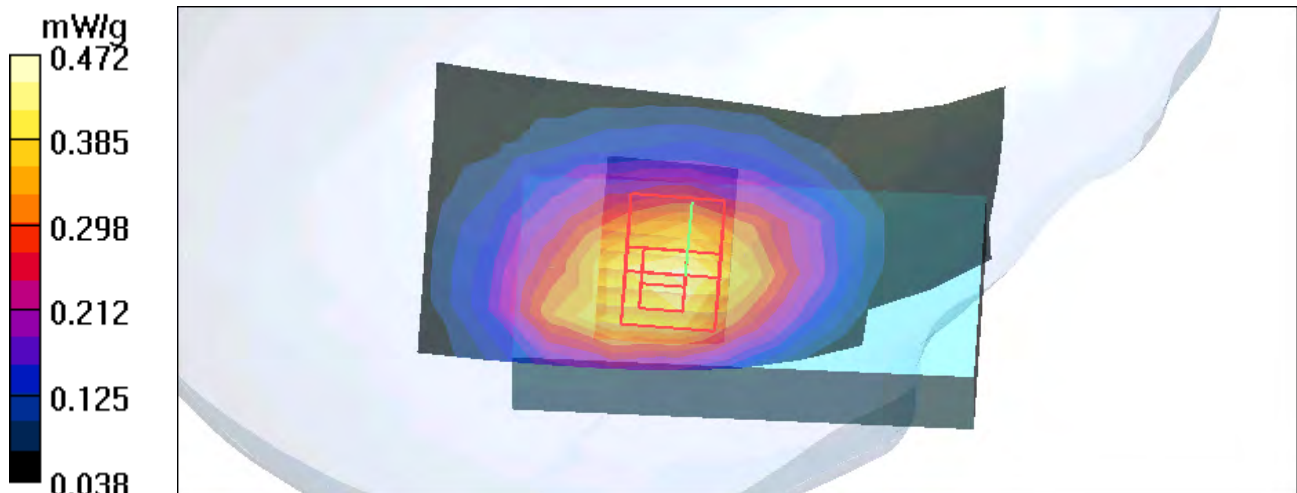

Test Laboratory: Advance Data Technology

M02-Right Head-Tilt-CDMA850-Ch1013

DUT: Pocket PC Phone ; Type: RAPH800 ; Test Frequency: 824.7 MHz

Communication System: CDMA ; Frequency: 824.7 MHz; Duty Cycle: 1:1
Medium: HSL835 Medium parameters used: $f = 824.7$ MHz; $\sigma = 0.92$ mho/m; $\epsilon_r = 42$; $\rho = 1000$

kg/m³ ; Liquid level: 155 mm

Phantom section: Right Section ; DUT test position : Tilt ; Modulation type: OQPSK

Antenna type : monopole Antenna ; Air temp. : 23.6 degrees ; Liquid temp. : 22.8 degrees

DASY4 Configuration:

- Probe: ET3DV6 - SN1790 ; ConvF(6.65, 6.65, 6.65) ; Calibrated: 2007/11/20
- Sensor-Surface: 4mm (Mechanical Surface Detection)
- Electronics: DAE3 Sn510; Calibrated: 2007/8/29
- Phantom: SAM 12; Type: SAM V4.0; Serial: TP 1202
- Measurement SW: DASY4, V4.7 Build 53; Postprocessing SW: SEMCAD, V1.8 Build 172

Tilt position - Low Channel 1013/Area Scan (6x10x1): Measurement grid: dx=15mm, dy=15mm

Maximum value of SAR (measured) = 0.209 mW/g

Tilt position - Low Channel 1013/Zoom Scan (7x7x7) (7x7x7)/Cube 0: Measurement grid: dx=5mm, dy=5mm, dz=5mm

Reference Value = 14.0 V/m

Peak SAR (extrapolated) = 0.290 W/kg

SAR(1 g) = 0.199 mW/g; SAR(10 g) = 0.142 mW/g

Maximum value of SAR (measured) = 0.211 mW/g

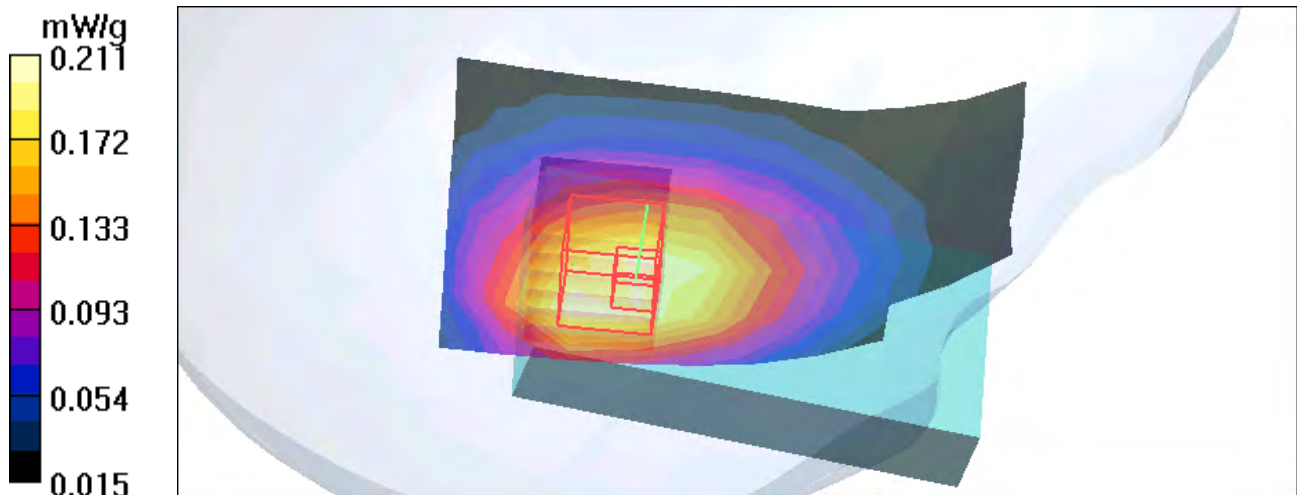

Test Laboratory: Advance Data Technology

M02-Right Head-Tilt-CDMA850-Ch384

DUT: Pocket PC Phone ; Type: RAPH800 ; Test Frequency: 836.5 MHz

Communication System: CDMA ; Frequency: 836.5 MHz; Duty Cycle: 1:1
Medium: HSL835 Medium parameters used: $f = 836.5$ MHz; $\sigma = 0.94$ mho/m; $\epsilon_r = 41.9$; $\rho = 1000$

kg/m³ ; Liquid level: 155 mm

Phantom section: Right Section ; DUT test position : Tilt ; Modulation type: OQPSK

Antenna type : monopole Antenna ; Air temp. : 23.6 degrees ; Liquid temp. : 22.8 degrees

DASY4 Configuration:

- Probe: ET3DV6 - SN1790 ; ConvF(6.65, 6.65, 6.65) ; Calibrated: 2007/11/20
- Sensor-Surface: 4mm (Mechanical Surface Detection)
- Electronics: DAE3 Sn510; Calibrated: 2007/8/29
- Phantom: SAM 12; Type: SAM V4.0; Serial: TP 1202
- Measurement SW: DASY4, V4.7 Build 53; Postprocessing SW: SEMCAD, V1.8 Build 172

Tilt position - Mid Channel 384/Area Scan (6x10x1): Measurement grid: dx=15mm, dy=15mm

Maximum value of SAR (measured) = 0.252 mW/g

Tilt position - Mid Channel 384/Zoom Scan (7x7x7) (7x7x7)/Cube 0: Measurement grid: dx=5mm, dy=5mm, dz=5mm

Reference Value = 14.9 V/m

Peak SAR (extrapolated) = 0.416 W/kg

SAR(1 g) = 0.257 mW/g; SAR(10 g) = 0.172 mW/g

Maximum value of SAR (measured) = 0.281 mW/g

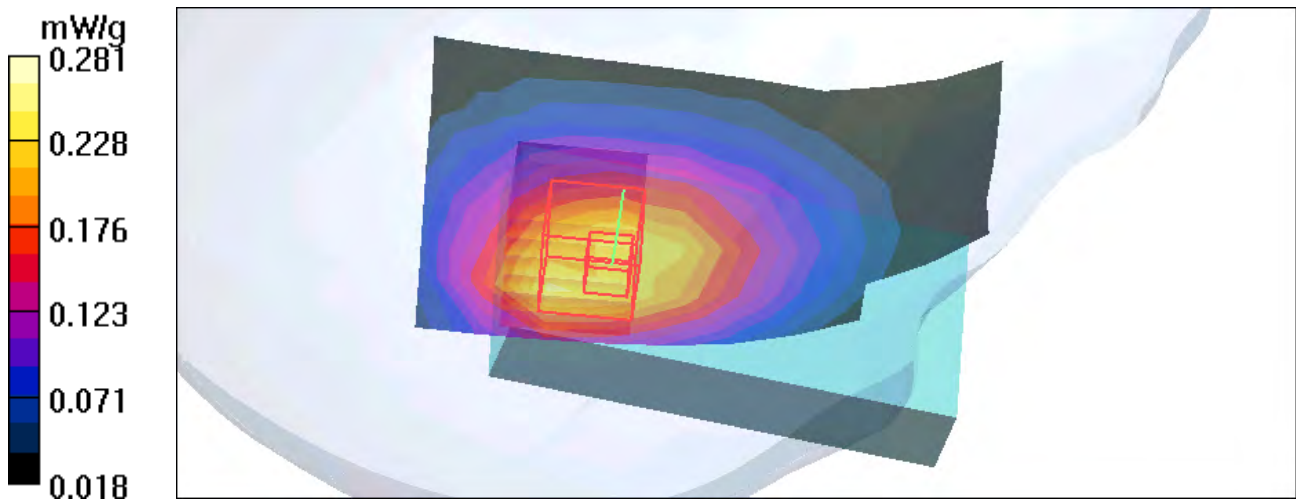

Test Laboratory: Advance Data Technology

M02-Right Head-Tilt-CDMA850-Ch777

DUT: Pocket PC Phone ; Type: RAPH800 ; Test Frequency: 848.3 MHz

Communication System: CDMA ; Frequency: 848.3 MHz; Duty Cycle: 1:1
Medium: HSL835 Medium parameters used: $f = 848.8$ MHz; $\sigma = 0.95$ mho/m; $\epsilon_r = 41.7$; $\rho = 1000$

kg/m³ ; Liquid level: 155 mm

Phantom section: Right Section ; DUT test position : Tilt ; Modulation type: OQPSK

Antenna type : monopole Antenna ; Air temp. : 23.6 degrees ; Liquid temp. : 22.8 degrees

DASY4 Configuration:

- Probe: ET3DV6 - SN1790 ; ConvF(6.65, 6.65, 6.65) ; Calibrated: 2007/11/20
- Sensor-Surface: 4mm (Mechanical Surface Detection)
- Electronics: DAE3 Sn510; Calibrated: 2007/8/29
- Phantom: SAM 12; Type: SAM V4.0; Serial: TP 1202
- Measurement SW: DASY4, V4.7 Build 53; Postprocessing SW: SEMCAD, V1.8 Build 172

Tilt position - High Channel 777/Area Scan (6x10x1): Measurement grid: dx=15mm, dy=15mm

Maximum value of SAR (measured) = 0.282 mW/g

Tilt position - High Channel 777/Zoom Scan (7x7x7) (7x7x7)/Cube 0: Measurement grid: dx=5mm, dy=5mm, dz=5mm

Reference Value = 15.8 V/m

Peak SAR (extrapolated) = 0.416 W/kg

SAR(1 g) = 0.271 mW/g; SAR(10 g) = 0.191 mW/g

Maximum value of SAR (measured) = 0.289 mW/g

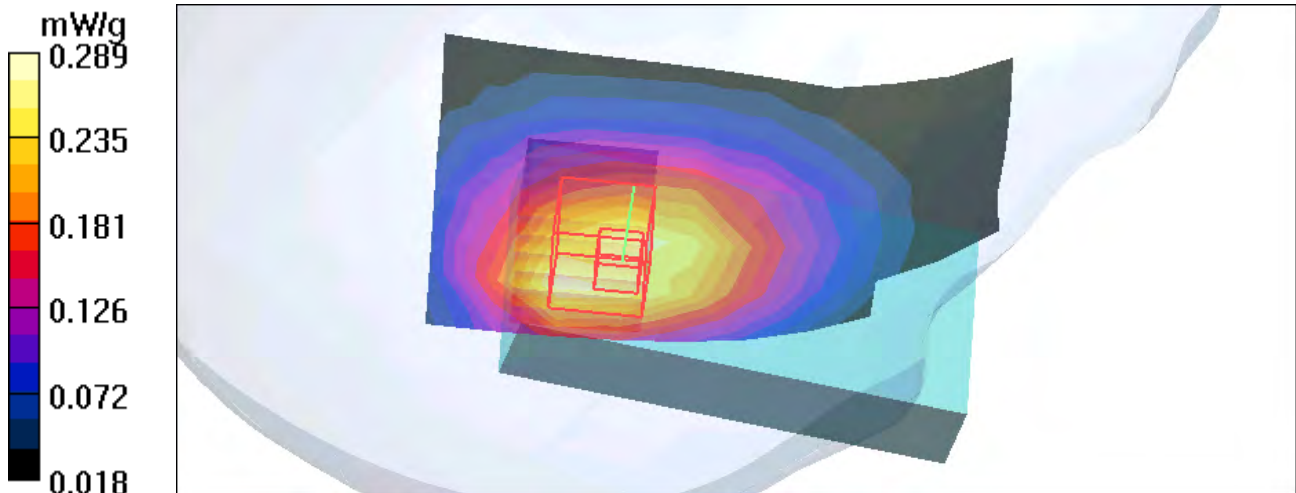

Test Laboratory: Advance Data Technology

M03-Left Head-Cheek-CDMA850-Ch1013

DUT: Pocket PC Phone ; Type: RAPH800 ; Test Frequency: 824.7 MHz

Communication System: CDMA ; Frequency: 824.7 MHz ; Duty Cycle: 1:1

Medium: HSL835 Medium parameters used: $f = 824.7$ MHz; $\sigma = 0.92$ mho/m; $\epsilon_r = 42$; $\rho = 1000$

kg/m³ ; Liquid level: 155 mm

Phantom section: Left Section ; DUT test position : Cheek ; Modulation type: OQPSK

Antenna type : monopole Antenna ; Air temp. : 23.6 degrees ; Liquid temp. : 22.8 degrees

DASY4 Configuration:

- Probe: ET3DV6 - SN1790 ; ConvF(6.65, 6.65, 6.65) ; Calibrated: 2007/11/20

- Sensor-Surface: 4mm (Mechanical Surface Detection)

- Electronics: DAE3 Sn510; Calibrated: 2007/8/29

- Phantom: SAM 12; Type: SAM V4.0; Serial: TP 1202

- Measurement SW: DASY4, V4.7 Build 53; Postprocessing SW: SEMCAD, V1.8 Build 172

Touch position - Low Channel 1013/Area Scan (6x10x1): Measurement grid: dx=15mm, dy=15mm

Maximum value of SAR (measured) = 0.519 mW/g

Touch position - Low Channel 1013/Zoom Scan (7x7x7) (7x7x7)/Cube 0: Measurement grid: dx=5mm, dy=5mm, dz=5mm

Reference Value = 18.8 V/m

Peak SAR (extrapolated) = 0.605 W/kg

SAR(1 g) = 0.482 mW/g; SAR(10 g) = 0.350 mW/g

Maximum value of SAR (measured) = 0.511 mW/g

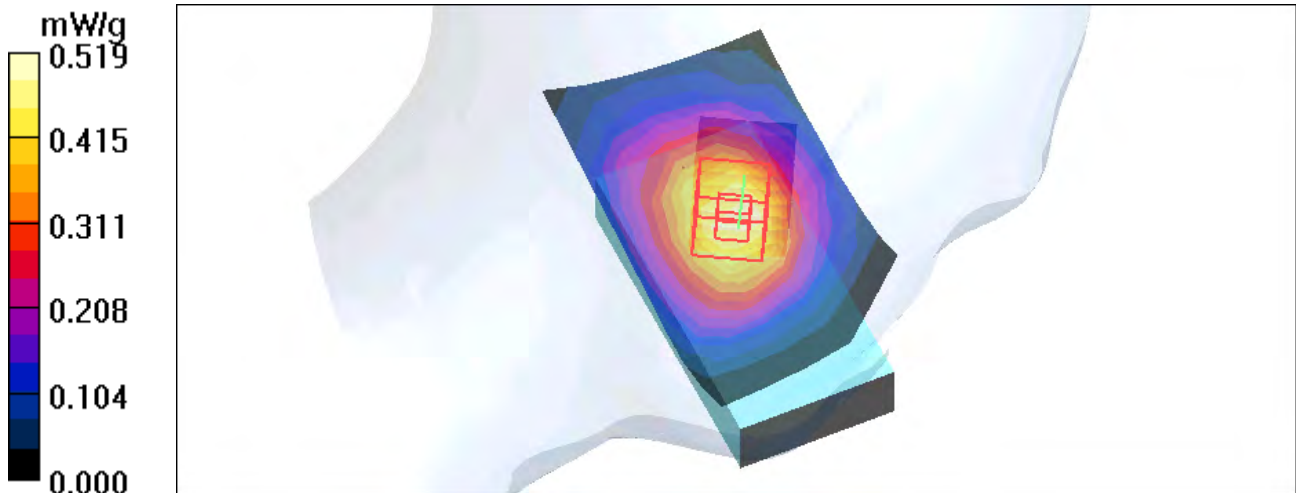

Test Laboratory: Advance Data Technology

M03-Left Head-Cheek-CDMA850-Ch384

DUT: Pocket PC Phone ; Type: RAPH800 ; Test Frequency: 836.5 MHz

Communication System: CDMA ; Frequency: 836.5 MHz ; Duty Cycle: 1:1

Medium: HSL835 Medium parameters used: $f = 836.5$ MHz; $\sigma = 0.94$ mho/m; $\epsilon_r = 41.9$; $\rho = 1000$

kg/m³ ; Liquid level: 155 mm

Phantom section: Left Section ; DUT test position : Cheek ; Modulation type: OQPSK

Antenna type : monopole Antenna ; Air temp. : 23.6 degrees ; Liquid temp. : 22.8 degrees

DASY4 Configuration:

- Probe: ET3DV6 - SN1790 ; ConvF(6.65, 6.65, 6.65) ; Calibrated: 2007/11/20

- Sensor-Surface: 4mm (Mechanical Surface Detection)

- Electronics: DAE3 Sn510; Calibrated: 2007/8/29

- Phantom: SAM 12; Type: SAM V4.0; Serial: TP 1202

- Measurement SW: DASY4, V4.7 Build 53; Postprocessing SW: SEMCAD, V1.8 Build 172

Touch position - Mid Channel 384/Area Scan (6x10x1): Measurement grid: dx=15mm, dy=15mm

Maximum value of SAR (measured) = 0.573 mW/g

Touch position - Mid Channel 384/Zoom Scan (7x7x7) (7x7x7)/Cube 0: Measurement grid: dx=5mm, dy=5mm, dz=5mm

Reference Value = 19.3 V/m

Peak SAR (extrapolated) = 0.693 W/kg

SAR(1 g) = 0.545 mW/g; SAR(10 g) = 0.393 mW/g

Maximum value of SAR (measured) = 0.577 mW/g

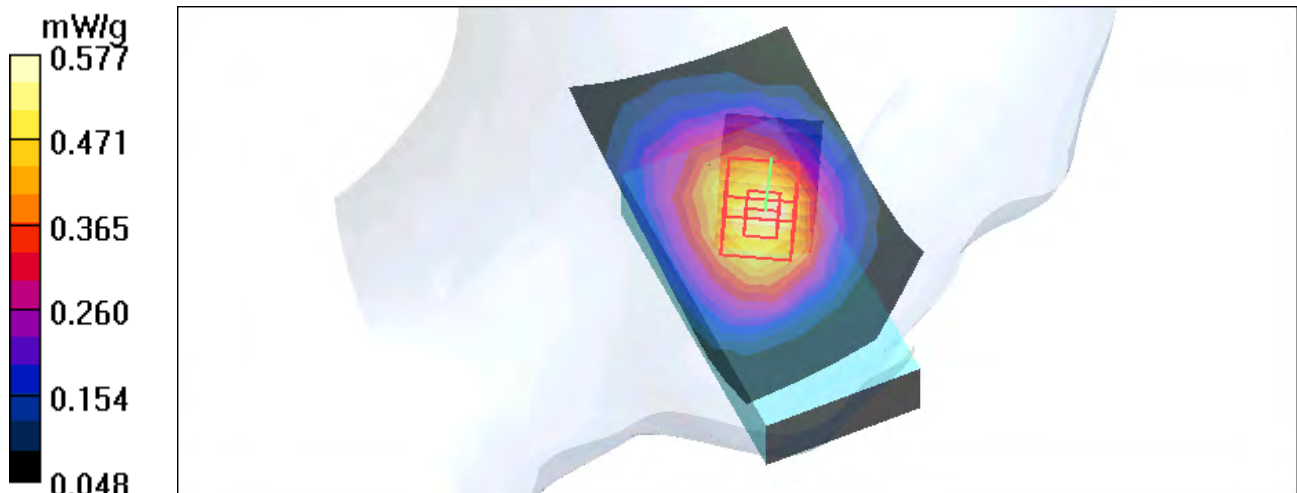

Test Laboratory: Advance Data Technology

M03-Left Head-Cheek-CDMA850-Ch777

DUT: Pocket PC Phone ; Type: RAPH800 ; Test Frequency: 848.3 MHz

Communication System: CDMA ; Frequency: 848.3 MHz ; Duty Cycle: 1:1

Medium: HSL835 Medium parameters used: $f = 848.8 \text{ MHz}$; $\sigma = 0.95 \text{ mho/m}$; $\epsilon_r = 41.7$; $\rho = 1000$

kg/m^3 ; Liquid level: 155 mm

Phantom section: Left Section ; DUT test position : Cheek ; Modulation type: OQPSK

Antenna type : monopole Antenna ; Air temp. : 23.6 degrees ; Liquid temp. : 22.8 degrees

DASY4 Configuration:

- Probe: ET3DV6 - SN1790 ; ConvF(6.65, 6.65, 6.65) ; Calibrated: 2007/11/20

- Sensor-Surface: 4mm (Mechanical Surface Detection)

- Electronics: DAE3 Sn510; Calibrated: 2007/8/29

- Phantom: SAM 12; Type: SAM V4.0; Serial: TP 1202

- Measurement SW: DASY4, V4.7 Build 53; Postprocessing SW: SEMCAD, V1.8 Build 172

Touch position - High Channel 777/Area Scan (6x10x1): Measurement grid: $dx=15\text{mm}$, $dy=15\text{mm}$

Maximum value of SAR (measured) = 0.576 mW/g

Touch position - High Channel 777/Zoom Scan (7x7x7) (7x7x7)/Cube 0: Measurement grid: $dx=5\text{mm}$, $dy=5\text{mm}$, $dz=5\text{mm}$

Reference Value = 19.5 V/m

Peak SAR (extrapolated) = 0.738 W/kg

SAR(1 g) = 0.577 mW/g; SAR(10 g) = 0.414 mW/g

Maximum value of SAR (measured) = 0.614 mW/g

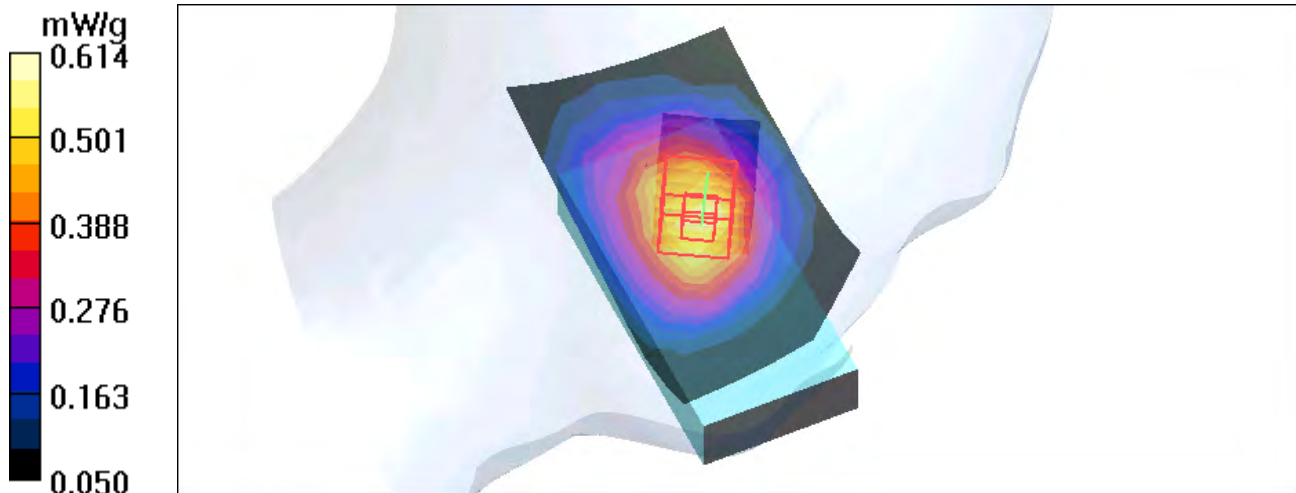

1g/10g Averaged SAR

SAR; Zoom Scan (7x7x7): Value Along Z, X=2, Y=3

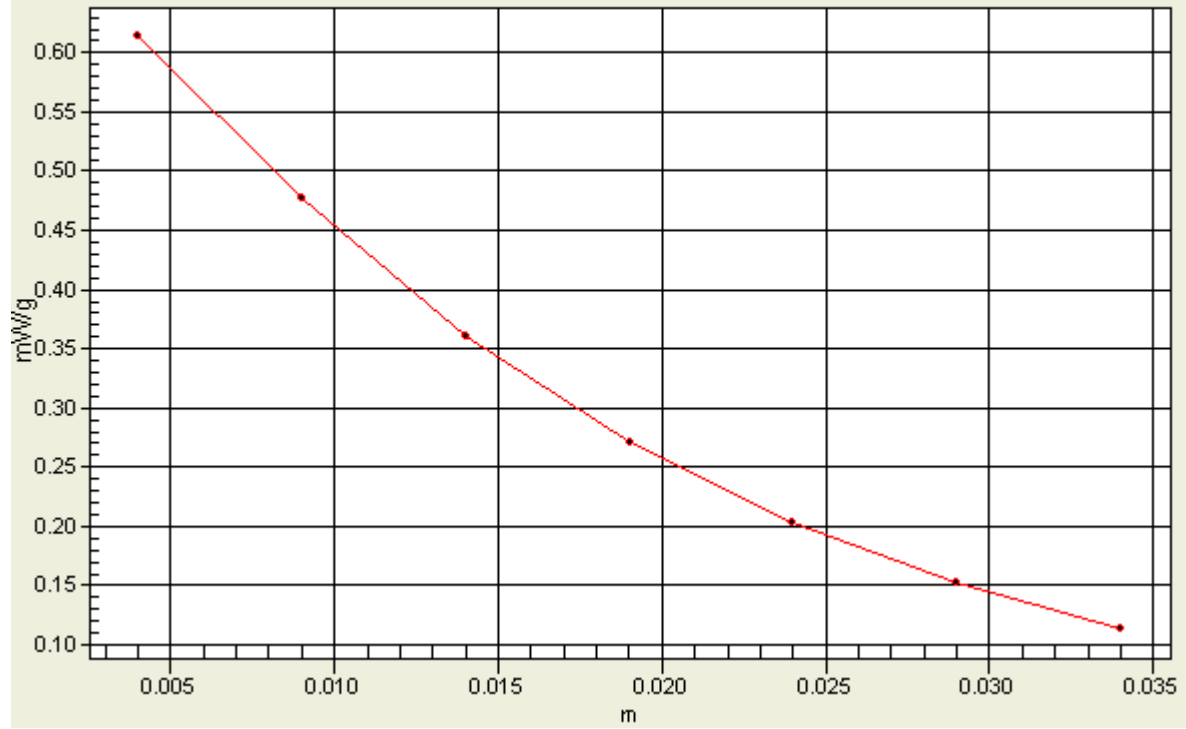

Test Laboratory: Advance Data Technology

M04-Left Head-Tilt-CDMA850-Ch1013

DUT: Pocket PC Phone ; Type: RAPH800 ; Test Frequency: 824.7 MHz

Communication System: CDMA ; Frequency: 824.7 MHz; Duty Cycle: 1:1
Medium: HSL835 Medium parameters used: $f = 824.7$ MHz; $\sigma = 0.92$ mho/m; $\epsilon_r = 42$; $\rho = 1000$

kg/m³ ; Liquid level: 155 mm

Phantom section: Left Section ; DUT test position : Tilt ; Modulation type: OQPSK

Antenna type : monopole Antenna ; Air temp. : 23.6 degrees ; Liquid temp. : 22.8 degrees

DASY4 Configuration:

- Probe: ET3DV6 - SN1790 ; ConvF(6.65, 6.65, 6.65) ; Calibrated: 2007/11/20
- Sensor-Surface: 4mm (Mechanical Surface Detection)
- Electronics: DAE3 Sn510; Calibrated: 2007/8/29
- Phantom: SAM 12; Type: SAM V4.0; Serial: TP 1202
- Measurement SW: DASY4, V4.7 Build 53; Postprocessing SW: SEMCAD, V1.8 Build 172

Tilt position - Low Channel 1013/Area Scan (6x10x1): Measurement grid: dx=15mm, dy=15mm

Maximum value of SAR (measured) = 0.158 mW/g

Tilt position - Low Channel 1013/Zoom Scan (7x7x7) (7x7x7)/Cube 0: Measurement grid: dx=5mm, dy=5mm, dz=5mm

Reference Value = 13.3 V/m

Peak SAR (extrapolated) = 0.201 W/kg

SAR(1 g) = 0.149 mW/g; SAR(10 g) = 0.113 mW/g

Maximum value of SAR (measured) = 0.165 mW/g

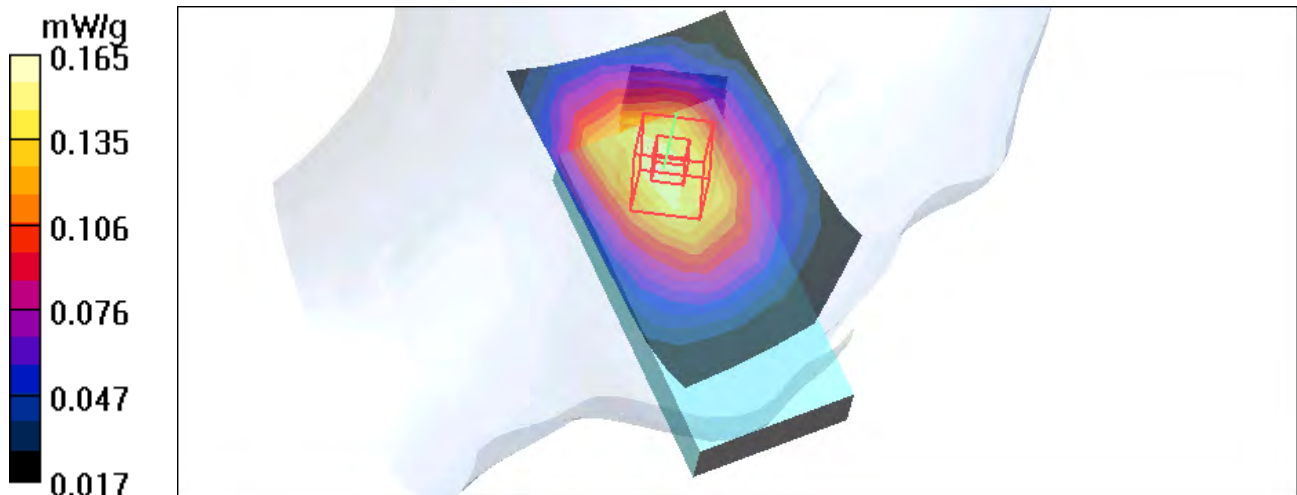

Test Laboratory: Advance Data Technology

M04-Left Head-Tilt-CDMA850-Ch384

DUT: Pocket PC Phone ; Type: RAPH800 ; Test Frequency: 836.5 MHz

Communication System: CDMA ; Frequency: 836.5 MHz; Duty Cycle: 1:1

Medium: HSL835 Medium parameters used: $f = 836.5$ MHz; $\sigma = 0.94$ mho/m; $\epsilon_r = 41.9$; $\rho = 1000$

kg/m³ ; Liquid level: 155 mm

Phantom section: Left Section ; DUT test position : Tilt ; Modulation type: OQPSK

Antenna type : monopole Antenna ; Air temp. : 23.6 degrees ; Liquid temp. : 22.8 degrees

DASY4 Configuration:

- Probe: ET3DV6 - SN1790 ; ConvF(6.65, 6.65, 6.65) ; Calibrated: 2007/11/20

- Sensor-Surface: 4mm (Mechanical Surface Detection)

- Electronics: DAE3 Sn510; Calibrated: 2007/8/29

- Phantom: SAM 12; Type: SAM V4.0; Serial: TP 1202

- Measurement SW: DASY4, V4.7 Build 53; Postprocessing SW: SEMCAD, V1.8 Build 172

Tilt position - Mid Channel 384/Area Scan (6x10x1): Measurement grid: dx=15mm, dy=15mm

Maximum value of SAR (measured) = 0.270 mW/g

Tilt position - Mid Channel 384/Zoom Scan (7x7x7) (7x7x7)/Cube 0: Measurement grid: dx=5mm, dy=5mm, dz=5mm

Reference Value = 17.5 V/m

Peak SAR (extrapolated) = 0.317 W/kg

SAR(1 g) = 0.261 mW/g; SAR(10 g) = 0.196 mW/g

Maximum value of SAR (measured) = 0.276 mW/g

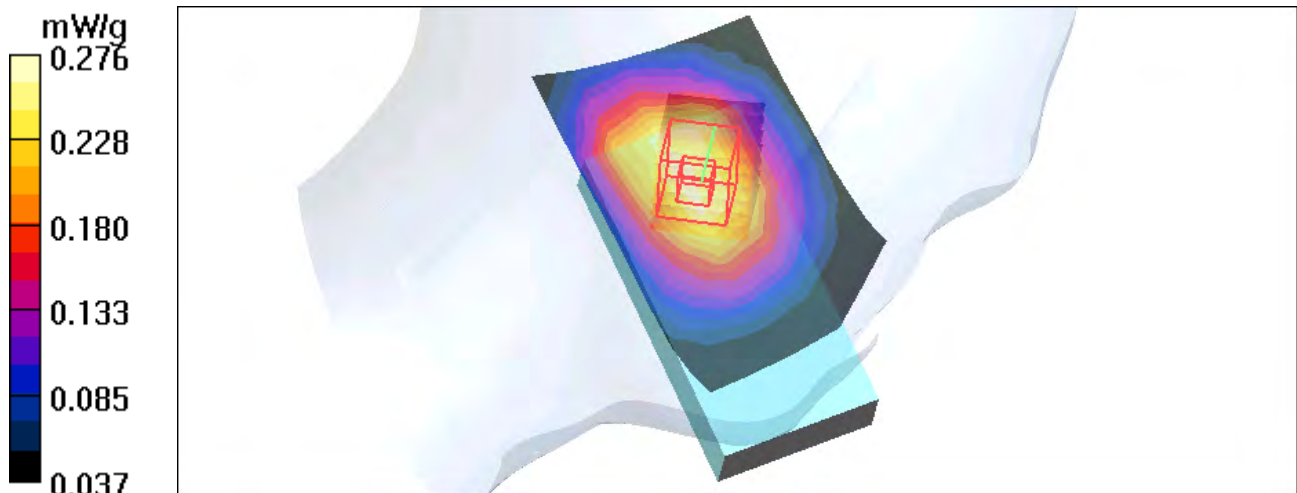

Test Laboratory: Advance Data Technology

M04-Left Head-Tilt-CDMA850-Ch777

DUT: Pocket PC Phone ; Type: RAPH800 ; Test Frequency: 848.3 MHz

Communication System: CDMA ; Frequency: 848.3 MHz; Duty Cycle: 1:1

Medium: HSL835 Medium parameters used: $f = 848.3 \text{ MHz}$; $\sigma = 0.95 \text{ mho/m}$; $\epsilon_r = 41.7$; $\rho = 1000 \text{ kg/m}^3$;
Liquid level: 155 mm

Phantom section: Left Section ; DUT test position : Tilt ; Modulation type: OQPSK

Antenna type : monopole Antenna ; Air temp. : 23.6 degrees ; Liquid temp. : 22.8 degrees

DASY4 Configuration:

- Probe: ET3DV6 - SN1790 ; ConvF(6.65, 6.65, 6.65) ; Calibrated: 2007/11/20

- Sensor-Surface: 4mm (Mechanical Surface Detection)

- Electronics: DAE3 Sn510; Calibrated: 2007/8/29

- Phantom: SAM 12; Type: SAM V4.0; Serial: TP 1202

- Measurement SW: DASY4, V4.7 Build 53; Postprocessing SW: SEMCAD, V1.8 Build 172

Tilt position - High Channel 777/Area Scan (6x10x1): Measurement grid: $dx=15\text{mm}$, $dy=15\text{mm}$

Maximum value of SAR (measured) = 0.284 mW/g

Tilt position - High Channel 777/Zoom Scan (7x7x7) (7x7x7)/Cube 0: Measurement grid:

$dx=5\text{mm}$, $dy=5\text{mm}$, $dz=5\text{mm}$

Reference Value = 17.0 V/m

Peak SAR (extrapolated) = 0.288 W/kg

SAR(1 g) = 0.199 mW/g; SAR(10 g) = 0.127 mW/g

Maximum value of SAR (measured) = 0.240 mW/g

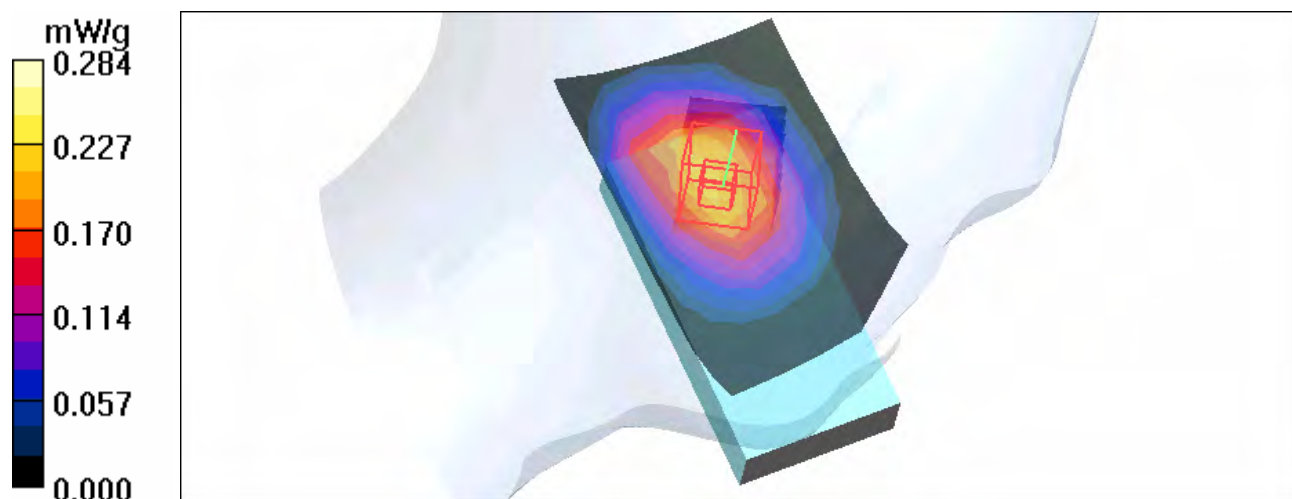

Test Laboratory: Advance Data Technology

M05-Body Worn-CDMA850-Ch1013

DUT: Pocket PC Phone ; Type: RAPH800 ; Test Frequency: 824.7 MHz

Communication System: CDMA ; Frequency: 824.7 MHz ; Duty Cycle: 1:1
Medium: MSL835 Medium parameters used: $f = 824.7$ MHz; $\sigma = 1$ mho/m; $\epsilon_r = 56.8$; $\rho = 1000$

kg/m³ ; Liquid Level : 153 mm

Phantom section: Flat Section ; DUT test position : Body ; Modulation Type: OQPSK

Separation Distance : 0 mm (The bottom side of the EUT to the Phantom)

Antenna Type : monopole Antenna ; Air Temp. : 23.2 degrees ; Liquid Temp. : 22.1 degrees

DASY4 Configuration:

- Probe: ET3DV6 - SN1790 ; ConvF(6.15, 6.15, 6.15) ; Calibrated: 2007/11/20
- Sensor-Surface: 4mm (Mechanical Surface Detection)
- Electronics: DAE3 Sn510 ; Calibrated: 2007/8/29
- Phantom: SAM 12 ; Type: SAM V4.0; Serial: TP 1202
- Measurement SW: DASY4, V4.7 Build 53 ; Postprocessing SW: SEMCAD, V1.8 Build 172

Low Channel 1013/Area Scan (6x9x1): Measurement grid: dx=15mm, dy=15mm

Maximum value of SAR (measured) = 0.658 mW/g

Low Channel 1013/Zoom Scan (7x7x7) (7x7x7)/Cube 0: Measurement grid: dx=5mm, dy=5mm, dz=5mm

Reference Value = 21.9 V/m

Peak SAR (extrapolated) = 1.07 W/kg

SAR(1 g) = 0.513 mW/g; SAR(10 g) = 0.342 mW/g

Maximum value of SAR (measured) = 0.646 mW/g

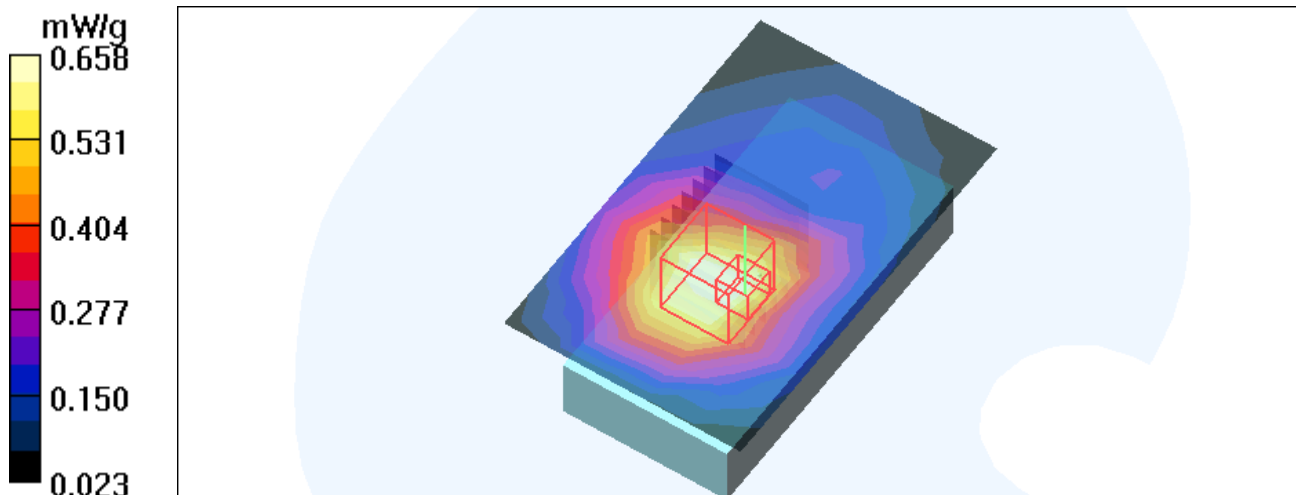

Test Laboratory: Advance Data Technology

M05-Body Worn-CDMA850-Ch384

DUT: Pocket PC Phone ; Type: RAPH800 ; Test Frequency: 836.5 MHz

Communication System: CDMA ; Frequency: 836.5 MHz ; Duty Cycle: 1:1

Medium: MSL835 Medium parameters used: $f = 836.5$ MHz; $\sigma = 1.01$ mho/m; $\epsilon_r = 56.7$; $\rho = 1000$

kg/m³ ; Liquid Level : 153 mm

Phantom section: Flat Section ; DUT test position : Body ; Modulation Type: OQPSK

Separation Distance : 0 mm (The bottom side of the EUT to the Phantom)

Antenna Type : monopole Antenna ; Air Temp. : 23.2 degrees ; Liquid Temp. : 22.1 degrees

DASY4 Configuration:

- Probe: ET3DV6 - SN1790 ; ConvF(6.15, 6.15, 6.15) ; Calibrated: 2007/11/20

- Sensor-Surface: 4mm (Mechanical Surface Detection)

- Electronics: DAE3 Sn510 ; Calibrated: 2007/8/29

- Phantom: SAM 12 ; Type: SAM V4.0; Serial: TP 1202

- Measurement SW: DASY4, V4.7 Build 53 ; Postprocessing SW: SEMCAD, V1.8 Build 172

Mid Channel 384/Area Scan (6x9x1): Measurement grid: dx=15mm, dy=15mm

Maximum value of SAR (measured) = 0.663 mW/g

Mid Channel 384/Zoom Scan (7x7x7) (7x7x7)/Cube 0: Measurement grid: dx=5mm, dy=5mm, dz=5mm

Reference Value = 20.6 V/m

Peak SAR (extrapolated) = 1.01 W/kg

SAR(1 g) = 0.613 mW/g; SAR(10 g) = 0.409 mW/g

Maximum value of SAR (measured) = 0.668 mW/g

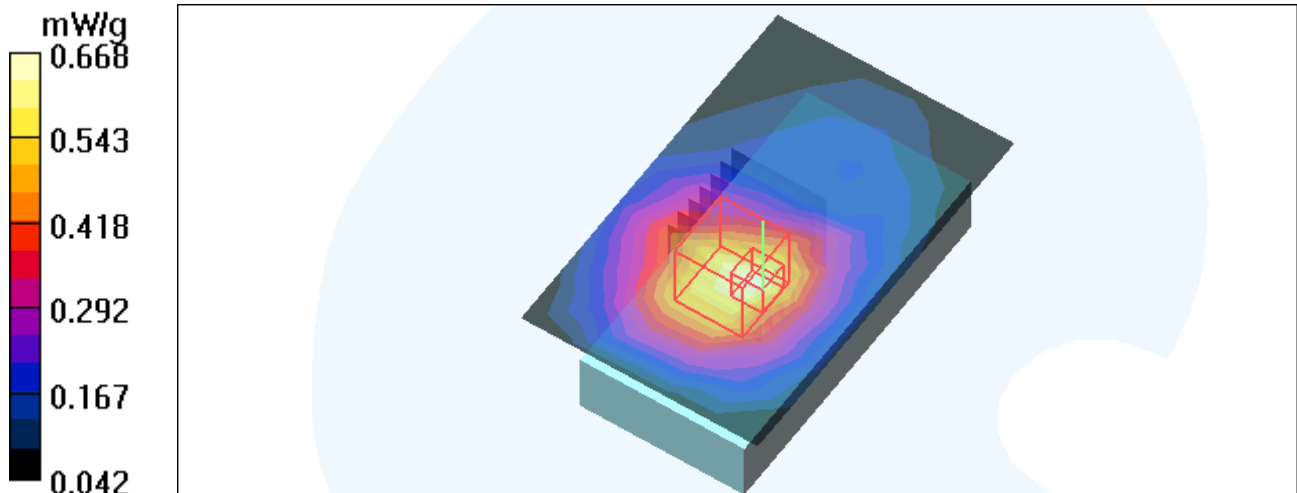

1g/10g Averaged SAR

SAR; Zoom Scan (7x7x7): Value Along Z, X=2, Y=3

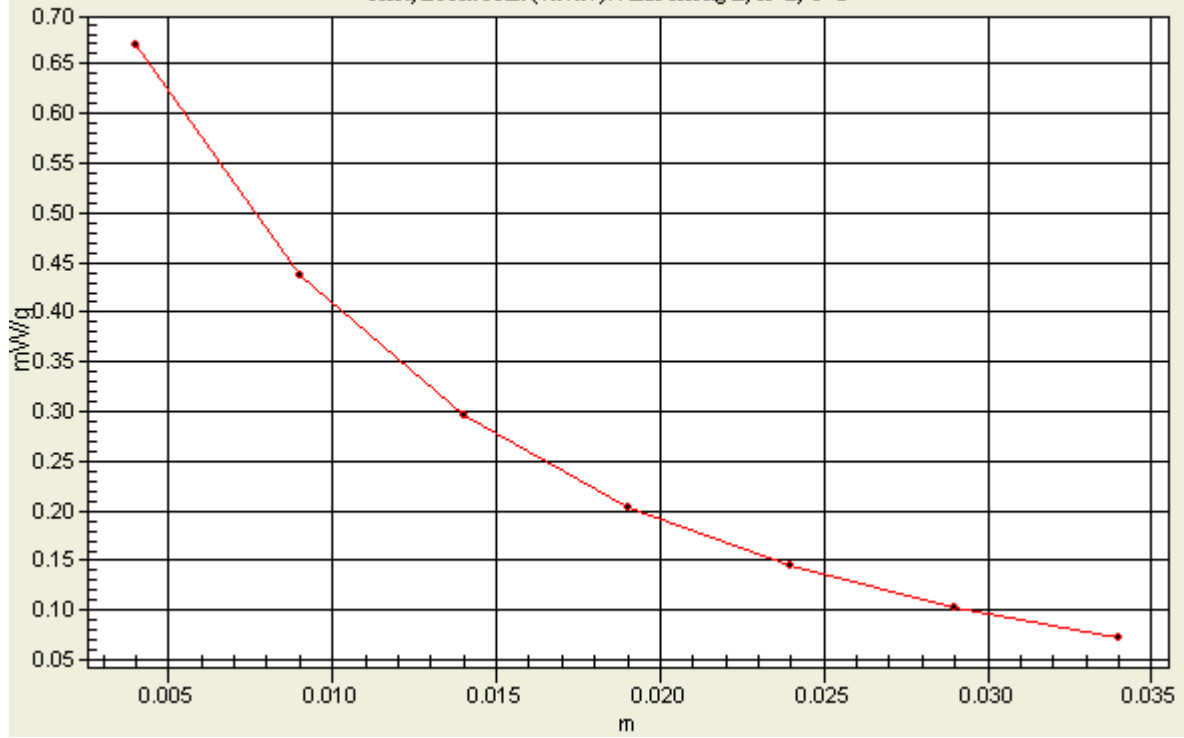

Test Laboratory: Advance Data Technology

M05-Body Worn-CDMA850-Ch777

DUT: Pocket PC Phone ; Type: RAPH800 ; Test Frequency: 848.3 MHz

Communication System: CDMA ; Frequency: 848.3 MHz ; Duty Cycle: 1:1

Medium: MSL835 Medium parameters used: $f = 848.3 \text{ MHz}$; $\sigma = 1.02 \text{ mho/m}$; $\epsilon_r = 56.6$; $\rho = 1000$

kg/m^3 ; Liquid Level : 153 mm

Phantom section: Flat Section ; DUT test position : Body ; Modulation Type: OQPSK

Separation Distance : 0 mm (The bottom side of the EUT to the Phantom)

Antenna Type : monopole Antenna ; Air Temp. : 23.2 degrees ; Liquid Temp. : 22.1 degrees

DASY4 Configuration:

- Probe: ET3DV6 - SN1790 ; ConvF(6.15, 6.15, 6.15) ; Calibrated: 2007/11/20

- Sensor-Surface: 4mm (Mechanical Surface Detection)

- Electronics: DAE3 Sn510 ; Calibrated: 2007/8/29

- Phantom: SAM 12 ; Type: SAM V4.0; Serial: TP 1202

- Measurement SW: DASY4, V4.7 Build 53 ; Postprocessing SW: SEMCAD, V1.8 Build 172

High Channel 777/Area Scan (6x9x1): Measurement grid: $dx=15\text{mm}$, $dy=15\text{mm}$

Maximum value of SAR (measured) = 0.612 mW/g

High Channel 777/Zoom Scan (7x7x7) (7x7x7)/Cube 0: Measurement grid: $dx=5\text{mm}$, $dy=5\text{mm}$, $dz=5\text{mm}$

Reference Value = 19.5 V/m

Peak SAR (extrapolated) = 0.940 W/kg

SAR(1 g) = 0.559 mW/g; SAR(10 g) = 0.372 mW/g

Maximum value of SAR (measured) = 0.608 mW/g

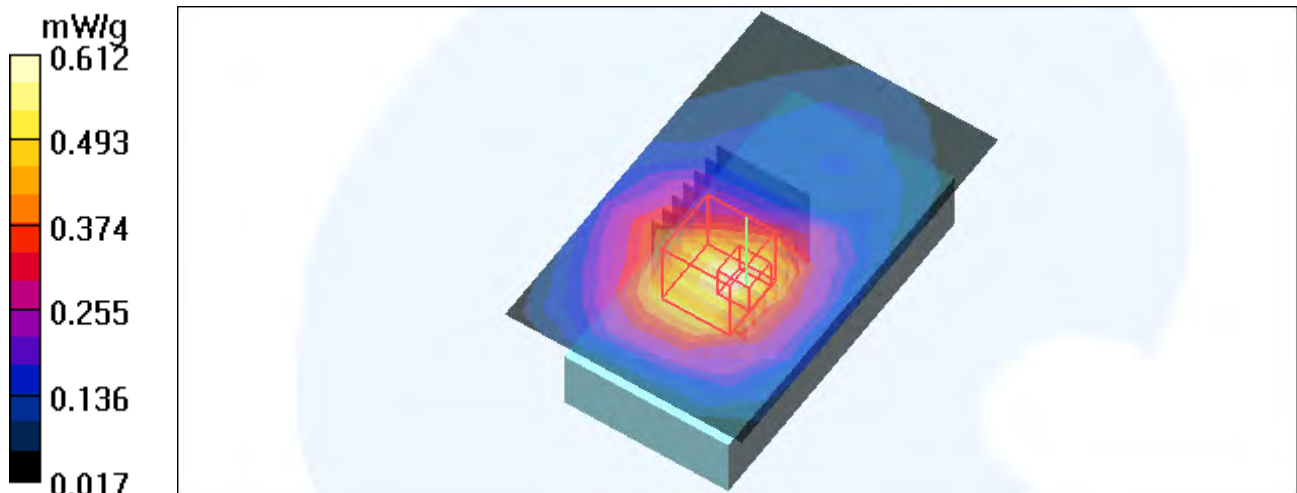

Test Laboratory: Advance Data Technology

M06-Body Worn-EVDO850-Ch384

DUT: Pocket PC Phone ; Type: RAPH800 ; Test Frequency: 836.5 MHz

Communication System: CDMA ; Frequency: 836.5 MHz ; Duty Cycle: 1:1

Medium: MSL835 Medium parameters used: $f = 836.5$ MHz; $\sigma = 1.01$ mho/m; $\epsilon_r = 56.7$; $\rho = 1000$

kg/m³ ; Liquid Level : 153 mm

Phantom section: Flat Section ; DUT test position : Body ; Modulation Type: HPSK

Separation Distance : 0 mm (The bottom side of the EUT to the Phantom)

Antenna Type : monopole Antenna ; Air Temp. : 23.2 degrees ; Liquid Temp. : 22.1 degrees

DASY4 Configuration:

- Probe: ET3DV6 - SN1790 ; ConvF(6.15, 6.15, 6.15) ; Calibrated: 2007/11/20

- Sensor-Surface: 4mm (Mechanical Surface Detection)

- Electronics: DAE3 Sn510 ; Calibrated: 2007/8/29

- Phantom: SAM 12 ; Type: SAM V4.0; Serial: TP 1202

- Measurement SW: DASY4, V4.7 Build 53 ; Postprocessing SW: SEMCAD, V1.8 Build 172

Mid Channel 384/Area Scan (6x9x1): Measurement grid: dx=15mm, dy=15mm

Maximum value of SAR (measured) = 0.664 mW/g

Mid Channel 384/Zoom Scan (7x7x7) (7x7x7)/Cube 0: Measurement grid: dx=5mm, dy=5mm, dz=5mm

Reference Value = 20.7 V/m

Peak SAR (extrapolated) = 1.06 W/kg

SAR(1 g) = 0.607 mW/g; SAR(10 g) = 0.402 mW/g

Maximum value of SAR (measured) = 0.655 mW/g

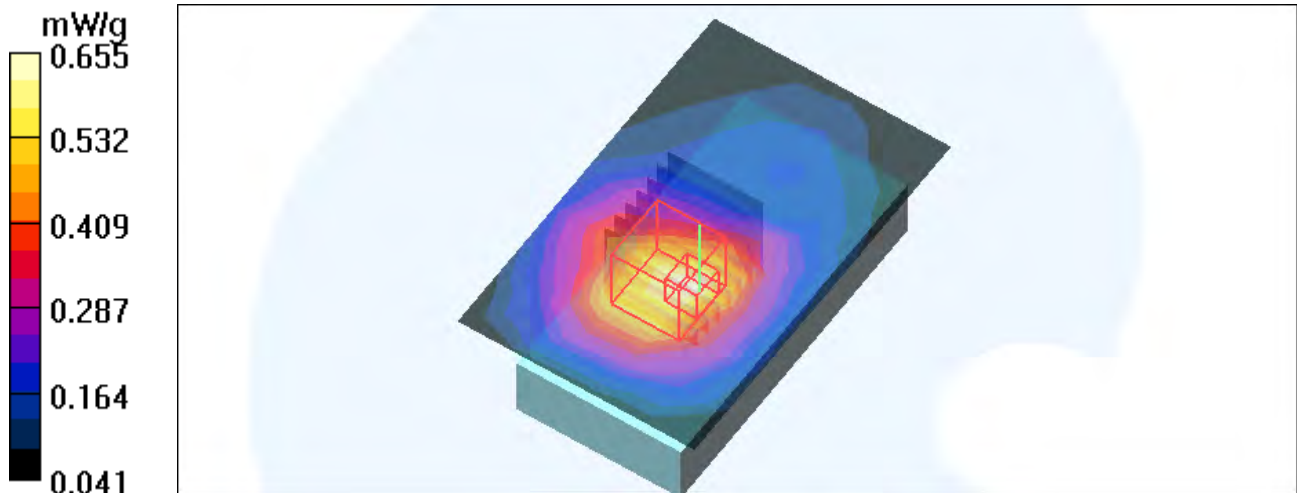

Test Laboratory: Advance Data Technology

M07-Body Worn-CDMA850-Ch384

DUT: Pocket PC Phone ; Type: RAPH800 ; Test Frequency: 836.5 MHz

Communication System: CDMA ; Frequency: 836.5 MHz ; Duty Cycle: 1:1

Medium: MSL835 Medium parameters used: $f = 836.5$ MHz; $\sigma = 1.01$ mho/m; $\epsilon_r = 56.7$; $\rho = 1000$

kg/m³ ; Liquid Level : 153 mm

Phantom section: Flat Section ; DUT test position : Body ; Modulation Type: OQPSK

Separation Distance : 0 mm (The front side of the EUT to the Phantom)

Antenna Type : monopole Antenna ; Air Temp. : 23.2 degrees ; Liquid Temp. : 22.1 degrees

DASY4 Configuration:

- Probe: ET3DV6 - SN1790 ; ConvF(6.15, 6.15, 6.15) ; Calibrated: 2007/11/20

- Sensor-Surface: 4mm (Mechanical Surface Detection)

- Electronics: DAE3 Sn510 ; Calibrated: 2007/8/29

- Phantom: SAM 12 ; Type: SAM V4.0; Serial: TP 1202

- Measurement SW: DASY4, V4.7 Build 53 ; Postprocessing SW: SEMCAD, V1.8 Build 172

Mid Channel 384/Area Scan (6x9x1): Measurement grid: dx=15mm, dy=15mm

Maximum value of SAR (measured) = 0.298 mW/g

Mid Channel 384/Zoom Scan (7x7x7) (7x7x7)/Cube 0: Measurement grid: dx=5mm, dy=5mm, dz=5mm

Reference Value = 15.4 V/m

Peak SAR (extrapolated) = 0.411 W/kg

SAR(1 g) = 0.278 mW/g; SAR(10 g) = 0.191 mW/g

Maximum value of SAR (measured) = 0.299 mW/g

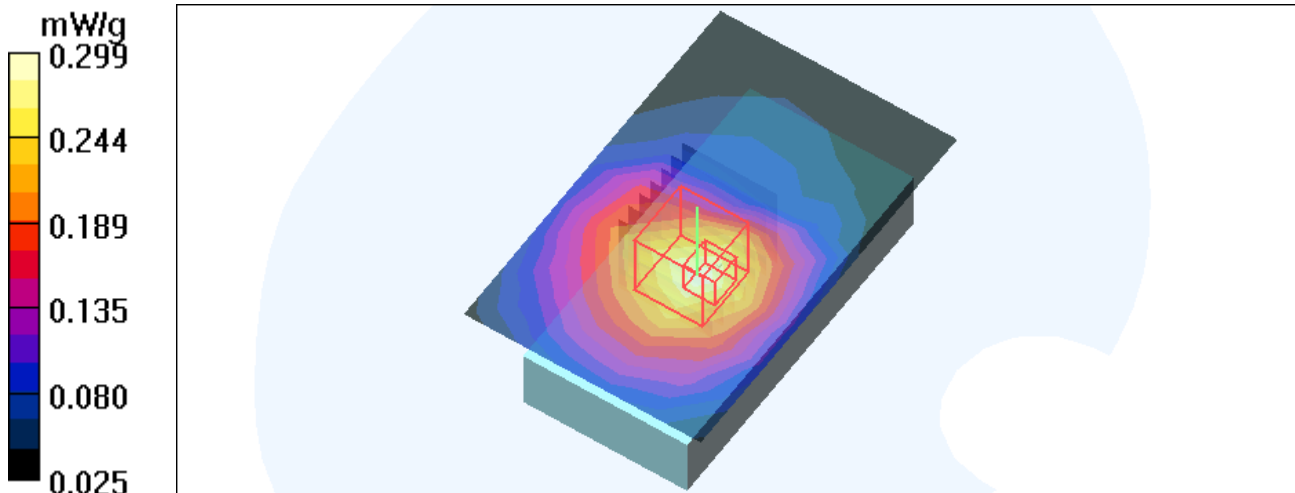

Test Laboratory: Advance Data Technology

System Validation Check-HSL 835MHz

DUT: Dipole 850 MHz ; Type: D835V2 ; Serial: 4d021 ; Test Frequency: 835 MHz

Communication System: CW ; Frequency: 835 MHz; Duty Cycle: 1:1; Modulation type: CW
Medium: HSL835;Medium parameters used: $f = 835$ MHz; $\sigma = 0.93$ mho/m; $\epsilon_r = 41.9$; $\rho = 1000$

kg/m^3 ; Liquid level : 155 mm

Phantom section: Flat Section ; Separation distance : 15 mm (The feetpoint of the dipole to the Phantom)Air temp. : 23.6 degrees ; Liquid temp. : 22.8 degrees

DASY4 Configuration:

- Probe: ET3DV6 - SN1790 ; ConvF(6.65, 6.65, 6.65) ; Calibrated: 2007/11/20
- Sensor-Surface: 4mm (Mechanical Surface Detection)
- Electronics: DAE3 Sn510; Calibrated: 2007/8/29
- Phantom: SAM 12; Type: SAM V4.0; Serial: TP 1202
- Measurement SW: DASY4, V4.7 Build 53; Postprocessing SW: SEMCAD, V1.8 Build 172

d=15mm, Pin=250mW/Area Scan (7x9x1): Measurement grid: dx=15mm, dy=15mm
Maximum value of SAR (measured) = 2.19 mW/g

d=15mm, Pin=250mW/Zoom Scan (7x7x7) (7x7x7)/Cube 0: Measurement grid: dx=5mm, dy=5mm, dz=5mm
Reference Value = 53.0 V/m; Power Drift = -0.082 dB
Peak SAR (extrapolated) = 3.14 W/kg
SAR(1 g) = 2.2 mW/g; SAR(10 g) = 1.45 mW/g
Maximum value of SAR (measured) = 2.38 mW/g

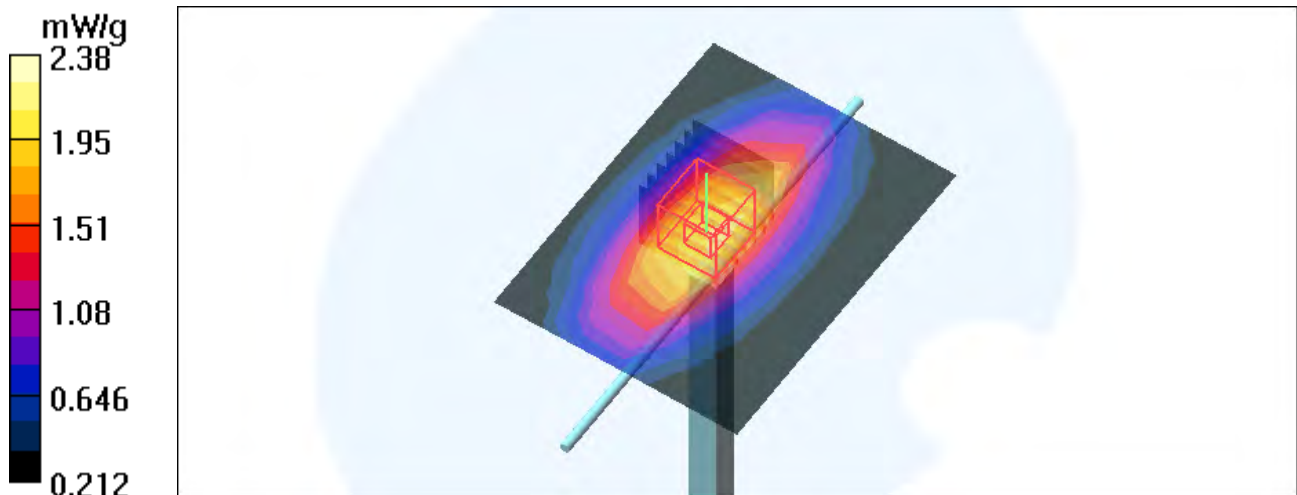

Test Laboratory: Advance Data Technology

System Validation Check-MSL 835MHz

DUT: Dipole 850 MHz ; Type: D835V2 ; Serial: 4d021 ; Test Frequency: 835 MHz

Communication System: CW ; Frequency: 835 MHz; Duty Cycle: 1:1; Modulation type: CW
Medium: MSL835; Medium parameters used: $f = 835 \text{ MHz}$; $\sigma = 1.01 \text{ mho/m}$; $\epsilon_r = 56.7$; $\rho = 1000$

kg/m^3 ; Liquid level : 153 mm

Phantom section: Flat Section ; Separation distance : 15 mm (The feetpoint of the dipole to the Phantom) Air temp. : 23.2 degrees ; Liquid temp. : 22.1 degrees

DASY4 Configuration:

- Probe: ET3DV6 - SN1790 ; ConvF(6.15, 6.15, 6.15) ; Calibrated: 2007/11/20
- Sensor-Surface: 4mm (Mechanical Surface Detection)
- Electronics: DAE3 Sn510; Calibrated: 2007/8/29
- Phantom: SAM 12; Type: SAM V4.0; Serial: TP 1202
- Measurement SW: DASY4, V4.7 Build 53; Postprocessing SW: SEMCAD, V1.8 Build 172

d=15mm, Pin=250mW/Area Scan (7x9x1): Measurement grid: dx=15mm, dy=15mm
Maximum value of SAR (measured) = 2.25 mW/g

d=15mm, Pin=250mW/Zoom Scan (7x7x7) (7x7x7)/Cube 0: Measurement grid: dx=5mm, dy=5mm, dz=5mm
Reference Value = 52.3 V/m; Power Drift = -0.098 dB
Peak SAR (extrapolated) = 3.16 W/kg
SAR(1 g) = 2.25 mW/g; SAR(10 g) = 1.48 mW/g
Maximum value of SAR (measured) = 2.45 mW/g

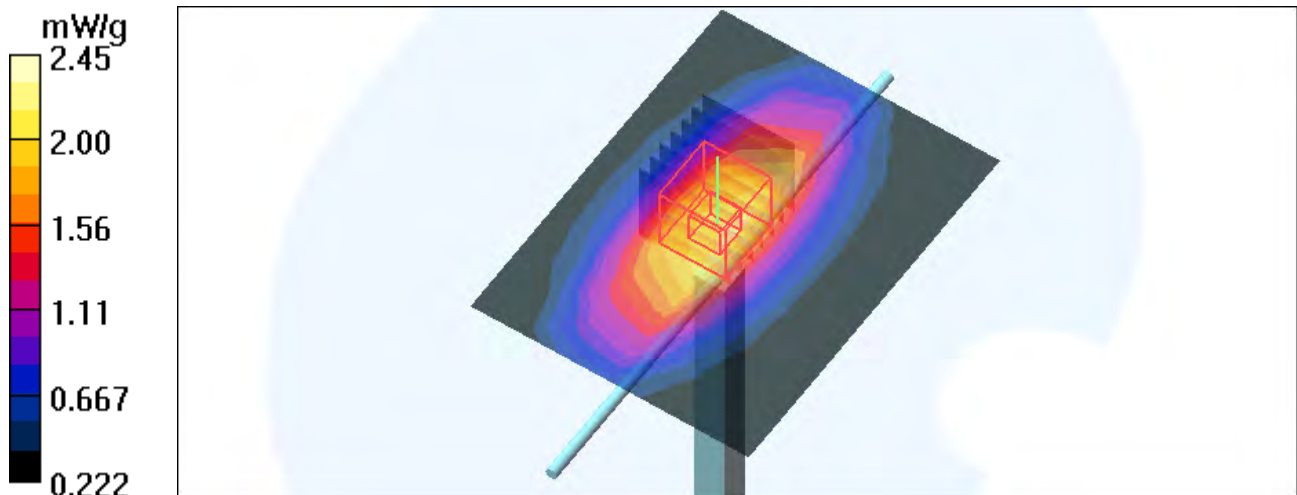

APPENDIX A: TEST DATA

Liquid Level Photo

HSL 1900MHz D=150mm



MSL 1900MHz D=151mm



Test Laboratory: Advance Data Technology

M08-Right Head-Cheek-CDMA1900-Ch25

DUT: Pocket PC Phone ; Type: RAPH800 ; Test Frequency: 1851.25 MHz

Communication System: CDMA ; Frequency: 1851.25 MHz ; Duty Cycle: 1:1
Medium: HSL1900 Medium parameters used: $f = 1851.25 \text{ MHz}$; $\sigma = 1.35 \text{ mho/m}$; $\epsilon_r = 40.3$; $\rho =$

1000 kg/m^3 ; Liquid level: 150 mm

Phantom section: Right Section ; DUT test position : Cheek ; Modulation type: OQPSK

Antenna type : monopole Antenna ; Air temp. : 23.4 degrees ; Liquid temp. : 22.1 degrees

DASY4 Configuration:

- Probe: ET3DV6 - SN1790 ; ConvF(5.1, 5.1, 5.1) ; Calibrated: 2007/11/20
- Sensor-Surface: 4mm (Mechanical Surface Detection)
- Electronics: DAE3 Sn510; Calibrated: 2007/8/29
- Phantom: SAM 12; Type: SAM V4.0; Serial: TP 1202
- Measurement SW: DASY4, V4.7 Build 53; Postprocessing SW: SEMCAD, V1.8 Build 172

Touch position - Low Channel 25/Area Scan (6x10x1): Measurement grid: $dx=15\text{mm}$, $dy=15\text{mm}$

Maximum value of SAR (measured) = 0.526 mW/g

Touch position - Low Channel 25/Zoom Scan (7x7x7) (7x7x7)/Cube 0: Measurement grid: $dx=5\text{mm}$, $dy=5\text{mm}$, $dz=5\text{mm}$

Reference Value = 15.7 V/m

Peak SAR (extrapolated) = 0.847 W/kg

SAR(1 g) = 0.532 mW/g; SAR(10 g) = 0.309 mW/g

Maximum value of SAR (measured) = 0.606 mW/g

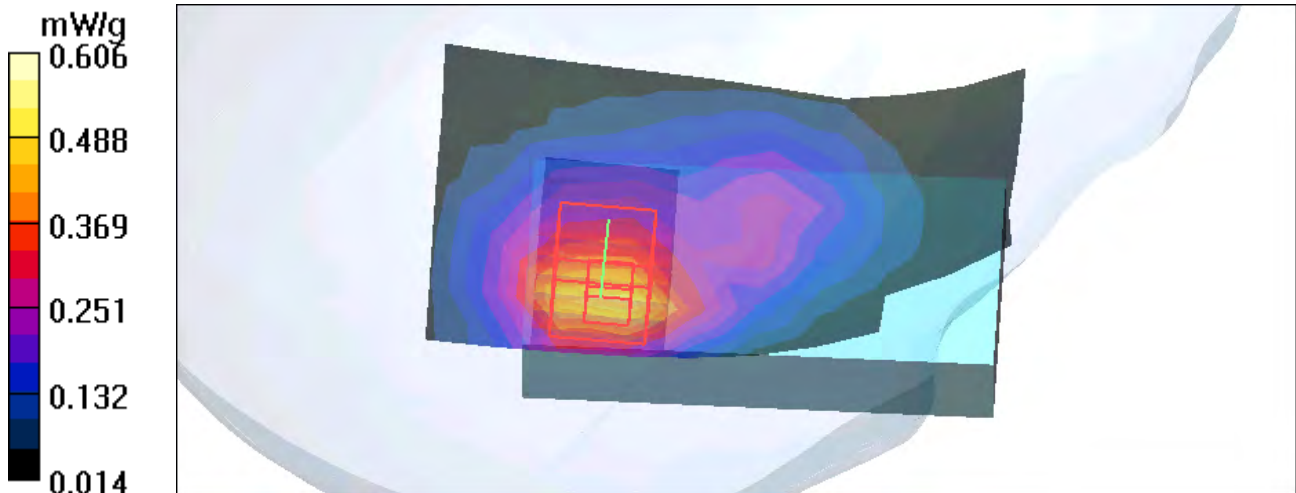

Test Laboratory: Advance Data Technology

M08-Right Head-Cheek-CDMA1900-Ch600

DUT: Pocket PC Phone ; Type: RAPH800 ; Test Frequency: 1880 MHz

Communication System: CDMA ; Frequency: 1880 MHz ; Duty Cycle: 1:1
Medium: HSL1900 Medium parameters used: $f = 1880$ MHz; $\sigma = 1.39$ mho/m; $\epsilon_r = 40.2$; $\rho = 1000$

kg/m³ ; Liquid level: 150 mm

Phantom section: Right Section ; DUT test position : Cheek ; Modulation type: OQPSK

Antenna type : monopole Antenna ; Air temp. : 23.4 degrees ; Liquid temp. : 22.1 degrees

DASY4 Configuration:

- Probe: ET3DV6 - SN1790 ; ConvF(5.1, 5.1, 5.1) ; Calibrated: 2007/11/20
- Sensor-Surface: 4mm (Mechanical Surface Detection)
- Electronics: DAE3 Sn510; Calibrated: 2007/8/29
- Phantom: SAM 12; Type: SAM V4.0; Serial: TP 1202
- Measurement SW: DASY4, V4.7 Build 53; Postprocessing SW: SEMCAD, V1.8 Build 172

Touch position - Mid Channel 600/Area Scan (6x10x1): Measurement grid: dx=15mm, dy=15mm

Maximum value of SAR (measured) = 0.712 mW/g

Touch position - Mid Channel 600/Zoom Scan (7x7x7) (7x7x7)/Cube 0: Measurement grid: dx=5mm, dy=5mm, dz=5mm

Reference Value = 18.2 V/m

Peak SAR (extrapolated) = 1.28 W/kg

SAR(1 g) = 0.613 mW/g; SAR(10 g) = 0.370 mW/g

Maximum value of SAR (measured) = 0.664 mW/g

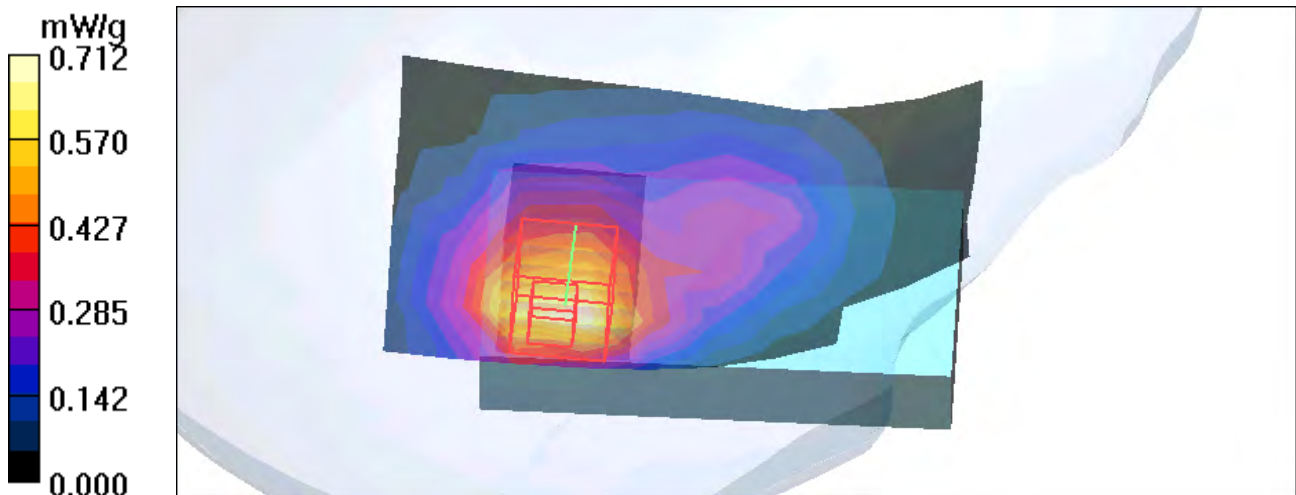

Test Laboratory: Advance Data Technology

M08-Right Head-Cheek-CDMA1900-Ch1175

DUT: Pocket PC Phone ; Type: RAPH800 ; Test Frequency: 1908.75 MHz

Communication System: CDMA ; Frequency: 1908.75 MHz ; Duty Cycle: 1:1
Medium: HSL1900 Medium parameters used: $f = 1908.75 \text{ MHz}$; $\sigma = 1.42 \text{ mho/m}$; $\epsilon_r = 40.1$; $\rho =$

1000 kg/m^3 ; Liquid level: 150 mm

Phantom section: Right Section ; DUT test position : Cheek ; Modulation type: OQPSK

Antenna type : monopole Antenna ; Air temp. : 23.4 degrees ; Liquid temp. : 22.1 degrees

DASY4 Configuration:

- Probe: ET3DV6 - SN1790 ; ConvF(5.1, 5.1, 5.1) ; Calibrated: 2007/11/20
- Sensor-Surface: 4mm (Mechanical Surface Detection)
- Electronics: DAE3 Sn510; Calibrated: 2007/8/29
- Phantom: SAM 12; Type: SAM V4.0; Serial: TP 1202
- Measurement SW: DASY4, V4.7 Build 53; Postprocessing SW: SEMCAD, V1.8 Build 172

Touch position - High Channel 1175/Area Scan (6x10x1): Measurement grid: dx=15mm, dy=15mm

Maximum value of SAR (measured) = 0.710 mW/g

Touch position - High Channel 1175/Zoom Scan (7x7x7) (7x7x7)/Cube 0:

Measurement grid: dx=5mm, dy=5mm, dz=5mm

Reference Value = 18.1 V/m

Peak SAR (extrapolated) = 1.11 W/kg

SAR(1 g) = 0.676 mW/g; SAR(10 g) = 0.394 mW/g

Maximum value of SAR (measured) = 0.748 mW/g

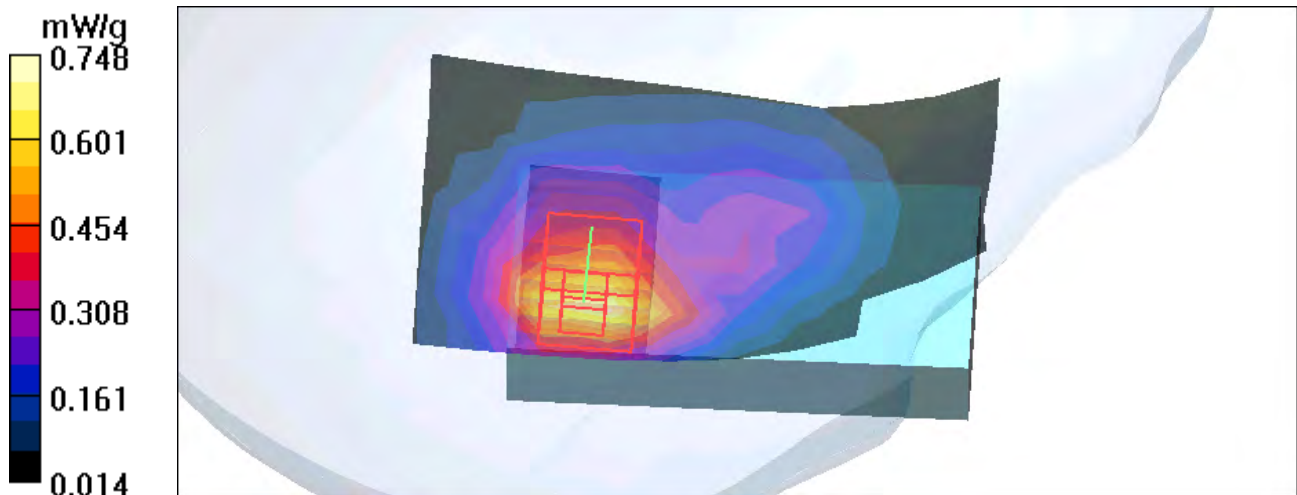

Test Laboratory: Advance Data Technology

M09-Right Head-Tilt-CDMA1900-Ch25

DUT: Pocket PC Phone ; Type: RAPH800 ; Test Frequency: 1851.25 MHz

Communication System: CDMA ; Frequency: 1851.25 MHz; Duty Cycle: 1:1
Medium: HSL1900 Medium parameters used: $f = 1851.25$ MHz; $\sigma = 1.35$ mho/m; $\epsilon_r = 40.3$; $\rho =$

1000 kg/m³ ; Liquid level: 150 mm

Phantom section: Right Section ; DUT test position : Tilt ; Modulation type: OQPSK

Antenna type : monopole Antenna ; Air temp. : 23.4 degrees ; Liquid temp. : 22.1 degrees

DASY4 Configuration:

- Probe: ET3DV6 - SN1790 ; ConvF(5.1, 5.1, 5.1) ; Calibrated: 2007/11/20
- Sensor-Surface: 4mm (Mechanical Surface Detection)
- Electronics: DAE3 Sn510; Calibrated: 2007/8/29
- Phantom: SAM 12; Type: SAM V4.0; Serial: TP 1202
- Measurement SW: DASY4, V4.7 Build 53; Postprocessing SW: SEMCAD, V1.8 Build 172

Tilt position - Low Channel 25/Area Scan (6x10x1): Measurement grid: dx=15mm, dy=15mm

Maximum value of SAR (measured) = 0.714 mW/g

Tilt position - Low Channel 25/Zoom Scan (7x7x7) (7x7x7)/Cube 0: Measurement grid: dx=5mm, dy=5mm, dz=5mm

Reference Value = 23.6 V/m

Peak SAR (extrapolated) = 1.02 W/kg

SAR(1 g) = 0.680 mW/g; SAR(10 g) = 0.418 mW/g

Maximum value of SAR (measured) = 0.737 mW/g

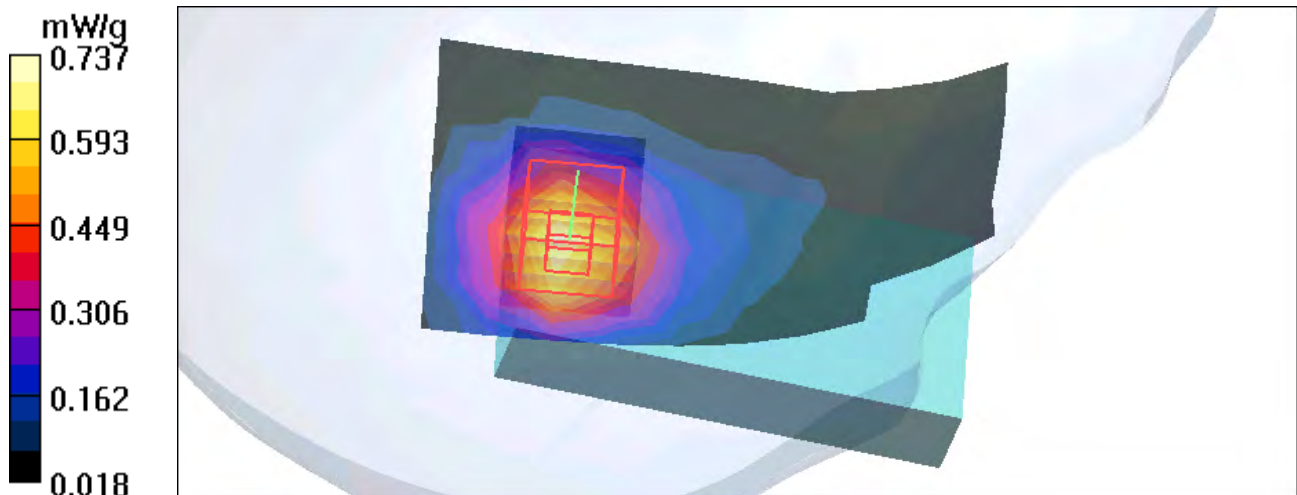

Test Laboratory: Advance Data Technology

M09-Right Head-Tilt-CDMA1900-Ch600

DUT: Pocket PC Phone ; Type: RAPH800 ; Test Frequency: 1880 MHz

Communication System: CDMA ; Frequency: 1880 MHz; Duty Cycle: 1:1
Medium: HSL1900 Medium parameters used: $f = 1880$ MHz; $\sigma = 1.39$ mho/m; $\epsilon_r = 40.2$; $\rho = 1000$

kg/m³ ; Liquid level: 150 mm

Phantom section: Right Section ; DUT test position : Tilt ; Modulation type: OQPSK

Antenna type : monopole Antenna ; Air temp. : 23.4 degrees ; Liquid temp. : 22.1 degrees

DASY4 Configuration:

- Probe: ET3DV6 - SN1790 ; ConvF(5.1, 5.1, 5.1) ; Calibrated: 2007/11/20
- Sensor-Surface: 4mm (Mechanical Surface Detection)
- Electronics: DAE3 Sn510; Calibrated: 2007/8/29
- Phantom: SAM 12; Type: SAM V4.0; Serial: TP 1202
- Measurement SW: DASY4, V4.7 Build 53; Postprocessing SW: SEMCAD, V1.8 Build 172

Tilt position - Mid Channel 600/Area Scan (6x10x1): Measurement grid: dx=15mm, dy=15mm

Maximum value of SAR (measured) = 0.864 mW/g

Tilt position - Mid Channel 600/Zoom Scan (7x7x7) (7x7x7)/Cube 0: Measurement grid: dx=5mm, dy=5mm, dz=5mm

Reference Value = 25.9 V/m

Peak SAR (extrapolated) = 1.31 W/kg

SAR(1 g) = 0.853 mW/g; SAR(10 g) = 0.508 mW/g

Maximum value of SAR (measured) = 0.921 mW/g

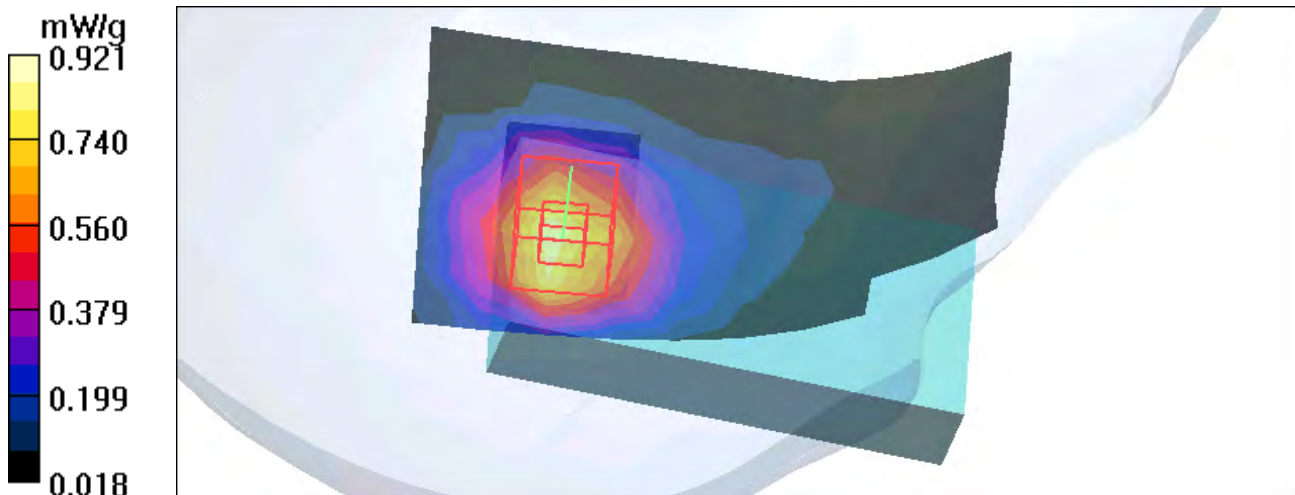

Test Laboratory: Advance Data Technology

M09-Right Head-Tilt-CDMA1900-Ch1175

DUT: Pocket PC Phone ; Type: RAPH800 ; Test Frequency: 1908.75 MHz

Communication System: CDMA ; Frequency: 1908.75 MHz; Duty Cycle: 1:1
Medium: HSL1900 Medium parameters used: $f = 1908.75$ MHz; $\sigma = 1.42$ mho/m; $\epsilon_r = 40.1$; $\rho =$

1000 kg/m^3 ; Liquid level: 150 mm

Phantom section: Right Section ; DUT test position : Tilt ; Modulation type: OQPSK

Antenna type : monopole Antenna ; Air temp. : 23.4 degrees ; Liquid temp. : 22.1 degrees

DASY4 Configuration:

- Probe: ET3DV6 - SN1790 ; ConvF(5.1, 5.1, 5.1) ; Calibrated: 2007/11/20
- Sensor-Surface: 4mm (Mechanical Surface Detection)
- Electronics: DAE3 Sn510; Calibrated: 2007/8/29
- Phantom: SAM 12; Type: SAM V4.0; Serial: TP 1202
- Measurement SW: DASY4, V4.7 Build 53; Postprocessing SW: SEMCAD, V1.8 Build 172

Tilt position - High Channel 1175/Area Scan (6x10x1): Measurement grid: $dx=15\text{mm}$, $dy=15\text{mm}$

Maximum value of SAR (measured) = 0.888 mW/g

Tilt position - High Channel 1175/Zoom Scan (7x7x7) (7x7x7)/Cube 0: Measurement grid: $dx=5\text{mm}$, $dy=5\text{mm}$, $dz=5\text{mm}$

Reference Value = 26.5 V/m

Peak SAR (extrapolated) = 1.42 W/kg

SAR(1 g) = 0.908 mW/g; SAR(10 g) = 0.537 mW/g

Maximum value of SAR (measured) = 0.995 mW/g

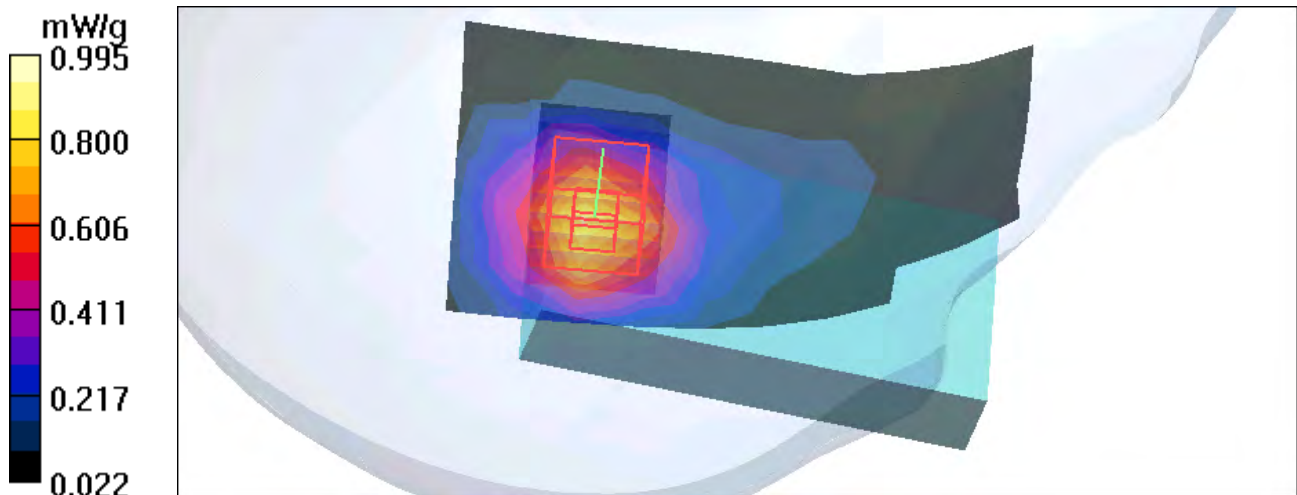

1g/10g Averaged SAR

SAR; Zoom Scan (7x7x7): Value Along Z, X=4, Y=3

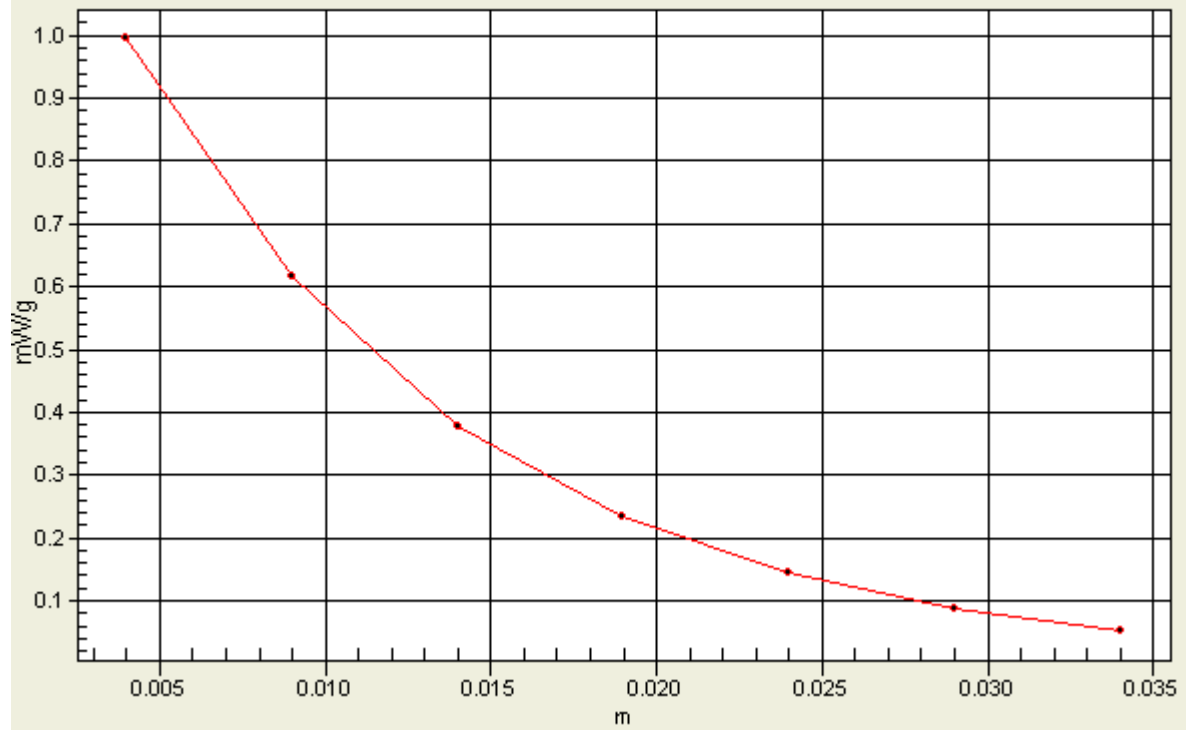

Test Laboratory: Advance Data Technology

M10-Left Head-Cheek-CDMA1900-Ch25

DUT: Pocket PC Phone ; Type: RAPH800 ; Test Frequency: 1851.25 MHz

Communication System: CDMA ; Frequency: 1851.25 MHz ; Duty Cycle: 1:1
Medium: HSL1900 Medium parameters used: $f = 1851.25$ MHz; $\sigma = 1.35$ mho/m; $\epsilon_r = 40.3$; $\rho =$

1000 kg/m³ ; Liquid level: 150 mm

Phantom section: Left Section ; DUT test position : Cheek ; Modulation type: OQPSK

Antenna type : monopole Antenna ; Air temp. : 23.4 degrees ; Liquid temp. : 22.1 degrees

DASY4 Configuration:

- Probe: ET3DV6 - SN1790 ; ConvF(5.1, 5.1, 5.1) ; Calibrated: 2007/11/20
- Sensor-Surface: 4mm (Mechanical Surface Detection)
- Electronics: DAE3 Sn510; Calibrated: 2007/8/29
- Phantom: SAM 12; Type: SAM V4.0; Serial: TP 1202
- Measurement SW: DASY4, V4.7 Build 53; Postprocessing SW: SEMCAD, V1.8 Build 172

Touch position - Low Channel 25/Area Scan (6x10x1): Measurement grid: dx=15mm, dy=15mm

Maximum value of SAR (measured) = 0.593 mW/g

Touch position - Low Channel 25/Zoom Scan (7x7x7) (7x7x7)/Cube 0: Measurement grid: dx=5mm, dy=5mm, dz=5mm

Reference Value = 18.7 V/m

Peak SAR (extrapolated) = 0.884 W/kg

SAR(1 g) = 0.503 mW/g; SAR(10 g) = 0.309 mW/g

Maximum value of SAR (measured) = 0.547 mW/g

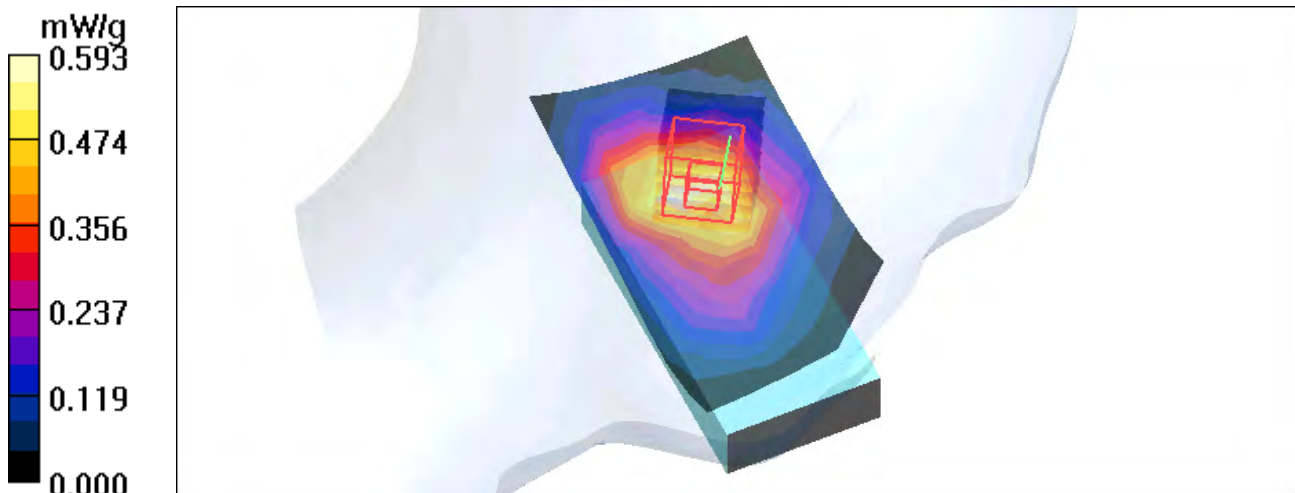

Test Laboratory: Advance Data Technology

M10-Left Head-Cheek-CDMA1900-Ch600

DUT: Pocket PC Phone ; Type: RAPH800 ; Test Frequency: 1880 MHz

Communication System: CDMA ; Frequency: 1880 MHz ; Duty Cycle: 1:1
Medium: HSL1900 Medium parameters used: $f = 1880 \text{ MHz}$; $\sigma = 1.39 \text{ mho/m}$; $\epsilon_r = 40.2$; $\rho = 1000$

kg/m^3 ; Liquid level: 150 mm

Phantom section: Left Section ; DUT test position : Cheek ; Modulation type: OQPSK

Antenna type : monopole Antenna ; Air temp. : 23.4 degrees ; Liquid temp. : 22.1 degrees

DASY4 Configuration:

- Probe: ET3DV6 - SN1790 ; ConvF(5.1, 5.1, 5.1) ; Calibrated: 2007/11/20
- Sensor-Surface: 4mm (Mechanical Surface Detection)
- Electronics: DAE3 Sn510; Calibrated: 2007/8/29
- Phantom: SAM 12; Type: SAM V4.0; Serial: TP 1202
- Measurement SW: DASY4, V4.7 Build 53; Postprocessing SW: SEMCAD, V1.8 Build 172

Touch position - Mid Channel 600/Area Scan (6x10x1): Measurement grid: $dx=15\text{mm}$, $dy=15\text{mm}$

Maximum value of SAR (measured) = 0.601 mW/g

Touch position - Mid Channel 600/Zoom Scan (7x7x7) (7x7x7)/Cube 0: Measurement grid: $dx=5\text{mm}$, $dy=5\text{mm}$, $dz=5\text{mm}$

Reference Value = 19.5 V/m

Peak SAR (extrapolated) = 0.855 W/kg

SAR(1 g) = 0.559 mW/g; SAR(10 g) = 0.357 mW/g

Maximum value of SAR (measured) = 0.606 mW/g

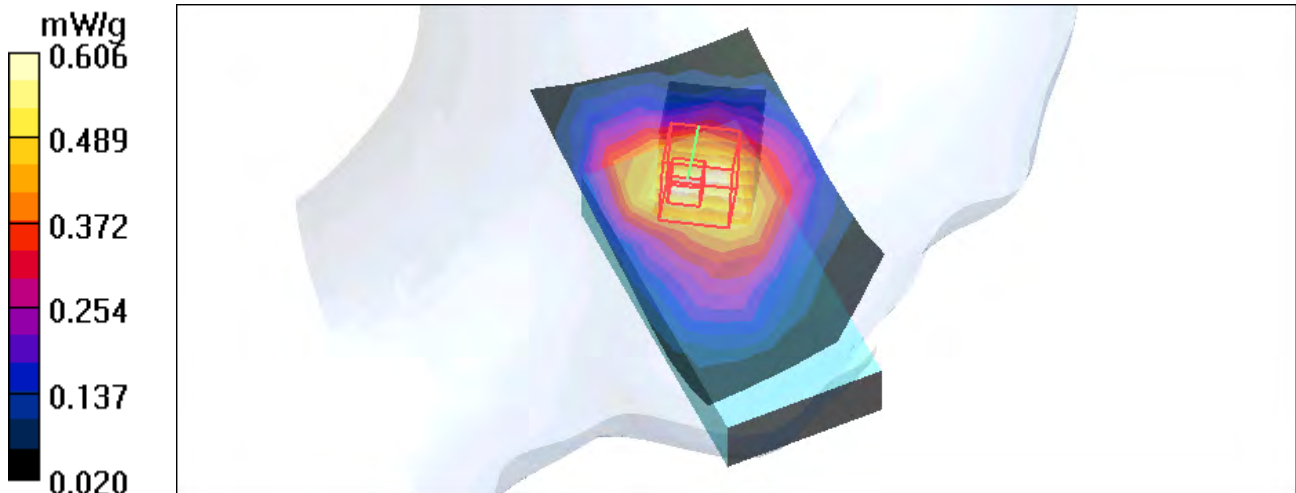

Test Laboratory: Advance Data Technology

M10-Left Head-Cheek-CDMA1900-Ch1175

DUT: Pocket PC Phone ; Type: RAPH800 ; Test Frequency: 1908.75 MHz

Communication System: CDMA ; Frequency: 1908.75 MHz ; Duty Cycle: 1:1
Medium: HSL1900 Medium parameters used: $f = 1908.75 \text{ MHz}$; $\sigma = 1.42 \text{ mho/m}$; $\epsilon_r = 40.1$; $\rho =$

1000 kg/m^3 ; Liquid level: 150 mm

Phantom section: Left Section ; DUT test position : Cheek ; Modulation type: OQPSK

Antenna type : monopole Antenna ; Air temp. : 23.4 degrees ; Liquid temp. : 22.1 degrees

DASY4 Configuration:

- Probe: ET3DV6 - SN1790 ; ConvF(5.1, 5.1, 5.1) ; Calibrated: 2007/11/20
- Sensor-Surface: 4mm (Mechanical Surface Detection)
- Electronics: DAE3 Sn510; Calibrated: 2007/8/29
- Phantom: SAM 12; Type: SAM V4.0; Serial: TP 1202
- Measurement SW: DASY4, V4.7 Build 53; Postprocessing SW: SEMCAD, V1.8 Build 172

Touch position - High Channel 1175/Area Scan (6x10x1): Measurement grid: dx=15mm, dy=15mm

Maximum value of SAR (measured) = 0.689 mW/g

Touch position - High Channel 1175/Zoom Scan (7x7x7) (7x7x7)/Cube 0:

Measurement grid: dx=5mm, dy=5mm, dz=5mm

Reference Value = 19.2 V/m

Peak SAR (extrapolated) = 1.40 W/kg

SAR(1 g) = 0.656 mW/g; SAR(10 g) = 0.393 mW/g

Maximum value of SAR (measured) = 0.637 mW/g

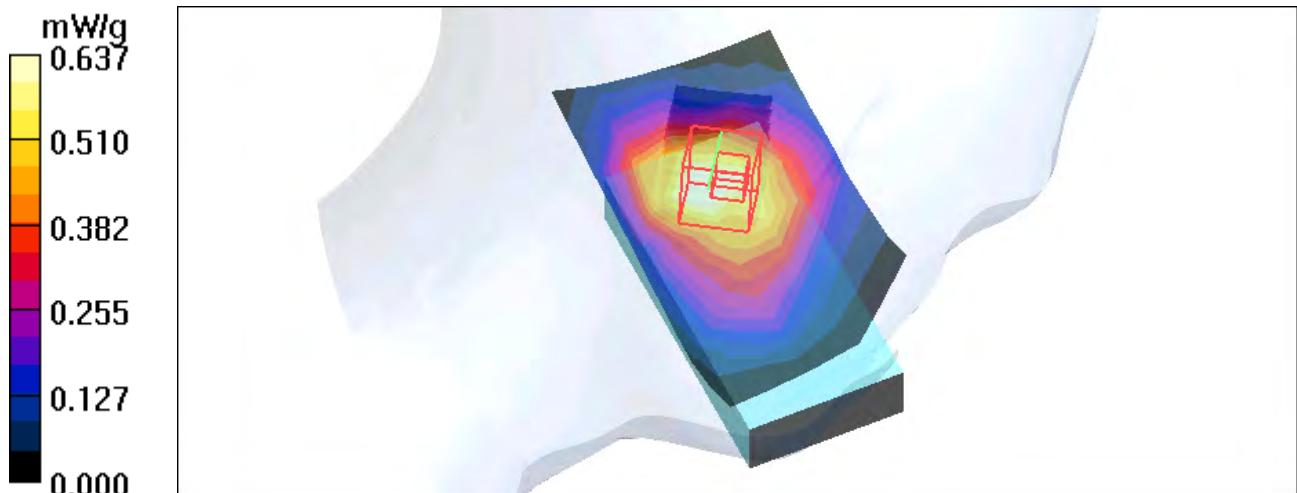

Test Laboratory: Advance Data Technology

M11-Left Head-Tilt-CDMA1900-Ch25

DUT: Pocket PC Phone ; Type: RAPH800 ; Test Frequency: 1851.25 MHz

Communication System: CDMA ; Frequency: 1851.25 MHz; Duty Cycle: 1:1
Medium: HSL1900 Medium parameters used: $f = 1851.25$ MHz; $\sigma = 1.35$ mho/m; $\epsilon_r = 40.3$; $\rho =$

1000 kg/m³ ; Liquid level: 150 mm

Phantom section: Left Section ; DUT test position : Tilt ; Modulation type: OQPSK

Antenna type : monopole Antenna ; Air temp. : 23.4 degrees ; Liquid temp. : 22.1 degrees

DASY4 Configuration:

- Probe: ET3DV6 - SN1790 ; ConvF(5.1, 5.1, 5.1) ; Calibrated: 2007/11/20
- Sensor-Surface: 4mm (Mechanical Surface Detection)
- Electronics: DAE3 Sn510; Calibrated: 2007/8/29
- Phantom: SAM 12; Type: SAM V4.0; Serial: TP 1202
- Measurement SW: DASY4, V4.7 Build 53; Postprocessing SW: SEMCAD, V1.8 Build 172

Tilt position - Low Channel 25/Area Scan (6x10x1): Measurement grid: dx=15mm, dy=15mm

Maximum value of SAR (measured) = 0.739 mW/g

Tilt position - Low Channel 25/Zoom Scan (7x7x7) (7x7x7)/Cube 0: Measurement grid: dx=5mm, dy=5mm, dz=5mm

Reference Value = 24.0 V/m

Peak SAR (extrapolated) = 1.12 W/kg

SAR(1 g) = 0.718 mW/g; SAR(10 g) = 0.430 mW/g

Maximum value of SAR (measured) = 0.781 mW/g

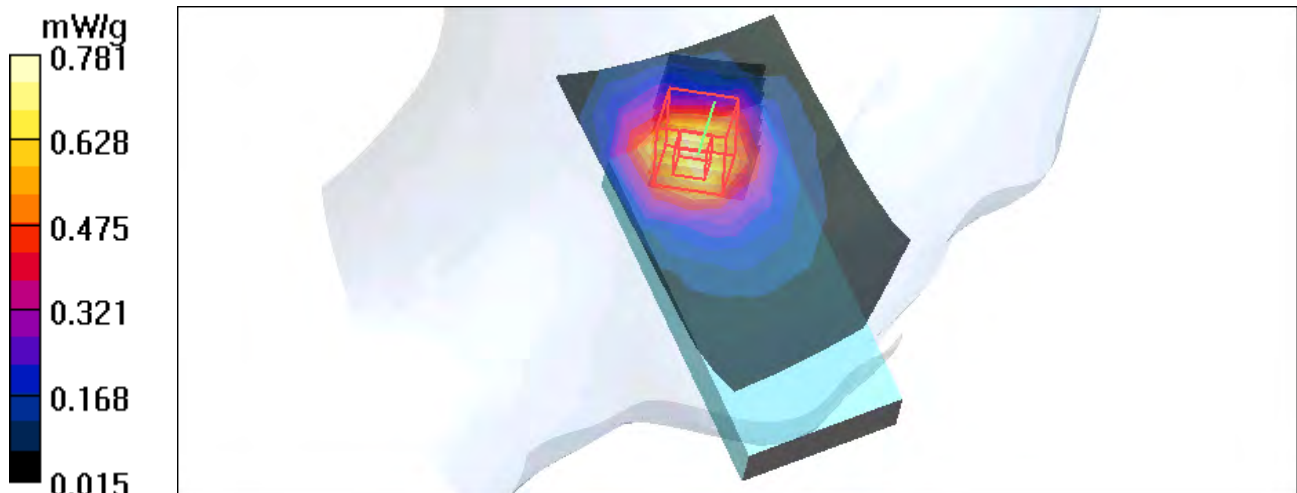

Test Laboratory: Advance Data Technology

M11-Left Head-Tilt-CDMA1900-Ch600

DUT: Pocket PC Phone ; Type: RAPH800 ; Test Frequency: 1880 MHz

Communication System: CDMA ; Frequency: 1880 MHz; Duty Cycle: 1:1
Medium: HSL1900 Medium parameters used: $f = 1880$ MHz; $\sigma = 1.39$ mho/m; $\epsilon_r = 40.2$; $\rho = 1000$

kg/m³ ; Liquid level: 150 mm

Phantom section: Left Section ; DUT test position : Tilt ; Modulation type: OQPSK

Antenna type : monopole Antenna ; Air temp. : 23.4 degrees ; Liquid temp. : 22.1 degrees

DASY4 Configuration:

- Probe: ET3DV6 - SN1790 ; ConvF(5.1, 5.1, 5.1) ; Calibrated: 2007/11/20
- Sensor-Surface: 4mm (Mechanical Surface Detection)
- Electronics: DAE3 Sn510; Calibrated: 2007/8/29
- Phantom: SAM 12; Type: SAM V4.0; Serial: TP 1202
- Measurement SW: DASY4, V4.7 Build 53; Postprocessing SW: SEMCAD, V1.8 Build 172

Tilt position - Mid Channel 600/Area Scan (6x10x1): Measurement grid: dx=15mm, dy=15mm

Maximum value of SAR (measured) = 0.816 mW/g

Tilt position - Mid Channel 600/Zoom Scan (7x7x7) (7x7x7)/Cube 0: Measurement grid: dx=5mm, dy=5mm, dz=5mm

Reference Value = 25.1 V/m

Peak SAR (extrapolated) = 1.36 W/kg

SAR(1 g) = 0.842 mW/g; SAR(10 g) = 0.447 mW/g

Maximum value of SAR (measured) = 0.901 mW/g

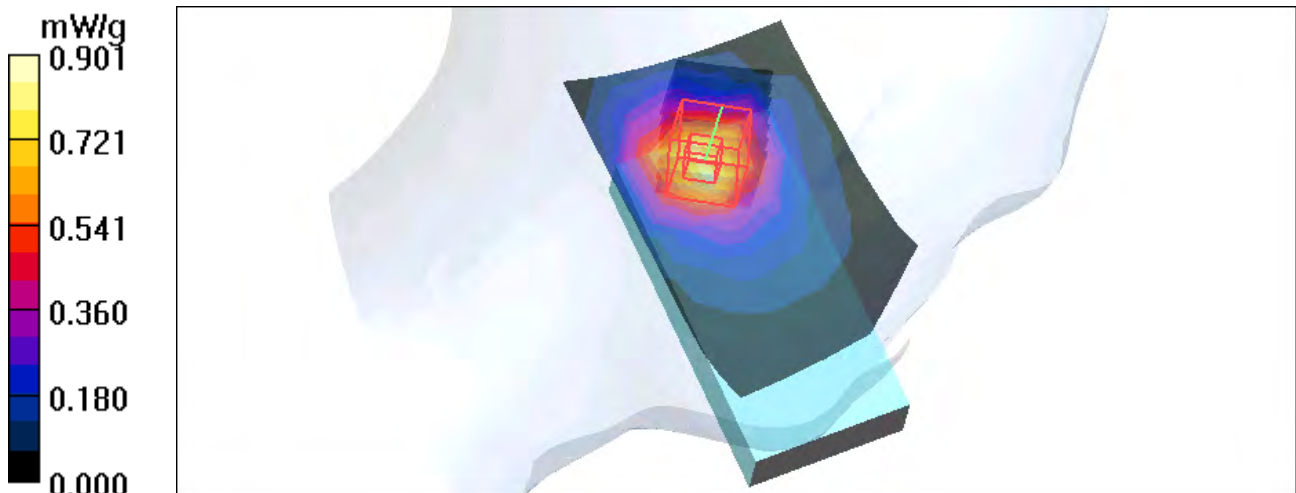

Test Laboratory: Advance Data Technology

M11-Left Head-Tilt-CDMA1900-Ch1175

DUT: Pocket PC Phone ; Type: RAPH800 ; Test Frequency: 1908.75 MHz

Communication System: CDMA ; Frequency: 1908.75 MHz; Duty Cycle: 1:1
Medium: HSL1900 Medium parameters used: $f = 1908.75$ MHz; $\sigma = 1.42$ mho/m; $\epsilon_r = 40.1$; $\rho =$

1000 kg/m^3 ; Liquid level: 150 mm

Phantom section: Left Section ; DUT test position : Tilt ; Modulation type: OQPSK

Antenna type : monopole Antenna ; Air temp. : 23.4 degrees ; Liquid temp. : 22.1 degrees

DASY4 Configuration:

- Probe: ET3DV6 - SN1790 ; ConvF(5.1, 5.1, 5.1) ; Calibrated: 2007/11/20
- Sensor-Surface: 4mm (Mechanical Surface Detection)
- Electronics: DAE3 Sn510; Calibrated: 2007/8/29
- Phantom: SAM 12; Type: SAM V4.0; Serial: TP 1202
- Measurement SW: DASY4, V4.7 Build 53; Postprocessing SW: SEMCAD, V1.8 Build 172

Tilt position - High Channel 1175/Area Scan (6x10x1): Measurement grid: $dx=15\text{mm}$, $dy=15\text{mm}$

Maximum value of SAR (measured) = 0.860 mW/g

Tilt position - High Channel 1175/Zoom Scan (7x7x7) (7x7x7)/Cube 0: Measurement grid: $dx=5\text{mm}$, $dy=5\text{mm}$, $dz=5\text{mm}$

Reference Value = 26.0 V/m

Peak SAR (extrapolated) = 1.33 W/kg

SAR(1 g) = 0.847 mW/g; SAR(10 g) = 0.499 mW/g

Maximum value of SAR (measured) = 0.922 mW/g

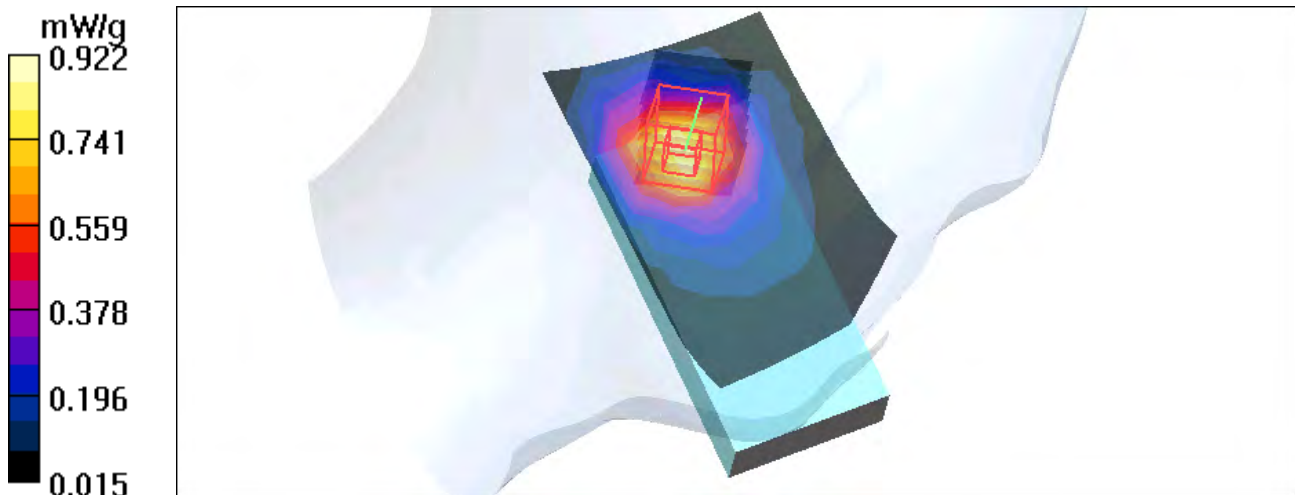

Test Laboratory: Advance Data Technology

M12-Body Worn-CDMA1900-Ch25

DUT: Pocket PC Phone ; Type: RAPH800 ; Test Frequency: 1851.25 MHz

Communication System: CDMA ; Frequency: 1851.25 MHz ; Duty Cycle: 1:1
Medium: MSL1900 Medium parameters used: $f = 1851.25 \text{ MHz}$; $\sigma = 1.51 \text{ mho/m}$; $\epsilon_r = 54.2$; $\rho =$

1000 kg/m^3 ; Liquid Level : 151 mm

Phantom section: Flat Section ; DUT test position : Body ; Modulation Type: OQPSK

Separation Distance : 0 mm (The bottom side of the EUT to the Phantom)

Antenna Type : monopole Antenna ; Air Temp. : 23.9 degrees ; Liquid Temp. : 22.7 degrees

DASY4 Configuration:

- Probe: ET3DV6 - SN1790 ; ConvF(4.58, 4.58, 4.58) ; Calibrated: 2007/11/20
- Sensor-Surface: 4mm (Mechanical Surface Detection)
- Electronics: DAE3 Sn510 ; Calibrated: 2007/8/29
- Phantom: SAM 12 ; Type: SAM V4.0; Serial: TP 1202
- Measurement SW: DASY4, V4.7 Build 53 ; Postprocessing SW: SEMCAD, V1.8 Build 172

Low Channel 25/Area Scan (6x9x1): Measurement grid: $dx=15\text{mm}$, $dy=15\text{mm}$

Maximum value of SAR (measured) = 0.759 mW/g

Low Channel 25/Zoom Scan (7x7x7) (7x7x7)/Cube 0: Measurement grid: $dx=5\text{mm}$, $dy=5\text{mm}$, $dz=5\text{mm}$

Reference Value = 21.0 V/m

Peak SAR (extrapolated) = 1.15 W/kg

SAR(1 g) = 0.692 mW/g; SAR(10 g) = 0.439 mW/g

Maximum value of SAR (measured) = 0.755 mW/g

Low Channel 25/Zoom Scan (7x7x7) (7x7x7)/Cube 1: Measurement grid: $dx=5\text{mm}$, $dy=5\text{mm}$, $dz=5\text{mm}$

Reference Value = 21.0 V/m

Peak SAR (extrapolated) = 0.856 W/kg

SAR(1 g) = 0.650 mW/g; SAR(10 g) = 0.397 mW/g

Maximum value of SAR (measured) = 0.715 mW/g

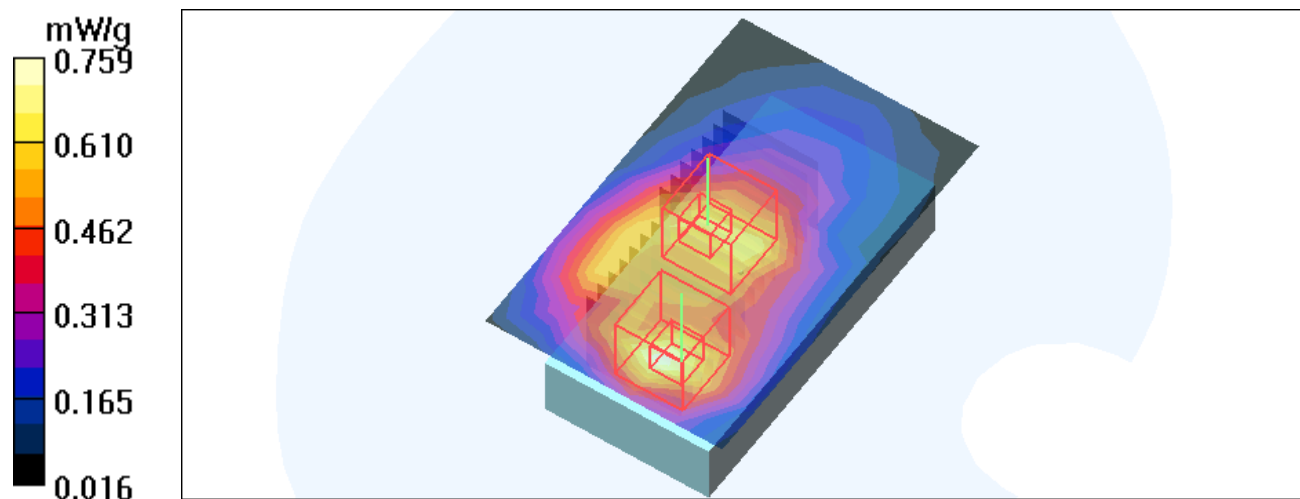

Test Laboratory: Advance Data Technology

M12-Body Worn-CDMA1900-Ch600

DUT: Pocket PC Phone ; Type: RAPH800 ; Test Frequency: 1880 MHz

Communication System: CDMA ; Frequency: 1880 MHz ; Duty Cycle: 1:1
Medium: MSL1900 Medium parameters used: $f = 1880$ MHz; $\sigma = 1.54$ mho/m; $\epsilon_r = 54.1$; $\rho = 1000$

kg/m³ ; Liquid Level : 151 mm

Phantom section: Flat Section ; DUT test position : Body ; Modulation Type: OQPSK

Separation Distance : 0 mm (The bottom side of the EUT to the Phantom)

Antenna Type : monopole Antenna ; Air Temp. : 23.9 degrees ; Liquid Temp. : 22.7 degrees

DASY4 Configuration:

- Probe: ET3DV6 - SN1790 ; ConvF(4.58, 4.58, 4.58) ; Calibrated: 2007/11/20
- Sensor-Surface: 4mm (Mechanical Surface Detection)
- Electronics: DAE3 Sn510 ; Calibrated: 2007/8/29
- Phantom: SAM 12 ; Type: SAM V4.0; Serial: TP 1202
- Measurement SW: DASY4, V4.7 Build 53 ; Postprocessing SW: SEMCAD, V1.8 Build 172

Mid Channel 600/Area Scan (6x9x1): Measurement grid: dx=15mm, dy=15mm

Maximum value of SAR (measured) = 0.743 mW/g

Mid Channel 600/Zoom Scan (7x7x7) (7x7x7)/Cube 0: Measurement grid: dx=5mm, dy=5mm, dz=5mm

Reference Value = 23.1 V/m

Peak SAR (extrapolated) = 0.991 W/kg

SAR(1 g) = 0.731 mW/g; SAR(10 g) = 0.453 mW/g

Maximum value of SAR (measured) = 0.773 mW/g

Mid Channel 600/Zoom Scan (7x7x7) (7x7x7)/Cube 1: Measurement grid: dx=5mm, dy=5mm, dz=5mm

Reference Value = 23.1 V/m

Peak SAR (extrapolated) = 1.24 W/kg

SAR(1 g) = 0.716 mW/g; SAR(10 g) = 0.415 mW/g

Maximum value of SAR (measured) = 0.806 mW/g

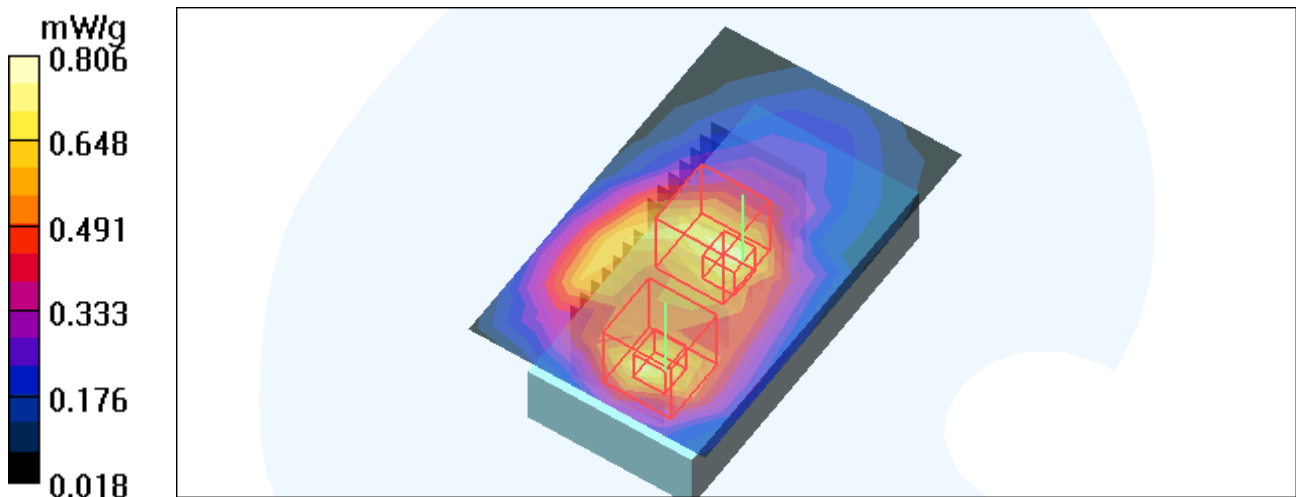

Test Laboratory: Advance Data Technology

M12-Body Worn-CDMA1900-Ch1175

DUT: Pocket PC Phone ; Type: RAPH800 ; Test Frequency: 1908.75 MHz

Communication System: CDMA ; Frequency: 1908.75 MHz ; Duty Cycle: 1:1

Medium: MSL1900 Medium parameters used: $f = 1908.75 \text{ MHz}$; $\sigma = 1.58 \text{ mho/m}$; $\epsilon_r = 54$; $\rho = 1000$

kg/m^3 ; Liquid Level : 151 mm

Phantom section: Flat Section ; DUT test position : Body ; Modulation Type: OQPSK

Separation Distance : 0 mm (The bottom side of the EUT to the Phantom)

Antenna Type : monopole Antenna ; Air Temp. : 23.9 degrees ; Liquid Temp. : 22.7 degrees

DASY4 Configuration:

- Probe: ET3DV6 - SN1790 ; ConvF(4.58, 4.58, 4.58) ; Calibrated: 2007/11/20

- Sensor-Surface: 4mm (Mechanical Surface Detection)

- Electronics: DAE3 Sn510 ; Calibrated: 2007/8/29

- Phantom: SAM 12 ; Type: SAM V4.0; Serial: TP 1202

- Measurement SW: DASY4, V4.7 Build 53 ; Postprocessing SW: SEMCAD, V1.8 Build 172

High Channel 1175/Area Scan (6x9x1): Measurement grid: $dx=15\text{mm}$, $dy=15\text{mm}$

Maximum value of SAR (measured) = 0.763 mW/g

High Channel 1175/Zoom Scan (7x7x7) (7x7x7)/Cube 0: Measurement grid: $dx=5\text{mm}$, $dy=5\text{mm}$, $dz=5\text{mm}$

Reference Value = 23.4 V/m

Peak SAR (extrapolated) = 1.03 W/kg

SAR(1 g) = 0.734 mW/g; SAR(10 g) = 0.459 mW/g

Maximum value of SAR (measured) = 0.798 mW/g

High Channel 1175/Zoom Scan (7x7x7) (7x7x7)/Cube 1: Measurement grid: $dx=5\text{mm}$, $dy=5\text{mm}$, $dz=5\text{mm}$

Reference Value = 23.4 V/m

Peak SAR (extrapolated) = 1.25 W/kg

SAR(1 g) = 0.719 mW/g; SAR(10 g) = 0.415 mW/g

Maximum value of SAR (measured) = 0.801 mW/g

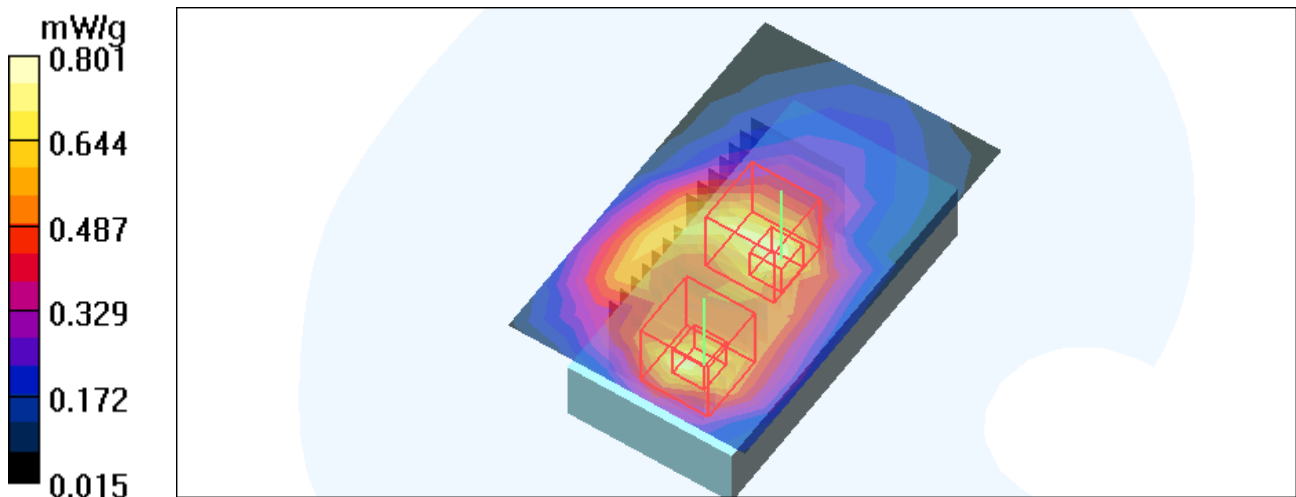

1g/10g Averaged SAR

SAR; Zoom Scan (7x7x7): Value Along Z, X=2, Y=3

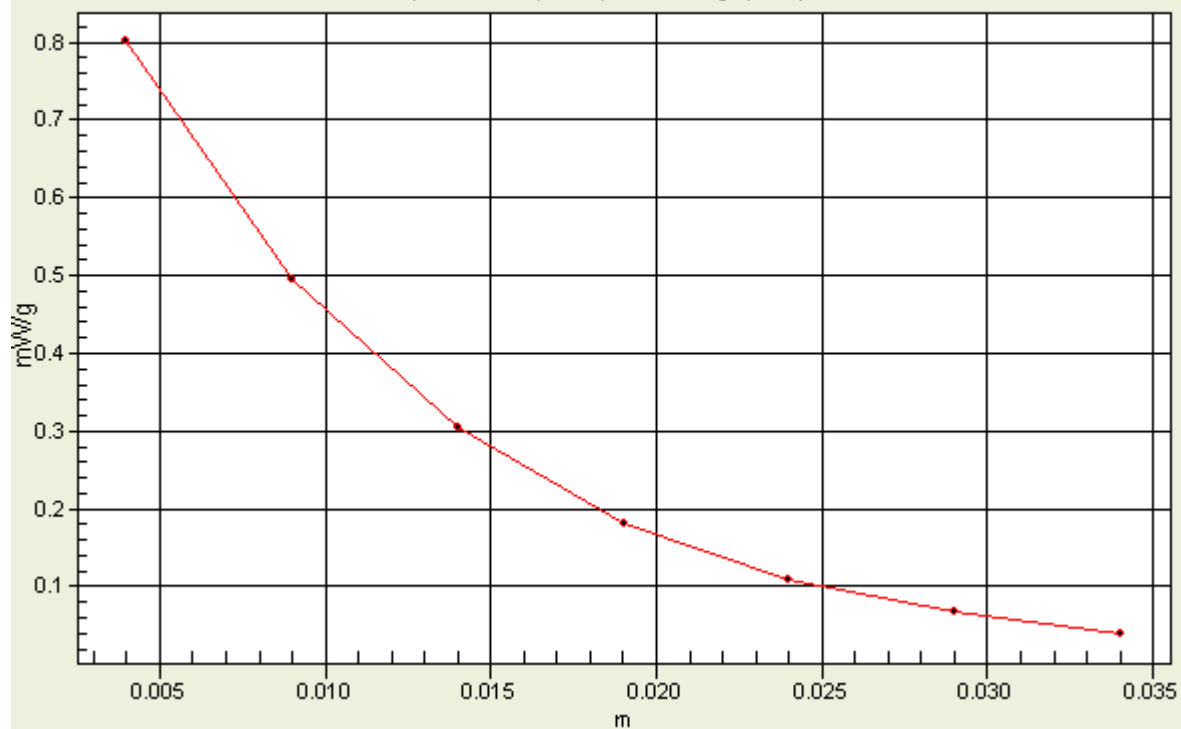

Test Laboratory: Advance Data Technology

M13-Body Worn-EVDO1900-Ch1175

DUT: Pocket PC Phone ; Type: RAPH800 ; Test Frequency: 1908.75 MHz

Communication System: CDMA ; Frequency: 1908.75 MHz ; Duty Cycle: 1:1

Medium: MSL1900 Medium parameters used: $f = 1908.75 \text{ MHz}$; $\sigma = 1.58 \text{ mho/m}$; $\epsilon_r = 54$; $\rho = 1000$

kg/m^3 ; Liquid Level : 151 mm

Phantom section: Flat Section ; DUT test position : Body ; Modulation Type: HPSK

Separation Distance : 0 mm (The bottom side of the EUT to the Phantom)

Antenna Type : monopole Antenna ; Air Temp. : 23.9 degrees ; Liquid Temp. : 22.7 degrees

DASY4 Configuration:

- Probe: ET3DV6 - SN1790 ; ConvF(4.58, 4.58, 4.58) ; Calibrated: 2007/11/20

- Sensor-Surface: 4mm (Mechanical Surface Detection)

- Electronics: DAE3 Sn510 ; Calibrated: 2007/8/29

- Phantom: SAM 12 ; Type: SAM V4.0; Serial: TP 1202

- Measurement SW: DASY4, V4.7 Build 53 ; Postprocessing SW: SEMCAD, V1.8 Build 172

High Channel 1175/Area Scan (6x9x1): Measurement grid: $dx=15\text{mm}$, $dy=15\text{mm}$

Maximum value of SAR (measured) = 0.722 mW/g

High Channel 1175/Zoom Scan (7x7x7) (7x7x7)/Cube 0: Measurement grid: $dx=5\text{mm}$, $dy=5\text{mm}$, $dz=5\text{mm}$

Reference Value = 24.0 V/m

Peak SAR (extrapolated) = 1.05 W/kg

SAR(1 g) = 0.487 mW/g; SAR(10 g) = 0.317 mW/g

Maximum value of SAR (measured) = 0.709 mW/g

High Channel 1175/Zoom Scan (7x7x7) (7x7x7)/Cube 1: Measurement grid: $dx=5\text{mm}$, $dy=5\text{mm}$, $dz=5\text{mm}$

Reference Value = 24.0 V/m

Peak SAR (extrapolated) = 1.13 W/kg

SAR(1 g) = 0.694 mW/g; SAR(10 g) = 0.394 mW/g

Maximum value of SAR (measured) = 0.751 mW/g

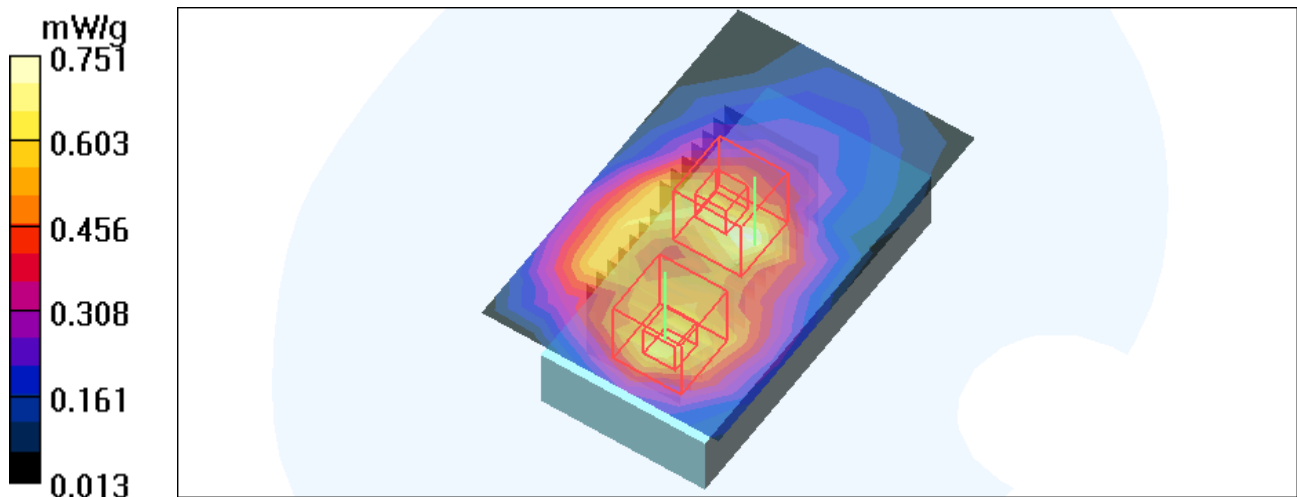

Test Laboratory: Advance Data Technology

M14-Body Worn-CDMA1900-Ch1175

DUT: Pocket PC Phone ; Type: RAPH800 ; Test Frequency: 1908.75 MHz

Communication System: CDMA ; Frequency: 1908.75 MHz ; Duty Cycle: 1:1

Medium: MSL1900 Medium parameters used: $f = 1908.75$ MHz; $\sigma = 1.58$ mho/m; $\epsilon_r = 54$; $\rho = 1000$

kg/m³ ; Liquid Level : 151 mm

Phantom section: Flat Section ; DUT test position : Body ; Modulation Type: OQPSK

Separation Distance : 0 mm (The front side of the EUT to the Phantom)

Antenna Type : monopole Antenna ; Air Temp. : 23.9 degrees ; Liquid Temp. : 22.7 degrees

DASY4 Configuration:

- Probe: ET3DV6 - SN1790 ; ConvF(4.58, 4.58, 4.58) ; Calibrated: 2007/11/20

- Sensor-Surface: 4mm (Mechanical Surface Detection)

- Electronics: DAE3 Sn510 ; Calibrated: 2007/8/29

- Phantom: SAM 12 ; Type: SAM V4.0; Serial: TP 1202

- Measurement SW: DASY4, V4.7 Build 53 ; Postprocessing SW: SEMCAD, V1.8 Build 172

High Channel 1175/Area Scan (6x9x1): Measurement grid: dx=15mm, dy=15mm

Maximum value of SAR (measured) = 0.261 mW/g

High Channel 1175/Zoom Scan (7x7x7) (7x7x7)/Cube 0: Measurement grid: dx=5mm, dy=5mm, dz=5mm

Reference Value = 8.23 V/m

Peak SAR (extrapolated) = 0.337 W/kg

SAR(1 g) = 0.213 mW/g; SAR(10 g) = 0.133 mW/g

Maximum value of SAR (measured) = 0.235 mW/g

High Channel 1175/Zoom Scan (7x7x7) (7x7x7)/Cube 1: Measurement grid: dx=5mm, dy=5mm, dz=5mm

Reference Value = 8.23 V/m

Peak SAR (extrapolated) = 0.349 W/kg

SAR(1 g) = 0.226 mW/g; SAR(10 g) = 0.134 mW/g

Maximum value of SAR (measured) = 0.245 mW/g

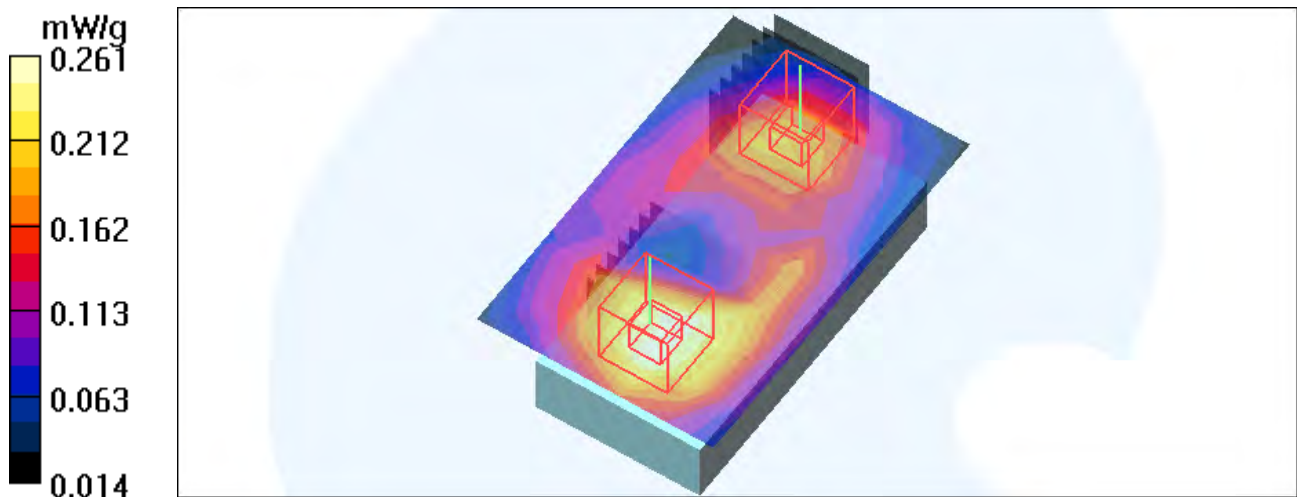

Test Laboratory: Advance Data Technology

System Validation Check-HSL 1900MHz

DUT: Dipole 1900 MHz ; Type: D1900V2 ; Serial: 5d022 ; Test Frequency: 1900 MHz

Communication System: CW ; Frequency: 1900 MHz; Duty Cycle: 1:1; Modulation type: CW
Medium: HSL1900;Medium parameters used: $f = 1900$ MHz; $\sigma = 1.42$ mho/m; $\epsilon_r = 40.2$; $\rho = 1000$ kg/m³ ; Liquid level : 150 mm
Phantom section: Flat Section ; Separation distance : 10 mm (The feetpoint of the dipole to the Phantom)Air temp. : 23.4 degrees ; Liquid temp. : 22.1 degrees

DASY4 Configuration:

- Probe: ET3DV6 - SN1790 ; ConvF(5.1, 5.1, 5.1) ; Calibrated: 2007/11/20
- Sensor-Surface: 4mm (Mechanical Surface Detection)
- Electronics: DAE3 Sn510; Calibrated: 2007/8/29
- Phantom: SAM 12; Type: SAM V4.0; Serial: TP 1202
- Measurement SW: DASY4, V4.7 Build 53; Postprocessing SW: SEMCAD, V1.8 Build 172

d=10mm, Pin=250mW/Area Scan (7x7x1): Measurement grid: dx=15mm, dy=15mm
Maximum value of SAR (measured) = 10.5 mW/g

d=10mm, Pin=250mW/Zoom Scan (7x7x7) (7x7x7)/Cube 0: Measurement grid: dx=5mm, dy=5mm, dz=5mm
Reference Value = 89.6 V/m; Power Drift = -0.026 dB
Peak SAR (extrapolated) = 17.4 W/kg
SAR(1 g) = 9.42 mW/g; SAR(10 g) = 4.86 mW/g
Maximum value of SAR (measured) = 10.7 mW/g

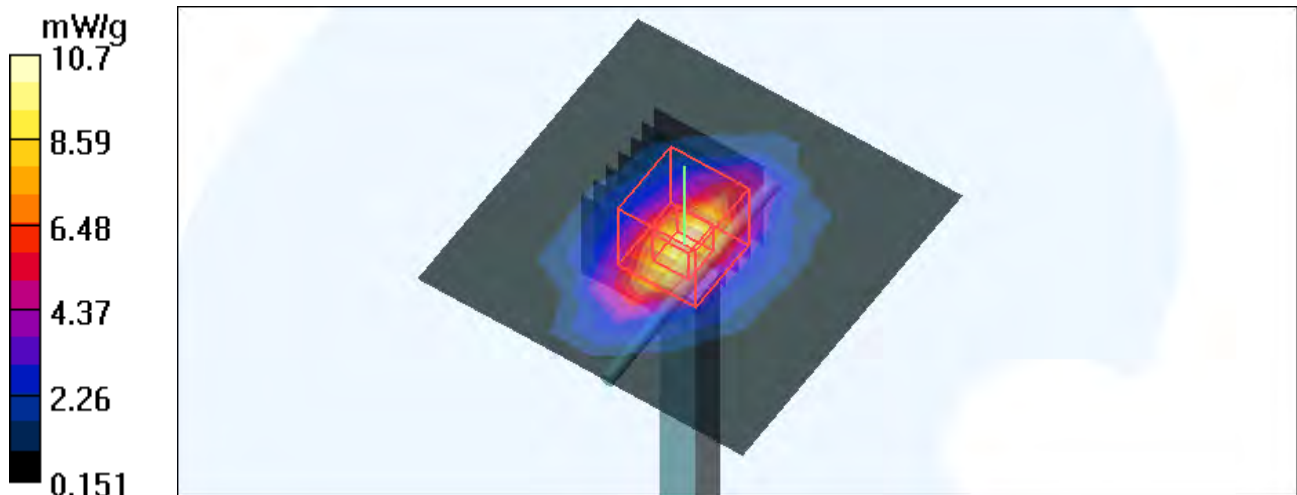

Test Laboratory: Advance Data Technology

System Validation Check-MSL 1900MHz

DUT: Dipole 1900 MHz ; Type: D1900V2 ; Serial: 5d022 ; Test Frequency: 1900 MHz

Communication System: CW ; Frequency: 1900 MHz; Duty Cycle: 1:1; Modulation type: CW
Medium: MSL1900; Medium parameters used: $f = 1900$ MHz; $\sigma = 1.57$ mho/m; $\epsilon_r = 54$; $\rho = 1000$ kg/m³ ; Liquid level : 151 mm
Phantom section: Flat Section ; Separation distance : 10 mm (The feetpoint of the dipole to the Phantom) Air temp. : 23.9 degrees ; Liquid temp. : 22.7 degrees

DASY4 Configuration:

- Probe: ET3DV6 - SN1790 ; ConvF(4.58, 4.58, 4.58) ; Calibrated: 2007/11/20
- Sensor-Surface: 4mm (Mechanical Surface Detection)
- Electronics: DAE3 Sn510; Calibrated: 2007/8/29
- Phantom: SAM 12; Type: SAM V4.0; Serial: TP 1202
- Measurement SW: DASY4, V4.7 Build 53; Postprocessing SW: SEMCAD, V1.8 Build 172

d=10mm, Pin=250mW/Area Scan (7x7x1): Measurement grid: dx=15mm, dy=15mm
Maximum value of SAR (measured) = 10.4 mW/g

d=10mm, Pin=250mW/Zoom Scan (7x7x7) (7x7x7)/Cube 0: Measurement grid: dx=5mm, dy=5mm, dz=5mm
Reference Value = 87.4 V/m; Power Drift = -0.041 dB
Peak SAR (extrapolated) = 16.4 W/kg
SAR(1 g) = 9.35 mW/g; SAR(10 g) = 4.97 mW/g
Maximum value of SAR (measured) = 10.6 mW/g

