



FCC TEST REPORT (PART 22)

REPORT NO.: RF970604L10

MODEL NO.: RAPH800

RECEIVED: Jun. 04, 2008

TESTED: Jun. 06 ~ Jun. 12, 2008

ISSUED: Jun. 16, 2008

APPLICANT: High Tech Computer Corp.

ADDRESS: 23, Hsin-Hua Rd., Taoyuan, 330, Taiwan, R.O.C.

ISSUED BY: Advance Data Technology Corporation

LAB ADDRESS: No. 47, 14th Ling, Chia Pau Tsuen, Lin Kou Hsiang
244, Taipei Hsien, Taiwan, R.O.C.

TEST LOCATION: No. 19, Hwa Ya 2nd Rd., Wen Hwa Tsuen, Kwei
Shan Hsiang, Taoyuan Hsien 333, Taiwan, R.O.C.

This test report consists of 57 pages in total. It may be duplicated completely for legal use with the approval of the applicant. It should not be reproduced except in full, without the written approval of our laboratory. The client should not use it to claim product endorsement by TAF, A2LA or any government agencies. The test results in the report only apply to the tested sample.





TABLE OF CONTENTS

1	CERTIFICATION	4
2	SUMMARY OF TEST RESULTS	5
2.1	MEASUREMENT UNCERTAINTY	5
3	GENERAL INFORMATION.....	6
3.1	GENERAL DESCRIPTION OF EUT	6
3.2	DESCRIPTION OF TEST MODES.....	8
3.2.1	CONFIGURATION OF SYSTEM UNDER TEST	9
3.2.2	TEST MODE APPLICABILITY AND TESTED CHANNEL DETAIL	10
3.3	GENERAL DESCRIPTION OF APPLIED STANDARDS	13
3.4	DESCRIPTION OF SUPPORT UNITS	13
4	TEST TYPES AND RESULTS	14
4.1	OUTPUT POWER MEASUREMENT	14
4.1.1	LIMITS OF OUTPUT POWER MEASUREMENT.....	14
4.1.2	TEST INSTRUMENTS.....	15
4.1.3	TEST PROCEDURES	16
4.1.4	TEST SETUP.....	17
4.1.5	EUT OPERATING CONDITIONS	18
4.1.6	TEST RESULTS	19
4.2	FREQUENCY STABILITY MEASUREMENT.....	21
4.2.1	LIMITS OF FREQUENCY STABILITY MEASUREMENT	21
4.2.2	TEST INSTRUMENTS.....	21
4.2.3	TEST PROCEDURE.....	22
4.2.4	TEST SETUP.....	22
4.2.5	TEST RESULTS	23
4.3	OCCUPIED BANDWIDTH MEASUREMENT	24
4.3.1	LIMITS OF OCCUPIED BANDWIDTH MEASUREMENT	24
4.3.2	TEST INSTRUMENTS.....	24
4.3.3	TEST SETUP.....	24
4.3.4	TEST PROCEDURES	25
4.3.5	TEST RESULTS	26
4.4	BAND EDGE MEASUREMENT.....	32
4.4.1	LIMITS OF BAND EDGE MEASUREMENT	32
4.4.2	TEST INSTRUMENTS.....	32
4.4.3	TEST SETUP.....	32
4.4.4	TEST PROCEDURES	33
4.4.5	EUT OPERATING CONDITION	33
4.4.6	TEST RESULTS	34
4.5	CONDUCTED SPURIOUS EMISSIONS.....	35
4.5.1	LIMITS OF CONDUCTED SPURIOUS EMISSIONS MEASUREMENT	35
4.5.2	TEST INSTRUMENTS.....	35
4.5.3	TEST PROCEDURE.....	36
4.5.4	TEST SETUP.....	36
4.5.5	EUT OPERATING CONDITIONS	37



4.5.6	TEST RESULTS	38
4.6	RADIATED EMISSION MEASUREMENT (BELOW 1GHz).....	44
4.6.1	LIMITS OF RADIATED EMISSION MEASUREMENT	44
4.6.2	TEST INSTRUMENTS.....	45
4.6.3	TEST PROCEDURES	46
4.6.4	DEVIATION FROM TEST STANDARD	46
4.6.5	TEST SETUP.....	47
4.6.6	EUT OPERATING CONDITIONS	47
4.6.7	TEST RESULTS	48
4.7	EFFECTIVE RADIATED POWER MEASUREMENT (ABOVE 1GHz)	49
4.7.1	LIMITS OF RADIATED EMISSION MEASUREMENT	49
4.7.2	TEST INSTRUMENTS.....	50
4.7.3	TEST PROCEDURES	51
4.7.4	DEVIATION FROM TEST STANDARD	51
4.7.5	TEST SETUP.....	52
4.7.6	EUT OPERATING CONDITIONS	52
4.7.7	TEST RESULTS	53
5	INFORMATION ON THE TESTING LABORATORIES	56
6	APPENDIX A – MODIFICATIONS RECORDERS FOR ENGINEERING CHANGES TO THE EUT BY THE LAB	57



1 CERTIFICATION

PRODUCT: Pocket PC Phone

MODEL: RAPH800

APPLICANT: High Tech Computer Corp.

TESTED: Jun. 06 ~ Jun. 12, 2008

TEST SAMPLE: ENGINEERING SAMPLE

TEST STANDARDS: FCC Part 22, Subpart H
ANSI C63.4-2003

The above equipment (model: RAPH800) has been tested by **Advance Data Technology Corporation**, and found compliance with the requirement of the above standards. The test record, data evaluation & Equipment Under Test (EUT) configurations represented herein are true and accurate accounts of the measurements of the sample's EMC characteristics under the conditions specified in this report.

PREPARED BY : Rennie Wang , **DATE:** Jun. 16, 2008
Rennie Wang / Senior Specialist

TECHNICAL ACCEPTANCE : Long Chen , **DATE:** Jun. 16, 2008
Responsible for RF Long Chen / Senior Engineer

APPROVED BY : Gary Chang , **DATE:** Jun. 16, 2008
Gary Chang / Assistant Manager

2 SUMMARY OF TEST RESULTS

The EUT has been tested according to the following specifications:

APPLIED STANDARD: FCC Part 22 & Part 2 / IC RSS-132			
STANDARD SECTION	TEST TYPE AND LIMIT	RESULT	REMARK
2.1046 22.913 (a)	Maximum Peak Output Power Limit: max. 7 watts e.r.p peak power	PASS	Meet the requirement of limit. Minimum passing margin is 24.02dBm at 824.70MHz.
2.1055	Frequency Stability AFC Freq. Error vs. Voltage AFC Freq. Error vs. Temperature Limit: max. ± 2.5 ppm	PASS	Meet the requirement of limit.
2.1049 (h)	Occupied Bandwidth	PASS	Meet the requirement of limit.
22.917	Band Edge Measurements	PASS	Meet the requirement of limit.
2.1051 22.917	Conducted Spurious Emissions	PASS	Meet the requirement of limit.
2.1053 22.917	Radiated Spurious Emissions	PASS	Meet the requirement of limit. Minimum passing margin is -34.29 dB at 255.49MHz.

2.1 MEASUREMENT UNCERTAINTY

Where relevant, the following measurement uncertainty levels have been estimated for tests performed on the EUT as specified in CISPR 16-4-2:

MEASUREMENT	FREQUENCY	UNCERTAINTY
Conducted emissions	9kHz~30MHz	2.44 dB
Radiated emissions	30MHz ~ 200MHz	3.34 dB
	200MHz ~1000MHz	3.35 dB
	1GHz ~ 18GHz	2.26 dB
	18GHz ~ 40GHz	1.94 dB

This uncertainty represents an expanded uncertainty expressed at approximately the 95% confidence level using a coverage factor of $k=2$.

3 GENERAL INFORMATION

3.1 GENERAL DESCRIPTION OF EUT

PRODUCT	Pocket PC Phone
MODEL NO.	RAPH800
FCC ID	NM8RAPH800
POWER SUPPLY	3.7Vdc from rechargeable lithium battery 5.0Vdc from power adapter 5.0Vdc from host equipment
MODULATION TYPE	OQPSK, HPSK
FREQUENCY RANGE	824MHz ~ 849MHz
NUMBER OF CHANNEL	788
MAX. ERP POWER	24.02dBm (0.252Watts)
ANTENNA TYPE	PIFA antenna with 0dBi gain
DATA CABLE	1.25m shielded USB cable without core 0.10m shielded 4-in-1 cable without core
I/O PORTS	Refer to user's manual
ACCESSORY DEVICES	Adapter, Battery, Earphone (Brand: hTC, model: HS S300, 1.90m), Pouch
EUT EXTREME VOL. RANGE	3.6Vdc to 4.2Vdc

NOTE:

1. The applicant defined the normal working voltage of the battery is from 3.6Vdc to 4.2Vdc.
2. The EUT is a Pocket PC Phone. The functions of EUT listed as below:

	TEST STANDARD	REFERENCE REPORT
WLAN 802.11b/g	FCC Part 15	RF970604L10-2
BLUETOOTH		RF970604L10-3
CDMA 850	FCC Part 22	RF970604L10
CDMA 1900	FCC Part 24	RF970604L10-1

3. The communicated functions of EUT listed as below:

		850MHz	1900MHz	With WLAN 802.11b/g + BT 2.0 with EDR + AGPS
3G	CDMA	V	V	
	1*EVDO	V	V	
	1*RTT	V	V	
	IS-95A/B	V	V	

4. The EUT has lithium battery listed as below:

BRAND:	hTC
MODEL:	DIAM171
RATING:	3.7Vdc, 1340mAh

5. The EUT was operated with following power adapter:

BRAND:	hTC
MODEL:	TC P300
INPUT:	100-240Vac, 0.2A, 50-60Hz
OUTPUT:	5Vdc, 1A
POWER LINE:	1.25m non-shielded cable without core

6. Refer to following table for MEID no.:

MEID NO.
A1000007*****

7. The above EUT information was declared by manufacturer and for more detailed features description, please refer to the manufacturer's specifications or User's Manual.

3.2 DESCRIPTION OF TEST MODES

788 channels are provided to this EUT in the CDMA850 band. Therefore, the low, middle and high channels are chosen for testing.

	CHANNEL	FREQUENCY	TX MODE
LOW	1013	824.7 MHz	SO55
MIDDLE	384	836.5 MHz	SO55
HIGH	777	848.3 MHz	SO55

NOTE:

1. Below 1 GHz, the channel 1013, 384 and 777 were pre-tested in chamber. The channel 1013 was the worst case and chosen for final test.
2. Above 1 GHz, the channel 1013, 384 and 777 were tested individually.
3. The channel space is 0.03MHz.
4. In this report, CDMA2000 (SO55) was the worst case for all test items, therefore, only the data was recorded in the following section.

3.2.1 CONFIGURATION OF SYSTEM UNDER TEST

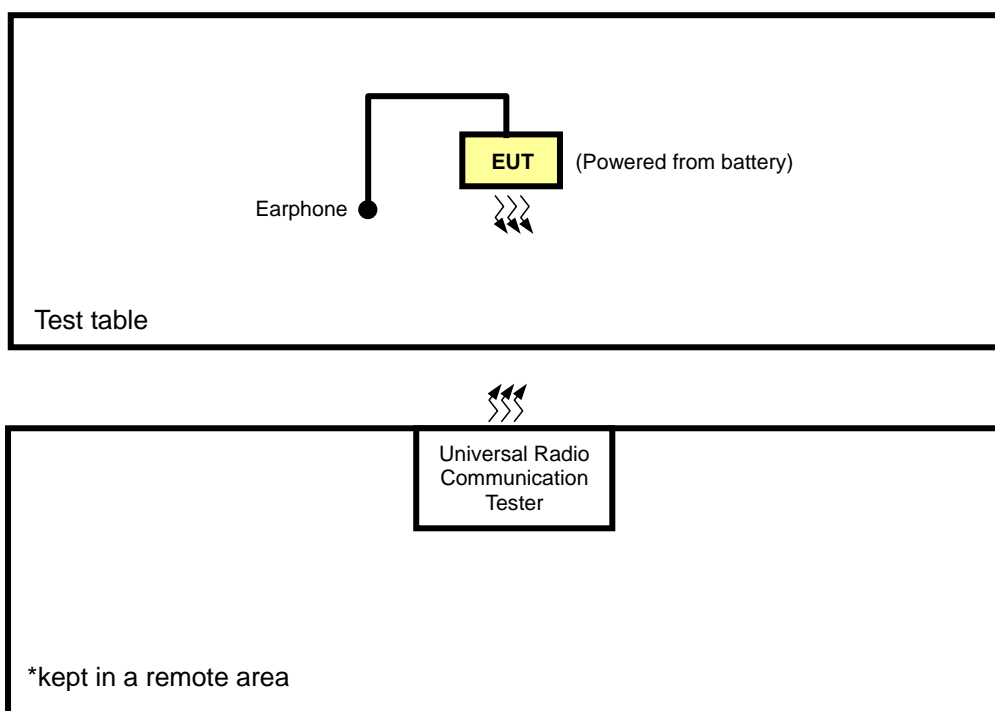

3.2.2 TEST MODE APPLICABILITY AND TESTED CHANNEL DETAIL

EUT CONFIGURE MODE	APPLICABLE TO							DESCRIPTION
	OP	FS	OB	BE	CE	RE<1G	RE≥1G	
-	V	V	V	V	V	V	V	-

Where **OP**: Output power **FS**: Frequency stability
OB: Occupied bandwidth **BE**: Band edge
CE: Conducted spurious emissions **RE<1G**: Radiated emission below 1GHz
RE≥1G: Radiated emission above 1GHz

OUTPUT POWER MEASUREMENT:

- Pre-Scan has been conducted to determine the worst-case mode from all possible combinations between available modulations, XYZ axis, and antenna ports (if EUT with antenna diversity architecture).
- Following channel(s) was (were) selected for the final test as listed below.

EUT CONFIGURE MODE	AVAILABLE CHANNEL	TESTED CHANNEL	MODULATION TECHNOLOGY	AXIS
-	1013 to 777	1013, 384, 777	CDMA	X

FREQUENCY STABILITY MEASUREMENT:

- Pre-Scan has been conducted to determine the worst-case mode from all possible combinations between available modulations and antenna ports (if EUT with antenna diversity architecture).
- Following channel(s) was (were) selected for the final test as listed below.

EUT CONFIGURE MODE	AVAILABLE CHANNEL	TESTED CHANNEL	MODULATION TECHNOLOGY
-	1013 to 777	384	CDMA



OCCUPIED BANDWIDTH MEASUREMENT:

- Pre-Scan has been conducted to determine the worst-case mode from all possible combinations between available modulations and antenna ports (if EUT with antenna diversity architecture).
- Following channel(s) was (were) selected for the final test as listed below.

EUT CONFIGURE MODE	AVAILABLE CHANNEL	TESTED CHANNEL	MODULATION TECHNOLOGY
-	1013 to 777	1013, 384, 777	CDMA

BAND EDGE MEASUREMENT:

- Pre-Scan has been conducted to determine the worst-case mode from all possible combinations between available modulations and antenna ports (if EUT with antenna diversity architecture).
- Following channel(s) was (were) selected for the final test as listed below.

EUT CONFIGURE MODE	AVAILABLE CHANNEL	TESTED CHANNEL	MODULATION TECHNOLOGY
-	1013 to 777	1013, 777	CDMA

CONDUCTED SPURIOUS EMISSIONS MEASUREMENT:

- Pre-Scan has been conducted to determine the worst-case mode from all possible combinations between available modulations and antenna ports (if EUT with antenna diversity architecture).
- Following channel(s) was (were) selected for the final test as listed below.

EUT CONFIGURE MODE	AVAILABLE CHANNEL	TESTED CHANNEL	MODULATION TECHNOLOGY
-	1013 to 777	1013, 384, 777	CDMA

RADIATED EMISSION MEASUREMENT (BELOW 1 GHz):

- Pre-Scan has been conducted to determine the worst-case mode from all possible combinations between available modulations, XYZ axis and antenna ports (if EUT with antenna diversity architecture).
- Following channel(s) was (were) selected for the final test as listed below.

EUT CONFIGURE MODE	AVAILABLE CHANNEL	TESTED CHANNEL	MODULATION TECHNOLOGY	AXIS
-	1013 to 777	1013	CDMA	X

RADIATED EMISSION MEASUREMENT (ABOVE 1 GHz):

- Pre-Scan has been conducted to determine the worst-case mode from all possible combinations between available modulations, XYZ axis and antenna ports (if EUT with antenna diversity architecture).
- Following channel(s) was (were) selected for the final test as listed below.

EUT CONFIGURE MODE	AVAILABLE CHANNEL	TESTED CHANNEL	MODULATION TECHNOLOGY	AXIS
-	1013 to 777	1013, 384, 777	CDMA	X



3.3 GENERAL DESCRIPTION OF APPLIED STANDARDS

The EUT is a RF product. According to the specifications of the manufacturer, it must comply with the requirements of the following standards:

FCC 47 CFR Part 2

FCC 47 CFR Part 22

ANSI C63.4-2003

ANSI/TIA/EIA-603-C 2004

NOTE: All test items have been performed and recorded as per the above standards.

3.4 DESCRIPTION OF SUPPORT UNITS

The EUT has been tested as an independent unit together with other necessary accessories or support units. The following support units or accessories were used to form a representative test configuration during the tests.

NO.	PRODUCT	BRAND	MODEL NO.	SERIAL NO.	CAL. DATE
1	Universal Radio Communication Tester	R&S	CMU200	101095	Nov. 25, 2008

NO.	SIGNAL CABLE DESCRIPTION OF THE ABOVE SUPPORT UNITS
1	NA

NOTE:

1. All power cords of the above support units are non shielded (1.8m).
2. Item 1 acted as a communication partners to transfer data.

4 TEST TYPES AND RESULTS

4.1 OUTPUT POWER MEASUREMENT

4.1.1 LIMITS OF OUTPUT POWER MEASUREMENT

The radiated peak output power shall be according to the specific rule Part 22.913 (a) that "Mobile / Portable station are limited to 7 watts e.r.p".



4.1.2 TEST INSTRUMENTS

DESCRIPTION & MANUFACTURER	MODEL NO.	SERIAL NO.	CALIBRATED UNTIL
Test Receiver ROHDE & SCHWARZ	ESCI	100424	Jul. 27, 2008
Spectrum Analyzer Agilent	E4446A	MY44360128	Dec. 06, 2008
BILOG Antenna SCHWARZBECK	VULB9168	9168-160	May 01, 2009
HORN Antenna SCHWARZBECK	9120D	9120D-209	Jun. 28, 2008
HORN Antenna SCHWARZBECK	BBHA 9170	BBHA9170243	Dec. 24, 2008
Preamplifier Agilent	8447D	2944A10633	Oct. 28, 2008
Preamplifier Agilent	8449B	3008A01964	Oct. 23, 2008
RF signal cable HUBER+SUHNNER	SUCOFLEX 104	283402/4	Dec. 06, 2008
RF signal cable HUBER+SUHNNER	SUCOFLEX 104	251644/4	Dec. 06, 2008
Software ADT.	ADT_Radiated_V7.6	NA	NA
Antenna Tower inn-co GmbH	MA 4000	013303	NA
Antenna Tower Controller inn-co GmbH	CO2000	017303	NA
Turn Table ADT.	TT100.	TT93021703	NA
Turn Table Controller ADT.	SC100.	SC93021703	NA

- NOTE:**
1. The calibration interval of the above test instruments is 12 months and the calibrations are traceable to NML/ROC and NIST/USA.
 2. The test was performed in HwaYa Chamber 3.
 3. The horn antenna and HP preamplifier (model: 8449B) are used only for the measurement of emission frequency above 1GHz if tested.
 4. The FCC Site Registration No. is 988962.
 5. The IC Site Registration No. is IC3789B-3.

4.1.3 TEST PROCEDURES

- a. The EUT was set up for the maximum peak power with CDMA link data modulation. The power was measured with R&S Spectrum Analyzer. All measurements were done at 3 channels: 1013, 384 and 777 (low, middle and high operational frequency range.)
- b. The conducted peak output power used the power splitter via EUT RF power connector between simulation base station and spectrum analyzer. The path loss included the splitter loss, cable loss and 20dB pad loss. The spectrum set RB/VB 3MHz, then read peak power value and record to the test. (All transmitted path loss shall be considered in the test report data.)
- c. E.I.R.P peak power measurement. In the fully anechoic chamber, EUT placed on the 1.5m height of Turn Table, rotated the table around 360 degrees to search the maximum radiation power and receiver antenna shall be rotated vertical and horizontal polarization to find the maximum polar radiated power. The "Read Value" is the spectrum reading the maximum power value.
- d. The substitution horn antenna is substituted for EUT at the same position and signals generator export the CW signal to the calibration antenna. Rotated the Turn Table to find the maximum radiation power. "Raw" is the spectrum reading value, "SG" is signal generator export power, "TX Gain" is calibration antenna isotropic gain value, "TX cable" is the transmitted cable loss between the calibration antenna and signal generator. The "Factor" means that the transmission path loss is equal to "SG" - "TX cable" + "TX Gain" - "Raw".
- e. Actually the real E.I.R.P peak power is equal to "Read Value" + "Factor".
- f. E.R.P power can be calculated form E.I.R.P power by subtracting the gain of dipole,
 $E.R.P \text{ power} = E.I.P.R \text{ power} - 2.15\text{dBi}$.

4.1.4 TEST SETUP

EIRP POWER MEASUREMENT:

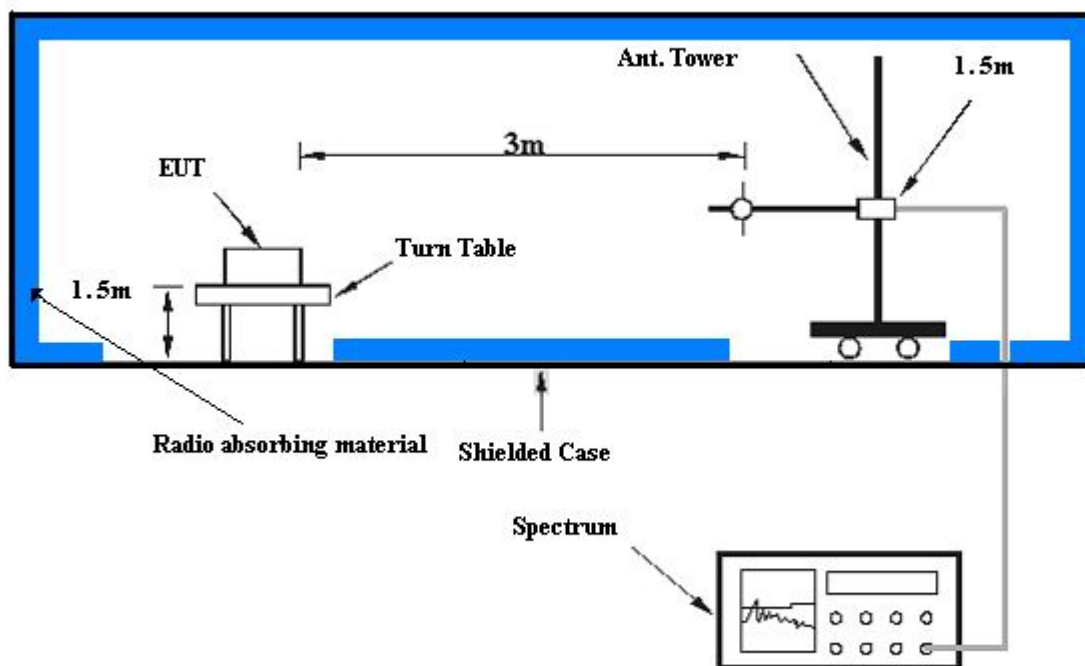

For the actual test configuration, please refer to the attached file (Test Setup Photo).

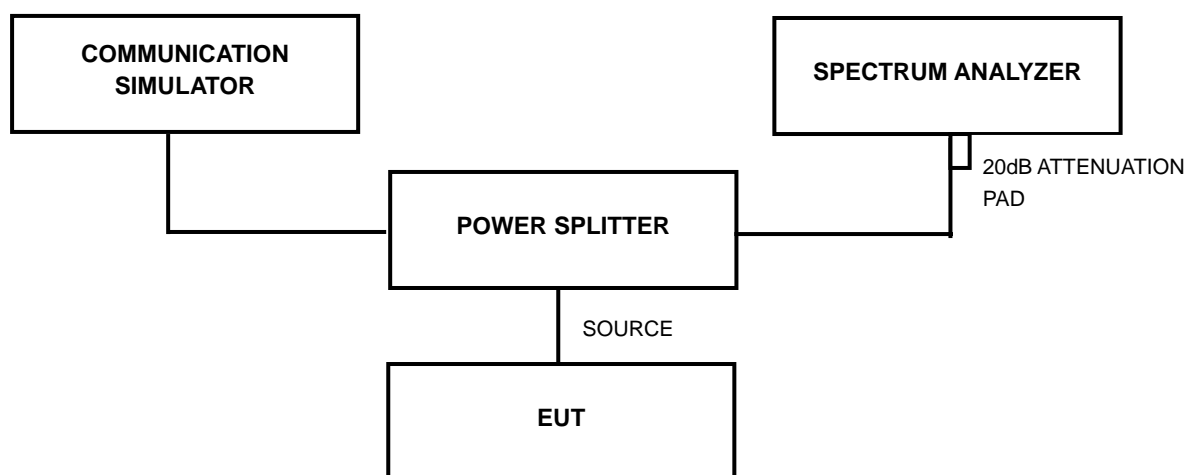

For the actual test configuration, please refer to the attached file (Test Setup Photo).

4.1.5 EUT OPERATING CONDITIONS

- a. The EUT makes a phone call to the communication simulator.
- b. The communication simulator station system controlled an EUT to export maximum output power under transmission mode and specific channel frequency.

4.1.6 TEST RESULTS

MODE	TX connected	DETECTOR FUNCTION	Average
INPUT POWER (SYSTEM)	120Vac, 60Hz	ENVIRONMENTAL CONDITIONS	23deg. C, 60%RH, 982hPa
TESTED BY	Dean Wang		

CONDUCTED POWER (1x EV-DO)								
CHANNEL	FREQ. (MHz)	RAW VALUE (dBm)		CORR. FACTOR (dB)	OUTPUT POWER			
		RTAP	FTAP		RTAP		FTAP	
					dBm	Watt	dBm	Watt
1013	824.7	20.61	20.49	3.20	23.81	0.240	23.69	0.234
384	836.5	20.72	20.62	3.20	23.92	0.247	23.82	0.241
777	848.3	20.97	20.85	3.20	24.17	0.261	24.05	0.254

CDMA 2000 CONDUCTED POWER														
CHAN.	FREQ. (MHz)	CDMA 2000	RAW VALUE (dBm)					CORR. FACTOR (dB)	OUTPUT POWER (dBm)					
			RC	SO2	SO55	TDSO SO32 (FCH)	TDSO SO32 (FCH+ SCH)		SO3	SO2	SO55	TDSO SO32 (FCH)	TDSO SO32 (FCH+ SCH)	SO3
1013	824.7	RC1	20.65	20.74	-	-	20.48	3.20	23.85	23.94	-	-	23.68	
		RC3	20.76	20.86	20.55	20.47	20.51	3.20	23.96	24.06	23.75	23.67	23.71	
384	836.5	RC1	20.85	20.92	-	-	20.52	3.20	24.05	24.12	-	-	23.72	
		RC3	21.01	21.08	20.72	20.61	20.69	3.20	24.21	24.28	23.92	23.81	23.89	
777	848.3	RC1	20.88	21.04	-	-	21.73	3.20	24.08	24.24	-	-	24.93	
		RC3	21.09	21.21	21.05	20.83	20.91	3.20	24.29	24.41	24.25	24.03	24.11	

- REMARKS:**
1. Peak Output Power (dBm) = Raw Value (dBm) + Correction Factor (dB).
 2. Correction Factor (dB) = Power Splitter Loss (dB) + Cable Loss (dB).
 3. The value in bold is the worst.



MODE	TX connected	DETECTOR FUNCTION	Average
INPUT POWER (SYSTEM)	120Vac, 60Hz	ENVIRONMENTAL CONDITIONS	23deg. C, 60%RH, 982hPa
TESTED BY	Dean Wang		

ERP POWER (1x EV-DO)								
CHANNEL	FREQ. (MHz)	RAW VALUE (dBm)		CORR. FACTOR (dB)	OUTPUT POWER			
		RTAP	FTAP		RTAP		FTAP	
					dBm	Watt	dBm	Watt
1013	824.7	-16.30	-16.41	40.03	23.73	0.236	23.62	0.230
384	836.5	-16.78	-16.92	40.32	23.54	0.226	23.40	0.219
777	848.3	-17.07	-17.26	40.62	23.55	0.226	23.36	0.217

ERP POWER (SO55)					
CHANNEL NO.	FREQUENCY (MHz)	RAW VALUE (dBm)	CORRECTION FACTOR (dB)	OUTPUT POWER	
				dBm	Watt
1013	824.7	-16.01	40.03	24.02	0.252
384	836.5	-16.55	40.32	23.77	0.238
777	848.3	-16.78	40.62	23.84	0.242

- REMARKS:**
1. Peak Output Power (dBm) = Raw Value (dBm) + Correction Factor (dB).
 2. Correction Factor (dB) = Receiver Antenna Gain (dBi) + Cable Loss (dB) + Free Space Loss (dB).
 3. The value in bold is the worst.



4.2 FREQUENCY STABILITY MEASUREMENT

4.2.1 LIMITS OF FREQUENCY STABILITY MEASUREMENT

According to the FCC part 2.4235 shall be tested the frequency stability. The rule is defined that "The frequency stability shall be sufficient to ensure that the fundamental emission stays within the authorized frequency block." The frequency error rate is according to the JTC standard that the frequency error rate shall be accurate to within 2.5ppm of the received frequency from the base station. The test extreme voltage is according to the 2.1055(d)(1) Vary primary supply voltage from 85 to 115 percent of the nominal value for other than hand carried battery equipment and the extreme temperature rule is comply with the 2.1055(a)(1) $-30^{\circ}\text{C} \sim 50^{\circ}\text{C}$.

4.2.2 TEST INSTRUMENTS

DESCRIPTION & MANUFACTURER	MODEL NO.	SERIAL NO.	CALIBRATED UNTIL
* ROHDE & SCHWARZ Spectrum Analyzer	FSP40	100040	Jun. 28, 2008
* Hewlett Packard RF cable	8120-6192	01428251	NA
* Suhner RF cable	Sucoflex104	204850/4	NA
* WIT Standard Temperature & Humidity Chamber	TH-4S-C	W981030	Jun. 28, 2008

- NOTE:**
1. The calibration interval of the above test instruments is 12 months. And the calibrations are traceable to NML/ROC and NIST/USA.
 2. "*" = These equipments are used for the final measurement.
 3. The test was performed in ADT RF OVEN room.

4.2.3 TEST PROCEDURE

- a. Because of the measure the carrier frequency under the condition of the AFC lock, it shall be used the mobile station in the CDMA link mode. This is accomplished with the use of the communication simulator station. The oven room could control the temperatures and humidity. The CDMA link channel is the 384.
- b. Power must be removed when changing from one temperature to another or one voltage to another voltage. Power warm up is at least 15 min and power applied should perform before recording frequency error.
- c. EUT is connected the external power supply to control the DC input power. The various Volts from the minimum 3.6 Volts to 4.2 Volts. Each step shall be record the frequency error rate.
- d. The temperature range step is 10 degrees in this test items. All temperature levels shall be hold the $\pm 0.5^{\circ}\text{C}$ during the measurement testing.
- e. The each temperature step shall be at least 0.5 hours, consider the EUT could be test under the stability condition.

NOTE: The frequency error was recorded frequency error from the communication simulator.

4.2.4 TEST SETUP

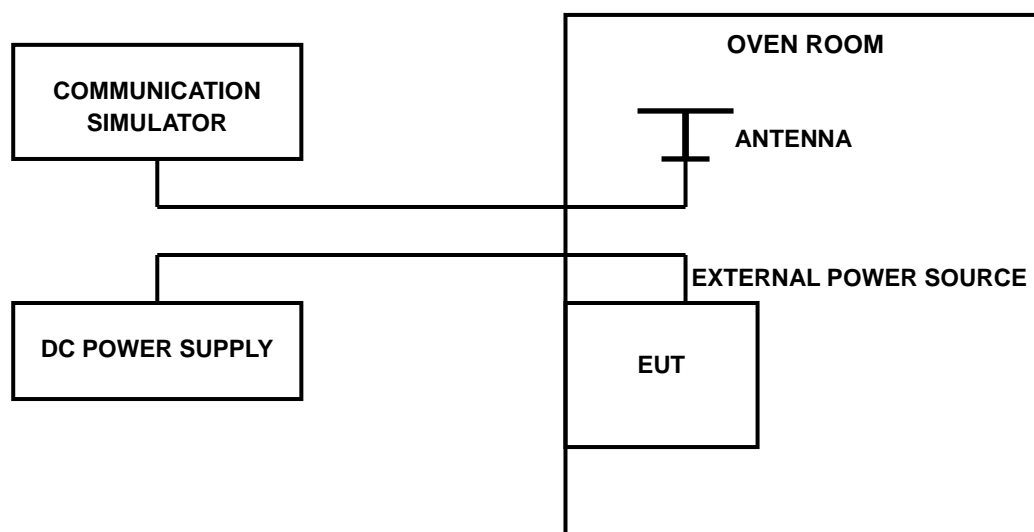



4.2.5 TEST RESULTS

MODE	Channel 384	ENVIRONMENTAL CONDITIONS	23deg. C, 60%RH, 982hPa
INPUT POWER (SYSTEM)	120Vac, 60Hz	TESTED BY	Dean Wang

AFC FREQUENCY ERROR vs. VOLTAGE			
VOLTAGE (Volts)	FREQUENCY ERROR (Hz)	FREQUENCY ERROR (ppm)	LIMIT (ppm)
4.2	11	0.0131497155	2.5
3.6	14	0.0167360015	2.5

NOTE: The applicant defined the normal working voltage of the battery is from 3.6Vdc to 4.2Vdc.

AFC FREQUENCY ERROR vs. TEMP.			
TEMP. (°C)	FREQUENCY ERROR (Hz)	FREQUENCY ERROR (ppm)	LIMIT (ppm)
50	15	0.0179314302	2.5
40	21	0.0251040023	2.5
30	12	0.0143451442	2.5
20	4	0.0047817147	2.5
10	-9	-0.0107588581	2.5
0	-1	-0.0011954287	2.5
-10	2	0.0023908574	2.5
-20	-11	-0.0131497155	2.5
-30	-17	-0.0203222876	2.5



4.3 OCCUPIED BANDWIDTH MEASUREMENT

4.3.1 LIMITS OF OCCUPIED BANDWIDTH MEASUREMENT

According to FCC 2.1049 (h) specified that emission bandwidth is defined as the width of the signal between two points, one below the carrier center frequency and one above the carrier center frequency, outside of which all emissions are attenuated at least 26dB below the transmitter power.

4.3.2 TEST INSTRUMENTS

DESCRIPTION & MANUFACTURER	MODEL NO.	SERIAL NO.	CALIBRATED UNTIL
* ROHDE & SCHWARZ Spectrum Analyzer	FSP40	100040	Jun. 28, 2008
* Mini-Circuits Power Splitter	ZAPD-4	400005	NA
* Hewlett Packard RF cable	8120-6192	01428251	NA
* JFW 20dB attenuation	50HF-020-SMA	NA	NA
* Suhner RF cable	Sucoflex104	204850/4	NA

NOTE: 1. The calibration interval of the above test instruments is 12 months. And the calibrations are traceable to NML/ROC and NIST/USA.

2. "*" = These equipments are used for the final measurement.

4.3.3 TEST SETUP

Same as Item 4.2.4 (Conducted Power Setup)

4.3.4 TEST PROCEDURES

- a. The EUT makes a phone call to the communication simulator. The power was measured with R&S Spectrum Analyzer. All measurements were done at 3 channels: 1013, 384 and 777 (low, middle and high operational frequency range.)
- b. The conducted occupied bandwidth used the power splitter via EUT RF power connector between simulation base station and spectrum analyzer. This splitter loss and cable loss is the worst loss 3.2dB in the transmitted path track.
- c. The communication simulator station system controlled a EUT to export maximum output power under transmission mode and specific channel frequency. FCC 2.1049 (h) required a measurement bandwidth is the fundamental emission below 26dB bandwidth.

4.3.5 TEST RESULTS

FOR SO55:

FREQUENCY (MHz)	MAX. OUTPUT POWER -26 dBc BANDWIDTH (MHz)
824.7	1.439
836.5	1.431
848.3	1.446

CH 1013

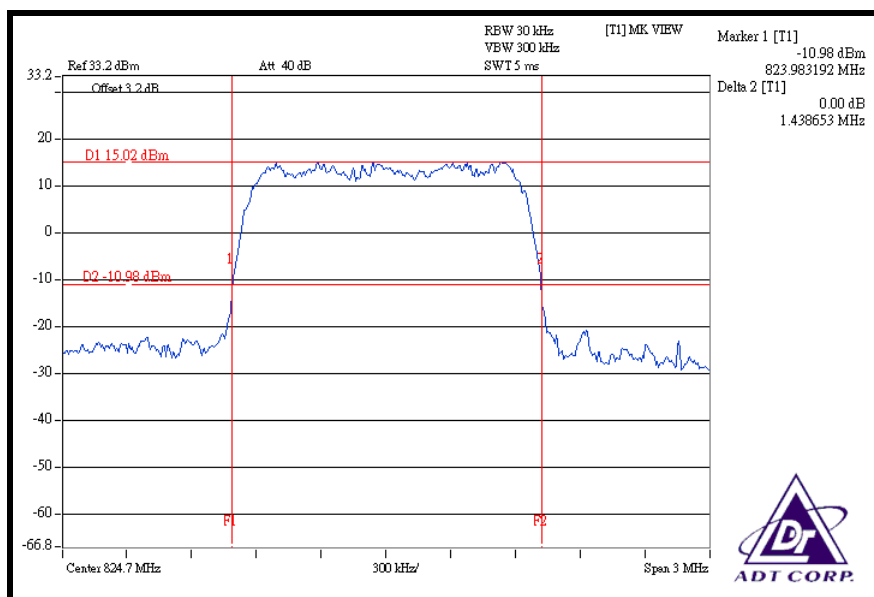

CH 384

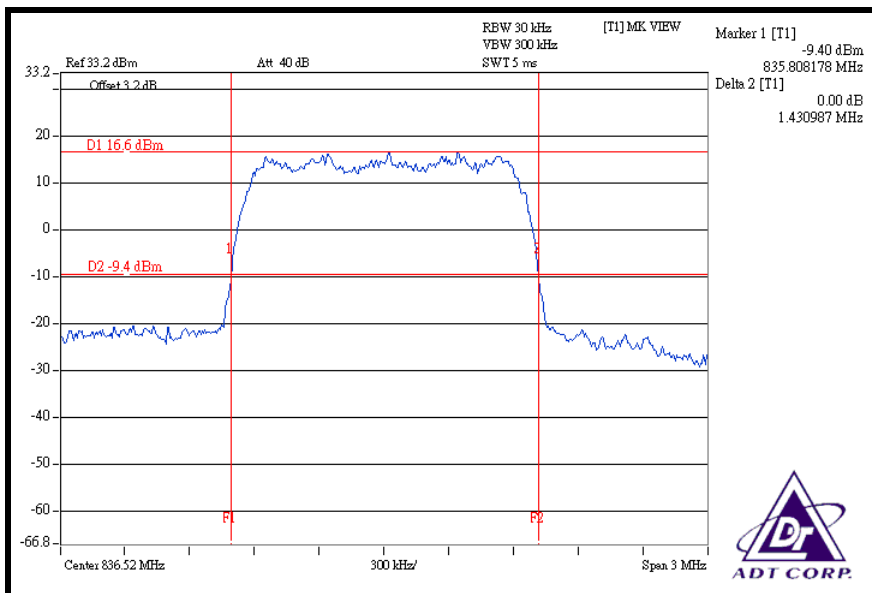

CH 777

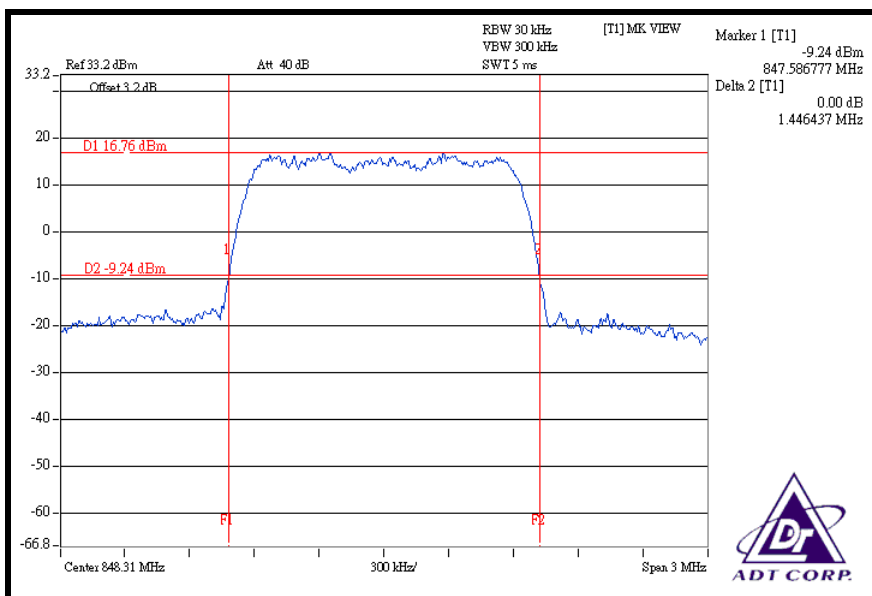

FOR EV-DO FTAP:

FREQUENCY (MHz)	MAX. OUTPUT POWER -26 dBc BANDWIDTH (MHz)
824.7	1.433
836.5	1.433
848.3	1.439

CH 1013

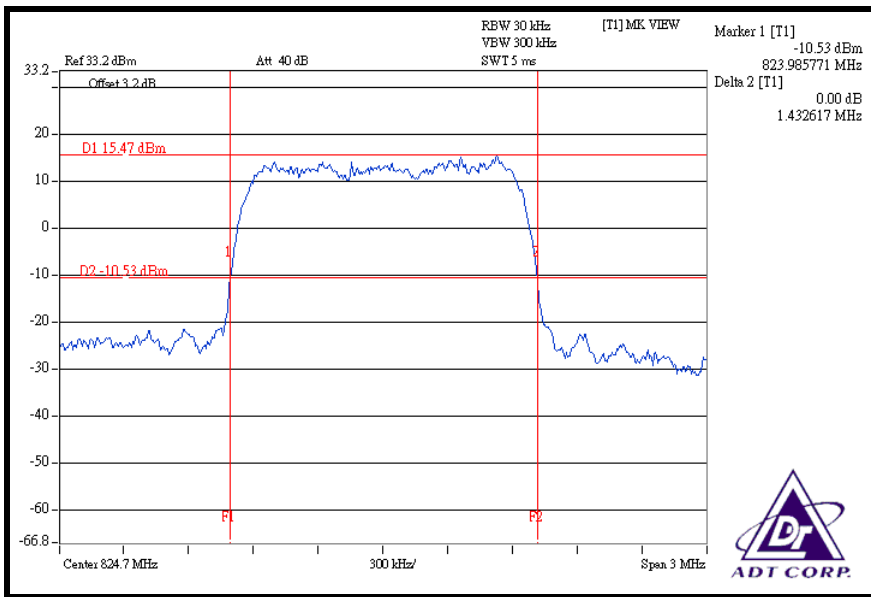

CH 384

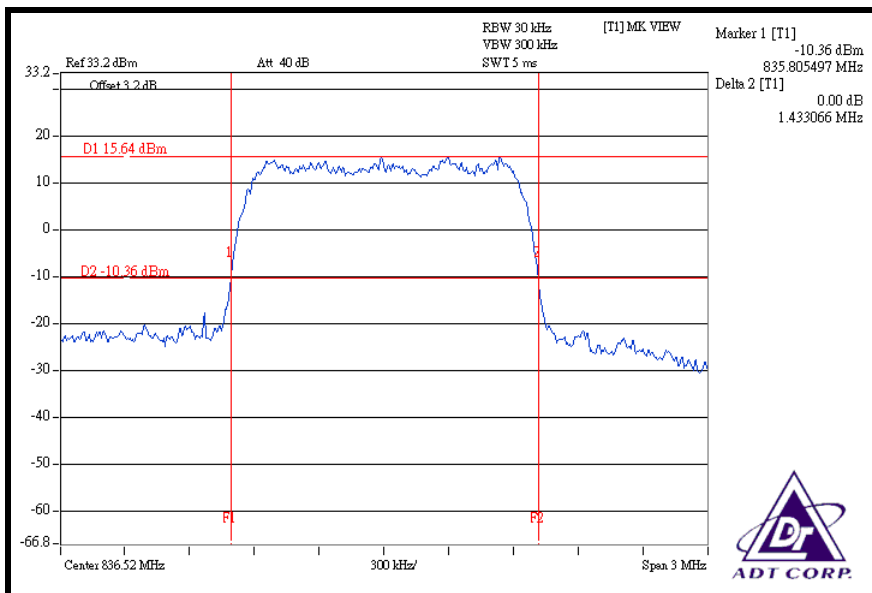

CH 777

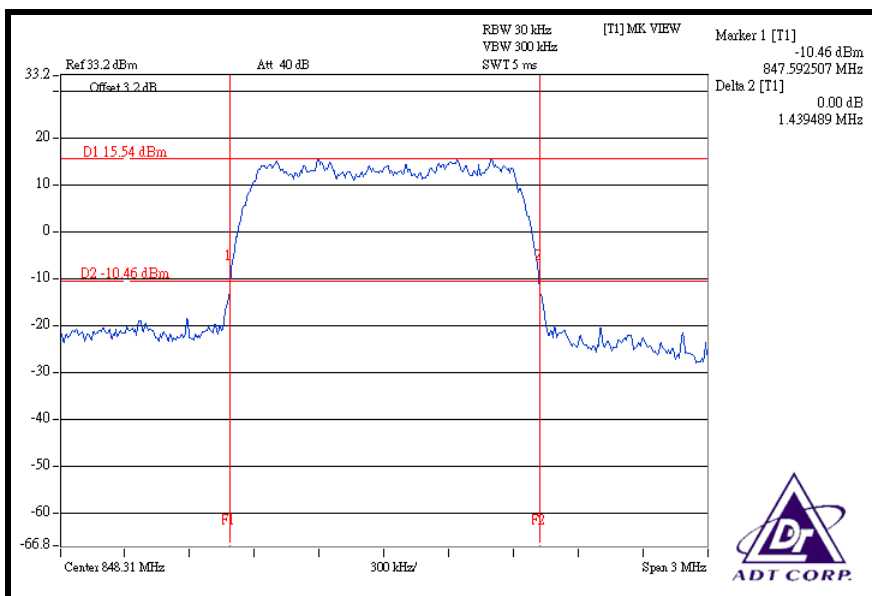

FOR EV-DO RTAP:

FREQUENCY (MHz)	MAX. OUTPUT POWER -26 dBc BANDWIDTH (MHz)
824.70	1.433
836.50	1.432
848.30	1.435

CH 1013

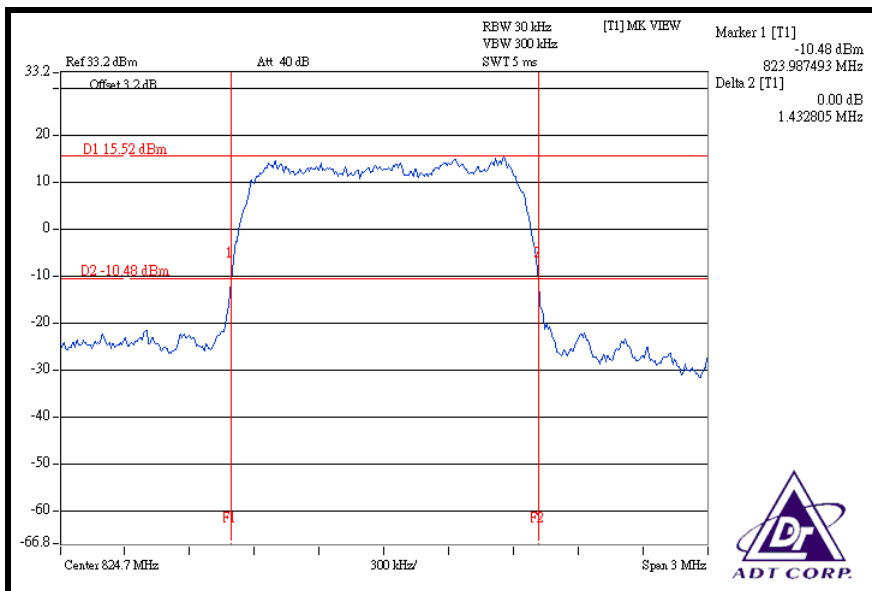

CH 384

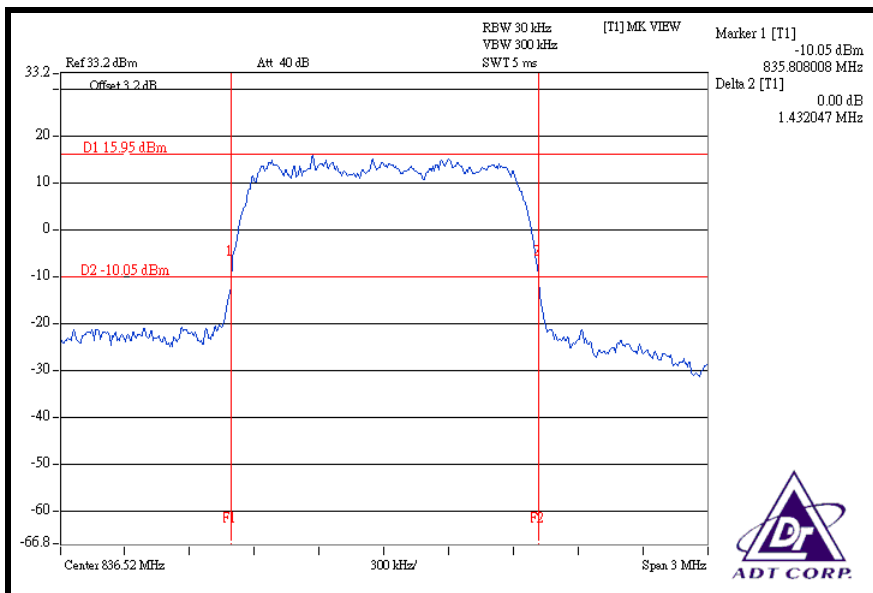

CH 777

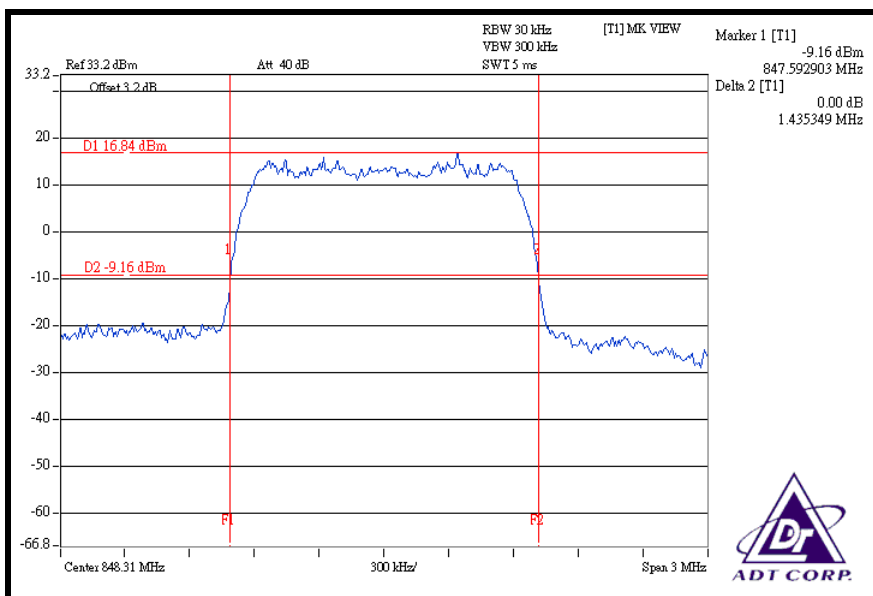

4.4 BAND EDGE MEASUREMENT

4.4.1 LIMITS OF BAND EDGE MEASUREMENT

According to FCC 22.917 specified that power of any emission outside of the authorized operating frequency ranges must be attenuated below the transmitting power (P) by a factor of at least $43 + 10 \log(P)$ dB. In the 1MHz bands immediately outside and adjacent to the frequency block a resolution bandwidth of at least one percent of the emission bandwidth of the fundamental emission of the transmitter may be employed.

4.4.2 TEST INSTRUMENTS

DESCRIPTION & MANUFACTURER	MODEL NO.	SERIAL NO.	CALIBRATED UNTIL
* ROHDE & SCHWARZ Spectrum Analyzer	E4446A	MY44360128	Dec. 06, 2008
* Mini-Circuits Power Splitter	ZAPD-4	400005	NA
* Hewlett Packard RF cable	8120-6192	01428251	NA
* JFW 20dB attenuation	50HF-020-SMA	NA	NA
* Suhner RF cable	Sucoflex104	204850/4	NA

- NOTE:** 1. The calibration interval of the above test instruments is 12 months. And the calibrations are traceable to NML/ROC and NIST/USA.
2. "*" = These equipments are used for the final measurement.

4.4.3 TEST SETUP

Same as Item 4.2.4 (Conducted Power Setup).

4.4.4 TEST PROCEDURES

- a. The EUT was set up for the maximum peak power with CDMA link data modulation. The power was measured with R&S Spectrum Analyzer. All measurements were done at 2 channels: 1013 and 777 (low and high operational frequency range).
- b. The band edge measurement used the power splitter via EUT RF power connector between simulation base station and spectrum analyzer. This splitter loss and cable loss is the worst loss 3.2dB in the transmitted path track.
- c. The center frequency of spectrum is the band edge frequency and span is 3MHz. RB of the spectrum is 15kHz and VB of the spectrum is 15kHz.
- d. Record the max trace plot into the test report.

4.4.5 EUT OPERATING CONDITION

- a. The EUT makes a phone call to the communication simulator.
- b. The communication simulator station system controlled an EUT to export maximum output power under transmission mode and specific channel frequency.

4.4.6 TEST RESULTS

LOWER BAND EDGE

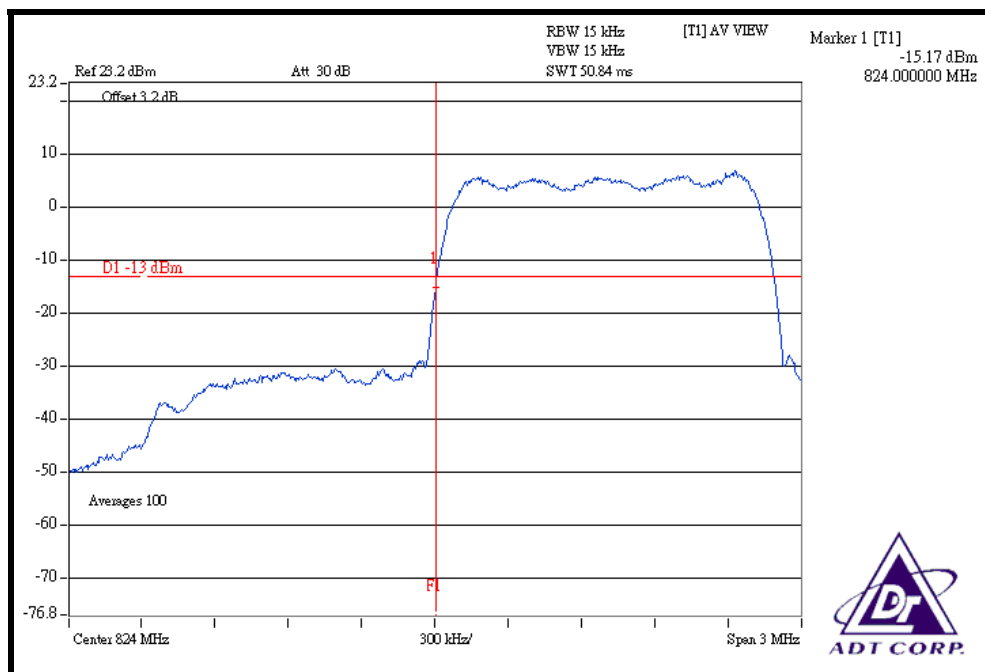

HIGHER BAND EDGE

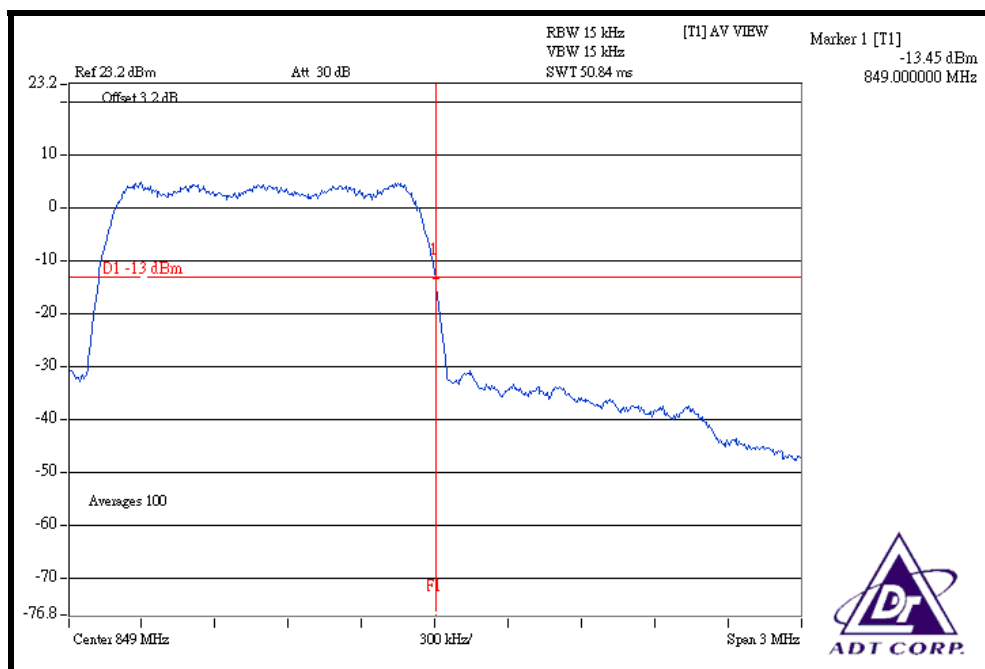



4.5 CONDUCTED SPURIOUS EMISSIONS

4.5.1 LIMITS OF CONDUCTED SPURIOUS EMISSIONS MEASUREMENT

In the FCC 22.917, On any frequency outside a licensee's frequency block within GSM850 spectrum, the power of any emission shall be attenuated below the transmitter power (P) by at least $43 + 10 \log (P)$ dB. The limit of emission equal to -13dBm .

4.5.2 TEST INSTRUMENTS

DESCRIPTION & MANUFACTURER	MODEL NO.	SERIAL NO.	CALIBRATED UNTIL
* ROHDE & SCHWARZ Spectrum Analyzer	FSP40	100040	Jun. 28, 2008
* Wainwright Instruments Band Reject Filter	WRCG1850/1910-183 0/1930-60/10SS	SN1	NA
* Wainwright Instruments High Pass Filter	WHK3.1/18G-10SS	SN1	NA
* Mini-Circuits Power Splitter	ZAPD-4	400005	NA
* Hewlett Packard RF cable	8120-6192	01428251	NA
* JFW 20dB attenuation	50HF-020-SMA	NA	NA
* Suhner RF cable	Sucoflex104	204850/4	NA

- NOTE:**
1. The calibration interval of the above test instruments is 12 months. And the calibrations are traceable to NML/ROC and NIST/USA.
 2. "*" = These equipments are used for the final measurement.

4.5.3 TEST PROCEDURE

- a. The EUT was set up for the maximum peak power with CDMA link data modulation. The power was measured with R&S Spectrum Analyzer. All measurements were done at 3 channels, 1013, 384 and 777 (low, middle and high operational frequency range.)
- b. The conducted spurious emission used the power splitter via EUT RF power connector between simulation base station and spectrum analyzer. This splitter loss and cable loss are the worst loss 3.2dB in the transmitted path track.
- c. When the spectrum scanned from 9kHz to 1GHz, it shall be connected to the band reject filter attenuated the carried frequency. The spectrum set RB=1MHz, VB=3MHz.
- d. When the spectrum scanned from 1GHz to 9GHz, it shall be connected to the high pass filter attenuated the carried frequency. The spectrum set RB=1MHz, VB=3MHz.

4.5.4 TEST SETUP

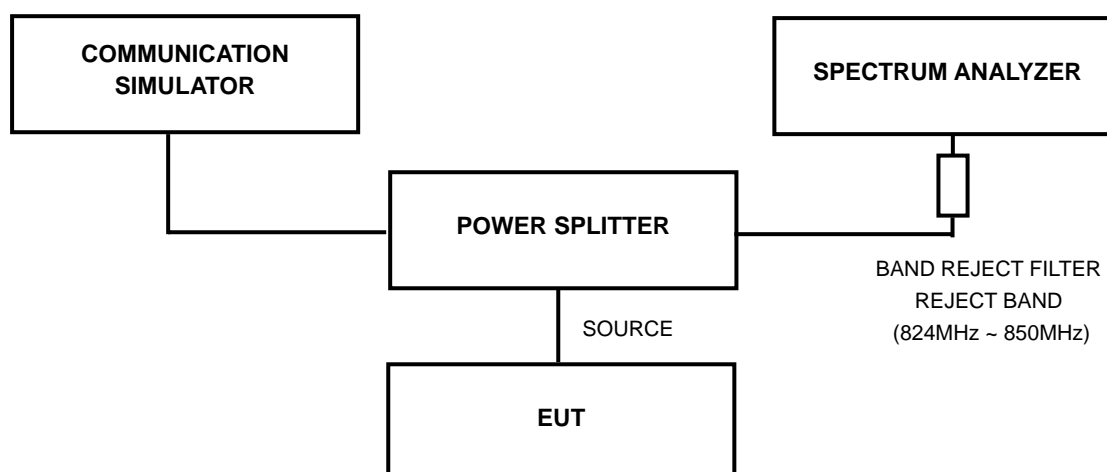

4.5.5 EUT OPERATING CONDITIONS

- a. The EUT makes a phone call to the communication simulator
- b. The communication simulator station system controlled a EUT to export maximum output power under transmission mode and specific channel frequency.

4.5.6 TEST RESULTS

CH 1013: 9kHz ~ 1GHz

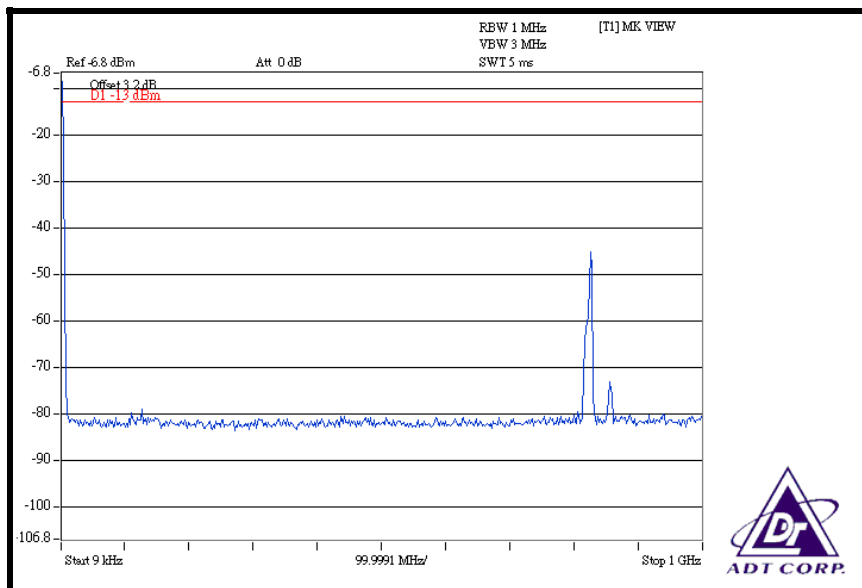

1GHz ~ 4GHz

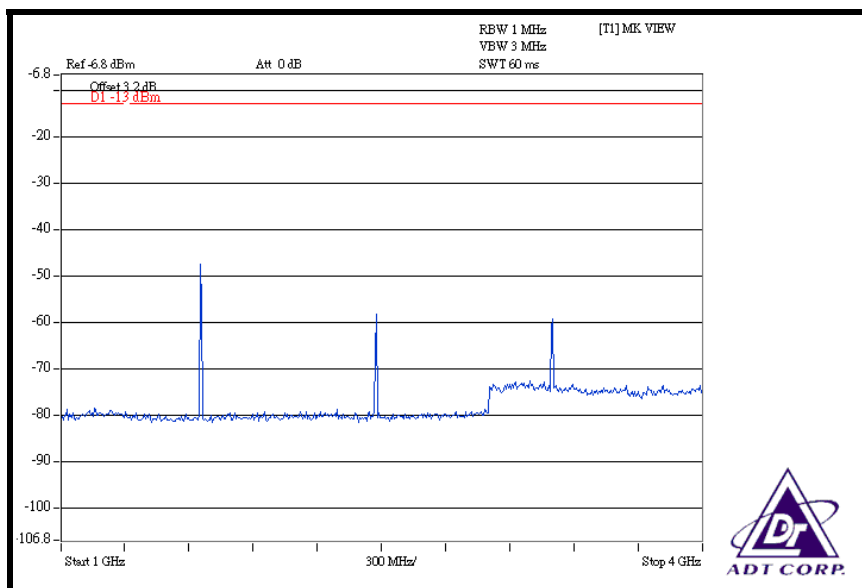

4GHz ~ 7GHz

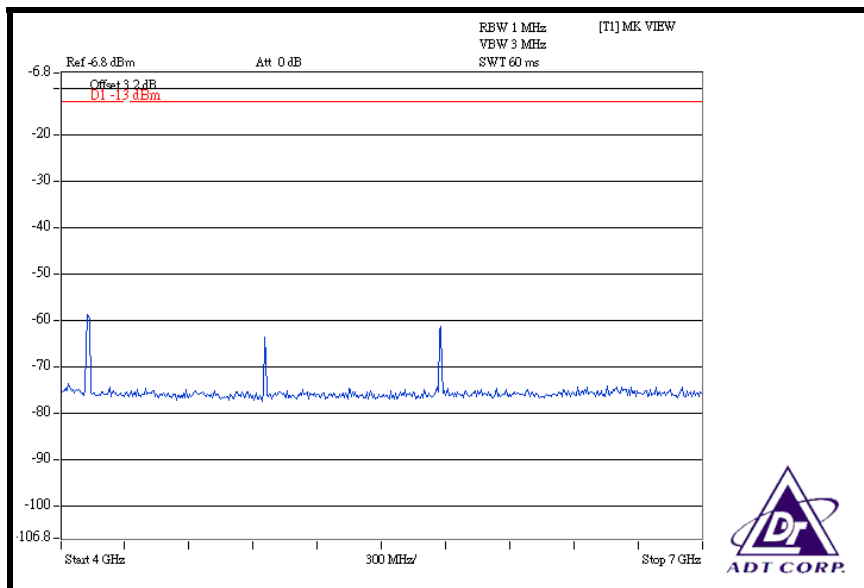

7GHz ~ 9GHz

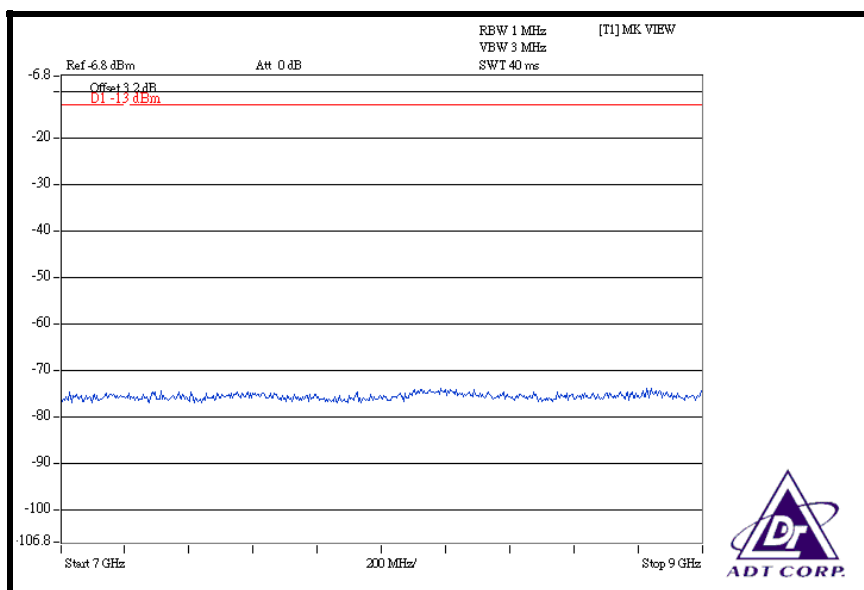

CH 384: 9kHz ~ 1GHz

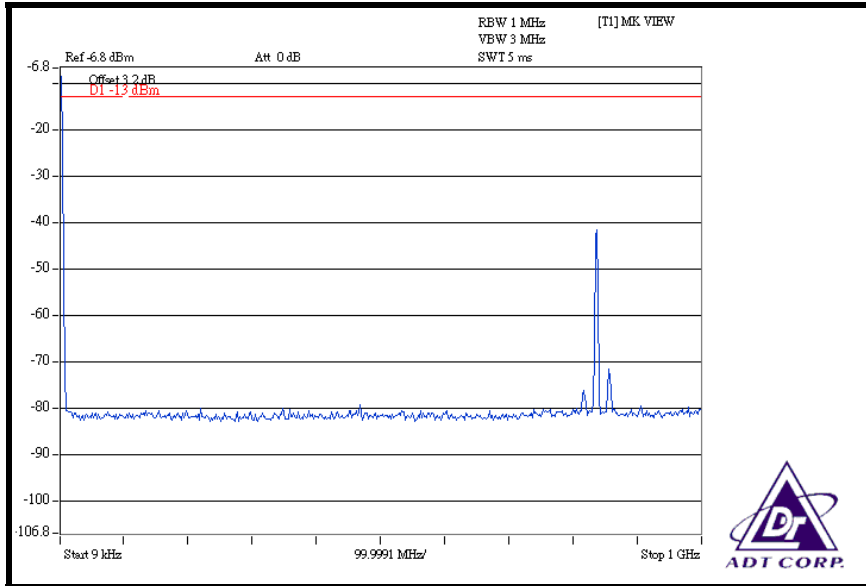

1GHz ~ 4GHz

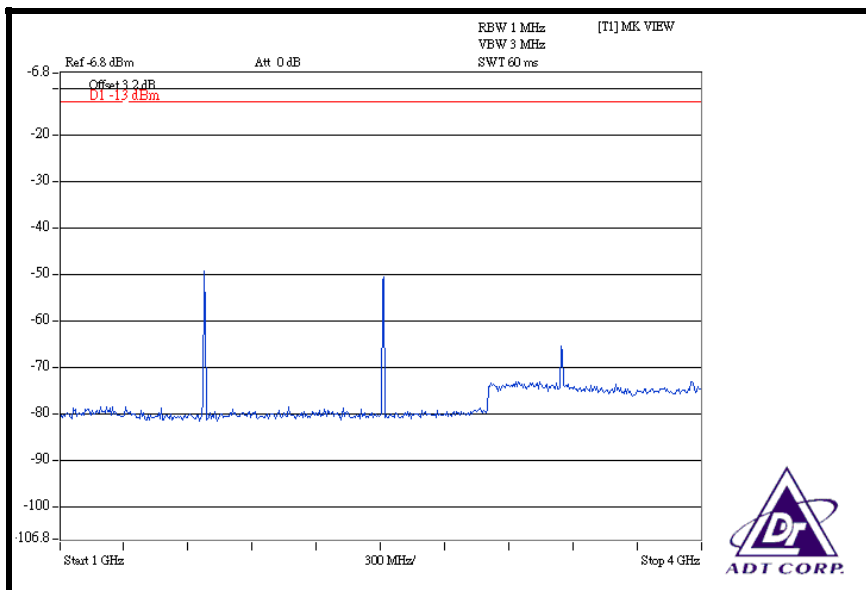

4GHz ~ 7GHz

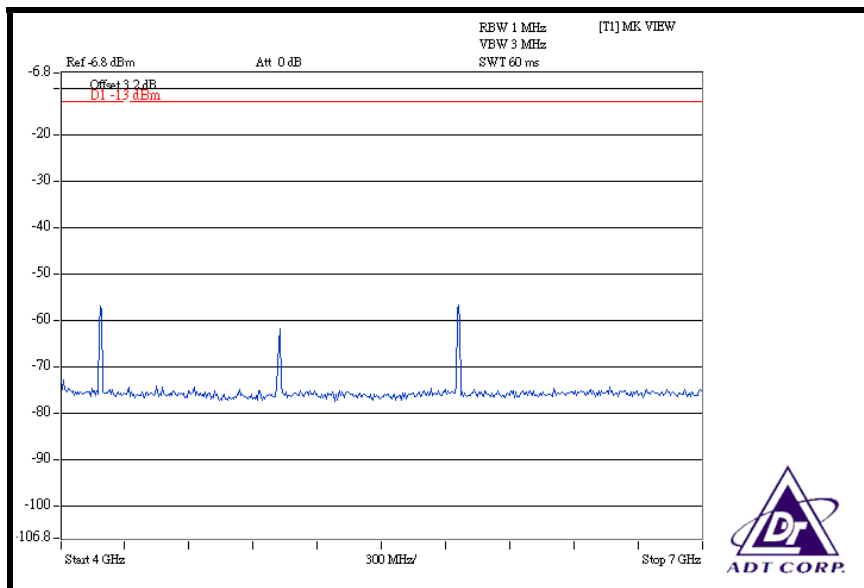

7GHz ~ 9GHz

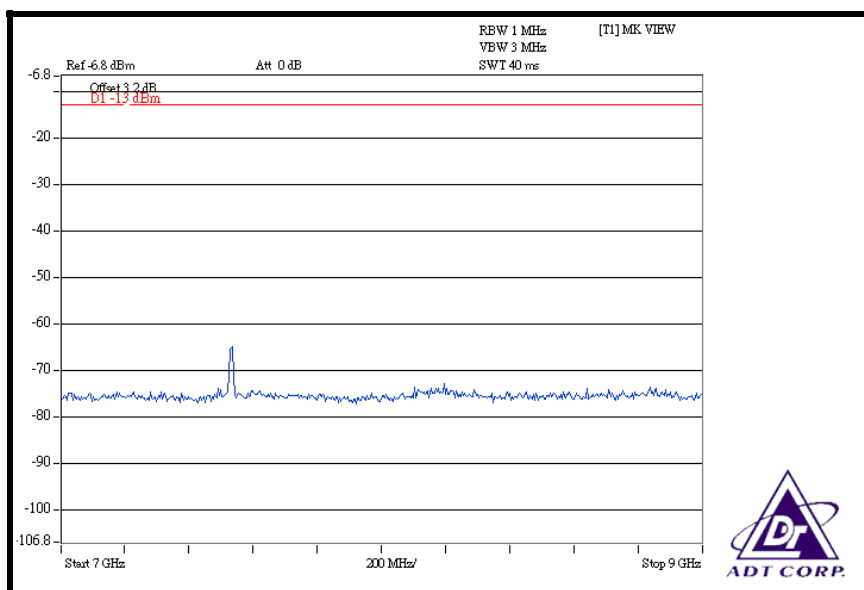

CH 777: 9kHz ~ 1GHz

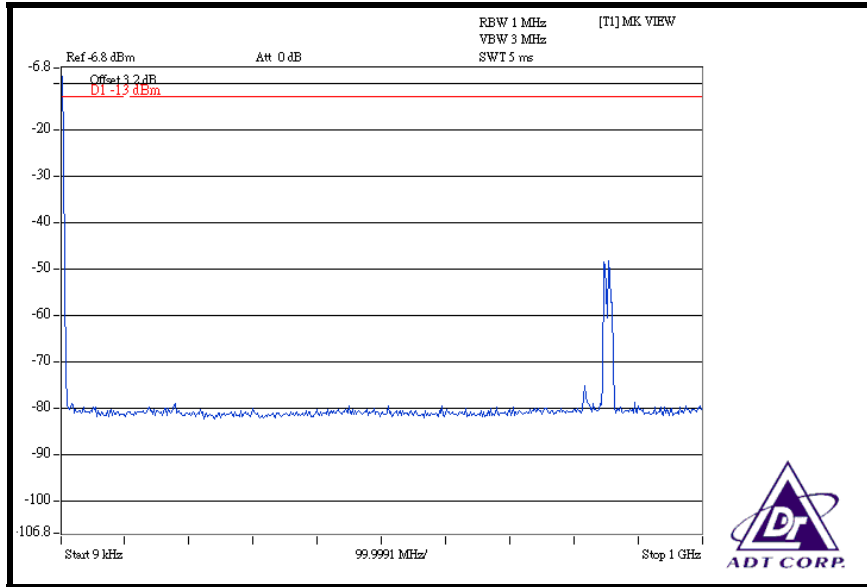

1GHz ~ 4GHz

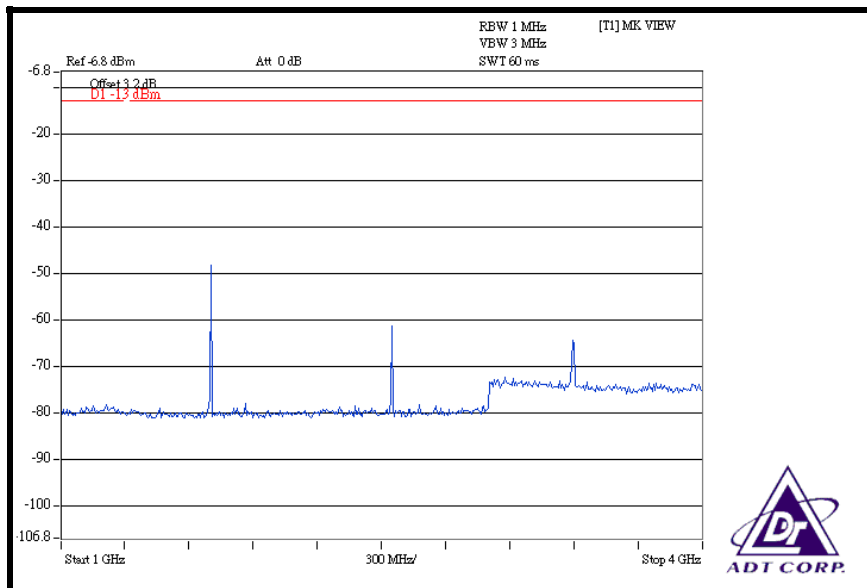

4GHz ~ 7GHz

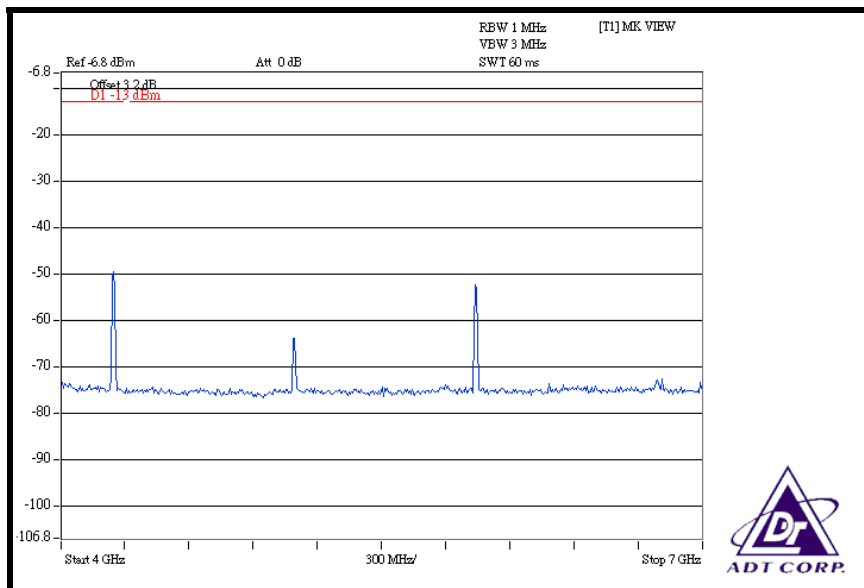

7GHz ~ 9GHz

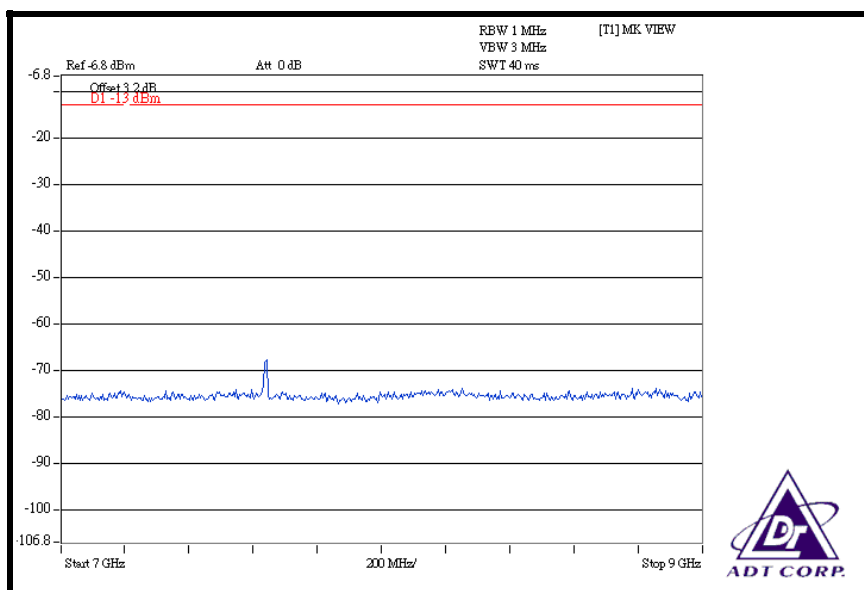

4.6 RADIATED EMISSION MEASUREMENT (BELOW 1GHz)

4.6.1 LIMITS OF RADIATED EMISSION MEASUREMENT

In the FCC 22.917, On any frequency outside a licensee's frequency block within GSM850 spectrum, the power of any emission shall be attenuated below the transmitter power (P) by at least $43 + 10 \log (P)$ dB. The limit of emission equal to -13 dBm. So the limit of emission is the same absolute specified line.

LIMIT (dBm)	EQUIVALENT FIELD STRENGTH AT 3m (dBuV/m) (NOTE)
-13	82.22

NOTE: The following formula is used to convert the equipment radiated power to field strength.

$$E = [1000000 \sqrt{(30P)}] / 3 \text{ uV/m, where P is Watts.}$$



4.6.2 TEST INSTRUMENTS

DESCRIPTION & MANUFACTURER	MODEL NO.	SERIAL NO.	CALIBRATED UNTIL
Test Receiver ROHDE & SCHWARZ	ESCI	100424	Jul. 27, 2008
Spectrum Analyzer Agilent	E4446A	MY44360128	Dec. 06, 2008
BILOG Antenna SCHWARZBECK	VULB9168	9168-160	May 01, 2009
HORN Antenna SCHWARZBECK	9120D	9120D-209	Jun. 28, 2008
HORN Antenna SCHWARZBECK	BBHA 9170	BBHA9170243	Dec. 24, 2008
Preamplifier Agilent	8447D	2944A10633	Oct. 28, 2008
Preamplifier Agilent	8449B	3008A01964	Oct. 23, 2008
RF signal cable HUBER+SUHNNER	SUCOFLEX 104	283402/4	Dec. 06, 2008
RF signal cable HUBER+SUHNNER	SUCOFLEX 104	251644/4	Dec. 06, 2008
Software ADT.	ADT_Radiated_V7.6	NA	NA
Antenna Tower inn-co GmbH	MA 4000	013303	NA
Antenna Tower Controller inn-co GmbH	CO2000	017303	NA
Turn Table ADT.	TT100.	TT93021703	NA
Turn Table Controller ADT.	SC100.	SC93021703	NA

- NOTE:**
1. The calibration interval of the above test instruments is 12 months and the calibrations are traceable to NML/ROC and NIST/USA.
 2. The test was performed in HwaYa Chamber 3.
 3. The horn antenna and HP preamplifier (model: 8449B) are used only for the measurement of emission frequency above 1GHz if tested.
 4. The FCC Site Registration No. is 988962.
 5. The IC Site Registration No. is IC3789B-3.

4.6.3 TEST PROCEDURES

- a. The EUT was placed on the top of a rotating table 0.8 meters above the ground. The table was rotated 360 degrees to determine the position of the highest radiation.
- b. The EUT was set 3 meters away from the receiving antenna, which was mounted on antenna tower and its position at 0.8 m above the ground.
- c. For each suspected emission, the EUT was arranged to its worst case and the rotatable table was turned from 0 degrees to 360 degrees to find the maximum reading and recorded the value.
- d. Repeat step a ~ c for horizontal polarization.

NOTE: The resolution bandwidth of spectrum analyzer is 1MHz and the video bandwidth is 3MHz.

4.6.4 DEVIATION FROM TEST STANDARD

No deviation

4.6.5 TEST SETUP

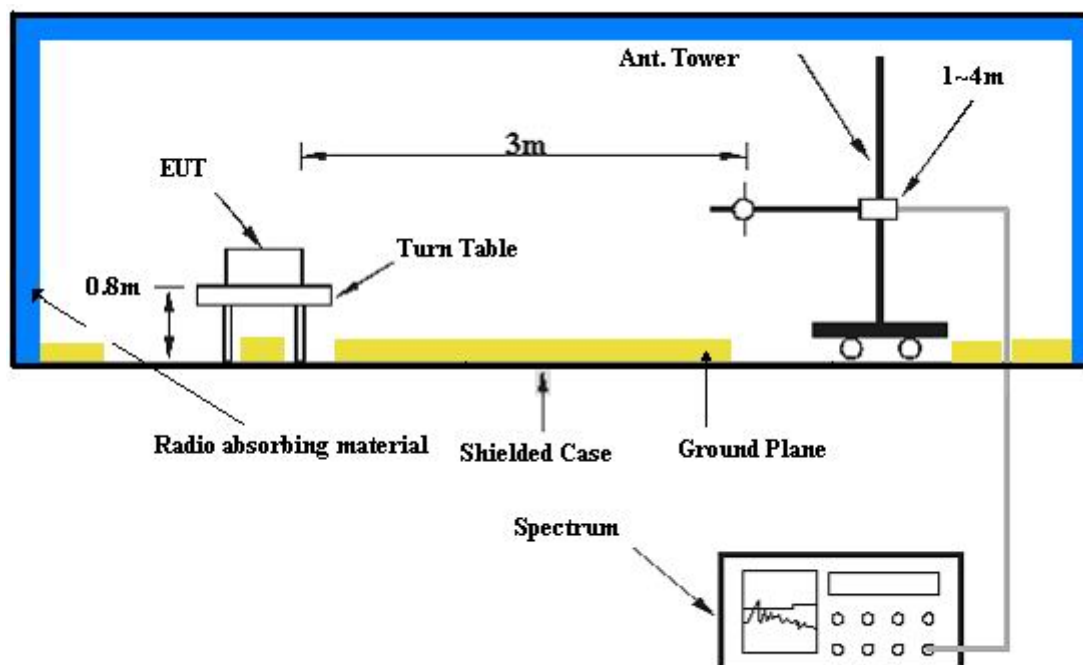

For the actual test configuration, please refer to the attached file (Test Setup Photo).

4.6.6 EUT OPERATING CONDITIONS

- The EUT makes a phone call to the communication simulator.
- The communication simulator station system controlled an EUT to export maximum output power under transmission mode and specific channel frequency.



4.6.7 TEST RESULTS

MODE	TX channel 1013	DETECTOR FUNCTION	Peak
FREQUENCY RANGE	Below 1000MHz	INPUT POWER (SYSTEM)	120Vac, 60Hz
ENVIRONMENTAL CONDITIONS	25deg. C, 65%RH, 980hPa	TESTED BY	Brad Wu

ANTENNA POLARITY & TEST DISTANCE: HORIZONTAL AT 3 M								
NO.	FREQ. (MHz)	EMISSION LEVEL (dBuV/m)	LIMIT (dBuV/m)	MARGIN (dB)	ANTENNA HEIGHT (m)	TABLE ANGLE (Degree)	RAW VALUE (dBuV)	CORRECTION FACTOR (dB/m)
1	125.25	36.77	82.22	-45.45	1.50 H	259	23.84	12.93
2	259.38	39.92	82.22	-42.30	1.50 H	181	26.37	13.56
3	269.10	40.73	82.22	-41.49	1.50 H	22	26.37	14.36
4	788.12	36.88	82.22	-45.34	1.00 H	325	11.06	25.83
5	826.99	37.24	82.22	-44.98	1.00 H	304	10.78	26.46
6	865.87	38.09	82.22	-44.13	1.50 H	79	10.92	27.16
7	900.86	38.79	82.22	-43.43	1.50 H	115	11.18	27.61
8	910.58	37.95	82.22	-44.27	1.50 H	19	10.19	27.75
9	968.90	38.99	82.22	-43.23	1.50 H	43	10.54	28.45
10	1000.00	39.84	82.22	-42.38	1.50 H	10	11.18	28.67

ANTENNA POLARITY & TEST DISTANCE: VERTICAL AT 3 M								
NO.	FREQ. (MHz)	EMISSION LEVEL (dBuV/m)	LIMIT (dBuV/m)	MARGIN (dB)	ANTENNA HEIGHT (m)	TABLE ANGLE (Degree)	RAW VALUE (dBuV)	CORRECTION FACTOR (dB/m)
1	121.36	47.64	82.22	-34.58	1.00 V	64	34.92	12.72
2	129.14	42.45	82.22	-39.77	1.50 V	1	29.30	13.15
3	255.49	47.93	82.22	-34.29	1.00 V	52	34.40	13.53
4	269.10	47.43	82.22	-34.79	1.00 V	64	33.07	14.36
5	630.66	40.70	82.22	-41.52	1.00 V	346	17.55	23.15
6	768.68	41.10	82.22	-41.12	1.00 V	1	15.36	25.74
7	801.72	39.37	82.22	-42.85	1.00 V	10	13.45	25.92
8	865.87	39.28	82.22	-42.94	1.00 V	91	12.12	27.16
9	900.86	40.20	82.22	-42.02	1.00 V	94	12.59	27.61
10	926.13	39.32	82.22	-42.90	2.00 V	331	11.35	27.98
11	966.95	39.94	82.22	-42.28	1.00 V	193	11.50	28.44
12	1000.00	39.26	82.22	-42.96	1.00 V	304	10.59	28.67

NOTE:

1. Emission level (dBuV/m) = Raw Value (dBuV) + Correction Factor (dB).
2. Correction Factor (dB/m) = Antenna Factor (dB/m) + Cable Factor (dB).
3. The other emission levels were very low against the limit.
4. Margin value = Emission level – Limit value.
5. This is valid for all 3 channels.



4.7 EFFECTIVE RADIATED POWER MEASUREMENT (ABOVE 1GHz)

4.7.1 LIMITS OF RADIATED EMISSION MEASUREMENT

In the FCC 22.917 (a), On any frequency outside a licensee's frequency block within GSM spectrum, the power of any emission shall be attenuated below the transmitter power (P) by at least $43 + 10 \log (P)$ dB. The limit of emission equal to -13dBm .



4.7.2 TEST INSTRUMENTS

DESCRIPTION & MANUFACTURER	MODEL NO.	SERIAL NO.	CALIBRATED UNTIL
Test Receiver ROHDE & SCHWARZ	ESCI	100424	Jul. 27, 2008
Spectrum Analyzer Agilent	E4446A	MY44360128	Dec. 06, 2008
BILOG Antenna SCHWARZBECK	VULB9168	9168-160	May 01, 2009
HORN Antenna SCHWARZBECK	9120D	9120D-209	Jun. 28, 2008
HORN Antenna SCHWARZBECK	BBHA 9170	BBHA9170243	Dec. 24, 2008
Preamplifier Agilent	8447D	2944A10633	Oct. 28, 2008
Preamplifier Agilent	8449B	3008A01964	Oct. 23, 2008
RF signal cable HUBER+SUHNNER	SUCOFLEX 104	283402/4	Dec. 06, 2008
RF signal cable HUBER+SUHNNER	SUCOFLEX 104	251644/4	Dec. 06, 2008
Software ADT.	ADT_Radiated_V7.6	NA	NA
Antenna Tower inn-co GmbH	MA 4000	013303	NA
Antenna Tower Controller inn-co GmbH	CO2000	017303	NA
Turn Table ADT.	TT100.	TT93021703	NA
Turn Table Controller ADT.	SC100.	SC93021703	NA

- NOTE:**
1. The calibration interval of the above test instruments is 12 months and the calibrations are traceable to NML/ROC and NIST/USA.
 2. The test was performed in HwaYa Chamber 3.
 3. The horn antenna and HP preamplifier (model: 8449B) are used only for the measurement of emission frequency above 1GHz if tested.
 4. The FCC Site Registration No. is 988962.
 5. The IC Site Registration No. is IC3789B-3.

4.7.3 TEST PROCEDURES

- a. The EUT was placed on the top of a rotating table 0.8 meters above the ground. The table was rotated 360 degrees to determine the position of the highest radiation.
- b. The EUT was set 3 meters away from the receiving antenna, which was mounted on antenna tower and its position at 0.8 m above the ground.
- c. For each suspected emission, the EUT was arranged to its worst case and the rotatable table was turned from 0 degrees to 360 degrees to find the maximum reading and recorded the value.
- d. The EUT is replaced by a horn antenna connected to a signal generator tuned to the frequency of emission.
- e. The signal generator level has to be adjusted to have the same emission nature.
- f. The radiated power can be calculated via the factor and antenna gain.
- g. Repeat step a ~ f for horizontal polarization.

NOTE: The resolution bandwidth of spectrum analyzer is 1MHz and the video bandwidth is 3MHz.

4.7.4 DEVIATION FROM TEST STANDARD

No deviation

4.7.5 TEST SETUP

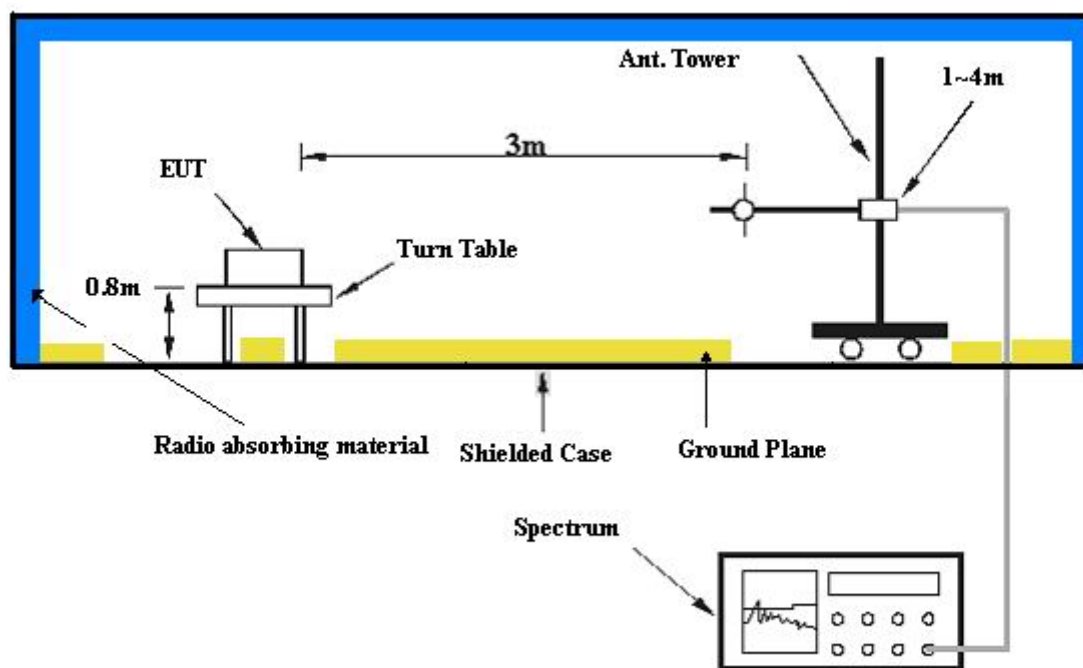

For the actual test configuration, please refer to the attached file (Test Setup Photo).

4.7.6 EUT OPERATING CONDITIONS

- a. The EUT makes a phone call to the communication simulator.
- b. The communication simulator station system controlled an EUT to export maximum output power under transmission mode and specific channel frequency.



4.7.7 TEST RESULTS

MODE	Channel 1013	FREQUENCY RANGE	Above 1000MHz
INPUT POWER (SYSTEM)	120Vac, 60Hz	ENVIRONMENTAL CONDITIONS	23deg°C, 60%RH, 988hPa
TESTED BY	Dean Wang		

ANTENNA POLARITY & TEST DISTANCE: HORIZONTAL AT 3 m						
NO.	FREQ. (MHz)	EMISSION LEVEL (dBuV)	LIMIT (dBm)	S.G POWER VALUE (dBm)	CORRECTION FACTOR (dB)	POWER VALUE (dBm)
1	1649.40	44.79	-13.00	-60.91	10.12	-50.79
2	2474.10	50.01	-13.00	-56.44	11.49	-44.95

ANTENNA POLARITY & TEST DISTANCE: VERTICAL AT 3 m						
NO.	FREQ. (MHz)	EMISSION LEVEL (dBuV)	LIMIT (dBm)	S.G POWER VALUE (dBm)	CORRECTION FACTOR (dB)	POWER VALUE (dBm)
1	1649.40	41.00	-13.00	-63.98	10.12	-53.86
2	2474.10	54.44	-13.00	-51.76	11.49	-40.27

NOTE: Power Value (dBum) = S.G Power Value (dBm) + Correction Factor (dB).



MODE	Channel 384	FREQUENCY RANGE	Above 1000MHz
INPUT POWER (SYSTEM)	120Vac, 60Hz	ENVIRONMENTAL CONDITIONS	23deg°C, 60%RH, 988hPa
TESTED BY	Dean Wang		

ANTENNA POLARITY & TEST DISTANCE: HORIZONTAL AT 3 m						
NO.	FREQ. (MHz)	EMISSION LEVEL (dBuV)	LIMIT (dBm)	S.G POWER VALUE (dBm)	CORRECTION FACTOR (dB)	POWER VALUE (dBm)
1	1673.04	44.36	-13.00	-60.27	10.12	-50.15
2	2509.56	52.01	-13.00	-54.45	11.49	-42.96

ANTENNA POLARITY & TEST DISTANCE: VERTICAL AT 3 m						
NO.	FREQ. (MHz)	EMISSION LEVEL (dBuV)	LIMIT (dBm)	S.G POWER VALUE (dBm)	CORRECTION FACTOR (dB)	POWER VALUE (dBm)
1	1673.04	47.39	-13.00	-58.25	10.12	-48.13
2	2509.56	50.58	-13.00	-56.56	11.49	-45.07

NOTE: Power Value (dBum) = S.G Power Value (dBm) + Correction Factor (dB).



MODE	Channel 777	FREQUENCY RANGE	Above 1000MHz
INPUT POWER (SYSTEM)	120Vac, 60Hz	ENVIRONMENTAL CONDITIONS	23deg°C, 60%RH, 988hPa
TESTED BY	Dean Wang		

ANTENNA POLARITY & TEST DISTANCE: HORIZONTAL AT 3 m						
NO.	FREQ. (MHz)	EMISSION LEVEL (dBuV)	LIMIT (dBm)	S.G POWER VALUE (dBm)	CORRECTION FACTOR (dB)	POWER VALUE (dBm)
1	1696.62	46.81	-13.00	-58.15	10.17	-47.98
2	2544.93	45.64	-13.00	-60.43	11.49	-48.94

ANTENNA POLARITY & TEST DISTANCE: VERTICAL AT 3 m						
NO.	FREQ. (MHz)	EMISSION LEVEL (dBuV)	LIMIT (dBm)	S.G POWER VALUE (dBm)	CORRECTION FACTOR (dB)	POWER VALUE (dBm)
1	1696.62	49.57	-13.00	-55.33	10.17	-45.16
2	2544.93	47.32	-13.00	-58.77	11.49	-47.28

NOTE: Power Value (dBum) = S.G Power Value (dBm) + Correction Factor (dB).



5 INFORMATION ON THE TESTING LABORATORIES

We, ADT Corp., were founded in 1988 to provide our best service in EMC, Radio, Telecom and Safety consultation. Our laboratories are accredited and approved by the following approval agencies according to ISO/IEC 17025.

USA	FCC, UL, A2LA
GERMANY	TUV Rheinland
JAPAN	VCCI
NORWAY	NEMKO
CANADA	INDUSTRY CANADA , CSA
R.O.C.	TAF, BSMI, NCC
NETHERLANDS	Telefication
SINGAPORE	GOST-ASIA (MOU)
RUSSIA	CERTIS (MOU)

Copies of accreditation certificates of our laboratories obtained from approval agencies can be downloaded from our web site: www.adt.com.tw/index.5/phtml.

If you have any comments, please feel free to contact us at the following:

Linko EMC/RF Lab:

Tel: 886-2-26052180

Fax: 886-2-26051924

Hsin Chu EMC/RF Lab:

Tel: 886-3-5935343

Fax: 886-3-5935342

Hwa Ya EMC/RF/Safety/Telecom Lab:

Tel: 886-3-3183232

Fax: 886-3-3185050

Web Site: www.adt.com.tw

The address and road map of all our labs can be found in our web site also.

6 APPENDIX A – MODIFICATIONS RECORDERS FOR ENGINEERING CHANGES TO THE EUT BY THE LAB

No any modifications are made to the EUT by the lab during the test.