



FCC TEST REPORT (FOR WIRELESS LAN)

REPORT NO.: RF970604L10-2

MODEL NO.: RAPH800

RECEIVED: Jun. 04, 2008

TESTED: Jun. 06 ~ Jun. 12, 2008

ISSUED: Jun. 16, 2008

APPLICANT: High Tech Computer Corp.

ADDRESS: 23, Hsin-Hua Rd., Taoyuan, 330, Taiwan, R.O.C.

ISSUED BY: Advance Data Technology Corporation

LAB ADDRESS: No. 47, 14th Ling, Chia Pau Tsuen, Lin Kou Hsiang
244, Taipei Hsien, Taiwan, R.O.C.

TEST LOCATION: No. 19, Hwa Ya 2nd Rd., Wen Hwa Tsuen, Kwei
Shan Hsiang, Taoyuan Hsien 333, Taiwan, R.O.C.

This test report consists of 60 pages in total. It may be duplicated completely for legal use with the approval of the applicant. It should not be reproduced except in full, without the written approval of our laboratory. The client should not use it to claim product endorsement by TAF, A2LA or any government agencies. The test results in the report only apply to the tested sample.





TABLE OF CONTENTS

1.	CERTIFICATION.....	4
2.	SUMMARY OF TEST RESULTS	5
2.1	MEASUREMENT UNCERTAINTY.....	5
3.	GENERAL INFORMATION.....	6
3.1	GENERAL DESCRIPTION OF EUT	6
3.2	DESCRIPTION OF TEST MODES	8
3.2.1	CONFIGURATION OF SYSTEM UNDER TEST	9
3.2.2	TEST MODE APPLICABILITY AND TESTED CHANNEL DETAIL	10
3.3.3	GENERAL DESCRIPTION OF APPLIED STANDARDS	12
3.3.4	DESCRIPTION OF SUPPORT UNITS	13
4.	TEST TYPES AND RESULTS	14
4.2	RADIATED EMISSION MEASUREMENT	14
4.2.1	LIMITS OF RADIATED EMISSION MEASUREMENT	14
4.2.2	TEST INSTRUMENTS.....	15
4.2.3	TEST PROCEDURES	16
4.2.4	DEVIATION FROM TEST STANDARD.....	16
4.2.5	TEST SETUP.....	17
4.2.6	EUT OPERATING CONDITIONS	17
4.2.7	TEST RESULTS	18
4.1	CONDUCTED EMISSION MEASUREMENT	26
4.1.1	LIMITS OF CONDUCTED EMISSION MEASUREMENT	26
4.1.2	TEST INSTRUMENTS.....	26
4.1.3	TEST PROCEDURES	27
4.1.4	DEVIATION FROM TEST STANDARD.....	27
4.1.5	TEST SETUP.....	28
4.1.6	EUT OPERATING CONDITIONS	28
4.1.7	TEST RESULTS	29
4.3	6dB BANDWIDTH MEASUREMENT.....	33
4.3.1	LIMITS OF 6dB BANDWIDTH MEASUREMENT	33
4.3.2	TEST INSTRUMENTS.....	33
4.3.3	TEST PROCEDURE.....	33
4.3.4	DEVIATION FROM TEST STANDARD.....	33
4.3.5	TEST SETUP.....	34
4.3.6	EUT OPERATING CONDITIONS	34
4.3.7	TEST RESULTS	35
4.4	MAXIMUM PEAK OUTPUT POWER.....	39
4.4.1	LIMITS OF MAXIMUM PEAK OUTPUT POWER MEASUREMENT	39
4.4.2	TEST INSTRUMENTS.....	39
4.4.3	TEST PROCEDURES	40
4.4.4	DEVIATION FROM TEST STANDARD.....	40
4.4.5	TEST SETUP.....	40
4.4.6	EUT OPERATING CONDITIONS	40
4.4.7	TEST RESULTS	41
4.5	POWER SPECTRAL DENSITY MEASUREMENT	42
4.5.1	LIMITS OF POWER SPECTRAL DENSITY MEASUREMENT	42
4.5.2	TEST INSTRUMENTS.....	42
4.5.3	TEST PROCEDURE.....	42
4.5.4	DEVIATION FROM TEST STANDARD.....	42



4.5.5	TEST SETUP	43
4.5.6	EUT OPERATING CONDITION.....	43
4.5.7	TEST RESULTS	44
4.6	BAND EDGES MEASUREMENT	48
4.6.1	LIMITS OF BAND EDGES MEASUREMENT	48
4.6.2	TEST INSTRUMENTS.....	48
4.6.3	TEST PROCEDURE.....	48
4.6.4	DEVIATION FROM TEST STANDARD.....	48
4.6.5	EUT OPERATING CONDITION.....	48
4.6.6	TEST RESULTS	49
4.7	ANTENNA REQUIREMENT	57
4.7.1	STANDARD APPLICABLE	57
4.7.2	ANTENNA CONNECTED CONSTRUCTION	57
5.	PHOTOGRAPHS OF THE TEST CONFIGURATION.....	58
6.	INFORMATION ON THE TESTING LABORATORIES	59
7.	APPENDIX A - MODIFICATIONS RECORDERS FOR ENGINEERING CHANGES TO THE EUT BY THE LAB.....	60



1. CERTIFICATION

PRODUCT: Pocket PC Phone

MODEL: RAPH800

APPLICANT: High Tech Computer Corp.

TESTED: Jun. 06 ~ Jun. 12, 2008

TEST SAMPLE: ENGINEERING SAMPLE

STANDARDS: **FCC Part 15, Subpart C (Section 15.247)**

ANSI C63.4-2003

The above equipment (model: RAPH800) has been tested by **Advance Data Technology Corporation**, and found compliance with the requirement of the above standards. The test record, data evaluation & Equipment Under Test (EUT) configurations represented herein are true and accurate accounts of the measurements of the sample's EMC characteristics under the conditions specified in this report.

PREPARED BY : Rennie Wang , **DATE:** Jun. 16, 2008
Rennie Wang / Senior Specialist

TECHNICAL ACCEPTANCE : Long Chen , **DATE:** Jun. 16, 2008
Responsible for RF Long Chen / Senior Engineer

APPROVED BY : Gary Chang , **DATE:** Jun. 16, 2008
Gary Chang / Assistant Manager

2. SUMMARY OF TEST RESULTS

The EUT has been tested according to the following specifications:

APPLIED STANDARD: FCC Part 15, Subpart C			
STANDARD SECTION	TEST TYPE AND LIMIT	RESULT	REMARK
15.207	AC Power Conducted Emission	PASS	Meet the requirement of limit Minimum passing margin is -16.32dB at 0.923MHz.
15.247(a)(2)	Spectrum Bandwidth of a Direct Sequence Spread Spectrum System Limit: min. 500kHz	PASS	Meet the requirement of limit
15.247(b)	Maximum Peak Output Power Limit: max. 30dBm	PASS	Meet the requirement of limit
15.247(d)	Radiated Emissions Limit: Table 15.209	PASS	Meet the requirement of limit. Minimum passing margin is -1.41dB at 2390.00MHz.
15.247(e)	Power Spectral Density Limit: max. 8dBm	PASS	Meet the requirement of limit
15.247(d)	Band Edge Measurement Limit: 20dB less than the peak value of fundamental frequency	PASS	Meet the requirement of limit

2.1 MEASUREMENT UNCERTAINTY

Where relevant, the following measurement uncertainty levels have been estimated for tests performed on the EUT as specified in CISPR 16-4-2:

MEASUREMENT	FREQUENCY	UNCERTAINTY
Conducted emissions	9kHz ~ 30MHz	2.44 dB
Radiated emissions	30MHz ~ 200MHz	3.34 dB
	200MHz ~ 1000MHz	3.35 dB
	1GHz ~ 18GHz	2.26 dB
	18GHz ~ 40GHz	1.94 dB

This uncertainty represents an expanded uncertainty expressed at approximately the 95% confidence level using a coverage factor of k=2.

3. GENERAL INFORMATION

3.1 GENERAL DESCRIPTION OF EUT

EUT	Pocket PC Phone
MODEL NO.	RAPH800
FCC ID	NM8RAPH800
POWER SUPPLY	3.7Vdc from rechargeable lithium battery 5.0Vdc from power adapter 5.0Vdc from host equipment
MODULATION TYPE	Wireless LAN: CCK, DQPSK, DBPSK for DSSS 64QAM, 16QAM, QPSK, BPSK for OFDM Bluetooth: GFSK, $\pi/4$ -DQPSK, 8DPSK
MODULATION TECHNOLOGY	DSSS, OFDM, FHSS
TRANSFER RATE	Wireless LAN: 802.11b: 11/5.5/2/1Mbps 802.11g: 54/48/36/24/18/12/9/6Mbps Bluetooth: 1/2/3Mbps
FREQUENCY RANGE	2400 ~ 2483.5MHz
NUMBER OF CHANNEL	Wireless LAN: 11 Bluetooth: 79
CHANNEL SPACING	Wireless LAN: 5MHz Bluetooth: 1MHz
OUTPUT POWER	Wireless LAN: 103.039mW Bluetooth: 0.989mW
ANTENNA TYPE	Wireless LAN: PIFA antenna with 1dBi gain Bluetooth: PIFA antenna with 1dBi gain
DATA CABLE	1.25m shielded USB cable without core 0.10m shielded 4-in-1 cable without core
I/O PORTS	Refer to user's manual
ACCESSORY DEVICES	Adapter, Battery, Earphone (Brand: hTC, model: HS S300, 1.90m), Pouch

NOTE:

1. The EUT is a Pocket PC Phone. The functions of EUT listed as below:

	TEST STANDARD	REFERENCE REPORT
WLAN 802.11b/g	FCC Part 15	RF970604L10-2
BLUETOOTH		RF970604L10-3
CDMA 850	FCC Part 22	RF970604L10
CDMA 1900	FCC Part 24	RF970604L10-1

2. The communicated functions of EUT listed as below:

		850MHz	1900MHz	With WLAN 802.11b/g + BT 2.0 with EDR + AGPS
3G	CDMA	V	V	
	1*EVDO	V	V	
	1*RTT	V	V	
	IS-95A/B	V	V	

3. The EUT has lithium battery listed as below:

BRAND:	hTC
MODEL:	DIAM171
RATING:	3.7Vdc, 1340mAh

4. The EUT was operated with following power adapter:

BRAND:	hTC
MODEL:	TC P300
INPUT:	100-240Vac, 0.2A, 50-60Hz
OUTPUT:	5Vdc, 1A
POWER LINE:	1.25m non-shielded cable without core

5. The EUT used the same antenna for Wireless LAN & Bluetooth function, but the two functions **CAN NOT** use at the same time.

6. The above EUT information was declared by manufacturer and for more detailed features description, please refer to the manufacturer's specifications or User's Manual.

3.2 DESCRIPTION OF TEST MODES

11 channels are provided to the EUT:

CHANNEL	FREQUENCY	CHANNEL	FREQUENCY
1	2412 MHz	7	2442 MHz
2	2417 MHz	8	2447 MHz
3	2422 MHz	9	2452 MHz
4	2427 MHz	10	2457 MHz
5	2432 MHz	11	2462 MHz
6	2437 MHz		

3.2.1 CONFIGURATION OF SYSTEM UNDER TEST

TEST MODE A

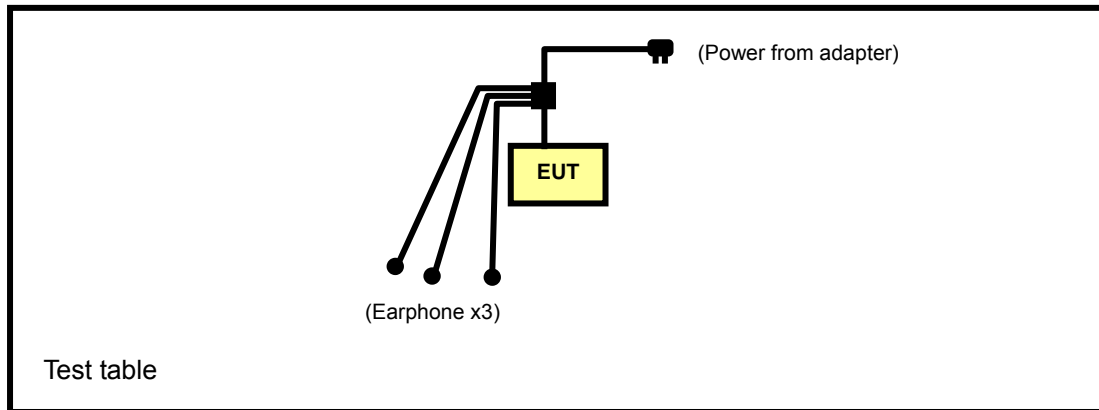

TEST MODE B

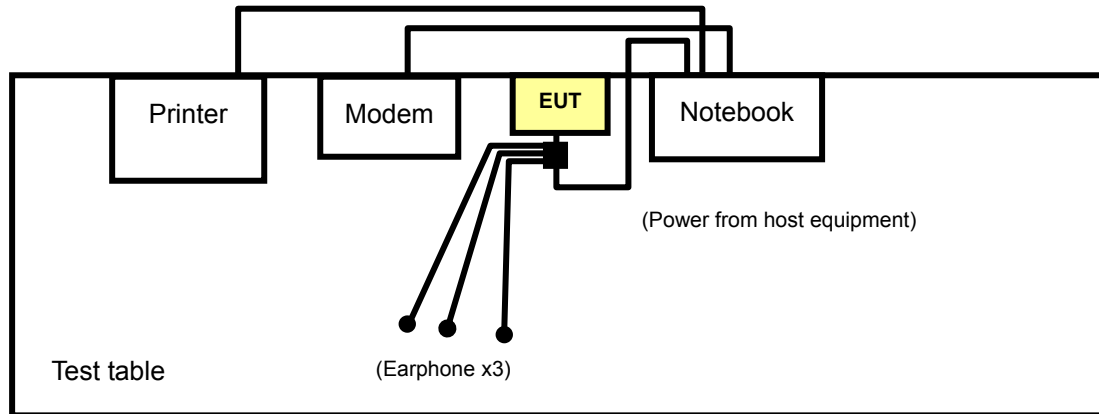

3.2.2 TEST MODE APPLICABILITY AND TESTED CHANNEL DETAIL

EUT CONFIGURE MODE	APPLICABLE TO				DESCRIPTION
	RE \geq 1G	RE<1G	PLC	APCM	
A	√	√	√	√	Power from adapter
B	-	√	√	-	Power from host equipment

Where **PLC**: Power Line Conducted Emission **RE<1G**: Radiated Emission below 1GHz
RE \geq 1G: Radiated Emission above 1GHz **APCM**: Antenna Port Conducted Measurement

NOTE: "-" means no effect.

RADIATED EMISSION TEST (ABOVE 1 GHz):

- Pre-Scan has been conducted to determine the worst-case mode from all possible combinations between available modulations, data rates, XYZ axis and antenna ports (if EUT with antenna diversity architecture) .
- Following channel(s) was (were) selected for the final test as listed below.

EUT CONFIGURE MODE	MODE	AVAILABLE CHANNEL	TESTED CHANNEL	MODULATION TECHNOLOGY	MODULATION TYPE	DATA RATE (Mbps)	AXIS
A	802.11b	1 to 11	1, 6, 11	DSSS	DBPSK	1.0	Y
A	802.11g	1 to 11	1, 6, 11	OFDM	BPSK	6.0	Y

RADIATED EMISSION TEST (BELOW 1 GHz):

- Pre-Scan has been conducted to determine the worst-case mode from all possible combinations between available modulations, data rates, XYZ axis and antenna ports (if EUT with antenna diversity architecture) .
- Following channel(s) was (were) selected for the final test as listed below.

EUT CONFIGURE MODE	MODE	AVAILABLE CHANNEL	TESTED CHANNEL	MODULATION TECHNOLOGY	MODULATION TYPE	DATA RATE (Mbps)	AXIS
A	802.11g	1 to 11	6	OFDM	BPSK	6.0	Y
B	802.11g	1 to 11	6	OFDM	BPSK	6.0	Y

POWER LINE CONDUCTED EMISSION TEST:

- Pre-Scan has been conducted to determine the worst-case mode from all possible combinations between available modulations, data rates and antenna ports (if EUT with antenna diversity architecture) .
- Following channel(s) was (were) selected for the final test as listed below.

EUT CONFIGURE MODE	MODE	AVAILABLE CHANNEL	TESTED CHANNEL	MODULATION TECHNOLOGY	MODULATION TYPE	DATA RATE (Mbps)
A	802.11g	1 to 11	6	OFDM	BPSK	6.0
B	802.11g	1 to 11	6	OFDM	BPSK	6.0

BANDEDGE MEASUREMENT:

- Pre-Scan has been conducted to determine the worst-case mode from all possible combinations between available modulations, data rates and antenna ports (if EUT with antenna diversity architecture) .
- Following channel(s) was (were) selected for the final test as listed below.

EUT CONFIGURE MODE	MODE	AVAILABLE CHANNEL	TESTED CHANNEL	MODULATION TECHNOLOGY	MODULATION TYPE	DATA RATE (Mbps)
A	802.11b	1 to 11	1, 11	DSSS	DBPSK	1.0
A	802.11g	1 to 11	1, 11	OFDM	BPSK	6.0

ANTENNA PORT CONDUCTED MEASUREMENT:

- Pre-Scan has been conducted to determine the worst-case mode from all possible combinations between available modulations, data rates and antenna ports (if EUT with antenna diversity architecture) .
- Following channel(s) was (were) selected for the final test as listed below.

EUT CONFIGURE MODE	MODE	AVAILABLE CHANNEL	TESTED CHANNEL	MODULATION TECHNOLOGY	MODULATION TYPE	DATA RATE (Mbps)
A	802.11b	1 to 11	1, 6, 11	DSSS	DBPSK	1.0
A	802.11g	1 to 11	1, 6, 11	OFDM	BPSK	6.0



3.3.3 GENERAL DESCRIPTION OF APPLIED STANDARDS

The EUT is a RF Product. According to the specifications of the manufacturer, it must comply with the requirements of the following standards:

FCC Part 15, Subpart C. (15.247)

ANSI C63.4- 2003

All test items have been performed and recorded as per the above standards.

NOTE: The EUT is also considered as a kind of computer peripheral, because the connection to computer is necessary for typical use. It has been verified to comply with the requirements of FCC Part 15, Subpart B, Class B (DoC). The test report has been issued separately.



3.3.4 DESCRIPTION OF SUPPORT UNITS

The EUT has been tested as an independent unit together with other necessary accessories or support units. The following support units or accessories were used to form a representative test configuration during the tests.

NO.	PRODUCT	BRAND	MODEL NO.	SERIAL NO.	FCC ID
1	NOTEBOOK	HP	NC6000	CNU411DXNL	FCC DoC Approved
2	PRINTER	EPSON	LQ-300+	DCGY047265	FCC DoC Approved
3	MODEM	ACEEX	1414V/3	0401008269	IFAXDM1414
4	EARPHONE (BLACK)	NA	NA	NA	NA
5	EARPHONE (SILVER)	NA	NA	NA	NA

NO.	SIGNAL CABLE DESCRIPTION OF THE ABOVE SUPPORT UNITS
1	1.25m shielded USB cable without core
2	1.8m braid shielded wire , DB25 connector , w/o core.
3	1.2m braid shielded wire , DB25 & DB9 connector , w/o core.
4	1.65m cable
5	1.50m cable

NOTE: 1. All power cords of the above support units are non shielded (1.8m).
2. Item 4~5 were provided by the client.

4. TEST TYPES AND RESULTS

4.2 RADIATED EMISSION MEASUREMENT

4.2.1 LIMITS OF RADIATED EMISSION MEASUREMENT

Emissions radiated outside of the specified bands, shall be according to the general radiated limits in 15.209 as following:

FREQUENCIES (MHz)	FIELD STRENGTH (microvolts/meter)	MEASUREMENT DISTANCE (meters)
0.009 ~ 0.490	2400/F(kHz)	300
0.490 ~ 1.705	24000/F(kHz)	30
1.705 ~ 30.0	30	30
30 ~ 88	100	3
88 ~ 216	150	3
216 ~ 960	200	3
Above 960	500	3

NOTE:

1. The lower limit shall apply at the transition frequencies.
2. Emission level (dBuV/m) = 20 log Emission level (uV/m).
3. As shown in 15.35(b), for frequencies above 1000MHz, the field strength limits are based on average detector, however, the peak field strength of any emission shall not exceed the maximum permitted average limits, specified above by more than 20dB under any condition of modulation.



4.2.2 TEST INSTRUMENTS

DESCRIPTION & MANUFACTURER	MODEL NO.	SERIAL NO.	CALIBRATED UNTIL
Test Receiver ROHDE & SCHWARZ	ESCI	100424	Jul. 27, 2008
Spectrum Analyzer Agilent	E4446A	MY44360128	Dec. 06, 2008
BILOG Antenna SCHWARZBECK	VULB9168	9168-160	May 01, 2009
HORN Antenna SCHWARZBECK	9120D	9120D-209	Jun. 28, 2008
HORN Antenna SCHWARZBECK	BBHA 9170	BBHA9170243	Dec. 24, 2008
Preamplifier Agilent	8447D	2944A10633	Oct. 28, 2008
Preamplifier Agilent	8449B	3008A01964	Oct. 23, 2008
RF signal cable HUBER+SUHNNER	SUCOFLEX 104	283402/4	Dec. 06, 2008
RF signal cable HUBER+SUHNNER	SUCOFLEX 104	251644/4	Dec. 06, 2008
Software ADT.	ADT_Radiated_V7.6	NA	NA
Antenna Tower inn-co GmbH	MA 4000	013303	NA
Antenna Tower Controller inn-co GmbH	CO2000	017303	NA
Turn Table ADT.	TT100.	TT93021703	NA
Turn Table Controller ADT.	SC100.	SC93021703	NA

- NOTE:**
1. The calibration interval of the above test instruments is 12 months and the calibrations are traceable to NML/ROC and NIST/USA.
 2. The test was performed in HwaYa Chamber 3.
 3. The horn antenna and HP preamplifier (model: 8449B) are used only for the measurement of emission frequency above 1GHz if tested.
 4. The FCC Site Registration No. is 988962.
 5. The IC Site Registration No. is IC3789B-3.

4.2.3 TEST PROCEDURES

- a. The EUT was placed on the top of a rotating table 0.8 meters above the ground at a 3 meter semi-anechoic chamber. The table was rotated 360 degrees to determine the position of the highest radiation.
- b. The EUT was set 3 meters away from the interference-receiving antenna, which was mounted on the top of a variable-height antenna tower.
- c. The antenna is a broadband antenna, and its height is varied from one meter to four meters above the ground to determine the maximum value of the field strength. Both horizontal and vertical polarizations of the antenna are set to make the measurement.
- d. For each suspected emission, the EUT was arranged to its worst case and then the antenna was tuned to heights from 1 meter to 4 meters and the rotatable table was turned from 0 degrees to 360 degrees to find the maximum reading.
- e. The test-receiver system was set to Peak Detect Function and Specified Bandwidth with Maximum Hold Mode.
- f. If the emission level of the EUT in peak mode was lower than the limit specified, then testing could be stopped and the peak values of the EUT would be reported. Otherwise the emissions would be re-tested one by one using the peak, quasi-peak or average method as specified and then reported in a data sheet.

NOTE:

1. The resolution bandwidth and video bandwidth of test receiver/spectrum analyzer is 120kHz for Quasi-peak detection at frequency below 1GHz.
2. The resolution bandwidth of test receiver/spectrum analyzer is 1 MHz and video bandwidth is 3MHz for Peak detection at frequency above 1GHz.
3. The resolution bandwidth of test receiver/spectrum analyzer is 1 MHz and the video bandwidth is 10Hz for Average detection (AV) at frequency above 1GHz.
4. All modes of operation were investigated and the worst-case emissions are reported.

4.2.4 DEVIATION FROM TEST STANDARD

No deviation

4.2.5 TEST SETUP

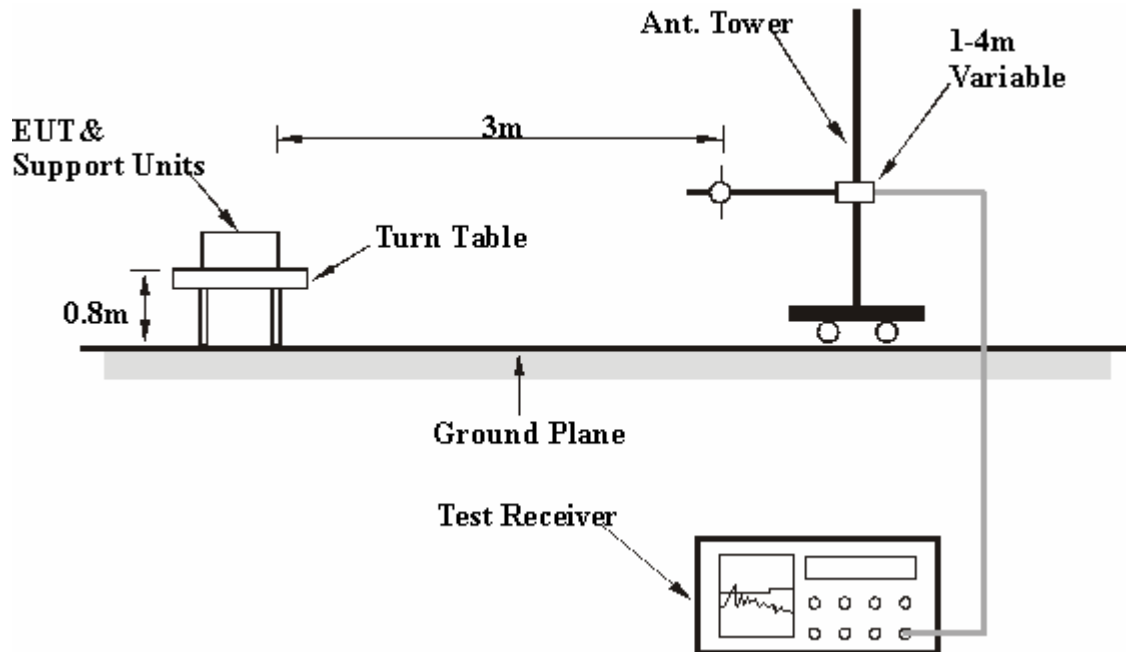

For the actual test configuration, please refer to the attached file (Test Setup Photo).

4.2.6 EUT OPERATING CONDITIONS

TEST MODE A

- Placed the EUT on a testing table.
- Use the software to control the EUT under transmission condition continuously at specific channel frequency.

TEST MODE B

- Connected the EUT to notebook and placed on a testing table.
- The notebook system ran a test program (provided by manufacturer) to enable EUT under transmission condition continuously at specific channel frequency.
- The necessary accessories enable the system in full functions.

4.2.7 TEST RESULTS

802.11b DSSS MODULATION

EUT TEST CONDITION		MEASUREMENT DETAIL	
CHANNEL	Channel 1	FREQUENCY RANGE	1 ~ 25GHz
INPUT POWER (SYSTEM)	120Vac, 60 Hz	DETECTOR FUNCTION	Peak (PK) Average (AV)
ENVIRONMENTAL CONDITIONS	27deg. C, 66%RH 993hPa	TESTED BY	Brad Wu

ANTENNA POLARITY & TEST DISTANCE: HORIZONTAL AT 3 M								
NO.	FREQ. (MHz)	EMISSION LEVEL (dBuV/m)	LIMIT (dBuV/m)	MARGIN (dB)	ANTENNA HEIGHT (m)	TABLE ANGLE (Degree)	RAW VALUE (dBuV)	CORRECTION FACTOR (dB/m)
1	2386.00	57.28 PK	74.00	-16.72	1.06 H	125	25.05	32.23
2	2386.00	48.28 AV	54.00	-5.72	1.06 H	125	16.05	32.23
3	*2412.00	105.71 PK			1.06 H	125	73.39	32.32
4	*2412.00	101.02 AV			1.06 H	125	68.70	32.32
5	4824.00	49.16 PK	74.00	-24.84	1.33 H	214	11.03	38.13
6	4824.00	40.19 AV	54.00	-13.81	1.33 H	214	2.06	38.13
ANTENNA POLARITY & TEST DISTANCE: VERTICAL AT 3 M								
NO.	FREQ. (MHz)	EMISSION LEVEL (dBuV/m)	LIMIT (dBuV/m)	MARGIN (dB)	ANTENNA HEIGHT (m)	TABLE ANGLE (Degree)	RAW VALUE (dBuV)	CORRECTION FACTOR (dB/m)
1	2386.00	54.37 PK	74.00	-19.63	1.27 V	189	22.14	32.23
2	2386.00	45.64 AV	54.00	-8.36	1.27 V	189	13.41	32.23
3	*2412.00	99.55 PK			1.27 V	189	67.23	32.32
4	*2412.00	94.95 AV			1.27 V	189	62.63	32.32
5	4824.00	51.40 PK	74.00	-22.60	1.09 V	200	13.27	38.13
6	4824.00	44.49 AV	54.00	-9.51	1.09 V	200	6.36	38.13

- REMARKS:**
1. Emission level (dBuV/m) = Raw Value (dBuV) + Correction Factor (dB/m).
 2. Correction Factor (dB/m) = Antenna Factor (dB/m) + Cable Factor (dB).
 3. The other emission levels were very low against the limit.
 4. Margin value = Emission level – Limit value.
 5. “ * “: Fundamental frequency.



EUT TEST CONDITION		MEASUREMENT DETAIL	
CHANNEL	Channel 6	FREQUENCY RANGE	1 ~ 25GHz
INPUT POWER (SYSTEM)	120Vac, 60 Hz	DETECTOR FUNCTION	Peak (PK) Average (AV)
ENVIRONMENTAL CONDITIONS	27deg. C, 66%RH 993hPa	TESTED BY	Brad Wu

ANTENNA POLARITY & TEST DISTANCE: HORIZONTAL AT 3 M								
NO.	FREQ. (MHz)	EMISSION LEVEL (dBuV/m)	LIMIT (dBuV/m)	MARGIN (dB)	ANTENNA HEIGHT (m)	TABLE ANGLE (Degree)	RAW VALUE (dBuV)	CORRECTION FACTOR (dB/m)
1	*2437.00	105.78 PK			1.06 H	131	73.38	32.40
2	*2437.00	101.21 AV			1.06 H	131	68.81	32.40
3	4874.00	50.07 PK	74.00	-23.93	1.29 H	199	11.75	38.32
4	4874.00	40.47 AV	54.00	-13.53	1.29 H	199	2.15	38.32
ANTENNA POLARITY & TEST DISTANCE: VERTICAL AT 3 M								
NO.	FREQ. (MHz)	EMISSION LEVEL (dBuV/m)	LIMIT (dBuV/m)	MARGIN (dB)	ANTENNA HEIGHT (m)	TABLE ANGLE (Degree)	RAW VALUE (dBuV)	CORRECTION FACTOR (dB/m)
1	*2437.00	100.04 PK			1.31 V	199	67.64	32.40
2	*2437.00	95.17 AV			1.31 V	199	62.77	32.40
3	4874.00	51.96 PK	74.00	-22.04	1.01 V	187	13.64	38.32
4	4874.00	44.82 AV	54.00	-9.18	1.01 V	187	6.50	38.32

- REMARKS:**
1. Emission level (dBuV/m) = Raw Value (dBuV) + Correction Factor (dB/m).
 2. Correction Factor (dB/m) = Antenna Factor (dB/m) + Cable Factor (dB).
 3. The other emission levels were very low against the limit.
 4. Margin value = Emission level – Limit value.
 5. “ * “: Fundamental frequency.



EUT TEST CONDITION		MEASUREMENT DETAIL	
CHANNEL	Channel 11	FREQUENCY RANGE	1 ~ 25GHz
INPUT POWER (SYSTEM)	120Vac, 60 Hz	DETECTOR FUNCTION	Peak (PK) Average (AV)
ENVIRONMENTAL CONDITIONS	27deg. C, 66%RH 993hPa	TESTED BY	Brad Wu

ANTENNA POLARITY & TEST DISTANCE: HORIZONTAL AT 3 M								
NO.	FREQ. (MHz)	EMISSION LEVEL (dBuV/m)	LIMIT (dBuV/m)	MARGIN (dB)	ANTENNA HEIGHT (m)	TABLE ANGLE (Degree)	RAW VALUE (dBuV)	CORRECTION FACTOR (dB/m)
1	*2462.00	105.53 PK			1.02 H	128	73.05	32.48
2	*2462.00	101.05 AV			1.02 H	128	68.57	32.48
3	2483.50	57.54 PK	74.00	-16.46	1.02 H	128	24.98	32.56
4	2483.50	48.84 AV	54.00	-5.16	1.02 H	128	16.28	32.56
5	4924.00	50.97 PK	74.00	-23.03	1.41 H	200	12.51	38.46
6	4924.00	41.69 AV	54.00	-12.31	1.41 H	200	3.23	38.46
ANTENNA POLARITY & TEST DISTANCE: VERTICAL AT 3 M								
NO.	FREQ. (MHz)	EMISSION LEVEL (dBuV/m)	LIMIT (dBuV/m)	MARGIN (dB)	ANTENNA HEIGHT (m)	TABLE ANGLE (Degree)	RAW VALUE (dBuV)	CORRECTION FACTOR (dB/m)
1	*2462.00	99.71 PK			1.31 V	187	67.23	32.48
2	*2462.00	95.03 AV			1.31 V	187	62.55	32.48
3	2483.50	57.14 PK	74.00	-16.86	1.31 V	187	24.58	32.56
4	2483.50	48.32 AV	54.00	-5.68	1.31 V	187	15.76	32.56
5	4924.00	50.85 PK	74.00	-23.15	1.04 V	187	12.39	38.46
6	4924.00	44.17 AV	54.00	-9.83	1.04 V	187	5.71	38.46

- REMARKS:**
1. Emission level (dBuV/m) = Raw Value (dBuV) + Correction Factor (dB/m).
 2. Correction Factor (dB/m) = Antenna Factor (dB/m) + Cable Factor (dB).
 3. The other emission levels were very low against the limit.
 4. Margin value = Emission level – Limit value.
 5. “ * “: Fundamental frequency.



802.11g OFDM MODULATION

EUT TEST CONDITION		MEASUREMENT DETAIL	
CHANNEL	Channel 1	FREQUENCY RANGE	1 ~ 25GHz
INPUT POWER (SYSTEM)	120Vac, 60 Hz	DETECTOR FUNCTION	Peak (PK) Average (AV)
ENVIRONMENTAL CONDITIONS	27deg. C, 66%RH 993hPa	TESTED BY	Brad Wu

ANTENNA POLARITY & TEST DISTANCE: HORIZONTAL AT 3 M								
NO.	FREQ. (MHz)	EMISSION LEVEL (dBuV/m)	LIMIT (dBuV/m)	MARGIN (dB)	ANTENNA HEIGHT (m)	TABLE ANGLE (Degree)	RAW VALUE (dBuV)	CORRECTION FACTOR (dB/m)
1	2390.00	72.59 PK	74.00	-1.41	1.34 H	27	40.35	32.24
2	2390.00	51.97 AV	54.00	-2.03	1.34 H	27	19.73	32.24
3	*2412.00	104.18 PK			1.29 H	20	71.86	32.32
4	*2412.00	92.40 AV			1.29 H	20	60.08	32.32
5	4824.00	48.52 PK	74.00	-25.48	1.00 H	360	10.39	38.13
6	4824.00	35.28 AV	54.00	-18.72	1.00 H	360	-2.85	38.13
ANTENNA POLARITY & TEST DISTANCE: VERTICAL AT 3 M								
NO.	FREQ. (MHz)	EMISSION LEVEL (dBuV/m)	LIMIT (dBuV/m)	MARGIN (dB)	ANTENNA HEIGHT (m)	TABLE ANGLE (Degree)	RAW VALUE (dBuV)	CORRECTION FACTOR (dB/m)
1	2390.00	70.27 PK	74.00	-3.73	1.00 V	348	38.03	32.24
2	2390.00	49.54 AV	54.00	-4.46	1.00 V	348	17.30	32.24
3	*2412.00	101.98 PK			1.00 V	348	69.66	32.32
4	*2412.00	90.67 AV			1.00 V	348	58.35	32.32
5	4824.00	49.34 PK	74.00	-24.66	1.00 V	360	11.21	38.13
6	4824.00	34.55 AV	54.00	-19.45	1.00 V	360	-3.58	38.13

- REMARKS:**
1. Emission level (dBuV/m) = Raw Value (dBuV) + Correction Factor (dB/m).
 2. Correction Factor (dB/m) = Antenna Factor (dB/m) + Cable Factor (dB).
 3. The other emission levels were very low against the limit.
 4. Margin value = Emission level – Limit value.
 5. “ * “: Fundamental frequency.



EUT TEST CONDITION		MEASUREMENT DETAIL	
CHANNEL	Channel 6	FREQUENCY RANGE	1 ~ 25GHz
INPUT POWER (SYSTEM)	120Vac, 60 Hz	DETECTOR FUNCTION	Peak (PK) Average (AV)
ENVIRONMENTAL CONDITIONS	27deg. C, 66%RH 993hPa	TESTED BY	Brad Wu

ANTENNA POLARITY & TEST DISTANCE: HORIZONTAL AT 3 M								
NO.	FREQ. (MHz)	EMISSION LEVEL (dBuV/m)	LIMIT (dBuV/m)	MARGIN (dB)	ANTENNA HEIGHT (m)	TABLE ANGLE (Degree)	RAW VALUE (dBuV)	CORRECTION FACTOR (dB/m)
1	*2437.00	106.11 PK			1.28 H	100	73.71	32.40
2	*2437.00	94.71 AV			1.28 H	100	62.31	32.40
3	4874.00	48.69 PK	74.00	-25.31	1.19 H	360	10.37	38.32
4	4874.00	35.30 AV	54.00	-18.70	1.19 H	360	-3.02	38.32
ANTENNA POLARITY & TEST DISTANCE: VERTICAL AT 3 M								
NO.	FREQ. (MHz)	EMISSION LEVEL (dBuV/m)	LIMIT (dBuV/m)	MARGIN (dB)	ANTENNA HEIGHT (m)	TABLE ANGLE (Degree)	RAW VALUE (dBuV)	CORRECTION FACTOR (dB/m)
1	*2437.00	103.24 PK			1.00 V	71	70.84	32.40
2	*2437.00	93.33 AV			1.00 V	71	60.93	32.40
3	4874.00	49.34 PK	74.00	-24.66	1.09 V	0	11.02	38.32
4	4874.00	35.32 AV	54.00	-18.68	1.09 V	0	-3.00	38.32

- REMARKS:**
1. Emission level (dBuV/m) = Raw Value (dBuV) + Correction Factor (dB/m).
 2. Correction Factor (dB/m) = Antenna Factor (dB/m) + Cable Factor (dB).
 3. The other emission levels were very low against the limit.
 4. Margin value = Emission level – Limit value.
 5. “ * “: Fundamental frequency.



EUT TEST CONDITION		MEASUREMENT DETAIL	
CHANNEL	Channel 11	FREQUENCY RANGE	1 ~ 25GHz
INPUT POWER (SYSTEM)	120Vac, 60 Hz	DETECTOR FUNCTION	Peak (PK) Average (AV)
ENVIRONMENTAL CONDITIONS	27deg. C, 66%RH 993hPa	TESTED BY	Brad Wu

ANTENNA POLARITY & TEST DISTANCE: HORIZONTAL AT 3 M								
NO.	FREQ. (MHz)	EMISSION LEVEL (dBuV/m)	LIMIT (dBuV/m)	MARGIN (dB)	ANTENNA HEIGHT (m)	TABLE ANGLE (Degree)	RAW VALUE (dBuV)	CORRECTION FACTOR (dB/m)
1	*2462.00	105.71 PK			1.04 H	127	73.23	32.48
2	*2462.00	94.59 AV			1.04 H	127	62.11	32.48
3	2483.50	72.06 PK	74.00	-1.94	1.03 H	129	39.50	32.56
4	2483.50	51.48 AV	54.00	-2.52	1.03 H	129	18.92	32.56
5	4924.00	48.17 PK	74.00	-25.83	1.10 H	360	9.71	38.46
6	4924.00	35.41 AV	54.00	-18.59	1.10 H	360	-3.05	38.46
ANTENNA POLARITY & TEST DISTANCE: VERTICAL AT 3 M								
NO.	FREQ. (MHz)	EMISSION LEVEL (dBuV/m)	LIMIT (dBuV/m)	MARGIN (dB)	ANTENNA HEIGHT (m)	TABLE ANGLE (Degree)	RAW VALUE (dBuV)	CORRECTION FACTOR (dB/m)
1	*2462.00	103.14 PK			1.10 V	355	70.66	32.48
2	*2462.00	93.21 AV			1.10 V	355	60.73	32.48
3	2483.50	69.41 PK	74.00	-4.59	1.10 V	355	36.85	32.56
4	2483.50	48.75 AV	54.00	-5.25	1.10 V	355	16.19	32.56
5	4924.00	48.63 PK	74.00	-25.37	1.00 V	0	10.17	38.46
6	4924.00	35.54 AV	54.00	-18.46	1.00 V	0	-2.92	38.46

- REMARKS:**
1. Emission level (dBuV/m) = Raw Value (dBuV) + Correction Factor (dB/m).
 2. Correction Factor (dB/m) = Antenna Factor (dB/m) + Cable Factor (dB).
 3. The other emission levels were very low against the limit.
 4. Margin value = Emission level – Limit value.
 5. “ * “: Fundamental frequency.



BELOW 1GHz WORST-CASE DATA : 802.11g OFDM MODULATION

EUT TEST CONDITION		MEASUREMENT DETAIL	
CHANNEL	Channel 6	FREQUENCY RANGE	Below 1000MHz
INPUT POWER (SYSTEM)	120Vac, 60 Hz	DETECTOR FUNCTION	Quasi-Peak
ENVIRONMENTAL CONDITIONS	27deg. C, 66%RH 993hPa	TESTED BY	Brad Wu
TEST MODE	A		

ANTENNA POLARITY & TEST DISTANCE: HORIZONTAL AT 3 M								
NO.	FREQ. (MHz)	EMISSION LEVEL (dBuV/m)	LIMIT (dBuV/m)	MARGIN (dB)	ANTENNA HEIGHT (m)	TABLE ANGLE (Degree)	RAW VALUE (dBuV)	CORRECTION FACTOR (dB/m)
1	35.73	27.79 QP	40.00	-12.21	2.00 H	202	13.82	13.97
2	160.17	29.68 QP	43.50	-13.82	1.50 H	184	15.18	14.50
3	169.89	34.59 QP	43.50	-8.91	2.00 H	187	20.83	13.76
4	208.77	35.55 QP	43.50	-7.95	1.00 H	112	23.90	11.65
5	249.60	28.08 QP	46.00	-17.92	1.00 H	271	14.60	13.47
6	292.38	32.86 QP	46.00	-13.14	1.00 H	331	17.90	14.96
7	305.99	35.37 QP	46.00	-10.63	1.00 H	289	20.07	15.30
8	768.73	30.26 QP	46.00	-15.74	1.00 H	286	4.53	25.74

ANTENNA POLARITY & TEST DISTANCE: VERTICAL AT 3 M								
NO.	FREQ. (MHz)	EMISSION LEVEL (dBuV/m)	LIMIT (dBuV/m)	MARGIN (dB)	ANTENNA HEIGHT (m)	TABLE ANGLE (Degree)	RAW VALUE (dBuV)	CORRECTION FACTOR (dB/m)
1	35.73	37.60 QP	40.00	-2.40	1.00 V	88	23.63	13.97
2	88.23	29.11 QP	43.50	-14.39	1.50 V	247	19.90	9.21
3	99.89	35.29 QP	43.50	-8.21	1.00 V	280	25.11	10.18
4	129.06	28.84 QP	43.50	-14.66	1.00 V	304	15.70	13.14
5	164.06	25.87 QP	43.50	-17.63	1.00 V	115	11.67	14.20
6	208.77	26.65 QP	43.50	-16.85	1.50 V	40	14.99	11.65
7	305.99	32.13 QP	46.00	-13.87	1.50 V	304	16.83	15.30
8	955.38	29.56 QP	46.00	-16.44	1.00 V	193	1.21	28.36

- REMARKS:**
1. Emission level (dBuV/m) = Raw Value (dBuV) + Correction Factor (dB/m).
 2. Correction Factor (dB/m) = Antenna Factor (dB/m) + Cable Factor (dB).
 3. The other emission levels were very low against the limit.
 4. Margin value = Emission level – Limit value.



EUT TEST CONDITION		MEASUREMENT DETAIL	
CHANNEL	Channel 6	FREQUENCY RANGE	Below 1000MHz
INPUT POWER (SYSTEM)	120Vac, 60 Hz	DETECTOR FUNCTION	Quasi-Peak
ENVIRONMENTAL CONDITIONS	27deg. C, 66%RH 993hPa	TESTED BY	Brad Wu
TEST MODE	B		

ANTENNA POLARITY & TEST DISTANCE: HORIZONTAL AT 3 M								
NO.	FREQ. (MHz)	EMISSION LEVEL (dBuV/m)	LIMIT (dBuV/m)	MARGIN (dB)	ANTENNA HEIGHT (m)	TABLE ANGLE (Degree)	RAW VALUE (dBuV)	CORRECTION FACTOR (dB/m)
1	119.34	34.63 QP	43.50	-8.87	1.50 H	145	22.07	12.56
2	164.06	34.40 QP	43.50	-9.10	1.50 H	139	20.20	14.20
3	208.77	36.49 QP	43.50	-7.01	1.50 H	118	24.84	11.65
4	288.49	34.25 QP	46.00	-11.75	1.00 H	286	19.38	14.87
5	325.43	36.71 QP	46.00	-9.29	1.00 H	91	20.89	15.82
6	331.26	33.30 QP	46.00	-12.70	1.00 H	205	17.33	15.97
7	582.08	34.84 QP	46.00	-11.16	1.50 H	31	12.81	22.03
8	829.00	33.10 QP	46.00	-12.90	1.00 H	283	6.60	26.51
ANTENNA POLARITY & TEST DISTANCE: VERTICAL AT 3 M								
NO.	FREQ. (MHz)	EMISSION LEVEL (dBuV/m)	LIMIT (dBuV/m)	MARGIN (dB)	ANTENNA HEIGHT (m)	TABLE ANGLE (Degree)	RAW VALUE (dBuV)	CORRECTION FACTOR (dB/m)
1	31.84	27.05 QP	40.00	-12.95	1.00 V	283	13.51	13.54
2	88.23	28.63 QP	43.50	-14.87	1.00 V	226	19.42	9.21
3	99.89	36.45 QP	43.50	-7.05	1.00 V	193	26.28	10.18
4	129.06	30.07 QP	43.50	-13.43	1.50 V	334	16.93	13.14
5	584.02	33.58 QP	46.00	-12.42	1.00 V	10	11.51	22.07
6	830.95	32.35 QP	46.00	-13.65	1.00 V	13	5.81	26.55
7	916.50	31.05 QP	46.00	-14.95	1.00 V	250	3.21	27.84
8	1000.10	39.54 QP	54.00	-14.46	1.00 V	19	10.88	28.67

- REMARKS:**
1. Emission level (dBuV/m) = Raw Value (dBuV) + Correction Factor (dB/m).
 2. Correction Factor (dB/m) = Antenna Factor (dB/m) + Cable Factor (dB).
 3. The other emission levels were very low against the limit.
 4. Margin value = Emission level – Limit value.

4.1 CONDUCTED EMISSION MEASUREMENT

4.1.1 LIMITS OF CONDUCTED EMISSION MEASUREMENT

FREQUENCY OF EMISSION (MHz)	CONDUCTED LIMIT (dB μ V)	
	Quasi-peak	Average
0.15 ~ 0.5	66 to 56	56 to 46
0.5 ~ 5	56	46
5 ~ 30	60	50

- NOTE:**
1. The lower limit shall apply at the transition frequencies.
 2. The limit decreases in line with the logarithm of the frequency in the range of 0.15 to 0.50 MHz.
 3. All emanations from a class A/B digital device or system, including any network of conductors and apparatus connected thereto, shall not exceed the level of field strengths specified above.

4.1.2 TEST INSTRUMENTS

DESCRIPTION & MANUFACTURER	MODEL NO.	SERIAL NO.	CALIBRATED UNTIL
Test Receiver ROHDE & SCHWARZ	ESCS30	100288	Sep. 21, 2008
RF signal cable Woken	5D-FB	Cable-HYCO3-0 1	Jan. 06, 2009
LISN ROHDE & SCHWARZ	ESH2-Z5	100100	Jan. 09, 2009
LISN SCHWARZBECK	ESH3-Z5	100311	Jan. 21, 2009
Software ADT	ADT_Cond_V3	NA	NA

- NOTE:**
1. The calibration interval of the above test instruments is 12 months and the calibrations are traceable to NML/ROC and NIST/USA.
 2. The test was performed in HwaYa Shielded Room 2.
 3. The VCCI Site Registration No. is C-2047.

4.1.3 TEST PROCEDURES

- a. The EUT was placed 0.4 meters from the conducting wall of the shielded room with EUT being connected to the power mains through a line impedance stabilization network (LISN). Other support units were connected to the power mains through another LISN. The two LISNs provide 50 ohm/ 50uH of coupling impedance for the measuring instrument.
- b. Both lines of the power mains connected to the EUT were checked for maximum conducted interference.
- c. The frequency range from 150kHz to 30MHz was searched. Emission levels under (Limit - 20dB) was not recorded.

4.1.4 DEVIATION FROM TEST STANDARD

No deviation

4.1.5 TEST SETUP

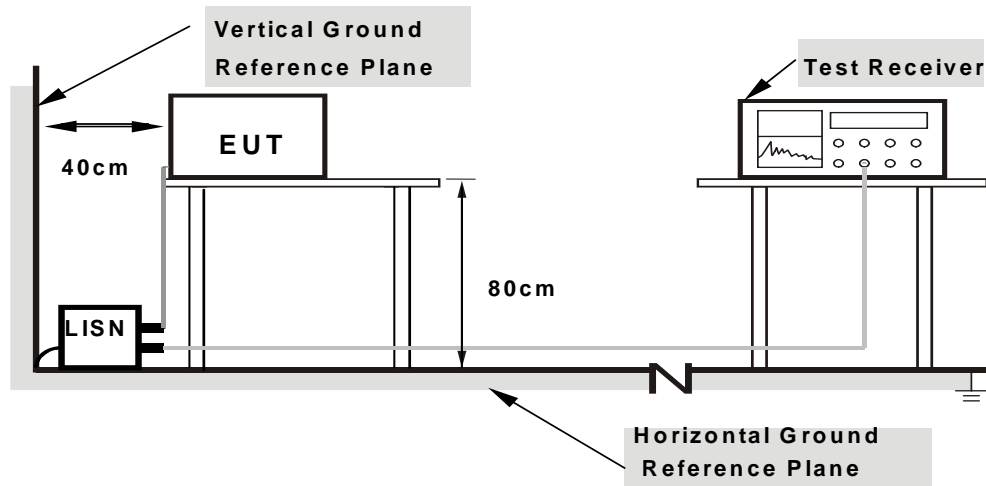

- Note:**
1. Support units were connected to second LISN.
 2. Both of LISNs (AMN) are 80 cm from EUT and at least 80 cm from other units and other metal planes

For the actual test configuration, please refer to the attached file (Test Setup Photo).

4.1.6 EUT OPERATING CONDITIONS

Same as 4.1.6.

4.1.7 TEST RESULTS

CONDUCTED WORST CASE DATA_802.11g OFDM MODULATION

EUT TEST CONDITION		MEASUREMENT DETAIL	
CHANNEL	Channel 6	PHASE	Line 1
MODULATION TYPE	BPSK	6dB BANDWIDTH	9 kHz
TRANSFER RATE	6Mbps	INPUT POWER (SYSTEM)	120Vac, 60 Hz
ENVIRONMENTAL CONDITIONS	25deg. C, 62%RH, 988hPa	TESTED BY	Kevin Liang
TEST MODE	A		

No	Freq. [MHz]	Corr. Factor (dB)	Reading Value		Emission Level		Limit		Margin	
			[dB (uV)]		[dB (uV)]		[dB (uV)]		(dB)	
			Q.P.	AV.	Q.P.	AV.	Q.P.	AV.	Q.P.	AV.
1	0.173	0.13	39.12	-	39.25	-	64.79	54.79	-25.55	-
2	0.259	0.13	37.22	-	37.35	-	61.45	51.45	-24.10	-
3	0.923	0.17	39.51	-	39.68	-	56.00	46.00	-16.32	-
4	2.758	0.33	28.98	-	29.31	-	56.00	46.00	-26.69	-
5	15.617	0.92	31.38	-	32.30	-	60.00	50.00	-27.70	-
6	26.520	1.68	32.69	-	34.37	-	60.00	50.00	-25.63	-

- REMARKS:**
1. Q.P. and AV. are abbreviations of quasi-peak and average individually.
 2. "-": The Quasi-peak reading value also meets average limit and measurement with the average detector is unnecessary.
 3. The emission levels of other frequencies were very low against the limit.
 4. Margin value = Emission level - Limit value
 5. Correction factor = Insertion loss + Cable loss
 6. Emission Level = Correction Factor + Reading Value.

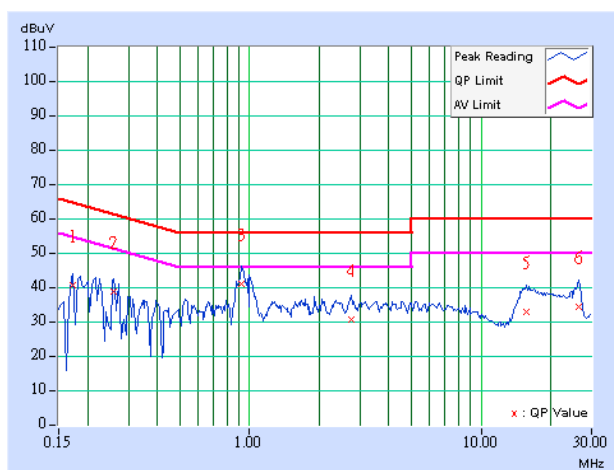

EUT TEST CONDITION		MEASUREMENT DETAIL	
CHANNEL	Channel 6	PHASE	Line 2
MODULATION TYPE	BPSK	6dB BANDWIDTH	9 kHz
TRANSFER RATE	6Mbps	INPUT POWER (SYSTEM)	120Vac, 60 Hz
ENVIRONMENTAL CONDITIONS	25deg. C, 62%RH, 988hPa	TESTED BY	Kevin Liang
TEST MODE	A		

No	Freq.	Corr. Factor	Reading Value		Emission Level		Limit		Margin	
			[dB (uV)]		[dB (uV)]		[dB (uV)]		(dB)	
	[MHz]	(dB)	Q.P.	AV.	Q.P.	AV.	Q.P.	AV.	Q.P.	AV.
1	0.236	0.14	35.18	-	35.32	-	62.24	52.24	-26.92	-
2	0.927	0.18	33.68	-	33.86	-	56.00	46.00	-22.14	-
3	1.691	0.24	23.49	-	23.73	-	56.00	46.00	-32.27	-
4	4.469	0.44	19.85	-	20.29	-	56.00	46.00	-35.71	-
5	14.766	0.71	28.46	-	29.17	-	60.00	50.00	-30.83	-
6	26.215	1.03	27.56	-	28.59	-	60.00	50.00	-31.41	-

- REMARKS:**
1. Q.P. and AV. are abbreviations of quasi-peak and average individually.
 2. "-": The Quasi-peak reading value also meets average limit and measurement with the average detector is unnecessary.
 3. The emission levels of other frequencies were very low against the limit.
 4. Margin value = Emission level - Limit value
 5. Correction factor = Insertion loss + Cable loss
 6. Emission Level = Correction Factor + Reading Value.

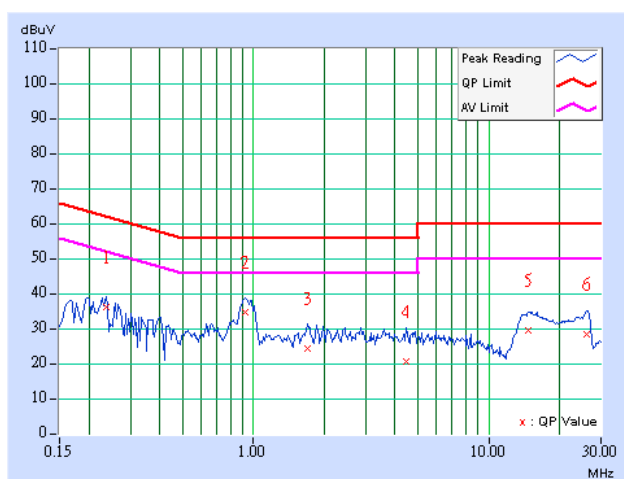

EUT TEST CONDITION		MEASUREMENT DETAIL	
CHANNEL	Channel 6	PHASE	Line 1
MODULATION TYPE	BPSK	6dB BANDWIDTH	9 kHz
TRANSFER RATE	6Mbps	INPUT POWER (SYSTEM)	120Vac, 60 Hz
ENVIRONMENTAL CONDITIONS	25deg. C, 62%RH, 988hPa	TESTED BY	Kevin Liang
TEST MODE	B		

No	Freq. [MHz]	Corr. Factor (dB)	Reading Value [dB (uV)]		Emission Level [dB (uV)]		Limit [dB (uV)]		Margin (dB)	
			Q.P.	AV.	Q.P.	AV.	Q.P.	AV.	Q.P.	AV.
1	0.154	0.13	37.96	-	38.09	-	65.79	55.79	-27.70	-
2	0.210	0.13	44.55	-	44.68	-	63.21	53.21	-18.53	-
3	0.560	0.15	36.03	-	36.18	-	56.00	46.00	-19.82	-
4	0.841	0.16	31.22	-	31.38	-	56.00	46.00	-24.62	-
5	2.938	0.34	33.10	-	33.44	-	56.00	46.00	-22.56	-
6	19.510	1.27	31.19	-	32.46	-	60.00	50.00	-27.54	-

- REMARKS:**
1. Q.P. and AV. are abbreviations of quasi-peak and average individually.
 2. "-": The Quasi-peak reading value also meets average limit and measurement with the average detector is unnecessary.
 3. The emission levels of other frequencies were very low against the limit.
 4. Margin value = Emission level - Limit value
 5. Correction factor = Insertion loss + Cable loss
 6. Emission Level = Correction Factor + Reading Value.

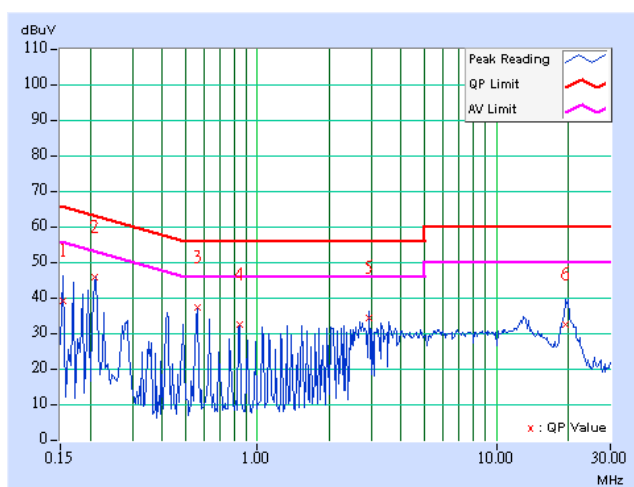

EUT TEST CONDITION		MEASUREMENT DETAIL	
CHANNEL	Channel 6	PHASE	Line 2
MODULATION TYPE	BPSK	6dB BANDWIDTH	9 kHz
TRANSFER RATE	6Mbps	INPUT POWER (SYSTEM)	120Vac, 60 Hz
ENVIRONMENTAL CONDITIONS	25deg. C, 62%RH, 988hPa	TESTED BY	Kevin Liang
TEST MODE	B		

No	Freq.	Corr. Factor	Reading Value		Emission Level		Limit		Margin	
			[dB (uV)]		[dB (uV)]		[dB (uV)]		(dB)	
	[MHz]	(dB)	Q.P.	AV.	Q.P.	AV.	Q.P.	AV.	Q.P.	AV.
1	0.150	0.14	39.20	-	39.34	-	66.00	56.00	-26.66	-
2	0.211	0.14	43.74	-	43.88	-	63.16	53.16	-19.28	-
3	0.559	0.16	36.67	-	36.83	-	56.00	46.00	-19.17	-
4	1.117	0.19	30.61	-	30.80	-	56.00	46.00	-25.20	-
5	3.493	0.39	27.52	-	27.91	-	56.00	46.00	-28.09	-
6	20.270	0.96	30.86	-	31.82	-	60.00	50.00	-28.18	-

- REMARKS:**
1. Q.P. and AV. are abbreviations of quasi-peak and average individually.
 2. "-": The Quasi-peak reading value also meets average limit and measurement with the average detector is unnecessary.
 3. The emission levels of other frequencies were very low against the limit.
 4. Margin value = Emission level - Limit value
 5. Correction factor = Insertion loss + Cable loss
 6. Emission Level = Correction Factor + Reading Value.

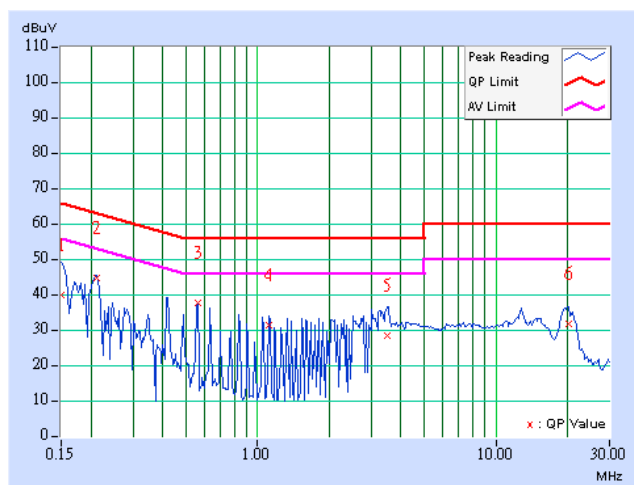



4.3 6dB BANDWIDTH MEASUREMENT

4.3.1 LIMITS OF 6dB BANDWIDTH MEASUREMENT

The minimum of 6dB Bandwidth Measurement is 0.5 MHz.

4.3.2 TEST INSTRUMENTS

DESCRIPTION & MANUFACTURER	MODEL NO.	SERIAL NO.	CALIBRATED UNTIL
SPECTRUM ANALYZER	FSP40	100040	Jun. 28, 2008

NOTE: The calibration interval of the above test instruments is 12 months and the calibrations are traceable to NML/ROC and NIST/USA.

4.3.3 TEST PROCEDURE

The transmitter output was connected to the spectrum analyzer through an attenuator. The bandwidth of the fundamental frequency was measured by spectrum analyzer with 100kHz RBW and 300kHz VBW. The 6dB bandwidth is defined as the total spectrum the power of which is higher than peak power minus 6dB.

4.3.4 DEVIATION FROM TEST STANDARD

No deviation

4.3.5 TEST SETUP

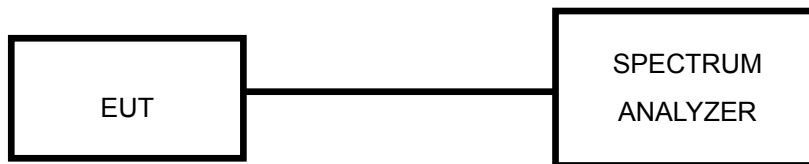

4.3.6 EUT OPERATING CONDITIONS

The software provided by client to enable the EUT under transmission condition continuously at lowest, middle and highest channel frequencies individually.

4.3.7 TEST RESULTS

802.11b DSSS MODULATION

MODULATION TYPE	DBPSK	TRANSFER RATE	1Mbps
INPUT POWER (SYSTEM)	120Vac, 60 Hz	ENVIRONMENTAL CONDITIONS	27deg. C, 66%RH, 985hPa
TESTED BY	Dean Wang		

CHANNEL	CHANNEL FREQUENCY (MHz)	6dB BANDWIDTH (MHz)	MINIMUM LIMIT (MHz)	PASS/FAIL
1	2412	10.12	0.5	PASS
6	2437	10.11	0.5	PASS
11	2462	10.10	0.5	PASS

CH 1

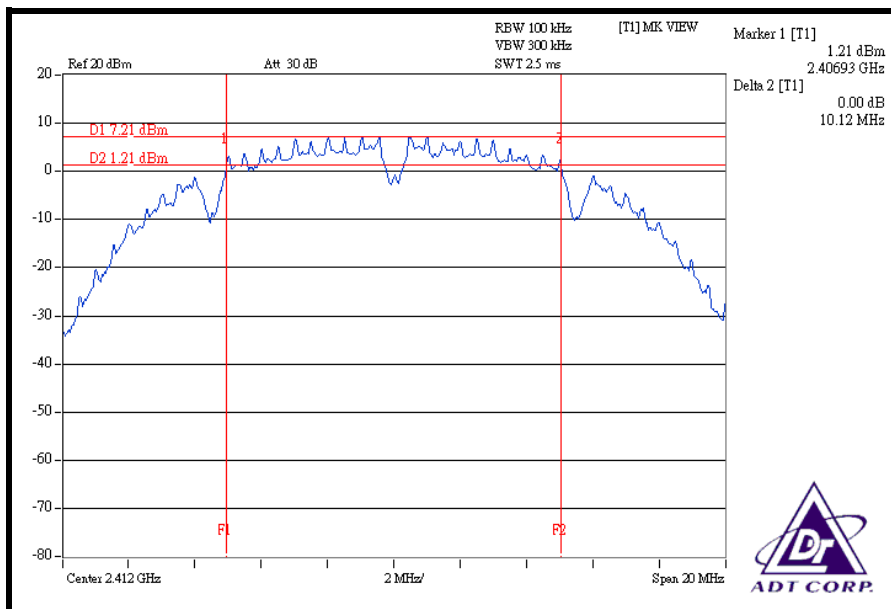

CH 6

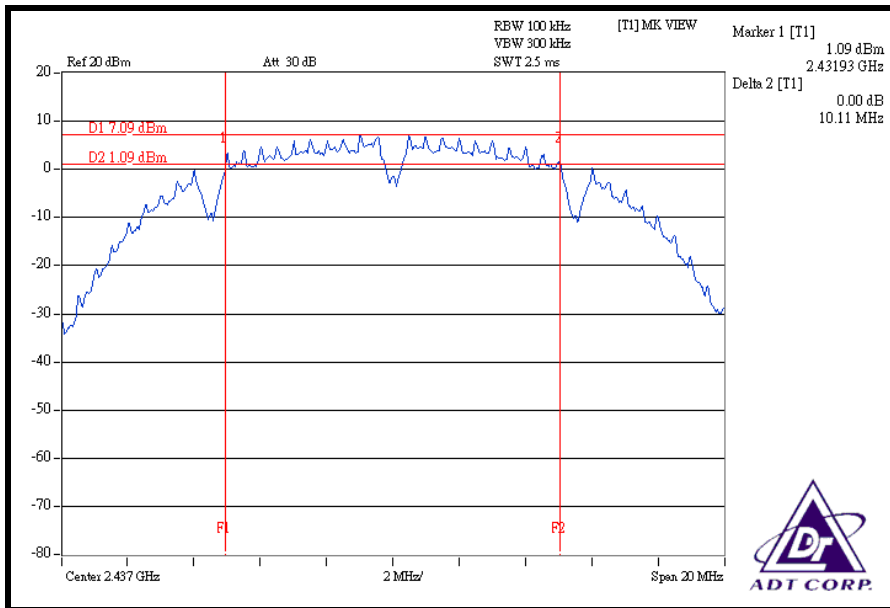

CH 11

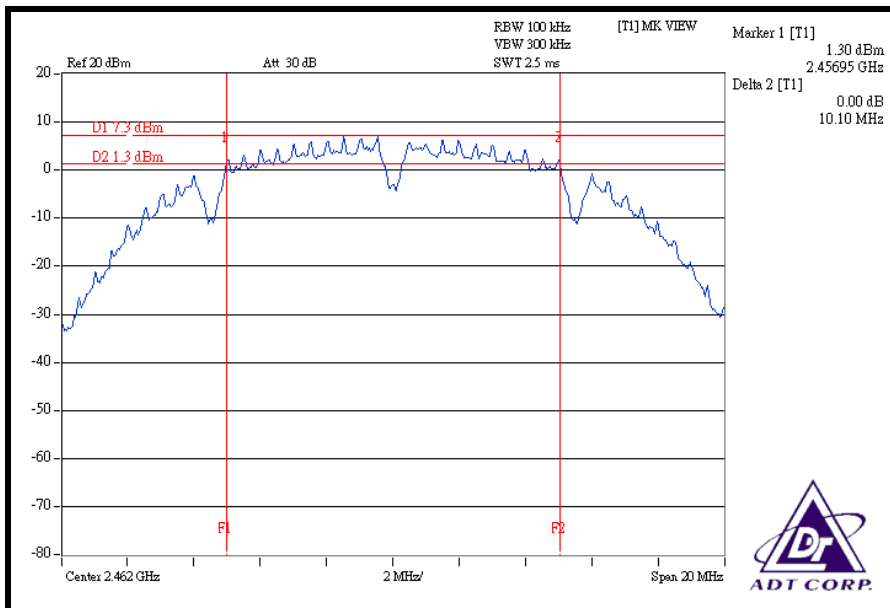



802.11g OFDM MODULATION

MODULATION TYPE	BPSK	TRANSFER RATE	6Mbps
INPUT POWER (SYSTEM)	120Vac, 60 Hz	ENVIRONMENTAL CONDITIONS	27deg. C, 66%RH, 985hPa
TESTED BY	Dean Wang		

CHANNEL	CHANNEL FREQUENCY (MHz)	6dB BANDWIDTH (MHz)	MINIMUM LIMIT (MHz)	PASS/FAIL
1	2412	16.37	0.5	PASS
6	2437	16.40	0.5	PASS
11	2462	16.42	0.5	PASS

CH 1

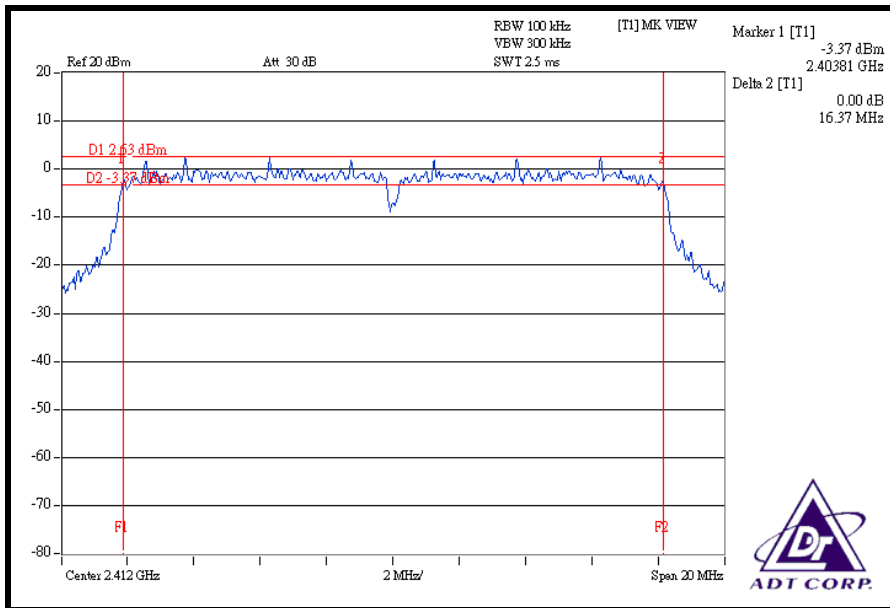

CH 6

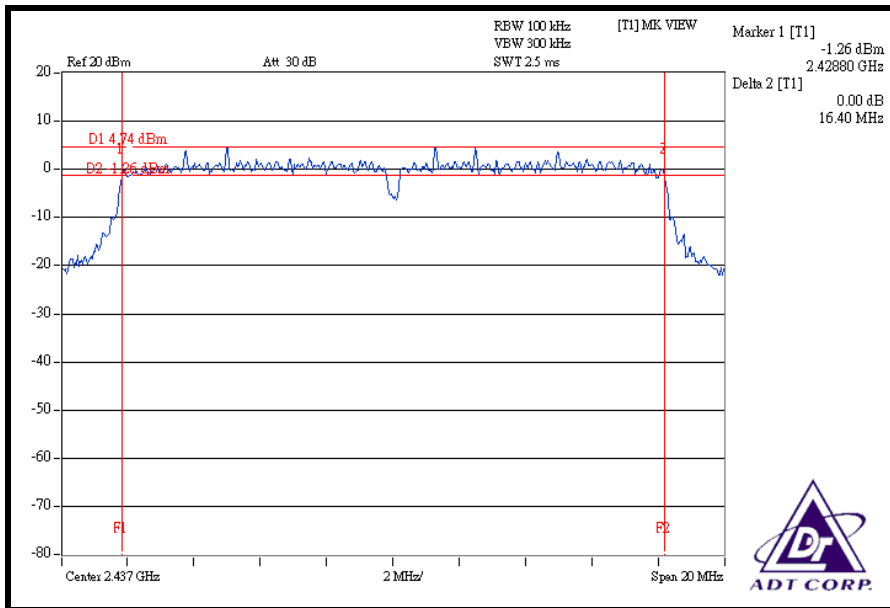

CH 11

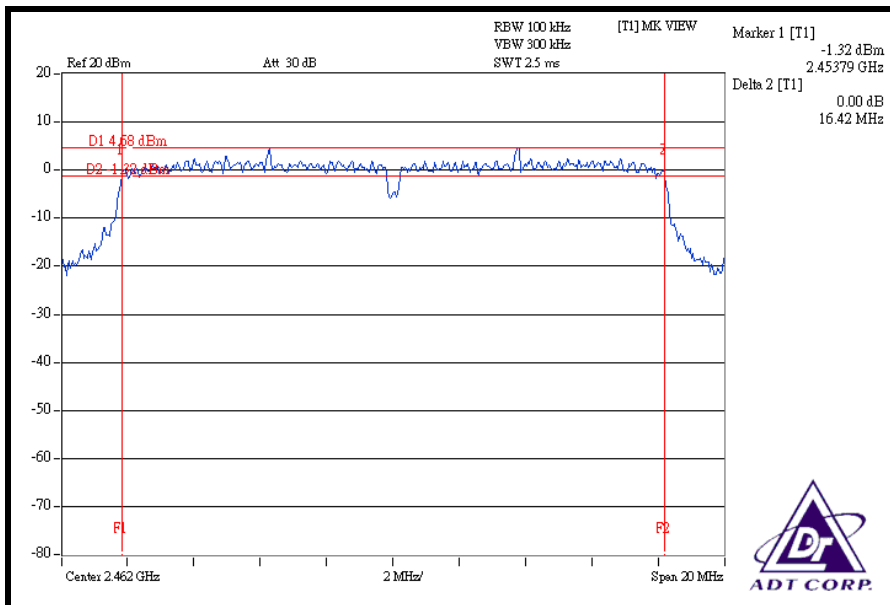



4.4 MAXIMUM PEAK OUTPUT POWER

4.4.1 LIMITS OF MAXIMUM PEAK OUTPUT POWER MEASUREMENT

The Maximum Peak Output Power Measurement is 30dBm.

4.4.2 TEST INSTRUMENTS

DESCRIPTION & MANUFACTURER	MODEL NO.	SERIAL NO.	CALIBRATED UNTIL
R&S SPECTRUM ANALYZER	FSP40	100040	Jun. 28, 2008
AGILENT SIGNAL GENERATOR	E8257C	MY43320668	Dec. 25, 2008
TEKTRONIX OSCILLOSCOPE	TDS1012	C037299	Nov. 21, 2008
NARDA DETECTOR	4503A	FSCM99899	NA

NOTE: The calibration interval of the above test instruments is 12 months and the calibrations are traceable to NML/ROC and NIST/USA.

4.4.3 TEST PROCEDURES

- a. A detector was used on the output port of the EUT. An oscilloscope was used to read the response of the detector.
- b. Replaced the EUT by the signal generator. The center frequency of the S.G was adjusted to the center frequency of the measured channel.
- c. Adjusted the power to have the same reading on oscilloscope. Record the power level.

4.4.4 DEVIATION FROM TEST STANDARD

No deviation

4.4.5 TEST SETUP



4.4.6 EUT OPERATING CONDITIONS

Same as Item 4.3.6

4.4.7 TEST RESULTS

802.11b DSSS MODULATION

MODULATION TYPE	DBPSK	TRANSFER RATE	1Mbps
INPUT POWER (SYSTEM)	120Vac, 60 Hz	ENVIRONMENTAL CONDITIONS	27deg. C, 66%RH, 985hPa
TESTED BY	Dean Wang		

CHANNEL	CHANNEL FREQUENCY (MHz)	PEAK POWER OUTPUT (mW)	PEAK POWER OUTPUT (dBm)	PEAK POWER LIMIT (dBm)	PASS/FAIL
1	2412	71.285	18.53	30	PASS
6	2437	71.614	18.55	30	PASS
11	2462	72.444	18.60	30	PASS

802.11g OFDM MODULATION

MODULATION TYPE	BPSK	TRANSFER RATE	6Mbps
INPUT POWER (SYSTEM)	120Vac, 60 Hz	ENVIRONMENTAL CONDITIONS	27deg. C, 66%RH, 985hPa
TESTED BY	Dean Wang		

CHANNEL	CHANNEL FREQUENCY (MHz)	PEAK POWER OUTPUT (mW)	PEAK POWER OUTPUT (dBm)	PEAK POWER LIMIT (dBm)	PASS/FAIL
1	2412	63.826	18.05	30	PASS
6	2437	103.039	20.13	30	PASS
11	2462	100.693	20.03	30	PASS



4.5 POWER SPECTRAL DENSITY MEASUREMENT

4.5.1 LIMITS OF POWER SPECTRAL DENSITY MEASUREMENT

The Maximum of Power Spectral Density Measurement is 8dBm.

4.5.2 TEST INSTRUMENTS

DESCRIPTION & MANUFACTURER	MODEL NO.	SERIAL NO.	CALIBRATED UNTIL
R&S SPECTRUM ANALYZER	FSP40	100040	Jun. 28, 2008

NOTE: The calibration interval of the above test instruments is 12 months and the calibrations are traceable to NML/ROC and NIST/USA.

4.5.3 TEST PROCEDURE

The transmitter output was connected to the spectrum analyzer through an attenuator, the bandwidth of the fundamental frequency was measured with the spectrum analyzer using 3kHz RBW and 30kHz VBW, set sweep time = span/1.5MHz. The power spectral density was measured and recorded.

The sweep time is allowed to be longer than span/3kHz for a full response of the mixer in the spectrum analyzer.

4.5.4 DEVIATION FROM TEST STANDARD

No deviation

4.5.5 TEST SETUP

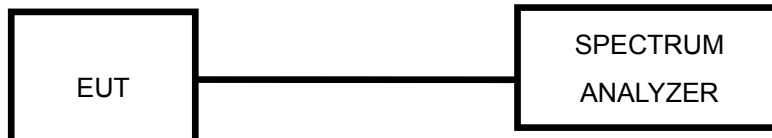

4.5.6 EUT OPERATING CONDITION

Same as Item 4.3.6

CH 6

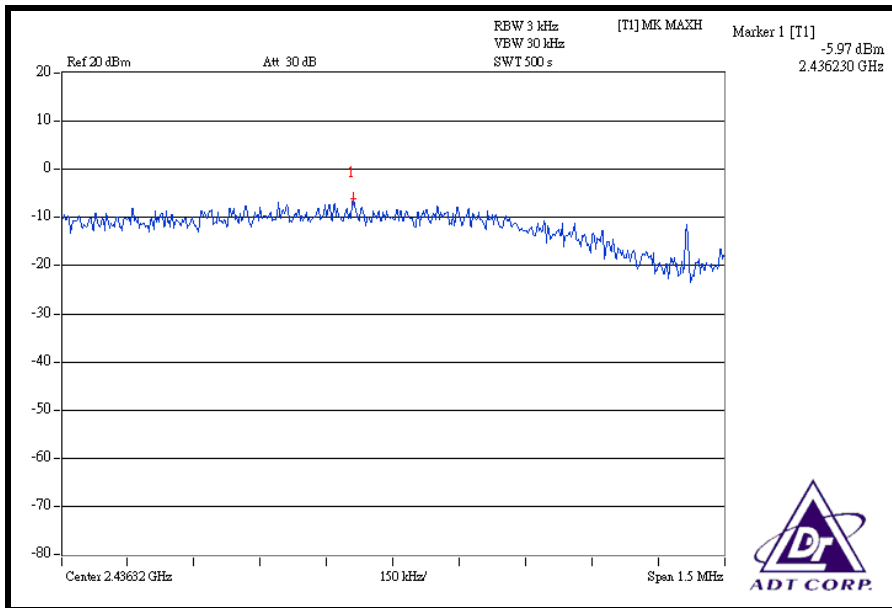

CH 11

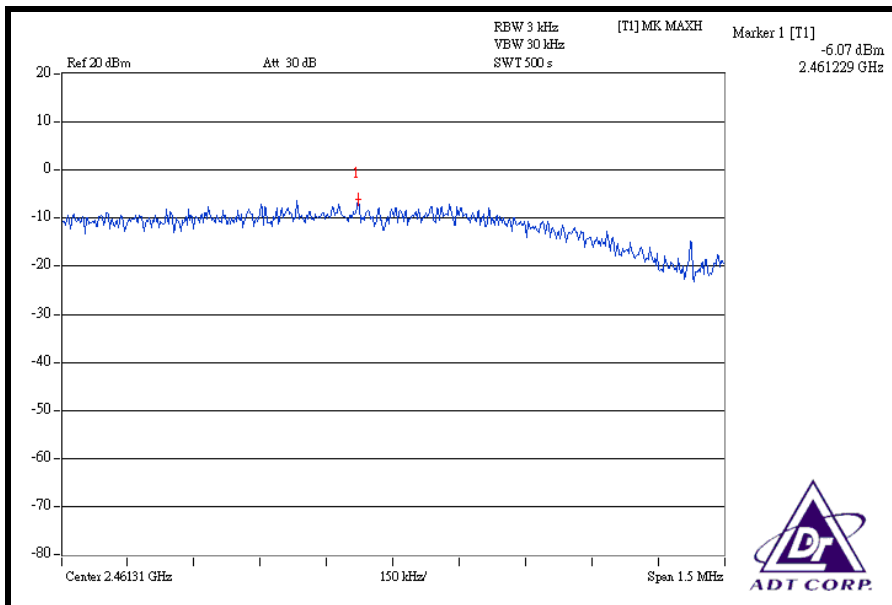

802.11g OFDM MODULATION

MODULATION TYPE	BPSK	TRANSFER RATE	6Mbps
INPUT POWER (SYSTEM)	120Vac, 60 Hz	ENVIRONMENTAL CONDITIONS	27deg. C, 66%RH, 985hPa
TESTED BY	Dean Wang		

CHANNEL	CHANNEL FREQUENCY (MHz)	RF POWER LEVEL IN 3kHz BW (dBm)	MAXIMUM LIMIT (dBm)	PASS/FAIL
1	2412	-10.46	8	PASS
6	2437	-8.43	8	PASS
11	2462	-8.55	8	PASS

CH 1

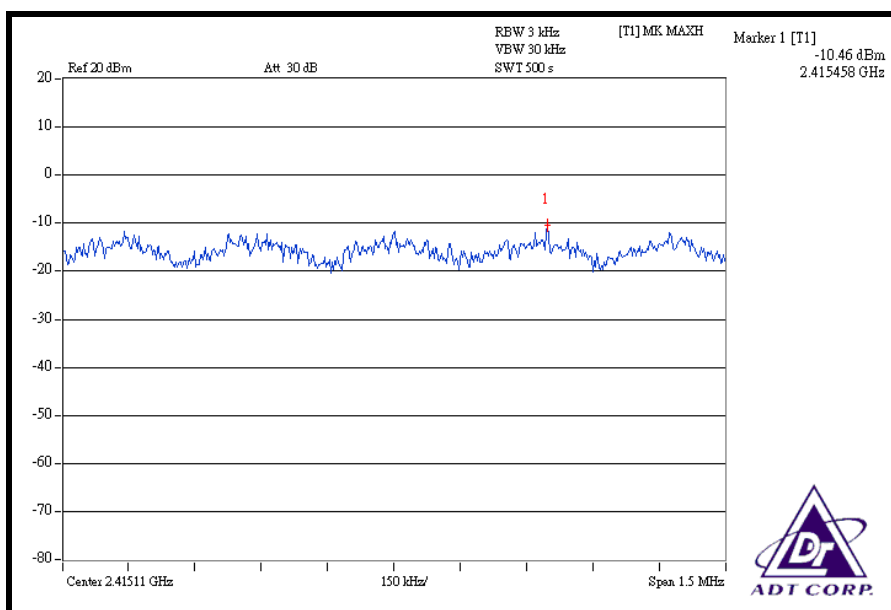

CH 6

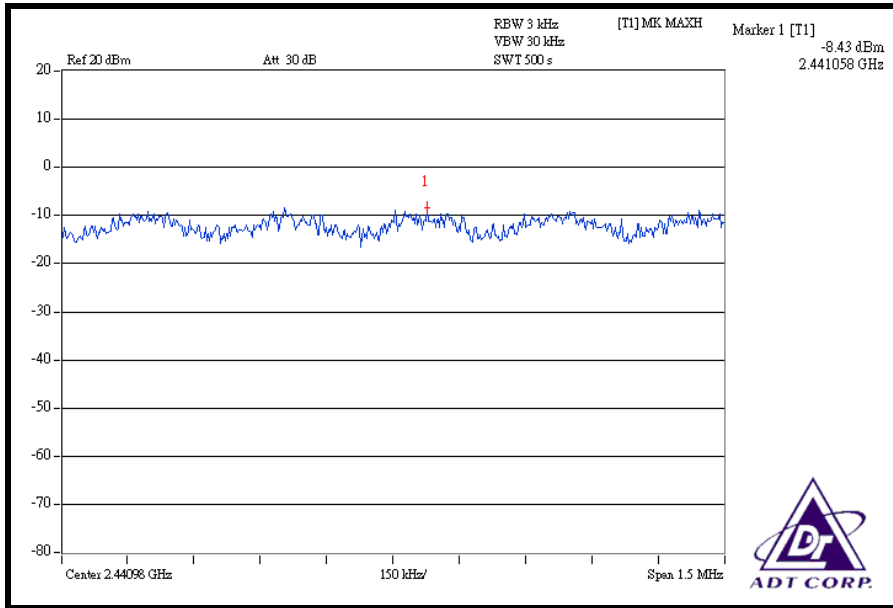

CH 11

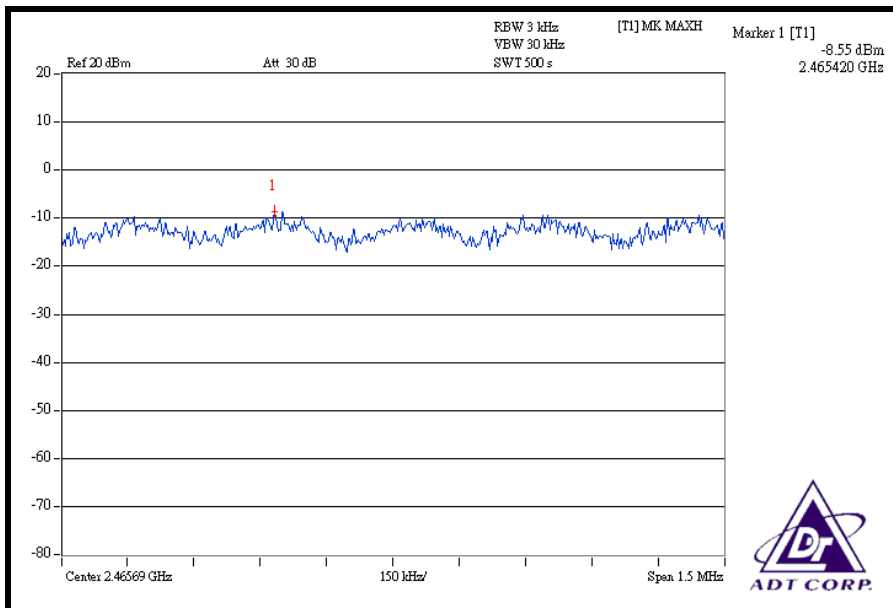



4.6 BAND EDGES MEASUREMENT

4.6.1 LIMITS OF BAND EDGES MEASUREMENT

Below -20dB of the highest emission level of operating band (in 100kHz Resolution Bandwidth).

4.6.2 TEST INSTRUMENTS

DESCRIPTION &	MODEL NO.	SERIAL NO.	CALIBRATED UNTIL
R&S SPECTRUM ANALYZER	FSP40	100040	Jun. 28, 2008

NOTE: The calibration interval of the above test instruments is 12 months and the calibrations are traceable to NML/ROC and NIST/USA.

4.6.3 TEST PROCEDURE

The transmitter output was connected to the spectrum analyzer via a low lose cable. Set both RBW and VBW of spectrum analyzer to 100 kHz and 300 kHz with suitable frequency span including 100 MHz bandwidth from band edge. The band edges was measured and recorded.

The spectrum plots (Peak RBW=100kHz, VBW=300kHz; Average RBW=1MHz, VBW=10Hz) are attached on the following pages.

4.6.4 DEVIATION FROM TEST STANDARD

No deviation

4.6.5 EUT OPERATING CONDITION

Same as Item 4.3.6

4.6.6 TEST RESULTS

The spectrum plots are attached on the following 12 images. D1 line indicates the highest level, and D2 line indicates the 20dB offset below D1. It shows compliance with the requirement in part 15.247(d).

802.11b DSSS MODULATION

NOTE 1: The band edge emission plot on the next page shows 51.18dBc between carrier maximum power and local maximum emission in restrict band (2.38640GHz). The emission of carrier strength list in the test result of channel 1 at the item 4.2.7 is 105.71dBuV/m (Peak), so the maximum field strength in restrict band is $105.71 - 51.18 = 54.53$ dBuV/m which is under 74dBuV/m limit.

The band edge emission plot on the next page shows 56.20dBc between carrier maximum power and local maximum emission in restrict band (2.38740GHz). The emission of carrier strength list in the test result of channel 1 at the item 4.2.7 is 101.02dBuV/m (Average), so the maximum field strength in restrict band is $101.02 - 56.20 = 44.82$ dBuV/m which is under 54dBuV/m limit.

NOTE 2: The band edge emission plot on the next second page shows 52.66dBc between carrier maximum power and local maximum emission in restrict band (2.48420GHz). The emission of carrier strength list in the test result of channel 11 at the item 4.2.7 is 105.53dBuV/m (Peak), so the maximum field strength in restrict band is $105.53 - 52.66 = 52.87$ dBuV/m which is under 74dBuV/m limit.

The band edge emission plot on the next third page shows 55.71dBc between carrier maximum power and local maximum emission in restrict band (2.48360GHz). The emission of carrier strength list in the test result of channel 11 at the item 4.2.7 is 101.05dBuV/m (Average), so the maximum field strength in restrict band is $101.05 - 55.71 = 45.34$ dBuV/m which is under 54dBuV/m limit.

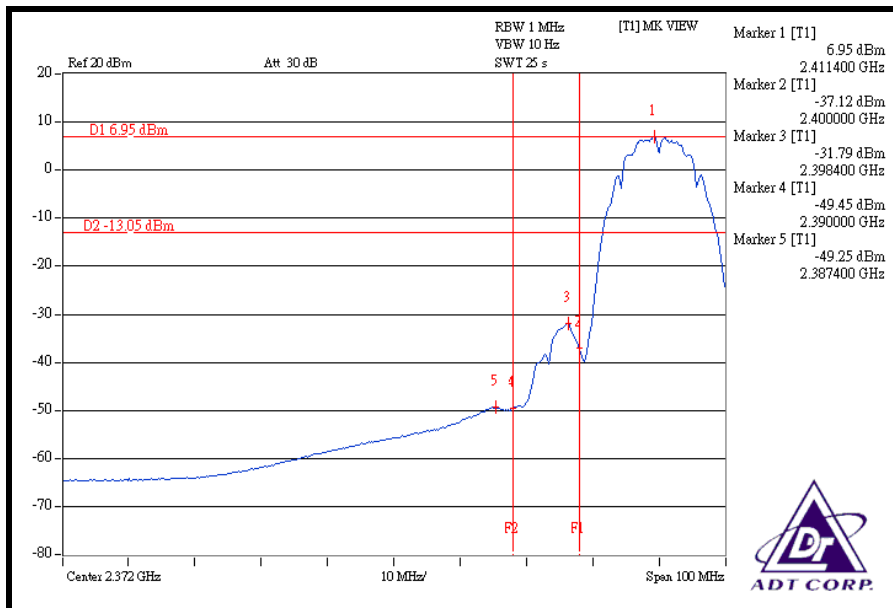
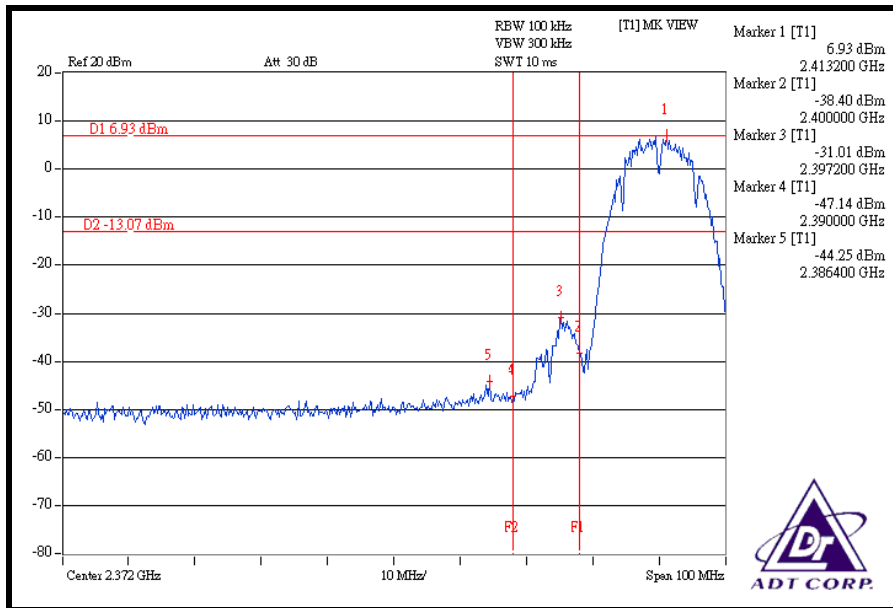

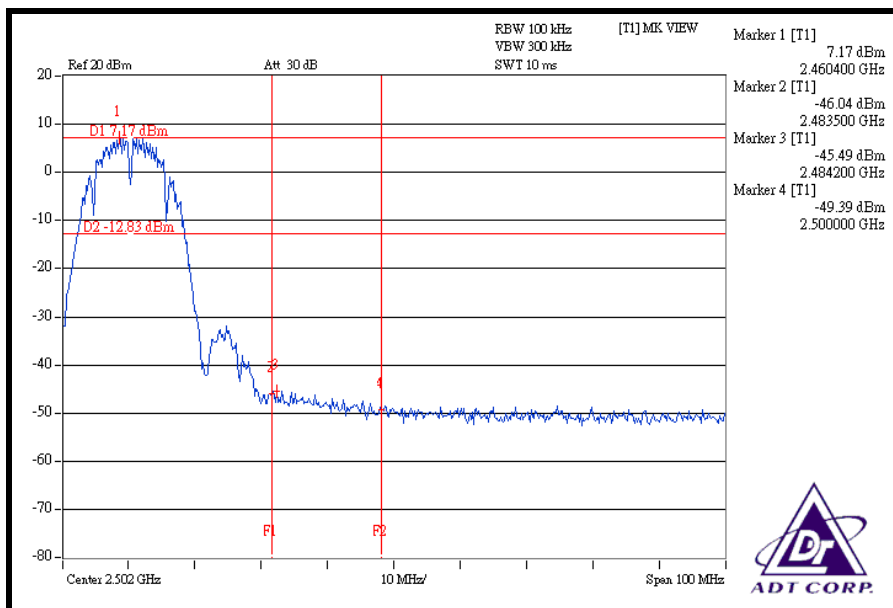
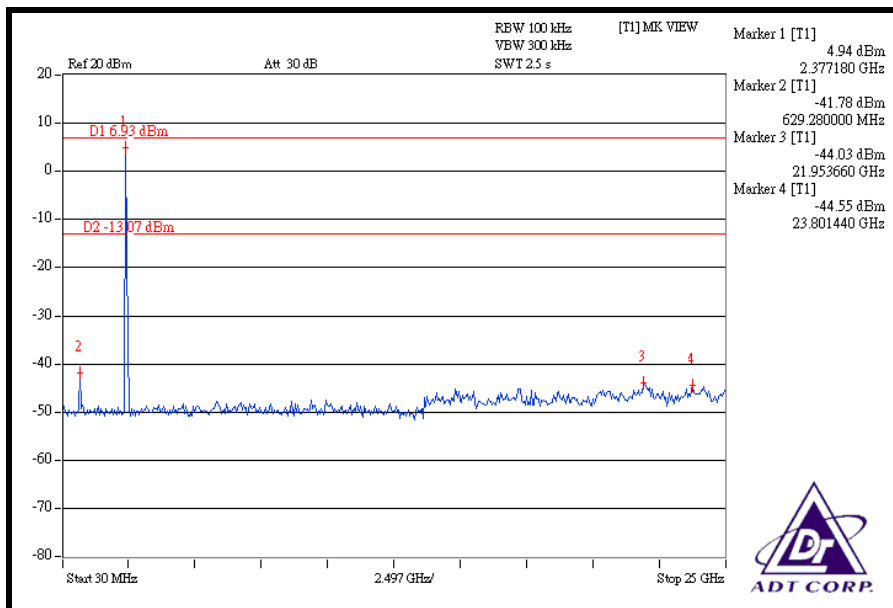

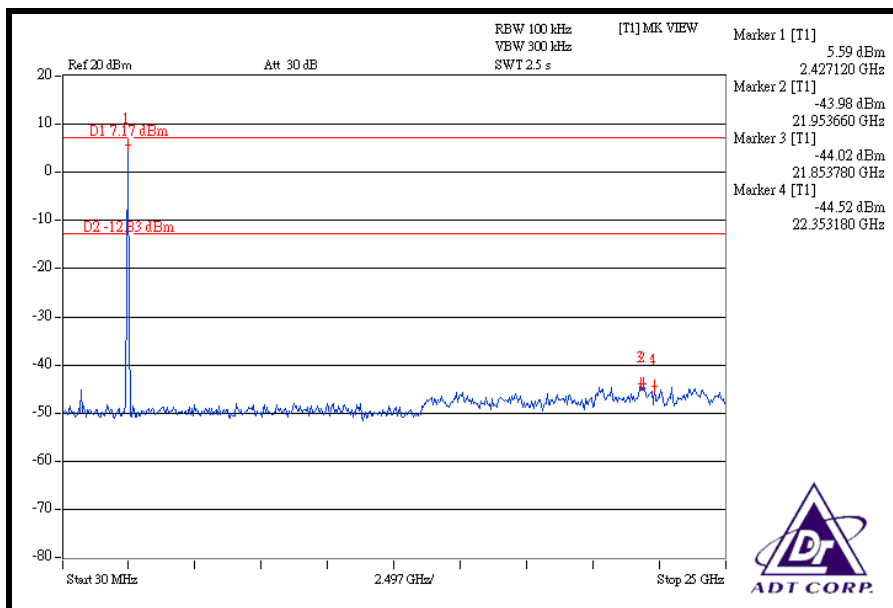
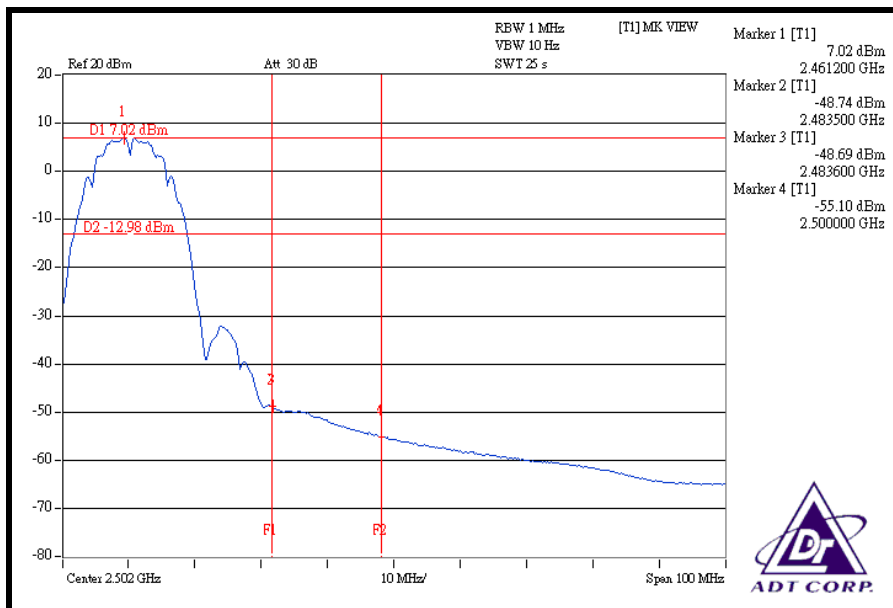

802.11g OFDM MODULATION

NOTE 1: The band edge emission plot on the next page shows 43.18dBc between carrier maximum power and local maximum emission in restrict band (2.39000GHz). The emission of carrier strength list in the test result of channel 1 at the item 4.2.7 is 104.18dBuV/m (Peak), so the maximum field strength in restrict band is $104.18 - 43.18 = 61.00$ dBuV/m which is under 74dBuV/m limit.

The band edge emission plot on the next page shows 45.08dBc between carrier maximum power and local maximum emission in restrict band (2.39000GHz). The emission of carrier strength list in the test result of channel 1 at the item 4.2.7 is 92.40dBuV/m (Average), so the maximum field strength in restrict band is $92.40 - 45.08 = 47.32$ dBuV/m which is under 54dBuV/m limit.

NOTE 2: The band edge emission plot on the next second page shows 39.36dBc between carrier maximum power and local maximum emission in restrict band (2.48360GHz). The emission of carrier strength list in the test result of channel 11 at the item 4.2.7 is 105.71dBuV/m (Peak), so the maximum field strength in restrict band is $105.71 - 39.36 = 66.35$ dBuV/m which is under 74dBuV/m limit.

The band edge emission plot on the next third page shows 42.51dBc between carrier maximum power and local maximum emission in restrict band (2.48350GHz). The emission of carrier strength list in the test result of channel 11 at the item 4.2.7 is 94.59dBuV/m (Average), so the maximum field strength in restrict band is $94.59 - 42.51 = 52.08$ dBuV/m which is under 54dBuV/m limit.

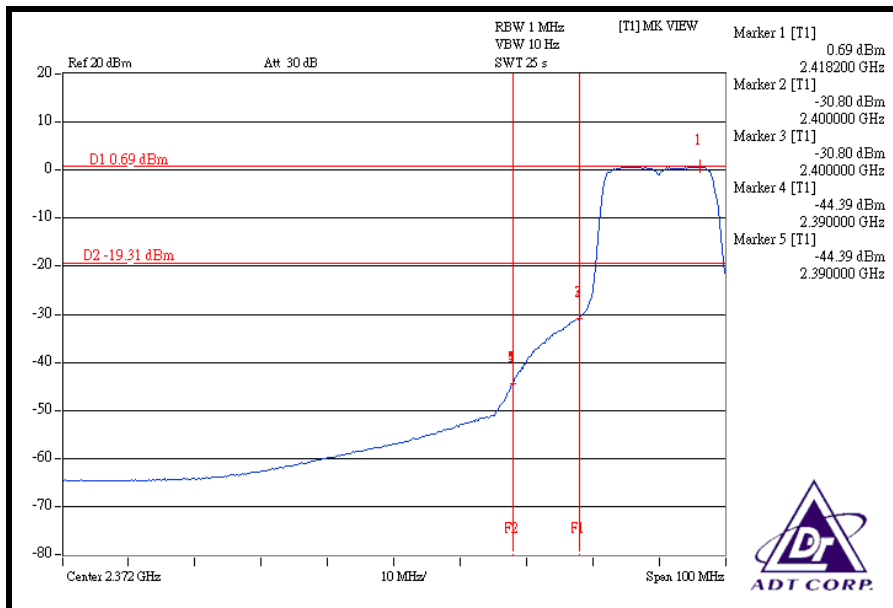
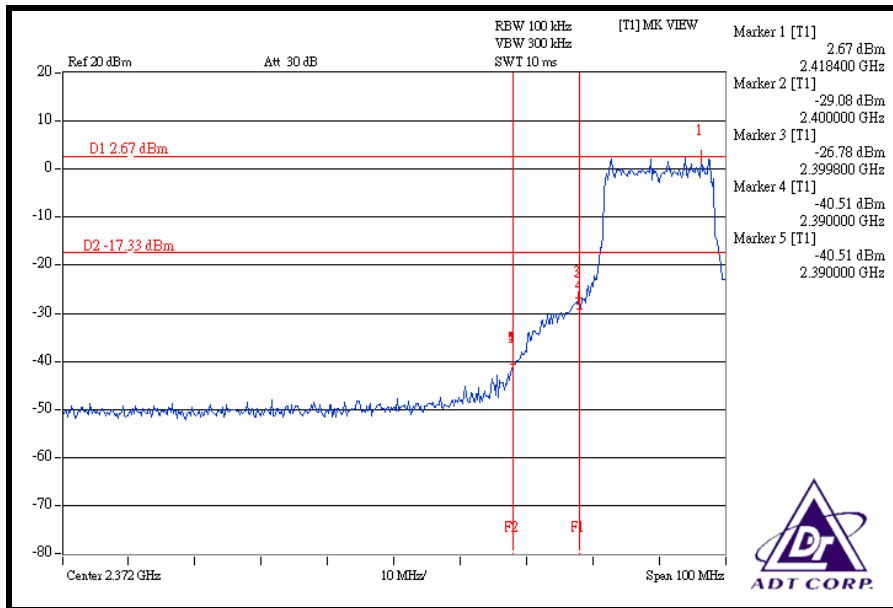

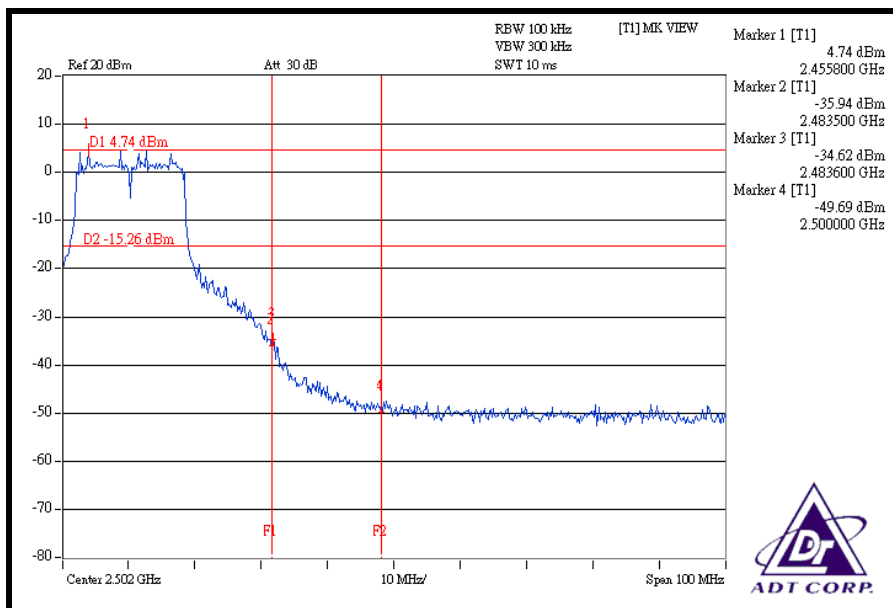
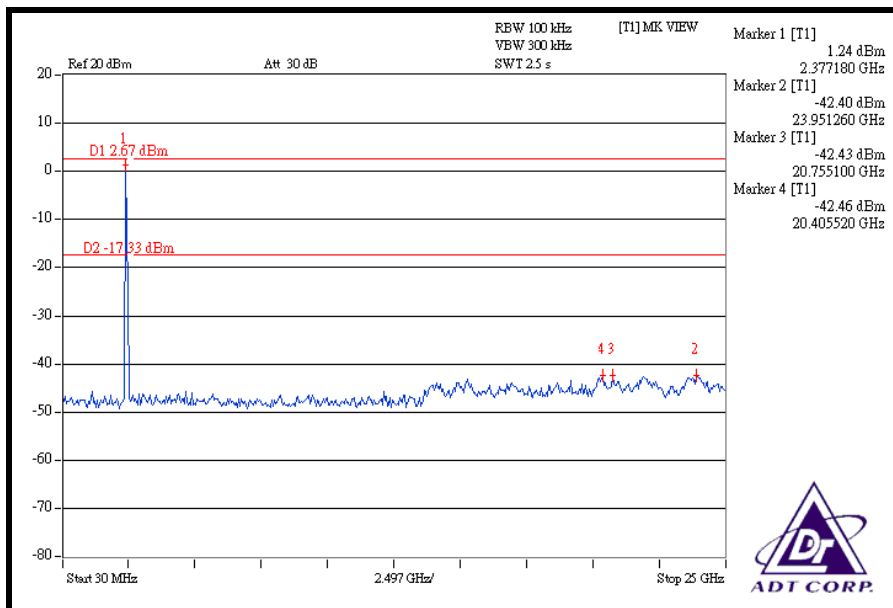

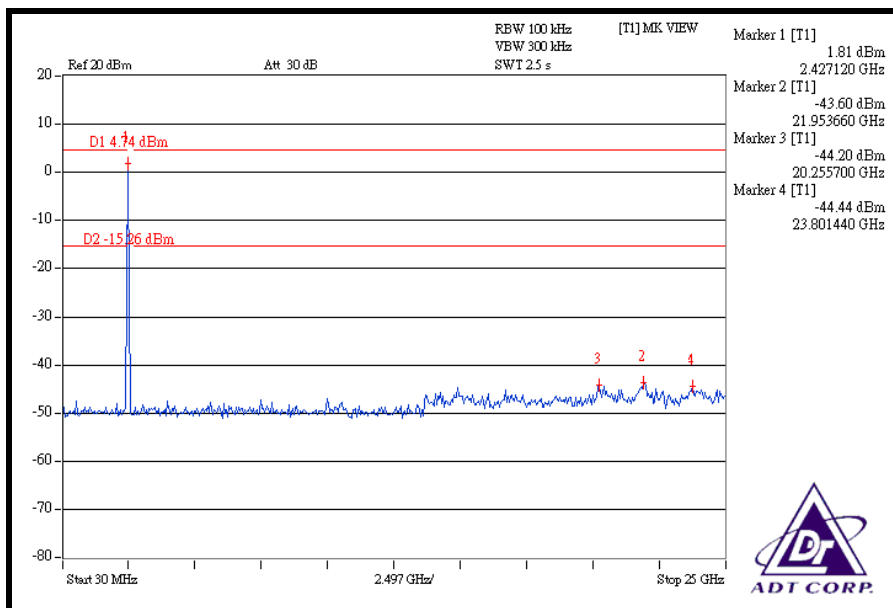
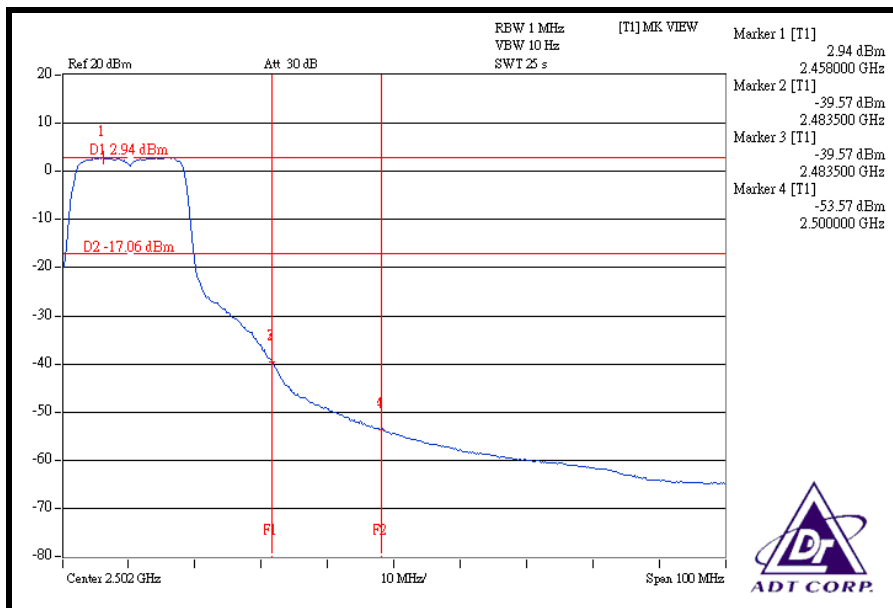



4.7 ANTENNA REQUIREMENT

4.7.1 STANDARD APPLICABLE

For intentional device, according to FCC 47 CFR Section 15.203, an intentional radiator shall be designed to ensure that no antenna other than that furnished by the responsible party shall be used with the device. And according to FCC 47 CFR Section 15.247 (b), if transmitting antennas of directional gain greater than 6dBi are used, the power shall be reduced by the amount in dB that the directional gain of the antenna exceeds 6dBi.

4.7.2 ANTENNA CONNECTED CONSTRUCTION

The antenna used in this product is PIFA antenna without connector. The maximum Gain of the antenna is 1dBi.



5. PHOTOGRAPHS OF THE TEST CONFIGURATION

Please refer to the attached file (Test Setup Photo).



6. INFORMATION ON THE TESTING LABORATORIES

We, ADT Corp., were founded in 1988 to provide our best service in EMC, Radio, Telecom and Safety consultation. Our laboratories are accredited and approved by the following approval agencies according to ISO/IEC 17025.

USA	FCC, UL, A2LA
GERMANY	TUV Rheinland
JAPAN	VCCI
NORWAY	NEMKO
CANADA	INDUSTRY CANADA , CSA
R.O.C.	TAF, BSMI, NCC
NETHERLANDS	Telefication
SINGAPORE	GOST-ASIA (MOU)
RUSSIA	CERTIS (MOU)

Copies of accreditation certificates of our laboratories obtained from approval agencies can be downloaded from our web site: www.adt.com.tw/index.5/phtml.
If you have any comments, please feel free to contact us at the following:

Linko EMC/RF Lab:
Tel: 886-2-26052180
Fax: 886-2-26051924

Hsin Chu EMC/RF Lab:
Tel: 886-3-5935343
Fax: 886-3-5935342

Hwa Ya EMC/RF/Safety Telecom Lab:
Tel: 886-3-3183232
Fax: 886-3-3185050

Web Site: www.adt.com.tw

The address and road map of all our labs can be found in our web site also.



7. APPENDIX A - MODIFICATIONS RECORDERS FOR ENGINEERING CHANGES TO THE EUT BY THE LAB

No any modifications are made to the EUT by the lab during the test