



A D T

FCC TEST REPORT (PART 24)

REPORT NO.: RF130312C18J-1

MODEL NO.: PO60100

FCC ID: NM8PO60100

RECEIVED: Mar. 15, 2013

TESTED: Mar. 27, 2013 ~ Apr. 08, 2013

ISSUED: Oct. 02, 2013

APPLICANT: HTC Corporation

ADDRESS: No. 23, Xinghua Rd., Taoyuan 330, Taiwan, R.O.C.

ISSUED BY: Bureau Veritas Consumer Products Services
(H.K.) Ltd., Taoyuan Branch

LAB ADDRESS: No. 47, 14th Ling, Chia Pau Vil., Lin Kou Dist., New
Taipei City, Taiwan (R.O.C.)

TEST LOCATION: No. 19, Hwa Ya 2nd Rd, Wen Hwa Tsuen, Kwei
Shan Hsiang, Taoyuan Hsien 333, Taiwan, R.O.C.

This report should not be used by the client to claim product certification, approval, or endorsement by TAF or any government agencies.



This report is for your exclusive use. Any copying or replication of this report to or for any other person or entity, or use of our name or trademark, is permitted only with our prior written permission. This report sets forth our findings solely with respect to the test samples identified herein. The results set forth in this report are not indicative or representative of the quality or characteristics of the lot from which a test sample was taken or any similar or identical product unless specifically and expressly noted. Our report includes all of the tests requested by you and the results thereof based upon the information that you provided to us. You have 60 days from date of issuance of this report to notify us of any material error or omission caused by our negligence, provided, however, that such notice shall be in writing and shall specifically address the issue you wish to raise. A failure to raise such issue within the prescribed time shall constitute your unqualified acceptance of the completeness of this report, the tests conducted and the correctness of the report contents. Unless specific mention, the uncertainty of measurement has been explicitly taken into account to declare the compliance or non-compliance to the specification



TABLE OF CONTENTS

RELEASE CONTROL RECORD.....	4
1 CERTIFICATION	5
2 SUMMARY OF TEST RESULTS	6
2.1 MEASUREMENT UNCERTAINTY	6
2.2 TEST SITE AND INSTRUMENTS	7
3 GENERAL INFORMATION.....	8
3.1 GENERAL DESCRIPTION OF EUT.....	8
3.2 CONFIGURATION OF SYSTEM UNDER TEST	9
3.3 DESCRIPTION OF SUPPORT UNITS	10
3.4 TEST ITEM AND TEST CONFIGURATION	11
3.5 EUT OPERATING CONDITIONS	12
3.6 GENERAL DESCRIPTION OF APPLIED STANDARDS	12
4 TEST TYPES AND RESULTS.....	13
4.1 OUTPUT POWER MEASUREMENT	13
4.1.1 LIMITS OF OUTPUT POWER MEASUREMENT	13
4.1.2 TEST PROCEDURES	13
4.1.3 TEST SETUP	14
4.1.4 TEST RESULTS	15
4.2 FREQUENCY STABILITY MEASUREMENT	17
4.2.1 LIMITS OF FREQUENCY STABILITY MEASUREMENT	17
4.2.2 TEST PROCEDURE	17
4.2.3 TEST SETUP	17
4.2.4 TEST RESULTS	18
4.3 OCCUPIED BANDWIDTH MEASUREMENT	19
4.3.1 TEST PROCEDURES	19
4.3.2 TEST SETUP	19
4.3.3 TEST RESULTS	20
4.4 PEAK TO AVERAGE RATIO	21
4.4.1 LIMITS OF PEAK TO AVERAGE RATIO MEASUREMENT	21
4.4.2 TEST SETUP	21
4.4.3 TEST PROCEDURES	21
4.4.4 TEST RESULTS	22
4.5 BAND EDGE MEASUREMENT	23
4.5.1 LIMITS OF BAND EDGE MEASUREMENT	23
4.5.2 TEST SETUP	23
4.5.3 TEST PROCEDURES	23
4.5.4 TEST RESULTS	24
4.6 CONDUCTED SPURIOUS EMISSIONS.....	25
4.6.1 LIMITS OF CONDUCTED SPURIOUS EMISSIONS MEASUREMENT	25
4.6.2 TEST PROCEDURE	25
4.6.3 TEST SETUP	25
4.6.4 TEST RESULTS	26
4.7 RADIATED EMISSION MEASUREMENT	27
4.7.1 LIMITS OF RADIATED EMISSION MEASUREMENT	27
4.7.2 TEST PROCEDURES	27
4.7.3 DEVIATION FROM TEST STANDARD	27
4.7.4 TEST SETUP	28
4.7.5 TEST RESULTS	29
5 PHOTOGRAPHS OF THE TEST CONFIGURATION.....	33



A D T

6	INFORMATION ON THE TESTING LABORATORIES.....	34
7	APPENDIX A – MODIFICATIONS RECORDERS FOR ENGINEERING CHANGES TO THE EUT BY THE LAB.....	35



A D T

RELEASE CONTROL RECORD

ISSUE NO.	REASON FOR CHANGE	DATE ISSUED
RF130312C18J-1	Original release	Oct. 02, 2013



1 CERTIFICATION

PRODUCT: Smartphone
MODEL: PO60100
BRAND: HTC
APPLICANT: HTC Corporation
TESTED: Mar. 27, 2013 ~ Apr. 08, 2013
TEST SAMPLE: Production Unit
STANDARDS: FCC Part 24, Subpart E

The above equipment (model: PO60100) has been tested by **Bureau Veritas Consumer Products Services (H.K.) Ltd., Taoyuan Branch**, and found compliance with the requirement of the above standards. The test record, data evaluation & Equipment Under Test (EUT) configurations represented herein are true and accurate accounts of the measurements of the sample's EMC characteristics under the conditions specified in this report.

PREPARED BY : Vera Huang , **DATE** : Oct. 02, 2013
Vera Huang / Specialist

APPROVED BY : Sam chen , **DATE** : Oct. 02, 2013
Sam Chen / Assistant Manager



A D T

2 SUMMARY OF TEST RESULTS

The EUT has been tested according to the following specifications:

APPLIED STANDARD: FCC Part 24 & Part 2			
STANDARD SECTION	TEST TYPE	RESULT	REMARK
2.1046 24.232	Equivalent isotropically radiated power	PASS	Meet the requirement of limit.
2.1055 24.235	Frequency Stability	PASS	Meet the requirement of limit.
2.1049 24.238(b)	Occupied Bandwidth	PASS	Meet the requirement of limit.
24.232(d)	Peak to average ratio	PASS	Meet the requirement of limit.
24.238(b)	Band Edge Measurements	PASS	Meet the requirement of limit.
2.1051 24.238	Conducted Spurious Emissions	PASS	Meet the requirement of limit.
2.1053 24.238	Radiated Spurious Emissions	PASS	Meet the requirement of limit. Minimum passing margin is -31.49dB at 5640.00MHz.

2.1 MEASUREMENT UNCERTAINTY

Where relevant, the following measurement uncertainty levels have been estimated for tests performed on the EUT as specified in CISPR 16-4-2:

MEASUREMENT	FREQUENCY	UNCERTAINTY
Conducted emissions	150kHz~30MHz	2.44 dB
Radiated emissions	30MHz ~ 200MHz	2.93 dB
	200MHz ~1000MHz	2.95 dB
	1GHz ~ 18GHz	2.26 dB
	18GHz ~ 40GHz	1.94 dB

This uncertainty represents an expanded uncertainty expressed at approximately the 95% confidence level using a coverage factor of k=2.



A D T

2.2 TEST SITE AND INSTRUMENTS

DESCRIPTION & MANUFACTURER	MODEL NO.	SERIAL NO.	DATE OF CALIBRATION	DUE DATE OF CALIBRATION
Test Receiver ROHDE & SCHWARZ	ESCI	100744	Apr. 19, 2012	Apr. 18, 2013
Spectrum Analyzer ROHDE & SCHWARZ	FSU43	101261	Dec. 17, 2012	Dec. 16, 2013
BILOG Antenna SCHWARZBECK	VULB9168	9168-472	Mar. 25, 2013	Mar. 24, 2014
HORN Antenna SCHWARZBECK	BBHA 9120 D	9120D-969	Jan. 07, 2013	Jan. 06, 2014
HORN Antenna SCHWARZBECK	BBHA 9170	9170-480	Dec. 25, 2012	Dec. 24, 2013
Loop Antenna	HFH2-Z2	100070	Jan. 31, 2012	Jan. 30, 2014
Preamplifier EMCI	EMC 012645	980115	Dec. 28, 2012	Dec. 27, 2013
Preamplifier EMCI	EMC 184045	980116	Dec. 28, 2012	Dec. 27, 2013
Preamplifier EMCI	EMC 330H	980112	Dec. 28, 2012	Dec. 27, 2013
RF signal cable HUBER+SUHNNER	SUCOFLEX 104	309219/4	Oct. 19, 2012	Oct. 18, 2013
RF signal cable HUBER+SUHNNER	SUCOFLEX 104	250130/4	Oct. 19, 2012	Oct. 18, 2013
RF signal cable Worken	RG-213	NA	Dec. 29, 2012	Dec. 28, 2013
Software	E3 6.120103	NA	NA	NA
Antenna Tower MF	MFA-440H	NA	NA	NA
Turn Table MF	MFT-201SS	NA	NA	NA
Antenna Tower & Turn Table Controller MF	MF-7802	NA	NA	NA

- NOTE:**
1. The calibration interval of the above test instruments is 12 months and the calibrations are traceable to NML/ROC and NIST/USA.
 2. The calibration interval of the loop antenna is 24 months and the calibrations are traceable to NML/ROC and NIST/USA.
 3. The test was performed in HwaYa Chamber 10.
 4. The horn antenna and HP preamplifier (model: 8449B) are used only for the measurement of emission frequency above 1GHz if tested.
 5. The FCC Site Registration No. is 690701.
 6. The IC Site Registration No. is IC 7450F-10.



3 GENERAL INFORMATION

3.1 GENERAL DESCRIPTION OF EUT

EUT	Smartphone	
MODEL NO.	PO60100	
POWER SUPPLY	5.0Vdc (adapter or host equipment) 3.7Vdc (battery)	
IMEI	356233050016507	
MODULATION TYPE	GSM/GPRS	GMSK
	EDGE	8PSK
FREQUENCY RANGE	GSM/GPRS/EDGE	1850.2MHz ~ 1909.8MHz
MAX. EIRP POWER	GSM	753.36mW
	EDGE	335.74mW
EMISSION DESIGNATOR	GSM	247KGXW
	EDGE	245KG7W
MULTI-SLOTS CLASS	12	
ANTENNA TYPE	Fixed Internal Antenna	
I/O PORTS	Refer to users' manual	
DATA CABLE	Refer to NOTE as below	
ACCESSORY DEVICES	Refer to NOTE as below	

NOTE:

1. The EUT's accessories list refers to EUT photo.
2. The above EUT information was declared by manufacturer and for more detailed features description, please refer to the manufacturer's specifications or User's Manual.

3.2 CONFIGURATION OF SYSTEM UNDER TEST

FOR RADIATION EMISSION TEST

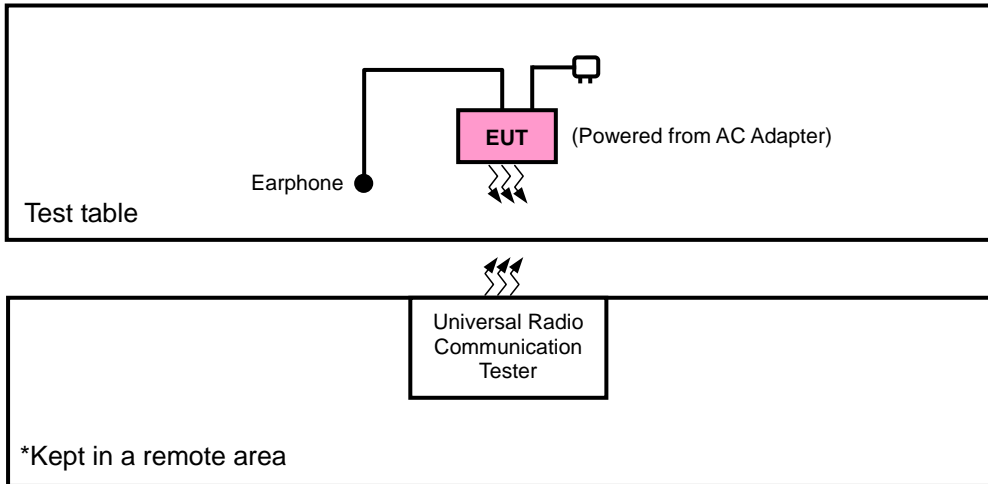

FOR E.I.R.P. TEST

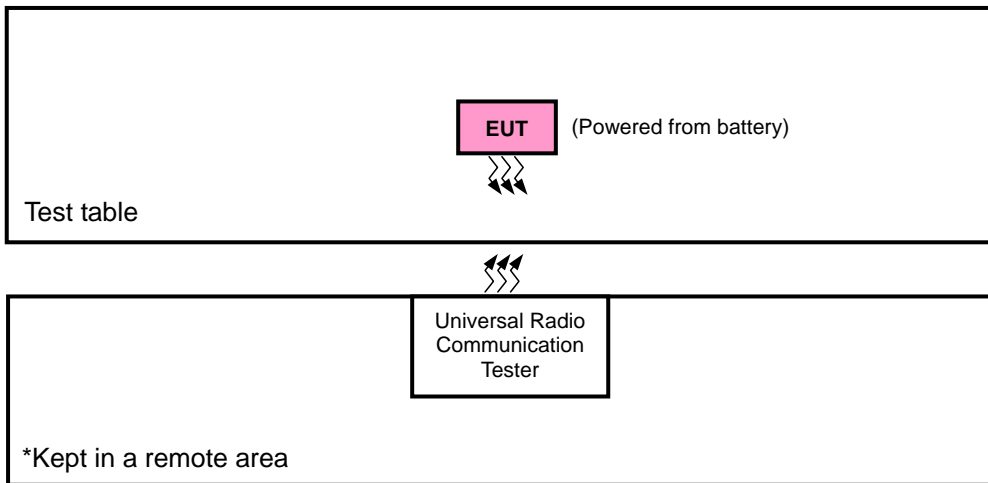



3.3 DESCRIPTION OF SUPPORT UNITS

The EUT has been tested as an independent unit together with other necessary accessories or support units. The following support units or accessories were used to form a representative test configuration during the tests.

NO.	PRODUCT	BRAND	MODEL NO.	SERIAL NO.	FCC ID
1	Communications Tester-Wireless	Agilent	8960 Series 10	MY50260642	NA

NO.	SIGNAL CABLE DESCRIPTION OF THE ABOVE SUPPORT UNITS
1	NA

NOTE:

1. All power cords of the above support units are non shielded (1.8m).
2. Items 1 acted as communication partners.



3.4 TEST ITEM AND TEST CONFIGURATION

Pre-Scan has been conducted to determine the worst-case mode from all possible combinations between available modulations, data rates, XYZ axis and antenna ports. The worst case was found when positioned on **X-axis** for EIRP and **Y-axis** for radiated emission. Following channel(s) was (were) selected for the final test as listed below:

GSM MODE

TEST ITEM	AVAILABLE CHANNEL	TESTED CHANNEL	MODE
EIRP	512 to 810	512, 661, 810	GSM, EDGE
FREQUENCY STABILITY	512 to 810	661	GSM, EDGE
OCCUPIED BANDWIDTH	512 to 810	512, 661, 810	GSM, EDGE
PEAK TO AVERAGE RATIO	512 to 810	512, 661, 810	GSM, EDGE
BAND EDGE	512 to 810	512, 810	GSM, EDGE
CONDCUDED EMISSION	512 to 810	661	GSM, EDGE
RADIATED EMISSION	512 to 810	661	GSM, EDGE

TEST CONDITION:

TEST ITEM	ENVIRONMENTAL CONDITIONS	INPUT POWER	TESTED BY
EIRP	26deg. C, 58%RH	3.7Vdc	Howard Kao
FREQUENCY STABILITY	26deg. C, 58%RH	3.7Vdc	Howard Kao
OCCUPIED BANDWIDTH	26deg. C, 58%RH	3.7Vdc	Howard Kao
BAND EDGE	26deg. C, 58%RH	3.7Vdc	Howard Kao
CONDCUDED EMISSION	26deg. C, 58%RH	3.7Vdc	Howard Kao
RADIATED EMISSION	25deg. C, 65%RH	120Vac, 60Hz	Kay Wu

3.5 EUT OPERATING CONDITIONS

The EUT makes a call to the communication simulator. The communication simulator station system controlled a EUT to export maximum output power under transmission mode and specific channel frequency

3.6 GENERAL DESCRIPTION OF APPLIED STANDARDS

The EUT is a RF product. According to the specifications of the manufacturer, it must comply with the requirements of the following standards:

FCC 47 CFR Part 2

FCC 47 CFR Part 24

ANSI/TIA/EIA-603-C 2004

NOTE: All test items have been performed and recorded as per the above standards.

4 TEST TYPES AND RESULTS

4.1 OUTPUT POWER MEASUREMENT

4.1.1 LIMITS OF OUTPUT POWER MEASUREMENT

Mobile and portable stations are limited to 2 watts EIRP

4.1.2 TEST PROCEDURES

EIRP MEASUREMENT:

- a. All measurements were done at low, middle and high operational frequency range. RBW and VBW is 1MHz for GSM, GPRS & EDGE, and 5MHz for CDMA & WCDMA mode.
- b. Substitution method is used for E.I.R.P measurement. In the semi-anechoic chamber, EUT placed on the 0.8m height of Turn Table, rotated the table around 360 degrees to search the maximum radiation power and receiver antenna shall be rotated vertical and horizontal polarization and moved height from 1m to 4m to find the maximum polar radiated power. The “Read Value” is the spectrum reading the maximum power value.
- c. The substitution horn antenna is substituted for EUT at the same position and signals generator export the CW signal to the substitution antenna via a tx cable. Rotated the Turn Table and moved receiving antenna to find the maximum radiation power. Adjust output power level of S.G to get a Value of spectrum reading equal to “Read Value” of step b. Record the power level of S.G
- d. $EIRP = \text{Output power level of S.G} - \text{TX cable loss} + \text{Antenna gain of substitution horn.}$

CONDUCTED POWER MEASUREMENT:

The EUT was set up for the maximum power with GSM, GPRS, EDGE & WCDMA link data modulation and link up with simulator. Set the EUT to transmit under low, middle and high channel and record the power level shown on simulator.

4.1.3 TEST SETUP

EIRP / ERP MEASUREMENT:

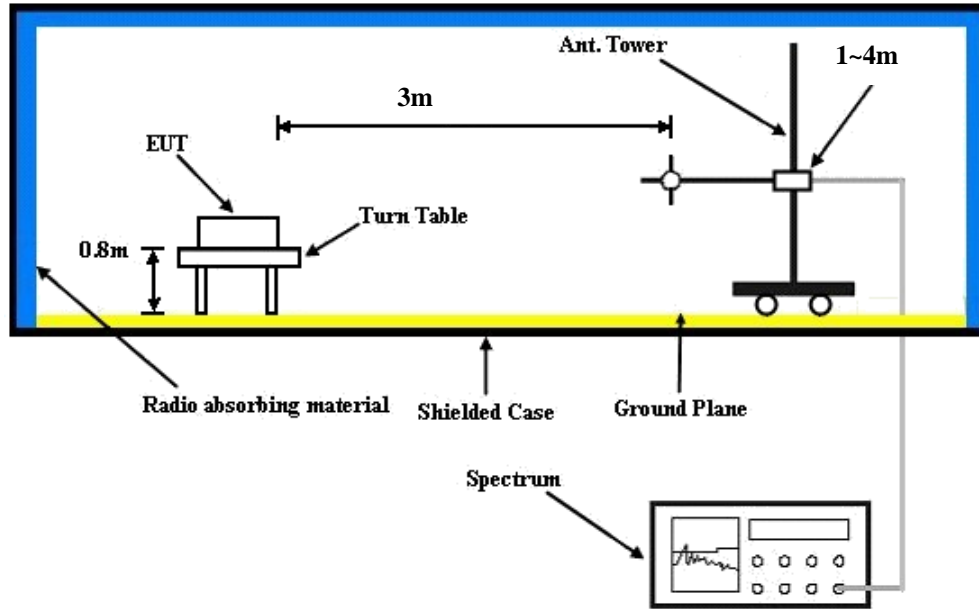

CONDUCTED POWER MEASUREMENT:

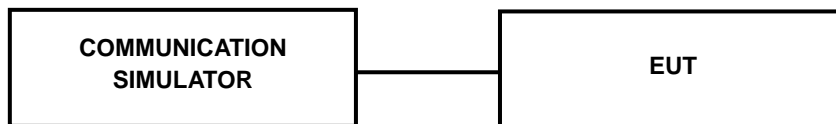

4.1.4 TEST RESULTS

CONDUCTED OUTPUT POWER (dBm)

Band	GSM1900		
	512	661	810
Channel	1850.2	1880.0	1909.8
Frequency (MHz)	1850.2	1880.0	1909.8
GSM (1 Uplink)	30.12	30.02	30.00
GPRS 8 (GMSK, 1 slot)	30.11	30.01	29.99
GPRS 10 (GMSK, 2 slot)	29.56	29.46	29.44
GPRS 11 (GMSK, 3 slot)	27.66	27.56	27.54
GPRS 12 (GMSK, 4 slot)	26.55	26.45	26.43
EDGE 8 (GMSK, 1 Uplink)	26.60	26.50	26.48
EDGE 10 (GMSK, 2 Uplink)	26.60	26.50	26.48
EDGE 11 (GMSK, 3 Uplink)	26.58	26.48	26.46
EDGE 12 (GMSK, 4 Uplink)	26.55	26.45	26.43
EDGE 8 (8PSK, 1 Uplink)	26.63	26.53	26.51
EDGE 10 (8PSK, 2 Uplink)	25.61	25.51	25.49
EDGE 11 (8PSK, 3 Uplink)	25.59	25.49	25.47
EDGE 12 (8PSK, 4 Uplink)	24.07	23.97	23.95



A D T

EIRP POWER (dBm)

GSM

Plane	Channel	Frequency (MHz)	LVL (dBm)	Correction Factor(dB)	EIRP(dBm)	EIRP(mW)	Polarization (H/V)
X	512	1850.2	-9.85	38.19	28.34	682.34	H
	661	1880.0	-10.56	38.70	28.14	651.63	H
	810	1909.8	-9.66	38.43	28.77	753.36	H
	512	1850.2	-18.21	38.48	20.27	106.41	V
	661	1880.0	-18.03	38.59	20.56	113.76	V
	810	1909.8	-18.14	38.87	20.73	118.30	V

EDGE

Plane	Channel	Frequency (MHz)	LVL (dBm)	Correction Factor(dB)	EIRP(dBm)	EIRP(mW)	Polarization (H/V)
X	512	1850.2	-13.15	38.19	25.04	319.15	H
	661	1880.0	-13.52	38.70	25.18	329.61	H
	810	1909.8	-13.17	38.43	25.26	335.74	H
	512	1850.2	-19.93	38.48	18.55	71.61	V
	661	1880.0	-19.70	38.59	18.89	77.45	V
	810	1909.8	-19.86	38.87	19.01	79.62	V

4.2 FREQUENCY STABILITY MEASUREMENT

4.2.1 LIMITS OF FREQUENCY STABILITY MEASUREMENT

The frequency stability shall be sufficient to ensure that the fundamental emission stays within the authorized frequency block.

4.2.2 TEST PROCEDURE

- a. Device is placed at the oven room. The oven room could control the temperatures and humidity. Power warm up is at least 15 min and power applied should perform before recording frequency error.
- b. EUT is connected the external power supply to control the DC input power. The test voltage range is from minimum to maximum working voltage. Each step shall be record the frequency error rate.
- c. The temperature range step is 10 degrees in this test items. All temperature levels shall be hold the $\pm 0.5^{\circ}\text{C}$ during the measurement testing. The each temperature step shall be at least 0.5 hours, consider the EUT could be test under the stability condition.

NOTE: The frequency error was recorded frequency error from the communication simulator.

4.2.3 TEST SETUP

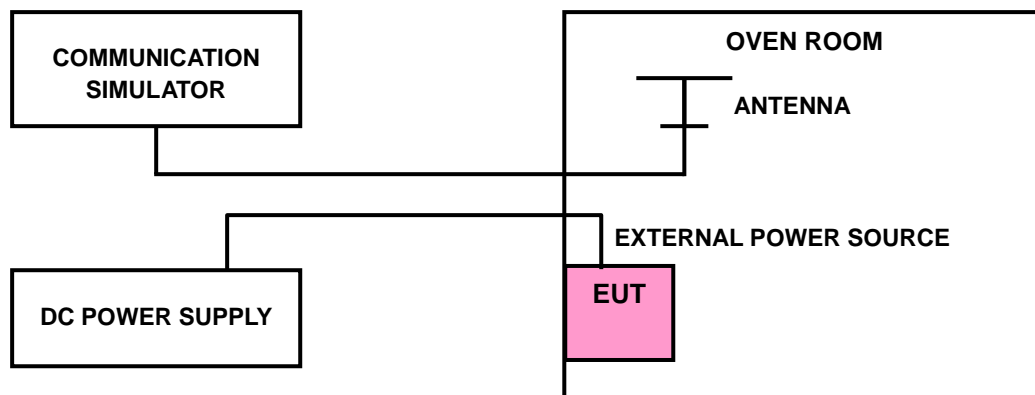

4.2.4 TEST RESULTS

FREQUENCY ERROR V.S VOLTAGE

VOLTAGE (Volts)	FREQUENCY ERROR (ppm)		LIMIT (ppm)
	GSM	EDGE	
3.7	-0.03	-0.03	2.5
3.6	-0.04	-0.04	2.5
4.2	-0.04	-0.04	2.5

NOTE: The applicant defined the normal working voltage of the battery is from 3.6Vdc to 4.2Vdc.

FREQUENCY ERROR V.S TEMPERATURE

TEMP. (°C)	FREQUENCY ERROR (ppm)		LIMIT (ppm)
	GSM	EDGE	
-30	-0.03	-0.04	2.5
-20	-0.03	-0.04	2.5
-10	-0.03	-0.04	2.5
0	-0.04	-0.04	2.5
10	-0.04	-0.04	2.5
20	-0.03	-0.04	2.5
30	-0.03	-0.03	2.5
40	-0.03	-0.04	2.5
50	-0.04	-0.04	2.5
55	-0.04	-0.04	2.5

4.3 OCCUPIED BANDWIDTH MEASUREMENT

4.3.1 TEST PROCEDURES

The EUT makes a call to the communication simulator. All measurements were done at low, middle and high operational frequency range. The communication simulator station system controlled a EUT to export maximum output power under transmission mode and specific channel frequency. Use OBW measurement function of Spectrum analyzer to measure 99 % occupied bandwidth.

4.3.2 TEST SETUP

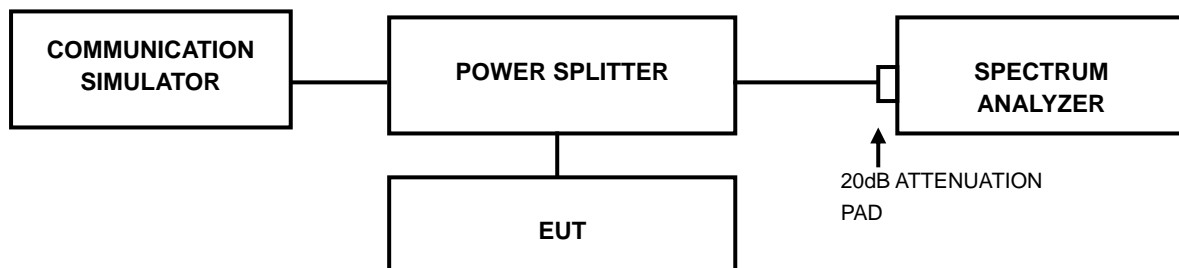



A D T

4.3.3 TEST RESULTS

CHANNEL	FREQUENCY (MHz)	99% OCCUPIED BANDWIDTH (kHz)	
		GSM	EDGE
512	1850.2	246.59	243.15
661	1880.0	243.54	243.14
810	1909.8	243.38	244.70

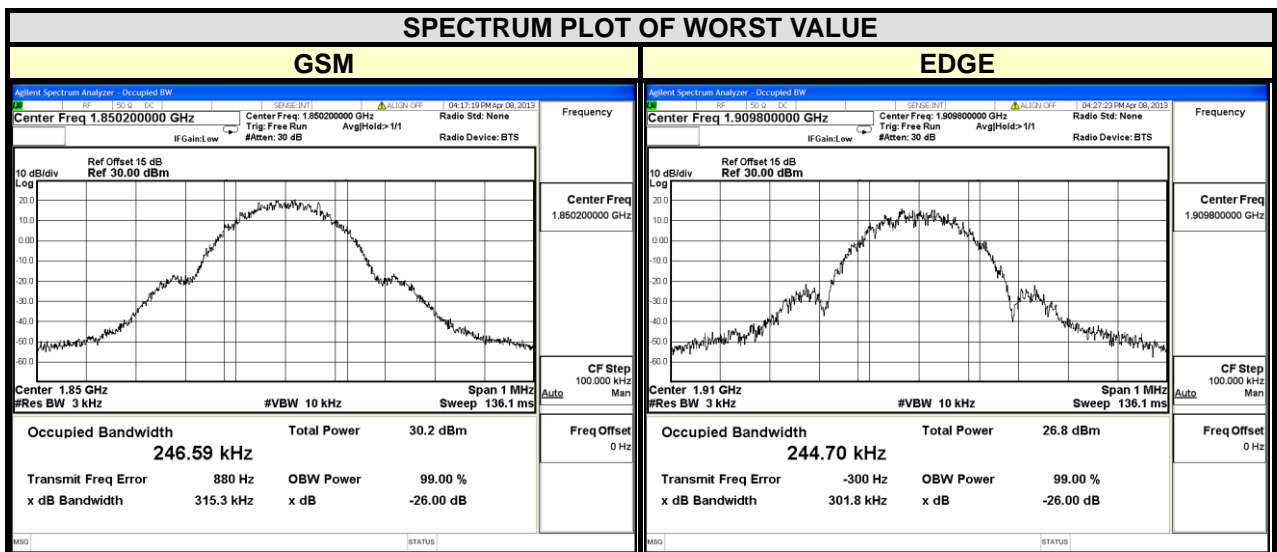

4.4 PEAK TO AVERAGE RATIO

4.4.1 LIMITS OF PEAK TO AVERAGE RATIO MEASUREMENT

In measuring transmissions in this band using an average power technique, the peak to-average ratio (PAR) of the transmission may not exceed 13 dB

4.4.2 TEST SETUP

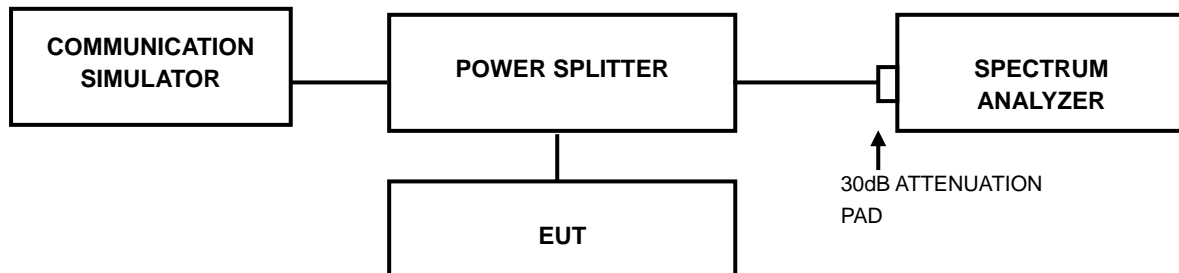

4.4.3 TEST PROCEDURES

1. Set resolution/measurement bandwidth \geq signal's occupied bandwidth;
2. Set the number of counts to a value that stabilizes the measured CCDF curve;
3. Record the maximum PAPR level associated with a probability of 0.1%.



A D T

4.4.4 TEST RESULTS

CHANNEL	FREQUENCY (MHz)	PEAK TO AVERAGE RATIO (dB)	
		GSM	EDGE
512	1850.2	0.09	3.16
661	1880.0	0.09	3.15
810	1909.8	0.09	3.17

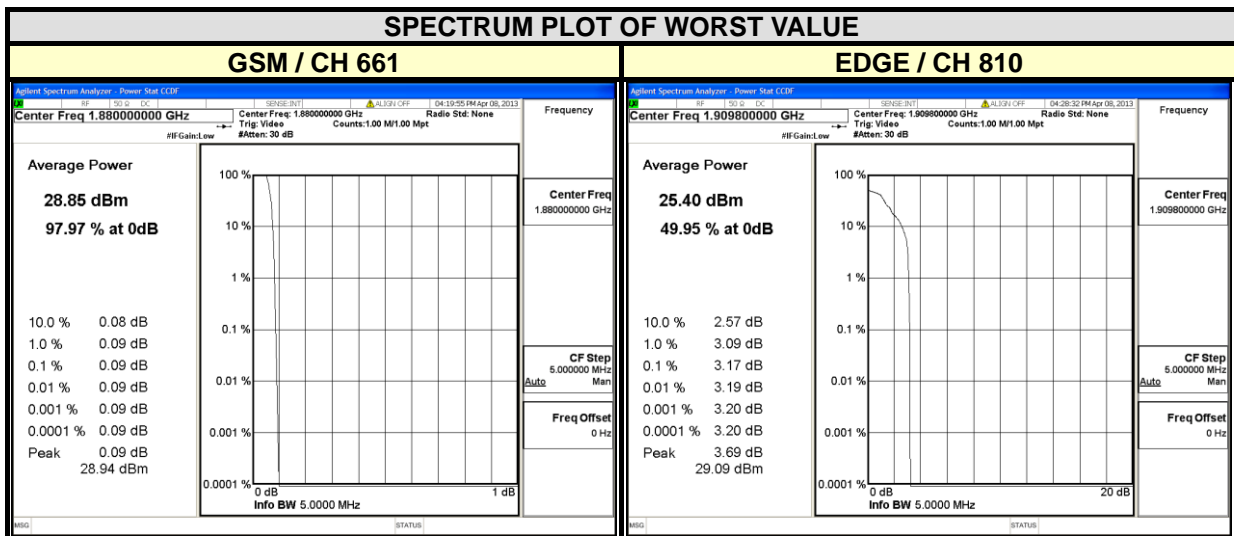

4.5 BAND EDGE MEASUREMENT

4.5.1 LIMITS OF BAND EDGE MEASUREMENT

Power of any emission outside of the authorized operating frequency ranges must be attenuated below the transmitting power (P) by a factor of at least $43 + 10 \log(P)$ dB. In the 1 MHz bands immediately outside and adjacent to the frequency block a resolution bandwidth of at least one percent of the emission bandwidth of the fundamental emission of the transmitter may be employed.

4.5.2 TEST SETUP

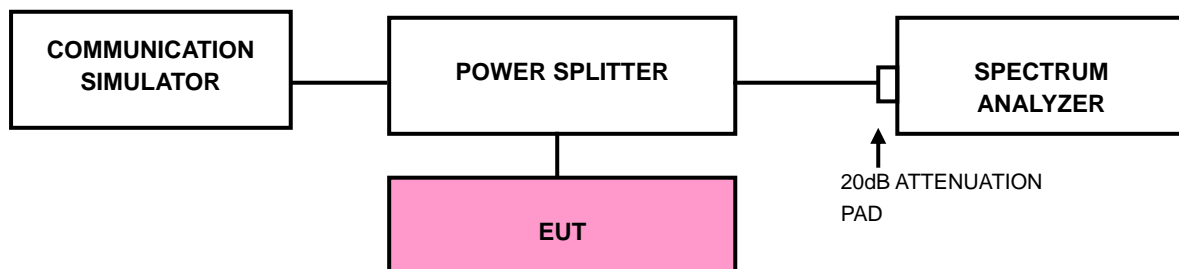

4.5.3 TEST PROCEDURES

- All measurements were done at low and high operational frequency range.
- The center frequency of spectrum is the band edge frequency and span is 1 MHz. RB of the spectrum is 3kHz and VB of the spectrum is 10kHz (GSM/GPRS/ EDGE).
- The center frequency of spectrum is the band edge frequency and span is 1 MHz. RB of the spectrum is 13kHz and VB of the spectrum is 51kHz (CDMA).
- The center frequency of spectrum is the band edge frequency and span is 5MHz. RB of the spectrum is 100kHz and VB of the spectrum is 300kHz (WCDMA).
- Record the max trace plot into the test report.



A D T

4.5.4 TEST RESULTS

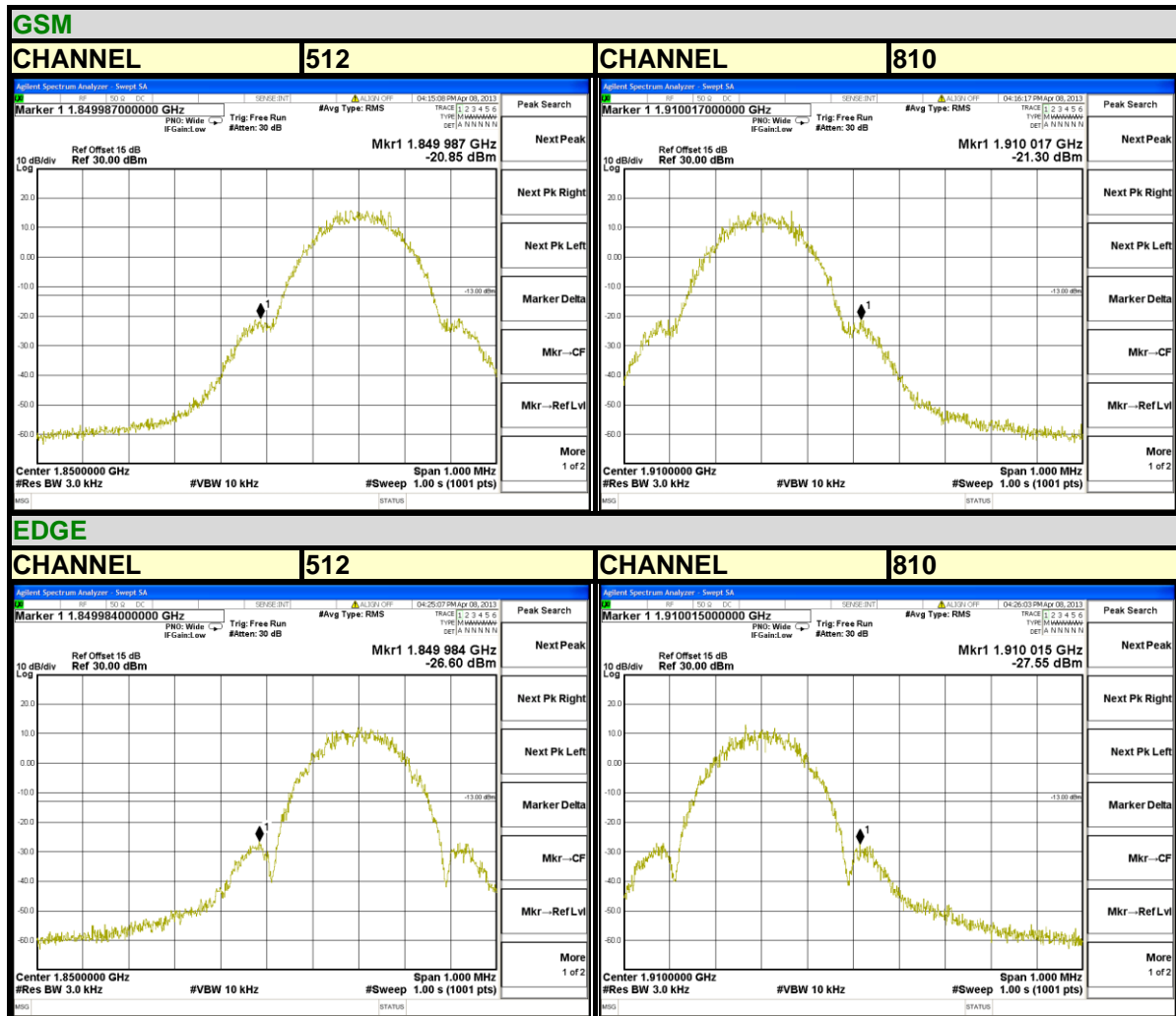

4.6 CONDUCTED SPURIOUS EMISSIONS

4.6.1 LIMITS OF CONDUCTED SPURIOUS EMISSIONS MEASUREMENT

The power of any emission outside of the authorized operating frequency ranges must be attenuated below the transmitting power (P) by a factor of at least $43 + 10 \log(P)$ dB. The emission limit equal to -13dBm .

4.6.2 TEST PROCEDURE

- The EUT makes a phone call to the communication simulator. All measurements were done at low, middle and high operational frequency range.
- Measuring frequency range is from 30 MHz to 19.1GHz. 10dB attenuation pad is connected with spectrum. RBW=1MHz and VBW=3MHz is used for conducted emission measurement.

4.6.3 TEST SETUP

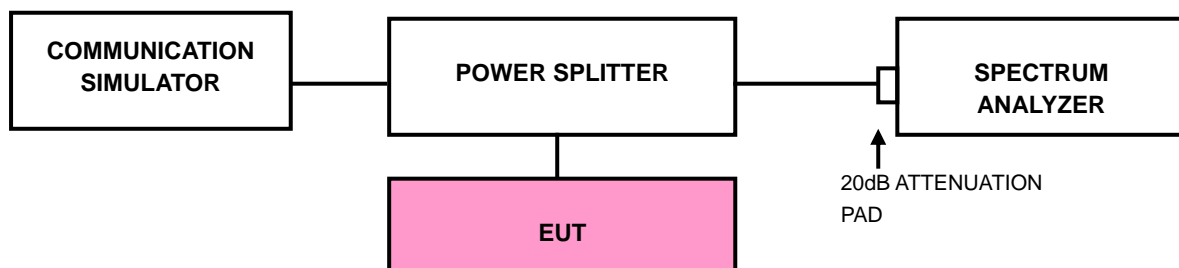



A D T

4.6.4 TEST RESULTS

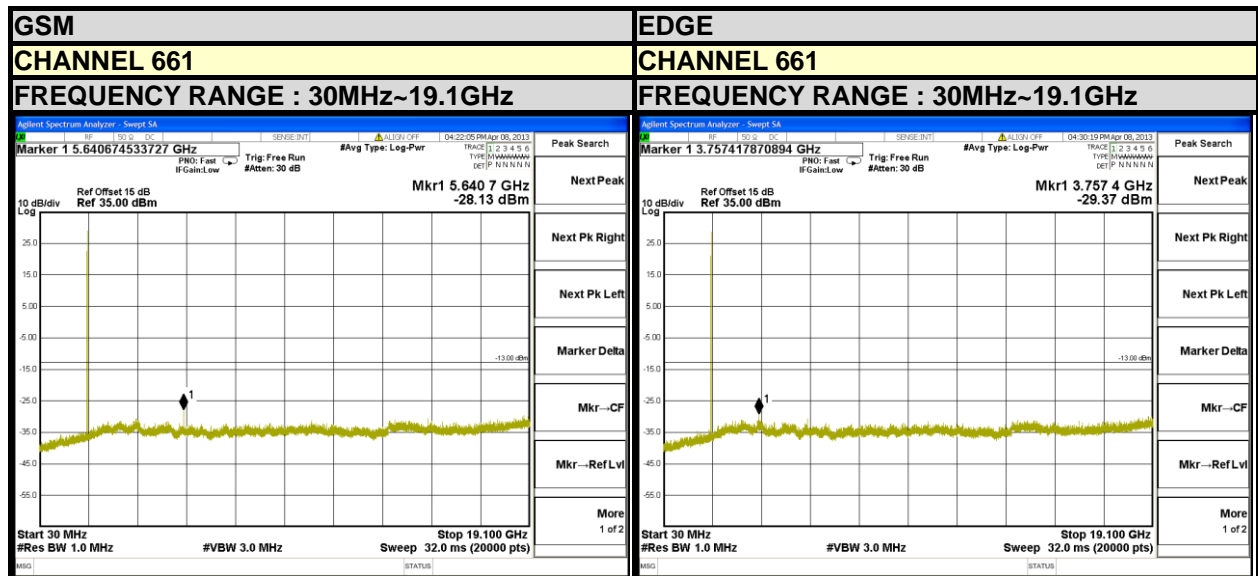

4.7 RADIATED EMISSION MEASUREMENT

4.7.1 LIMITS OF RADIATED EMISSION MEASUREMENT

The power of any emission outside of the authorized operating frequency ranges must be attenuated below the transmitting power (P) by a factor of at least $43 + 10 \log(P)$ dB. The emission limit equal to -13dBm .

4.7.2 TEST PROCEDURES

- a. Substitution method is used for E.I.R.P measurement. In the semi-anechoic chamber, EUT placed on the 0.8m height of Turn Table, rotated the table around 360 degrees to search the maximum radiation power and receiver antenna shall be rotated vertical and horizontal polarization and moved height from 1m to 4m to find the maximum polar radiated power. The “Read Value” is the spectrum reading the maximum power value.
- b. The substitution horn antenna is substituted for EUT at the same position and signals generator export the CW signal to the substitution antenna via a TX cable. Rotated the Turn Table and moved receiving antenna to find the maximum radiation power. Adjust output power level of S.G to get a Value of spectrum reading equal to “Read Value” of step a. Record the power level of S.G
- c. $\text{EIRP} = \text{Output power level of S.G} - \text{TX cable loss} + \text{Antenna gain of substitution horn}$.
- d. E.R.P power can be calculated form E.I.R.P power by subtracting the gain of dipole,
 $\text{E.R.P power} = \text{E.I.R.P power} - 2.15\text{dBi}$.

NOTE: The resolution bandwidth and video bandwidth of test receiver/spectrum analyzer is 1MHz/3MHz.

4.7.3 DEVIATION FROM TEST STANDARD

No deviation

4.7.4 TEST SETUP

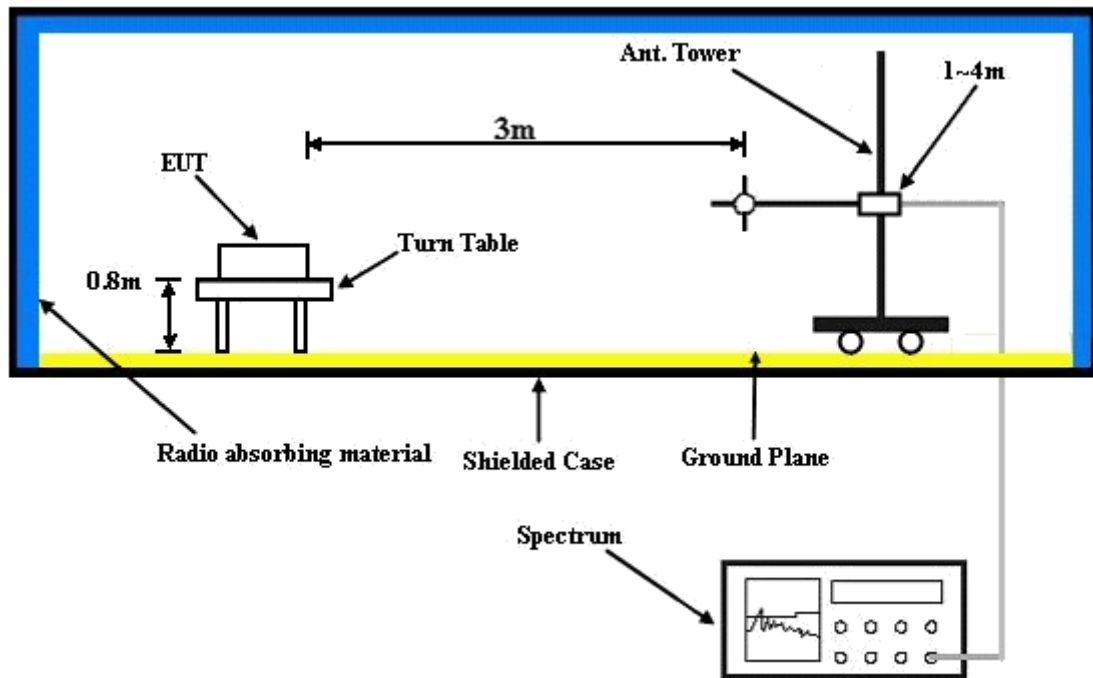

For the actual test configuration, please refer to the attached file (Test Setup Photo).



A D T

4.7.5 TEST RESULTS

GSM:



Bureau Veritas Consumer Products Services Ltd., Taoyuan Branch

A D T

Data: 15

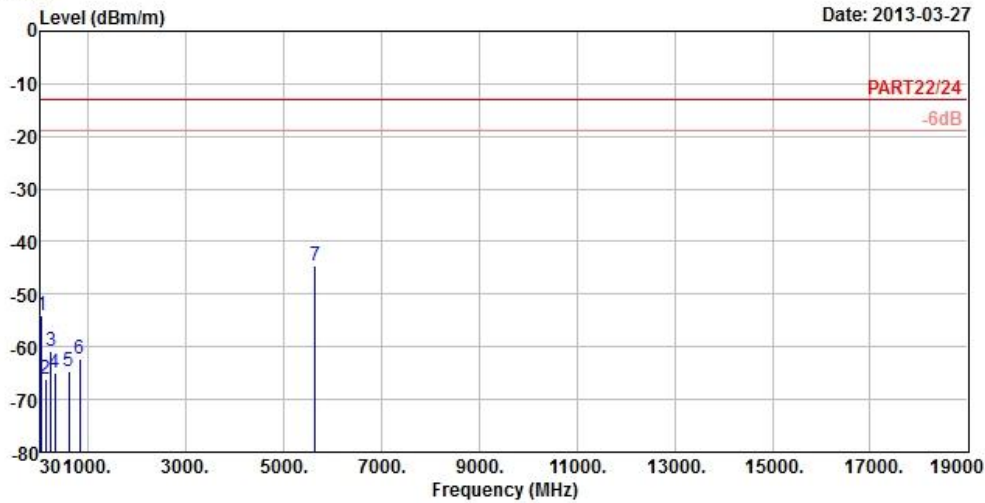

Site : 966 Chamber 5
 Condition : PART22/24 3m HORIZONTAL
 Brand/Model: P060100
 Remark : PCS1900 Link
 Tested by : Kay Wu
 Temperature : 25°C
 Humidity : 65%
 Plane : Y

	Freq	Level	Read	Limit	Over		
	MHz	dBm/m	Level	Line	Limit	Factor	Remark
			dBm	dBm/m	dB	dB/m	
1	43.23	-54.10	-52.84	-13.00	-41.10	-1.26	Peak
2	131.52	-66.27	-58.53	-13.00	-53.27	-7.74	Peak
3	237.63	-60.86	-54.61	-13.00	-47.86	-6.25	Peak
4	318.90	-64.96	-58.72	-13.00	-51.96	-6.24	Peak
5	614.30	-64.58	-64.47	-13.00	-51.58	-0.11	Peak
6	828.50	-62.41	-64.70	-13.00	-49.41	2.29	Peak
7 pp	5640.00	-44.49	-44.70	-13.00	-31.49	0.21	Peak



A D T



Bureau Veritas Consumer Products Services Ltd., Taoyuan Branch

A D T

Data: 16

Date: 2013-03-27

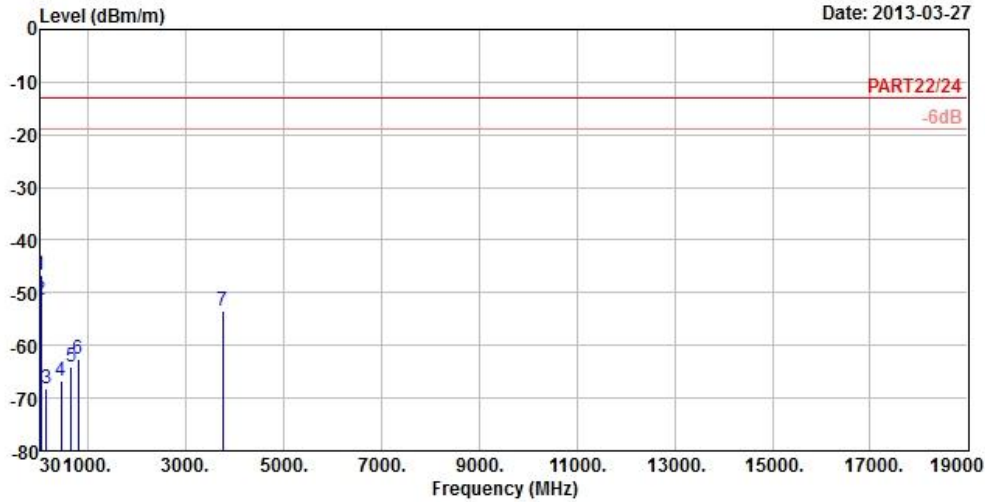

Site : 966 Chamber 5
 Condition : PART22/24 3m VERTICAL
 Brand/Model: P060100
 Remark : PCS1900 Link
 Tested by : Kay Wu
 Temperature : 25°C
 Humidity : 65%
 Plane : Y

	Freq	Level	Read	Limit	Over		
	MHz	dBm/m	Level	Line	Limit	Factor	Remark
			dBm	dBm/m	dB	dB/m	
1	pp	30.81	-46.68	-47.02	-13.00	-33.68	0.34 Peak
2		42.42	-51.47	-50.14	-13.00	-38.47	-1.33 Peak
3		144.21	-68.16	-62.18	-13.00	-55.16	-5.98 Peak
4		455.40	-66.85	-62.63	-13.00	-53.85	-4.22 Peak
5		651.40	-64.07	-64.65	-13.00	-51.07	0.58 Peak
6		798.40	-62.64	-64.76	-13.00	-49.64	2.12 Peak
7		3760.00	-53.56	-46.83	-13.00	-40.56	-6.73 Peak



A D T

EDGE:



Bureau Veritas Consumer Products Services Ltd., Taoyuan Branch

A D T

Data: 11

Date: 2013-03-27

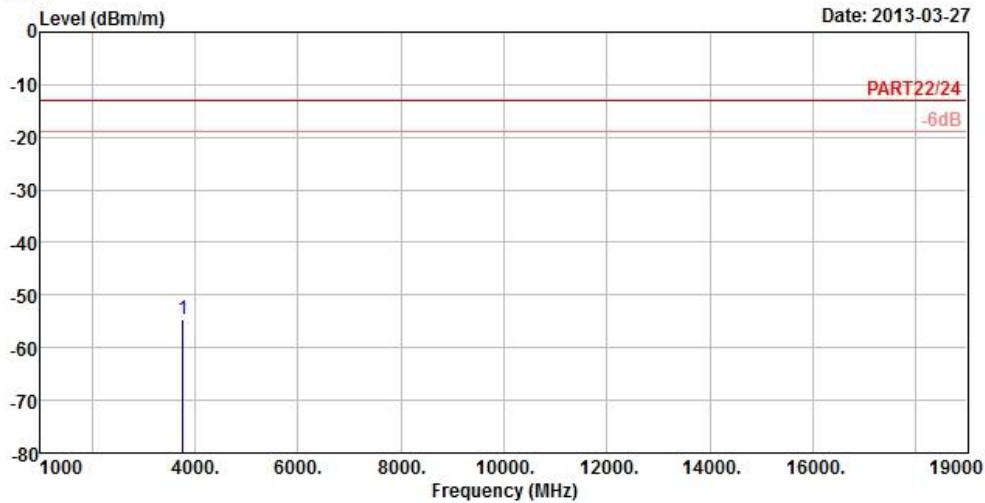

Site : 966 Chamber 5
 Condition : PART22/24 3m HORIZONTAL
 Brand/Model: P060100
 Remark : EDGELink
 Tested by : Kay Wu
 Temperature : 25°C
 Humidity : 65%
 Plane : Y

Freq	Level	Read Level	Limit Line	Over Limit	Factor	Remark
MHz	dBm/m	dBm	dBm/m	dB	dB/m	
1 pp 3760.00	-54.67	-47.94	-13.00	-41.67	-6.73	Peak



A D T



Bureau Veritas Consumer Products Services Ltd., Taoyuan Branch

A D T

Data: 12

Date: 2013-03-27

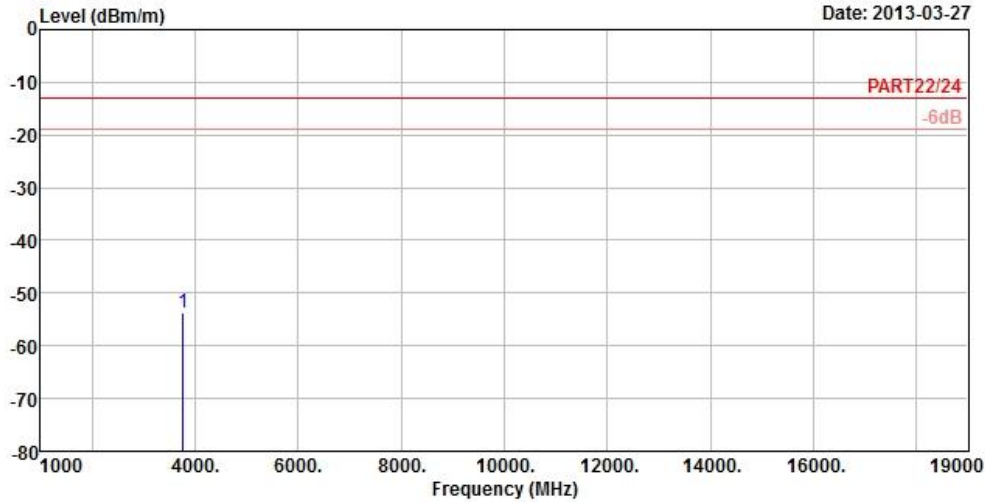

Site : 966 Chamber 5
 Condition : PART22/24 3m VERTICAL
 Brand/Model: P060100
 Remark : EDGELink
 Tested by : Kay Wu
 Temperature : 25°C
 Humidity : 65%
 Plane : Y

	Read	Limit	Over		
Freq	Level	Level	Line	Limit	Factor Remark
MHz	dBm/m	dBm	dBm/m	dB	dB/m
1 pp 3760.00	-53.86	-47.13	-13.00	-40.86	-6.73 Peak

5 PHOTOGRAPHS OF THE TEST CONFIGURATION

Please refer to the attached file (Test Setup Photo).



A D T

6 INFORMATION ON THE TESTING LABORATORIES

We, Bureau Veritas Consumer Products Services (H.K.) Ltd., Taoyuan Branch, were founded in 1988 to provide our best service in EMC, Radio, Telecom and Safety consultation. Our laboratories are accredited and approved according to ISO/IEC 17025.

If you have any comments, please feel free to contact us at the following:

Linko EMC/RF Lab:

Tel: 886-2-26052180

Fax: 886-2-26051924

Hsin Chu EMC/RF Lab:

Tel: 886-3-5935343

Fax: 886-3-5935342

Hwa Ya EMC/RF/Safety/Telecom Lab:

Tel: 886-3-3183232

Fax: 886-3-3270892

Email: service.adt@tw.bureauveritas.com

Web Site: www.bureauveritas-adt.com

The address and road map of all our labs can be found in our web site also.



A D T

7 APPENDIX A – MODIFICATIONS RECORDERS FOR ENGINEERING CHANGES TO THE EUT BY THE LAB

No any modifications were made to the EUT by the lab during the test.

---END---