



FCC TEST REPORT (PART 24)

REPORT NO.: RF130408C19-1
MODEL NO.: PO58220
FCC ID: NM8PO58220
RECEIVED: Apr. 08, 2013
TESTED: Apr. 27, 2013 ~ May 06, 2013
ISSUED: May 23, 2013

APPLICANT: HTC Corporation

ADDRESS: 23, Xinghua Rd., Taoyuan 330, Taiwan, R.O.C.

ISSUED BY: Bureau Veritas Consumer Products Services
(H.K.) Ltd., Taoyuan Branch

LAB ADDRESS: No. 47, 14th Ling, Chia Pau Vil., Lin Kou Dist., New
Taipei City, Taiwan (R.O.C.)

TEST LOCATION: No. 19, Hwa Ya 2nd Rd, Wen Hwa Tsuen, Kwei
Shan Hsiang, Taoyuan Hsien 333, Taiwan, R.O.C.

This report should not be used by the client to claim
product certification, approval, or endorsement by TAF or
any government agencies.



This report is for your exclusive use. Any copying or replication of this report to or for any other person or entity, or use of our name or trademark, is permitted only with our prior written permission. This report sets forth our findings solely with respect to the test samples identified herein. The results set forth in this report are not indicative or representative of the quality or characteristics of the lot from which a test sample was taken or any similar or identical product unless specifically and expressly noted. Our report includes all of the tests requested by you and the results thereof based upon the information that you provided to us. You have 60 days from date of issuance of this report to notify us of any material error or omission caused by our negligence, provided, however, that such notice shall be in writing and shall specifically address the issue you wish to raise. A failure to raise such issue within the prescribed time shall constitute your unqualified acceptance of the completeness of this report, the tests conducted and the correctness of the report contents. Unless specific mention, the uncertainty of measurement has been explicitly taken into account to declare the compliance or non-compliance to the specification



TABLE OF CONTENTS

RELEASE CONTROL RECORD	4
1 CERTIFICATION	5
2 SUMMARY OF TEST RESULTS.....	6
2.1 MEASUREMENT UNCERTAINTY	6
2.2 TEST SITE AND INSTRUMENTS.....	7
3 GENERAL INFORMATION	8
3.1 GENERAL DESCRIPTION OF EUT	8
3.2 CONFIGURATION OF SYSTEM UNDER TEST	10
3.3 DESCRIPTION OF SUPPORT UNITS.....	10
3.4 TEST ITEM AND TEST CONFIGURATION	11
3.5 EUT OPERATING CONDITIONS.....	13
3.6 GENERAL DESCRIPTION OF APPLIED STANDARDS	13
4 TEST TYPES AND RESULTS.....	14
4.1 OUTPUT POWER MEASUREMENT	14
4.1.1 LIMITS OF OUTPUT POWER MEASUREMENT	14
4.1.2 TEST PROCEDURES	14
4.1.3 TEST SETUP	15
4.1.4 TEST RESULTS	16
4.2 FREQUENCY STABILITY MEASUREMENT	22
4.2.1 LIMITS OF FREQUENCY STABILITY MEASUREMENT	22
4.2.2 TEST PROCEDURE.....	22
4.2.3 TEST SETUP	22
4.2.4 TEST RESULTS	23
4.3 OCCUPIED BANDWIDTH MEASUREMENT	24
4.3.1 TEST PROCEDURES	24
4.3.2 TEST SETUP	24
4.3.3 TEST RESULTS	25
4.4 PEAK TO AVERAGE RATIO	27
4.4.1 LIMITS OF PEAK TO AVERAGE RATIO MEASUREMENT	27
4.4.2 TEST SETUP	27
4.4.3 TEST PROCEDURES	27
4.4.4 TEST RESULTS	28
4.5 BAND EDGE MEASUREMENT	30
4.5.1 LIMITS OF BAND EDGE MEASUREMENT	30
4.5.2 TEST SETUP	30
4.5.3 TEST PROCEDURES	30
4.5.4 TEST RESULTS	31
4.6 CONDUCTED SPURIOUS EMISSIONS.....	34
4.6.1 LIMITS OF CONDUCTED SPURIOUS EMISSIONS MEASUREMENT	34
4.6.2 TEST PROCEDURE.....	34
4.6.3 TEST SETUP	34
4.6.4 TEST RESULTS	35
4.7 RADIATED EMISSION MEASUREMENT	36
4.7.1 LIMITS OF RADIATED EMISSION MEASUREMENT	36
4.7.2 TEST PROCEDURES	36
4.7.3 DEVIATION FROM TEST STANDARD	36
4.7.4 TEST SETUP	37
4.7.5 TEST RESULTS	38
5 PHOTOGRAPHS OF THE TEST CONFIGURATION.....	48



A D T

6	INFORMATION ON THE TESTING LABORATORIES	49
7	APPENDIX A – MODIFICATIONS RECORDERS FOR ENGINEERING CHANGES TO THE EUT BY THE LAB	50



RELEASE CONTROL RECORD

ISSUE NO.	REASON FOR CHANGE	DATE ISSUED
RF130408C19-1	Original release	May 23, 2013



1 CERTIFICATION

PRODUCT: Smartphone

MODEL: PO58220

BRAND: HTC

APPLICANT: HTC Corporation

TESTED: Apr. 27, 2013 ~ May 06, 2013

TEST SAMPLE: Production Unit

STANDARDS: FCC Part 24, Subpart E

The above equipment (model: PO58220) has been tested by **Bureau Veritas Consumer Products Services (H.K.) Ltd., Taoyuan Branch**, and found compliance with the requirement of the above standards. The test record, data evaluation & Equipment Under Test (EUT) configurations represented herein are true and accurate accounts of the measurements of the sample's EMC characteristics under the conditions specified in this report.

PREPARED BY : Ivonne Wu , **DATE** : May 23, 2013
Ivonne Wu / Senior Specialist

APPROVED BY : Sam Chen , **DATE** : May 23, 2013
Sam Chen / Assistant Manager

2 SUMMARY OF TEST RESULTS

The EUT has been tested according to the following specifications:

APPLIED STANDARD: FCC Part 24 & Part 2			
STANDARD SECTION	TEST TYPE	RESULT	REMARK
2.1046 24.232	Equivalent isotropically radiated power	PASS	Meet the requirement of limit.
2.1055 24.235	Frequency Stability	PASS	Meet the requirement of limit.
2.1049 24.238(b)	Occupied Bandwidth	PASS	Meet the requirement of limit.
24.232(d)	Peak to average ratio	PASS	Meet the requirement of limit.
24.238(b)	Band Edge Measurements	PASS	Meet the requirement of limit.
2.1051 24.238	Conducted Spurious Emissions	PASS	Meet the requirement of limit.
2.1053 24.238	Radiated Spurious Emissions	PASS	Meet the requirement of limit. Minimum passing margin is -23.49dB at 42.42MHz.

2.1 MEASUREMENT UNCERTAINTY

Where relevant, the following measurement uncertainty levels have been estimated for tests performed on the EUT as specified in CISPR 16-4-2:

MEASUREMENT	FREQUENCY	UNCERTAINTY
Conducted emissions	150kHz~30MHz	2.44 dB
Radiated emissions	30MHz ~ 200MHz	2.93 dB
	200MHz ~1000MHz	2.95 dB
	1GHz ~ 18GHz	2.26 dB
	18GHz ~ 40GHz	1.94 dB

This uncertainty represents an expanded uncertainty expressed at approximately the 95% confidence level using a coverage factor of k=2.



2.2 TEST SITE AND INSTRUMENTS

DESCRIPTION & MANUFACTURER	MODEL NO.	SERIAL NO.	DATE OF CALIBRATION	DUE DATE OF CALIBRATION
Test Receiver ROHDE & SCHWARZ	ESCS30	100289	Nov. 16, 2012	Nov. 15, 2013
Spectrum Analyzer ROHDE & SCHWARZ	FSU43	101261	Dec. 17, 2012	Dec. 16, 2013
BILOG Antenna SCHWARZBECK	VULB9168	9168-472	Mar. 25, 2013	Mar. 24, 2014
HORN Antenna SCHWARZBECK	BBHA 9120 D	9120D-969	Jan. 07, 2013	Jan. 06, 2014
HORN Antenna SCHWARZBECK	BBHA 9170	9170-480	Dec. 25, 2012	Dec. 24, 2013
Loop Antenna	HFH2-Z2	100070	Jan. 31, 2012	Jan. 30, 2014
Preamplifier EMCI	EMC 012645	980115	Dec. 28, 2012	Dec. 27, 2013
Preamplifier EMCI	EMC 184045	980116	Dec. 28, 2012	Dec. 27, 2013
Preamplifier EMCI	EMC 330H	980112	Dec. 28, 2012	Dec. 27, 2013
RF signal cable HUBER+SUHNNER	SUCOFLEX 104	309219/4	Oct. 19, 2012	Oct. 18, 2013
RF signal cable HUBER+SUHNNER	SUCOFLEX 104	250130/4	Oct. 19, 2012	Oct. 18, 2013
RF signal cable Worken	RG-213	NA	Dec. 29, 2012	Dec. 28, 2013
Software BV ADT	E3 6.120103	NA	NA	NA
Antenna Tower MF	MFA-440H	NA	NA	NA
Turn Table MF	MFT-201SS	NA	NA	NA
Antenna Tower & Turn Table Controller MF	MF-7802	NA	NA	NA
Mini-Circuits Power Splitter	ZN2PD-9G	NA	Jun. 13, 2012	Jun. 12, 2013
JFW 20dB attenuation	50HF-020-SMA	NA	NA	NA
Communications Tester-Wireless	E5515C	MY52102049	Jun. 11, 2012	Jun. 10, 2013
Radio Communication Analyzer	MT8820C	6201168830	Jul. 17, 2012	Jul. 16, 2013

- NOTE:** 1. The calibration interval of the above test instruments is 12 months and the calibrations are traceable to NML/ROC and NIST/USA.
2. The test was performed in HwaYa Chamber 10.
3. The horn antenna and HP preamplifier (model: 8449B) are used only for the measurement of emission frequency above 1GHz if tested.
4. The FCC Site Registration No. is 690701.
5. The IC Site Registration No. is IC 7450F-10.



3 GENERAL INFORMATION

3.1 GENERAL DESCRIPTION OF EUT

EUT	Smartphone	
MODEL NO.	PO58220	
POWER SUPPLY	5.0Vdc (adapter or host equipment) 3.8Vdc (battery)	
MODULATION TYPE	GSM/GPRS	GMSK
	EDGE	8PSK
	WCDMA	BPSK
	LTE Band 2	QPSK, 16QAM
FREQUENCY RANGE	GSM/GPRS/EDGE	1850.2MHz ~ 1909.8MHz
	WCDMA	1852.4MHz ~ 1907.6MHz
	LTE Band 2 (Channel Bandwidth: 5MHz)	1852.5MHz ~ 1907.5MHz
	LTE Band 2 (Channel Bandwidth: 10MHz)	1855MHz ~ 1905MHz
MAX. EIRP POWER	GSM	580.76mW
	EDGE	483.06mW
	WCDMA	152.76mW
	LTE Band 2 (Channel Bandwidth: 5MHz)	98.86mW
	LTE Band 2 (Channel Bandwidth: 10MHz)	99.31mW
EMISSION DESIGNATOR	GSM	248KGXW
	EDGE	249KG7W
	WCDMA	4M18F9W
	LTE Band 2 (Channel Bandwidth: 5MHz)	4M49G7D
	LTE Band 2 (Channel Bandwidth: 10MHz)	8M92W7D
MULTI-SLOTS CLASS	10	
WCDMA RELEASE VERSION	6	
ANTENNA TYPE	Fixed Internal Antenna	
I/O PORTS	Refer to users' manual	
DATA CABLE	Refer to NOTE as below	
ACCESSORY DEVICES	Refer to NOTE as below	

NOTE:

1. The device has 2 configurations as below.

Main sample (A): Battery 1 + LCD Panel 1 + Photo Camera 1

2nd sample (B): Battery 2 + LCD Panel 2 + Photo Camera 2

✧ Only the test data for main sample was presented in the report, since the verified data for 2nd sample was not worse than the main sample.

2. The EUT's accessories list refers to EUT photo.

3. The above EUT information was declared by manufacturer and for more detailed features description, please refer to the manufacturer's specifications or User's Manual.

3.2 CONFIGURATION OF SYSTEM UNDER TEST

FOR RADIATION EMISSION TEST

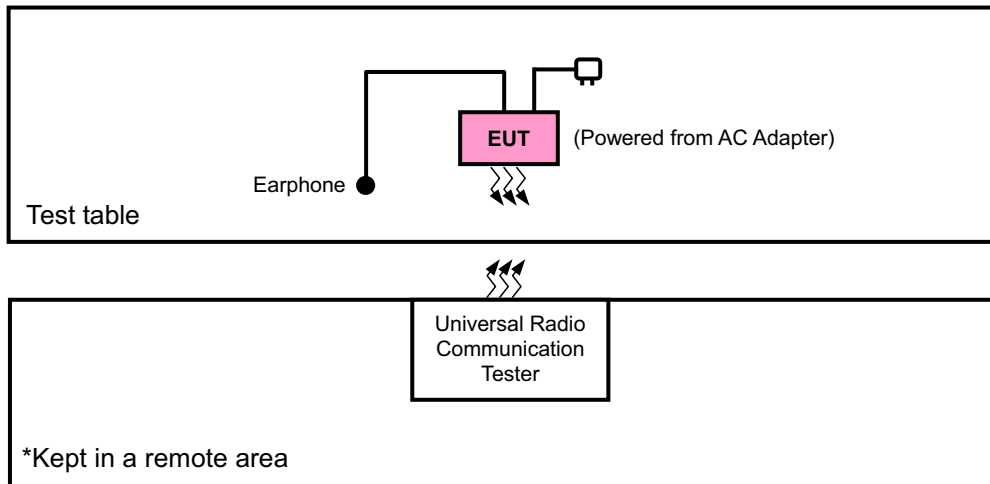

FOR E.I.R.P. TEST

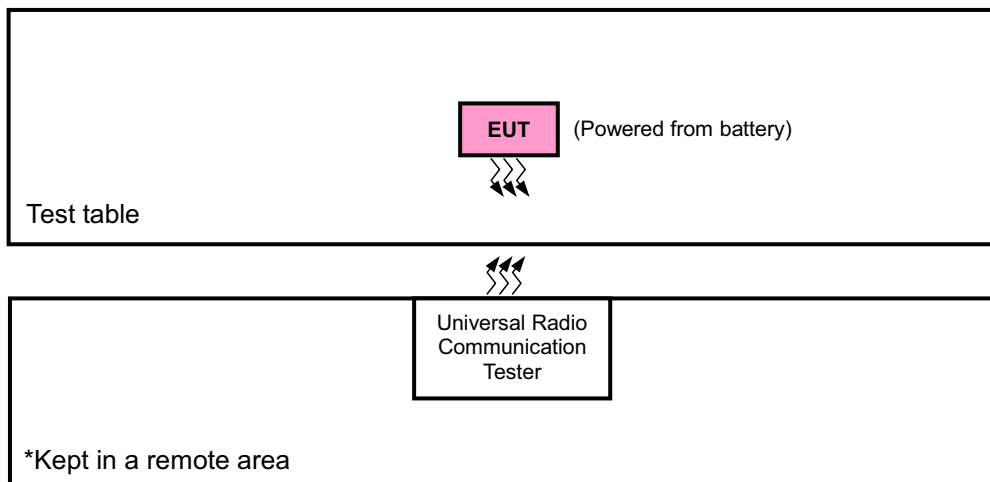

3.3 DESCRIPTION OF SUPPORT UNITS

The EUT has been tested as an independent unit together with other necessary accessories or support units.

3.4 TEST ITEM AND TEST CONFIGURATION

Pre-Scan has been conducted to determine the worst-case mode from all possible combinations between available modulations, data rates, XYZ axis and antenna ports. The worst case was found when positioned on X-plane for EIRP and X-axis for WWAN and Y-axis for LTE for radiated emission for antenna 0. Following channel(s) was (were) selected for the final test as listed below:

GSM MODE

EUT CONFIGURE MODE	TEST ITEM	AVAILABLE CHANNEL	TESTED CHANNEL	MODE
-	EIRP	512 to 810	512, 661, 810	GSM, EDGE
-	FREQUENCY STABILITY	512 to 810	661	GSM, EDGE
-	OCCUPIED BANDWIDTH	512 to 810	512, 661, 810	GSM, EDGE
-	PEAK TO AVERAGE RATIO	512 to 810	512, 661, 810	GSM, EDGE
-	BAND EDGE	512 to 810	512, 810	GSM, EDGE
-	CONDCUETED EMISSION	512 to 810	661	GSM, EDGE
-	RADIATED EMISSION	512 to 810	661	GSM, EDGE

WCDMA MODE

EUT CONFIGURE MODE	TEST ITEM	AVAILABLE CHANNEL	TESTED CHANNEL	MODE
-	EIRP	9262 to 9538	9262, 9400, 9538	WCDMA
-	FREQUENCY STABILITY	9262 to 9538	9400	WCDMA
-	OCCUPIED BANDWIDTH	9262 to 9538	9262, 9400, 9538	WCDMA
-	PEAK TO AVERAGE RATIO	9262 to 9538	9262, 9400, 9538	WCDMA
-	BAND EDGE	9262 to 9538	9262, 9538	WCDMA
-	CONDCUETED EMISSION	9262 to 9538	9400	WCDMA
-	RADIATED EMISSION	9262 to 9538	9400	WCDMA



LTE BAND 2 MODE

EUT CONFIGURE MODE	TEST ITEM	AVAILABLE CHANNEL	TESTED CHANNEL	CHANNEL BANDWIDTH	MODULATION	MODE
-	EIRP	18625 to 19175	18625, 18800, 19175	5MHz	QPSK, 16QAM	1 RB / 0 RB Offset
		18650 to 19150	18650, 18900, 19150	10MHz	QPSK, 16QAM	1 RB / 0 RB Offset
-	FREQUENCY STABILITY	18625 to 19175	18900	5MHz	QPSK	1 RB / 0 RB Offset
		18650 to 19150	18900	10MHz	QPSK	1 RB / 0 RB Offset
-	OCCUPIED BANDWIDTH	18625 to 19175	18625, 18800, 19175	5MHz	QPSK	25 RB / 0 RB Offset
					16QAM	25 RB / 0 RB Offset
		18650 to 19150	18650, 18900, 19150	10MHz	QPSK	50 RB / 0 RB Offset
					16QAM	50 RB / 0 RB Offset
-	PEAK TO AVERAGE RATIO	18625 to 19175	18625, 18800, 19175	5MHz	QPSK	1 RB / 0 RB Offset
					16QAM	1 RB / 0 RB Offset
		18650 to 19150	18650, 18900, 19150	10MHz	QPSK	1 RB / 0 RB Offset
					16QAM	1 RB / 0 RB Offset
-	BAND EDGE	18625 to 19175	18625	5MHz	QPSK	1 RB / 0 RB Offset
			19175	5MHz	QPSK	25 RB / 0 RB Offset
		18650 to 19150	18650	10MHz	QPSK	1 RB / 24 RB Offset
					QPSK	25 RB / 0 RB Offset
			19150	10MHz	QPSK	1 RB / 0 RB Offset
					QPSK	50 RB / 0 RB Offset
-	CONDCUDED EMISSION	18625 to 19175	18900	5MHz	QPSK	1 RB / 0 RB Offset
		18650 to 19150	18900	10MHz	QPSK	1 RB / 0 RB Offset
-	RADIATED EMISSION	18625 to 19175	18900	5MHz	QPSK	1 RB / 0 RB Offset
		18650 to 19150	18900	10MHz	QPSK	1 RB / 0 RB Offset

Note: This device was tested under all bandwidths, RB configurations and modulations. The worst case was found in QPSK modulation.

TEST CONDITION:

TEST ITEM	ENVIRONMENTAL CONDITIONS	INPUT POWER	TESTED BY
EIRP	26deg. C, 58%RH	3.8Vdc	Howard Kao
FREQUENCY STABILITY	26deg. C, 58%RH	3.8Vdc	Howard Kao
OCCUPIED BANDWIDTH	26deg. C, 58%RH	3.8Vdc	Howard Kao
BAND EDGE	26deg. C, 58%RH	3.8Vdc	Howard Kao
CONDCUDED EMISSION	26deg. C, 58%RH	3.8Vdc	Howard Kao
RADIATED EMISSION	25deg. C, 65%RH	120Vac, 60Hz	Johnson Liao



3.5 EUT OPERATING CONDITIONS

The EUT makes a call to the communication simulator. The communication simulator station system controlled a EUT to export maximum output power under transmission mode and specific channel frequency

3.6 GENERAL DESCRIPTION OF APPLIED STANDARDS

The EUT is a RF product. According to the specifications of the manufacturer, it must comply with the requirements of the following standards:

FCC 47 CFR Part 2

FCC 47 CFR Part 24

ANSI/TIA/EIA-603-C 2004

NOTE: All test items have been performed and recorded as per the above standards.

4 TEST TYPES AND RESULTS

4.1 OUTPUT POWER MEASUREMENT

4.1.1 LIMITS OF OUTPUT POWER MEASUREMENT

Mobile and portable stations are limited to 2 watts EIRP

4.1.2 TEST PROCEDURES

EIRP MEASUREMENT:

- a. All measurements were done at low, middle and high operational frequency range. RBW and VBW is 1MHz for GSM, GPRS & EDGE, 5MHz for WCDMA, and 10MHz for LTE mode.
- b. Substitution method is used for E.I.R.P measurement. In the semi-anechoic chamber, EUT placed on the 0.8m height of Turn Table, rotated the table around 360 degrees to search the maximum radiation power and receiver antenna shall be rotated vertical and horizontal polarization and moved height from 1m to 4m to find the maximum polar radiated power. The “Read Value” is the spectrum reading the maximum power value.
- c. The substitution horn antenna is substituted for EUT at the same position and signals generator export the CW signal to the substitution antenna via a tx cable. Rotated the Turn Table and moved receiving antenna to find the maximum radiation power. Adjust output power level of S.G to get a Value of spectrum reading equal to “Read Value” of step b. Record the power level of S.G
- d. $EIRP = \text{Output power level of S.G} - \text{TX cable loss} + \text{Antenna gain of substitution horn.}$

CONDUCTED POWER MEASUREMENT:

The EUT was set up for the maximum power with GSM, GPRS, EDGE & WCDMA link data modulation and link up with simulator. Set the EUT to transmit under low, middle and high channel and record the power level shown on simulator.

4.1.3 TEST SETUP

EIRP / ERP MEASUREMENT:

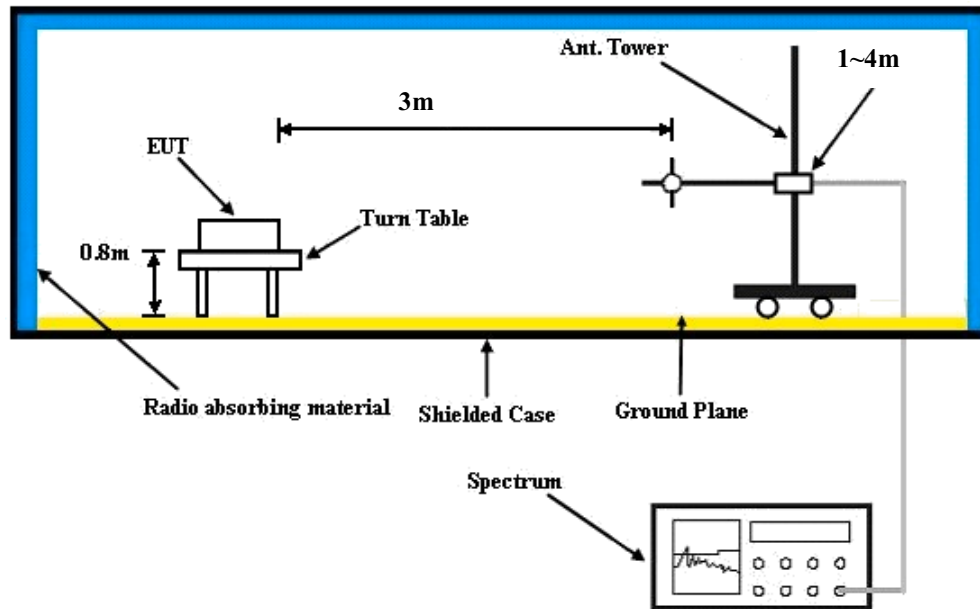

CONDUCTED POWER MEASUREMENT:

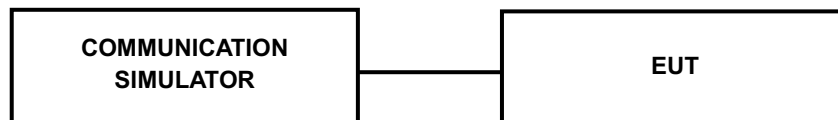

4.1.4 TEST RESULTS

CONDUCTED OUTPUT POWER (dBm)

Band	GSM1900		
Channel	512	661	810
Frequency (MHz)	1850.2	1880.0	1909.8
GSM (1 Uplink)	29.83	30.09	29.92
GPRS 8 (GMSK, 1 slot)	29.77	30.03	29.86
GPRS 10 (GMSK, 2 slot)	28.73	28.99	28.82
EDGE 8 (GMSK, 1 Uplink)	29.79	30.05	29.88
EDGE 10 (GMSK, 2 Uplink)	28.71	28.97	28.80
EDGE 8 (8PSK, 1 Uplink)	25.30	25.56	25.39
EDGE 10 (8PSK, 2 Uplink)	25.32	25.58	25.41

Band	WCDMA II		
Channel	9262	9400	9538
Frequency (MHz)	1852.4	1880.0	1907.6
RMC 12.2K	24.18	24.25	24.11
HSDPA Subtest-1	23.21	23.28	23.14
HSDPA Subtest-2	23.19	23.26	23.12
HSDPA Subtest-3	22.71	22.78	22.64
HSDPA Subtest-4	22.73	22.80	22.66
HSUPA Subtest-1	23.21	23.28	23.14
HSUPA Subtest-2	21.24	21.31	21.17
HSUPA Subtest-3	22.19	22.26	22.12
HSUPA Subtest-4	21.31	21.38	21.24
HSUPA Subtest-5	23.28	23.35	23.21



LTE Band 2								
BW	Modulation	CH	Frequency	RB	RB Offset	MPR	Target	Measured
			(MHz)				Power	Power
5 MHz	QPSK	18625	1852.5	1	0	0	23	22.35
		18900	1880	1	0	0	23	22.46
		19175	1907.5	1	0	0	23	22.39
		18625	1852.5	1	12	0	23	22.32
		18900	1880	1	12	0	23	22.43
		19175	1907.5	1	12	0	23	22.36
		18625	1852.5	1	24	0	23	22.22
		18900	1880	1	24	0	23	22.33
		19175	1907.5	1	24	0	23	22.26
		18625	1852.5	12	0	1	23	21.38
		18900	1880	12	0	1	23	21.49
		19175	1907.5	12	0	1	23	21.42
		18625	1852.5	12	6	1	23	21.14
		18900	1880	12	6	1	23	21.25
		19175	1907.5	12	6	1	23	21.18
		18625	1852.5	12	13	1	23	21.07
		18900	1880	12	13	1	23	21.18
		19175	1907.5	12	13	1	23	21.11
	18625	1852.5	25	0	1	23	21.18	
	18900	1880	25	0	1	23	21.29	
	19175	1907.5	25	0	1	23	21.22	
	18625	1852.5	1	0	1	23	21.85	
	18900	1880	1	0	1	23	21.96	
	19175	1907.5	1	0	1	23	21.89	
	18625	1852.5	1	12	1	23	21.82	
	18900	1880	1	12	1	23	21.93	
	19175	1907.5	1	12	1	23	21.86	
	18625	1852.5	1	24	1	23	21.72	
	18900	1880	1	24	1	23	21.83	
	19175	1907.5	1	24	1	23	2.76	
	18625	1852.5	12	0	2	23	20.88	
	18900	1880	12	0	2	23	20.99	
	19175	1907.5	12	0	2	23	20.92	
	18625	1852.5	12	6	2	23	20.64	
	18900	1880	12	6	2	23	20.75	
	19175	1907.5	12	6	2	23	20.68	
18625	1852.5	12	13	2	23	20.57		
18900	1880	12	13	2	23	20.68		
19175	1907.5	12	13	2	23	20.61		
18625	1852.5	25	0	2	23	20.68		
18900	1880	25	0	2	23	20.79		
19175	1907.5	25	0	2	23	20.72		
	16QAM	18625	1852.5	1	0	1	23	21.85
		18900	1880	1	0	1	23	21.96
		19175	1907.5	1	0	1	23	21.89
		18625	1852.5	1	12	1	23	21.82
		18900	1880	1	12	1	23	21.93
		19175	1907.5	1	12	1	23	21.86
		18625	1852.5	1	24	1	23	21.72
		18900	1880	1	24	1	23	21.83
		19175	1907.5	1	24	1	23	2.76
		18625	1852.5	12	0	2	23	20.88
		18900	1880	12	0	2	23	20.99
		19175	1907.5	12	0	2	23	20.92
		18625	1852.5	12	6	2	23	20.64
		18900	1880	12	6	2	23	20.75
		19175	1907.5	12	6	2	23	20.68
		18625	1852.5	12	13	2	23	20.57
		18900	1880	12	13	2	23	20.68
		19175	1907.5	12	13	2	23	20.61
	18625	1852.5	25	0	2	23	20.68	
	18900	1880	25	0	2	23	20.79	
	19175	1907.5	25	0	2	23	20.72	

LTE Band 2								
BW	Modulation	CH	Frequency	RB	RB Offset	MPR	Target	Measured
			(MHz)				Power	Power
10MHz	QPSK	18650	1855	1	0	0	23	22.55
		18900	1880	1	0	0	23	22.66
		19150	1905	1	0	0	23	22.59
		18650	1855	1	24	0	23	22.52
		18900	1880	1	24	0	23	22.63
		19150	1905	1	24	0	23	22.56
		18650	1855	1	49	0	23	22.42
		18900	1880	1	49	0	23	22.53
		19150	1905	1	49	0	23	22.46
		18650	1855	25	0	1	23	21.58
		18900	1880	25	0	1	23	21.69
		19150	1905	25	0	1	23	21.62
		18650	1855	25	12	1	23	21.34
		18900	1880	25	12	1	23	21.45
		19150	1905	25	12	1	23	21.38
		18650	1855	25	25	1	23	21.27
		18900	1880	25	25	1	23	21.38
		19150	1905	25	25	1	23	21.31
	18650	1855	50	0	1	23	21.38	
	18900	1880	50	0	1	23	21.49	
	19150	1905	50	0	1	23	21.42	
	18650	1855	1	0	1	23	21.85	
	18900	1880	1	0	1	23	21.96	
	19150	1905	1	0	1	23	21.89	
	18650	1855	1	24	1	23	21.82	
	18900	1880	1	24	1	23	21.93	
	19150	1905	1	24	1	23	21.86	
	18650	1855	1	49	1	23	21.72	
	18900	1880	1	49	1	23	21.83	
	19150	1905	1	49	1	23	21.76	
	18650	1855	25	0	2	23	20.88	
	18900	1880	25	0	2	23	20.99	
	19150	1905	25	0	2	23	20.92	
	18650	1855	25	12	2	23	20.64	
	18900	1880	25	12	2	23	20.75	
	19150	1905	25	12	2	23	20.68	
18650	1855	25	25	2	23	20.57		
18900	1880	25	25	2	23	20.68		
19150	1905	25	25	2	23	20.61		
18650	1855	50	0	2	23	20.68		
18900	1880	50	0	2	23	20.79		
19150	1905	50	0	2	23	20.72		
	16QAM	18650	1855	1	0	1	23	21.85
		18900	1880	1	0	1	23	21.96
		19150	1905	1	0	1	23	21.89
		18650	1855	1	24	1	23	21.82
		18900	1880	1	24	1	23	21.93
		19150	1905	1	24	1	23	21.86
		18650	1855	1	49	1	23	21.72
		18900	1880	1	49	1	23	21.83
		19150	1905	1	49	1	23	21.76
		18650	1855	25	0	2	23	20.88
		18900	1880	25	0	2	23	20.99
		19150	1905	25	0	2	23	20.92
		18650	1855	25	12	2	23	20.64
		18900	1880	25	12	2	23	20.75
		19150	1905	25	12	2	23	20.68
		18650	1855	25	25	2	23	20.57
		18900	1880	25	25	2	23	20.68
		19150	1905	25	25	2	23	20.61
	18650	1855	50	0	2	23	20.68	
	18900	1880	50	0	2	23	20.79	
	19150	1905	50	0	2	23	20.72	

EIRP POWER (dBm)

GSM

Plane	Channel	Frequency (MHz)	LVL (dBm)	Correction Factor(dB)	ERP(dBm)	ERP(mW)	Polarization (H/V)
X	512	1850.2	-11.09	38.19	27.10	512.86	H
	661	1880.0	-11.63	38.70	27.07	509.33	H
	810	1909.8	-10.79	38.43	27.64	580.76	H
	512	1850.2	-21.54	38.48	16.94	49.43	V
	661	1880.0	-21.74	38.59	16.85	48.42	V
	810	1909.8	-22.14	38.87	16.73	47.10	V

EDGE

Plane	Channel	Frequency (MHz)	LVL (dBm)	Correction Factor(dB)	ERP(dBm)	ERP(mW)	Polarization (H/V)
X	512	1850.2	-11.38	38.19	26.81	479.73	H
	661	1880.0	-11.86	38.70	26.84	483.06	H
	810	1909.8	-12.13	38.43	26.30	426.58	H
	512	1850.2	-21.88	38.48	16.60	45.71	V
	661	1880.0	-21.82	38.59	16.77	47.53	V
	810	1909.8	-22.70	38.87	16.17	41.40	V

WCDMA

Plane	Channel	Frequency (MHz)	LVL (dBm)	Correction Factor(dB)	ERP(dBm)	ERP(mW)	Polarization (H/V)
X	9262	1852.4	-16.35	38.19	21.84	152.76	H
	9400	1880.0	-17.59	38.70	21.11	129.12	H
	9538	1907.6	-16.63	38.43	21.80	151.36	H
	9262	1852.4	-25.76	38.48	12.72	18.71	V
	9400	1880.0	-26.38	38.59	12.21	16.63	V
	9538	1907.6	-26.57	38.87	12.30	16.98	V

LTE Band 2

CHANNEL BANDWIDTH: 5MHz QPSK

Plane	Channel	Frequency (MHz)	LVL (dBm)	Correction Factor(dB)	ERP(dBm)	ERP(mW)	Polarization (H/V)
X	18625	1852.5	-18.04	37.99	19.95	98.86	H
	18900	1880	-18.91	37.99	19.08	80.91	H
	19175	1907.5	-19.28	38.36	19.08	80.91	H
	18625	1852.5	-27.96	37.91	9.95	9.89	V
	18900	1880	-28.68	38.00	9.32	8.55	V
	19175	1907.5	-28.39	38.28	9.89	9.75	V

CHANNEL BANDWIDTH: 5MHz 16QAM

Plane	Channel	Frequency (MHz)	LVL (dBm)	Correction Factor(dB)	ERP(dBm)	ERP(mW)	Polarization (H/V)
X	18625	1852.5	-18.44	37.90	19.46	88.31	H
	18900	1880	-18.23	37.99	19.76	94.62	H
	19175	1907.5	-18.58	38.31	19.73	93.97	H
	18625	1852.5	-27.91	37.81	9.90	9.77	V
	18900	1880	-28.76	38.00	9.24	8.39	V
	19175	1907.5	-28.58	38.22	9.64	9.20	V

CHANNEL BANDWIDTH: 10MHz QPSK

Plane	Channel	Frequency (MHz)	LVL (dBm)	Correction Factor(dB)	ERP(dBm)	ERP(mW)	Polarization (H/V)
X	18650	1855	-18.83	37.90	19.07	80.72	H
	18900	1880	-18.11	37.99	19.88	97.27	H
	19150	1905	-18.75	38.31	19.56	90.36	H
	18650	1855	-28.54	37.81	9.27	8.45	V
	18900	1880	-28.90	38.00	9.10	8.13	V
	19150	1905	-28.69	38.22	9.53	8.97	V

CHANNEL BANDWIDTH: 10MHz 16QAM

Plane	Channel	Frequency (MHz)	LVL (dBm)	Correction Factor(dB)	ERP(dBm)	ERP(mW)	Polarization (H/V)
X	18650	1855	-18.13	37.99	19.86	96.83	H
	18900	1880	-18.02	37.99	19.97	99.31	H
	19150	1905	-19.87	38.36	18.49	70.63	H
	18650	1855	-27.94	37.91	9.97	9.93	V
	18900	1880	-28.02	38.00	9.98	9.95	V
	19150	1905	-29.24	38.28	9.04	8.02	V

4.2 FREQUENCY STABILITY MEASUREMENT

4.2.1 LIMITS OF FREQUENCY STABILITY MEASUREMENT

The frequency stability shall be sufficient to ensure that the fundamental emission stays within the authorized frequency block.

4.2.2 TEST PROCEDURE

- a. Device is placed at the oven room. The oven room could control the temperatures and humidity. Power warm up is at least 15 min and power applied should perform before recording frequency error.
- b. EUT is connected the external power supply to control the DC input power. The test voltage range is from minimum to maximum working voltage. Each step shall be record the frequency error rate.
- c. The temperature range step is 10 degrees in this test items. All temperature levels shall be hold the $\pm 0.5^{\circ}\text{C}$ during the measurement testing. The each temperature step shall be at least 0.5 hours, consider the EUT could be test under the stability condition.

NOTE: The frequency error was recorded frequency error from the communication simulator.

4.2.3 TEST SETUP

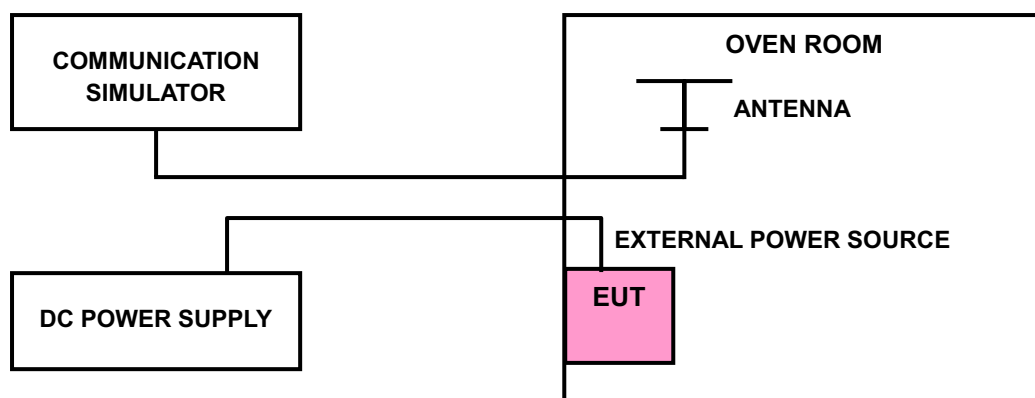

4.2.4 TEST RESULTS

FREQUENCY ERROR vs. VOLTAGE

VOLTAGE (Volts)	FREQUENCY ERROR (ppm)					LIMIT (ppm)
	GSM	EDGE	WCDMA	LTE Band 2		
				5MHz	10MHz	
3.8	-0.007	0.009	-0.004	-0.011	0.005	2.5
3.6	-0.006	0.009	-0.005	-0.017	-0.019	2.5
4.35	-0.006	0.011	-0.004	-0.012	-0.020	2.5

NOTE: The applicant defined the normal working voltage of the battery is from 3.6Vdc to 4.35Vdc.

FREQUENCY ERROR vs. TEMPERATURE.

TEMP. (°C)	FREQUENCY ERROR (ppm)					LIMIT (ppm)
	GSM	EDGE	WCDMA	LTE Band 2		
				5MHz	10MHz	
-10	-0.006	0.012	-0.005	0.037	-0.018	2.5
0	-0.009	0.013	-0.005	0.011	0.033	2.5
10	-0.008	0.013	-0.005	-0.017	-0.019	2.5
20	-0.009	0.013	-0.004	-0.035	-0.009	2.5
30	-0.009	0.015	-0.005	-0.012	-0.008	2.5
40	-0.010	0.014	-0.006	-0.013	-0.019	2.5
50	-0.007	0.010	-0.005	-0.013	-0.009	2.5

Note:

1. The applicant declared that the normal operating temperature of the EUT is from -10°C to 50°C.
2. The EUT would shut down automatically as below -10°C.

4.3 OCCUPIED BANDWIDTH MEASUREMENT

4.3.1 TEST PROCEDURES

The EUT makes a call to the communication simulator. All measurements were done at low, middle and high operational frequency range. The communication simulator station system controlled a EUT to export maximum output power under transmission mode and specific channel frequency. Use OBW measurement function of Spectrum analyzer to measure 99 % occupied bandwidth.

4.3.2 TEST SETUP

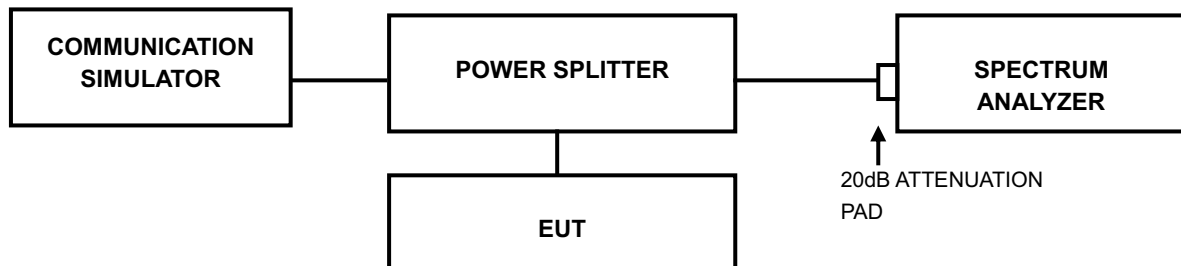

4.3.3 TEST RESULTS

CHANNEL	FREQUENCY (MHz)	99% OCCUPIED BANDWIDTH (kHz)		CHANNEL	FREQUENCY (MHz)	99% OCCUPIED BANDWIDTH (MHz)
		GSM	EDGE			WCDMA
512	1850.2	246.40	246.52	9262	1852.4	4.1768
661	1880.0	248.47	247.53	9400	1880.0	4.17
810	1909.8	246.09	248.77	9538	1907.6	4.1726

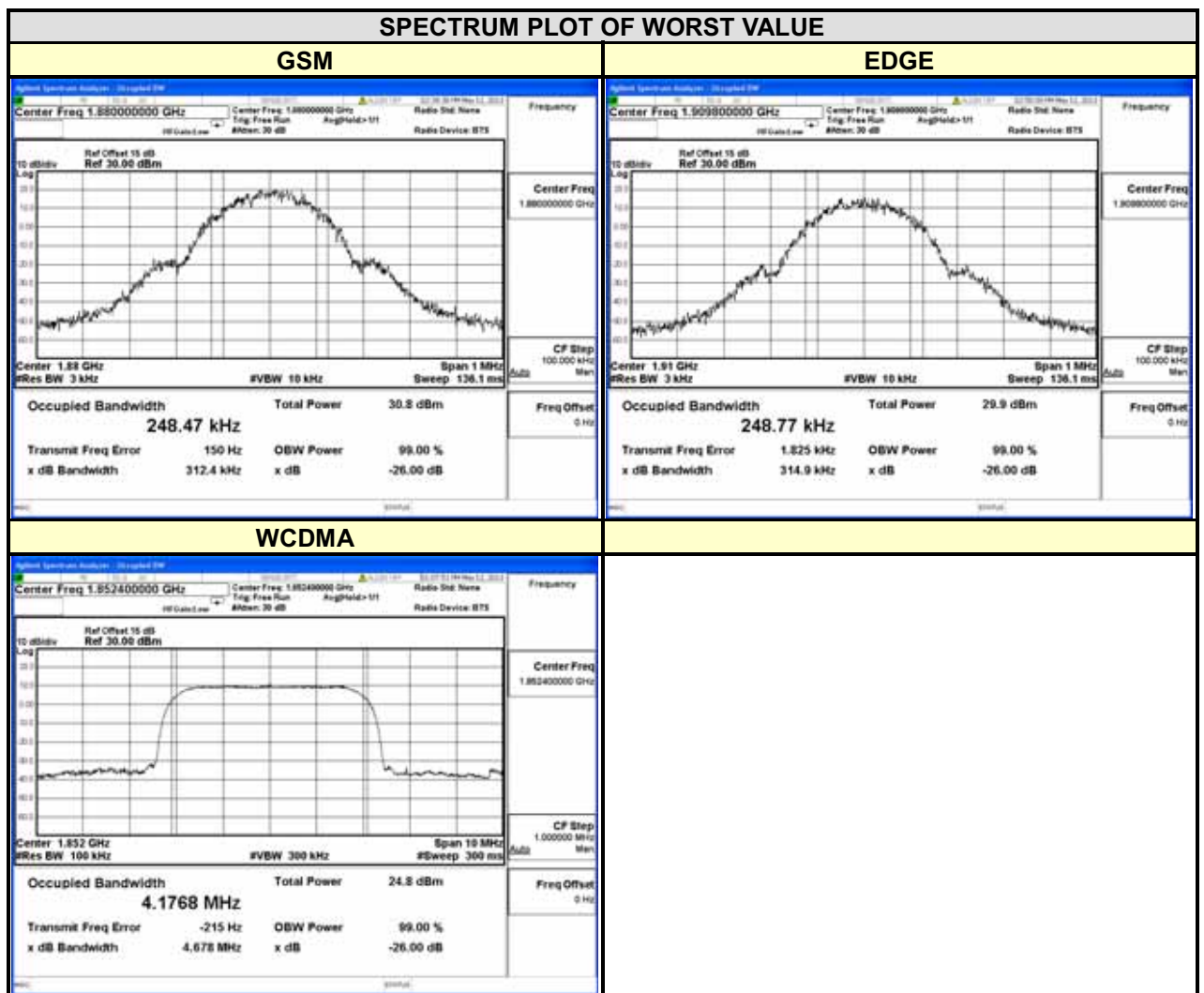

LTE BAND 2							
CHANNEL BANDWIDTH: 5MHz				CHANNEL BANDWIDTH: 10MHz			
CHANNEL	FREQUENCY (MHz)	99% OCCUPIED BANDWIDTH (MHz)		CHANNEL	FREQUENCY (MHz)	99% OCCUPIED BANDWIDTH (MHz)	
		QPSK	16QAM			QPSK	16QAM
18625	1852.5	4.4898	4.4851	18650	1855	8.9222	8.9216
18900	1880	4.4872	4.4860	18900	1880	8.9215	8.9219
19175	1907.5	4.4888	4.4811	19150	1905	8.9240	8.9244

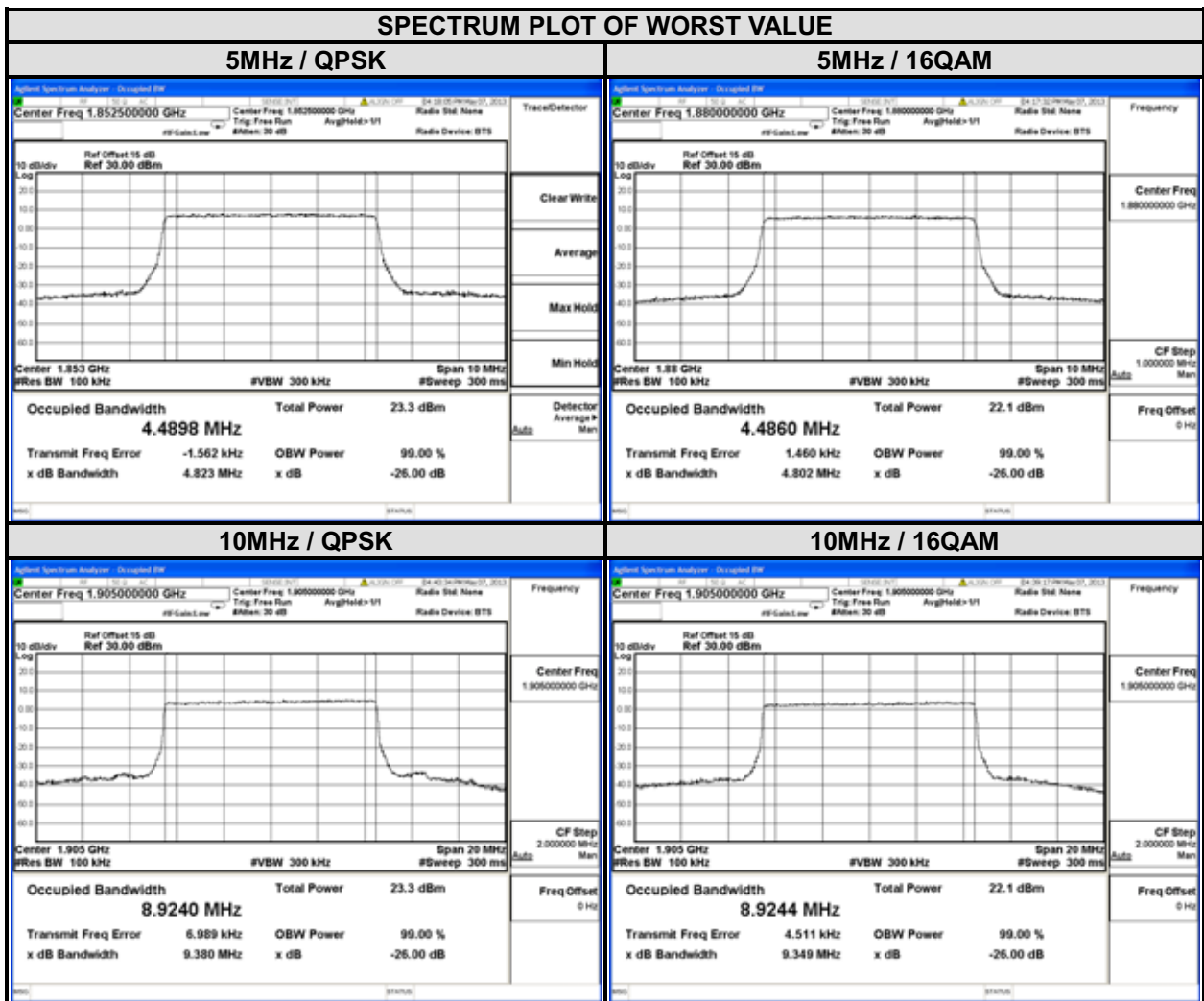

4.4 PEAK TO AVERAGE RATIO

4.4.1 LIMITS OF PEAK TO AVERAGE RATIO MEASUREMENT

In measuring transmissions in this band using an average power technique, the peak to-average ratio (PAR) of the transmission may not exceed 13 dB

4.4.2 TEST SETUP

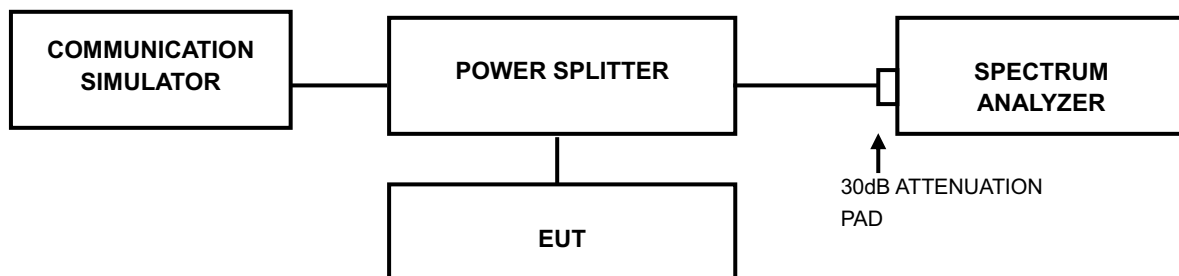

4.4.3 TEST PROCEDURES

1. Set resolution/measurement bandwidth \geq signal's occupied bandwidth;
2. Set the number of counts to a value that stabilizes the measured CCDF curve;
3. Record the maximum PAPR level associated with a probability of 0.1%.

4.4.4 TEST RESULTS

CHANNEL	FREQUENCY (MHz)	PEAK TO AVERAGE RATIO (dB)		CHANNEL	FREQUENCY (MHz)	PEAK TO AVERAGE RATIO (dB)
		GSM	EDGE			WCDMA
512	1850.2	0.12	0.17	9262	1852.4	2.83
661	1880.0	0.12	0.16	9400	1880.0	3.01
810	1909.8	0.13	0.17	9538	1907.6	2.90

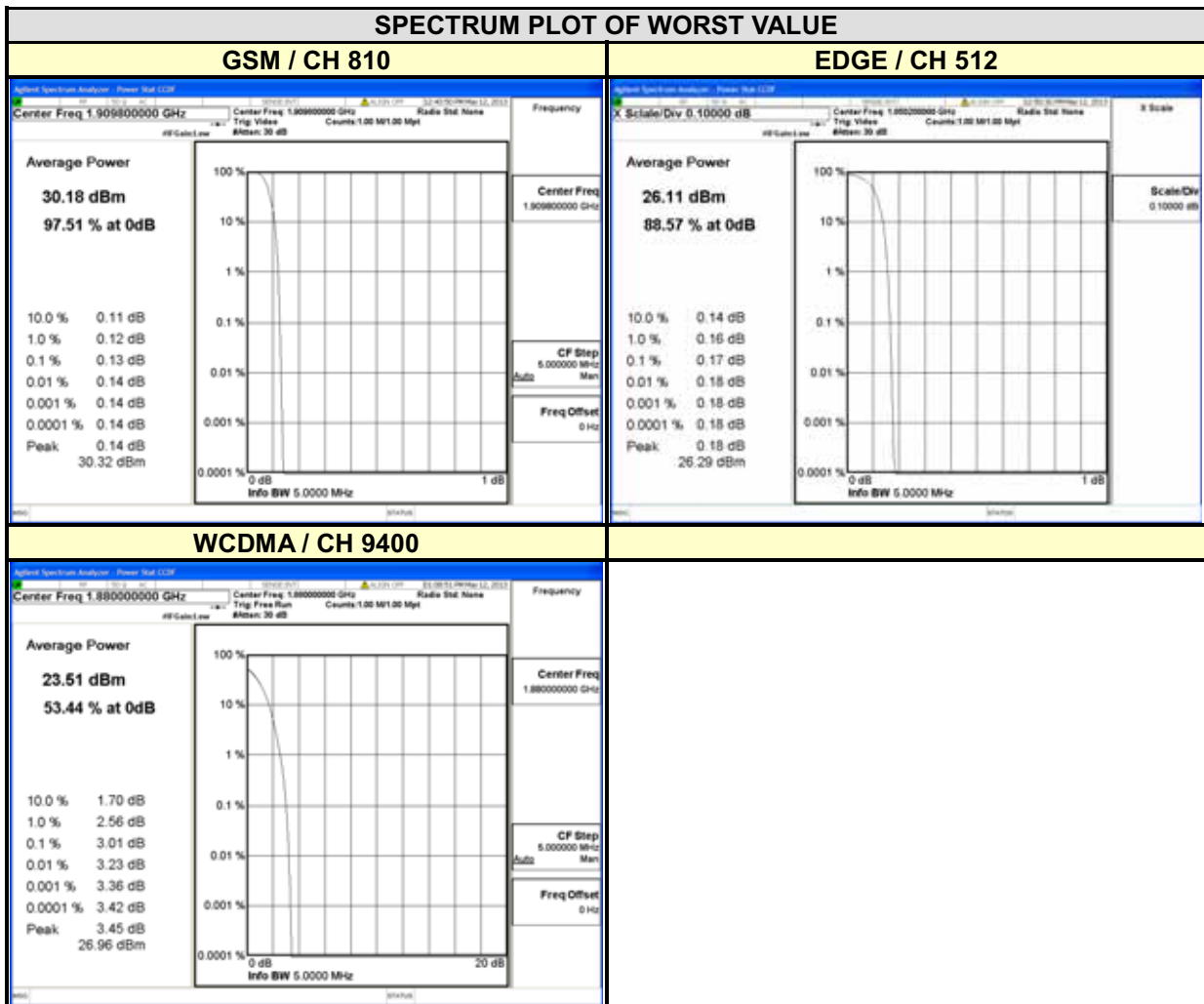

LTE BAND 2							
CHANNEL BANDWIDTH: 5MHz				CHANNEL BANDWIDTH: 10MHz			
CHANNEL	FREQUENCY (MHz)	PEAK TO AVERAGE RATIO (dB)		CHANNEL	FREQUENCY (MHz)	PEAK TO AVERAGE RATIO (dB)	
		QPSK	16QAM			QPSK	16QAM
18625	1852.5	4.28	5.43	18650	1855	4.24	5.39
18900	1880	4.75	5.90	18900	1880	4.74	5.88
19175	1907.5	4.96	6.18	19150	1905	5.06	6.27

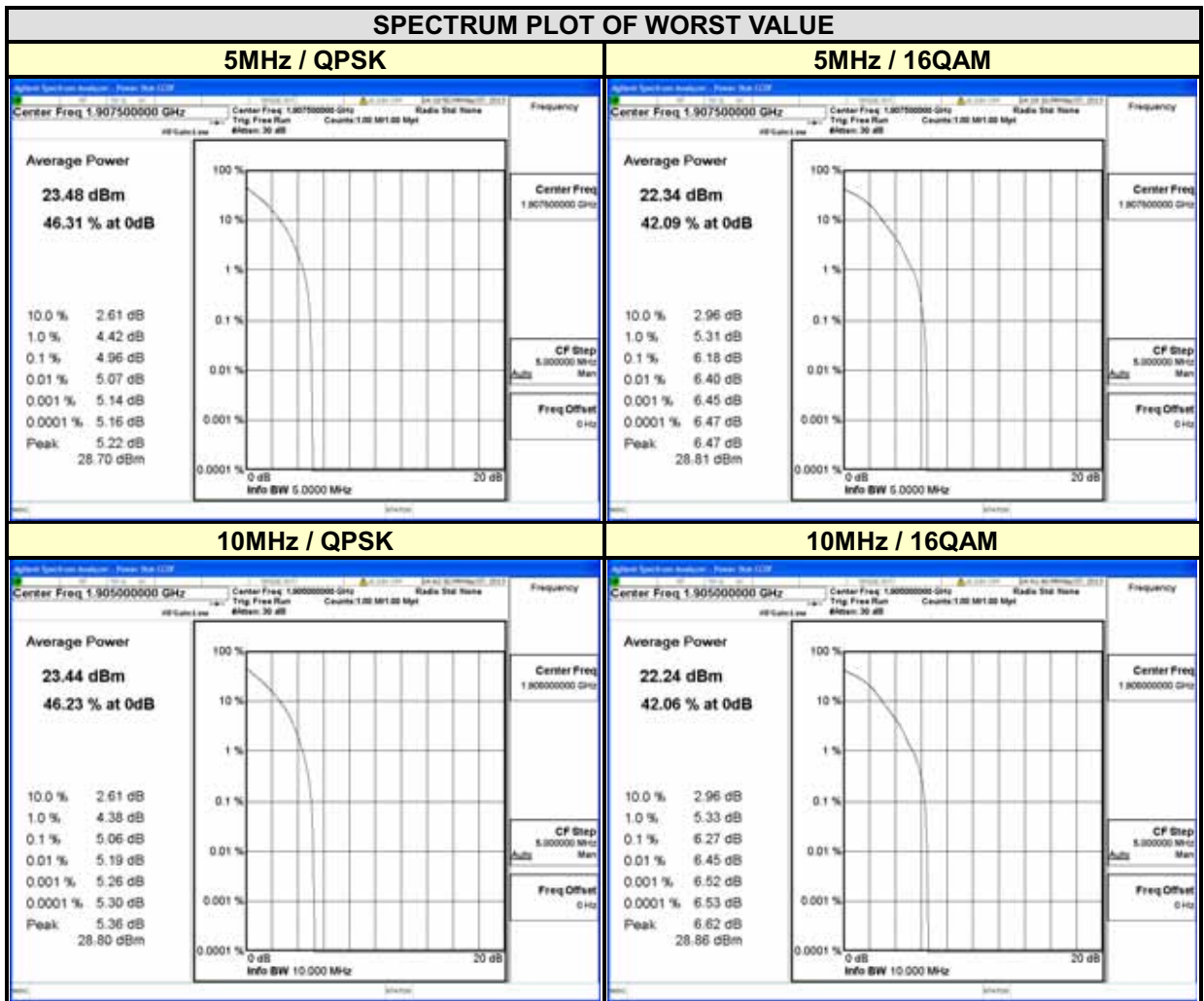

4.5 BAND EDGE MEASUREMENT

4.5.1 LIMITS OF BAND EDGE MEASUREMENT

Power of any emission outside of the authorized operating frequency ranges must be attenuated below the transmitting power (P) by a factor of at least $43 + 10 \log(P)$ dB. In the 1 MHz bands immediately outside and adjacent to the frequency block a resolution bandwidth of at least one percent of the emission bandwidth of the fundamental emission of the transmitter may be employed.

4.5.2 TEST SETUP

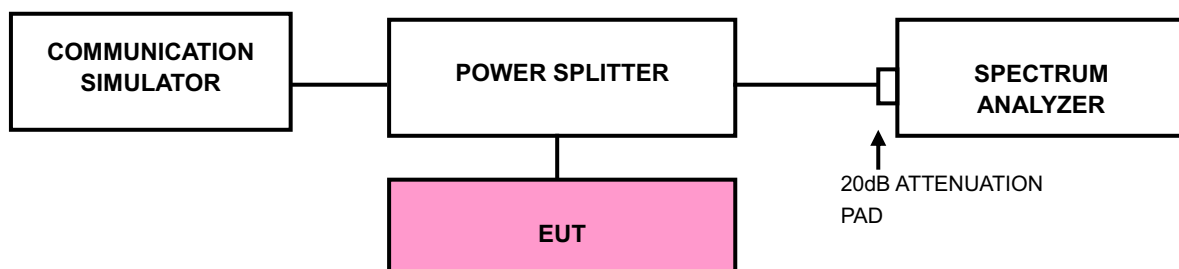

4.5.3 TEST PROCEDURES

- All measurements were done at low and high operational frequency range.
- The center frequency of spectrum is the band edge frequency and span is 1 MHz. RB of the spectrum is 3kHz and VB of the spectrum is 10kHz (GSM/GPRS/ EDGE).
- The center frequency of spectrum is the band edge frequency and span is 5MHz. RB of the spectrum is 100kHz and VB of the spectrum is 300kHz (WCDMA/LTE).
- Record the max trace plot into the test report.



A D T

4.5.4 TEST RESULTS

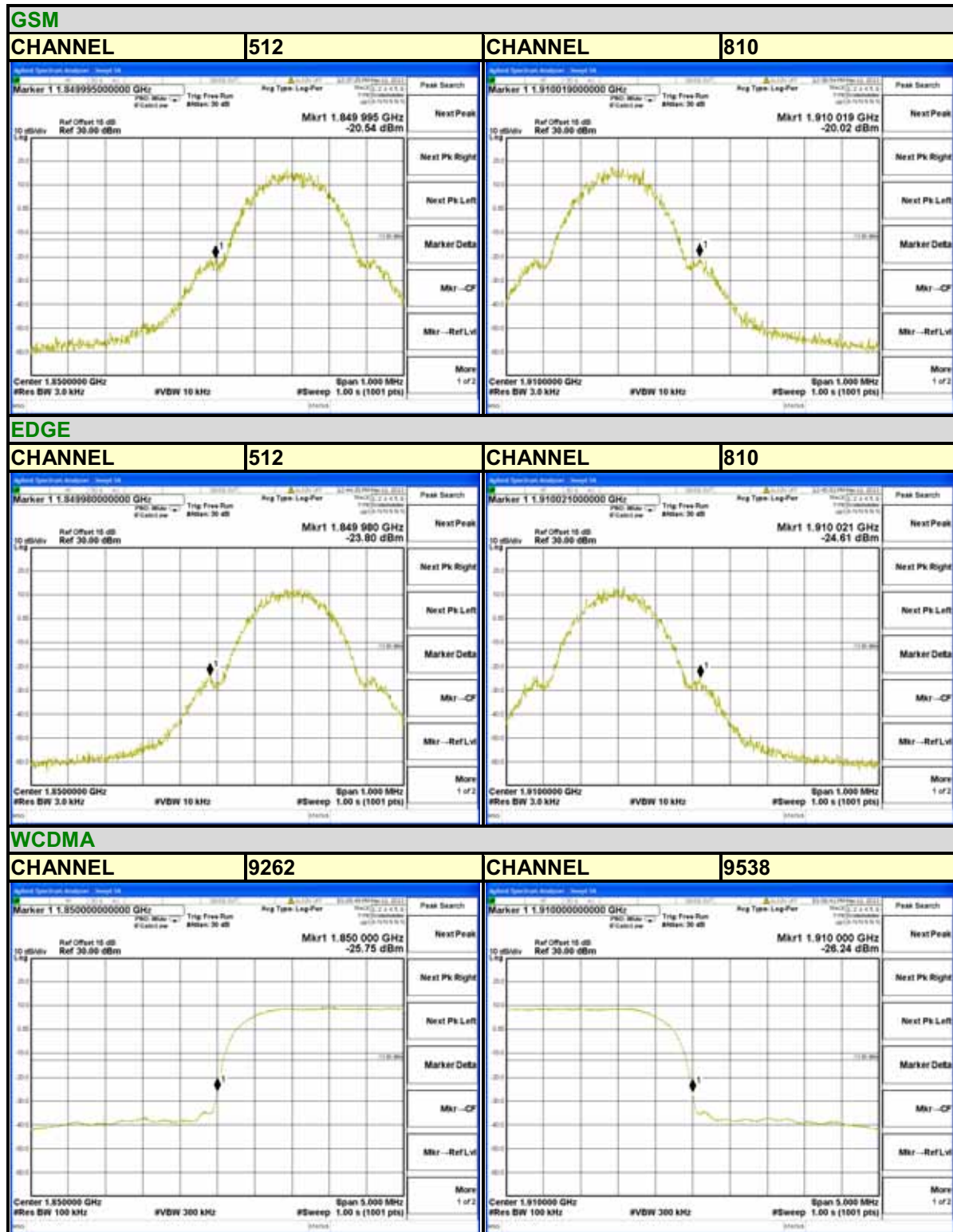



A D T

LTE Band 2

Channel Bandwidth: 5MHz

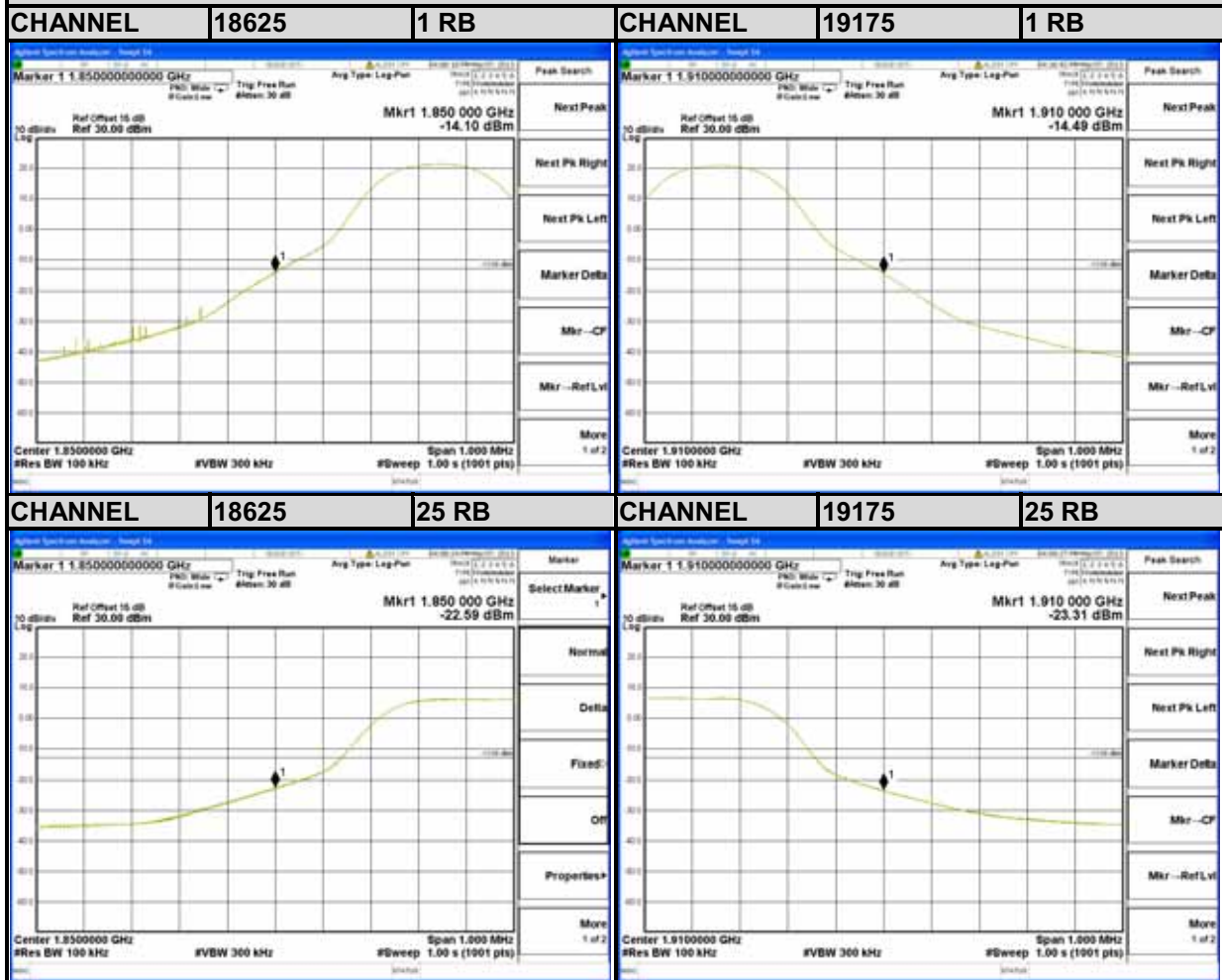



A D T

LTE Band 2

Channel Bandwidth: 10MHz

CHANNEL	18650	1 RB	CHANNEL	19150	1 RB
----------------	--------------	-------------	----------------	--------------	-------------

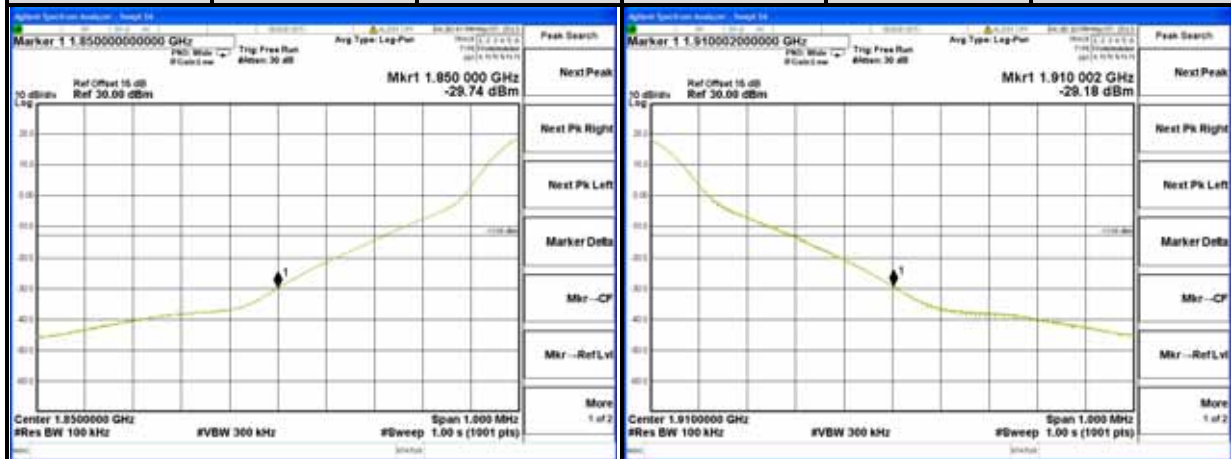

CHANNEL	18650	50 RB	CHANNEL	19150	50 RB
----------------	--------------	--------------	----------------	--------------	--------------

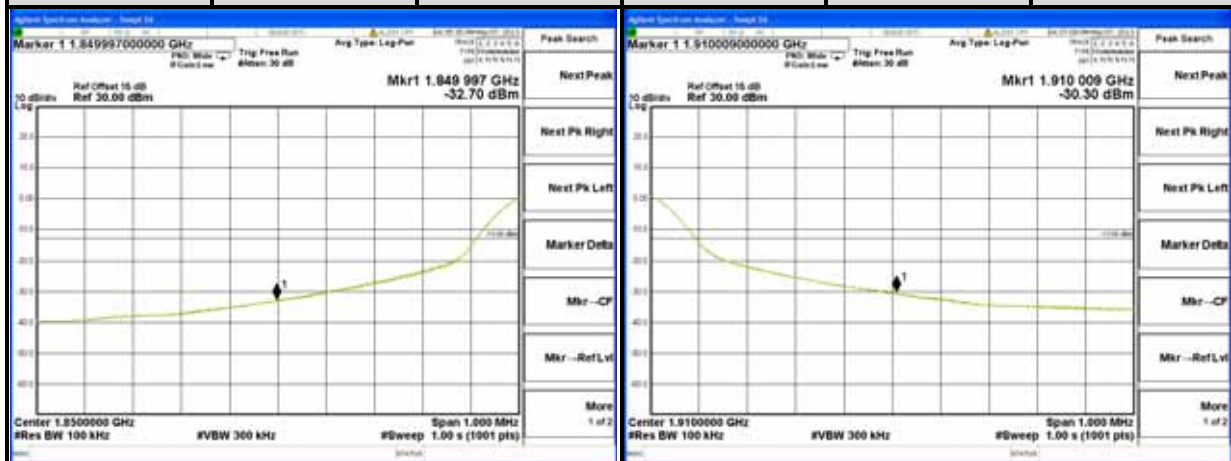

4.6 CONDUCTED SPURIOUS EMISSIONS

4.6.1 LIMITS OF CONDUCTED SPURIOUS EMISSIONS MEASUREMENT

The power of any emission outside of the authorized operating frequency ranges must be attenuated below the transmitting power (P) by a factor of at least $43 + 10 \log(P)$ dB. The emission limit equal to -13dBm .

4.6.2 TEST PROCEDURE

- a. The EUT makes a phone call to the communication simulator. All measurements were done at low, middle and high operational frequency range.
- b. Measuring frequency range is from 30 MHz to 19.1GHz. 10dB attenuation pad is connected with spectrum. RBW=1MHz and VBW=3MHz is used for conducted emission measurement.

4.6.3 TEST SETUP

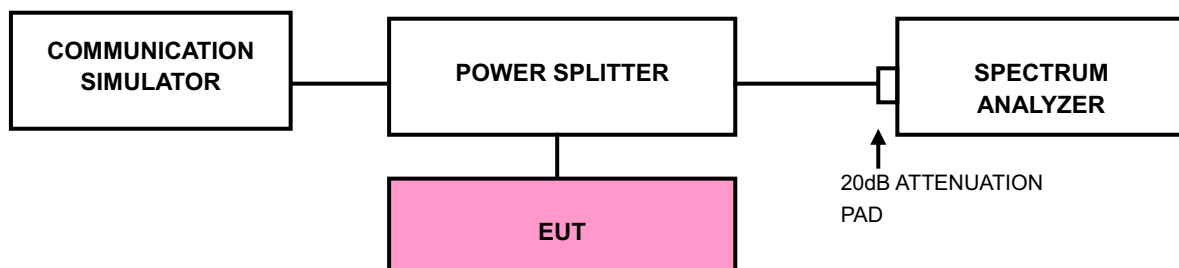

4.6.4 TEST RESULTS

GSM	EDGE
CHANNEL 661	CHANNEL 661
FREQUENCY RANGE : 30MHz~19.1GHz	FREQUENCY RANGE : 30MHz~19.1GHz
WCDMA	
CHANNEL 9400	
FREQUENCY RANGE : 30MHz~19.1GHz	
LTE Band 2 (Channel Bandwidth: 5MHz)	LTE Band 2 (Channel Bandwidth: 10MHz)
CHANNEL 18900	CHANNEL 18900
FREQUENCY RANGE : 30MHz~19.1GHz	FREQUENCY RANGE : 30MHz~19.1GHz

4.7 RADIATED EMISSION MEASUREMENT

4.7.1 LIMITS OF RADIATED EMISSION MEASUREMENT

The power of any emission outside of the authorized operating frequency ranges must be attenuated below the transmitting power (P) by a factor of at least $43 + 10 \log(P)$ dB. The emission limit equal to -13dBm .

4.7.2 TEST PROCEDURES

- a. Substitution method is used for E.I.R.P measurement. In the semi-anechoic chamber, EUT placed on the 0.8m height of Turn Table, rotated the table around 360 degrees to search the maximum radiation power and receiver antenna shall be rotated vertical and horizontal polarization and moved height from 1m to 4m to find the maximum polar radiated power. The “Read Value” is the spectrum reading the maximum power value.
- b. The substitution horn antenna is substituted for EUT at the same position and signals generator export the CW signal to the substitution antenna via a TX cable. Rotated the Turn Table and moved receiving antenna to find the maximum radiation power. Adjust output power level of S.G to get a Value of spectrum reading equal to “Read Value” of step a. Record the power level of S.G
- c. $\text{EIRP} = \text{Output power level of S.G} - \text{TX cable loss} + \text{Antenna gain of substitution horn}$.
- d. E.R.P power can be calculated form E.I.R.P power by subtracting the gain of dipole,
 $\text{E.R.P power} = \text{E.I.R.P power} - 2.15\text{dBi}$.

NOTE: The resolution bandwidth and video bandwidth of test receiver/spectrum analyzer is 1MHz/3MHz.

4.7.3 DEVIATION FROM TEST STANDARD

No deviation

4.7.4 TEST SETUP

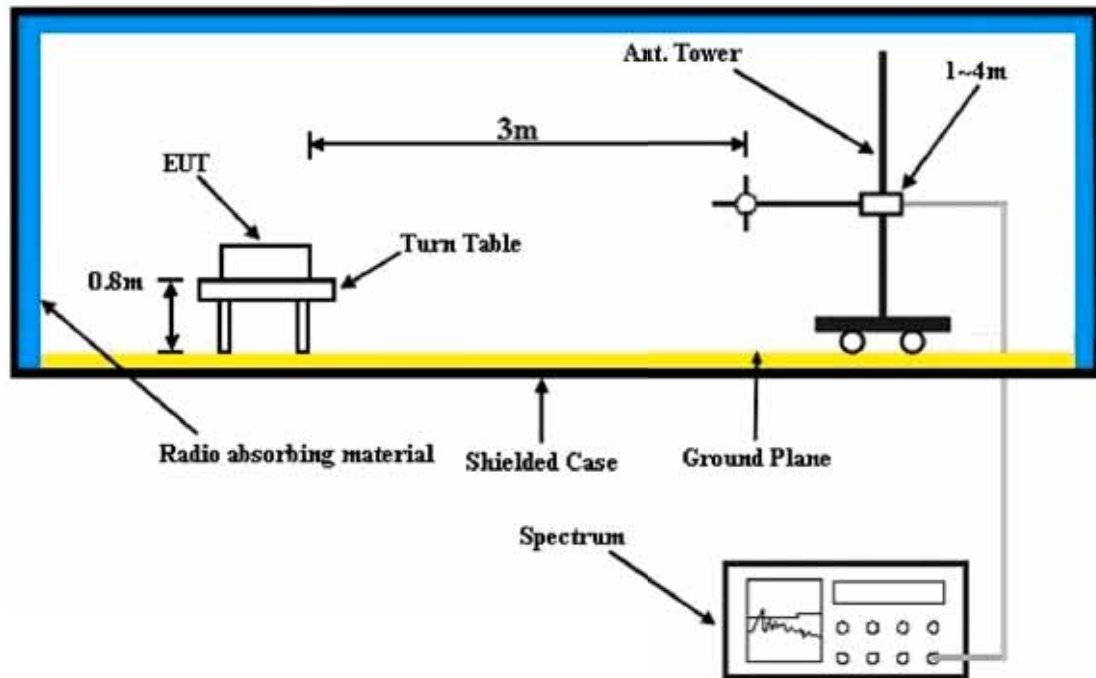

For the actual test configuration, please refer to the attached file (Test Setup Photo).

4.7.5 TEST RESULTS

GSM:



Bureau Veritas Consumer Products Services Ltd., Taoyuan Branch

A D T

Data: 11

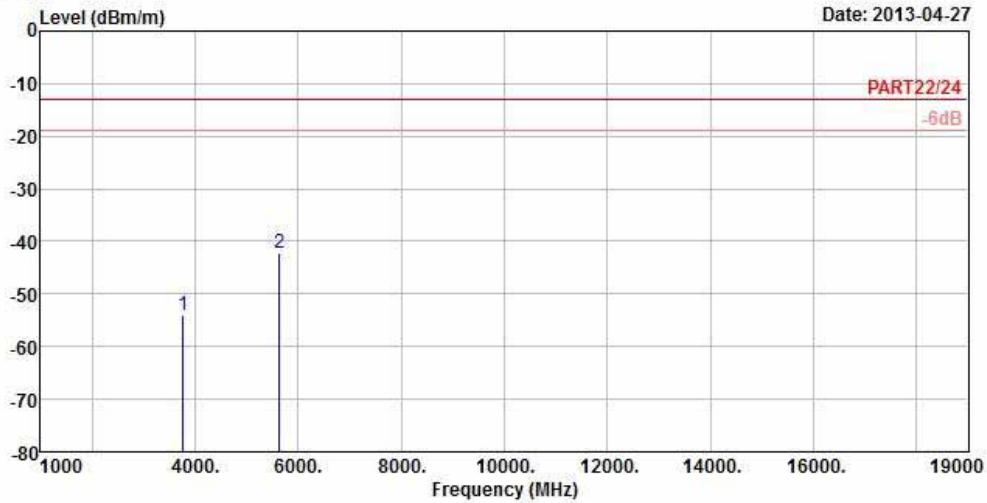

Site : 966 Chamber 5
 Condition : PART22/24 3m HORIZONTAL
 Brand/Model: P058220
 Remark : PCS1900 Link
 Tested by : Johnson Liao
 Temperature : 25°C
 Humidity : 65%
 Plane : X

	Freq	Level	Read	Limit	Over		
	MHz	dBm/m	Level	Line	Limit	Factor	Remark
			dBm	dBm/m	dB	dB/m	
1	3760.00	-54.12	-47.39	-13.00	-41.12	-6.73	Peak
2 pp	5640.00	-42.15	-42.36	-13.00	-29.15	0.21	Peak



Bureau Veritas Consumer Products Services Ltd., Taoyuan Branch

A D T

Data: 12

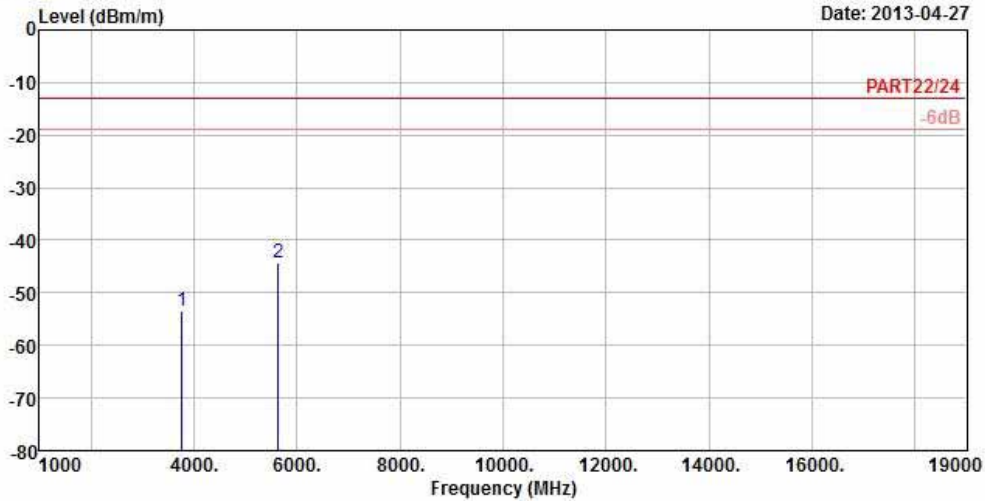

Site : 966 Chamber 5
 Condition : PART22/24 3m VERTICAL
 Brand/Model: P058220
 Remark : PCS1900 Link
 Tested by : Johnson Liao
 Temperature : 25°C
 Humidity : 65%
 Plane : X

	Freq	Level	Read Level	Limit Line	Over Limit	Factor	Remark
	MHz	dBm/m	dBm	dBm/m	dB	dB/m	
1	3760.00	-53.47	-46.74	-13.00	-40.47	-6.73	Peak
2 pp	5640.00	-44.36	-44.57	-13.00	-31.36	0.21	Peak

EDGE:



Bureau Veritas Consumer Products Services Ltd., Taoyuan Branch

A D T

Data: 15

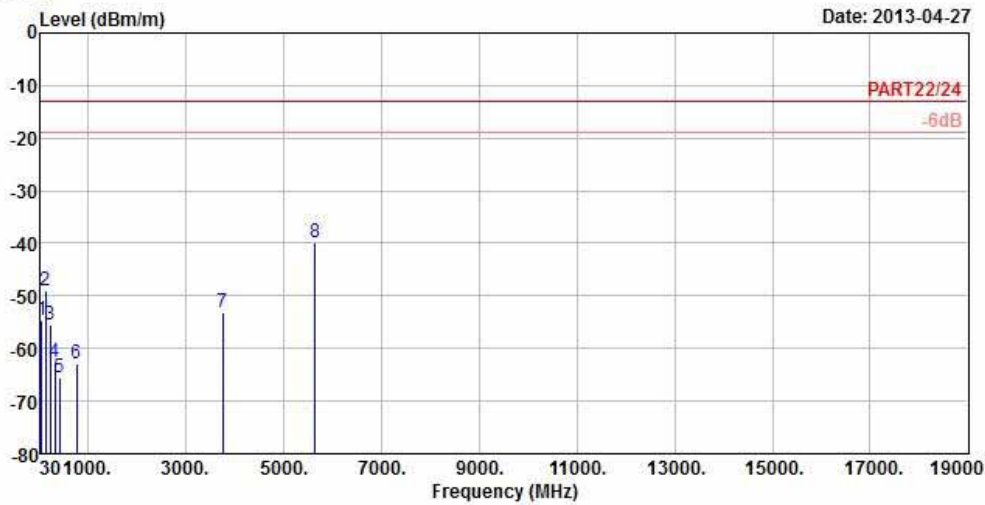

Site : 966 Chamber 5
 Condition : PART22/24 3m HORIZONTAL
 Brand/Model: P058220
 Remark : EDGE 1900 Link
 Tested by : Johnson Liao
 Temperature : 25°C
 Humidity : 65%
 Plane : X

	Freq	Level	Read Level	Limit Line	Over Limit	Factor	Remark
	MHz	dBm/m	dBm	dBm/m	dB	dB/m	
1	43.50	-54.62	-53.36	-13.00	-41.62	-1.26	Peak
2	138.00	-48.96	-42.77	-13.00	-35.96	-6.19	Peak
3	231.42	-55.63	-49.12	-13.00	-42.63	-6.51	Peak
4	315.40	-62.63	-56.36	-13.00	-49.63	-6.27	Peak
5	421.80	-65.52	-60.44	-13.00	-52.52	-5.08	Peak
6	760.60	-62.85	-64.71	-13.00	-49.85	1.86	Peak
7	3760.00	-53.14	-46.41	-13.00	-40.14	-6.73	Peak
8 pp	5640.00	-39.86	-40.07	-13.00	-26.86	0.21	Peak



Bureau Veritas Consumer Products Services Ltd., Taoyuan Branch

A D T

Data: 16

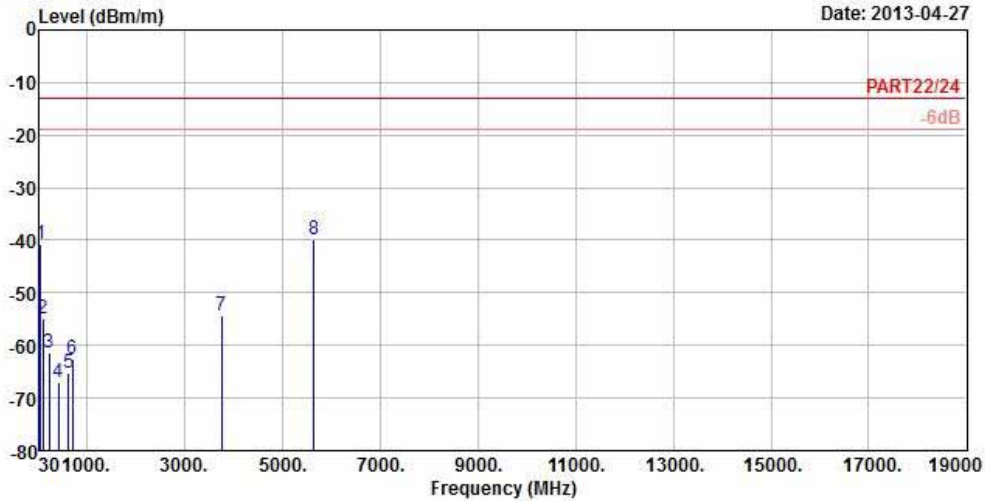

Site : 966 Chamber 5
 Condition : PART22/24 3m VERTICAL
 Brand/Model: P058220
 Remark : EDGE 1900 Link
 Tested by : Johnson Liao
 Temperature : 25°C
 Humidity : 65%
 Plane : X

	Freq	Level	Read Level	Limit Line	Over Limit	Factor	Remark
	MHz	dBm/m	dBm	dBm/m	dB	dB/m	
1	43.77	-40.80	-39.54	-13.00	-27.80	-1.26	Peak
2	105.06	-54.76	-44.26	-13.00	-41.76	-10.50	Peak
3	231.69	-61.26	-54.75	-13.00	-48.26	-6.51	Peak
4	416.90	-67.03	-61.83	-13.00	-54.03	-5.20	Peak
5	615.70	-65.25	-65.18	-13.00	-52.25	-0.07	Peak
6	707.40	-62.44	-63.94	-13.00	-49.44	1.50	Peak
7	3760.00	-54.35	-47.62	-13.00	-41.35	-6.73	Peak
8 pp	5640.00	-39.77	-39.98	-13.00	-26.77	0.21	Peak

WCDMA:



Bureau Veritas Consumer Products Services Ltd., Taoyuan Branch

A D T

Data: 11

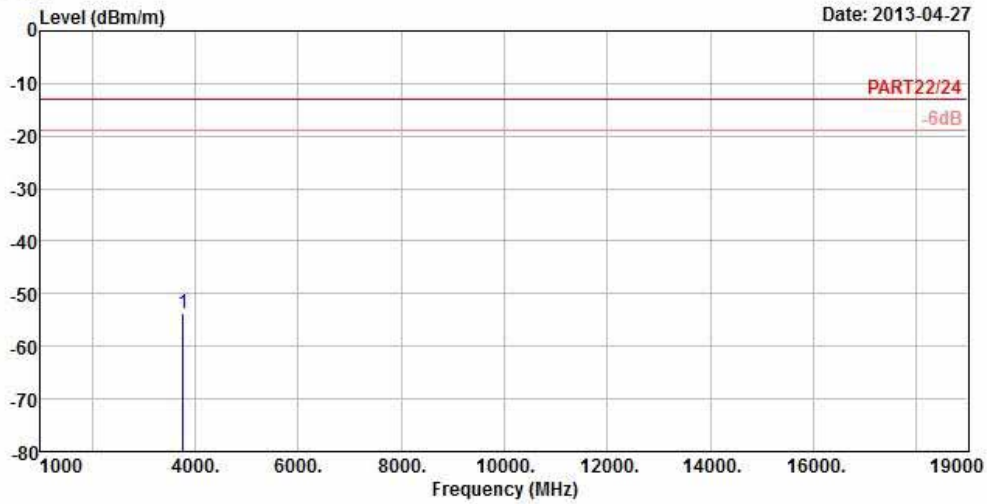

Site : 966 Chamber 5
 Condition : PART22/24 3m HORIZONTAL
 Brand/Model: P058220
 Remark : Band II Link
 Tested by : Johnson Liao
 Temperature : 25°C
 Humidity : 65%
 Plane : X

	Read	Limit	Over			
Freq	Level	Level	Line	Limit	Factor	Remark
MHz	dBm/m	dBm	dBm/m	dB	dB/m	
1 pp 3760.00	-53.68	-46.95	-13.00	-40.68	-6.73	Peak



A D T



Bureau Veritas Consumer Products Services Ltd., Taoyuan Branch

A D T

Data: 12

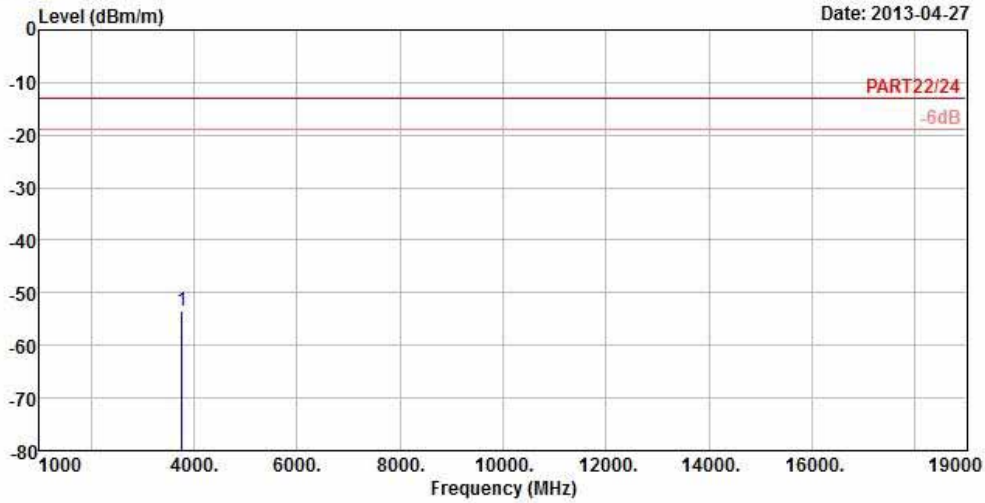

Site : 966 Chamber 5
 Condition : PART22/24 3m VERTICAL
 Brand/Model: P058220
 Remark : Band II Link
 Tested by : Johnson Liao
 Temperature : 25°C
 Humidity : 65%
 Plane : X

Freq	Level	Read Level	Limit Line	Over Limit	Factor	Remark
MHz	dBm/m	dBm	dBm/m	dB	dB/m	
1 pp 3760.00	-53.46	-46.73	-13.00	-40.46	-6.73	Peak

LTE BAND 2

CHANNEL BANDWIDTH: 5MHz / QPSK



Bureau Veritas Consumer Products Services Ltd., Taoyuan Branch

A D T

Data: 15

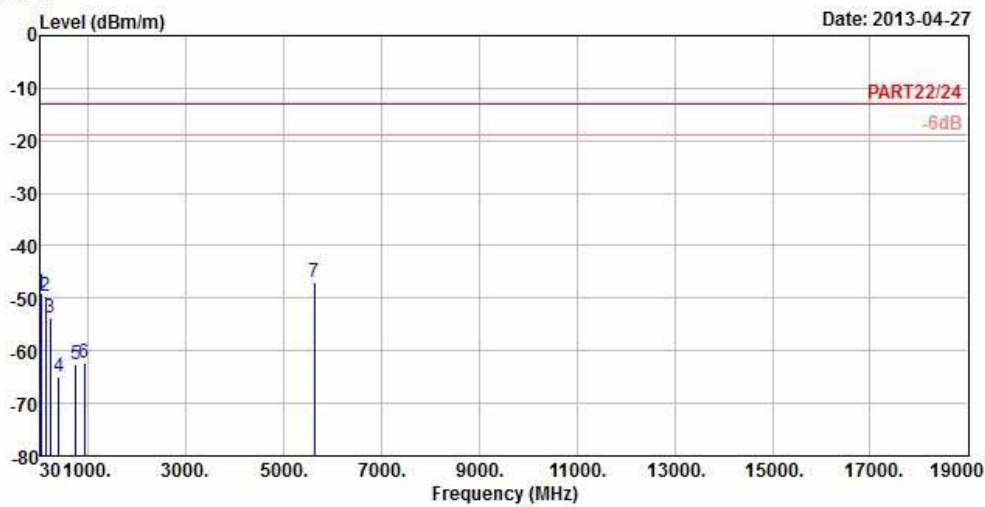

Site : 966 Chamber 5
 Condition : PART22/24 3m HORIZONTAL
 Brand/Model: P058220
 Remark : Band 2_5M_(QPSK 1,0) Link
 Tested by : David Huang
 Temperature : 25°C
 Humidity : 65%
 Plane : Y

	Freq	Level	Read Level	Limit Line	Over Limit	Factor	Remark
	MHz	dBm/m	dBm	dBm/m	dB	dB/m	
1	35.94	-48.89	-46.53	-13.00	-35.89	-2.36	Peak
2	136.65	-49.47	-43.02	-13.00	-36.47	-6.45	Peak
3	228.72	-53.66	-47.02	-13.00	-40.66	-6.64	Peak
4	405.70	-64.85	-59.36	-13.00	-51.85	-5.49	Peak
5	750.80	-62.52	-64.31	-13.00	-49.52	1.79	Peak
6	923.70	-62.22	-65.38	-13.00	-49.22	3.16	Peak
7 pp	5633.40	-46.91	-47.09	-13.00	-33.91	0.18	Peak



A D T



Bureau Veritas Consumer Products Services Ltd., Taoyuan Branch

A D T

Data: 16

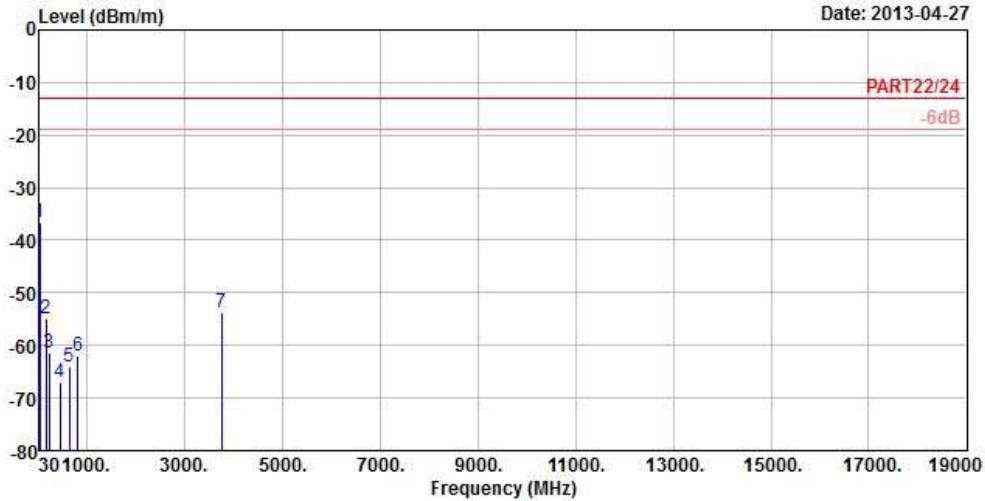

Site : 966 Chamber 5
 Condition : PART22/24 3m VERTICAL
 Brand/Model: P058220
 Remark : Band 2_5M_(QPSK 1,0) Link
 Tested by : David Huang
 Temperature : 25°C
 Humidity : 65%
 Plane : Y

	Freq	Level	Read Level	Limit Line	Over Limit	Factor	Remark
	MHz	dBm/m	dBm	dBm/m	dB	dB/m	
1	pp	42.42	-36.49	-35.16	-13.00	-23.49	-1.33 Peak
2		156.09	-55.03	-48.58	-13.00	-42.03	-6.45 Peak
3		221.16	-61.50	-54.51	-13.00	-48.50	-6.99 Peak
4		444.90	-66.92	-62.43	-13.00	-53.92	-4.49 Peak
5		640.90	-64.17	-64.55	-13.00	-51.17	0.38 Peak
6		808.20	-62.09	-64.26	-13.00	-49.09	2.17 Peak
7		3755.60	-53.63	-46.90	-13.00	-40.63	-6.73 Peak

CHANNEL BANDWIDTH: 10MHz / QPSK



Bureau Veritas Consumer Products Services Ltd., Taoyuan Branch

A D T

Data: 11

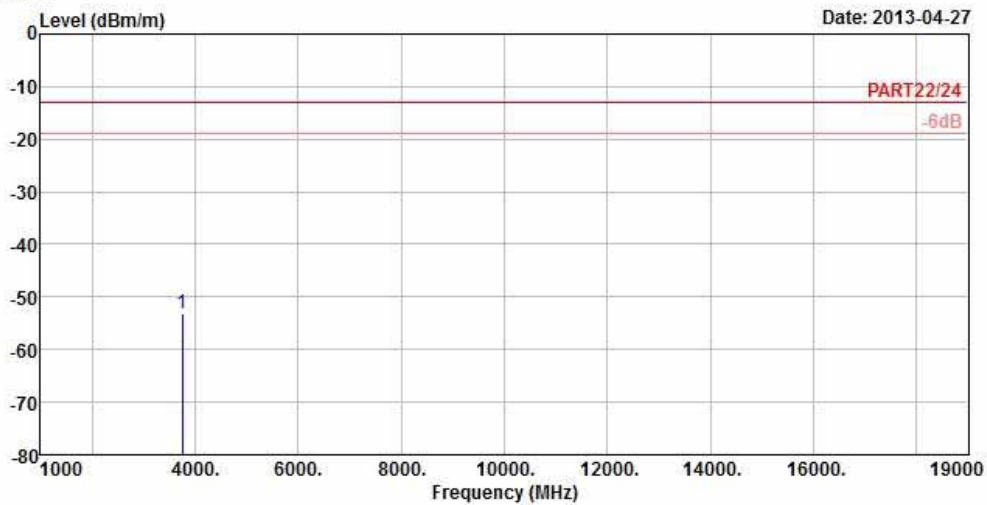

Site : 966 Chamber 5
 Condition : PART22/24 3m HORIZONTAL
 Brand/Model: P058220
 Remark : Band 2_10M_(QPSK 1,0) Link
 Tested by : David Huang
 Temperature : 25°C
 Humidity : 65%
 Plane : Y

Freq	Level	Read Level	Limit Line	Over Limit	Factor	Remark
MHz	dBm/m	dBm	dBm/m	dB	dB/m	
1 pp 3755.60	-53.21	-46.48	-13.00	-40.21	-6.73	Peak



Bureau Veritas Consumer Products Services Ltd., Taoyuan Branch

A D T

Data: 12

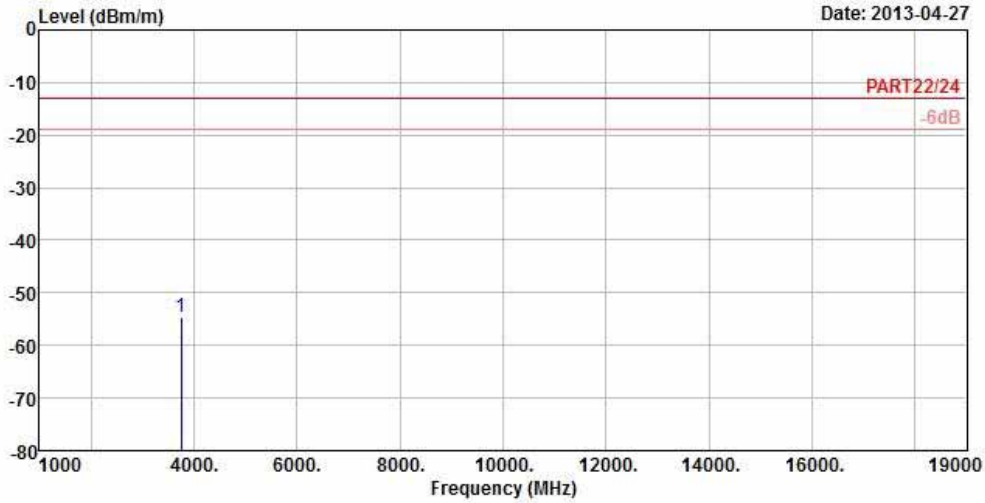

Site : 966 Chamber 5
 Condition : PART22/24 3m VERTICAL
 Brand/Model: P058220
 Remark : Band 2_10M_(QPSK 1,0) Link
 Tested by : David Huang
 Temperature : 25°C
 Humidity : 65%
 Plane : Y

Freq	Level	Read Level	Limit Line	Over Limit	Factor	Remark
MHz	dBm/m	dBm	dBm/m	dB	dB/m	
1 pp 3755.60	-54.69	-47.96	-13.00	-41.69	-6.73	Peak



5 PHOTOGRAPHS OF THE TEST CONFIGURATION

Please refer to the attached file (Test Setup Photo).



6 INFORMATION ON THE TESTING LABORATORIES

We, Bureau Veritas Consumer Products Services (H.K.) Ltd., Taoyuan Branch, were founded in 1988 to provide our best service in EMC, Radio, Telecom and Safety consultation. Our laboratories are accredited and approved according to ISO/IEC 17025.

If you have any comments, please feel free to contact us at the following:

Linko EMC/RF Lab:

Tel: 886-2-26052180

Fax: 886-2-26051924

Hsin Chu EMC/RF Lab:

Tel: 886-3-5935343

Fax: 886-3-5935342

Hwa Ya EMC/RF/Safety/Telecom Lab:

Tel: 886-3-3183232

Fax: 886-3-3270892

Email: service.adt@tw.bureauveritas.com

Web Site: www.bureauveritas-adt.com

The address and road map of all our labs can be found in our web site also.



7 APPENDIX A – MODIFICATIONS RECORDERS FOR ENGINEERING CHANGES TO THE EUT BY THE LAB

No any modifications were made to the EUT by the lab during the test.

---END---