



FCC TEST REPORT (15.407)

REPORT NO.: RF130408C19-5
MODEL NO.: PO58220
FCC ID: NM8PO58220
RECEIVED: Apr. 04, 2013
TESTED: Apr. 24, 2013 ~ May 13, 2013
ISSUED: May 23, 2013

APPLICANT: HTC Corporation

ADDRESS: 23, Xinghua Rd., Taoyuan 330, Taiwan, R.O.C.

ISSUED BY: Bureau Veritas Consumer Products Services
(H.K.) Ltd., Taoyuan Branch

LAB ADDRESS: No. 47, 14th Ling, Chia Pau Vil., Lin Kou Dist.,
New Taipei City, Taiwan (R.O.C)

TEST LOCATION: No. 19, Hwa Ya 2nd Rd, Wen Hwa Tsuen, Kwei
Shan Hsiang, Taoyuan Hsien 333, Taiwan, R.O.C.

This report should not be used by the client to claim product certification, approval, or endorsement by TAF or any government agencies.



This report is for your exclusive use. Any copying or replication of this report to or for any other person or entity, or use of our name or trademark, is permitted only with our prior written permission. This report sets forth our findings solely with respect to the test samples identified herein. The results set forth in this report are not indicative or representative of the quality or characteristics of the lot from which a test sample was taken or any similar or identical product unless specifically and expressly noted. Our report includes all of the tests requested by you and the results thereof based upon the information that you provided to us. You have 60 days from date of issuance of this report to notify us of any material error or omission caused by our negligence, provided, however, that such notice shall be in writing and shall specifically address the issue you wish to raise. A failure to raise such issue within the prescribed time shall constitute your unqualified acceptance of the completeness of this report, the tests conducted and the correctness of the report contents. Unless specific mention, the uncertainty of measurement has been explicitly taken into account to declare the compliance or non-compliance to the specification

TABLE OF CONTENTS

RELEASE CONTROL RECORD	4
1. CERTIFICATION	5
2. SUMMARY OF TEST RESULTS	6
2.1 MEASUREMENT UNCERTAINTY	6
3. GENERAL INFORMATION	7
3.1 GENERAL DESCRIPTION OF EUT	7
3.2 DESCRIPTION OF TEST MODES	8
3.2.1 TEST MODE APPLICABILITY AND TESTED CHANNEL DETAIL	9
3.3 DESCRIPTION OF SUPPORT UNITS	11
3.3.1 CONFIGURATION OF SYSTEM UNDER TEST	11
3.4 DUTY CYCLE OF TEST SIGNAL	12
3.5 GENERAL DESCRIPTION OF APPLIED STANDARDS	13
4. TEST TYPES AND RESULTS	14
4.1 RADIATED EMISSION AND BANDEDGE MEASUREMENT	14
4.1.1 LIMITS OF RADIATED EMISSION AND BANDEDGE MEASUREMENT	14
4.1.2 LIMITS OF UNWANTED EMISSION OUT OF THE RESTRICTED BANDS	14
4.1.3 TEST INSTRUMENTS	15
4.1.4 TEST PROCEDURES	16
4.1.5 DEVIATION FROM TEST STANDARD	16
4.1.6 TEST SETUP	17
4.1.7 EUT OPERATING CONDITION	17
4.1.8 TEST RESULTS	18
4.2 CONDUCTED EMISSION MEASUREMENT	44
4.2.1 LIMITS OF CONDUCTED EMISSION MEASUREMENT	44
4.2.2 TEST INSTRUMENTS	44
4.2.3 TEST PROCEDURES	45
4.2.4 DEVIATION FROM TEST STANDARD	45
4.2.5 TEST SETUP	45
4.2.6 EUT OPERATING CONDITIONS	45
4.2.7 TEST RESULTS	46
4.3 PEAK TRANSMIT POWER MEASUREMENT	48
4.3.1 LIMITS OF PEAK TRANSMIT POWER MEASUREMENT	48
4.3.2 TEST SETUP	48
4.3.3 TEST INSTRUMENTS	48
4.3.4 TEST PROCEDURE	49
4.3.5 DEVIATION FROM TEST STANDARD	49
4.3.6 EUT OPERATING CONDITIONS	49
4.3.7 TEST RESULTS	50
4.4 PEAK POWER SPECTRAL DENSITY MEASUREMENT	52
4.4.1 LIMITS OF PEAK POWER SPECTRAL DENSITY MEASUREMENT	52
4.4.2 TEST SETUP	52
4.4.3 TEST INSTRUMENTS	52
4.4.4 TEST PROCEDURES	52
4.4.5 DEVIATION FROM TEST STANDARD	52
4.4.6 EUT OPERATING CONDITIONS	52
4.4.7 TEST RESULTS	53
4.5 PEAK POWER EXCURSION MEASUREMENT	55



A D T

4.5.1	LIMITS OF PEAK POWER EXCURSION MEASUREMENT	55
4.5.2	TEST SETUP	55
4.5.3	TEST INSTRUMENTS.....	55
4.5.4	TEST PROCEDURE	55
4.5.5	DEVIATION FROM TEST STANDARD	55
4.5.6	EUT OPERATING CONDITIONS	55
4.5.7	TEST RESULTS	56
4.6	FREQUENCY STABILITY.....	59
4.6.1	LIMITS OF FREQUENCY STABILITY MEASUREMENT	59
4.6.2	TEST SETUP	59
4.6.3	TEST INSTRUMENTS.....	59
4.6.4	TEST PROCEDURE	60
4.6.5	DEVIATION FROM TEST STANDARD	60
4.6.6	EUT OPERATING CONDITION	60
4.6.7	TEST RESULTS	61
5.	PHOTOGRAPHS OF THE TEST CONFIGURATION	62
6.	INFORMATION ON THE TESTING LABORATORIES	63
7.	APPENDIX A - MODIFICATIONS RECORDERS FOR ENGINEERING CHANGES TO THE EUT BY THE LAB.....	64



A D T

RELEASE CONTROL RECORD

ISSUE NO.	REASON FOR CHANGE	DATE ISSUED
RF130408C19-5	Original release	May 23, 2013



1. CERTIFICATION

PRODUCT: Smartphone
MODEL NO.: PO58220
BRAND: HTC
APPLICANT: HTC Corporation
TESTED: Apr. 24, 2013 ~ May 13, 2013
TEST SAMPLE: PRODUCTION UNIT
STANDARDS: **FCC Part 15, Subpart E (Section 15.407)**
ANSI C63.10-2009

The above equipment (model: PO58220) has been tested by **Bureau Veritas Consumer Products Services (H.K.) Ltd., Taoyuan Branch**, and found compliance with the requirement of the above standards. The test record, data evaluation & Equipment Under Test (EUT) configurations represented herein are true and accurate accounts of the measurements of the sample's EMC characteristics under the conditions specified in this report.

PREPARED BY : Ivonne Wu , **DATE** : May 23, 2013
Ivonne Wu / Senior Specialist

APPROVED BY : Sam Chen , **DATE** : May 23, 2013
Sam Chen / Assistant Manager

2. SUMMARY OF TEST RESULTS

The EUT has been tested according to the following specifications:

APPLIED STANDARD: FCC PART 15, SUBPART E (SECTION 15.407)			
STANDARD SECTION	TEST TYPE	RESULT	REMARK
15.407(b)(6)	AC Power Conducted Emission	PASS	Meet the requirement of limit. Minimum passing margin is -20.29dB at 0.84141MHz.
15.407(b/1/2/3) (b)(6)	Spurious Emissions	PASS	Meet the requirement of limit. Minimum passing margin is -5.11dB at 42.69MHz.
15.407(a/1/2)	Peak Transmit Power	PASS	Meet the requirement of limit.
15.407(a)(6)	Peak Power Excursion	PASS	Meet the requirement of limit.
15.407(a/1/2)	Peak Power Spectral Density	PASS	Meet the requirement of limit.
15.407(g)	Frequency Stability	PASS	Meet the requirement of limit.
15.203	Antenna Requirement	PASS	No antenna connector is used.

2.1 MEASUREMENT UNCERTAINTY

Where relevant, the following measurement uncertainty levels have been estimated for tests performed on the EUT as specified in CISPR 16-4-2:

MEASUREMENT	FREQUENCY	UNCERTAINTY
Conducted emissions	9kHz~30MHz	2.44 dB
Radiated emissions	30MHz ~ 200MHz	2.93 dB
	200MHz ~1000MHz	2.95 dB
	1GHz ~ 18GHz	2.26 dB
	18GHz ~ 40GHz	1.94 dB

This uncertainty represents an expanded uncertainty expressed at approximately the 95% confidence level using a coverage factor of $k = 2$.

3. GENERAL INFORMATION

3.1 GENERAL DESCRIPTION OF EUT

EUT	Smartphone
MODEL NO.	PO58220
POWER SUPPLY	5.0Vdc (adapter or host equipment) 3.8Vdc (Li-ion battery)
MODULATION TYPE	64QAM, 16QAM, QPSK, BPSK
MODULATION TECHNOLOGY	OFDM
TRANSFER RATE	802.11a: 54.0/ 48.0/ 36.0/ 24.0/ 18.0/ 12.0/ 9.0/ 6.0Mbps 802.11n: up to MCS7
OPERATING FREQUENCY	5180 ~ 5240MHz, 5260 ~ 5320MHz & 5500 ~ 5700MHz
NUMBER OF CHANNEL	5180 ~ 5240MHz: 4 for 802.11a, 802.11n (20MHz) 2 for 802.11n (40MHz) 5260 ~ 5320MHz: 4 for 802.11a, 802.11n (20MHz) 2 for 802.11n (40MHz) 5500 ~ 5700MHz: 8 for 802.11a, 802.11n (20MHz) 3 for 802.11n (40MHz)
OUTPUT POWER	37.325mW for 5180 ~ 5240MHz 38.994mW for 5260 ~ 5320MHz 37.844mW for 5500 ~ 5700MHz
ANTENNA TYPE	PIFA antenna with -1dBi gain (5180 ~ 5240MHz) PIFA antenna with 1dBi gain (5260 ~ 5320MHz) PIFA antenna with 0dBi gain (5500 ~ 5700MHz)
ANTENNA CONNECTOR	NA
DATA CABLE	Refer to Note as below
I/O PORTS	Refer to user's manual
ACCESSORY DEVICES	Refer to Note as below

NOTE:

- The device has 2 configurations as below.
Main sample (A): Battery 1 + LCD Panel 1 + Photo Camera 1
2nd sample (B): Battery 2 + LCD Panel 2 + Photo Camera 2
✧ Only the test data for main sample was presented in the report, since the verified data for 2nd sample was not worse than the main sample.
- The EUT's accessories list refers to Ext. Pho.
- The above EUT information is declared by the manufacturer and for more detailed features description, please refer to the manufacturer's specifications or User's Manual.

3.2 DESCRIPTION OF TEST MODES

FOR 5180 ~ 5240MHz

4 channels are provided for 802.11a, 802.11n (20MHz):

CHANNEL	FREQUENCY	CHANNEL	FREQUENCY
36	5180 MHz	44	5220 MHz
40	5200 MHz	48	5240 MHz

2 channels are provided for 802.11n (40MHz):

CHANNEL	FREQUENCY	CHANNEL	FREQUENCY
38	5190 MHz	46	5230 MHz

FOR 5260 ~ 5320MHz

4 channels are provided for 802.11a, 802.11n (20MHz):

CHANNEL	FREQUENCY	CHANNEL	FREQUENCY
52	5260 MHz	60	5300 MHz
56	5280 MHz	64	5320 MHz

2 channels are provided for 802.11n (40MHz):

CHANNEL	FREQUENCY	CHANNEL	FREQUENCY
54	5270 MHz	62	5310 MHz

FOR 5500 ~ 5700MHz

8 channels are provided for 802.11a, 802.11n (20MHz):

CHANNEL	FREQUENCY	CHANNEL	FREQUENCY
100	5500MHz	116	5580MHz
104	5520MHz	132	5660MHz
108	5540MHz	136	5680MHz
112	5560MHz	140	5700MHz

3 channels are provided for 802.11n (40MHz):

CHANNEL	FREQUENCY	CHANNEL	FREQUENCY
102	5510MHz	134	5670MHz
110	5550MHz		

3.2.1 TEST MODE APPLICABILITY AND TESTED CHANNEL DETAIL

EUT CONFIGURE MODE	APPLICABLE TO				DESCRIPTION
	RE \geq 1G	RE<1G	PLC	APCM	
-	√	√	√	√	-

Where **RE \geq 1G**: Radiated Emission above 1GHz **RE<1G**: Radiated Emission below 1GHz
PLC: Power Line Conducted Emission **APCM**: Antenna Port Conducted Measurement

NOTE: The EUT had been pre-tested on the positioned of each 3 axis. The worst case was found when positioned on **Z-plane** for 5180MHz~5240MHz & 5500MHz~5700MHz and **Y-plane** for 5260MHz~5320MHz.

RADIATED EMISSION TEST (ABOVE 1GHz):

- Pre-Scan has been conducted to determine the worst-case mode from all possible combinations between available modulations, data rates and antenna ports (if EUT with antenna diversity architecture).
- Following channel(s) was (were) selected for the final test as listed below.

MODE	FREQ. BAND (MHz)	AVAILABLE CHANNEL	TESTED CHANNEL	MODULATION TECHNOLOGY	MODULATION TYPE	DATA RATE (Mbps)
802.11a	5180-5240	36 to 48	36, 44, 48	OFDM	BPSK	6.0
802.11n (20MHz)		36 to 48	36, 44, 48	OFDM	BPSK	MCS0
802.11n (40MHz)		38 to 46	38, 46	OFDM	BPSK	MCS0
802.11a	5260-5320	52 to 64	52, 60, 64	OFDM	BPSK	6.0
802.11n (20MHz)		52 to 64	52, 60, 64	OFDM	BPSK	MCS0
802.11n (40MHz)		54 to 62	54, 62	OFDM	BPSK	MCS0
802.11a	5500-5700	100 to 140	100, 116, 140	OFDM	BPSK	6.0
802.11n (20MHz)		100 to 140	100, 116, 140	OFDM	BPSK	MCS0
802.11n (40MHz)		102 to 134	102, 110, 134	OFDM	BPSK	MCS0

RADIATED EMISSION TEST (BELOW 1GHz):

- Pre-Scan has been conducted to determine the worst-case mode from all possible combinations between available modulations, data rates and antenna ports (if EUT with antenna diversity architecture).
- Following channel(s) was (were) selected for the final test as listed below.

MODE	FREQ. BAND (MHz)	AVAILABLE CHANNEL	TESTED CHANNEL	MODULATION TECHNOLOGY	MODULATION TYPE	DATA RATE (Mbps)
802.11a	5260-5320	52 to 64	64	OFDM	BPSK	6.0

POWER LINE CONDUCTED EMISSION TEST:

- Pre-Scan has been conducted to determine the worst-case mode from all possible combinations between available modulations, data rates and antenna ports (if EUT with antenna diversity architecture).
- Following channel(s) was (were) selected for the final test as listed below.

MODE	FREQ. BAND (MHz)	AVAILABLE CHANNEL	TESTED CHANNEL	MODULATION TECHNOLOGY	MODULATION TYPE	DATA RATE (Mbps)
802.11a	5260-5320	52 to 64	64	OFDM	BPSK	6.0

BANDEDGE MEASUREMENT:

- Pre-Scan has been conducted to determine the worst-case mode from all possible combinations between available modulations, data rates and antenna ports (if EUT with antenna diversity architecture).
- Following channel(s) was (were) selected for the final test as listed below.

MODE	FREQ. BAND (MHz)	AVAILABLE CHANNEL	TESTED CHANNEL	MODULATION TECHNOLOGY	MODULATION TYPE	DATA RATE (Mbps)
802.11a	5180-5240	36 to 48	36, 48	OFDM	BPSK	6.0
802.11n (20MHz)		36 to 48	36, 48	OFDM	BPSK	MCS0
802.11n (40MHz)		38 to 46	38, 46	OFDM	BPSK	MCS0
802.11a	5260-5320	52 to 64	52, 64	OFDM	BPSK	6.0
802.11n (20MHz)		52 to 64	52, 64	OFDM	BPSK	MCS0
802.11n (40MHz)		54 to 62	54, 62	OFDM	BPSK	MCS0
802.11a	5500-5700	100 to 140	100, 140	OFDM	BPSK	6.0
802.11n (20MHz)		100 to 140	100, 140	OFDM	BPSK	MCS0
802.11n (40MHz)		102 to 134	102, 134	OFDM	BPSK	MCS0

ANTENNA PORT CONDUCTED MEASUREMENT:

- This item includes all test value of each mode, but only includes spectrum plot of worst value of each mode.
- Pre-Scan has been conducted to determine the worst-case mode from all possible combinations between available modulations, data rates and antenna ports (if EUT with antenna diversity architecture).
- Following channel(s) was (were) selected for the final test as listed below.

MODE	FREQ. BAND (MHz)	AVAILABLE CHANNEL	TESTED CHANNEL	MODULATION TECHNOLOGY	MODULATION TYPE	DATA RATE (Mbps)
802.11a	5180-5240	36 to 48	36, 44, 48	OFDM	BPSK	6.0
802.11n (20MHz)		36 to 48	36, 44, 48	OFDM	BPSK	MCS0
802.11n (40MHz)		38 to 46	38, 46	OFDM	BPSK	MCS0
802.11a	5260-5320	52 to 64	52, 60, 64	OFDM	BPSK	6.0
802.11n (20MHz)		52 to 64	52, 60, 64	OFDM	BPSK	MCS0
802.11n (40MHz)		54 to 62	54, 62	OFDM	BPSK	MCS0
802.11a	5500-5700	100 to 140	100, 116, 140	OFDM	BPSK	6.0
802.11n (20MHz)		100 to 140	100, 116, 140	OFDM	BPSK	MCS0
802.11n (40MHz)		102 to 134	102, 110, 134	OFDM	BPSK	MCS0

TEST CONDITION:

APPLICABLE TO	ENVIRONMENTAL CONDITIONS	INPUT POWER	TESTED BY
RE \geq 1G	25deg. C, 65%RH	120Vac, 60Hz	Johnson Liao
RE $<$ 1G	25deg. C, 65%RH	120Vac, 60Hz	Johnson Liao
PLC	25deg. C, 65%RH	120Vac, 60Hz	David Huang
APCM	25deg. C, 65%RH	120Vac, 60Hz	Phoenix Chen

3.3 DESCRIPTION OF SUPPORT UNITS

The EUT has been tested as an independent unit together with other necessary accessories or support units.

3.3.1 CONFIGURATION OF SYSTEM UNDER TEST

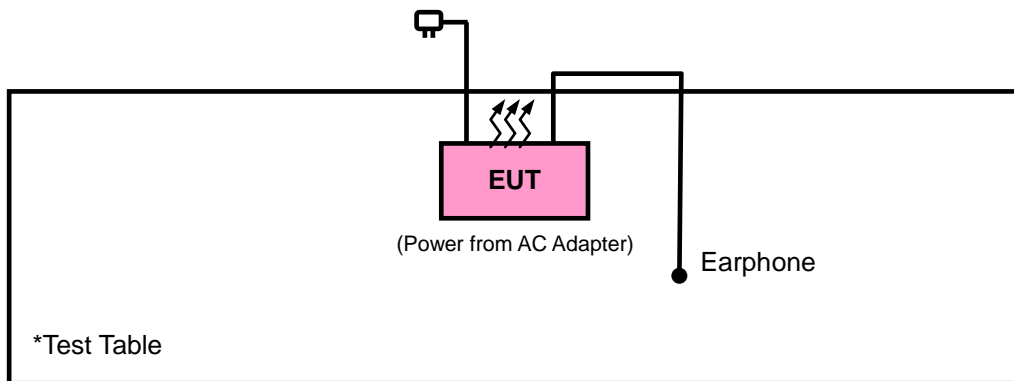

3.4 DUTY CYCLE OF TEST SIGNAL

If duty cycle is < 98%, duty factor shall be considered.

802.11a: Duty cycle = $2.059/2.163 = 0.952$, Duty factor = $10 * \log(1/0.952) = 0.21$

802.11n (20MHz): Duty cycle = $1.907/2.019 = 0.945$, Duty factor = $10 * \log(1/0.945) = 0.25$

802.11n (40MHz): Duty cycle = $913/1042 = 0.876$, Duty factor = $10 * \log(1/0.876) = 0.57$

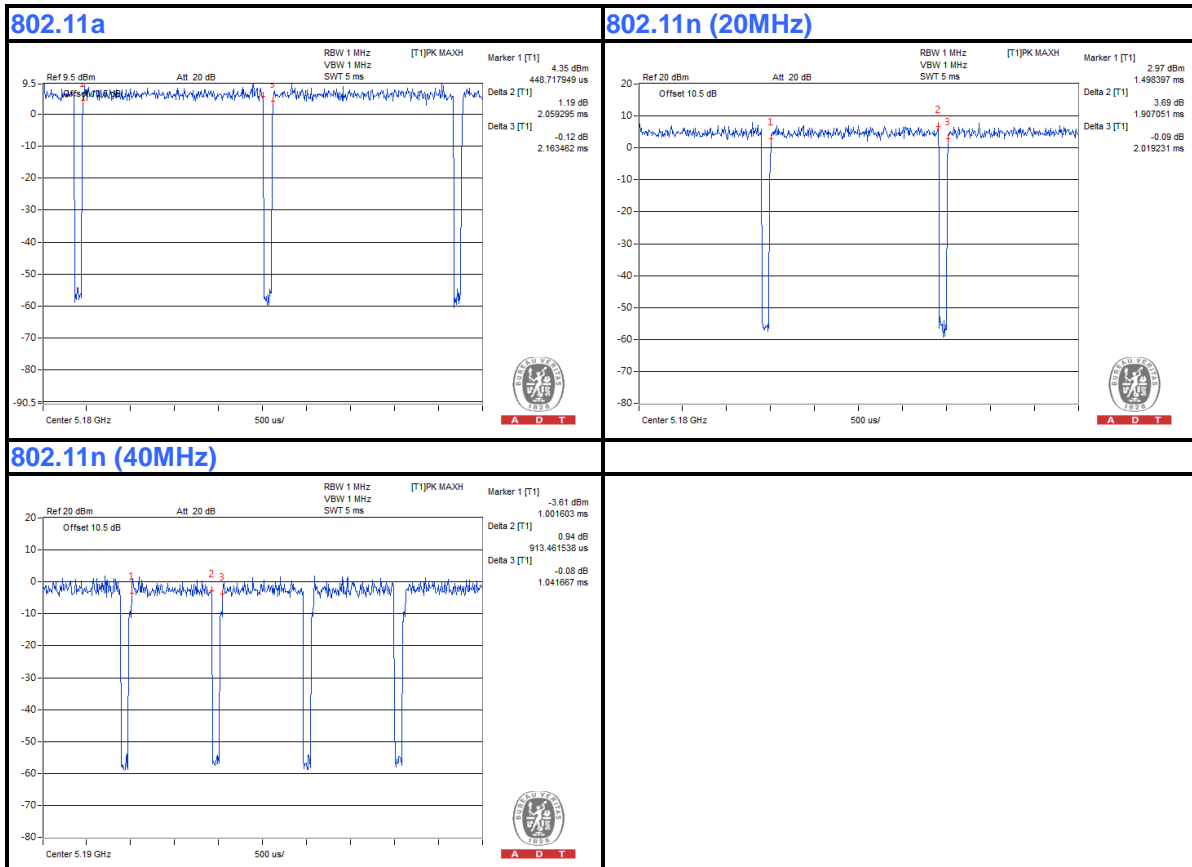

3.5 GENERAL DESCRIPTION OF APPLIED STANDARDS

The EUT is a RF Product. According to the specifications of the manufacturer, it must comply with the requirements of the following standards:

FCC Part 15, Subpart E (15.407)

ANSI C63.10-2009

KDB 789033 D01 General UNII Test Procedures v01r02

All test items have been performed and recorded as per the above standards.

NOTE: The EUT is also considered as a kind of computer peripheral, because the connection to computer is necessary for typical use. It has been verified to comply with the requirements of FCC Part 15, Subpart B, Class B (DoC). The test report has been issued separately.

4. TEST TYPES AND RESULTS

4.1 RADIATED EMISSION AND BANDEDGE MEASUREMENT

4.1.1 LIMITS OF RADIATED EMISSION AND BANDEDGE MEASUREMENT

Radiated emissions which fall in the restricted bands must comply with the radiated emission limits specified as below table:

FREQUENCIES (MHz)	FIELD STRENGTH (microvolts/meter)	MEASUREMENT DISTANCE (meters)
0.009 ~ 0.490	2400/F(kHz)	300
0.490 ~ 1.705	24000/F(kHz)	30
1.705 ~ 30.0	30	30
30 ~ 88	100	3
88 ~ 216	150	3
216 ~ 960	200	3
Above 960	500	3

NOTE:

1. The lower limit shall apply at the transition frequencies.
2. Emission level (dBuV/m) = 20 log Emission level (uV/m).
3. For frequencies above 1000MHz, the field strength limits are based on average detector, however, the peak field strength of any emission shall not exceed the maximum permitted average limits, specified above by more than 20dB under any condition of modulation.

4.1.2 LIMITS OF UNWANTED EMISSION OUT OF THE RESTRICTED BANDS

APPLICABLE TO	LIMIT	
	FIELD STRENGTH AT 3m (dBµV/m)	
	PK	AV
	74	54
√	EIRP LIMIT (dBm)	EQUIVALENT FIELD STRENGTH AT 3m (dBµV/m)
	PK	PK
	-27	68.3

NOTE: The following formula is used to convert the equipment isotropic radiated power (eirp) to field strength:

$$E = \frac{1000000\sqrt{30P}}{3} \mu\text{V/m, where P is the eirp (Watts).}$$



4.1.3 TEST INSTRUMENTS

DESCRIPTION & MANUFACTURER	MODEL NO.	SERIAL NO.	DATE OF CALIBRATION	DUE DATE OF CALIBRATION
Test Receiver ROHDE & SCHWARZ	ESCI	100744	Apr. 15, 2013	Apr. 14, 2014
Spectrum Analyzer ROHDE & SCHWARZ	FSU43	101261	Dec. 17, 2012	Dec. 16, 2013
BILOG Antenna SCHWARZBECK	VULB9168	9168-472	Mar. 25, 2013	Mar. 24, 2014
HORN Antenna SCHWARZBECK	BBHA 9120 D	9120D-969	Jan. 07, 2013	Jan. 06, 2014
HORN Antenna SCHWARZBECK	BBHA 9170	9170-480	Dec. 25, 2012	Dec. 24, 2013
Loop Antenna	HFH2-Z2	100070	Jan. 31, 2012	Jan. 30, 2014
Preamplifier EMCI	EMC 012645	980115	Dec. 28, 2012	Dec. 27, 2013
Preamplifier EMCI	EMC 184045	980116	Dec. 28, 2012	Dec. 27, 2013
Preamplifier EMCI	EMC 330H	980112	Dec. 28, 2012	Dec. 27, 2013
RF signal cable HUBER+SUHNNER	SUCOFLEX 104	309219/4	Oct. 19, 2012	Oct. 18, 2013
RF signal cable HUBER+SUHNNER	SUCOFLEX 104	250130/4	Oct. 19, 2012	Oct. 18, 2013
RF signal cable Worken	RG-213	NA	Dec. 29, 2012	Dec. 28, 2013
Software BV ADT	E3 6.120103	NA	NA	NA
Antenna Tower MF	MFA-440H	NA	NA	NA
Turn Table MF	MFT-201SS	NA	NA	NA
Antenna Tower & Turn Table Controller MF	MF-7802	NA	NA	NA
Power Meter	ML2495A	1232002	Aug. 10, 2012	Aug. 09, 2013
Power Sensor	MA2411B	1207325	Aug. 15, 2012	Aug. 14, 2013

- NOTE:**
1. The calibration interval of the above test instruments is 12 months and the calibrations are traceable to NML/ROC and NIST/USA.
 2. The calibration interval of the loop antenna is 24 months and the calibrations are traceable to NML/ROC and NIST/USA.
 3. The test was performed in HwaYa Chamber 10.
 4. The horn antenna and HP preamplifier (model: 8449B) are used only for the measurement of emission frequency above 1GHz if tested.
 5. The FCC Site Registration No. is 690701.
 6. The IC Site Registration No. is IC 7450F-10.

4.1.4 TEST PROCEDURES

- a. The EUT was placed on the top of a rotating table 0.8 meters above the ground at a 3 meter semi-anechoic chamber. The table was rotated 360 degrees to determine the position of the highest radiation.
- b. The EUT was set 3 meters away from the interference-receiving antenna, which was mounted on the top of a variable-height antenna tower.
- c. The antenna is a broadband antenna, and its height is varied from one meter to four meters above the ground to determine the maximum value of the field strength. Both horizontal and vertical polarizations of the antenna are set to make the measurement.
- d. For each suspected emission, the EUT was arranged to its worst case and then the antenna was tuned to heights from 1 meter to 4 meters and the rotatable table was turned from 0 degrees to 360 degrees to find the maximum reading.
- e. The test-receiver system was set to Peak Detect Function and Specified Bandwidth with Maximum Hold Mode.
- f. If the emission level of the EUT in peak mode was 10dB lower than the limit specified, then testing could be stopped and the peak values of the EUT would be reported. Otherwise the emissions that did not have 10dB margin would be re-tested one by one using peak, quasi-peak or average method as specified and then reported in a data sheet.

NOTE:

1. The resolution bandwidth and video bandwidth of test receiver/spectrum analyzer is 120kHz for Peak detection (PK) and Quasi-peak detection (QP) at frequency below 1GHz.
2. The resolution bandwidth of test receiver/spectrum analyzer is 1MHz and video bandwidth is 3MHz for Peak detection at frequency above 1GHz.
3. The resolution bandwidth of test receiver/spectrum analyzer is 1MHz and the video bandwidth is 1kHz for Average detection (AV) at frequency above 1GHz.
4. All modes of operation were investigated and the worst-case emissions are reported.

4.1.5 DEVIATION FROM TEST STANDARD

No deviation.

4.1.6 TEST SETUP

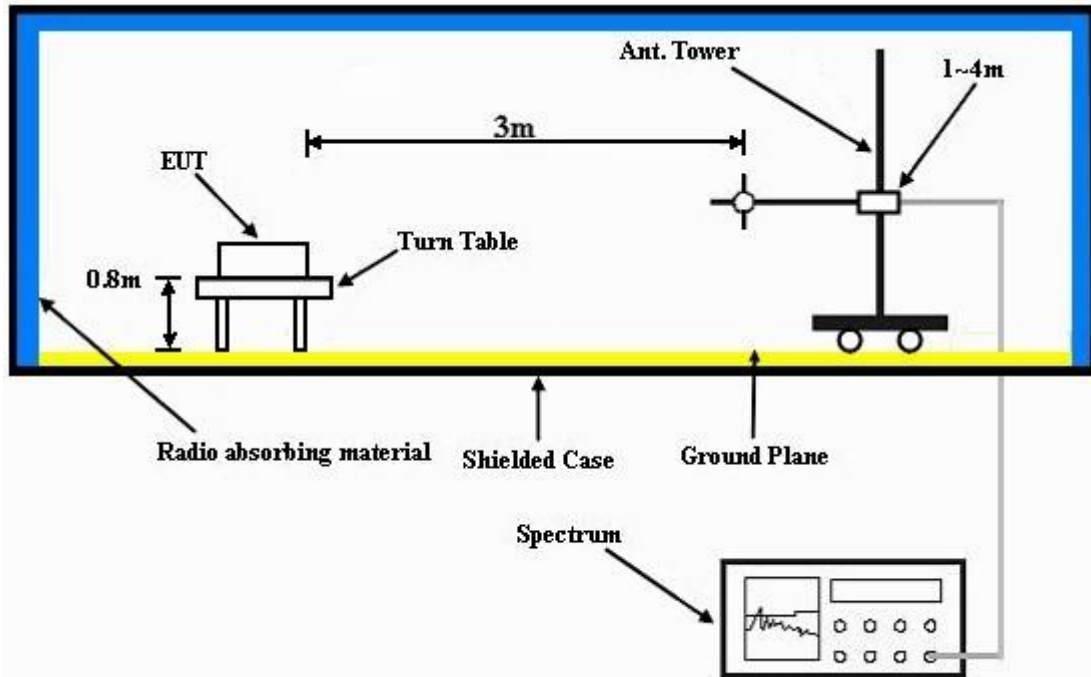

For the actual test configuration, please refer to the attached file (Test Setup Photo).

4.1.7 EUT OPERATING CONDITION

- a. Placed the EUT on a testing table.
- b. Use the software to control the EUT under transmission condition continuously at specific channel frequency.



A D T

4.1.8 TEST RESULTS

ABOVE 1GHz DATA: 802.11a

EUT TEST CONDITION		MEASUREMENT DETAIL	
CHANNEL	Channel 36	FREQUENCY RANGE	1GHz ~ 40GHz
INPUT POWER (SYSTEM)	120Vac, 60 Hz	DETECTOR FUNCTION	Peak (PK) Average (AV)
ENVIRONMENTAL CONDITIONS	25deg. C, 65%RH	TESTED BY	Kay Wu

ANTENNA POLARITY & TEST DISTANCE: HORIZONTAL AT 3 M										
FREQ. (MHz)	EMISSION LEVEL (dBuV/m)	READ LEVEL (dBuV)	LIMIT (dBuV/m)	MARGIN (dB)	ANTENNA FACTOR (dB/m)	CABLE LOSS (dB)	PREAMP FACTOR (dB)	ANTENNA HEIGHT (cm)	TABLE ANGLE (Degree)	REMARK
5144	41.15	39.82	54	-12.85	31.32	7.33	37.32	108	348	Average
5144	52.42	51.09	74	-21.58	31.32	7.33	37.32	108	348	Peak
5180	89.9	88.57			31.35	7.32	37.34	108	348	Average
5180	99.1	97.77			31.35	7.32	37.34	108	348	Peak
5420	39.73	37.98	54	-14.27	31.53	7.4	37.18	108	348	Average
5420	51.81	50.06	74	-22.19	31.53	7.4	37.18	108	348	Peak
ANTENNA POLARITY & TEST DISTANCE: VERTICAL AT 3 M										
FREQ. (MHz)	EMISSION LEVEL (dBuV/m)	READ LEVEL (dBuV)	LIMIT (dBuV/m)	MARGIN (dB)	ANTENNA FACTOR (dB/m)	CABLE LOSS (dB)	PREAMP FACTOR (dB)	ANTENNA HEIGHT (cm)	TABLE ANGLE (Degree)	REMARK
5104	39.75	38.4	54	-14.25	31.28	7.35	37.28	100	44	Average
5104	51.91	50.56	74	-22.09	31.28	7.35	37.28	100	44	Peak
5180	80.52	79.19			31.35	7.32	37.34	100	44	Average
5180	89.78	88.45			31.35	7.32	37.34	100	44	Peak
5434	39.83	37.94	54	-14.17	31.55	7.47	37.13	100	44	Average
5434	51.65	49.76	74	-22.35	31.55	7.47	37.13	100	44	Peak

REMARKS:

1. Emission Level = Read Level + Antenna Factor + Cable Loss - Preamp Factor
2. 5180MHz: Fundamental frequency.



A D T

EUT TEST CONDITION		MEASUREMENT DETAIL	
CHANNEL	Channel 44	FREQUENCY RANGE	1GHz ~ 40GHz
INPUT POWER (SYSTEM)	120Vac, 60 Hz	DETECTOR FUNCTION	Peak (PK) Average (AV)
ENVIRONMENTAL CONDITIONS	25deg. C, 65%RH	TESTED BY	Kay Wu

ANTENNA POLARITY & TEST DISTANCE: HORIZONTAL AT 3 M										
FREQ. (MHz)	EMISSION LEVEL (dBuV/m)	READ LEVEL (dBuV)	LIMIT (dBuV/m)	MARGIN (dB)	ANTENNA FACTOR (dB/m)	CABLE LOSS (dB)	PREAMP FACTOR (dB)	ANTENNA HEIGHT (cm)	TABLE ANGLE (Degree)	REMARK
5116	39.54	38.18	54	-14.46	31.29	7.35	37.28	108	12	Average
5116	51.88	50.52	74	-22.12	31.29	7.35	37.28	108	12	Peak
5220	88.69	87.36			31.37	7.32	37.36	108	12	Average
5220	98.14	96.81			31.37	7.32	37.36	108	12	Peak
5436	39.75	37.86	54	-14.25	31.55	7.47	37.13	108	12	Average
5436	51.81	49.92	74	-22.19	31.55	7.47	37.13	108	12	Peak
ANTENNA POLARITY & TEST DISTANCE: VERTICAL AT 3 M										
FREQ. (MHz)	EMISSION LEVEL (dBuV/m)	READ LEVEL (dBuV)	LIMIT (dBuV/m)	MARGIN (dB)	ANTENNA FACTOR (dB/m)	CABLE LOSS (dB)	PREAMP FACTOR (dB)	ANTENNA HEIGHT (cm)	TABLE ANGLE (Degree)	REMARK
5086	39.42	38.12	54	-14.58	31.27	7.3	37.27	100	271	Average
5086	51.64	50.34	74	-22.36	31.27	7.3	37.27	100	271	Peak
5220	80.72	79.39			31.37	7.32	37.36	100	271	Average
5220	91.29	89.96			31.37	7.32	37.36	100	271	Peak
5432	39.91	38.02	54	-14.09	31.55	7.47	37.13	100	271	Average
5432	51.47	49.58	74	-22.53	31.55	7.47	37.13	100	271	Peak

REMARKS:

1. Emission Level = Read Level + Antenna Factor + Cable Loss - Preamp Factor
2. 5220MHz: Fundamental frequency.



A D T

EUT TEST CONDITION		MEASUREMENT DETAIL	
CHANNEL	Channel 48	FREQUENCY RANGE	1GHz ~ 40GHz
INPUT POWER (SYSTEM)	120Vac, 60 Hz	DETECTOR FUNCTION	Peak (PK) Average (AV)
ENVIRONMENTAL CONDITIONS	25deg. C, 65%RH	TESTED BY	Kay Wu

ANTENNA POLARITY & TEST DISTANCE: HORIZONTAL AT 3 M										
FREQ. (MHz)	EMISSION LEVEL (dBuV/m)	READ LEVEL (dBuV)	LIMIT (dBuV/m)	MARGIN (dB)	ANTENNA FACTOR (dB/m)	CABLE LOSS (dB)	PREAMP FACTOR (dB)	ANTENNA HEIGHT (cm)	TABLE ANGLE (Degree)	REMARK
5042	39.35	38.11	54	-14.65	31.24	7.25	37.25	105	13	Average
5042	52.24	51	74	-21.76	31.24	7.25	37.25	105	13	Peak
5240	89.63	88.22			31.39	7.34	37.32	105	13	Average
5240	98.86	97.45			31.39	7.34	37.32	105	13	Peak
5350	39.63	37.93	54	-14.37	31.48	7.4	37.18	105	13	Average
5350	52.4	50.7	74	-21.6	31.48	7.4	37.18	105	13	Peak
ANTENNA POLARITY & TEST DISTANCE: VERTICAL AT 3 M										
FREQ. (MHz)	EMISSION LEVEL (dBuV/m)	READ LEVEL (dBuV)	LIMIT (dBuV/m)	MARGIN (dB)	ANTENNA FACTOR (dB/m)	CABLE LOSS (dB)	PREAMP FACTOR (dB)	ANTENNA HEIGHT (cm)	TABLE ANGLE (Degree)	REMARK
5056	39.22	37.97	54	-14.78	31.25	7.25	37.25	100	46	Average
5056	52	50.75	74	-22	31.25	7.25	37.25	100	46	Peak
5240	79.3	77.89			31.39	7.34	37.32	100	46	Average
5240	88.52	87.11			31.39	7.34	37.32	100	46	Peak
5394	39.58	37.85	54	-14.42	31.51	7.4	37.18	100	46	Average
5394	52.05	50.32	74	-21.95	31.51	7.4	37.18	100	46	Peak

REMARKS:

1. Emission Level = Read Level + Antenna Factor + Cable Loss - Preamp Factor
2. 5240MHz: Fundamental frequency.



A D T

EUT TEST CONDITION		MEASUREMENT DETAIL	
CHANNEL	Channel 52	FREQUENCY RANGE	1GHz ~ 40GHz
INPUT POWER (SYSTEM)	120Vac, 60 Hz	DETECTOR FUNCTION	Peak (PK) Average (AV)
ENVIRONMENTAL CONDITIONS	25deg. C, 65%RH	TESTED BY	Kay Wu

ANTENNA POLARITY & TEST DISTANCE: HORIZONTAL AT 3 M										
FREQ. (MHz)	EMISSION LEVEL (dBuV/m)	READ LEVEL (dBuV)	LIMIT (dBuV/m)	MARGIN (dB)	ANTENNA FACTOR (dB/m)	CABLE LOSS (dB)	PREAMP FACTOR (dB)	ANTENNA HEIGHT (cm)	TABLE ANGLE (Degree)	REMARK
5030	39.31	38.13	54	-14.69	31.23	7.19	37.24	112	64	Average
5030	51.72	50.54	74	-22.28	31.23	7.19	37.24	112	64	Peak
5260	82.41	80.91			31.41	7.36	37.27	112	64	Average
5260	91.9	90.4			31.41	7.36	37.27	112	64	Peak
5446	39.78	37.88	54	-14.22	31.56	7.47	37.13	112	64	Average
5446	51.77	49.87	74	-22.23	31.56	7.47	37.13	112	64	Peak
ANTENNA POLARITY & TEST DISTANCE: VERTICAL AT 3 M										
FREQ. (MHz)	EMISSION LEVEL (dBuV/m)	READ LEVEL (dBuV)	LIMIT (dBuV/m)	MARGIN (dB)	ANTENNA FACTOR (dB/m)	CABLE LOSS (dB)	PREAMP FACTOR (dB)	ANTENNA HEIGHT (cm)	TABLE ANGLE (Degree)	REMARK
5106	39.48	38.12	54	-14.52	31.29	7.35	37.28	100	10	Average
5106	51.76	50.4	74	-22.24	31.29	7.35	37.28	100	10	Peak
5260	88.42	86.92			31.41	7.36	37.27	100	10	Average
5260	98.1	96.6			31.41	7.36	37.27	100	10	Peak
5352	39.7	38	54	-14.3	31.48	7.4	37.18	100	10	Average
5352	52.18	50.48	74	-21.82	31.48	7.4	37.18	100	10	Peak

REMARKS:

1. Emission Level = Read Level + Antenna Factor + Cable Loss - Preamp Factor
2. 5260MHz: Fundamental frequency.



A D T

EUT TEST CONDITION		MEASUREMENT DETAIL	
CHANNEL	Channel 60	FREQUENCY RANGE	1GHz ~ 40GHz
INPUT POWER (SYSTEM)	120Vac, 60 Hz	DETECTOR FUNCTION	Peak (PK) Average (AV)
ENVIRONMENTAL CONDITIONS	25deg. C, 65%RH	TESTED BY	Kay Wu

ANTENNA POLARITY & TEST DISTANCE: HORIZONTAL AT 3 M										
FREQ. (MHz)	EMISSION LEVEL (dBuV/m)	READ LEVEL (dBuV)	LIMIT (dBuV/m)	MARGIN (dB)	ANTENNA FACTOR (dB/m)	CABLE LOSS (dB)	PREAMP FACTOR (dB)	ANTENNA HEIGHT (cm)	TABLE ANGLE (Degree)	REMARK
5046	39.2	37.96	54	-14.8	31.24	7.25	37.25	100	74	Average
5046	51.74	50.5	74	-22.26	31.24	7.25	37.25	100	74	Peak
5300	82.89	81.24			31.44	7.4	37.19	100	74	Average
5300	91.97	90.32			31.44	7.4	37.19	100	74	Peak
5396	39.65	37.91	54	-14.35	31.52	7.4	37.18	100	74	Average
5396	51.93	50.19	74	-22.07	31.52	7.4	37.18	100	74	Peak
ANTENNA POLARITY & TEST DISTANCE: VERTICAL AT 3 M										
FREQ. (MHz)	EMISSION LEVEL (dBuV/m)	READ LEVEL (dBuV)	LIMIT (dBuV/m)	MARGIN (dB)	ANTENNA FACTOR (dB/m)	CABLE LOSS (dB)	PREAMP FACTOR (dB)	ANTENNA HEIGHT (cm)	TABLE ANGLE (Degree)	REMARK
5040	39.15	37.96	54	-14.85	31.24	7.19	37.24	100	360	Average
5040	52.51	51.32	74	-21.49	31.24	7.19	37.24	100	360	Peak
5300	88.2	86.55			31.44	7.4	37.19	100	360	Average
5300	97.68	96.03			31.44	7.4	37.19	100	360	Peak
5352	39.94	38.24	54	-14.06	31.48	7.4	37.18	100	360	Average
5352	51.98	50.28	74	-22.02	31.48	7.4	37.18	100	360	Peak

REMARKS:

1. Emission Level = Read Level + Antenna Factor + Cable Loss - Preamp Factor
2. 5300MHz: Fundamental frequency.



A D T

EUT TEST CONDITION		MEASUREMENT DETAIL	
CHANNEL	Channel 64	FREQUENCY RANGE	1GHz ~ 40GHz
INPUT POWER (SYSTEM)	120Vac, 60 Hz	DETECTOR FUNCTION	Peak (PK) Average (AV)
ENVIRONMENTAL CONDITIONS	25deg. C, 65%RH	TESTED BY	Kay Wu

ANTENNA POLARITY & TEST DISTANCE: HORIZONTAL AT 3 M										
FREQ. (MHz)	EMISSION LEVEL (dBuV/m)	READ LEVEL (dBuV)	LIMIT (dBuV/m)	MARGIN (dB)	ANTENNA FACTOR (dB/m)	CABLE LOSS (dB)	PREAMP FACTOR (dB)	ANTENNA HEIGHT (cm)	TABLE ANGLE (Degree)	REMARK
5076	39.19	37.89	54	-14.81	31.27	7.3	37.27	100	66	Average
5076	52.1	50.8	74	-21.9	31.27	7.3	37.27	100	66	Peak
5320	82.68	81.02			31.45	7.4	37.19	100	66	Average
5320	91.61	89.95			31.45	7.4	37.19	100	66	Peak
5450	39.84	37.83	54	-14.16	31.56	7.53	37.08	100	66	Average
5450	52.03	50.02	74	-21.97	31.56	7.53	37.08	100	66	Peak
ANTENNA POLARITY & TEST DISTANCE: VERTICAL AT 3 M										
FREQ. (MHz)	EMISSION LEVEL (dBuV/m)	READ LEVEL (dBuV)	LIMIT (dBuV/m)	MARGIN (dB)	ANTENNA FACTOR (dB/m)	CABLE LOSS (dB)	PREAMP FACTOR (dB)	ANTENNA HEIGHT (cm)	TABLE ANGLE (Degree)	REMARK
5028	39.19	38.01	54	-14.81	31.23	7.19	37.24	100	349	Average
5028	51.52	50.34	74	-22.48	31.23	7.19	37.24	100	349	Peak
5320	87.29	85.63			31.45	7.4	37.19	100	349	Average
5320	96.22	94.56			31.45	7.4	37.19	100	349	Peak
5392	40.2	38.47	54	-13.8	31.51	7.4	37.18	100	349	Average
5392	52.01	50.28	74	-21.99	31.51	7.4	37.18	100	349	Peak

REMARKS:

1. Emission Level = Read Level + Antenna Factor + Cable Loss - Preamp Factor
2. 5320MHz: Fundamental frequency.



A D T

EUT TEST CONDITION		MEASUREMENT DETAIL	
CHANNEL	Channel 100	FREQUENCY RANGE	1GHz ~ 40GHz
INPUT POWER (SYSTEM)	120Vac, 60 Hz	DETECTOR FUNCTION	Peak (PK) Average (AV)
ENVIRONMENTAL CONDITIONS	25deg. C, 65%RH	TESTED BY	Kay Wu

ANTENNA POLARITY & TEST DISTANCE: HORIZONTAL AT 3 M										
FREQ. (MHz)	EMISSION LEVEL (dBuV/m)	READ LEVEL (dBuV)	LIMIT (dBuV/m)	MARGIN (dB)	ANTENNA FACTOR (dB/m)	CABLE LOSS (dB)	PREAMP FACTOR (dB)	ANTENNA HEIGHT (cm)	TABLE ANGLE (Degree)	REMARK
5382	40.31	38.58	54	-13.69	31.51	7.4	37.18	100	346	Average
5382	52.62	50.89	74	-21.38	31.51	7.4	37.18	100	346	Peak
5470	53.73	51.71	68.3	-14.57	31.57	7.53	37.08	100	346	Peak
5500	85.12	82.96			31.6	7.59	37.03	100	346	Average
5500	94.52	92.36			31.6	7.59	37.03	100	346	Peak
5725	51.25	49.01	68.3	-17.05	31.96	7.71	37.43	100	346	Peak
ANTENNA POLARITY & TEST DISTANCE: VERTICAL AT 3 M										
FREQ. (MHz)	EMISSION LEVEL (dBuV/m)	READ LEVEL (dBuV)	LIMIT (dBuV/m)	MARGIN (dB)	ANTENNA FACTOR (dB/m)	CABLE LOSS (dB)	PREAMP FACTOR (dB)	ANTENNA HEIGHT (cm)	TABLE ANGLE (Degree)	REMARK
5442	39.56	37.67	54	-14.44	31.55	7.47	37.13	100	273	Average
5442	51.99	50.1	74	-22.01	31.55	7.47	37.13	100	273	Peak
5470	50.21	48.19	68.3	-18.09	31.57	7.53	37.08	100	273	Peak
5500	77.39	75.23			31.6	7.59	37.03	100	273	Average
5500	86.93	84.77			31.6	7.59	37.03	100	273	Peak
5725	51.31	49.07	68.3	-16.99	31.96	7.71	37.43	100	273	Peak

REMARKS:

1. Emission Level = Read Level + Antenna Factor + Cable Loss - Preamp Factor
2. 5500MHz: Fundamental frequency.
3. 5470MHz & 5725MHz: Out of restricted band



A D T

EUT TEST CONDITION		MEASUREMENT DETAIL	
CHANNEL	Channel 116	FREQUENCY RANGE	1GHz ~ 40GHz
INPUT POWER (SYSTEM)	120Vac, 60 Hz	DETECTOR FUNCTION	Peak (PK) Average (AV)
ENVIRONMENTAL CONDITIONS	25deg. C, 65%RH	TESTED BY	Kay Wu

ANTENNA POLARITY & TEST DISTANCE: HORIZONTAL AT 3 M										
FREQ. (MHz)	EMISSION LEVEL (dBuV/m)	READ LEVEL (dBuV)	LIMIT (dBuV/m)	MARGIN (dB)	ANTENNA FACTOR (dB/m)	CABLE LOSS (dB)	PREAMP FACTOR (dB)	ANTENNA HEIGHT (cm)	TABLE ANGLE (Degree)	REMARK
5434	39.83	37.94	54	-14.17	31.55	7.47	37.13	100	2	Average
5434	51.87	49.98	74	-22.13	31.55	7.47	37.13	100	2	Peak
5470	50.35	48.33	68.3	-17.95	31.57	7.53	37.08	100	2	Peak
5580	83.9	81.78			31.71	7.57	37.16	100	2	Average
5580	93.67	91.55			31.71	7.57	37.16	100	2	Peak
5725	51.96	49.72	68.3	-16.34	31.96	7.71	37.43	100	2	Peak
ANTENNA POLARITY & TEST DISTANCE: VERTICAL AT 3 M										
FREQ. (MHz)	EMISSION LEVEL (dBuV/m)	READ LEVEL (dBuV)	LIMIT (dBuV/m)	MARGIN (dB)	ANTENNA FACTOR (dB/m)	CABLE LOSS (dB)	PREAMP FACTOR (dB)	ANTENNA HEIGHT (cm)	TABLE ANGLE (Degree)	REMARK
5458	39.65	37.64	54	-14.35	31.56	7.53	37.08	100	281	Average
5458	51.92	49.91	74	-22.08	31.56	7.53	37.08	100	281	Peak
5470	50.53	48.51	68.3	-17.77	31.57	7.53	37.08	100	281	Peak
5580	76.08	73.96			31.71	7.57	37.16	100	281	Average
5580	86	83.88			31.71	7.57	37.16	100	281	Peak
5725	50.84	48.6	68.3	-17.46	31.96	7.71	37.43	100	281	Peak

REMARKS:

1. Emission Level = Read Level + Antenna Factor + Cable Loss - Preamp Factor
2. 5580MHz: Fundamental frequency.
3. 5470MHz & 5725MHz: Out of restricted band



A D T

EUT TEST CONDITION		MEASUREMENT DETAIL	
CHANNEL	Channel 140	FREQUENCY RANGE	1GHz ~ 40GHz
INPUT POWER (SYSTEM)	120Vac, 60 Hz	DETECTOR FUNCTION	Peak (PK) Average (AV)
ENVIRONMENTAL CONDITIONS	25deg. C, 65%RH	TESTED BY	Kay Wu

ANTENNA POLARITY & TEST DISTANCE: HORIZONTAL AT 3 M										
FREQ. (MHz)	EMISSION LEVEL (dBuV/m)	READ LEVEL (dBuV)	LIMIT (dBuV/m)	MARGIN (dB)	ANTENNA FACTOR (dB/m)	CABLE LOSS (dB)	PREAMP FACTOR (dB)	ANTENNA HEIGHT (cm)	TABLE ANGLE (Degree)	REMARK
5430	39.52	37.63	54	-14.48	31.55	7.47	37.13	100	314	Average
5430	52.1	50.21	74	-21.9	31.55	7.47	37.13	100	314	Peak
5470	51.01	48.99	68.3	-17.29	31.57	7.53	37.08	100	314	Peak
5700	84.89	82.7			31.9	7.69	37.4	100	314	Average
5700	94.46	92.27			31.9	7.69	37.4	100	314	Peak
5725	50.68	48.44	68.3	-17.62	31.96	7.71	37.43	100	314	Peak
ANTENNA POLARITY & TEST DISTANCE: VERTICAL AT 3 M										
FREQ. (MHz)	EMISSION LEVEL (dBuV/m)	READ LEVEL (dBuV)	LIMIT (dBuV/m)	MARGIN (dB)	ANTENNA FACTOR (dB/m)	CABLE LOSS (dB)	PREAMP FACTOR (dB)	ANTENNA HEIGHT (cm)	TABLE ANGLE (Degree)	REMARK
5442	39.62	37.73	54	-14.38	31.55	7.47	37.13	100	303	Average
5442	51.36	49.47	74	-22.64	31.55	7.47	37.13	100	303	Peak
5470	50.59	48.57	68.3	-17.71	31.57	7.53	37.08	100	303	Peak
5700	76.72	74.53			31.9	7.69	37.4	100	303	Average
5700	85.93	83.74			31.9	7.69	37.4	100	303	Peak
5725	49.81	47.57	68.3	-18.49	31.96	7.71	37.43	100	303	Peak

REMARKS:

1. Emission Level = Read Level + Antenna Factor + Cable Loss - Preamp Factor
2. 5700MHz: Fundamental frequency.
3. 5470MHz & 5725MHz: Out of restricted band



A D T

802.11n (20MHz)

EUT TEST CONDITION		MEASUREMENT DETAIL	
CHANNEL	Channel 36	FREQUENCY RANGE	1GHz ~ 40GHz
INPUT POWER (SYSTEM)	120Vac, 60 Hz	DETECTOR FUNCTION	Peak (PK) Average (AV)
ENVIRONMENTAL CONDITIONS	25deg. C, 65%RH	TESTED BY	Kay Wu

ANTENNA POLARITY & TEST DISTANCE: HORIZONTAL AT 3 M										
FREQ. (MHz)	EMISSION LEVEL (dBuV/m)	READ LEVEL (dBuV)	LIMIT (dBuV/m)	MARGIN (dB)	ANTENNA FACTOR (dB/m)	CABLE LOSS (dB)	PREAMP FACTOR (dB)	ANTENNA HEIGHT (cm)	TABLE ANGLE (Degree)	REMARK
5138	40.01	38.66	54	-13.99	31.31	7.34	37.3	106	350	Average
5138	51.84	50.49	74	-22.16	31.31	7.34	37.3	106	350	Peak
5180	86.79	85.46			31.35	7.32	37.34	106	350	Average
5180	96.16	94.83			31.35	7.32	37.34	106	350	Peak
5440	39.76	37.87	54	-14.24	31.55	7.47	37.13	106	350	Average
5440	52.17	50.28	74	-21.83	31.55	7.47	37.13	106	350	Peak
ANTENNA POLARITY & TEST DISTANCE: VERTICAL AT 3 M										
FREQ. (MHz)	EMISSION LEVEL (dBuV/m)	READ LEVEL (dBuV)	LIMIT (dBuV/m)	MARGIN (dB)	ANTENNA FACTOR (dB/m)	CABLE LOSS (dB)	PREAMP FACTOR (dB)	ANTENNA HEIGHT (cm)	TABLE ANGLE (Degree)	REMARK
5134	39.43	38.08	54	-14.57	31.31	7.34	37.3	100	33	Average
5134	51.84	50.49	74	-22.16	31.31	7.34	37.3	100	33	Peak
5180	79.84	78.51			31.35	7.32	37.34	100	33	Average
5180	89.23	87.9			31.35	7.32	37.34	100	33	Peak
5434	39.55	37.66	54	-14.45	31.55	7.47	37.13	100	33	Average
5434	50.99	49.1	74	-23.01	31.55	7.47	37.13	100	33	Peak

REMARKS:

1. Emission Level = Read Level + Antenna Factor + Cable Loss - Preamp Factor
2. 5180MHz: Fundamental frequency.



A D T

EUT TEST CONDITION		MEASUREMENT DETAIL	
CHANNEL	Channel 44	FREQUENCY RANGE	1GHz ~ 40GHz
INPUT POWER (SYSTEM)	120Vac, 60 Hz	DETECTOR FUNCTION	Peak (PK) Average (AV)
ENVIRONMENTAL CONDITIONS	25deg. C, 65%RH	TESTED BY	Kay Wu

ANTENNA POLARITY & TEST DISTANCE: HORIZONTAL AT 3 M										
FREQ. (MHz)	EMISSION LEVEL (dBuV/m)	READ LEVEL (dBuV)	LIMIT (dBuV/m)	MARGIN (dB)	ANTENNA FACTOR (dB/m)	CABLE LOSS (dB)	PREAMP FACTOR (dB)	ANTENNA HEIGHT (cm)	TABLE ANGLE (Degree)	REMARK
5116	39.5	38.14	54	-14.5	31.29	7.35	37.28	106	352	Average
5116	51.32	49.96	74	-22.68	31.29	7.35	37.28	106	352	Peak
5220	88.62	87.29			31.37	7.32	37.36	106	352	Average
5220	97.66	96.33			31.37	7.32	37.36	106	352	Peak
5432	39.65	37.76	54	-14.35	31.55	7.47	37.13	106	352	Average
5432	51.54	49.65	74	-22.46	31.55	7.47	37.13	106	352	Peak
ANTENNA POLARITY & TEST DISTANCE: VERTICAL AT 3 M										
FREQ. (MHz)	EMISSION LEVEL (dBuV/m)	READ LEVEL (dBuV)	LIMIT (dBuV/m)	MARGIN (dB)	ANTENNA FACTOR (dB/m)	CABLE LOSS (dB)	PREAMP FACTOR (dB)	ANTENNA HEIGHT (cm)	TABLE ANGLE (Degree)	REMARK
5038	39.13	37.94	54	-14.87	31.24	7.19	37.24	100	32	Average
5038	51.49	50.3	74	-22.51	31.24	7.19	37.24	100	32	Peak
5220	78.42	77.09			31.37	7.32	37.36	100	32	Average
5220	87.98	86.65			31.37	7.32	37.36	100	32	Peak
5352	39.39	37.69	54	-14.61	31.48	7.4	37.18	100	32	Average
5352	51.44	49.74	74	-22.56	31.48	7.4	37.18	100	32	Peak

REMARKS:

1. Emission Level = Read Level + Antenna Factor + Cable Loss - Preamp Factor
2. 5220MHz: Fundamental frequency.



A D T

EUT TEST CONDITION		MEASUREMENT DETAIL	
CHANNEL	Channel 48	FREQUENCY RANGE	1GHz ~ 40GHz
INPUT POWER (SYSTEM)	120Vac, 60 Hz	DETECTOR FUNCTION	Peak (PK) Average (AV)
ENVIRONMENTAL CONDITIONS	25deg. C, 65%RH	TESTED BY	Kay Wu

ANTENNA POLARITY & TEST DISTANCE: HORIZONTAL AT 3 M										
FREQ. (MHz)	EMISSION LEVEL (dBuV/m)	READ LEVEL (dBuV)	LIMIT (dBuV/m)	MARGIN (dB)	ANTENNA FACTOR (dB/m)	CABLE LOSS (dB)	PREAMP FACTOR (dB)	ANTENNA HEIGHT (cm)	TABLE ANGLE (Degree)	REMARK
5058	39.22	37.97	54	-14.78	31.25	7.25	37.25	106	352	Average
5058	51.04	49.79	74	-22.96	31.25	7.25	37.25	106	352	Peak
5240	89.1	87.69			31.39	7.34	37.32	106	352	Average
5240	98.19	96.78			31.39	7.34	37.32	106	352	Peak
5418	39.64	37.89	54	-14.36	31.53	7.4	37.18	106	352	Average
5418	51.69	49.94	74	-22.31	31.53	7.4	37.18	106	352	Peak
ANTENNA POLARITY & TEST DISTANCE: VERTICAL AT 3 M										
FREQ. (MHz)	EMISSION LEVEL (dBuV/m)	READ LEVEL (dBuV)	LIMIT (dBuV/m)	MARGIN (dB)	ANTENNA FACTOR (dB/m)	CABLE LOSS (dB)	PREAMP FACTOR (dB)	ANTENNA HEIGHT (cm)	TABLE ANGLE (Degree)	REMARK
5084	39.24	37.94	54	-14.76	31.27	7.3	37.27	100	53	Average
5084	51.1	49.8	74	-22.9	31.27	7.3	37.27	100	53	Peak
5240	80.09	78.68			31.39	7.34	37.32	100	53	Average
5240	89.07	87.66			31.39	7.34	37.32	100	53	Peak
5426	39.48	37.61	54	-14.52	31.53	7.47	37.13	100	53	Average
5426	51.95	50.08	74	-22.05	31.53	7.47	37.13	100	53	Peak

REMARKS:

1. Emission Level = Read Level + Antenna Factor + Cable Loss - Preamp Factor
2. 5240MHz: Fundamental frequency.



A D T

EUT TEST CONDITION		MEASUREMENT DETAIL	
CHANNEL	Channel 52	FREQUENCY RANGE	1GHz ~ 40GHz
INPUT POWER (SYSTEM)	120Vac, 60 Hz	DETECTOR FUNCTION	Peak (PK) Average (AV)
ENVIRONMENTAL CONDITIONS	25deg. C, 65%RH	TESTED BY	Kay Wu

ANTENNA POLARITY & TEST DISTANCE: HORIZONTAL AT 3 M										
FREQ. (MHz)	EMISSION LEVEL (dBuV/m)	READ LEVEL (dBuV)	LIMIT (dBuV/m)	MARGIN (dB)	ANTENNA FACTOR (dB/m)	CABLE LOSS (dB)	PREAMP FACTOR (dB)	ANTENNA HEIGHT (cm)	TABLE ANGLE (Degree)	REMARK
5090	39.2	37.89	54	-14.8	31.28	7.3	37.27	100	58	Average
5090	51.09	49.78	74	-22.91	31.28	7.3	37.27	100	58	Peak
5260	79.71	78.21			31.41	7.36	37.27	100	58	Average
5260	89.17	87.67			31.41	7.36	37.27	100	58	Peak
5416	39.38	37.63	54	-14.62	31.53	7.4	37.18	100	58	Average
5416	51.39	49.64	74	-22.61	31.53	7.4	37.18	100	58	Peak
ANTENNA POLARITY & TEST DISTANCE: VERTICAL AT 3 M										
FREQ. (MHz)	EMISSION LEVEL (dBuV/m)	READ LEVEL (dBuV)	LIMIT (dBuV/m)	MARGIN (dB)	ANTENNA FACTOR (dB/m)	CABLE LOSS (dB)	PREAMP FACTOR (dB)	ANTENNA HEIGHT (cm)	TABLE ANGLE (Degree)	REMARK
5086	39.15	37.85	54	-14.85	31.27	7.3	37.27	100	350	Average
5086	52.45	51.15	74	-21.55	31.27	7.3	37.27	100	350	Peak
5260	87.01	85.51			31.41	7.36	37.27	100	350	Average
5260	96.49	94.99			31.41	7.36	37.27	100	350	Peak
5354	39.48	37.78	54	-14.52	31.48	7.4	37.18	100	350	Average
5354	51.37	49.67	74	-22.63	31.48	7.4	37.18	100	350	Peak

REMARKS:

1. Emission Level = Read Level + Antenna Factor + Cable Loss - Preamp Factor
2. 5260MHz: Fundamental frequency.



A D T

EUT TEST CONDITION		MEASUREMENT DETAIL	
CHANNEL	Channel 60	FREQUENCY RANGE	1GHz ~ 40GHz
INPUT POWER (SYSTEM)	120Vac, 60 Hz	DETECTOR FUNCTION	Peak (PK) Average (AV)
ENVIRONMENTAL CONDITIONS	25deg. C, 65%RH	TESTED BY	Kay Wu

ANTENNA POLARITY & TEST DISTANCE: HORIZONTAL AT 3 M										
FREQ. (MHz)	EMISSION LEVEL (dBuV/m)	READ LEVEL (dBuV)	LIMIT (dBuV/m)	MARGIN (dB)	ANTENNA FACTOR (dB/m)	CABLE LOSS (dB)	PREAMP FACTOR (dB)	ANTENNA HEIGHT (cm)	TABLE ANGLE (Degree)	REMARK
5150	39.2	37.87	54	-14.8	31.32	7.33	37.32	100	81	Average
5150	51.77	50.44	74	-22.23	31.32	7.33	37.32	100	81	Peak
5300	81.7	80.05			31.44	7.4	37.19	100	81	Average
5300	91.25	89.6			31.44	7.4	37.19	100	81	Peak
5446	39.56	37.66	54	-14.44	31.56	7.47	37.13	100	81	Average
5446	52.53	50.63	74	-21.47	31.56	7.47	37.13	100	81	Peak
ANTENNA POLARITY & TEST DISTANCE: VERTICAL AT 3 M										
FREQ. (MHz)	EMISSION LEVEL (dBuV/m)	READ LEVEL (dBuV)	LIMIT (dBuV/m)	MARGIN (dB)	ANTENNA FACTOR (dB/m)	CABLE LOSS (dB)	PREAMP FACTOR (dB)	ANTENNA HEIGHT (cm)	TABLE ANGLE (Degree)	REMARK
5012	38.99	37.87	54	-15.01	31.21	7.14	37.23	100	21	Average
5012	51.31	50.19	74	-22.69	31.21	7.14	37.23	100	21	Peak
5300	85.37	83.72			31.44	7.4	37.19	100	21	Average
5300	94.6	92.95			31.44	7.4	37.19	100	21	Peak
5396	39.57	37.83	54	-14.43	31.52	7.4	37.18	100	21	Average
5396	52.13	50.39	74	-21.87	31.52	7.4	37.18	100	21	Peak

REMARKS:

1. Emission Level = Read Level + Antenna Factor + Cable Loss - Preamp Factor
2. 5300MHz: Fundamental frequency.



A D T

EUT TEST CONDITION		MEASUREMENT DETAIL	
CHANNEL	Channel 64	FREQUENCY RANGE	1GHz ~ 40GHz
INPUT POWER (SYSTEM)	120Vac, 60 Hz	DETECTOR FUNCTION	Peak (PK) Average (AV)
ENVIRONMENTAL CONDITIONS	25deg. C, 65%RH	TESTED BY	Kay Wu

ANTENNA POLARITY & TEST DISTANCE: HORIZONTAL AT 3 M										
FREQ. (MHz)	EMISSION LEVEL (dBuV/m)	READ LEVEL (dBuV)	LIMIT (dBuV/m)	MARGIN (dB)	ANTENNA FACTOR (dB/m)	CABLE LOSS (dB)	PREAMP FACTOR (dB)	ANTENNA HEIGHT (cm)	TABLE ANGLE (Degree)	REMARK
5054	39.11	37.87	54	-14.89	31.24	7.25	37.25	100	77	Average
5054	50.83	49.59	74	-23.17	31.24	7.25	37.25	100	77	Peak
5320	81.5	79.84			31.45	7.4	37.19	100	77	Average
5320	90.59	88.93			31.45	7.4	37.19	100	77	Peak
5456	39.78	37.77	54	-14.22	31.56	7.53	37.08	100	77	Average
5456	51.37	49.36	74	-22.63	31.56	7.53	37.08	100	77	Peak
ANTENNA POLARITY & TEST DISTANCE: VERTICAL AT 3 M										
FREQ. (MHz)	EMISSION LEVEL (dBuV/m)	READ LEVEL (dBuV)	LIMIT (dBuV/m)	MARGIN (dB)	ANTENNA FACTOR (dB/m)	CABLE LOSS (dB)	PREAMP FACTOR (dB)	ANTENNA HEIGHT (cm)	TABLE ANGLE (Degree)	REMARK
5122	39.45	38.12	54	-14.55	31.29	7.34	37.3	100	10	Average
5122	51.78	50.45	74	-22.22	31.29	7.34	37.3	100	10	Peak
5320	86.35	84.69			31.45	7.4	37.19	100	10	Average
5320	95.58	93.92			31.45	7.4	37.19	100	10	Peak
5458	40.18	38.17	54	-13.82	31.56	7.53	37.08	100	10	Average
5458	52.2	50.19	74	-21.8	31.56	7.53	37.08	100	10	Peak

REMARKS:

1. Emission Level = Read Level + Antenna Factor + Cable Loss - Preamp Factor
2. 5320MHz: Fundamental frequency.



A D T

EUT TEST CONDITION		MEASUREMENT DETAIL	
CHANNEL	Channel 100	FREQUENCY RANGE	1GHz ~ 40GHz
INPUT POWER (SYSTEM)	120Vac, 60 Hz	DETECTOR FUNCTION	Peak (PK) Average (AV)
ENVIRONMENTAL CONDITIONS	25deg. C, 65%RH	TESTED BY	Kay Wu

ANTENNA POLARITY & TEST DISTANCE: HORIZONTAL AT 3 M										
FREQ. (MHz)	EMISSION LEVEL (dBuV/m)	READ LEVEL (dBuV)	LIMIT (dBuV/m)	MARGIN (dB)	ANTENNA FACTOR (dB/m)	CABLE LOSS (dB)	PREAMP FACTOR (dB)	ANTENNA HEIGHT (cm)	TABLE ANGLE (Degree)	REMARK
5454	40.5	38.49	54	-13.5	31.56	7.53	37.08	100	13	Average
5454	52.46	50.45	74	-21.54	31.56	7.53	37.08	100	13	Peak
5470	52.91	50.89	68.3	-15.39	31.57	7.53	37.08	100	13	Peak
5500	84.54	82.38			31.6	7.59	37.03	100	13	Average
5500	93.63	91.47			31.6	7.59	37.03	100	13	Peak
5725	51.3	49.06	68.3	-17	31.96	7.71	37.43	100	13	Peak
ANTENNA POLARITY & TEST DISTANCE: VERTICAL AT 3 M										
FREQ. (MHz)	EMISSION LEVEL (dBuV/m)	READ LEVEL (dBuV)	LIMIT (dBuV/m)	MARGIN (dB)	ANTENNA FACTOR (dB/m)	CABLE LOSS (dB)	PREAMP FACTOR (dB)	ANTENNA HEIGHT (cm)	TABLE ANGLE (Degree)	REMARK
5456	39.82	37.81	54	-14.18	31.56	7.53	37.08	100	259	Average
5456	52	49.99	74	-22	31.56	7.53	37.08	100	259	Peak
5470	51.55	49.53	68.3	-16.75	31.57	7.53	37.08	100	259	Peak
5500	77.17	75.01			31.6	7.59	37.03	100	259	Average
5500	86.73	84.57			31.6	7.59	37.03	100	259	Peak
5725	51.11	48.87	68.3	-17.19	31.96	7.71	37.43	100	259	Peak

REMARKS:

1. Emission Level = Read Level + Antenna Factor + Cable Loss - Preamp Factor
2. 5500MHz: Fundamental frequency.
3. 5470MHz & 5725MHz: Out of restricted band



A D T

EUT TEST CONDITION		MEASUREMENT DETAIL	
CHANNEL	Channel 116	FREQUENCY RANGE	1GHz ~ 40GHz
INPUT POWER (SYSTEM)	120Vac, 60 Hz	DETECTOR FUNCTION	Peak (PK) Average (AV)
ENVIRONMENTAL CONDITIONS	25deg. C, 65%RH	TESTED BY	Kay Wu

ANTENNA POLARITY & TEST DISTANCE: HORIZONTAL AT 3 M										
FREQ. (MHz)	EMISSION LEVEL (dBuV/m)	READ LEVEL (dBuV)	LIMIT (dBuV/m)	MARGIN (dB)	ANTENNA FACTOR (dB/m)	CABLE LOSS (dB)	PREAMP FACTOR (dB)	ANTENNA HEIGHT (cm)	TABLE ANGLE (Degree)	REMARK
5426	39.68	37.81	54	-14.32	31.53	7.47	37.13	100	13	Average
5426	51.42	49.55	74	-22.58	31.53	7.47	37.13	100	13	Peak
5470	49.76	47.74	68.3	-18.54	31.57	7.53	37.08	100	13	Peak
5580	84	81.88			31.71	7.57	37.16	100	13	Average
5580	93.78	91.66			31.71	7.57	37.16	100	13	Peak
5725	49.83	47.59	68.3	-18.47	31.96	7.71	37.43	100	13	Peak
ANTENNA POLARITY & TEST DISTANCE: VERTICAL AT 3 M										
FREQ. (MHz)	EMISSION LEVEL (dBuV/m)	READ LEVEL (dBuV)	LIMIT (dBuV/m)	MARGIN (dB)	ANTENNA FACTOR (dB/m)	CABLE LOSS (dB)	PREAMP FACTOR (dB)	ANTENNA HEIGHT (cm)	TABLE ANGLE (Degree)	REMARK
5428	39.56	37.69	54	-14.44	31.53	7.47	37.13	100	281	Average
5428	51.09	49.22	74	-22.91	31.53	7.47	37.13	100	281	Peak
5470	51.58	49.56	68.3	-16.72	31.57	7.53	37.08	100	281	Peak
5580	77.14	75.02			31.71	7.57	37.16	100	281	Average
5580	87.09	84.97			31.71	7.57	37.16	100	281	Peak
5725	51.15	48.91	68.3	-17.15	31.96	7.71	37.43	100	281	Peak

REMARKS:

1. Emission Level = Read Level + Antenna Factor + Cable Loss - Preamp Factor
2. 5580MHz: Fundamental frequency.
3. 5470MHz & 5725MHz: Out of restricted band



A D T

EUT TEST CONDITION		MEASUREMENT DETAIL	
CHANNEL	Channel 140	FREQUENCY RANGE	1GHz ~ 40GHz
INPUT POWER (SYSTEM)	120Vac, 60 Hz	DETECTOR FUNCTION	Peak (PK) Average (AV)
ENVIRONMENTAL CONDITIONS	25deg. C, 65%RH	TESTED BY	Kay Wu

ANTENNA POLARITY & TEST DISTANCE: HORIZONTAL AT 3 M										
FREQ. (MHz)	EMISSION LEVEL (dBuV/m)	READ LEVEL (dBuV)	LIMIT (dBuV/m)	MARGIN (dB)	ANTENNA FACTOR (dB/m)	CABLE LOSS (dB)	PREAMP FACTOR (dB)	ANTENNA HEIGHT (cm)	TABLE ANGLE (Degree)	REMARK
5436	39.69	37.8	54	-14.31	31.55	7.47	37.13	100	350	Average
5436	51.04	49.15	74	-22.96	31.55	7.47	37.13	100	350	Peak
5470	49.32	47.3	68.3	-18.98	31.57	7.53	37.08	100	350	Peak
5700	84.44	82.25			31.9	7.69	37.4	100	350	Average
5700	93.8	91.61			31.9	7.69	37.4	100	350	Peak
5725	51.44	49.2	68.3	-16.86	31.96	7.71	37.43	100	350	Peak
ANTENNA POLARITY & TEST DISTANCE: VERTICAL AT 3 M										
FREQ. (MHz)	EMISSION LEVEL (dBuV/m)	READ LEVEL (dBuV)	LIMIT (dBuV/m)	MARGIN (dB)	ANTENNA FACTOR (dB/m)	CABLE LOSS (dB)	PREAMP FACTOR (dB)	ANTENNA HEIGHT (cm)	TABLE ANGLE (Degree)	REMARK
5436	39.6	37.71	54	-14.4	31.55	7.47	37.13	107	281	Average
5436	52.35	50.46	74	-21.65	31.55	7.47	37.13	107	281	Peak
5470	50.39	48.37	68.3	-17.91	31.57	7.53	37.08	107	281	Peak
5700	76.87	74.68			31.9	7.69	37.4	107	281	Average
5700	86.57	84.38			31.9	7.69	37.4	107	281	Peak
5725	51.32	49.08	68.3	-16.98	31.96	7.71	37.43	107	281	Peak

REMARKS:

1. Emission Level = Read Level + Antenna Factor + Cable Loss - Preamp Factor
2. 5700MHz: Fundamental frequency.
3. 5470MHz & 5725MHz: Out of restricted band

802.11n (40MHz)

EUT TEST CONDITION		MEASUREMENT DETAIL	
CHANNEL	Channel 38	FREQUENCY RANGE	1GHz ~ 40GHz
INPUT POWER (SYSTEM)	120Vac, 60 Hz	DETECTOR FUNCTION	Peak (PK) Average (AV)
ENVIRONMENTAL CONDITIONS	25deg. C, 65%RH	TESTED BY	Kay Wu

ANTENNA POLARITY & TEST DISTANCE: HORIZONTAL AT 3 M										
FREQ. (MHz)	EMISSION LEVEL (dBuV/m)	READ LEVEL (dBuV)	LIMIT (dBuV/m)	MARGIN (dB)	ANTENNA FACTOR (dB/m)	CABLE LOSS (dB)	PREAMP FACTOR (dB)	ANTENNA HEIGHT (cm)	TABLE ANGLE (Degree)	REMARK
5132	39.3	37.95	54	-14.7	31.31	7.34	37.3	100	62	Average
5132	51.36	50.01	74	-22.64	31.31	7.34	37.3	100	62	Peak
5190	74.54	73.21			31.35	7.32	37.34	100	62	Average
5190	84.89	83.56			31.35	7.32	37.34	100	62	Peak
5448	39.59	37.69	54	-14.41	31.56	7.47	37.13	100	62	Average
5448	52.02	50.12	74	-21.98	31.56	7.47	37.13	100	62	Peak
ANTENNA POLARITY & TEST DISTANCE: VERTICAL AT 3 M										
FREQ. (MHz)	EMISSION LEVEL (dBuV/m)	READ LEVEL (dBuV)	LIMIT (dBuV/m)	MARGIN (dB)	ANTENNA FACTOR (dB/m)	CABLE LOSS (dB)	PREAMP FACTOR (dB)	ANTENNA HEIGHT (cm)	TABLE ANGLE (Degree)	REMARK
5148	40.34	39.01	54	-13.66	31.32	7.33	37.32	100	28	Average
5148	52.71	51.38	74	-21.29	31.32	7.33	37.32	100	28	Peak
5190	77.67	76.34			31.35	7.32	37.34	100	28	Average
5190	87.02	85.69			31.35	7.32	37.34	100	28	Peak
5434	40.07	38.18	54	-13.93	31.55	7.47	37.13	100	28	Average
5434	52.14	50.25	74	-21.86	31.55	7.47	37.13	100	28	Peak

REMARKS:

1. Emission Level = Read Level + Antenna Factor + Cable Loss - Preamp Factor
2. 5190MHz: Fundamental frequency.



A D T

EUT TEST CONDITION		MEASUREMENT DETAIL	
CHANNEL	Channel 46	FREQUENCY RANGE	1GHz ~ 40GHz
INPUT POWER (SYSTEM)	120Vac, 60 Hz	DETECTOR FUNCTION	Peak (PK) Average (AV)
ENVIRONMENTAL CONDITIONS	25deg. C, 65%RH	TESTED BY	Kay Wu

ANTENNA POLARITY & TEST DISTANCE: HORIZONTAL AT 3 M										
FREQ. (MHz)	EMISSION LEVEL (dBuV/m)	READ LEVEL (dBuV)	LIMIT (dBuV/m)	MARGIN (dB)	ANTENNA FACTOR (dB/m)	CABLE LOSS (dB)	PREAMP FACTOR (dB)	ANTENNA HEIGHT (cm)	TABLE ANGLE (Degree)	REMARK
5150	40.67	39.34	54	-13.33	31.32	7.33	37.32	100	320	Average
5150	50.25	48.92	74	-23.75	31.32	7.33	37.32	100	320	Peak
5230	82.26	80.85			31.39	7.34	37.32	100	320	Average
5230	91.27	89.86			31.39	7.34	37.32	100	320	Peak
5350	39.99	38.29	54	-14.01	31.48	7.4	37.18	100	320	Average
5350	48.37	46.67	74	-25.63	31.48	7.4	37.18	100	320	Peak
ANTENNA POLARITY & TEST DISTANCE: VERTICAL AT 3 M										
FREQ. (MHz)	EMISSION LEVEL (dBuV/m)	READ LEVEL (dBuV)	LIMIT (dBuV/m)	MARGIN (dB)	ANTENNA FACTOR (dB/m)	CABLE LOSS (dB)	PREAMP FACTOR (dB)	ANTENNA HEIGHT (cm)	TABLE ANGLE (Degree)	REMARK
5150	40.8	39.47	54	-13.2	31.32	7.33	37.32	100	173	Average
5150	48.12	46.79	74	-25.88	31.32	7.33	37.32	100	173	Peak
5230	76.3	74.89			31.39	7.34	37.32	100	173	Average
5230	86.2	84.79			31.39	7.34	37.32	100	173	Peak
5350	40.14	38.44	54	-13.86	31.48	7.4	37.18	100	173	Average
5350	50.52	48.82	74	-23.48	31.48	7.4	37.18	100	173	Peak

REMARKS:

1. Emission Level = Read Level + Antenna Factor + Cable Loss - Preamp Factor
2. 5230MHz: Fundamental frequency.



A D T

EUT TEST CONDITION		MEASUREMENT DETAIL	
CHANNEL	Channel 54	FREQUENCY RANGE	1GHz ~ 40GHz
INPUT POWER (SYSTEM)	120Vac, 60 Hz	DETECTOR FUNCTION	Peak (PK) Average (AV)
ENVIRONMENTAL CONDITIONS	25deg. C, 65%RH	TESTED BY	Kay Wu

ANTENNA POLARITY & TEST DISTANCE: HORIZONTAL AT 3 M										
FREQ. (MHz)	EMISSION LEVEL (dBuV/m)	READ LEVEL (dBuV)	LIMIT (dBuV/m)	MARGIN (dB)	ANTENNA FACTOR (dB/m)	CABLE LOSS (dB)	PREAMP FACTOR (dB)	ANTENNA HEIGHT (cm)	TABLE ANGLE (Degree)	REMARK
5088	39.67	38.37	54	-14.33	31.27	7.3	37.27	100	83	Average
5088	52.04	50.74	74	-21.96	31.27	7.3	37.27	100	83	Peak
5270	75.3	73.8			31.41	7.36	37.27	100	83	Average
5270	84.52	83.02			31.41	7.36	37.27	100	83	Peak
5458	40.05	38.04	54	-13.95	31.56	7.53	37.08	100	83	Average
5458	51.58	49.57	74	-22.42	31.56	7.53	37.08	100	83	Peak
ANTENNA POLARITY & TEST DISTANCE: VERTICAL AT 3 M										
FREQ. (MHz)	EMISSION LEVEL (dBuV/m)	READ LEVEL (dBuV)	LIMIT (dBuV/m)	MARGIN (dB)	ANTENNA FACTOR (dB/m)	CABLE LOSS (dB)	PREAMP FACTOR (dB)	ANTENNA HEIGHT (cm)	TABLE ANGLE (Degree)	REMARK
5120	39.75	38.42	54	-14.25	31.29	7.34	37.3	100	3	Average
5120	51.82	50.49	74	-22.18	31.29	7.34	37.3	100	3	Peak
5270	78.75	77.25			31.41	7.36	37.27	100	3	Average
5270	88.08	86.58			31.41	7.36	37.27	100	3	Peak
5460	40.23	38.22	54	-13.77	31.56	7.53	37.08	100	3	Average
5460	52.17	50.16	74	-21.83	31.56	7.53	37.08	100	3	Peak

REMARKS:

1. Emission Level = Read Level + Antenna Factor + Cable Loss - Preamp Factor
2. 5270MHz: Fundamental frequency.



A D T

EUT TEST CONDITION		MEASUREMENT DETAIL	
CHANNEL	Channel 62	FREQUENCY RANGE	1GHz ~ 40GHz
INPUT POWER (SYSTEM)	120Vac, 60 Hz	DETECTOR FUNCTION	Peak (PK) Average (AV)
ENVIRONMENTAL CONDITIONS	25deg. C, 65%RH	TESTED BY	Kay Wu

ANTENNA POLARITY & TEST DISTANCE: HORIZONTAL AT 3 M										
FREQ. (MHz)	EMISSION LEVEL (dBuV/m)	READ LEVEL (dBuV)	LIMIT (dBuV/m)	MARGIN (dB)	ANTENNA FACTOR (dB/m)	CABLE LOSS (dB)	PREAMP FACTOR (dB)	ANTENNA HEIGHT (cm)	TABLE ANGLE (Degree)	REMARK
5150	38.96	0.31	54	-15.04	31.32	7.33	0	100	59	Average
5150	48.71	10.06	74	-25.29	31.32	7.33	0	100	59	Peak
5310	76.44	37.59			31.45	7.4	0	100	59	Average
5310	85.55	46.7			31.45	7.4	0	100	59	Peak
5350	39.71	0.83	54	-14.29	31.48	7.4	0	100	59	Average
5350	50.49	11.61	74	-23.51	31.48	7.4	0	100	59	Peak
ANTENNA POLARITY & TEST DISTANCE: VERTICAL AT 3 M										
FREQ. (MHz)	EMISSION LEVEL (dBuV/m)	READ LEVEL (dBuV)	LIMIT (dBuV/m)	MARGIN (dB)	ANTENNA FACTOR (dB/m)	CABLE LOSS (dB)	PREAMP FACTOR (dB)	ANTENNA HEIGHT (cm)	TABLE ANGLE (Degree)	REMARK
5150	39.61	0.96	54	-14.39	31.32	7.33	0	100	345	Average
5150	49.4	10.75	74	-24.6	31.32	7.33	0	100	345	Peak
5310	82.74	43.89			31.45	7.4	0	100	345	Average
5310	91.89	53.04			31.45	7.4	0	100	345	Peak
5350	41.01	2.13	54	-12.99	31.48	7.4	0	100	345	Average
5350	51.08	12.2	74	-22.92	31.48	7.4	0	100	345	Peak

REMARKS:

1. Emission Level = Read Level + Antenna Factor + Cable Loss - Preamp Factor
2. 5310MHz: Fundamental frequency.



A D T

EUT TEST CONDITION		MEASUREMENT DETAIL	
CHANNEL	Channel 102	FREQUENCY RANGE	1GHz ~ 40GHz
INPUT POWER (SYSTEM)	120Vac, 60 Hz	DETECTOR FUNCTION	Peak (PK) Average (AV)
ENVIRONMENTAL CONDITIONS	25deg. C, 65%RH	TESTED BY	Kay Wu

ANTENNA POLARITY & TEST DISTANCE: HORIZONTAL AT 3 M										
FREQ. (MHz)	EMISSION LEVEL (dBuV/m)	READ LEVEL (dBuV)	LIMIT (dBuV/m)	MARGIN (dB)	ANTENNA FACTOR (dB/m)	CABLE LOSS (dB)	PREAMP FACTOR (dB)	ANTENNA HEIGHT (cm)	TABLE ANGLE (Degree)	REMARK
5458	40.52	38.51	54	-13.48	31.56	7.53	37.08	100	1	Average
5458	52.28	50.27	74	-21.72	31.56	7.53	37.08	100	1	Peak
5470	53.03	51.01	68.3	-15.27	31.57	7.53	37.08	100	1	Peak
5510	77.96	75.83			31.6	7.59	37.06	100	1	Average
5510	87.67	85.54			31.6	7.59	37.06	100	1	Peak
5725	50.62	48.38	68.3	-17.68	31.96	7.71	37.43	100	1	Peak
ANTENNA POLARITY & TEST DISTANCE: VERTICAL AT 3 M										
FREQ. (MHz)	EMISSION LEVEL (dBuV/m)	READ LEVEL (dBuV)	LIMIT (dBuV/m)	MARGIN (dB)	ANTENNA FACTOR (dB/m)	CABLE LOSS (dB)	PREAMP FACTOR (dB)	ANTENNA HEIGHT (cm)	TABLE ANGLE (Degree)	REMARK
5436	40.22	38.33	54	-13.78	31.55	7.47	37.13	100	266	Average
5436	51.67	49.78	74	-22.33	31.55	7.47	37.13	100	266	Peak
5470	50.31	48.29	68.3	-17.99	31.57	7.53	37.08	100	266	Peak
5510	72.74	70.61			31.6	7.59	37.06	100	266	Average
5510	82.13	80			31.6	7.59	37.06	100	266	Peak
5725	50.13	47.89	68.3	-18.17	31.96	7.71	37.43	100	266	Peak

REMARKS:

1. Emission Level = Read Level + Antenna Factor + Cable Loss - Preamp Factor
2. 5510MHz: Fundamental frequency.
3. 5470MHz & 5725MHz: Out of restricted band



A D T

EUT TEST CONDITION		MEASUREMENT DETAIL	
CHANNEL	Channel 110	FREQUENCY RANGE	1GHz ~ 40GHz
INPUT POWER (SYSTEM)	120Vac, 60 Hz	DETECTOR FUNCTION	Peak (PK) Average (AV)
ENVIRONMENTAL CONDITIONS	25deg. C, 65%RH	TESTED BY	Kay Wu

ANTENNA POLARITY & TEST DISTANCE: HORIZONTAL AT 3 M										
FREQ. (MHz)	EMISSION LEVEL (dBuV/m)	READ LEVEL (dBuV)	LIMIT (dBuV/m)	MARGIN (dB)	ANTENNA FACTOR (dB/m)	CABLE LOSS (dB)	PREAMP FACTOR (dB)	ANTENNA HEIGHT (cm)	TABLE ANGLE (Degree)	REMARK
5460	40.05	38.04	54	-13.95	31.56	7.53	37.08	100	4	Average
5460	49.31	47.3	74	-24.69	31.56	7.53	37.08	100	4	Peak
5470	49.2	47.18	68.3	-19.1	31.57	7.53	37.08	100	4	Peak
5550	81.03	78.86			31.68	7.58	37.09	100	4	Average
5550	90.28	88.11			31.68	7.58	37.09	100	4	Peak
5725	49.87	47.63	68.3	-18.43	31.96	7.71	37.43	100	4	Peak
ANTENNA POLARITY & TEST DISTANCE: VERTICAL AT 3 M										
FREQ. (MHz)	EMISSION LEVEL (dBuV/m)	READ LEVEL (dBuV)	LIMIT (dBuV/m)	MARGIN (dB)	ANTENNA FACTOR (dB/m)	CABLE LOSS (dB)	PREAMP FACTOR (dB)	ANTENNA HEIGHT (cm)	TABLE ANGLE (Degree)	REMARK
5460	39.54	37.53	54	-14.46	31.56	7.53	37.08	100	279	Average
5460	49.53	47.52	74	-24.47	31.56	7.53	37.08	100	279	Peak
5470	49.28	47.26	68.3	-19.02	31.57	7.53	37.08	100	279	Peak
5550	75.91	73.74			31.68	7.58	37.09	100	279	Average
5550	85.13	82.96			31.68	7.58	37.09	100	279	Peak
5725	49.78	47.54	68.3	-18.52	31.96	7.71	37.43	100	279	Peak

REMARKS:

1. Emission Level = Read Level + Antenna Factor + Cable Loss - Preamp Factor
2. 5550MHz: Fundamental frequency.
3. 5470MHz & 5725MHz: Out of restricted band



A D T

EUT TEST CONDITION		MEASUREMENT DETAIL	
CHANNEL	Channel 134	FREQUENCY RANGE	1GHz ~ 40GHz
INPUT POWER (SYSTEM)	120Vac, 60 Hz	DETECTOR FUNCTION	Peak (PK) Average (AV)
ENVIRONMENTAL CONDITIONS	25deg. C, 65%RH	TESTED BY	Kay Wu

ANTENNA POLARITY & TEST DISTANCE: HORIZONTAL AT 3 M										
FREQ. (MHz)	EMISSION LEVEL (dBuV/m)	READ LEVEL (dBuV)	LIMIT (dBuV/m)	MARGIN (dB)	ANTENNA FACTOR (dB/m)	CABLE LOSS (dB)	PREAMP FACTOR (dB)	ANTENNA HEIGHT (cm)	TABLE ANGLE (Degree)	REMARK
5460	39.55	37.54	54	-14.45	31.56	7.53	37.08	100	345	Average
5460	50.11	48.1	74	-23.89	31.56	7.53	37.08	100	345	Peak
5470	50.53	48.51	68.3	-17.77	31.57	7.53	37.08	100	345	Peak
5670	81.05	78.85			31.88	7.66	37.34	100	345	Average
5670	90.61	88.41			31.88	7.66	37.34	100	345	Peak
5725	49.65	47.41	68.3	-18.65	31.96	7.71	37.43	100	345	Peak
ANTENNA POLARITY & TEST DISTANCE: VERTICAL AT 3 M										
FREQ. (MHz)	EMISSION LEVEL (dBuV/m)	READ LEVEL (dBuV)	LIMIT (dBuV/m)	MARGIN (dB)	ANTENNA FACTOR (dB/m)	CABLE LOSS (dB)	PREAMP FACTOR (dB)	ANTENNA HEIGHT (cm)	TABLE ANGLE (Degree)	REMARK
5460	39.72	37.71	54	-14.28	31.56	7.53	37.08	98	179	Average
5460	48.03	46.02	74	-25.97	31.56	7.53	37.08	98	179	Peak
5470	49.89	47.87	68.3	-18.41	31.57	7.53	37.08	98	179	Peak
5670	76.17	73.97			31.88	7.66	37.34	98	179	Average
5670	83.91	81.71			31.88	7.66	37.34	98	179	Peak
5725	49.15	46.91	68.3	-19.15	31.96	7.71	37.43	98	179	Peak

REMARKS:

1. Emission Level = Read Level + Antenna Factor + Cable Loss - Preamp Factor
2. 5670MHz: Fundamental frequency.
3. 5470MHz & 5725MHz: Out of restricted band



A D T

BELOW 1GHz WORST-CASE DATA : 802.11a

EUT TEST CONDITION		MEASUREMENT DETAIL	
CHANNEL	Channel 64	FREQUENCY RANGE	30MHz ~ 1GHz
INPUT POWER (SYSTEM)	120Vac, 60 Hz	DETECTOR FUNCTION	Peak (PK) Average (AV)
ENVIRONMENTAL CONDITIONS	25deg. C, 65%RH	TESTED BY	Kay Wu

ANTENNA POLARITY & TEST DISTANCE: HORIZONTAL AT 3 M										
FREQ. (MHz)	EMISSION LEVEL (dBuV/m)	READ LEVEL (dBuV)	LIMIT (dBuV/m)	MARGIN (dB)	ANTENNA FACTOR (dB/m)	CABLE LOSS (dB)	PREAMP FACTOR (dB)	ANTENNA HEIGHT (cm)	TABLE ANGLE (Degree)	REMARK
42.42	29.59	46.39	40	-10.41	13.58	0.7	31.08	100	153	Peak
114.51	27.52	47.78	43.5	-15.98	10.46	1.15	31.87	100	185	Peak
227.64	22.73	42.29	46	-23.27	10.54	1.73	31.83	100	251	Peak
430.9	20.21	33.73	46	-25.79	15.95	2.54	32.01	100	236	Peak
562.5	22.66	33	46	-23.34	18.75	2.98	32.07	100	114	Peak
689.2	26.1	33.86	46	-19.9	20.69	3.39	31.84	100	154	Peak
ANTENNA POLARITY & test distance: VERTICAL at 3 m										
FREQ. (MHz)	EMISSION LEVEL (dBuV/m)	READ LEVEL (dBuV)	LIMIT (dBuV/m)	MARGIN (dB)	ANTENNA FACTOR (dB/m)	CABLE LOSS (dB)	PREAMP FACTOR (dB)	ANTENNA HEIGHT (cm)	TABLE ANGLE (Degree)	REMARK
36.48	33.97	51.29	40	-6.03	13.09	0.62	31.03	101	253	Peak
42.69	34.89	51.69	40	-5.11	13.58	0.7	31.08	100	254	Peak
68.88	27.85	47.84	40	-12.15	10.89	0.89	31.77	100	158	Peak
563.2	22.88	33.19	46	-23.12	18.77	2.99	32.07	100	162	Peak
639.5	24.93	33.74	46	-21.07	20.08	3.21	32.1	100	118	Peak
821.5	27.24	32.61	46	-18.76	22.5	3.75	31.62	100	184	Peak

REMARKS: Emission Level = Read Level + Antenna Factor + Cable Loss - Preamp Factor

4.2 CONDUCTED EMISSION MEASUREMENT

4.2.1 LIMITS OF CONDUCTED EMISSION MEASUREMENT

FREQUENCY OF EMISSION (MHz)	CONDUCTED LIMIT (dB μ V)	
	Quasi-peak	Average
0.15 ~ 0.5	66 to 56	56 to 46
0.5 ~ 5	56	46
5 ~ 30	60	50

- NOTE:** 1. The lower limit shall apply at the transition frequencies.
 2. The limit decreases in line with the logarithm of the frequency in the range of 0.15 to 0.50MHz.
 3. All emanations from a class A/B digital device or system, including any network of conductors and apparatus connected thereto, shall not exceed the level of field strengths specified above.

4.2.2 TEST INSTRUMENTS

DESCRIPTION & MANUFACTURER	MODEL NO.	SERIAL NO.	DATE OF CALIBRATION	DUE DATE OF CALIBRATION
Test Receiver ROHDE & SCHWARZ	ESCS30	100288	Nov. 09, 2012	Nov. 08, 2013
RF signal cable Woken	5D-FB	Cable-HYCO2-01	Dec. 28, 2012	Dec. 27, 2013
LISN ROHDE & SCHWARZ (EUT)	ESH2-Z5	100100	Dec. 21, 2012	Dec. 20, 2013
LISN ROHDE & SCHWARZ (Peripheral)	ESH3-Z5	100311	Jul. 06, 2012	Jul. 05, 2013
Software ADT	BV ADT_Cond_ V7.3.7.3	NA	NA	NA

- NOTE:** 1. The calibration interval of the above test instruments is 12 months and the calibrations are traceable to NML/ROC and NIST/USA.
 2. The test was performed in HwaYa Shielded Room 2.
 3. The VCCI Site Registration No. is C-2047.

4.2.3 TEST PROCEDURES

- The EUT was placed 0.4 meters from the conducting wall of the shielded room with EUT being connected to the power mains through a line impedance stabilization network (LISN). Other support units were connected to the power mains through another LISN. The two LISNs provide 50 ohm/ 50uH of coupling impedance for the measuring instrument.
- Both lines of the power mains connected to the EUT were checked for maximum conducted interference.
- The frequency range from 150kHz to 30MHz was searched. Emission levels under (Limit - 20dB) was not recorded.

NOTE: All modes of operation were investigated and the worst-case emissions are reported.

4.2.4 DEVIATION FROM TEST STANDARD

No deviation.

4.2.5 TEST SETUP

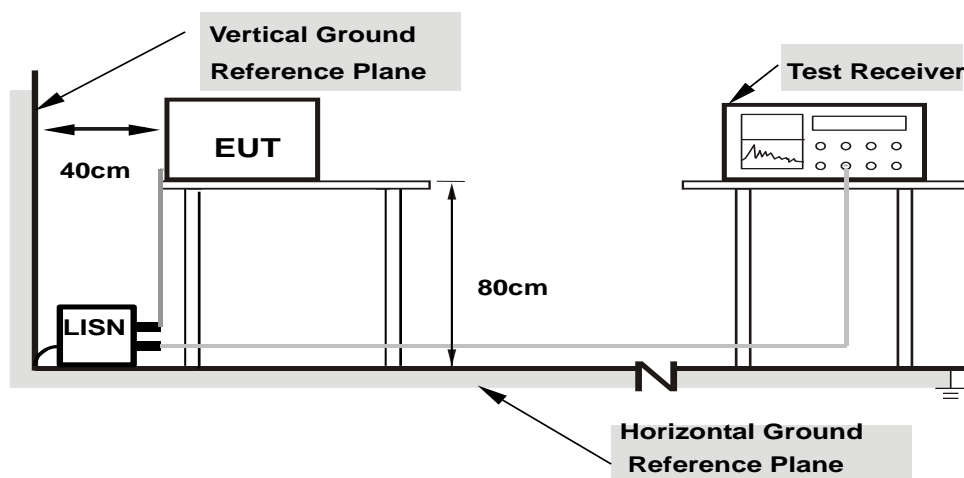

- Note:**
- Support units were connected to second LISN.
 - Both of LISNs (AMN) are 80 cm from EUT and at least 80 from other units and other metal planes

For the actual test configuration, please refer to the attached file (Test Setup Photo).

4.2.6 EUT OPERATING CONDITIONS

Same as 4.1.6.

4.2.7 TEST RESULTS

CONDUCTED WORST-CASE DATA : 802.11a

PHASE	Line 1	6dB BANDWIDTH	9kHz
--------------	--------	----------------------	------

No	Freq. [MHz]	Corr. Factor (dB)	Reading Value		Emission Level		Limit		Margin	
			[dB (uV)]		[dB (uV)]		[dB (uV)]		(dB)	
			Q.P.	AV.	Q.P.	AV.	Q.P.	AV.	Q.P.	AV.
1	0.19687	0.12	36.20	21.55	36.32	21.67	63.74	53.74	-27.42	-32.07
2	0.45469	0.16	34.23	19.04	34.39	19.20	56.79	46.79	-22.40	-27.59
3	0.83359	0.19	33.39	17.57	33.58	17.76	56.00	46.00	-22.42	-28.24
4	3.63672	0.33	28.84	18.44	29.17	18.77	56.00	46.00	-26.83	-27.23
5	8.81641	0.59	28.69	16.86	29.28	17.45	60.00	50.00	-30.72	-32.55
6	16.23438	1.02	34.51	23.25	35.53	24.27	60.00	50.00	-24.47	-25.73

REMARKS:

1. Q.P. and AV. are abbreviations of quasi-peak and average individually.
2. The emission levels of other frequencies were very low against the limit.
3. Margin value = Emission level - Limit value
4. Correction factor = Insertion loss + Cable loss
5. Emission Level = Correction Factor + Reading Value.

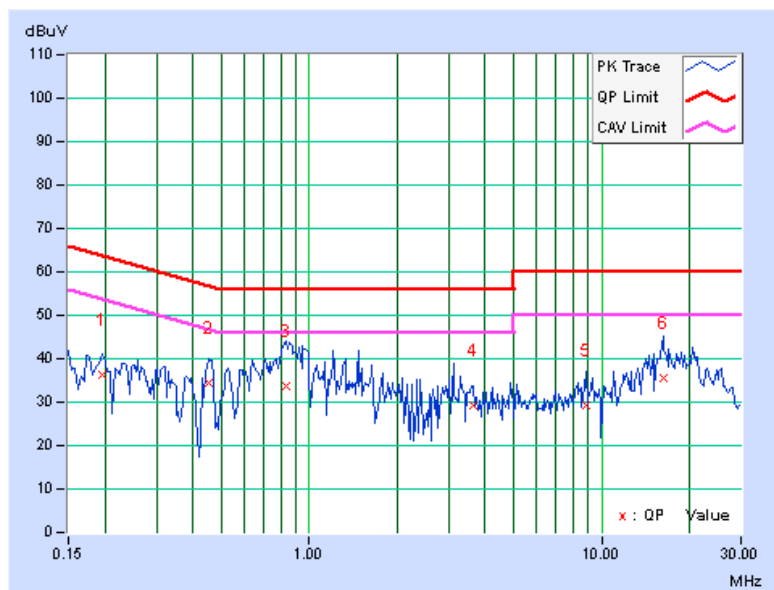



A D T

PHASE	Line 2	6dB BANDWIDTH	9kHz
-------	--------	---------------	------

No	Freq. [MHz]	Corr. Factor (dB)	Reading Value [dB (uV)]		Emission Level [dB (uV)]		Limit [dB (uV)]		Margin (dB)	
			Q.P.	AV.	Q.P.	AV.	Q.P.	AV.	Q.P.	AV.
			1	0.18906	0.17	33.60	20.27	33.77	20.44	64.08
2	0.43906	0.21	28.28	19.32	28.49	19.53	57.08	47.08	-28.59	-27.55
3	0.84141	0.24	35.47	25.26	35.71	25.50	56.00	46.00	-20.29	-20.50
4	3.08203	0.33	32.04	19.54	32.37	19.87	56.00	46.00	-23.63	-26.13
5	11.89453	0.65	29.15	18.45	29.80	19.10	60.00	50.00	-30.20	-30.90
6	18.94141	0.89	38.41	25.73	39.30	26.62	60.00	50.00	-20.70	-23.38

REMARKS:

1. Q.P. and AV. are abbreviations of quasi-peak and average individually.
2. The emission levels of other frequencies were very low against the limit.
3. Margin value = Emission level - Limit value
4. Correction factor = Insertion loss + Cable loss
5. Emission Level = Correction Factor + Reading Value.

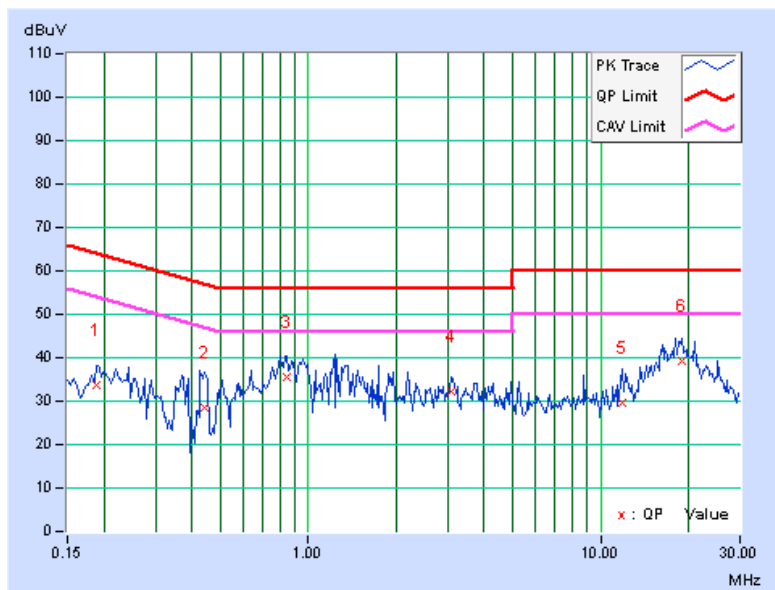

4.3 PEAK TRANSMIT POWER MEASUREMENT

4.3.1 LIMITS OF PEAK TRANSMIT POWER MEASUREMENT

FREQUENCY BAND	LIMIT
5.150 ~ 5.250GHz	The lesser of 50mW (17dBm) or 4dBm + 10logB
5.250 ~ 5.350GHz	The lesser of 250mW (24dBm) or 11dBm + 10logB
5.470 ~ 5.725GHz	The lesser of 250mW (24dBm) or 11dBm + 10logB

NOTE: Where B is the 26dB emission bandwidth in MHz.

4.3.2 TEST SETUP

FOR POWER OUTPUT MEASUREMENT

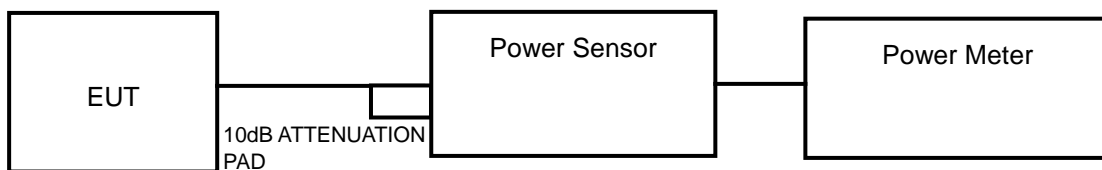

FOR 26dB BANDWIDTH

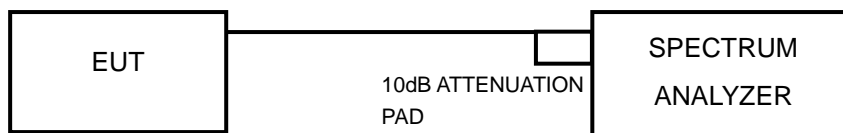

4.3.3 TEST INSTRUMENTS

Refer to section 4.1.3 to get information of above instrument.

4.3.4 TEST PROCEDURE

FOR AVERAGE POWER MEASUREMENT

<802.11a, 802.11n (20MHz), 802.11n (40MHz)>

Method PM is used to perform output power measurement, trigger and gating function of wide band power meter is enabled to measure max output power of TX on burst. Duty factor is added to measured value.

FOR 26dB BANDWIDTH

- 1) Set RBW = approximately 1% of the emission bandwidth.
- 2) Set the VBW > RBW.
- 3) Detector = Peak.
- 4) Trace mode = max hold.
- 5) Measure the maximum width of the emission that is 26 dB down from the peak of the emission. Compare this with the RBW setting of the analyzer. Readjust RBW and repeat measurement as needed until the RBW/EBW ratio is approximately 1%.

4.3.5 DEVIATION FROM TEST STANDARD

No deviation.

4.3.6 EUT OPERATING CONDITIONS

The software provided by client to enable the EUT under transmission condition continuously at specific channel frequencies individually.



4.3.7 TEST RESULTS

POWER OUTPUT: 802.11a

CHANNEL	CHANNEL FREQUENCY (MHz)	AVERAGE POWER (mW)	AVERAGE POWER (dBm)	POWER LIMIT (dBm)	PASS/FAIL
36	5180	34.277	15.35	17	PASS
44	5220	36.308	15.60	17	PASS
48	5240	37.325	15.72	17	PASS
52	5260	38.994	15.91	24	PASS
60	5300	32.434	15.11	24	PASS
64	5320	32.584	15.13	24	PASS
100	5500	35.975	15.56	24	PASS
116	5580	37.844	15.78	24	PASS
140	5700	32.359	15.10	24	PASS

802.11n (20MHz)

CHANNEL	CHANNEL FREQUENCY (MHz)	AVERAGE POWER (mW)	AVERAGE POWER (dBm)	POWER LIMIT (dBm)	PASS/FAIL
36	5180	27.102	14.33	17	PASS
44	5220	28.774	14.59	17	PASS
48	5240	29.174	14.65	17	PASS
52	5260	29.854	14.75	24	PASS
60	5300	25.645	14.09	24	PASS
64	5320	26.062	14.16	24	PASS
100	5500	29.040	14.63	24	PASS
116	5580	30.269	14.81	24	PASS
140	5700	25.823	14.12	24	PASS

802.11n (40MHz)

CHANNEL	CHANNEL FREQUENCY (MHz)	AVERAGE POWER (mW)	AVERAGE POWER (dBm)	POWER LIMIT (dBm)	PASS/FAIL
38	5190	17.660	12.47	17	PASS
46	5230	18.664	12.71	17	PASS
54	5270	19.364	12.87	24	PASS
62	5310	16.181	12.09	24	PASS
102	5510	18.239	12.61	24	PASS
110	5550	18.880	12.76	24	PASS
134	5670	16.069	12.06	24	PASS



A D T

26dB BANDWIDTH: 802.11a

CHANNEL	CHANNEL FREQUENCY (MHz)	26dBc BANDWIDTH (MHz)	PASS / FAIL
36	5180	24.21	PASS
44	5220	23.80	PASS
48	5240	23.60	PASS
52	5260	24.30	PASS
60	5300	23.57	PASS
64	5320	24.06	PASS
100	5500	23.89	PASS
116	5580	23.95	PASS
140	5700	23.83	PASS

802.11n (20MHz)

CHANNEL	CHANNEL FREQUENCY (MHz)	26dBc BANDWIDTH (MHz)	PASS / FAIL
36	5180	24.70	PASS
44	5220	24.34	PASS
48	5240	23.77	PASS
52	5260	24.59	PASS
60	5300	24.34	PASS
64	5320	24.42	PASS
100	5500	24.02	PASS
116	5580	24.12	PASS
140	5700	23.86	PASS

802.11n (40MHz)

CHANNEL	CHANNEL FREQUENCY (MHz)	26dBc BANDWIDTH (MHz)	PASS / FAIL
38	5190	53.72	PASS
46	5230	52.22	PASS
54	5270	52.85	PASS
62	5310	53.11	PASS
102	5510	53.61	PASS
110	5550	54.26	PASS
134	5670	53.92	PASS

4.4 PEAK POWER SPECTRAL DENSITY MEASUREMENT

4.4.1 LIMITS OF PEAK POWER SPECTRAL DENSITY MEASUREMENT

FREQUENCY BAND	LIMIT
5.150 ~ 5.250GHz	4dBm
5.250 ~ 5.350GHz	11dBm
5.470 ~ 5.725GHz	11dBm

4.4.2 TEST SETUP

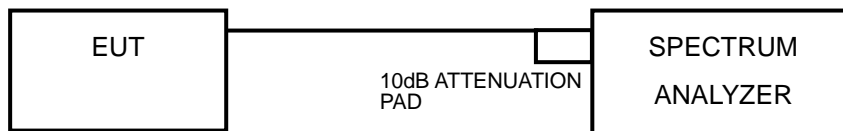

4.4.3 TEST INSTRUMENTS

Refer to section 4.1.3 to get information of above instrument.

4.4.4 TEST PROCEDURES

<802.11a, 802.11n (20MHz), 802.11n (40MHz)>

Using method SA-2 alternative

- 1) Set span to encompass the entire emission bandwidth (EBW) of the signal.
- 2) Set RBW = 1 MHz, Set VBW \geq 3 MHz, Detector = RMS
- 3) Sweep time = 4second.
- 4) Perform a single sweep.
- 5) Record the max value and add 10 log (1/duty cycle)

4.4.5 DEVIATION FROM TEST STANDARD

No deviation.

4.4.6 EUT OPERATING CONDITIONS

Same as 4.3.6.

4.4.7 TEST RESULTS

802.11a

CHANNEL	FREQUENCY (MHz)	PSD W/O DUTY FACTOR (dBm)	DUTY FACTOR	PSD WITH DUTY FACTOR (dBm)	MAXIMUM LIMIT (dBm)	PASS/FAIL
36	5180	3.17	0.21	3.38	4	PASS
44	5220	3.41	0.21	3.62	4	PASS
48	5240	3.63	0.21	3.84	4	PASS
52	5260	3.93	0.21	4.14	11	PASS
60	5300	4.22	0.21	4.43	11	PASS
64	5320	4.29	0.21	4.50	11	PASS
100	5500	3.94	0.21	4.15	11	PASS
116	5580	4.12	0.21	4.33	11	PASS
140	5700	4.09	0.21	4.30	11	PASS

NOTE: Refer to section 3.3 for duty cycle spectrum plot.

802.11n (20MHz)

CHANNEL	FREQUENCY (MHz)	PSD W/O DUTY FACTOR (dBm)	DUTY FACTOR	PSD WITH DUTY FACTOR (dBm)	MAXIMUM LIMIT (dBm)	PASS/FAIL
36	5180	1.89	0.25	2.14	4	PASS
44	5220	2.18	0.25	2.43	4	PASS
48	5240	2.34	0.25	2.59	4	PASS
52	5260	2.63	0.25	2.88	11	PASS
60	5300	2.97	0.25	3.22	11	PASS
64	5320	3.18	0.25	3.43	11	PASS
100	5500	2.86	0.25	3.11	11	PASS
116	5580	3.06	0.25	3.31	11	PASS
140	5700	3.03	0.25	3.28	11	PASS

NOTE: Refer to section 3.3 for duty cycle spectrum plot.



802.11n (40MHz)

CHANNEL	FREQUENCY (MHz)	PSD W/O DUTY FACTOR (dBm)	DUTY FACTOR	PSD WITH DUTY FACTOR (dBm)	MAXIMUM LIMIT (dBm)	PASS/FAIL
38	5190	-2.36	0.57	-1.79	4	PASS
46	5230	-1.95	0.57	-1.38	4	PASS
54	5270	-1.57	0.57	-1.00	11	PASS
62	5310	-2.29	0.57	-1.72	11	PASS
102	5510	-2.54	0.57	-1.97	11	PASS
110	5550	-2.47	0.57	-1.90	11	PASS
134	5670	-2.42	0.57	-1.85	11	PASS

NOTE: Refer to section 3.3 for duty cycle spectrum plot.

4.5 PEAK POWER EXCURSION MEASUREMENT

4.5.1 LIMITS OF PEAK POWER EXCURSION MEASUREMENT

Shall not exceed 13 dB.

4.5.2 TEST SETUP

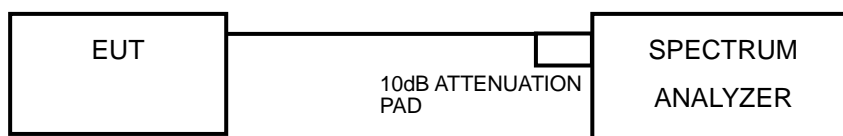

4.5.3 TEST INSTRUMENTS

Refer to section 4.1.3 to get information of above instrument.

4.5.4 TEST PROCEDURE

- 1) Set RBW = 1 MHz, VBW \geq 3 MHz, Detector = peak.
- 2) Trace mode = max-hold. Allow the sweeps to continue until the trace stabilizes.
- 3) Use the peak search function to find the peak of the spectrum.
- 4) Measure the PPSD.
- 5) Compute the ratio of the maximum of the peak-max-hold spectrum to the PPSD.

4.5.5 DEVIATION FROM TEST STANDARD

No deviation.

4.5.6 EUT OPERATING CONDITIONS

Same as 4.2.6

4.5.7 TEST RESULTS

802.11a

CHAN.	CHANNEL FREQUENCY (MHz)	PEAK VALUE (dBm)	PPSD WITHOUT DUTY FACTOR (dBm)	PPSD WITH DUTY FACTOR (dBm)	PEAK POWER EXCURSION (dB)	PEAK to AVERAGE EXCURSION LIMIT (dB)	PASS /FAIL
36	5180	12.56	3.17	3.38	9.18	13	PASS
44	5220	12.90	3.41	3.62	9.28	13	PASS
48	5240	13.29	3.63	3.84	9.45	13	PASS
52	5260	13.02	3.93	4.14	8.88	13	PASS
60	5300	13.33	4.22	4.43	8.90	13	PASS
64	5320	13.39	4.29	4.50	8.89	13	PASS
100	5500	13.67	3.94	4.15	9.52	13	PASS
116	5580	13.84	4.12	4.33	9.51	13	PASS
140	5700	13.79	4.09	4.30	9.49	13	PASS

NOTE: Refer to section 3.3 for duty cycle spectrum plot.

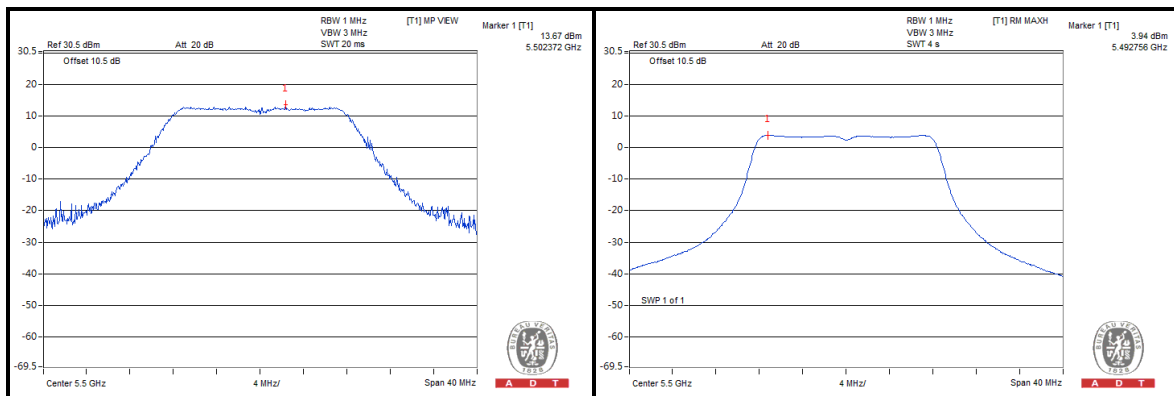

802.11n (20MHz)

CHAN.	CHANNEL FREQUENCY (MHz)	PEAK VALUE (dBm)	PPSD WITHOUT DUTY FACTOR (dBm)	PPSD WITH DUTY FACTOR (dBm)	PEAK POWER EXCURSION (dB)	PEAK to AVERAGE EXCURSION LIMIT (dB)	PASS /FAIL
36	5180	11.39	1.89	2.14	9.25	13	PASS
44	5220	11.65	2.18	2.43	9.22	13	PASS
48	5240	11.41	2.34	2.59	8.82	13	PASS
52	5260	12.23	2.63	2.88	9.35	13	PASS
60	5300	12.22	2.97	3.22	9.00	13	PASS
64	5320	13.26	3.18	3.43	9.83	13	PASS
100	5500	12.52	2.86	3.11	9.41	13	PASS
116	5580	12.45	3.06	3.31	9.14	13	PASS
140	5700	12.94	3.03	3.28	9.66	13	PASS

NOTE: Refer to section 3.3 for duty cycle spectrum plot.

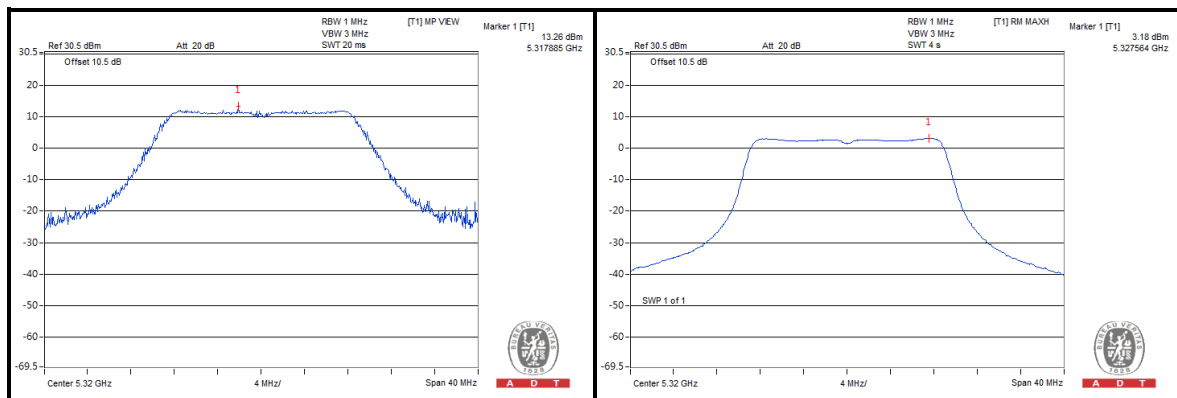

802.11n (40MHz)

CHAN.	CHANNEL FREQUENCY (MHz)	PEAK VALUE (dBm)	PPSD WITHOUT DUTY FACTOR (dBm)	PPSD WITH DUTY FACTOR (dBm)	PEAK POWER EXCURSION (dB)	PEAK to AVERAGE EXCURSION LIMIT (dB)	PASS /FAIL
38	5190	7.51	-2.36	-1.79	9.30	13	PASS
46	5230	8.57	-1.95	-1.38	9.95	13	PASS
54	5270	7.97	-1.57	-1.00	8.97	13	PASS
62	5310	7.36	-2.29	-1.72	9.08	13	PASS
102	5510	7.29	-2.54	-1.97	9.26	13	PASS
110	5550	7.07	-2.47	-1.90	8.97	13	PASS
134	5670	7.47	-2.42	-1.85	9.32	13	PASS

NOTE: Refer to section 3.3 for duty cycle spectrum plot.

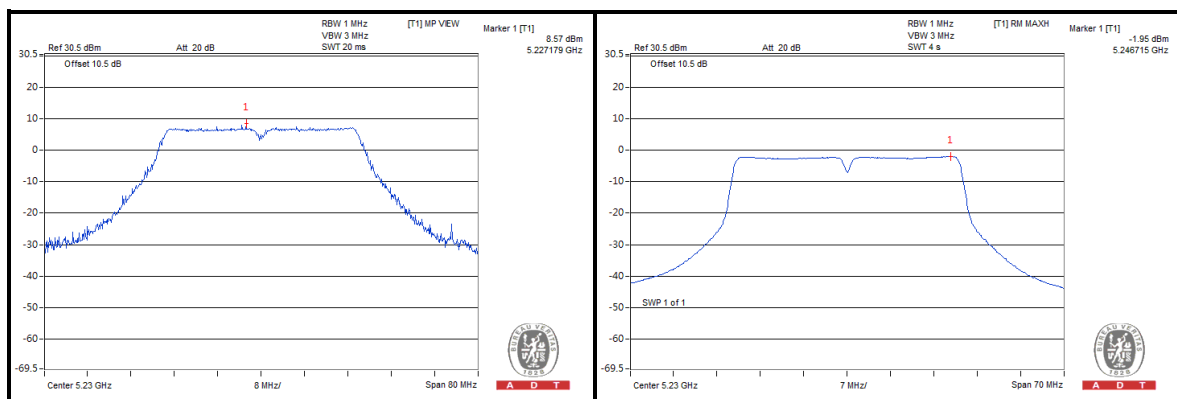

4.6 FREQUENCY STABILITY

4.6.1 LIMITS OF FREQUENCY STABILITY MEASUREMENT

The frequency of the carrier signal shall be maintained within band of operation

4.6.2 TEST SETUP

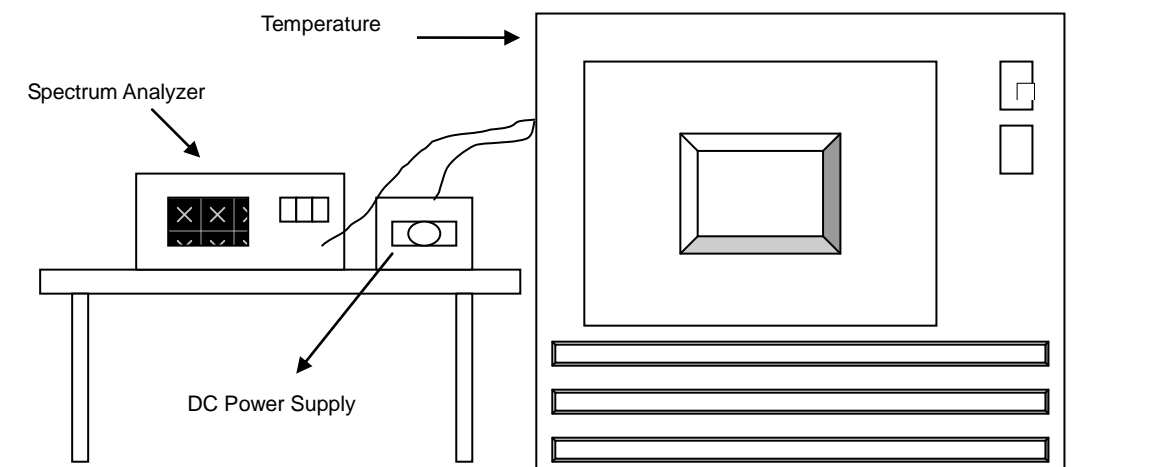

4.6.3 TEST INSTRUMENTS

Refer to section 4.1.3 to get information of above instrument.

4.6.4 TEST PROCEDURE

- a. To ensure emission at the band edge is maintained within the authorized band, those values shall be measured by radiation emissions at upper and lower frequency points, and finally compensated by frequency deviation as procedures below.
- b. The EUT was operated at the maximum output power, and connected to the spectrum analyzer, which is set to maximum hold function and peak detector. The peak value of the power envelope was measured and noted. The upper and lower frequency points were respectively measured relatively 10dB lower than the measured peak value.
- c. The frequency deviation was calculated by adding the upper frequency point and the lower frequency point divided by two. Those detailed values of frequency deviation are provided in table below.

4.6.5 DEVIATION FROM TEST STANDARD

No deviation.

4.6.6 EUT OPERATING CONDITION

Set the EUT transmit at un-modulation mode to test frequency stability.

4.6.7 TEST RESULTS

FREQUENCY STABILITY VERSUS TEMP.									
OPERATING FREQUENCY: 5320MHz									
TEMP. (°C)	POWER SUPPLY (Vdc)	0 MINUTE		2 MINUTE		5 MINUTE		10 MINUTE	
		Measured Frequency (MHz)	Frequency Drift (ppm)	Measured Frequency (MHz)	Frequency Drift (ppm)	Measured Frequency (MHz)	Frequency Drift (ppm)	Measured Frequency (MHz)	Frequency Drift (ppm)
50	3.8	5320.042408	7.971	5320.042102	7.914	5320.042160	7.925	5320.042225	7.937
40	3.8	5320.042986	8.080	5320.042789	8.043	5320.042945	8.072	5320.043114	8.104
30	3.8	5320.044018	8.274	5320.044202	8.309	5320.044263	8.320	5320.044147	8.298
20	3.8	5320.045306	8.516	5320.045021	8.463	5320.045081	8.474	5320.045354	8.525
10	3.8	5320.046659	8.770	5320.046705	8.779	5320.046843	8.805	5320.046412	8.724
0	3.8	5320.044919	8.443	5320.045179	8.492	5320.044625	8.388	5320.045360	8.526
-10	3.8	5320.042085	7.911	5320.042097	7.913	5320.042348	7.960	5320.041781	7.854

FREQUENCY STABILITY VERSUS VOLTAGE									
OPERATING FREQUENCY: 5320MHz									
TEMP. (°C)	POWER SUPPLY (Vac)	0 MINUTE		2 MINUTE		5 MINUTE		10 MINUTE	
		Measured Frequency (MHz)	Frequency Drift (ppm)	Measured Frequency (MHz)	Frequency Drift (ppm)	Measured Frequency (MHz)	Frequency Drift (ppm)	Measured Frequency (MHz)	Frequency Drift (ppm)
20	3.6	5320.044925	8.445	5320.045192	8.495	5320.044462	8.358	5320.045105	8.478
	3.8	5320.045306	8.516	5320.045021	8.463	5320.045081	8.474	5320.045354	8.525
	4.35	5320.046590	8.758	5320.046639	8.767	5320.046547	8.749	5320.045938	8.635

5. PHOTOGRAPHS OF THE TEST CONFIGURATION

Please refer to the attached file (Test Setup Photo).



6. INFORMATION ON THE TESTING LABORATORIES

We, Bureau Veritas Consumer Products Services (H.K.) Ltd., Taoyuan Branch, were founded in 1988 to provide our best service in EMC, Radio, Telecom and Safety consultation. Our laboratories are accredited and approved according to ISO/IEC 17025.

If you have any comments, please feel free to contact us at the following:

Linko EMC/RF Lab:

Tel: 886-2-26052180

Fax: 886-2-26051924

Hsin Chu EMC/RF Lab:

Tel: 886-3-5935343

Fax: 886-3-5935342

Hwa Ya EMC/RF/Safety Telecom Lab:

Tel: 886-3-3183232

Fax: 886-3-3270892

Email: service.adt@tw.bureauveritas.com

Web Site: www.bureauveritas-adt.com

The address and road map of all our labs can be found in our web site also.

7. APPENDIX A - MODIFICATIONS RECORDERS FOR ENGINEERING CHANGES TO THE EUT BY THE LAB

No modifications were made to the EUT by the lab during the test.

---END---