

A Test Lab Techno Corp.

Changan Lab : No. 140 -1, Changan Street, Bade City, Taoyuan County, Taiwan R.O.C.

Tel : 886-3-271-0188 / Fax : 886-3-271-0190

SAR EVALUATION REPORT



Test Report No.	:	1207FS14
Applicant	:	HTC Corporation
Product Type	:	Smartphone
Trade Name	:	HTC
Model Number	:	PM66100
Date of Received	:	Jun. 25, 2012
Dates of Test	:	Jun. 26 ~ Jul. 05, 2012
Date of Issued	:	Jul. 23, 2012
Test Environment	:	Ambient Temperature : 22 ± 2 ° C Relative Humidity : 40 - 70 %
Standard	:	ANSI/IEEE C95.1-1999 IEEE Std. 1528-2003 47 CFR Part §2.1093; FCC/OET Bulletin 65 Supplement C [July 2001]
Max. SAR	:	1.040 W/kg Head SAR 1.350 W/kg Body SAR
Test Lab Location	:	Chang-an Lab

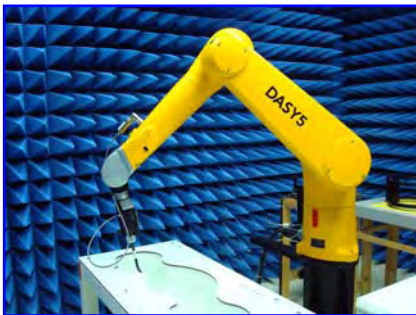

1. The test operations have to be performed with cautious behavior, the test results are as attached.
2. The test results are under chamber environment of A Test Lab Techno Corp. A Test Lab Techno Corp. does not assume responsibility for any conclusions and generalizations drawn from the test results with regard to other specimens or samples.
3. The measurement report has to be written approval of A Test Lab Techno Corp. It may only be reproduced or published in full. This report shall not be reproduced except in full, without the written approval of A Test Lab Techno Corp. The test results in the report only apply to the tested sample.

Approved By : Yung-Tan Tsai Tested By : Bill Hu
(Yung Tan Tsai) (Bill Hu)



Contents

1. Description of Equipment under Test (EUT)	3
2. Introduction	4
2.1 SAR Definition	4
3. SAR Measurement Setup	5
3.1 DASY5 E-Field Probe System	6
3.2 Data Acquisition Electronic (DAE) System.....	9
3.3 Robot.....	9
3.4 Measurement Server.....	9
3.5 Device Holder.....	10
3.6 Phantom - SAM v4.0	10
3.7 Oval Flat Phantom - ELI 4.0.....	11
3.8 Data Storage and Evaluation	11
4. Tissue Simulating Liquids	14
4.1 Ingredients	15
4.2 Recipes	15
4.3 Liquid Confirmation	16
5. SAR Testing with RF Transmitters	19
5.1 SAR Testing with DTM Mode	19
5.2 SAR Testing with HSDPA Transmitters	20
5.3 SAR Testing with 802.11 Transmitters	23
5.4 Conducted Power.....	24
5.5 Simultaneous Transmitting Evaluate.....	29
6. System Performance Check	39
6.1 Symmetric Dipoles for System Verification	39
6.2 Verification.....	40
7. Test Equipment List.....	47
8. Measurement Uncertainty.....	48
9. Measurement Procedure	50
9.1 Spatial Peak SAR Evaluation	50
9.2 Area & Zoom Scan Procedures	51
9.3 Volume Scan Procedures	51
9.4 SAR Averaged Methods.....	51
9.5 Power Drift Monitoring.....	51
10. SAR Test Results Summary.....	52
10.1 Head SAR	52
10.2 Body SAR.....	54
10.3 Std. C95.1-1999 RF Exposure Limit	56
11. Conclusion	57
12. References.....	57
Appendix A - System Performance Check	58
Appendix B - SAR Measurement Data	68
Appendix C - Calibration	152



1. Description of Equipment under Test (EUT)

Applicant	HTC Corporation	
Applicant Address	No. 23, Xinghua Rd., Taoyuan City, Taoyuan County 330, Taiwan	
Manufacture	HTC Corporation	
Manufacture Address	No. 23, Xinghua Rd., Taoyuan City, Taoyuan County 330, Taiwan	
Product Type	Smartphone	
Trade Name	HTC	
Model Number	PM66100	
IMEI Number	358835040010495	
FCC ID	NM8PM66100	
RF Function	GSM/GPRS/EGPRS/DTM 850 (Device Class A, Multi-slot Class 12) GSM/GPRS/EGPRS/DTM 1900 (Device Class A, Multi-slot Class 12) WCDMA(RMC 12.2K) / HSDPA / HSUPA Band V IEEE 802.11b / 802.11g / draft 802.11n 2.4GHz Standard-20MHz Bluetooth 3.0 / Bluetooth v4.0 LE	
Tx Frequency	Band	Operate Frequency (MHz)
	GSM/GPRS/EGPRS/DTM 850	824.2 - 848.8
	GSM/GPRS/EGPRS/DTM 1900	1850.2 - 1909.8
	WCDMA (RMC 12.2K) / HSDPA / HSUPA Band V	826.4 - 846.6
	IEEE 802.11b / 802.11g	2412 - 2462
	draft 802.11n 2.4GHz Standard-20MHz	2412 - 2462
	Bluetooth v3.0 / Bluetooth v4.0 LE	2402 - 2480
RF Conducted Power (Avg.)	Band	Power (W / dBm)
	GSM/GPRS/EGPRS/DTM 850	2.218 / 33.46
	GSM/GPRS/EGPRS/DTM 1900	1.005 / 30.02
	WCDMA (RMC 12.2K) / HSDPA / HSUPA Band V	0.182 / 22.60
	IEEE 802.11b	0.064 / 18.07
	IEEE 802.11g	0.017 / 12.41
	draft 802.11n 2.4GHz Standard-20MHz	0.017 / 12.26
	Bluetooth v3.0	0.001 / -1.09
Bluetooth v4.0 LE	0.001 / 0.25	
Max. SAR Measurement	1.040 W/kg Head SAR 1.350 W/kg Body SAR	
Antenna Type	PIFA Type	
Device Category	Portable Device	
RF Exposure Environment	General Population / Uncontrolled	
Application Type	Certification	

This wireless portable device has been shown to be capable of compliance for localized specific absorption rate (SAR) for uncontrolled environment / general population exposure limits specified in Standard C95.1-1999 and had been tested in accordance with the measurement procedures specified in IEEE Std. 1528-2003.

2. Introduction

The A Test Lab Techno Corp. has performed measurements of the maximum potential exposure to the user of **HTC Corporation Trade Name : HTC Model(s) : PM66100**. The test procedures, as described in American National Standards, Institute C95.1-1999 [1] , FCC/OET Bulletin 65 Supplement C [July 2001] were employed and they specify the maximum exposure limit of 1.6mW/g as averaged over any 1 gram of tissue for portable devices being used within 20cm between user and EUT in the uncontrolled environment. A description of the product and operating configuration, detailed summary of the test results, methodology and procedures used in the equipment used are included within this test report.

2.1 SAR Definition

Specific Absorption Rate (SAR) is defined as the time derivative (rate) of the incremental energy (dw) absorbed by (dissipated in) an incremental mass (dm) contained in a volume element (dv) of a given density (ρ). It is also defined as the rate of RF energy absorption per unit mass at a point in an absorbing body (see Figure 2).

$$\text{SAR} = \frac{d}{dt} \left(\frac{dw}{dm} \right) = \frac{d}{dt} \left(\frac{dw}{\rho dv} \right)$$

Figure 2. SAR Mathematical Equation

SAR is expressed in units of Watts per kilogram (W/kg)

$$\text{SAR} = \frac{\sigma E^2}{\rho}$$

Where :

σ = conductivity of the tissue (S/m)

ρ = mass density of the tissue (kg/m³)

E = RMS electric field strength (V/m)

* Note :

The primary factors that control rate of energy absorption were found to be the wavelength of the incident field in relations to the dimensions and geometry of the irradiated organism, the orientation of the organism in relation to the polarity of field vectors, the presence of reflecting surfaces, and whether conductive contact is made by the organism with a ground plane [2]

3. SAR Measurement Setup

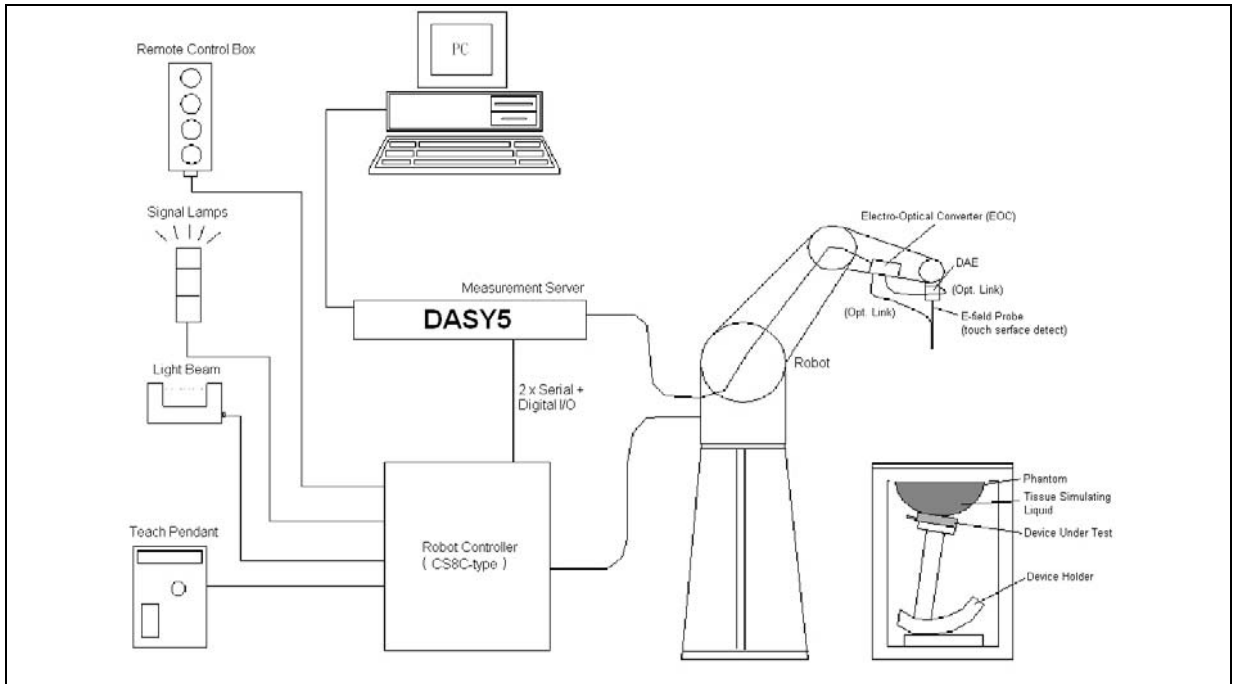

The DASY5 system for performing compliance tests consists of the following items:

1. A standard high precision 6-axis robot (Stäubli TX family) with controller, teach pendant and software. An arm extension for accommodating the data acquisition electronics (DAE).
2. A dosimetric probe, i.e., an isotropic E-field probe optimized and calibrated for usage in tissue simulating liquid. The probe is equipped with an optical surface detector system.
3. A data acquisition electronics (DAE) which performs the signal amplification, signal multiplexing, AD-conversion, offset measurements, mechanical surface detection, collision detection, etc. The unit is battery powered with standard or rechargeable batteries. The signal is optically transmitted to the EOC.
4. The function of the measurement server is to perform the time critical tasks such as signal filtering, control of the robot operation and fast movement interrupts.
5. A probe alignment unit which improves the (absolute) accuracy of the probe positioning.
6. A computer operating Windows 2000 or Windows XP.
7. DASY5 software.
8. Remote controls with teach pendant and additional circuitry for robot safety such as warning lamps, etc.
9. The SAM twin phantom enabling testing left-hand and right-hand usage.
10. The device holder for handheld mobile phones.
11. Tissue simulating liquid mixed according to the given recipes.
12. Validation dipole kits allowing validating the proper functioning of the system.



3.1 DASYS E-Field Probe System

The SAR measurements were conducted with the dosimetric probe EX3DV4 (manufactured by SPEAG), designed in the classical triangular configuration (3) and optimized for dosimetric evaluation. The probe is constructed using the thick film technique; with printed resistive lines on ceramic substrates. The probe is equipped with an optical multi-fiber line ending at the front of the probe tip. It is connected to the EOC box on the robot arm and provides an automatic detection of the phantom surface. Half of the fibers are connected to a pulsed infrared transmitter, the other half to a synchronized receiver. As the probe approaches the surface, the reflection from the surface produces a coupling from the transmitting to the receiving fibers. This reflection increases first during the approach, reaches maximum and then decreases. If the probe is flatly touching the surface, the coupling is zero. The distance of the coupling maximum to the surface is independent of the surface reflectivity and largely independent of the surface to probe angle. The DASYS software reads the reflection during a software approach and looks for the maximum using a 2nd order fitting. The approach is stopped when reaching the maximum.

3.1.1 E-Field Probe Specification

Construction	<p>Symmetrical design with triangular core</p> <p>Built-in optical fiber for surface detection System</p> <p>Built-in shielding against static charges</p> <p>PEEK enclosure material (resistant to organic solvents, e.q., glycol)</p>
Calibration	<p>In air from 10 MHz to 6 GHz</p> <p>In brain and muscle simulating tissue at frequencies of 835MHz, 1900MHz and 2450MHz (accuracy $\pm 8\%$)</p> <p>Calibration for other liquids and frequencies upon request</p>
Frequency	± 0.2 dB (30 MHz to 6 GHz) for EX3DV4
Directivity	<p>± 0.3 dB in brain tissue (rotation around probe axis)</p> <p>± 0.5 dB in brain tissue (rotation normal probe axis)</p>
Dynamic Range	10 μ W/g to > 100mW/g; Linearity: ± 0.2 dB
Dimensions	<p>Overall length: 337mm</p> <p>Tip length: 20mm</p> <p>Body diameter: 12mm</p> <p>Tip diameter: 2.5mm for EX3DV4</p> <p>Distance from probe tip to dipole centers: 1.0mm for EX3DV4</p>
Application	<p>General dosimetry up to 6GHz</p> <p>Compliance tests of mobile phones</p> <p>Fast automatic scanning in arbitrary phantoms</p>

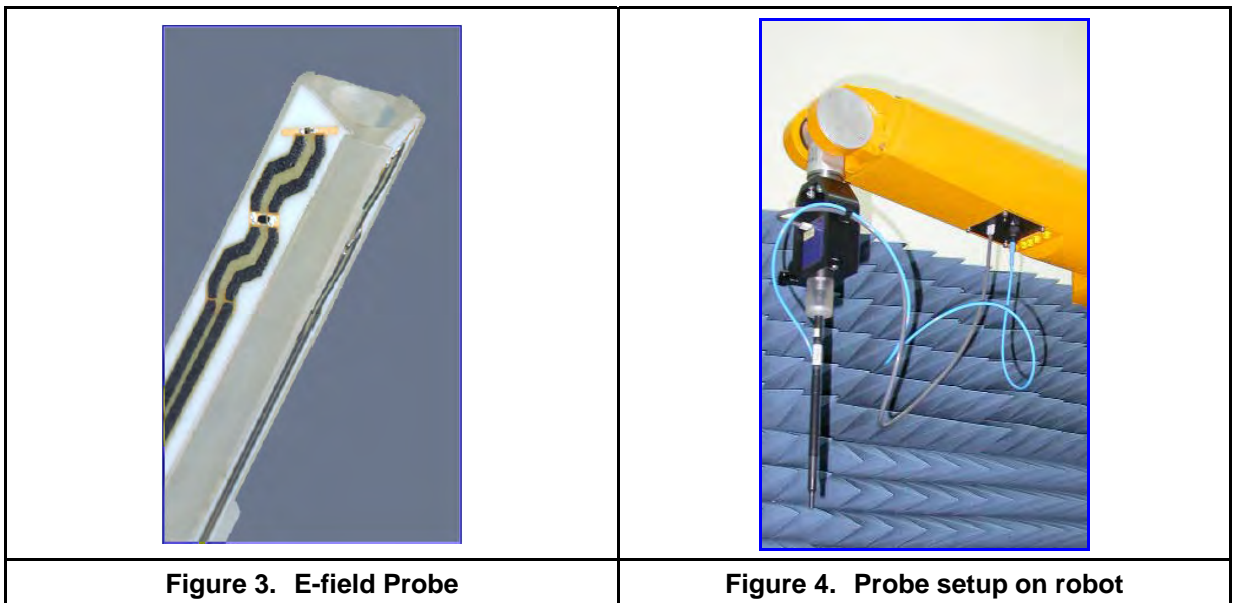



3.1.2 E-Field Probe Calibration process

Dosimetric Assessment Procedure

Each E-Probe/Probe Amplifier combination has unique calibration parameters. A TEM cell calibration procedure is conducted to determine the proper amplifier settings to enter in the probe parameters. The amplifier settings are determined for a given frequency by subjecting the probe to a known E-field density (1 mW/cm²) using an RF Signal generator, TEM cell, and RF Power Meter.

Free Space Assessment

The free space E-field from amplified probe outputs is determined in a test chamber. This calibration can be performed in a TEM cell if the frequency is below 1 GHz and in a waveguide or other methodologies above 1 GHz for free space. For the free space calibration, the probe is placed in the volumetric center of the cavity and at the proper orientation with the field. The probe is rotated 360 degrees until the three channels show the maximum reading. The power density readings equates to 1 mW/cm².

Temperature Assessment

E-field temperature correlation calibration is performed in a flat phantom filled with the appropriate simulated head tissue. The E-field in the medium correlates with the temperature rise in the dielectric medium. For temperature correlation calibration a RF transparent thermistor-based temperature probe is used in conjunction with the E-field probe.

$$\text{SAR} = C \frac{\Delta T}{\Delta t}$$

Where :

- Δt = Exposure time (30 seconds),
- C = Heat capacity of tissue (head or body),
- ΔT = Temperature increase due to RF exposure.

$$\text{Or } \text{SAR} = \frac{|E|^2 \sigma}{\rho}$$

Where :

- σ = Simulated tissue conductivity,
- ρ = Tissue density (kg/m³).



3.2 Data Acquisition Electronic (DAE) System

Cell Controller

Processor : Intel Core(TM)2 CPU
Clock Speed : @ 1.86GHz
Operating System : Windows XP Professional

Data Converter

Features : Signal Amplifier, multiplexer, A/D converter, and control logic
Software : DASY5 v5.0 (Build 125) & SEMCAD X Version 13.4 Build 125
Connecting Lines : Optical downlink for data and status info
Optical uplink for commands and clock

3.3 Robot

Positioner : Stäubli Unimation Corp. Robot Model: TX90XL
Repeatability : ± 0.02 mm
No. of Axis : 6

3.4 Measurement Server

Processor : PC/104 with a 400MHz intel ULV Celeron
I/O-board : Link to DAE4 (or DAE3)
16-bit A/D converter for surface detection system
Digital I/O interface
Serial link to robot
Direct emergency stop output for robot

3.5 Device Holder

The DASY device holder is constructed of low-loss POM material having the following dielectric parameters: relative permittivity $\epsilon=3$ and loss tangent $\delta=0.02$. The amount of dielectric material has been reduced in the closest vicinity of the device, since measurements have suggested that the influence of the clamp on the test results could thus be lowered.

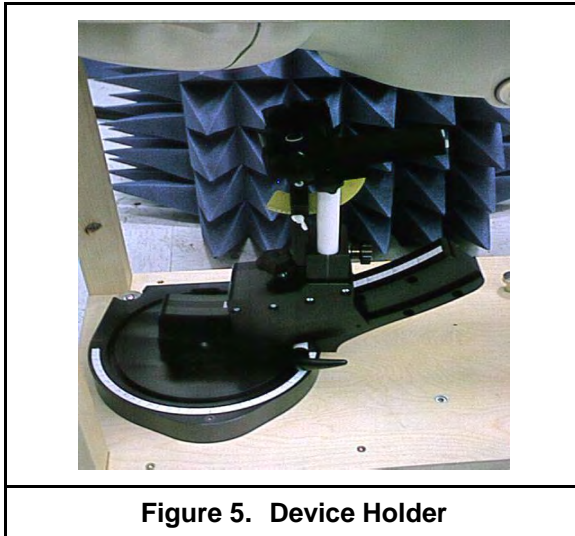

Figure 5. Device Holder

3.6 Phantom - SAM v4.0

The shell corresponds to the specifications of the Specific Anthropomorphic Mannequin (SAM) phantom defined in IEEE 1528 and IEC 62209. It enables the dosimetric evaluation of left and right hand phone usage as well as body mounted usage at the flat phantom region. A cover prevents evaporation of the liquid. Reference markings on the phantom allow the complete setup of all predefined phantom positions and measurement grids by manually teaching three points with the robot.

Shell Thickness	2 ±0.2 mm
Filling Volume	Approx. 25 liters
Dimensions	1000x500 mm (LxW)
Table 1. Specification of SAM v4.0	



Figure 6. SAM Twin Phantom

3.7 Oval Flat Phantom - ELI 4.0

The shell corresponds to the specifications of the Specific Anthropomorphic Mannequin (Oval Flat) phantom defined in IEEE 1528-2003, CENELEC 50361 and IEC 62209. It enables the dosimetric evaluation of wireless portable device usage as well as body mounted usage at the flat phantom region. A cover prevents evaporation of the liquid. Reference markings on the phantom allow the complete setup of all predefined phantom positions and measurement grids by manually teaching three points with the robot.

Shell Thickness	2 ±0.2 mm
Filling Volume	Approx. 30 liters
Dimensions	190×600×400 mm (H×L×W)
Table 2. Specification of ELI 4.0	

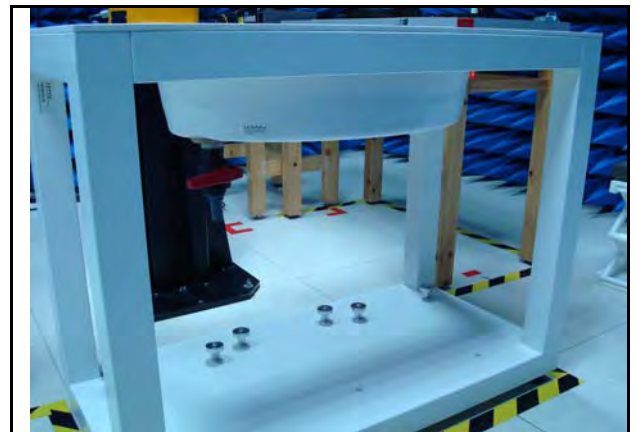

Figure 7. Oval Flat Phantom

3.8 Data Storage and Evaluation

3.8.1 Data Storage

The DASY5 software stores the assessed data from the data acquisition electronics as raw data (in microvolt readings from the probe sensors), together with all the necessary software parameters for the data evaluation (probe calibration data, liquid parameters and device frequency and modulation data) in measurement files with the extension DA5. The post processing software evaluates the desired unit and format for output each time the data is visualized or exported. This allows verification of the complete software setup even after the measurement and allows correction of erroneous parameter settings. For example, if a measurement has been performed with an incorrect crest factor parameter in the device setup, the parameter can be corrected afterwards and the data can be reevaluated.



3.8.2 Data Evaluation

The DASY5 post processing software (SEMCAD) automatically executes the following procedures to calculate the field units from the microvolt readings at the probe connector. The parameters used in the evaluation are stored in the configuration modules of the software :

- Probe parameters :**
- Sensitivity Normi, ai0, ai1, ai2
 - Conversion factor ConvFi
 - Diode compression point dcp_i
- Device parameters :**
- Frequency f
 - Crest factor cf
- Media parameters :**
- Conductivity σ
 - Density ρ

These parameters must be set correctly in the software. They can be found in the component documents or they can be imported into the software from the configuration files issued for the DASY components. In the direct measuring mode of the multimeter option, the parameters of the actual system setup are used. In the scan visualization and export modes, the parameters stored in the corresponding document files are used.

The first step of the evaluation is a linearization of the filtered input signal to account for the compression characteristics of the detector diode. The compensation depends on the input signal, the diode type and the DC-transmission factor from the diode to the evaluation electronics. If the exciting field is pulsed, the crest factor of the signal must be known to correctly compensate for peak power. The formula for each channel can be given as :

$$V_i = U_i + U_i^2 \cdot \frac{cf}{dcp_i}$$

- with V_i = compensated signal of channel i ($i = x, y, z$)
- U_i = input signal of channel i ($i = x, y, z$)
- cf = crest factor of exciting field (DASY parameter)
- dcp_i = diode compression point (DASY parameter)

From the compensated input signals the primary field data for each channel can be evaluated :

E-field probes :
$$E_i = \sqrt{\frac{V_i}{Norm_i \cdot ConvF}}$$

$$H_i = \sqrt{V_i} \cdot \frac{a_{i0} + a_{i1}f + a_{i2}f^2}{f}$$

H-field probes :

with V_i = compensated signal of channel i ($i = x, y, z$)

$Norm_i$ = sensor sensitivity of channel i ($i = x, y, z$)

$\mu V/(V/m)^2$ for E-field Probes

$ConvF$ = sensitivity enhancement in solution

a_{ij} = sensor sensitivity factors for H-field probes

f = carrier frequency [GHz]

E_i = electric field strength of channel i in V/m

Hi = magnetic field strength of channel i in A/m

The RSS value of the field components gives the total field strength (Hermitian magnitude) :

$$E_{tot} = \sqrt{E_x^2 + E_y^2 + E_z^2}$$

The primary field data are used to calculate the derived field units.

$$SAR = E_{tot}^2 \cdot \frac{\sigma}{\rho \cdot 1000}$$

with SAR = local specific absorption rate in mW/g

E_{tot} = total field strength in V/m

σ = conductivity in [mho/m] or [Siemens/m]

ρ = equivalent tissue density in g/cm^3

***Note :** That the density is set to 1, to account for actual head tissue density rather than the density of the tissue simulating liquid.

The power flow density is calculated assuming the excitation field to be a free space field.

$$P_{pwe} = \frac{E_{tot}^2}{3770} \quad \text{or} \quad P_{pwe} = \frac{H_{tot}^2}{37.7}$$

with P_{pwe} = equivalent power density of a plane wave in mW/cm^2

E_{tot} = total electric field strength in V/m

H_{tot} = total magnetic field strength in A/m



4. Tissue Simulating Liquids

The mixture is calibrated to obtain proper dielectric constant (permittivity) and conductivity of the tissue. The dielectric parameters of the liquids were verified prior to the SAR evaluation using an 85070C Dielectric Probe Kit and an E5071B Network Analyzer.

IEEE SCC-34/SC-2 in 1528 recommended Tissue Dielectric Parameters

The head tissue dielectric parameters recommended by the IEEE SCC-34/SC-2 in 1528 have been incorporated in the following table. These head parameters are derived from planar layer models simulating the highest expected SAR for the dielectric properties and tissue thickness variations in human head. Other head and body tissue parameters that have not been specified in 1528 are derived from the tissue dielectric parameters computed from the 4-Cole-Cole equation and extrapolated according to the head parameter specified in 1528.

Target Frequency (MHz)	Head		Body	
	ϵ_r	σ (S/m)	ϵ_r	σ (S/m)
150	52.3	0.76	61.9	0.80
300	45.3	0.87	58.2	0.92
450	43.5	0.87	56.7	0.94
835	41.5	0.90	55.2	0.97
900	41.5	0.97	55.0	1.05
915	41.5	0.98	55.0	1.06
1450	40.5	1.20	54.0	1.30
1610	40.3	1.29	53.8	1.40
1800 - 2000	40.0	1.40	53.3	1.52
2450	39.2	1.80	52.7	1.95
3000	38.5	2.40	52.0	2.73
5800	35.3	5.27	48.2	6.00

(ϵ_r = relative permittivity, σ = conductivity and $\rho = 1000 \text{ kg/m}^3$)

Table 3. Tissue dielectric parameters for head and body phantoms



4.1 Ingredients

The following ingredients are used:

- Water: deionized water (pure H₂O), resistivity $\geq 16 \text{ M } \Omega$ -as basis for the liquid
- Sugar: refined white sugar (typically 99.7 % sucrose, available as crystal sugar in food shops)
-to reduce relative permittivity
- Salt: pure NaCl -to increase conductivity
- Cellulose: Hydroxyethyl-cellulose, medium viscosity (75-125 mPa.s, 2% in water, 20 °C), CAS # 54290 -to increase viscosity and to keep sugar in solution.
- Preservative: Preventol D-7 Bayer AG, D-51368 Leverkusen, CAS # 55965-84-9 -to prevent the spread of bacteria and molds
- DGBE: Diethylenglycol-monobutyl ether (DGBE), Fluka Chemie GmbH, CAS # 112-34-5 -to reduce relative permittivity

4.2 Recipes

The following tables give the recipes for tissue simulating liquids to be used in different frequency bands.

Note: The goal dielectric parameters (at 22 °C) must be achieved within a tolerance of $\pm 5\%$ for ϵ and $\pm 5\%$ for σ .

Ingredients (% by weight)	Frequency (MHz)									
	450		835		915		1900		2450	
Tissue Type	Head	Body	Head	Body	Head	Body	Head	Body	Head	Body
Water	38.56	51.16	41.45	52.4	41.05	56.0	54.9	40.4	62.7	73.2
Salt (NaCl)	3.95	1.49	1.45	1.4	1.35	0.76	0.18	0.5	0.5	0.04
Sugar	56.32	46.78	56.0	45.0	56.5	41.76	0.0	58.0	0.0	0.0
HEC	0.98	0.52	1.0	1.0	1.0	1.21	0.0	1.0	0.0	0.0
Bactericide	0.19	0.05	0.1	0.1	0.1	0.27	0.0	0.1	0.0	0.0
Triton X-100	0.0	0.0	0.0	0.0	0.0	0.0	0.0	0.0	36.8	0.0
DGBE	0.0	0.0	0.0	0.0	0.0	0.0	44.92	0.0	0.0	26.7
Dielectric Constant	43.42	58.0	42.54	56.1	42.0	56.8	39.9	54.0	39.8	52.5
Conductivity (S/m)	0.85	0.83	0.91	0.95	1.0	1.07	1.42	1.45	1.88	1.78

Salt: 99+% Pure Sodium Chloride Sugar: 98+% Pure Sucrose

Water: De-ionized, $16 \text{ M } \Omega$ resistivity HEC: Hydroxyethyl Cellulose

DGBE: 99+% Di(ethylene glycol) butyl ether, [2-(2-butoxyethoxy)ethanol]

Triton X-100 (ultra pure): Polyethylene glycol mono [4-(1,1, 3, 3-tetramethylbutyl)phenyl]ether



4.3 Liquid Confirmation

4.3.1 Parameters

Liquid Verify								
Ambient Temperature : 22 ± 2 °C ; Relative Humidity : 40 -70%								
Liquid Type	Frequency	Temp (°C)	Parameters	Target Value	Measured Value	Deviation (%)	Limit (%)	Measured Date
835MHz Head	820MHz	22.0	ϵ_r	41.50	41.01	-1.18 %	± 5	06/26/2012
			σ	0.90	0.898	-0.22 %	± 5	
	835MHz	22.0	ϵ_r	41.50	40.99	-1.23 %	± 5	
			σ	0.90	0.913	1.44 %	± 5	
	850MHz	22.0	ϵ_r	41.50	40.90	-1.45 %	± 5	
			σ	0.90	0.928	3.11 %	± 5	
835MHz Head	820MHz	22.0	ϵ_r	41.50	41.01	-1.18 %	± 5	07/05/2012
			σ	0.90	0.898	-0.22 %	± 5	
	835MHz	22.0	ϵ_r	41.50	40.99	-1.23 %	± 5	
			σ	0.90	0.913	1.44 %	± 5	
	850MHz	22.0	ϵ_r	41.50	40.90	-1.45 %	± 5	
			σ	0.90	0.928	3.11 %	± 5	
1900MHz Head	1850MHz	22.0	ϵ_r	40.00	39.19	-2.03 %	± 5	06/27/2012
			σ	1.40	1.344	-4.00 %	± 5	
	1900MHz	22.0	ϵ_r	40.00	39.03	-2.43 %	± 5	
			σ	1.40	1.388	-0.86 %	± 5	
	1930MHz	22.0	ϵ_r	40.00	38.93	-2.68 %	± 5	
			σ	1.40	1.414	1.00 %	± 5	
1900MHz Head	1850MHz	22.0	ϵ_r	40.00	39.19	-2.03 %	± 5	06/28/2012
			σ	1.40	1.344	-4.00 %	± 5	
	1900MHz	22.0	ϵ_r	40.00	39.03	-2.43 %	± 5	
			σ	1.40	1.388	-0.86 %	± 5	
	1930MHz	22.0	ϵ_r	40.00	38.93	-2.68 %	± 5	
			σ	1.40	1.414	1.00 %	± 5	
2450MHz Head	2400MHz	22.0	ϵ_r	39.20	39.72	1.33 %	± 5	07/03/2012
			σ	1.80	1.755	-2.50 %	± 5	
	2450MHz	22.0	ϵ_r	39.20	39.49	0.74 %	± 5	
			σ	1.80	1.810	0.56 %	± 5	
	2500MHz	22.0	ϵ_r	39.20	39.40	0.51 %	± 5	
			σ	1.80	1.862	3.44 %	± 5	

Table 4. Measured Tissue dielectric parameters for head phantoms



Liquid Verify								
Ambient Temperature : 22 ± 2 °C ; Relative Humidity : 40 -70%								
Liquid Type	Frequency	Temp (°C)	Parameters	Target Value	Measured Value	Deviation (%)	Limit (%)	Measured Date
835MHz Body	820MHz	22.0	ϵ_r	55.20	55.11	-0.16 %	± 5	06/28/2012
			σ	0.97	0.976	0.62 %	± 5	
	835MHz	22.0	ϵ_r	55.20	55.06	-0.25 %	± 5	
			σ	0.97	0.990	2.06 %	± 5	
	850MHz	22.0	ϵ_r	55.20	54.99	-0.38 %	± 5	
			σ	0.97	1.006	3.71 %	± 5	
1900MHz Body	1850MHz	22.0	ϵ_r	53.30	51.11	-4.11 %	± 5	06/29/2012
			σ	1.52	1.464	-3.68 %	± 5	
	1900MHz	22.0	ϵ_r	53.30	51.05	-4.22 %	± 5	
			σ	1.52	1.489	-2.04 %	± 5	
	1930MHz	22.0	ϵ_r	53.30	50.88	-4.54 %	± 5	
			σ	1.52	1.533	0.86 %	± 5	
1900MHz Body	1850MHz	22.0	ϵ_r	53.30	51.11	-4.11 %	± 5	07/01/2012
			σ	1.52	1.464	-3.68 %	± 5	
	1900MHz	22.0	ϵ_r	53.30	51.05	-4.22 %	± 5	
			σ	1.52	1.489	-2.04 %	± 5	
	1930MHz	22.0	ϵ_r	53.30	50.88	-4.54 %	± 5	
			σ	1.52	1.533	0.86 %	± 5	
2450MHz Body	2400MHz	22.0	ϵ_r	52.70	51.38	-2.50 %	± 5	07/02/2012
			σ	1.95	1.889	-3.13 %	± 5	
	2450MHz	22.0	ϵ_r	52.70	51.23	-2.79 %	± 5	
			σ	1.95	1.977	1.38 %	± 5	
	2500MHz	22.0	ϵ_r	52.70	51.07	-3.09 %	± 5	
			σ	1.95	2.026	3.90 %	± 5	
2450MHz Body	2400MHz	22.0	ϵ_r	52.70	51.38	-2.50 %	± 5	07/03/2012
			σ	1.95	1.889	-3.13 %	± 5	
	2450MHz	22.0	ϵ_r	52.70	51.23	-2.79 %	± 5	
			σ	1.95	1.977	1.38 %	± 5	
	2500MHz	22.0	ϵ_r	52.70	51.07	-3.09 %	± 5	
			σ	1.95	2.026	3.90 %	± 5	

Table 5. Measured Tissue dielectric parameters for body phantoms

4.3.2 Liquid Depth

The liquid level was during measurement 15cm \pm 0.5cm.

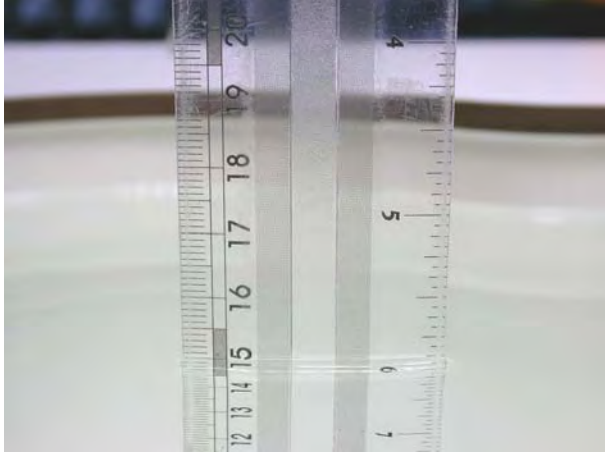

Figure 8. Head-Tissue-Simulating-Liquid



Figure 9. Body-Tissue-Simulating-Liquid

5. SAR Testing with RF Transmitters

5.1 SAR Testing with DTM Mode

DTM Mode setup for SAR Measurement.

When devices have DTM function, the number of uplink, the numbers of downlink are defined by DTM class. Table as below:

Table 9-1 DTM multislot classes

Multislot class	Maximum number of slots		Sum
	Downlink (MS RX)	Uplink (MS TX)	
5	2	2	4
6	3	2	4
9	3	2	5
10	4	2	5
11	4	3	5

The DTM mode is GSM & GPRS used at the same time, therefore GSM has 1Tx 1Rx, The Sum deduct 1Tx 1Rx, others are GPRS configuration, EX: DTM Class 11

The Sum is 5, maximum Tx is 3, therefore 2 Downlink 3 Uplink is max transmission. Before link DTM, make sure GSM & GPRS setting, like DTM Class 11, for GSM use 1Down1Up for GPRS use 1Down2Up, and follow chart as below, first link GSM next link GPRS:

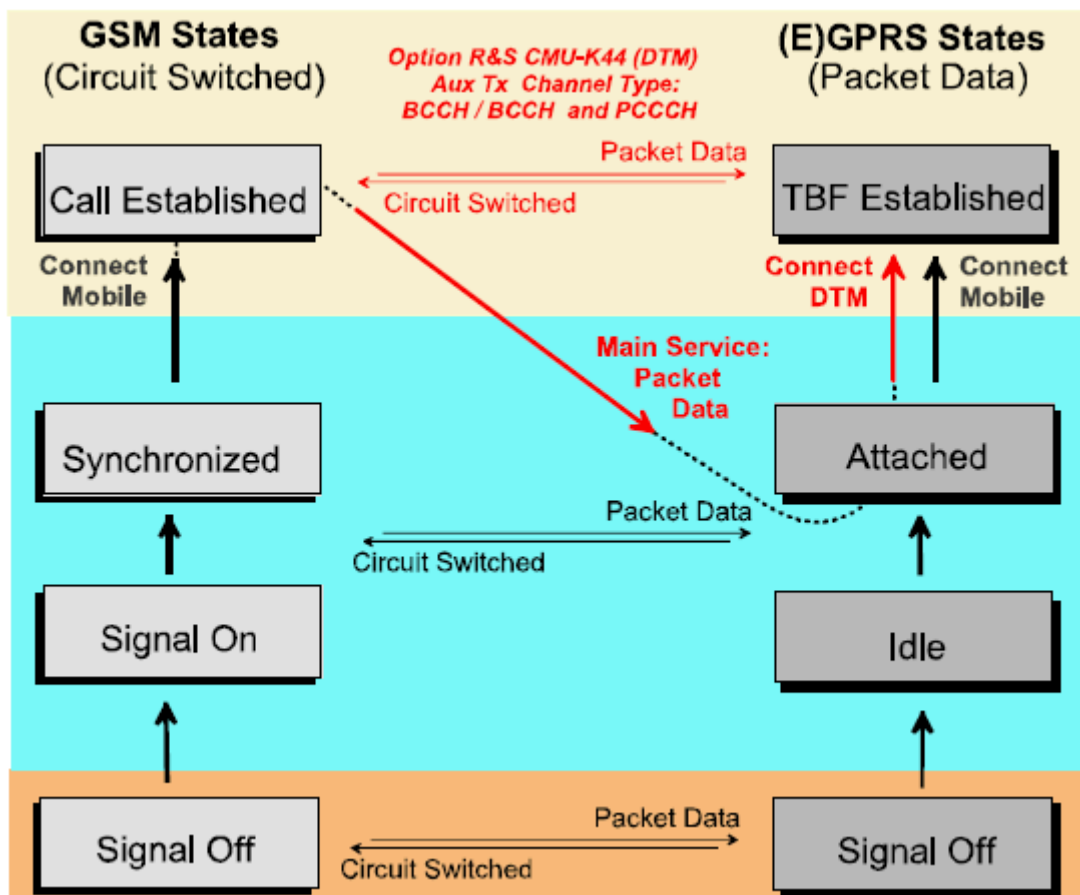

5.2 SAR Testing with HSDPA Transmitters

HSDPA Data Devices setup for SAR Measurement.

HSDPA should be configured according to the UE category of a test device. The number of HS-DSCH/HS-PDSCHs, HARQ processes, minimum inter-TTI interval, transport block sizes and RV coding sequence are defined by the H-set. To maintain a consistent test configuration and stable transmission conditions, QPSK is used in the H-set for SAR testing. HS-DPCCH should be configured with a CQI feedback cycle of 4 ms with a CQI repetition factor of 2 to maintain a constant rate of active CQI slots. DPCCH and DPDCH gain factors (β_c , β_d), and HS-DPCCH power offset parameters (Δ_{ACK} , Δ_{NACK} , Δ_{CQI}) should be set according to values indicated in the Table below.³² The CQI value is determined by the UE category, transport block size, number of HS-PDSCHs and modulation used in the H-set.³³

Sub-test	β_c	β_d	β_d (SF)	β_c/β_d	$\beta_{hs}^{(1,2)}$	CM (dB) ⁽³⁾	MRP (dB) ⁽³⁾
1	2/15	15/15	64	2/15	4/15	0.0	0.0
2	12/15 ⁽⁴⁾	15/15 ⁽⁴⁾	64	12/15 ⁽⁴⁾	24/15	1.0	0.0
3	15/15	8/15	64	15/8	30/15	1.5	0.5
4	15/15	4/15	64	15/4	30/15	1.5	0.5

Note

1. Δ_{ACK} , Δ_{NACK} and $\Delta_{CQI} = 8 \Leftrightarrow A_{hs} = \beta_{hs}/\beta_c = 30/15 \Leftrightarrow \beta_{hs} = 30/15 * \beta_c$
2. For the HS-DPCCH power mask requirement test in clause 5.2C, 5.7A, and the Error Vector Magnitude (EVM) with HS-DPCCH test in clause 5.13.1A and HSDPA EVM with phase discontinuity in clause 5.13.1AA, Δ_{ACK} and $\Delta_{NACK} = 30/15$ with $\beta_{hs} = 30/15 * \beta_c$ and $\Delta_{CQI} = 24/15$ with $\beta_{hs} = 24/15 * \beta_c$
3. CM = 1 for $\beta_c/\beta_d = 12/15$, $\beta_{hs}/\beta_c = 24/15$. For all other combinations of DPDCH, DPCCH and HS-DPCCH the MPR is based on the relative CM difference. This is applicable for only UEs that support HSDPA in release 6 and later releases.
4. For subtest 2 the β_c/β_d ratio of 12/15 for the TFC during the measurement period (TF1, TF0) is achieved by setting the signaled gain factors for the reference TFC (TF1, TF1) to $\beta_c = 11/15$ and $\beta_d = 15/15$.

Table 6. Setup for Release 5 HSDPA



HSPA Data Devices setup for SAR Measurement.

The following procedures are applicable to HSPA (HSUPA/HSDPA) data devices operating under 3GPP Release 6. Body exposure conditions generally apply to these devices, including handsets and data modems operating in various electronic devices. HSUPA operates in conjunction with WCDMA and HSDPA. SAR is initially measured in WCDMA test configurations without HSPA. The default test configuration is to establish a radio link between the DUT and a communication test set to configure a 12.2 kbps RMC (reference measurement channel) in Test Loop Mode 1. SAR for HSPA is selectively measured with HS-DPCCH, EDPCCH and E-DPDCH, all enabled, along with a 12.2 kbps RMC using the highest SAR configuration in WCDMA with 12.2 kbps RMC only. An FRC is configured according to HSDPCCH Sub-test 1 using H-set 1 and QPSK. HSPA is configured according to E-DCH Subtest 5 requirements. SAR for other HSPA sub-test configurations is also confirmed selectively according to output power, exposure conditions and E-DCH UE Category. Maximum output power is verified according to procedures in applicable versions of 3GPP TS 34.121 and SAR must be measured according to these maximum output conditions. The UE Categories for HSDPCCH and HSPA should be clearly identified in the SAR report. The following procedures are applicable only if Maximum Power Reduction (MPR) is implemented according to Cubic Metric (CM) requirements.

When voice transmission and head exposure conditions are applicable to a WCDMA/HSPA data device, head exposure is measured according to the 'Head SAR Measurements' procedures in the 'WCDMA Handsets' section of this document. SAR for body exposure configurations are measured according to the 'Body SAR Measurements' procedures in the 'WCDMA Handsets' section of this document. In addition, body SAR is also measured for HSPA when the maximum average output of each RF channel with HSPA active is at least ¼ dB higher than that measured without HSPA using 12.2 kbps RMC or the maximum SAR for 12.2 kbps RMC is above 75% of the SAR limit. Body SAR for HSPA is measured with E-DCH Sub-test 5, using H-Set 1 and QPSK for FRC and a 12.2 kbps RMC configured in Test Loop Mode 1 with power control algorithm 2, according to the highest body SAR configuration in 12.2 kbps RMC without HSPA. When VOIP is applicable for head exposure, SAR is not required when the maximum output of each RF channel with HSPA is less than ¼ dB higher than that measured using 12.2 kbps RMC; otherwise, the same HSPA configuration used for body measurements should be used to test for head exposure.

Due to inner loop power control requirements in HSPA, a commercial communication test set should be used for the output power and SAR tests. The 12.2 kbps RMC, FRC H-set 1 and E-DCH configurations for HSPA should be configured according to the β values indicated below as well as other applicable procedures described in the 'WCDMA Handset' and 'Release 5 HSDPA Data Devices' sections of this document.



The highest body SAR measured in Antenna Extended & Retracted configurations on a channel in 12.2 kbps RMC. The possible channels are the High, Middle & Low channel. Contact the FCC Laboratory for test and approval requirements if the maximum output power measured in E-DCH Sub-test 2 - 4 is higher than Sub-test 5.

Sub-test	β_c	β_d	β_d (SF)	β_c/β_d	$\beta_{hs}^{(1)}$	β_{ec}	β_{ed}	Bed (SF)	Bed (codes)	CM ⁽²⁾ (dB)	MPR (dB)	AG ⁽⁴⁾ Index	E-TFCI
1	11/15 ⁽³⁾	15/15 ⁽³⁾	64	11/15 ⁽³⁾	22/15	209/225	1039/225	4	1	1.0	0.0	20	75
2	6/15	15/15	64	6/15	12/15	12/15	94/75	4	1	3.0	2.0	12	67
3	15/15	9/15	64	15/9	30/15	30/15	$\beta_{ed1}: 47/15$ $\beta_{ed2}: 47/15$	4	2	2.0	1.0	15	92
4	2/15	15/15	64	2/15	4/15	2/15	56/75	4	1	3.0	2.0	17	71
5	15/15 ⁽⁴⁾	15/15 ⁽⁴⁾	64	15/15 ⁽⁴⁾	30/15	24/15	134/15	4	1	1.0	0.0	21	81

Note 1: $\Delta ACK, \Delta NACK$ and $\Delta CQI = 8 \Leftrightarrow A_{hs} = \beta_{hs}/\beta_c = 30/15 \Leftrightarrow \beta_{hs} = 30/15 * \beta_c$.

Note 2: CM = 1 for $\beta_c/\beta_d = 12/15, \beta_{hs}/\beta_c = 24/15$. For all other combinations of DPDCH, DPCCH, HS- DPCCH, E-DPDCH and E-DPCCH the MPR is based on the relative CM difference.

Note 3: For subtest 1 the β_c/β_d ratio of 11/15 for the TFC during the measurement period (TF1, TF0) is achieved by setting the signaled gain factors for the reference TFC (TF1, TF1) to $\beta_c = 10/15$ and $\beta_d = 15/15$.

Note 4: For subtest 5 the β_c/β_d ratio of 15/15 for the TFC during the measurement period (TF1, TF0) is achieved by setting the signaled gain factors for the reference TFC (TF1, TF1) to $\beta_c = 14/15$ and $\beta_d = 15/15$.

Note 5: Testing UE using E-DPDCH Physical Layer category 1 Sub-test 3 is not required according to TS 25.306 Table 5.1g.

Note 6: β_{ed} can not be set directly; it is set by Absolute Grant Value.

Table 7. Setup for Release 6 HSPA / Release 7 HSPA+



5.3 SAR Testing with 802.11 Transmitters

Normal network operating configurations are not suitable for measuring the SAR of 802.11 b/g transmitters. Unpredictable fluctuations in network traffic and antenna diversity conditions can introduce undesirable variations in SAR results. The SAR for these devices should be measured using chipset based test mode software to ensure the results are consistent and reliable.

5.3.1 General Device Setup

Chipset based test mode software is hardware dependent and generally varies among manufacturers. The device operating parameters established in test mode for SAR measurements must be identical to those programmed in production units, including output power levels, amplifier gain settings and other RF performance tuning parameters. The test frequencies should correspond to actual channel frequencies defined

for domestic use. SAR for devices with switched diversity should be measured with only one antenna transmitting at a time during each SAR measurement, according to a fixed modulation and data rate.

The same data pattern should be used for all measurements.

5.3.2 Frequency Channel Configurations

802.11 a/b/g and 4.9 GHz operating modes are tested independently according to the service requirements in each frequency band. 802.11 b/g modes are tested on channels 1, 6 and 11. 802.11a is tested for UNII operations on channels 36 and 48 in the 5.15-5.25 GHz band; channels 52 and 64 in the 5.25-5.35 GHz band; channels 104, 116, 124 and 136 in the 5.470-5.725 GHz band; and channels 149 and 161 in the 5.8 GHz band. When 5.8 GHz §15.247 is also available, channels 149, 157 and 165 should be tested instead of the UNII channels. 4.9 GHz is tested on channels 1, 10 and 5 or 6, whichever has the higher output power, for 5 MHz channels; channels 11, 15 and 19 for 10 MHz channels; and channels 21 and 25 for 20 MHz channels. These are referred to as the “default test channels”. 802.11g mode was evaluated only if the output power was 0.25 dB higher than the 802.11b mode.

802.11 Test Channels per FCC Requirement

Mode	GHz	Channel	Turbo Channel	Default Test “Channels”			
				§15.247		UNII	
				802.11b	802.11g		
802.11 b/g	2412	1		✓	▽		
	2437	6	6	✓	▽		
	2462	11		✓	▽		



5.4 Conducted Power

Band	Modulation	Mode	CH	Frequency (MHz)	RF Conducted Output Power (dBm)	
					Time Average	Average burst
GSM 850	GMSK	1Down1Up Duty factor 1/8	Lowest	824.2	24.43	33.46
			Middle	836.6	24.40	33.43
			Highest	848.8	24.14	33.17
GPRS 850 Multi Class :12 Max Up:4 Max Down:4 Sum:5		4Down1Up Duty factor 1/8	Lowest	824.2	24.40	33.43
			Middle	836.6	24.38	33.41
			Highest	848.8	23.78	32.81
		3Down2Up Duty factor 2/8	Lowest	824.2	26.33	32.35
			Middle	836.6	26.47	32.49
			Highest	848.8	25.98	32.00
		2Down3Up Duty factor 3/8	Lowest	824.2	26.63	30.89
			Middle	836.6	26.56	30.82
			Highest	848.8	26.45	30.71
1Down4Up Duty factor 4/8	Lowest	824.2	26.26	29.27		
	Middle	836.6	26.27	29.28		
	Highest	848.8	26.13	29.14		
EGPRS 850 Multi Class :12 Max Up:4 Max Down:4 Sum:5	8PSK	4Down1Up Duty factor 1/8	Lowest	824.2	17.93	26.96
			Middle	836.6	17.89	26.92
			Highest	848.8	17.79	26.82
		3Down2Up Duty factor 2/8	Lowest	824.2	19.48	25.50
			Middle	836.6	19.38	25.40
			Highest	848.8	19.35	25.37
		2Down3Up Duty factor 3/8	Lowest	824.2	21.16	25.42
			Middle	836.6	21.11	25.37
			Highest	848.8	21.04	25.30
		1Down4Up Duty factor 4/8	Lowest	824.2	21.33	24.34
			Middle	836.6	21.31	24.32
			Highest	848.8	21.21	24.22
DTM 850 Multi Class :11 Max Up:3 Down:4 Sum:5	GMSK	GSM + GPRS 2Down3Up Duty factor 3/8	Lowest	824.2	26.64	30.90
			Middle	836.6	26.54	30.80
			Highest	848.8	26.44	30.70
	GMSK/8PSK	GSM + EGPRS 2Down3Up Duty factor 3/8	Lowest	824.2	21.14	25.40
			Middle	836.6	21.14	25.40
			Highest	848.8	21.04	25.30

Note: 1. Time Average power slot duty cycle factor calculate:

1up: Average burst power+10*LOG(1/8)

2up: Average burst power+10*LOG(2/8)

3up: Average burst power+10*LOG(3/8)

4up: Average burst power+10*LOG(4/8)

2. Selected Mode for SAR testing:

a. Head – GSM(Voice mode)/GPRS(Data mode)/DTM(2Down3Up)

b. Body worn accessory 10mm – GSM(Voice mode)/DTM(2Down3Up)

c. Body Hot-Spot mode 10mm – GPRS(Data mode)



Band	Modulation	Mode	CH	Frequency (MHz)	RF Conducted Output Power (dBm)	
					Time Average	Average burst
GSM 1900	GMSK	1Down1Up Duty factor 1/8	Lowest	1850.2	20.96	29.99
			Middle	1880.0	20.99	30.02
			Highest	1909.8	20.80	29.83
GPRS 1900 Multi Class :12 Max Up:4 Max Down:4 Sum:5		4Down1Up Duty factor 1/8	Lowest	1850.2	20.82	29.85
			Middle	1880.0	20.91	29.94
			Highest	1909.8	20.67	29.70
		3Down2Up Duty factor 2/8	Lowest	1850.2	23.26	29.28
			Middle	1880.0	23.39	29.41
			Highest	1909.8	23.14	29.16
		2Down3Up Duty factor 3/8	Lowest	1850.2	23.42	27.68
			Middle	1880.0	23.54	27.80
			Highest	1909.8	23.32	27.58
1Down4Up Duty factor 4/8	Lowest	1850.2	23.17	26.18		
	Middle	1880.0	23.30	26.31		
	Highest	1909.8	23.10	26.11		
EGPRS 1900 Multi Class :12 Max Up:4 Max Down:4 Sum:5	8PSK	4Down1Up Duty factor 1/8	Lowest	1850.2	16.84	25.87
			Middle	1880.0	16.85	25.88
			Highest	1909.8	16.64	25.67
		3Down2Up Duty factor 2/8	Lowest	1850.2	18.77	24.79
			Middle	1880.0	18.85	24.87
			Highest	1909.8	18.71	24.73
		2Down3Up Duty factor 3/8	Lowest	1850.2	20.55	24.81
			Middle	1880.0	20.56	24.82
			Highest	1909.8	20.43	24.69
		1Down4Up Duty factor 4/8	Lowest	1850.2	20.32	23.33
			Middle	1880.0	20.28	23.29
			Highest	1909.8	20.16	23.17
DTM 1900	GMSK	GSM + GPRS 2Down3Up Duty factor 3/8	Lowest	1850.2	23.09	27.35
			Middle	1880.0	23.14	27.40
			Highest	1909.8	22.89	27.15
	GMSK/8PSK	GSM + EGPRS 2Down3Up Duty factor 3/8	Lowest	1850.2	20.29	24.55
			Middle	1880.0	20.29	24.55
			Highest	1909.8	20.09	24.35

Note: 1. Time Average power slot duty cycle factor calculate:

- 1up: Average burst power+10*LOG(1/8)
- 2up: Average burst power+10*LOG(2/8)
- 3up: Average burst power+10*LOG(3/8)
- 4up: Average burst power+10*LOG(4/8)

2. Selected Mode for SAR testing:

- a. Head – GSM(Voice mode)/GPRS(Data mode)/DTM(2Down3Up)
- b. Body worn accessory 10mm – GSM(Voice mode)/DTM(2Down3Up)
- c. Body Hot-Spot mode 10mm – GPRS(Data mode)



Band	Modulation	Sub-test	CH	Frequency (MHz)	RF Conducted Output Power (dBm)
					Average
WCDMA Band V	RMC12.2K	---	Lowest	826.4	22.42
			Middle	836.6	22.46
			Highest	846.6	22.60
HSDPA Band V	QPSK	1	Lowest	826.4	22.57
			Middle	836.6	22.59
			Highest	846.6	22.52
		2	Lowest	826.4	22.48
			Middle	836.6	22.56
			Highest	846.6	22.50
		3	Lowest	826.4	22.08
			Middle	836.6	22.18
			Highest	846.6	22.09
		4	Lowest	826.4	22.00
			Middle	836.6	22.08
			Highest	846.6	22.07
HSUPA Band V	QPSK	1	Lowest	826.4	20.88
			Middle	836.6	20.98
			Highest	846.6	20.11
		2	Lowest	826.4	18.79
			Middle	836.6	18.91
			Highest	846.6	18.20
		3	Lowest	826.4	19.79
			Middle	836.6	19.98
			Highest	846.6	19.05
		4	Lowest	826.4	18.79
			Middle	836.6	18.98
			Highest	846.6	18.18
		5	Lowest	826.4	20.84
			Middle	836.6	20.93
			Highest	846.6	20.02

Note: Selected Mode for SAR testing:

- a. Head – WCDMA(RMC 12.2K mode)
- b. Body Hot-Spot mode 10mm – WCDMA(RMC 12.2K mode)



Band	Data Rate	CH	Frequency (MHz)	RF Conducted Output Power (dBm)
				Average
IEEE 802.11b	1 M	1	2412.0	17.10
		6	2437.0	17.52
		11	2462.0	18.07
	2 M	1	2412.0	17.00
		6	2437.0	17.54
		11	2462.0	17.95
	5.5 M	1	2412.0	17.07
		6	2437.0	17.50
		11	2462.0	17.95
	11 M	1	2412.0	16.90
		6	2437.0	17.44
		11	2462.0	17.81
IEEE 802.11g	6 M	1	2412.0	11.48
		6	2437.0	11.95
		11	2462.0	12.41
	9 M	1	2412.0	11.30
		6	2437.0	11.84
		11	2462.0	12.28
	12 M	1	2412.0	11.21
		6	2437.0	11.75
		11	2462.0	12.22
	18 M	1	2412.0	11.00
		6	2437.0	11.53
		11	2462.0	12.01
	24 M	1	2412.0	10.90
		6	2437.0	11.35
		11	2462.0	11.81
	36 M	1	2412.0	10.51
		6	2437.0	11.01
		11	2462.0	11.48
	48 M	1	2412.0	10.15
		6	2437.0	10.72
		11	2462.0	11.27
	54 M	1	2412.0	10.14
		6	2437.0	10.60
		11	2462.0	11.07

Note: Selected Mode for SAR testing:

- a. Head – IEEE 802.11b
- d. Body Hot-Spot mode 10mm – IEEE 802.11b



Band	Data Rate	CH	Frequency (MHz)	RF Conducted Output Power (dBm)
				Average
Draft 802.11n_HT20 (2.4 GHz)	6.5 M	1	2412.0	11.37
		6	2437.0	11.86
		11	2462.0	12.26
	13.0 M	1	2412.0	11.06
		6	2437.0	11.66
		11	2462.0	12.02
	19.5 M	1	2412.0	10.92
		6	2437.0	11.32
		11	2462.0	11.84
	26.0 M	1	2412.0	10.62
		6	2437.0	11.17
		11	2462.0	11.67
	39.0 M	1	2412.0	10.38
		6	2437.0	10.90
		11	2462.0	11.38
	52.0 M	1	2412.0	10.12
		6	2437.0	10.55
		11	2462.0	11.08
	58.5 M	1	2412.0	9.95
		6	2437.0	10.52
		11	2462.0	10.97
65.0 M	1	2412.0	9.87	
	6	2437.0	10.39	
	11	2462.0	10.83	
Band	Packet Type	CH	Frequency (MHz)	RF Conducted Output Power (dBm)
				Average
Bluetooth v3.0	DH1	00	2402	-4.42
		39	2441	-4.97
		78	2480	-5.05
	DH3	00	2402	-2.61
		39	2441	-1.76
		78	2480	-1.83
	DH5	00	2402	-1.94
		39	2441	-1.09
		78	2480	-1.16
Bluetooth v4.0 LE	---	00	2402	-0.56
		19	2440	0.25
		38	2480	0.05

Note: Selected Mode for SAR testing:

- a. Body 10mm - Bluetooth v3.0/Bluetooth v4.0 LE



5.5 Simultaneous Transmitting Evaluate

RF Conducted Power		
Band	dBm	W
GSM/GPRS/EGPRS/DTM 850	26.64	0.461
GSM/GPRS/EGPRS/DTM 1900	23.54	0.226
WCDMA/HSDPA/HSUPA Band V	22.60	0.182
Wi-Fi 802.11b	18.07	0.064
Wi-Fi 802.11g	12.41	0.017
Wi-Fi 802.11n_2.4GHz	12.26	0.017
BT 3.0 / BT 4.0	0.25	0.001

Antenna Distance	
Antenna Account	Distance (cm)
BT to WLAN	0
BT to WWAN (License)	7.7
WLAN to WWAN (License)	7.7

BT and WWAN and WLAN simultaneously SAR Description

(1) Antenna Distance

- 1a. Bluetooth & WWAN 7.7 cm
- 1b. Bluetooth & WLAN 0 cm
- 1c. WWAN & WLAN 7.7 cm

(2) WWAN/ Bluetooth – with antenna separation distance greater than > 5cm – BT power is less than 2*Pref, then simultaneous SAR of WWAN/BT is not required.

(3) WLAN/ Bluetooth – Use the same antenna, then antenna separation distance greater than <2.5cm
Max sum of BT and WLAN (2.4GHz) is $0.021+0.309 = 0.33 < 1.6$ mW/g. Therefore Simultaneous SAR is not required.

(4) WLAN/WWAN – with antenna separation distance greater than > 5cm
Max sum of WWAN and WLAN is $1.35+0.309 = 1.659 > 1.6$ mW/g, SPLSR $= (1.35+0.309)/8.5 = 0.2 < 0.3$. Therefore Simultaneous SAR is not required.

(5) WWAN/WLAN/BT

Stand-alone SAR is required due to routine evaluation requirements.

(6) Highest Simultaneous SAR Evaluation:

Body SAR : $\Sigma \text{ SAR} = \text{WWAN} + \text{WLAN} = 1.659 \text{ mW/g} > \text{SAR limit: } 1.6 \text{ mW/g}$

SPLSR $= (1.35+0.309)/8.5 = 0.2 < 0.3$. Therefore Simultaneous SAR is not required.

Head SAR : $\Sigma \text{ SAR} = \text{WWAN} + \text{WLAN} = 1.431 \text{ mW/g} < \text{SAR limit: } 1.6 \text{ mW/g}$

Therefore Simultaneous SAR is not required.

(7) For WiFi hot spot mode, since the GSM network will support the DTM mode, therefore the GPRS SAR of head is required.

(8) The distance of peak to peak location for evaluation as below:

WWAN: Flat_DTM PCS CH661_2D3U_Back Surface to Phantom_10mm_Headset			
Value of SAR	X ₂	Y ₂	Z ₂
Max.	m	m	m
1.61	-0.003	-0.044	-0.203
WLAN: Flat_802.11b CH11_1M_Back Surface to Phantom_10mm			
Value of SAR	X ₁	Y ₁	Z ₁
Max.	m	m	m
0.379	-0.007	0.0405	-0.203

Distance calculation

DASY stores the individual coordinates of each measurement point, whereby the center coordinate (x=0, y=0) is always the Grid Reference Point as set in the Phantom properties within DASY setup pane. As long as the same phantom section is used the distance between two hot spots can be calculated with the Pythagoras' theorem.

E.g. Antenna 1 has X₁, Y₁, Z₁ and Antenna 2 has X₂, Y₂, Z₂ as the hot spot coordinates. The closest distance between them is

$$d = \sqrt{(X_1 - X_2)^2 + (Y_1 - Y_2)^2 + (Z_1 - Z_2)^2}$$

Distance	Calculation
0.085 m	d=SQRT((-0.007-(-0.003))^2+(0.0405-(-0.044))^2+(-0.203-(-0.203))^2)
8.5 cm	

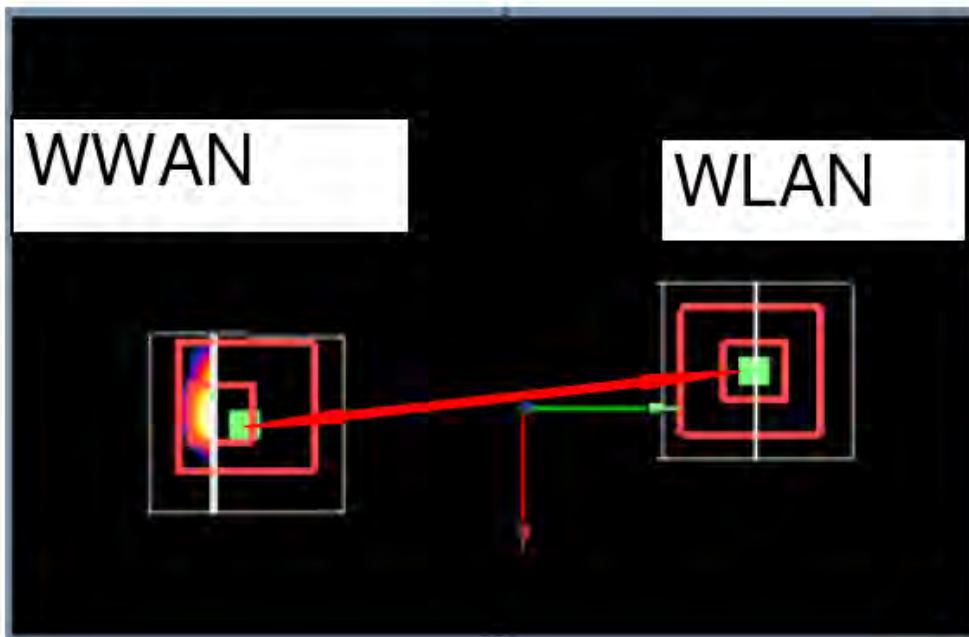



Note:

1. Simultaneous Transmitting Summary, please find the table 8 as below.
2. Simultaneous Transmission Summation of SAR, please find the table 9 as below.
 - 2.1 For hot-spot mode, the WWAN antenna location to edge >2.5 cm. Therefore test Edge Top is not required.
 - 2.2 For hot-spot mode, the WLAN antenna location to edge >2.5 cm. Therefore test Edge Bottom are not required.

Table 8. Simultaneous Transmitting Summary

Simultaneous Transmitting	802.11b	802.11g	802.11n	Bluetooth
GSM/GPRS/EGPRS/DTM 850	V	V	V	V
GSM/GPRS/EGPRS/DTM 1900	V	V	V	V
WCDMA/HSDPA/HSUPA Band V	V	V	V	V
Bluetooth	V	V	V	

This is a summary for the capability of simultaneous transmitting. For evaluation of simultaneously SAR, please refer to the above BT and WWAN and WLAN simultaneously SAR Description



Table 9.

Right-Cheek mode					
The sum of the 1-g SAR					
Simult Tx	Configuration	GSM 850 SAR mW/g	WLAN SAR mW/g	Σ SAR mW/g	Σ SAR
Head SAR	Right-Cheek	0.314	0.323	0.637	<1.6
Simult Tx	Configuration	GPRS 850 SAR mW/g	WLAN SAR mW/g	Σ SAR mW/g	Σ SAR
Head SAR	Right-Cheek	0.361	0.323	0.684	<1.6
Simult Tx	Configuration	DTM 850 SAR mW/g	WLAN SAR mW/g	Σ SAR mW/g	Σ SAR
Head SAR	Right-Cheek	0.304	0.323	0.627	<1.6
Simult Tx	Configuration	GSM 1900 SAR mW/g	WLAN SAR mW/g	Σ SAR mW/g	Σ SAR
Head SAR	Right-Cheek	0.392	0.323	0.715	<1.6
Simult Tx	Configuration	GPRS 1900 SAR mW/g	WLAN SAR mW/g	Σ SAR mW/g	Σ SAR
Head SAR	Right-Cheek	0.961	0.323	1.284	<1.6
Simult Tx	Configuration	DTM 1900 SAR mW/g	WLAN SAR mW/g	Σ SAR mW/g	Σ SAR
Head SAR	Right-Cheek	0.792	0.323	1.115	<1.6
Simult Tx	Configuration	WCDMA Band V SAR mW/g	WLAN SAR mW/g	Σ SAR mW/g	Σ SAR
Head SAR	Right-Cheek	0.191	0.323	0.514	<1.6



Right-Tilted mode					
The sum of the 1-g SAR					
Simult Tx	Configuration	GSM 850 SAR mW/g	WLAN SAR mW/g	Σ SAR mW/g	Σ SAR
Head SAR	Right-Cheek	0.168	0.445	0.613	<1.6
Simult Tx	Configuration	GPRS 850 SAR mW/g	WLAN SAR mW/g	Σ SAR mW/g	Σ SAR
Head SAR	Right-Cheek	0.196	0.445	0.641	<1.6
Simult Tx	Configuration	DTM 850 SAR mW/g	WLAN SAR mW/g	Σ SAR mW/g	Σ SAR
Head SAR	Right-Cheek	0.167	0.445	0.612	<1.6
Simult Tx	Configuration	GSM 1900 SAR mW/g	WLAN SAR mW/g	Σ SAR mW/g	Σ SAR
Head SAR	Right-Cheek	0.456	0.445	0.901	<1.6
Simult Tx	Configuration	GPRS 1900 SAR mW/g	WLAN SAR mW/g	Σ SAR mW/g	Σ SAR
Head SAR	Right-Cheek	0.817	0.445	1.262	<1.6
Simult Tx	Configuration	DTM 1900 SAR mW/g	WLAN SAR mW/g	Σ SAR mW/g	Σ SAR
Head SAR	Right-Cheek	0.804	0.445	1.249	<1.6
Simult Tx	Configuration	WCDMA Band V SAR mW/g	WLAN SAR mW/g	Σ SAR mW/g	Σ SAR
Head SAR	Right-Cheek	0.101	0.445	0.546	<1.6



Left-Cheek mode					
The sum of the 1-g SAR					
Simult Tx	Configuration	GSM 850 SAR mW/g	WLAN SAR mW/g	Σ SAR mW/g	Σ SAR
Head SAR	Right-Cheek	0.2	0.391	0.591	<1.6
Simult Tx	Configuration	GPRS 850 SAR mW/g	WLAN SAR mW/g	Σ SAR mW/g	Σ SAR
Head SAR	Right-Cheek	0.26	0.391	0.651	<1.6
Simult Tx	Configuration	DTM 850 SAR mW/g	WLAN SAR mW/g	Σ SAR mW/g	Σ SAR
Head SAR	Right-Cheek	0.189	0.391	0.58	<1.6
Simult Tx	Configuration	GSM 1900 SAR mW/g	WLAN SAR mW/g	Σ SAR mW/g	Σ SAR
Head SAR	Right-Cheek	0.584	0.391	0.975	<1.6
Simult Tx	Configuration	GPRS 1900 SAR mW/g	WLAN SAR mW/g	Σ SAR mW/g	Σ SAR
Head SAR	Right-Cheek	1.04	0.391	1.431	<1.6
Simult Tx	Configuration	DTM 1900 SAR mW/g	WLAN SAR mW/g	Σ SAR mW/g	Σ SAR
Head SAR	Right-Cheek	0.973	0.391	1.364	<1.6
Simult Tx	Configuration	WCDMA Band V SAR mW/g	WLAN SAR mW/g	Σ SAR mW/g	Σ SAR
Head SAR	Right-Cheek	0.128	0.391	0.519	<1.6



Left-Tilted mode					
The sum of the 1-g SAR					
Simult Tx	Configuration	GSM 850 SAR mW/g	WLAN SAR mW/g	Σ SAR mW/g	Σ SAR
Head SAR	Right-Cheek	0.127	0.365	0.492	<1.6
Simult Tx	Configuration	GPRS 850 SAR mW/g	WLAN SAR mW/g	Σ SAR mW/g	Σ SAR
Head SAR	Right-Cheek	0.185	0.365	0.55	<1.6
Simult Tx	Configuration	DTM 850 SAR mW/g	WLAN SAR mW/g	Σ SAR mW/g	Σ SAR
Head SAR	Right-Cheek	0.136	0.365	0.501	<1.6
Simult Tx	Configuration	GSM 1900 SAR mW/g	WLAN SAR mW/g	Σ SAR mW/g	Σ SAR
Head SAR	Right-Cheek	0.327	0.365	0.692	<1.6
Simult Tx	Configuration	GPRS 1900 SAR mW/g	WLAN SAR mW/g	Σ SAR mW/g	Σ SAR
Head SAR	Right-Cheek	0.582	0.365	0.947	<1.6
Simult Tx	Configuration	DTM 1900 SAR mW/g	WLAN SAR mW/g	Σ SAR mW/g	Σ SAR
Head SAR	Right-Cheek	0.577	0.365	0.942	<1.6
Simult Tx	Configuration	WCDMA Band V SAR mW/g	WLAN SAR mW/g	Σ SAR mW/g	Σ SAR
Head SAR	Right-Cheek	0.086	0.365	0.451	<1.6



Hot-spot mode _ Front surface					
The sum of the 1-g SAR					
Simult Tx	Configuration	GPRS 850 SAR mW/g	WLAN SAR mW/g	Σ SAR mW/g	Σ SAR
Body SAR	Flat	0.311	0.141	0.452	<1.6
Simult Tx	Configuration	GPRS 1900 SAR mW/g	WLAN SAR mW/g	Σ SAR mW/g	Σ SAR
Body SAR	Flat	1.05	0.141	1.191	<1.6
Simult Tx	Configuration	WCDMA Band V SAR mW/g	WLAN SAR mW/g	Σ SAR mW/g	Σ SAR
Body SAR	Flat	0.178	0.141	0.319	<1.6

Hot-spot mode _ Back surface					
The sum of the 1-g SAR					
Simult Tx	Configuration	GPRS 850 SAR mW/g	WLAN SAR mW/g	Σ SAR mW/g	Σ SAR
Body SAR	Flat	0.425	0.309	0.734	<1.6
Simult Tx	Configuration	GPRS 1900 SAR mW/g	WLAN SAR mW/g	Σ SAR mW/g	Σ SAR
Body SAR	Flat	1.23	0.309	1.539	<1.6
Simult Tx	Configuration	WCDMA Band V SAR mW/g	WLAN SAR mW/g	Σ SAR mW/g	Σ SAR
Body SAR	Flat	0.314	0.309	0.623	<1.6



Hot-spot mode _ Edge Right					
The sum of the 1-g SAR					
Simult Tx	Configuration	GPRS 850 SAR mW/g	WLAN SAR mW/g	Σ SAR mW/g	Σ SAR
Body SAR	Flat	0.247	0.17	0.417	<1.6
Simult Tx	Configuration	GPRS 1900 SAR mW/g	WLAN SAR mW/g	Σ SAR mW/g	Σ SAR
Body SAR	Flat	0.362	0.17	0.532	<1.6
Simult Tx	Configuration	WCDMA Band V SAR mW/g	WLAN SAR mW/g	Σ SAR mW/g	Σ SAR
Body SAR	Flat	0.115	0.17	0.285	<1.6

Hot-spot mode _ Edge Left					
The sum of the 1-g SAR					
Simult Tx	Configuration	GPRS 850 SAR mW/g	WLAN SAR mW/g	Σ SAR mW/g	Σ SAR
Body SAR	Flat	0.231	0.038	0.269	<1.6
Simult Tx	Configuration	GPRS 1900 SAR mW/g	WLAN SAR mW/g	Σ SAR mW/g	Σ SAR
Body SAR	Flat	0.291	0.038	0.329	<1.6
Simult Tx	Configuration	WCDMA Band V SAR mW/g	WLAN SAR mW/g	Σ SAR mW/g	Σ SAR
Body SAR	Flat	0.136	0.038	0.174	<1.6



The body worn accessory _ Front Surface					
The sum of the 1-g SAR					
Simult Tx	Configuration	GSM 850 SAR mW/g	WLAN SAR mW/g	Σ SAR mW/g	Σ SAR
Body SAR	Flat	0.179	0.141	0.32	<1.6
Simult Tx	Configuration	DTM 850 SAR mW/g	WLAN SAR mW/g	Σ SAR mW/g	Σ SAR
Body SAR	Flat	0.35	0.141	0.491	<1.6
Simult Tx	Configuration	GSM 1900 SAR mW/g	WLAN SAR mW/g	Σ SAR mW/g	Σ SAR
Body SAR	Flat	0.51	0.141	0.651	<1.6
Simult Tx	Configuration	DTM 1900 SAR mW/g	WLAN SAR mW/g	Σ SAR mW/g	Σ SAR
Body SAR	Flat	0.922	0.141	1.063	<1.6

The body worn accessory _ Back Surface					
The sum of the 1-g SAR					
Simult Tx	Configuration	GSM 850 SAR mW/g	WLAN SAR mW/g	Σ SAR mW/g	Σ SAR
Body SAR	Flat	0.326	0.309	0.635	<1.6
Simult Tx	Configuration	DTM 850 SAR mW/g	WLAN SAR mW/g	Σ SAR mW/g	Σ SAR
Body SAR	Flat	0.584	0.309	0.893	<1.6
Simult Tx	Configuration	GSM 1900 SAR mW/g	WLAN SAR mW/g	Σ SAR mW/g	Σ SAR
Body SAR	Flat	0.658	0.309	0.967	<1.6
Simult Tx	Configuration	DTM 1900 SAR mW/g	WLAN SAR mW/g	Σ SAR mW/g	Σ SAR
Body SAR	Flat	1.35	0.309	1.659	>1.6

6. System Performance Check

6.1 Symmetric Dipoles for System Verification

Construction	Symmetrical dipole with 1/4 balun enables measurement of feed point impedance with NWA matched for use near flat phantoms filled with head simulating solutions Includes distance holder and tripod adaptor Calibration Calibrated SAR value for specified position and input power at the flat phantom in head simulating solutions.
Frequency	835, 1900 and 2450 MHz
Return Loss	> 20 dB at specified verification position
Power Capability	> 100 W (f < 1GHz); > 40 W (f > 1GHz)
Options	Dipoles for other frequencies or solutions and other calibration conditions are available upon request
Dimensions	D835V2: dipole length 161 mm; overall height 340 mm D1900V2: dipole length 67.7 mm; overall height 300 mm D2450V2: dipole length 51.5 mm; overall height 300 mm

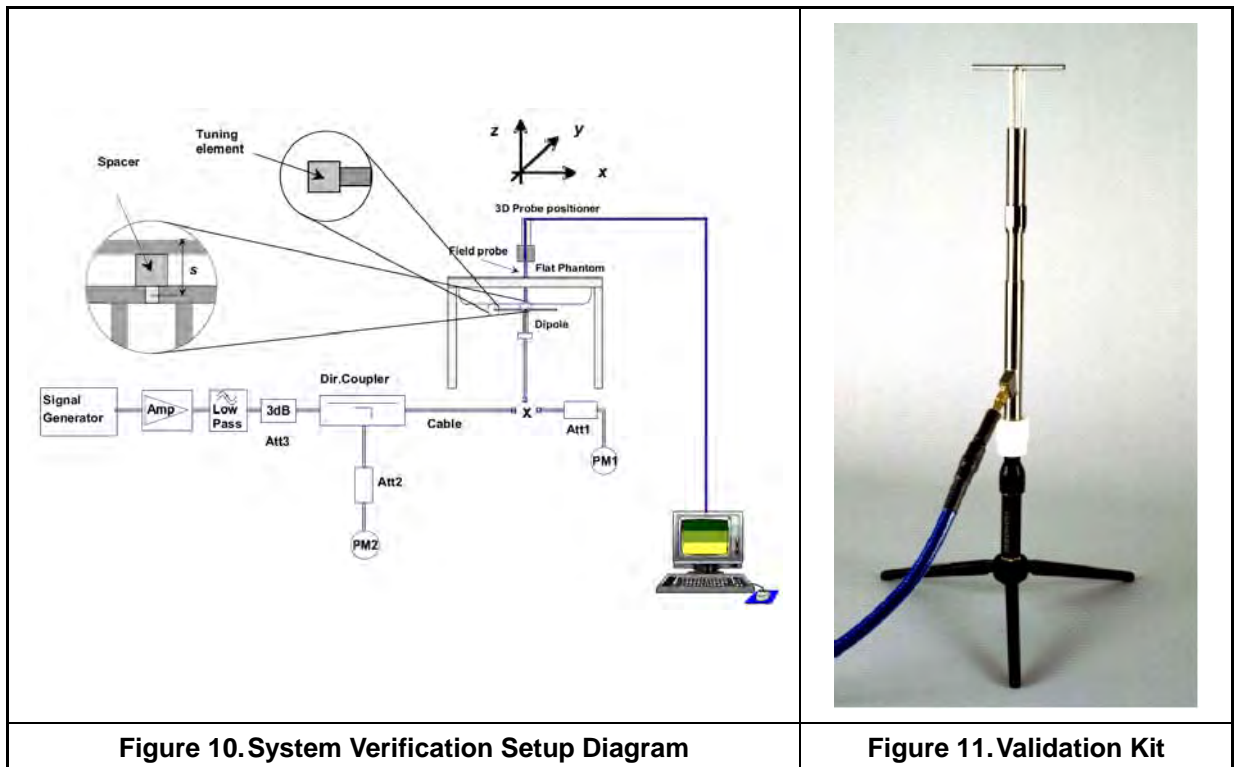



6.2 Verification

Prior to the assessment, the system validation kit was used to test whether the system was operating within its specifications of $\pm 7\%$. The verification was performed at 835, 1900 and 2450MHz.

Validation kit		Mixture Type	SAR _{1g} [mW/g]		SAR _{10g} [mW/g]		Date of Calibration
D835V2-SN4d082		Head	9.25		6.07		07/19/2011
D1900V2-SN5d111		Head	39.90		20.80		07/22/2011
D2450V2-SN712		Head	52.90		24.50		02/23/2012
Frequency (MHz)	Power (dBm)	SAR _{1g} (mW/g)	SAR _{10g} (mW/g)	Drift (dB)	Difference percentage		Date
					1g	10g	
835 (Head)	250mW	2.42	1.58	-0.14100	4.6 %	4.1 %	06/26/2012
	Normalize to 1 Watt	9.68	6.32				
835 (Head)	250mW	2.38	1.55	-0.00442	2.9 %	2.1 %	07/05/2012
	Normalize to 1 Watt	9.52	6.20				
1900 (Head)	250mW	9.97	5.20	0.01100	-0.1 %	0.0 %	06/27/2012
	Normalize to 1 Watt	39.88	20.80				
1900 (Head)	250mW	9.69	4.99	-0.14200	-2.9 %	-4.0 %	06/28/2012
	Normalize to 1 Watt	38.76	19.96				
2450 (Head)	250mW	13.10	6.00	0.01500	-2.1 %	-3.2 %	07/03/2012
	Normalize to 1 Watt	52.40	24.00				



Validation kit		Mixture Type	SAR _{1g} [mW/g]		SAR _{10g} [mW/g]		Date of Calibration
D835V2-SN4d082		Body	9.43		6.22		07/19/2011
D1900V2-SN5d111		Body	40.90		21.50		07/22/2011
D2450V2-SN712		Body	49.90		23.60		02/23/2012
Frequency (MHz)	Power (dBm)	SAR _{1g} (mW/g)	SAR _{10g} (mW/g)	Drift (dB)	Difference percentage		Date
					1g	10g	
835 (Body)	250mW	2.41	1.58	-0.04100	2.2 %	1.6 %	06/28/2012
	Normalize to 1 Watt	9.64	6.32				
1900 (Body)	250mW	10.40	5.46	0.04200	1.7 %	1.6 %	06/29/2012
	Normalize to 1 Watt	41.60	21.84				
1900 (Body)	250mW	10.50	5.49	0.02600	2.7 %	2.1 %	07/01/2012
	Normalize to 1 Watt	42.00	21.96				
2450 (Body)	250mW	12.90	5.86	-0.00637	3.4 %	-0.7 %	07/02/2012
	Normalize to 1 Watt	51.60	23.44				
2450 (Body)	250mW	12.60	5.75	-0.01200	1.0 %	-2.5 %	07/03/2012
	Normalize to 1 Watt	50.40	23.00				

Z-axis Plot of System Performance Check

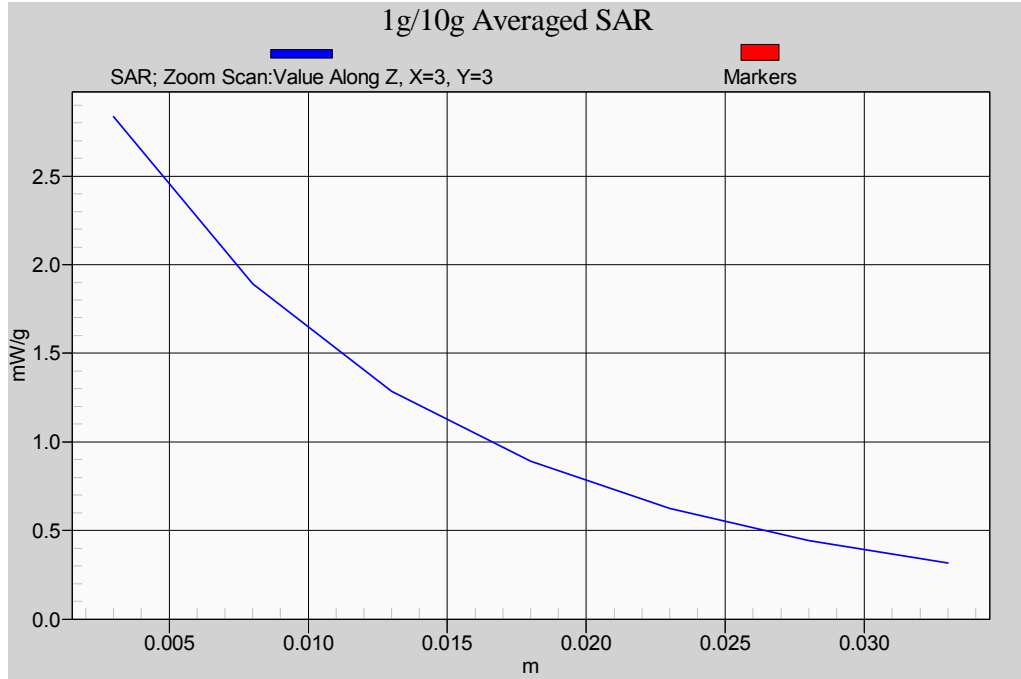

Head-Tissue-Simulating-Liquid 835MHz (06/26/2012)

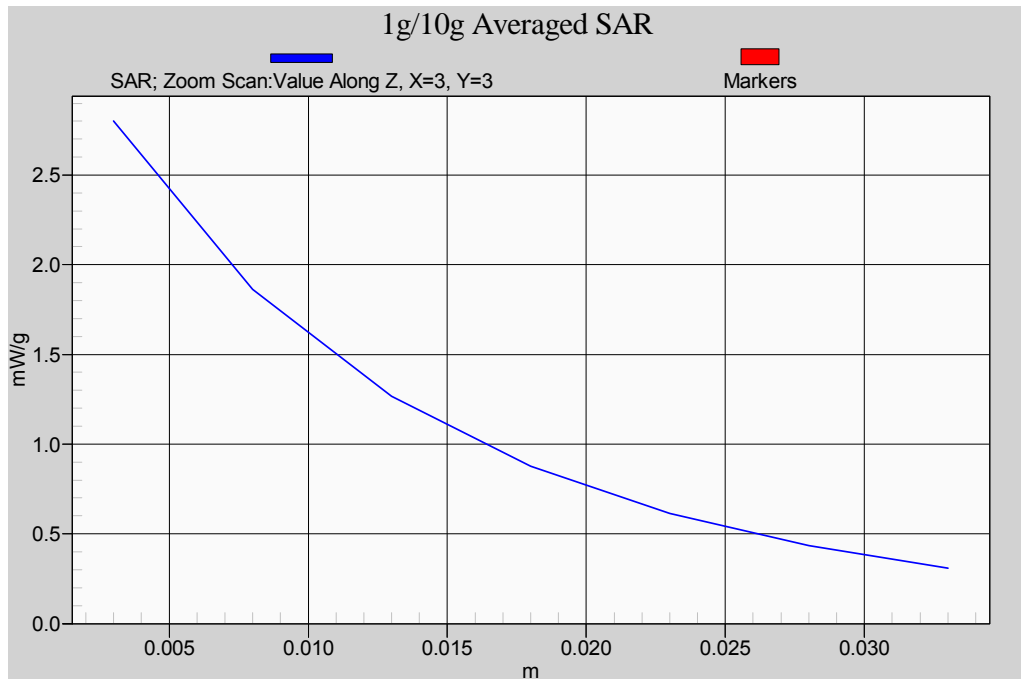

Head-Tissue-Simulating-Liquid 835MHz (07/05/2012)

Z-axis Plot of System Performance Check

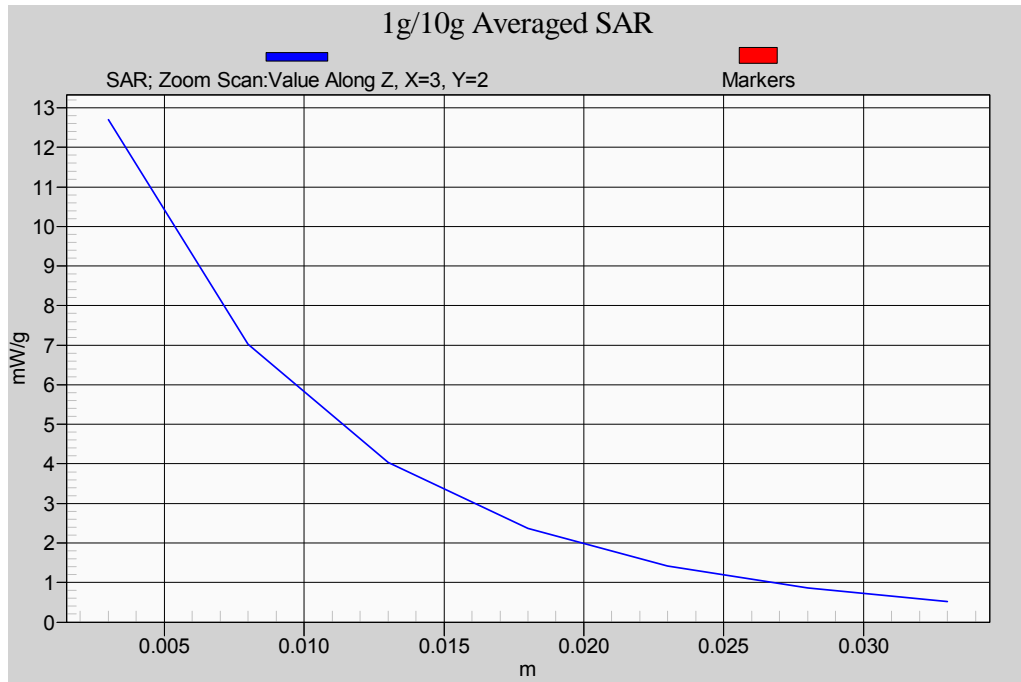

Head-Tissue-Simulating-Liquid 1900MHz (06/27/2012)

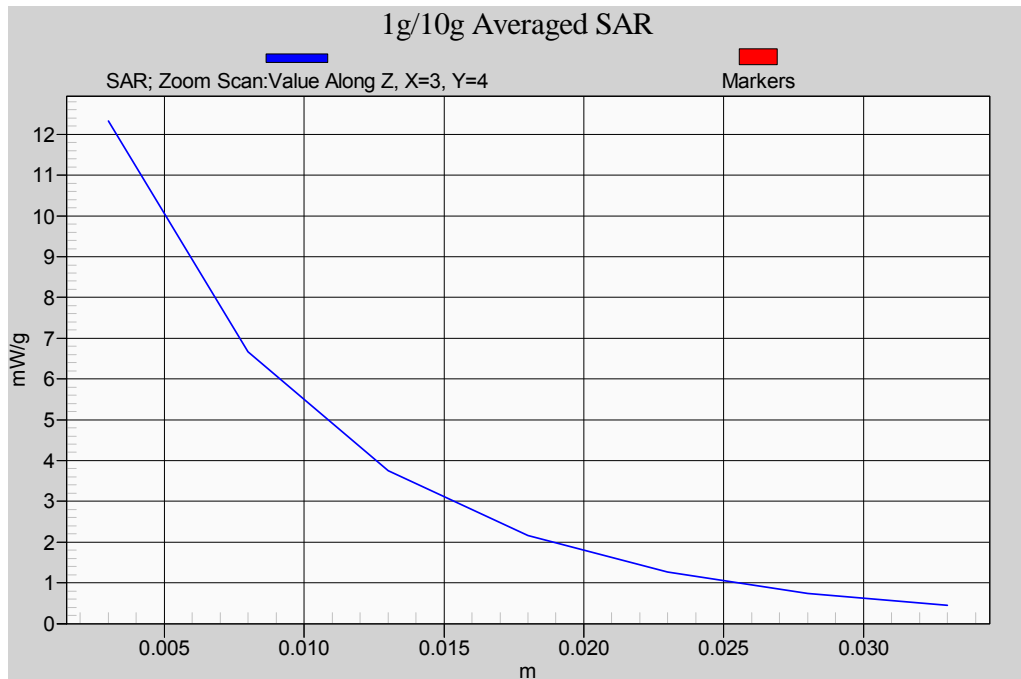

Head-Tissue-Simulating-Liquid 1900MHz (06/28/2012)

Z-axis Plot of System Performance Check

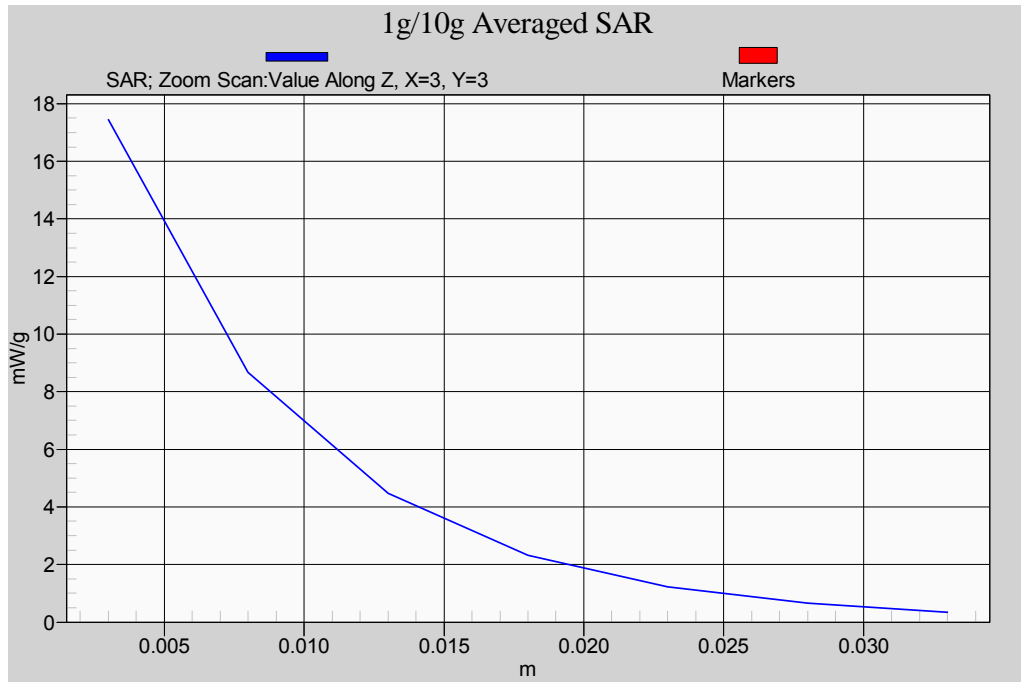

Head-Tissue-Simulating-Liquid 2450MHz

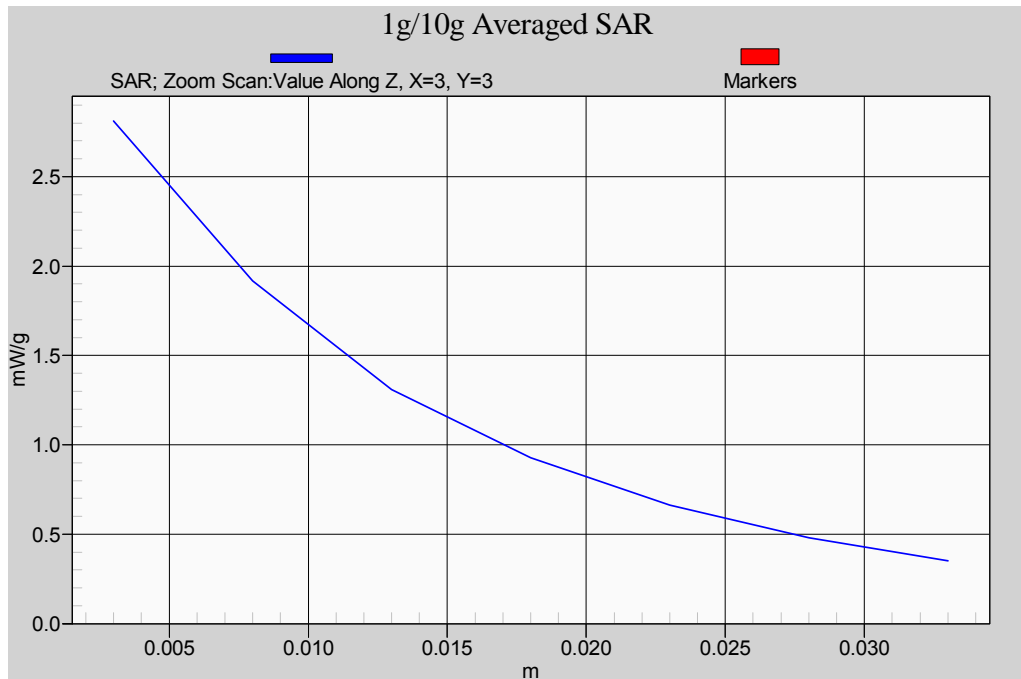

Body-Tissue-Simulating-Liquid 835MHz

Z-axis Plot of System Performance Check

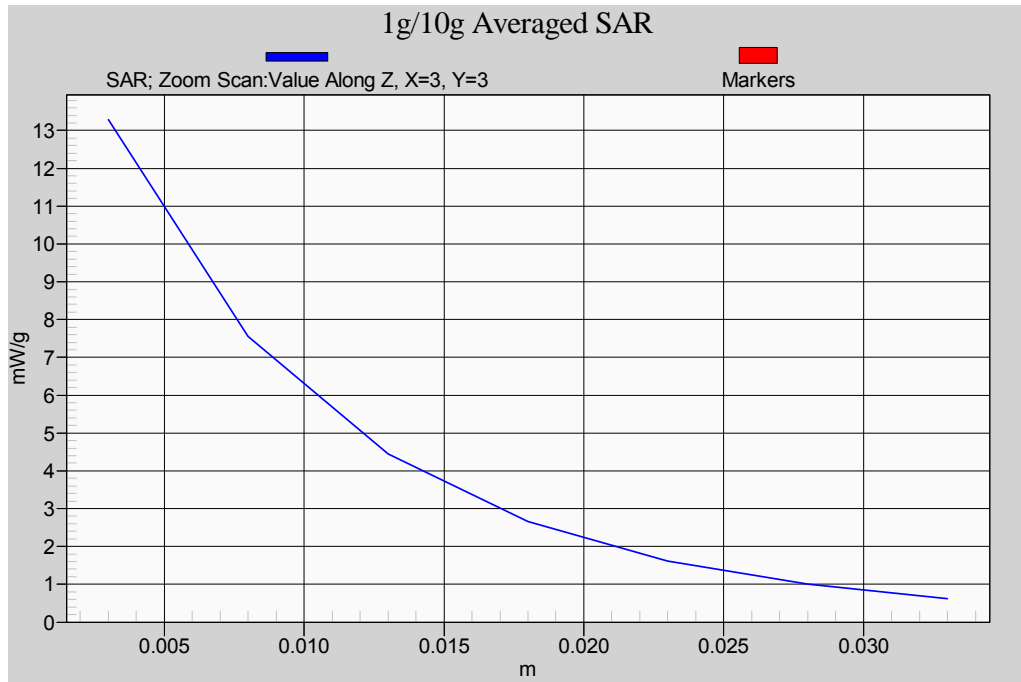

Body-Tissue-Simulating-Liquid 1900MHz (06/29/2012)

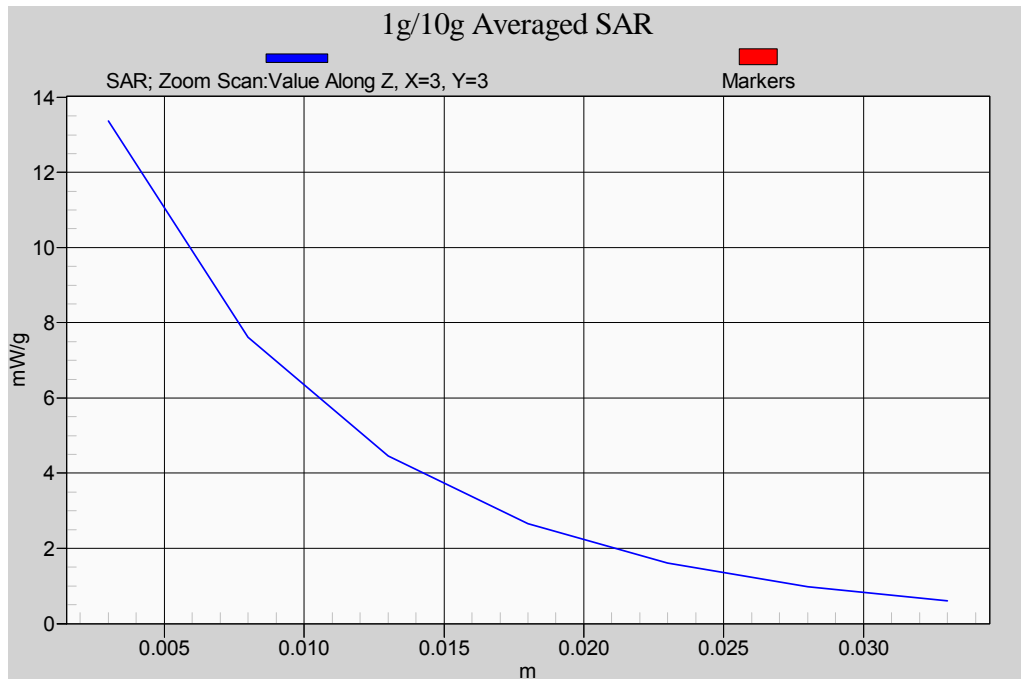

Body-Tissue-Simulating-Liquid 1900MHz (07/01/2012)

Z-axis Plot of System Performance Check

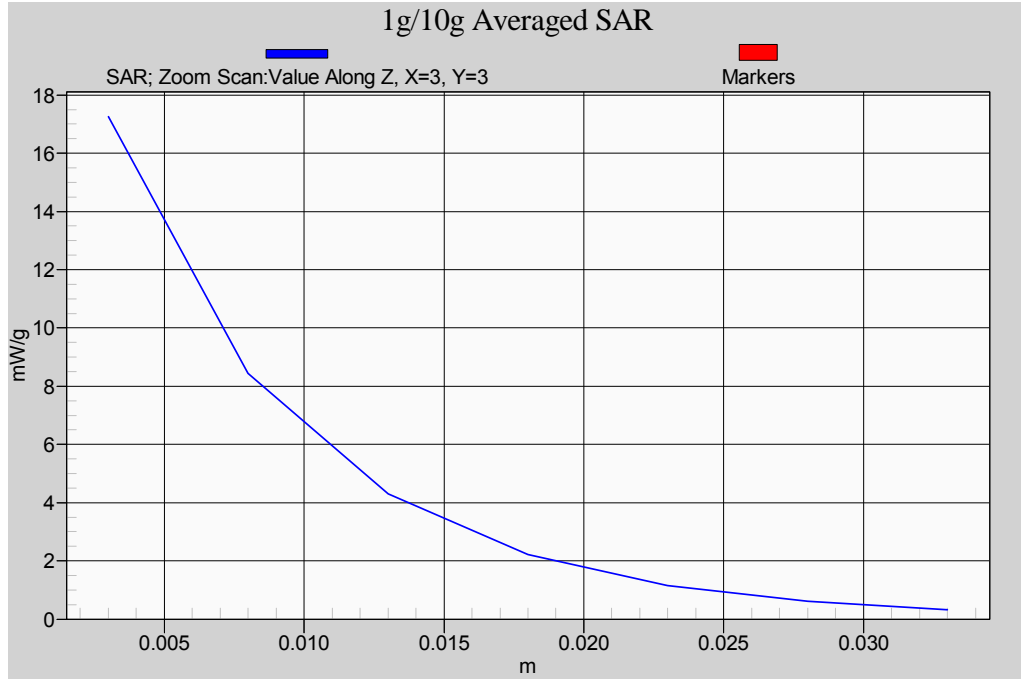

Body-Tissue-Simulating-Liquid 2450MHz (07/02/2012)

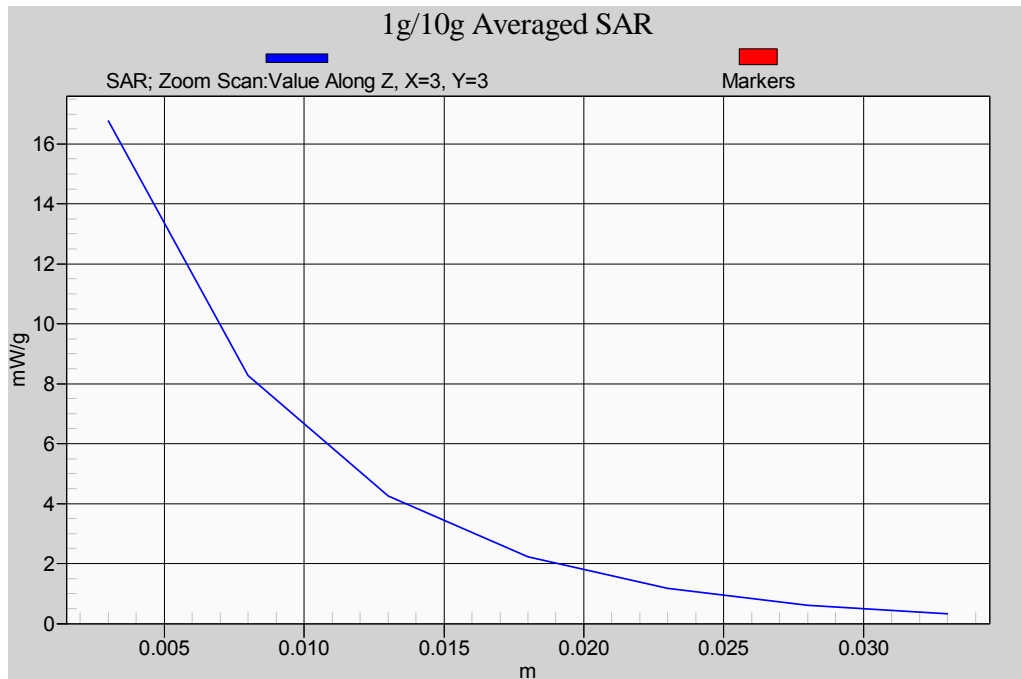

Body-Tissue-Simulating-Liquid 2450MHz (07/03/2012)



7. Test Equipment List

Manufacturer	Name of Equipment	Type/Model	Serial Number	Calibration	
				Last Cal.	Due Date
SPEAG	Dosimetric E-Field Probe	EX3DV4	3847	03/21/2012	03/21/2013
SPEAG	835MHz System Validation Kit	D835V2	4d082	07/19/2011	07/19/2012
SPEAG	1900MHz System Validation Kit	D1900V2	5d111	07/22/2011	07/22/2012
SPEAG	2450MHz System Validation Kit	D2450V2	712	02/23/2012	02/23/2013
SPEAG	Data Acquisition Electronics	DAE4	779	01/23/2012	01/23/2013
SPEAG	Measurement Server	SE UMS 011 AA	1025	NCR	
SPEAG	Device Holder	N/A	N/A	NCR	
SPEAG	Phantom	ELI 4.0	1036	NCR	
SPEAG	Robot	Staubli TX90XL	F07/564ZA1/C/01	NCR	
SPEAG	Software	DASY5 V5.0 Build 125	N/A	NCR	
SPEAG	Software	SEMCAD V13.4 Build 125	N/A	NCR	
Agilent	Dielectric Probe Kit	85070C	US99360094	NCR	
Agilent	ENA Series Network Analyzer	E5071B	MY42404655	04/05/2012	04/05/2014
R&S	Power Sensor	NRP-Z22	100179	05/16/2012	05/16/2013
Agilent	MXG Vector Signal Generator	N5182A	MY47420962	05/24/2011	05/24/2013
Agilent	Dual Directional Coupler	778D	50334	NCR	
Mini-Circuits	Power Amplifier	ZHL-42W-SMA	D111103#5	NCR	
Mini-Circuits	Power Amplifier	ZVE-8G-SMA	D042005 671800514	NCR	
Aisi	Attenuator	IEAT 3dB	N/A	NCR	

Table 10. Test Equipment List



8. Measurement Uncertainty

Measurement uncertainties in SAR measurements are difficult to quantify due to several variables including biological, physiological, and environmental. However, we estimate the measurement uncertainties in SAR to be less than $\pm 19.62\%$ [8]. The frequency range of the measurement uncertainty is 750 ~ 5800MHz $\pm 10.1\%$

According to Std. C95.3 [9], the overall uncertainties are difficult to assess and will vary with the type of meter and usage situation. However, accuracy's of ± 1 to 3 dB can be expected in practice, with greater uncertainties in near-field situations and at higher frequencies (shorter wavelengths), or areas where large reflecting objects are present. Under optimum measurement conditions, SAR measurement uncertainties of at least ± 2 dB can be expected.

According to CENELEC [10] , typical worst-case uncertainty of field measurements is ± 5 dB. For well-defined modulation characteristics the uncertainty can be reduced to ± 3 dB.



Item	Uncertainty Component	Uncertainty Value	Prob. Dist	Div.	c_i (1g)	c_i (10g)	Std. Unc. (1-g)	Std. Unc. (10-g)	V_i or V_{eff}
Measurement System									
u1	Probe Calibration ($k=1$)	$\pm 5.05\%$	Normal	1	1	1	$\pm 5.05\%$	$\pm 5.05\%$	∞
u2	Probe Isotropy	$\pm 7.6\%$	Rectangular	$\sqrt{3}$	0.7	0.7	$\pm 3.1\%$	$\pm 3.1\%$	∞
u3	Boundary Effect	$\pm 1.0\%$	Rectangular	$\sqrt{3}$	1	1	$\pm 0.6\%$	$\pm 0.6\%$	∞
u4	Linearity	$\pm 4.7\%$	Rectangular	$\sqrt{3}$	1	1	$\pm 2.7\%$	$\pm 2.7\%$	∞
u5	System Detection Limit	$\pm 1.0\%$	Rectangular	$\sqrt{3}$	1	1	$\pm 0.58\%$	$\pm 0.58\%$	∞
u6	Readout Electronics	$\pm 0.3\%$	Normal	1	1	1	$\pm 0.3\%$	$\pm 0.3\%$	∞
u7	Response Time	$\pm 0.8\%$	Rectangular	$\sqrt{3}$	1	1	$\pm 0.5\%$	$\pm 0.5\%$	∞
u8	Integration Time	$\pm 2.6\%$	Rectangular	$\sqrt{3}$	1	1	$\pm 1.5\%$	$\pm 1.5\%$	∞
u9	RF Ambient Conditions	$\pm 0\%$	Rectangular	$\sqrt{3}$	1	1	$\pm 0\%$	$\pm 0\%$	∞
u10	RF Ambient Reflections	$\pm 0\%$	Rectangular	$\sqrt{3}$	1	1	$\pm 0\%$	$\pm 0\%$	∞
u11	Probe Positioner Mechanical Tolerance	$\pm 0.4\%$	Rectangular	$\sqrt{3}$	1	1	$\pm 0.2\%$	$\pm 0.2\%$	∞
u12	Probe Positioning with respect to Phantom Shell	$\pm 2.9\%$	Rectangular	$\sqrt{3}$	1	1	$\pm 1.7\%$	$\pm 1.7\%$	∞
u13	Extrapolation, interpolation and integration Algorithms for Max. SAR Evaluation	$\pm 1.0\%$	Rectangular	$\sqrt{3}$	1	1	$\pm 0.6\%$	$\pm 0.6\%$	∞
Test sample Related									
u14	Test sample Positioning	$\pm 3.6\%$	Normal	1	1	1	$\pm 3.6\%$	$\pm 3.6\%$	89
u15	Device Holder Uncertainty	$\pm 3.5\%$	Normal	1	1	1	$\pm 3.5\%$	$\pm 3.5\%$	5
u16	Output Power Variation - SAR drift measurement	$\pm 5.0\%$	Rectangular	$\sqrt{3}$	1	1	$\pm 2.9\%$	$\pm 2.9\%$	∞
Phantom and Tissue Parameters									
u17	Phantom Uncertainty (shape and thickness tolerances)	$\pm 4.0\%$	Rectangular	$\sqrt{3}$	1	1	$\pm 2.3\%$	$\pm 2.3\%$	∞
u18	Liquid Conductivity - deviation from target values	$\pm 5.0\%$	Rectangular	$\sqrt{3}$	0.64	0.43	$\pm 1.8\%$	$\pm 1.2\%$	∞
u19	Liquid Conductivity - measurement uncertainty	$\pm 1.93\%$	Normal	1	0.64	0.43	$\pm 1.24\%$	$\pm 0.83\%$	69
u20	Liquid Permittivity - deviation from target values	$\pm 5.0\%$	Rectangular	$\sqrt{3}$	0.6	0.49	$\pm 1.7\%$	$\pm 1.4\%$	∞
u21	Liquid Permittivity - measurement uncertainty	$\pm 1.4\%$	Normal	1	0.6	0.49	$\pm 0.84\%$	$\pm 1.69\%$	69
Combined standard uncertainty			RSS				$\pm 9.81\%$	$\pm 9.62\%$	313
Expanded uncertainty (95% CONFIDENCE LEVEL)			$k=2$				$\pm 19.62\%$	$\pm 19.24\%$	

Table 11. Uncertainty Budget of DASY



9. Measurement Procedure

The measurement procedures are as follows:

1. For WLAN function, engineering testing software installed on Notebook can provide continuous transmitting signal.
2. Measure output power through RF cable and power meter
3. Set scan area, grid size and other setting on the DASY software
4. Find out the largest SAR result on these testing positions of each band
5. Measure SAR results for other channels in worst SAR testing position if the SAR of highest power channel is larger than 0.8 W/kg

According to the test standard, the recommended procedure for assessing the peak spatial-average SAR value consists of the following steps:

1. Power reference measurement
2. Area scan
3. Zoom scan
4. Power drift measurement

9.1 Spatial Peak SAR Evaluation

The procedure for spatial peak SAR evaluation has been implemented according to the test standard. It can be conducted for 1g and 10g, as well as for user-specific masses. The DASY software includes all numerical procedures necessary to evaluate the spatial peak SAR value.

The base for the evaluation is a "cube" measurement. The measured volume must include the 1g and 10g cubes with the highest averaged SAR values. For that purpose, the center of the measured volume is aligned to the interpolated peak SAR value of a previously performed area scan.

The entire evaluation of the spatial peak values is performed within the post-processing engine (SEMCAD). The system always gives the maximum values for the 1g and 10g cubes. The algorithm to find the cube with highest averaged SAR is divided into the following stages

1. Extraction of the measured data (grid and values) from the Zoom Scan
2. Calculation of the SAR value at every measurement point based on all stored data (A/D values and measurement parameters)
3. Generation of a high-resolution mesh within the measured volume
4. Interpolation of all measured values from the measurement grid to the high-resolution grid
5. Extrapolation of the entire 3-D field distribution to the phantom surface over the distance from sensor to surface
6. Calculation of the averaged SAR within masses of 1g and 10g



9.2 Area & Zoom Scan Procedures

First Area Scan is used to locate the approximate location(s) of the local peak SAR value(s). The measurement grid within an Area Scan is defined by the grid extent, grid step size and grid offset. Next, in order to determine the EM field distribution in a three-dimensional spatial extension, Zoom Scan is required. The Zoom Scan measures 7x7x9 points with step size 5, 5 and 3 mm for 300 MHz to 3 GHz, and 7x7x9 points with step size 5, 5 and 3 mm for 3 GHz to 6 GHz. The Zoom Scan is performed around the highest E-field value to determine the averaged SAR-distribution over 10 g.

9.3 Volume Scan Procedures

The volume scan is used for assess overlapping SAR distributions for antennas transmitting in different frequency bands. It is equivalent to an oversized zoom scan used in standalone measurements. The measurement volume will be used to enclose all the simultaneous transmitting antennas. For antennas transmitting simultaneously in different frequency bands, the volume scan is measured separately in each frequency band. In order to sum correctly to compute the 1g aggregate SAR, the DUT remain in the same test position for all measurements and all volume scan use the same spatial resolution and grid spacing (step-size is 4, 4 and 2.5 mm). When all volume scan were completed, the software, SEMCAD postprocessor can combine and subsequently superpose these measurement data to calculating the multiband SAR.

9.4 SAR Averaged Methods

In DASYS, the interpolation and extrapolation are both based on the modified Quadratic Shepard's method. The interpolation scheme combines a least-square fitted function method and a weighted average method which are the two basic types of computational interpolation and approximation. Extrapolation routines are used to obtain SAR values between the lowest measurement points and the inner phantom surface. The extrapolation distance is determined by the surface detection distance and the probe sensor offset. The uncertainty increases with the extrapolation distance. To keep the uncertainty within 1% for the 1 g and 10 g cubes, the extrapolation distance should not be larger than 5 mm.

9.5 Power Drift Monitoring

All SAR testing is under the DUT install full charged battery and transmit maximum output power. In DASYS measurement software, the power reference measurement and power drift measurement procedures are used for monitoring the power drift of DUT during SAR test. Both these procedures measure the field at a specified reference position before and after the SAR testing. The software will calculate the field difference in dB. If the power drift more than 5%, the SAR will be retested.



10. SAR Test Results Summary

10.1 Head SAR

Measurement Results								
Band	Frequency		Power (dBm)	Phantom Position	Spacing (mm)	SAR _{1g} [mW/g]	Power Drift (dB)	Remark
	CH	MHz						
GSM 850 1Down1Up	128	824.2	33.46	Right-cheek	0	0.31400	0.037000	---
	128	824.2	33.46	Right-Tilted	0	0.16800	0.045000	---
	128	824.2	33.46	Left-cheek	0	0.20000	0.026000	---
	128	824.2	33.46	Left-Tilted	0	0.12700	-0.032000	---
GPRS 850 2Down3Up	128	824.2	30.89	Right-cheek	0	0.36100	0.098000	---
	128	824.2	30.89	Right-Tilted	0	0.19600	0.151000	---
	128	824.2	30.89	Left-cheek	0	0.26000	-0.094000	---
	128	824.2	30.89	Left-Tilted	0	0.18500	0.052000	---
DTM 850 2Down3Up (GSM+GPRS)	128	824.2	30.90	Right-cheek	0	0.30400	0.031000	---
	128	824.2	30.90	Right-Tilted	0	0.16700	0.060000	---
	128	824.2	30.90	Left-cheek	0	0.18900	-0.020000	---
	128	824.2	30.90	Left-Tilted	0	0.13600	0.010000	---
GSM 1900 1Down1Up	661	1880.0	30.02	Right-cheek	0	0.39200	-0.081000	---
	661	1880.0	30.02	Right-Tilted	0	0.45600	-0.122000	---
	661	1880.0	30.02	Left-cheek	0	0.58400	0.055000	---
	661	1880.0	30.02	Left-Tilted	0	0.32700	-0.014000	---
GPRS 1900 2Down3Up	512	1850.2	27.68	Right-cheek	0	0.74800	-0.021000	---
	661	1880.0	27.80	Right-cheek	0	0.96100	-0.079000	---
	810	1909.8	27.58	Right-cheek	0	0.79400	-0.115000	---
	512	1850.2	27.68	Right-Tilted	0	0.78800	0.000452	---
	661	1880.0	27.80	Right-Tilted	0	0.81700	-0.001250	---
	810	1909.8	27.58	Right-Tilted	0	0.71300	-0.008110	---
	512	1850.2	27.68	Left-cheek	0	1.04000	-0.137000	---
	661	1880.0	27.80	Left-cheek	0	1.03000	-0.078000	---
	810	1909.8	27.58	Left-cheek	0	0.83400	-0.023000	---
	661	1880.0	27.80	Left-Tilted	0	0.58200	-0.063000	---
Std. C95.1-1999 - Safety Limit Spatial Peak Uncontrolled Exposure/General Population					1.6 W/kg (mW/g) Averaged over 1 gram			



Measurement Results								
Band	Frequency		Power (dBm)	Phantom Position	Spacing (mm)	SAR _{1g} [mW/g]	Power Drift (dB)	Remark
	CH	MHz						
DTM 1900 2Down3Up (GSM+GPRS)	661	1880.0	27.40	Right-cheek	0	0.79200	-0.017000	---
	512	1850.2	27.35	Right-Tilted	0	0.76600	0.119000	---
	661	1880.0	27.40	Right-Tilted	0	0.80400	-0.040000	---
	810	1909.8	27.15	Right-Tilted	0	0.68700	-0.011000	---
	512	1850.2	27.35	Left-cheek	0	0.97300	0.018000	---
	661	1880.0	27.40	Left-cheek	0	0.84400	-0.006760	---
	810	1909.8	27.15	Left-cheek	0	0.81400	-0.024000	---
	661	1880.0	27.40	Left-Tilted	0	0.57700	-0.043000	---
WCDMA Band V	4233	846.6	22.60	Right-cheek	0	0.19100	-0.002640	---
	4233	846.6	22.60	Right-Tilted	0	0.10100	0.095000	---
	4233	846.6	22.60	Left-cheek	0	0.12800	-0.036000	---
	4233	846.6	22.60	Left-Tilted	0	0.08600	0.093000	---
IEEE 802.11b Rate 1M	11	2462.0	18.07	Right-cheek	0	0.32300	0.070000	---
	11	2462.0	18.07	Right-Tilted	0	0.44500	-0.000607	---
	11	2462.0	18.07	Left-cheek	0	0.39100	0.009450	---
	11	2462.0	18.07	Left-Tilted	0	0.36500	-0.016000	---
Std. C95.1-1999 - Safety Limit Spatial Peak Uncontrolled Exposure/General Population					1.6 W/kg (mW/g) Averaged over 1 gram			



10.2 Body SAR

Measurement Results									
Band	Frequency		Power (dBm)	Phantom Position	Spacing (mm)	Accessory	SAR _{1g} [mW/g]	Power Drift (dB)	Remark
	CH	MHz							
GSM 850 1Down1Up	128	824.2	33.46	Flat	10	Headset	0.17900	-0.013000	Front Surface to Phantom
	128	824.2	33.46	Flat	10	Headset	0.32600	-0.027000	Back Surface to Phantom
GPRS 850 2Down3Up	128	824.2	30.89	Flat	10	N/A	0.31100	-0.182000	Front Surface to Phantom
	128	824.2	30.89	Flat	10	N/A	0.42500	-0.002320	Back Surface to Phantom
	128	824.2	30.89	Flat	10	N/A	0.02700	-0.086000	Edge Bottom to Phantom
	128	824.2	30.89	Flat	10	N/A	0.24700	0.010000	Edge Right to Phantom
	128	824.2	30.89	Flat	10	N/A	0.23100	0.039000	Edge Left to Phantom
DTM 850 2Down3Up (GSM+GPRS)	128	824.2	30.90	Flat	10	Headset	0.35000	-0.149000	Front Surface to Phantom
	128	824.2	30.90	Flat	10	Headset	0.58400	-0.164000	Back Surface to Phantom
GSM 1900 1Down1Up	661	1880.0	30.02	Flat	10	Headset	0.51000	0.098000	Front Surface to Phantom
	661	1880.0	30.02	Flat	10	Headset	0.65800	0.030000	Back Surface to Phantom
GPRS 1900 2Down3Up	512	1850.2	27.68	Flat	10	N/A	1.05000	-0.037000	Front Surface to Phantom
	512	1850.2	27.68	Flat	10	N/A	1.01000	-0.121000	Back Surface to Phantom
	661	1880.0	27.80	Flat	10	N/A	0.90500	-0.075000	Front Surface to Phantom
	661	1880.0	27.80	Flat	10	N/A	1.23000	0.035000	Back Surface to Phantom
	661	1880.0	27.80	Flat	10	N/A	0.46700	0.020000	Edge Bottom to Phantom
	661	1880.0	27.80	Flat	10	N/A	0.36200	-0.042000	Edge Right to Phantom
	661	1880.0	27.80	Flat	10	N/A	0.29100	0.006570	Edge Left to Phantom
	810	1909.8	27.58	Flat	10	N/A	0.88600	-0.121000	Front Surface to Phantom
	810	1909.8	27.58	Flat	10	N/A	1.00000	-0.000288	Back Surface to Phantom
DTM 1900 2Down3Up (GSM+GPRS)	512	1850.2	27.35	Flat	10	Headset	0.80700	-0.088000	Front Surface to Phantom
	512	1850.2	27.35	Flat	10	Headset	1.34000	0.026000	Back Surface to Phantom
	661	1880.0	27.40	Flat	10	Headset	0.92200	-0.059000	Front Surface to Phantom
	661	1880.0	27.40	Flat	10	Headset	1.35000	0.107000	Back Surface to Phantom
	810	1909.8	27.15	Flat	10	Headset	0.81500	-0.054000	Front Surface to Phantom
	810	1909.8	27.15	Flat	10	Headset	1.08000	-0.006520	Back Surface to Phantom
Std. C95.1-1999 - Safety Limit Spatial Peak Uncontrolled Exposure/General Population						1.6 W/kg (mW/g) Averaged over 1 gram			

Measurement Results									
Band	Frequency		Power (dBm)	Phantom Position	Spacing (mm)	Accessory	SAR _{1g} [mW/g]	Power Drift (dB)	Remark
	CH	MHz							
WCDMA Band V	4233	846.6	22.60	Flat	10	N/A	0.17800	-0.014000	Front Surface to Phantom
	4233	846.6	22.60	Flat	10	N/A	0.31400	-0.042000	Back Surface to Phantom
	4233	846.6	22.60	Flat	10	N/A	0.01700	-0.162000	Edge Bottom to Phantom
	4233	846.6	22.60	Flat	10	N/A	0.11500	0.042000	Edge Right to Phantom
	4233	846.6	22.60	Flat	10	N/A	0.13600	0.034000	Edge Left to Phantom
IEEE 802.11b Rate 1M	11	2462.0	18.07	Flat	10	N/A	0.14100	0.039000	Front Surface to Phantom
	11	2462.0	18.07	Flat	10	N/A	0.30900	0.068000	Back Surface to Phantom
	11	2462.0	18.07	Flat	10	N/A	0.26400	0.026000	Edge Top to Phantom
	11	2462.0	18.07	Flat	10	N/A	0.17000	0.147000	Edge Right to Phantom
	11	2462.0	18.07	Flat	10	N/A	0.03800	0.054000	Edge Left to Phantom
Bluetooth v3.0	39	2441.0	-1.09	Flat	10	N/A	0.00513	0.161000	Front Surface to Phantom
	39	2441.0	-1.09	Flat	10	N/A	0.02100	0.041000	Back Surface to Phantom
Bluetooth v4.0 LE	19	2440.0	0.25	Flat	10	N/A	0.00417	0.041000	Front Surface to Phantom
	19	2440.0	0.25	Flat	10	N/A	0.01980	0.127000	Back Surface to Phantom
Std. C95.1-1999 - Safety Limit Spatial Peak Uncontrolled Exposure/General Population						1.6 W/kg (mW/g) Averaged over 1 gram			

Note:

1. The test data reported are the worst-case SAR value with the position set in a typical configuration. Test procedures used were according to FCC/OET Bulletin 65, Supplement C [June 2001], IEEE1528-2003.
2. All modes of operation were investigated, and worst-case results are reported.
3. Tissue parameters and temperatures are listed on the SAR plots.
4. Batteries are fully charged for all readings.
5. If the conducted power of (802.11g and 802.11n) are higher than 802.11b 0.25dB, (802.11g and 802.11n) are supposed to be tested.
6. For hot-spot mode, the WWAN antenna location to edge >2.5 cm. Therefore test Edge Top is not required.
7. For hot-spot mode, the WLAN antenna location to edge >2.5 cm. Therefore test Edge Bottom is not required.
8. HSDPA & HSUPA power are not more than WCDMA 0.25dB and the SAR value of WCDMA <1.2 mW/g. Therefore HSDPA & HSUPA Stand-alone SAR is not required.



10.3 Std. C95.1-1999 RF Exposure Limit

Human Exposure	Population Uncontrolled Exposure (W/kg) or (mW/g)	Occupational Controlled Exposure (W/kg) or (mW/g)
Spatial Peak SAR* (head)	1.60	8.00
Spatial Peak SAR** (Whole Body)	0.08	0.40
Spatial Peak SAR*** (Partial-Body)	1.60	8.00
Spatial Peak SAR**** (Hands / Feet / Ankle / Wrist)	4.00	20.00

Table 12. Safety Limits for Partial Body Exposure

Notes :

- * The Spatial Peak value of the SAR averaged over any 1 gram of tissue.
(defined as a tissue volume in the shape of a cube) and over the appropriate averaging time.
- ** The Spatial Average value of the SAR averaged over the whole – body.
- *** The Spatial Average value of the SAR averaged over the partial – body.
- **** The Spatial Peak value of the SAR averaged over any 10 grams of tissue.
(defined as a tissue volume in the shape of a cube) and over the appropriate averaging time.

Population / Uncontrolled Environments : are defined as locations where there is the exposure of individuals who have no knowledge or control of their exposure.

Occupational / Controlled Environments : are defined as locations where there is exposure that may be incurred by persons who are aware of the potential for exposure, (i.e. as a result of employment or occupation).



11. Conclusion

The SAR test values found for the portable mobile phone **HTC Corporation Trade Name : HTC Model(s) : PM66100** is below the maximum recommended level of 1.6 W/kg (mW/g).

12. References

- [1] Std. C95.1-1999, "American National Standard safety levels with respect to human exposure to radio frequency electromagnetic fields, 300KHz to 100GHz", New York.
- [2] NCRP, National Council on Radiation Protection and Measurements, "Biological Effects and Exposure Criteria for Radio frequency Electromagnetic Fields", NCRP report NO. 86, 1986.
- [3] T. Schmid, O. Egger, and N. Kuster, "Automatic E-field scanning system for dosimetric assessments", IEEE Transactions on Microwave Theory and Techniques, vol. 44, pp, 105-113, Jan. 1996.
- [4] K. Poković, T. Schmid, and N. Kuster, "Robust setup for precise calibration of E-field probes in tissue simulating liquids at mobile communications frequency", in ICECOM'97, Dubrovnik, October 15-17, 1997, pp.120-124.
- [5] K. Poković, T. Schmid, and N. Kuster, "E-field probe with improved isotropy in brain simulating liquids", in Proceedings of the ELMAR, Zadar, Croatia, 23-25 June, 1996, pp.172-175.
- [6] N. Kuster, and Q. Balzano, "Energy absorption mechanism by biological bodies in the near field of dipole antennas above 300MHz", IEEE Transaction on Vehicular Technology, vol. 41, no. 1, Feb. 1992, pp. 17-23.
- [7] Robert J. Renka, "Multivariate Interpolation Of Large Sets Of Scattered Data", University of North Texas ACM Transactions on Mathematical Software, vol. 14, no. 2, June 1988 , pp. 139-148.
- [8] N. Kuster, R. Kastle, T. Schmid, "Dosimetric evaluation of mobile communications equipment with known precision, IEEE Transaction on Communications, vol. E80-B, no. 5, May 1997, pp. 645-652.
- [9] Std. C95.3-1991, "IEEE Recommended Practice for the Measurement of Potentially Hazardous Electromagnetic Fields – RF and Microwave, New York: IEEE, Aug. 1992.
- [10] CENELEC CLC/SC111B, European Prestandard (prENV 50166-2), Human Exposure to Electromagnetic Fields High-frequency. 10KHz-300GHz, Jan. 1995.
- [11] KDB248227 D01 SAR meas for 802 11 a b g v01r02.
- [12] KDB 648474 D01 SAR Handsets Multi Xmitter and Ant v01r05
- [13] KDB 941225 D01 SAR Test for 3G Devices 3G-SAR
- [14] KDB 941225 D03 SAR Test Reduction GSM GPRS EDGE
- [15] KDB 941225 D04 SAR for GSM E GPRS Dual Xfer Mode v01
- [16] KDB 941225 D06 Hot Spot SAR v01



Appendix A - System Performance Check

Test Laboratory: A Test Lab Techno Corp.
Date/Time: 6/26/2012 10:26:54 AM

System Performance Check at 835MHz_20120626_Head

DUT: Dipole 835 MHz; Type: D835V2; Serial: D835V2 - SN:4d082

Communication System: CW; Frequency: 835 MHz; Duty Cycle: 1:1
Medium parameters used: $f = 835$ MHz; $\sigma = 0.913$ mho/m; $\epsilon_r = 41$; $\rho = 1000$ kg/m³
Phantom section: Flat Section
Measurement Standard: DASYS (IEEE/IEC)

DASY5 Configuration:

- Area Scan setting - Find Secondary Maximum Within:2.0dB and with a peak SAR value greater than 0.5 W/Kg
- Probe: EX3DV4 - SN3847; ConvF(9.34, 9.34, 9.34); Calibrated: 3/21/2012
- Sensor-Surface: 3mm (Mechanical Surface Detection)
- Electronics: DAE4 Sn779; Calibrated: 1/23/2012
- Phantom: SAM 12; Type: SAM v4.0; Serial: TP:1009
- Measurement SW: DASYS, V5.0 Build 125;SEMCAD X Version 13.4 Build 125

System Performance Check at 835MHz/Area Scan (61x121x1):

Measurement grid: dx=15mm, dy=15mm
Maximum value of SAR (interpolated) = 2.88 mW/g

System Performance Check at 835MHz/Zoom Scan (7x7x7)/Cube 0:

Measurement grid: dx=5mm, dy=5mm, dz=5mm
Reference Value = 56.9 V/m; Power Drift = -0.141 dB
Peak SAR (extrapolated) = 3.63 W/kg
SAR(1 g) = 2.42 mW/g; SAR(10 g) = 1.58 mW/g
Maximum value of SAR (measured) = 2.84 mW/g

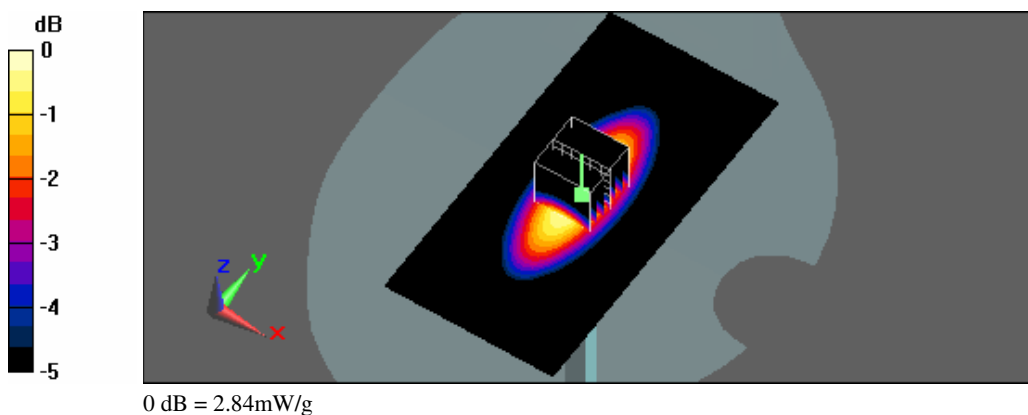

Test Laboratory: A Test Lab Techno Corp.
Date/Time: 7/5/2012 12:32:01 AM

System Performance Check at 835MHz_20120705_Head

DUT: Dipole 835 MHz; Type: D835V2; Serial: D835V2 - SN:4d082

Communication System: CW; Frequency: 835 MHz; Duty Cycle: 1:1
Medium parameters used: $f = 835 \text{ MHz}$; $\sigma = 0.913 \text{ mho/m}$; $\epsilon_r = 41$; $\rho = 1000 \text{ kg/m}^3$
Phantom section: Flat Section
Measurement Standard: DASYS (IEEE/IEC)

DASY5 Configuration:

- Area Scan setting - Find Secondary Maximum Within:2.0dB and with a peak SAR value greater than 0.5 W/Kg
- Probe: EX3DV4 - SN3847; ConvF(9.34, 9.34, 9.34); Calibrated: 3/21/2012
- Sensor-Surface: 3mm (Mechanical Surface Detection)
- Electronics: DAE4 Sn779; Calibrated: 1/23/2012
- Phantom: SAM 12; Type: SAM v4.0; Serial: TP:1009
- Measurement SW: DASY5, V5.0 Build 125;SEMCAD X Version 13.4 Build 125

System Performance Check at 835MHz/Area Scan (61x121x1):

Measurement grid: $dx=15\text{mm}$, $dy=15\text{mm}$
Maximum value of SAR (interpolated) = 2.77 mW/g

System Performance Check at 835MHz/Zoom Scan (7x7x7)/Cube 0:

Measurement grid: $dx=5\text{mm}$, $dy=5\text{mm}$, $dz=5\text{mm}$
Reference Value = 55.8 V/m; Power Drift = -0.00442 dB
Peak SAR (extrapolated) = 3.59 W/kg
SAR(1 g) = 2.38 mW/g; SAR(10 g) = 1.55 mW/g
Maximum value of SAR (measured) = 2.8 mW/g

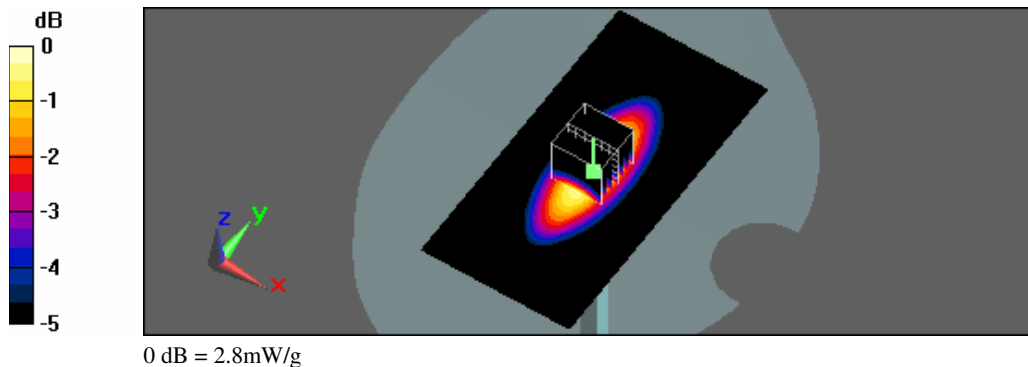

Test Laboratory: A Test Lab Techno Corp.
Date/Time: 6/27/2012 6:01:40 AM

System Performance Check at 1900MHz_20120627_Head

DUT: Dipole D1900V2_SN5d111; Type: D1900V2; Serial: D1900V2 - SN:5d111

Communication System: CW; Frequency: 1900 MHz; Duty Cycle: 1:1
Medium parameters used: $f = 1900$ MHz; $\sigma = 1.39$ mho/m; $\epsilon_r = 39$; $\rho = 1000$ kg/m³
Phantom section: Flat Section
Measurement Standard: DASYS (IEEE/IEC)

DASY5 Configuration:

- Area Scan setting - Find Secondary Maximum Within:2.0dB and with a peak SAR value greater than 0.5 W/Kg
- Probe: EX3DV4 - SN3847; ConvF(8.05, 8.05, 8.05); Calibrated: 3/21/2012
- Sensor-Surface: 3mm (Mechanical Surface Detection)
- Electronics: DAE4 Sn779; Calibrated: 1/23/2012
- Phantom: SAM 12; Type: SAM v4.0; Serial: TP:1009
- Measurement SW: DASYS, V5.0 Build 125;SEMCAD X Version 13.4 Build 125

System Performance Check at 1900MHz/Area Scan (61x61x1):

Measurement grid: dx=15mm, dy=15mm
Maximum value of SAR (interpolated) = 12.9 mW/g

System Performance Check at 1900MHz/Zoom Scan (7x7x7)/Cube 0:

Measurement grid: dx=5mm, dy=5mm, dz=5mm
Reference Value = 95.6 V/m; Power Drift = 0.011 dB
Peak SAR (extrapolated) = 18.5 W/kg
SAR(1 g) = 9.97 mW/g; SAR(10 g) = 5.2 mW/g
Maximum value of SAR (measured) = 12.7 mW/g

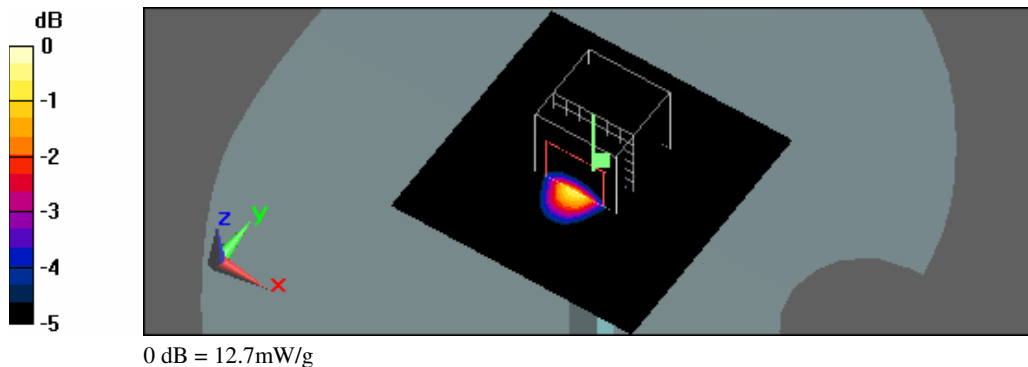

Test Laboratory: A Test Lab Techno Corp.
Date/Time: 6/28/2012 9:33:23 AM

System Performance Check at 1900MHz_20120628_Head

DUT: Dipole D1900V2_SN5d111; Type: D1900V2; Serial: D1900V2 - SN:5d111

Communication System: CW; Frequency: 1900 MHz; Duty Cycle: 1:1
Medium parameters used: $f = 1900 \text{ MHz}$; $\sigma = 1.39 \text{ mho/m}$; $\epsilon_r = 39$; $\rho = 1000 \text{ kg/m}^3$
Phantom section: Flat Section
Measurement Standard: DASYS (IEEE/IEC)

DASY5 Configuration:

- Area Scan setting - Find Secondary Maximum Within:2.0dB and with a peak SAR value greater than 0.5 W/Kg
- Probe: EX3DV4 - SN3847; ConvF(8.05, 8.05, 8.05); Calibrated: 3/21/2012
- Sensor-Surface: 3mm (Mechanical Surface Detection)
- Electronics: DAE4 Sn779; Calibrated: 1/23/2012
- Phantom: SAM 12; Type: SAM v4.0; Serial: TP:1009
- Measurement SW: DASYS, V5.0 Build 125; SEMCAD X Version 13.4 Build 125

System Performance Check at 1900MHz/Area Scan (61x61x1):

Measurement grid: $dx=15\text{mm}$, $dy=15\text{mm}$
Maximum value of SAR (interpolated) = 12.7 mW/g

System Performance Check at 1900MHz/Zoom Scan (7x7x7)/Cube 0:

Measurement grid: $dx=5\text{mm}$, $dy=5\text{mm}$, $dz=5\text{mm}$
Reference Value = 95.8 V/m; Power Drift = -0.142 dB
Peak SAR (extrapolated) = 18.3 W/kg
SAR(1 g) = 9.69 mW/g; SAR(10 g) = 4.99 mW/g
Maximum value of SAR (measured) = 12.3 mW/g

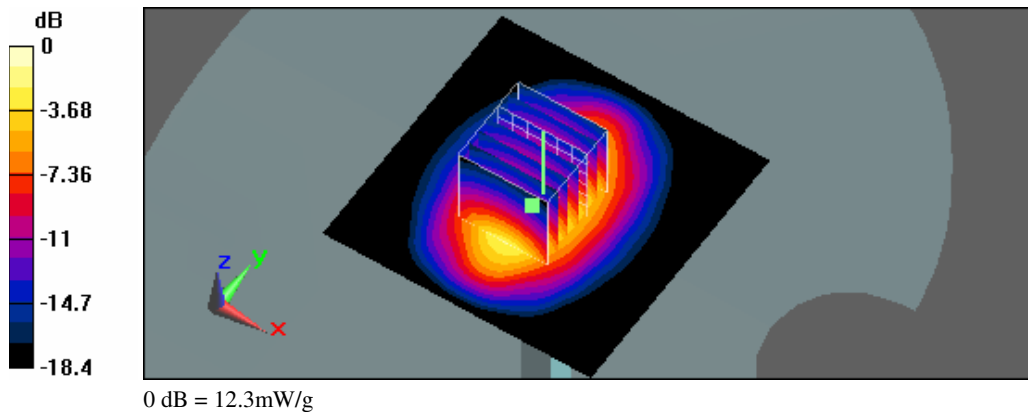

Test Laboratory: A Test Lab Techno Corp.
Date/Time: 7/3/2012 9:37:45 AM

System Performance Check at 2450MHz_20120703_Head

DUT: Dipole 2450 MHz; Type: D2450V2; Serial: D2450V2 - SN:712

Communication System: CW; Frequency: 2450 MHz; Duty Cycle: 1:1
Medium parameters used: $f = 2450 \text{ MHz}$; $\sigma = 1.81 \text{ mho/m}$; $\epsilon_r = 39.5$; $\rho = 1000 \text{ kg/m}^3$
Phantom section: Flat Section
Measurement Standard: DASYS (IEEE/IEC)

DASY5 Configuration:

- Area Scan setting - Find Secondary Maximum Within:2.0dB and with a peak SAR value greater than 0.5 W/Kg
- Probe: EX3DV4 - SN3847; ConvF(7.17, 7.17, 7.17); Calibrated: 3/21/2012
- Sensor-Surface: 3mm (Mechanical Surface Detection)
- Electronics: DAE4 Sn779; Calibrated: 1/23/2012
- Phantom: SAM 12; Type: SAM v4.0; Serial: TP:1009
- Measurement SW: DASY5, V5.0 Build 125;SEMCAD X Version 13.4 Build 125

System Performance Check at 2450MHz/Area Scan (61x61x1):

Measurement grid: $dx=15\text{mm}$, $dy=15\text{mm}$
Maximum value of SAR (interpolated) = 17.4 mW/g

System Performance Check at 2450MHz/Zoom Scan (7x7x7)/Cube 0:

Measurement grid: $dx=5\text{mm}$, $dy=5\text{mm}$, $dz=5\text{mm}$
Reference Value = 98.5 V/m; Power Drift = 0.015 dB
Peak SAR (extrapolated) = 27.2 W/kg
SAR(1 g) = 13.1 mW/g; SAR(10 g) = 6 mW/g
Maximum value of SAR (measured) = 17.4 mW/g

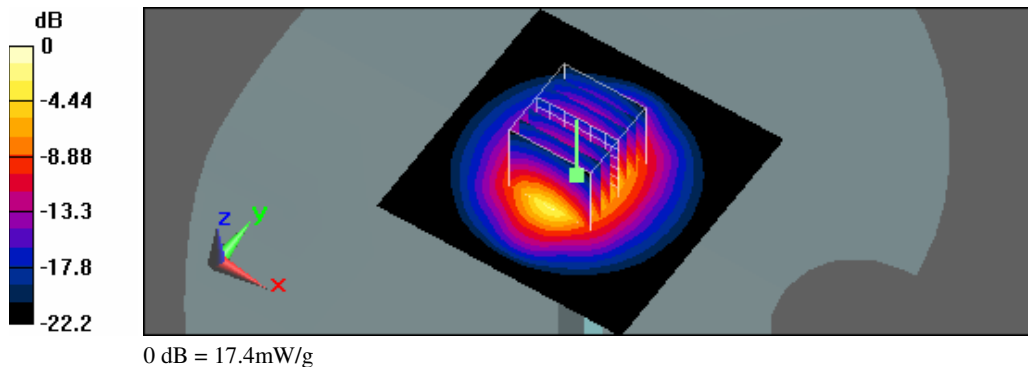

Test Laboratory: A Test Lab Techno Corp.
Date/Time: 6/28/2012 8:46:20 PM

System Performance Check at 835MHz_20120628_Body

DUT: Dipole 835 MHz; Type: D835V2; Serial: D835V2 - SN:4d082

Communication System: CW; Frequency: 835 MHz; Duty Cycle: 1:1
Medium parameters used: $f = 835 \text{ MHz}$; $\sigma = 0.99 \text{ mho/m}$; $\epsilon_r = 55.1$; $\rho = 1000 \text{ kg/m}^3$
Phantom section: Flat Section
Measurement Standard: DASYS (IEEE/IEC)

DASY5 Configuration:

- Area Scan setting - Find Secondary Maximum Within:2.0dB and with a peak SAR value greater than 0.5 W/Kg
- Probe: EX3DV4 - SN3847; ConvF(9.24, 9.24, 9.24); Calibrated: 3/21/2012
- Sensor-Surface: 3mm (Mechanical Surface Detection)
- Electronics: DAE4 Sn779; Calibrated: 1/23/2012
- Phantom: SAM 12; Type: SAM v4.0; Serial: TP:1009
- Measurement SW: DASY5, V5.0 Build 125;SEMCAD X Version 13.4 Build 125

System Performance Check at 835MHz/Area Scan (61x121x1):

Measurement grid: $dx=15\text{mm}$, $dy=15\text{mm}$
Maximum value of SAR (interpolated) = 2.83 mW/g

System Performance Check at 835MHz/Zoom Scan (7x7x7)/Cube 0:

Measurement grid: $dx=5\text{mm}$, $dy=5\text{mm}$, $dz=5\text{mm}$
Reference Value = 54 V/m; Power Drift = -0.041 dB
Peak SAR (extrapolated) = 3.49 W/kg
SAR(1 g) = 2.41 mW/g; SAR(10 g) = 1.58 mW/g
Maximum value of SAR (measured) = 2.81 mW/g

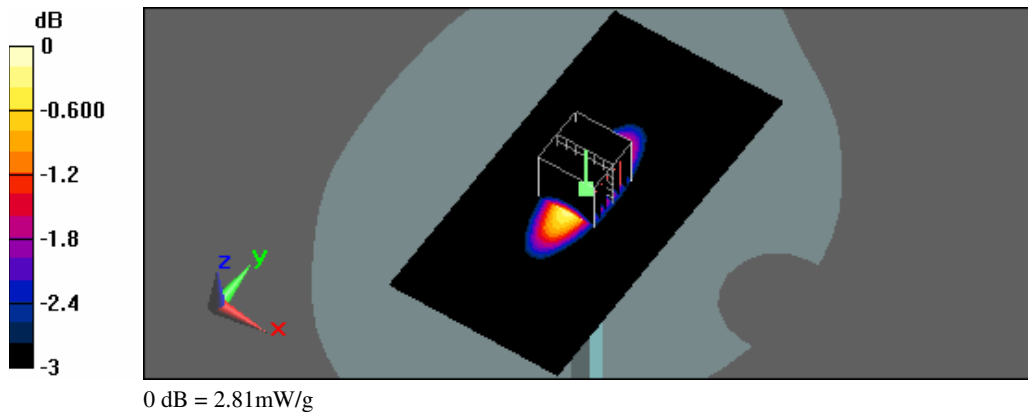

Test Laboratory: A Test Lab Techno Corp.
Date/Time: 6/29/2012 7:13:51 PM

System Performance Check at 1900MHz_20120629_Body

DUT: Dipole D1900V2_SN5d111; Type: D1900V2; Serial: D1900V2 - SN:5d111

Communication System: CW; Frequency: 1900 MHz; Duty Cycle: 1:1
Medium parameters used: $f = 1900$ MHz; $\sigma = 1.49$ mho/m; $\epsilon_r = 51.1$; $\rho = 1000$ kg/m³
Phantom section: Flat Section
Measurement Standard: DASYS (IEEE/IEC)

DASY5 Configuration:

- Area Scan setting - Find Secondary Maximum Within:2.0dB and with a peak SAR value greater than 0.5 W/Kg
- Probe: EX3DV4 - SN3847; ConvF(7.2, 7.2, 7.2); Calibrated: 3/21/2012
- Sensor-Surface: 3mm (Mechanical Surface Detection)
- Electronics: DAE4 Sn779; Calibrated: 1/23/2012
- Phantom: SAM 12; Type: SAM v4.0; Serial: TP:1009
- Measurement SW: DASY5, V5.0 Build 125;SEMCAD X Version 13.4 Build 125

System Performance Check at 1900MHz/Area Scan (61x61x1):

Measurement grid: dx=15mm, dy=15mm
Maximum value of SAR (interpolated) = 13.3 mW/g

System Performance Check at 1900MHz/Zoom Scan (7x7x7)/Cube 0:

Measurement grid: dx=5mm, dy=5mm, dz=5mm
Reference Value = 94.7 V/m; Power Drift = 0.042 dB
Peak SAR (extrapolated) = 18.8 W/kg
SAR(1 g) = 10.4 mW/g; SAR(10 g) = 5.46 mW/g
Maximum value of SAR (measured) = 13.3 mW/g

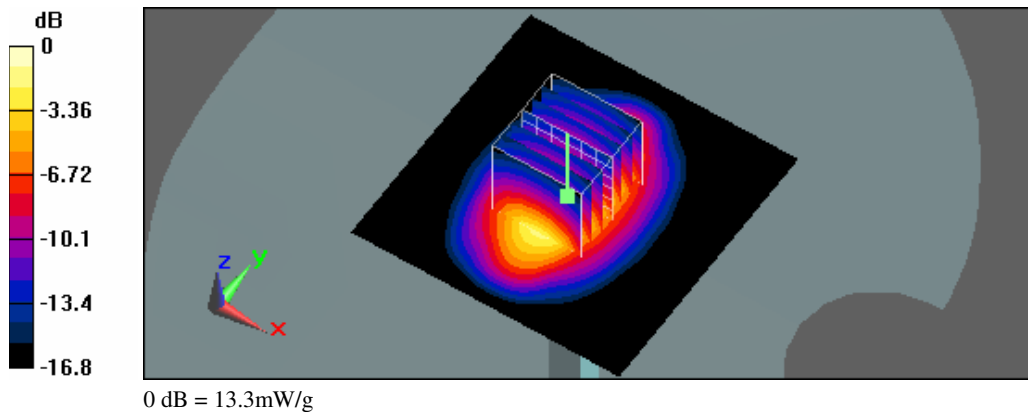

Test Laboratory: A Test Lab Techno Corp.
Date/Time: 7/1/2012 9:16:35 AM

System Performance Check at 1900MHz_20120701_Body

DUT: Dipole D1900V2_SN5d111; Type: D1900V2; Serial: D1900V2 - SN:5d111

Communication System: CW; Frequency: 1900 MHz; Duty Cycle: 1:1
Medium parameters used: $f = 1900 \text{ MHz}$; $\sigma = 1.49 \text{ mho/m}$; $\epsilon_r = 51.1$; $\rho = 1000 \text{ kg/m}^3$
Phantom section: Flat Section
Measurement Standard: DASYS (IEEE/IEC)

DASY5 Configuration:

- Area Scan setting - Find Secondary Maximum Within:2.0dB and with a peak SAR value greater than 0.5 W/Kg
- Probe: EX3DV4 - SN3847; ConvF(7.2, 7.2, 7.2); Calibrated: 3/21/2012
- Sensor-Surface: 3mm (Mechanical Surface Detection)
- Electronics: DAE4 Sn779; Calibrated: 1/23/2012
- Phantom: SAM 12; Type: SAM v4.0; Serial: TP:1009
- Measurement SW: DASYS, V5.0 Build 125;SEMCAD X Version 13.4 Build 125

System Performance Check at 1900MHz/Area Scan (61x61x1):

Measurement grid: $dx=15\text{mm}$, $dy=15\text{mm}$
Maximum value of SAR (interpolated) = 13.7 mW/g

System Performance Check at 1900MHz/Zoom Scan (7x7x7)/Cube 0:

Measurement grid: $dx=5\text{mm}$, $dy=5\text{mm}$, $dz=5\text{mm}$
Reference Value = 94 V/m; Power Drift = 0.026 dB
Peak SAR (extrapolated) = 19.1 W/kg
SAR(1 g) = 10.5 mW/g; SAR(10 g) = 5.49 mW/g
Maximum value of SAR (measured) = 13.4 mW/g

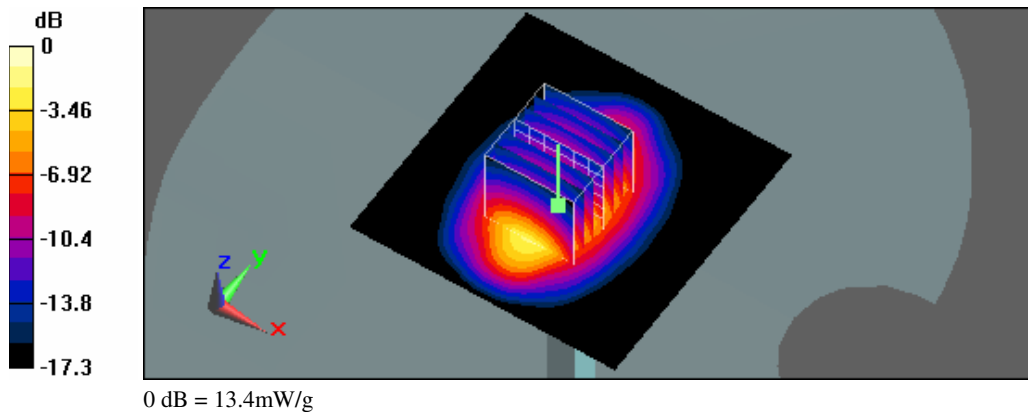

Test Laboratory: A Test Lab Techno Corp.
Date/Time: 7/2/2012 7:07:28 PM

System Performance Check at 2450MHz_20120702_Body

DUT: Dipole 2450 MHz; Type: D2450V2; Serial: D2450V2 - SN:712

Communication System: CW; Frequency: 2450 MHz; Duty Cycle: 1:1
Medium parameters used: $f = 2450$ MHz; $\sigma = 1.98$ mho/m; $\epsilon_r = 51.2$; $\rho = 1000$ kg/m³
Phantom section: Flat Section
Measurement Standard: DASYS (IEEE/IEC)

DASY5 Configuration:

- Area Scan setting - Find Secondary Maximum Within:2.0dB and with a peak SAR value greater than 0.5 W/Kg
- Probe: EX3DV4 - SN3847; ConvF(6.85, 6.85, 6.85); Calibrated: 3/21/2012
- Sensor-Surface: 3mm (Mechanical Surface Detection)
- Electronics: DAE4 Sn779; Calibrated: 1/23/2012
- Phantom: SAM 12; Type: SAM v4.0; Serial: TP:1009
- Measurement SW: DASY5, V5.0 Build 125;SEMCAD X Version 13.4 Build 125

System Performance Check at 2450MHz/Area Scan (61x61x1):

Measurement grid: dx=15mm, dy=15mm
Maximum value of SAR (interpolated) = 17.3 mW/g

System Performance Check at 2450MHz/Zoom Scan (7x7x7)/Cube 0:

Measurement grid: dx=5mm, dy=5mm, dz=5mm
Reference Value = 93.5 V/m; Power Drift = -0.00637 dB
Peak SAR (extrapolated) = 27.3 W/kg
SAR(1 g) = 12.9 mW/g; SAR(10 g) = 5.86 mW/g
Maximum value of SAR (measured) = 17.3 mW/g

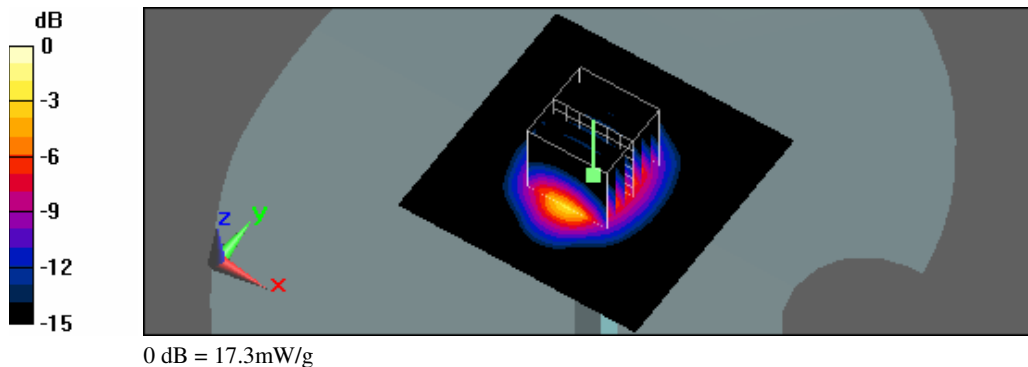

Test Laboratory: A Test Lab Techno Corp.
Date/Time: 7/3/2012 5:40:44 PM

System Performance Check at 2450MHz_20120703_Body

DUT: Dipole 2450 MHz; Type: D2450V2; Serial: D2450V2 - SN:712

Communication System: CW; Frequency: 2450 MHz; Duty Cycle: 1:1
Medium parameters used: $f = 2450$ MHz; $\sigma = 1.98$ mho/m; $\epsilon_r = 51.2$; $\rho = 1000$ kg/m³
Phantom section: Flat Section
Measurement Standard: DASYS (IEEE/IEC)

DASY5 Configuration:

- Area Scan setting - Find Secondary Maximum Within:2.0dB and with a peak SAR value greater than 0.5 W/Kg
- Probe: EX3DV4 - SN3847; ConvF(6.85, 6.85, 6.85); Calibrated: 3/21/2012
- Sensor-Surface: 3mm (Mechanical Surface Detection)
- Electronics: DAE4 Sn779; Calibrated: 1/23/2012
- Phantom: SAM 12; Type: SAM v4.0; Serial: TP:1009
- Measurement SW: DASY5, V5.0 Build 125; SEMCAD X Version 13.4 Build 125

System Performance Check at 2450MHz/Area Scan (61x61x1):

Measurement grid: dx=15mm, dy=15mm
Maximum value of SAR (interpolated) = 17 mW/g

System Performance Check at 2450MHz/Zoom Scan (7x7x7)/Cube 0:

Measurement grid: dx=5mm, dy=5mm, dz=5mm
Reference Value = 93.3 V/m; Power Drift = -0.012 dB
Peak SAR (extrapolated) = 26.3 W/kg
SAR(1 g) = 12.6 mW/g; SAR(10 g) = 5.75 mW/g
Maximum value of SAR (measured) = 16.8 mW/g

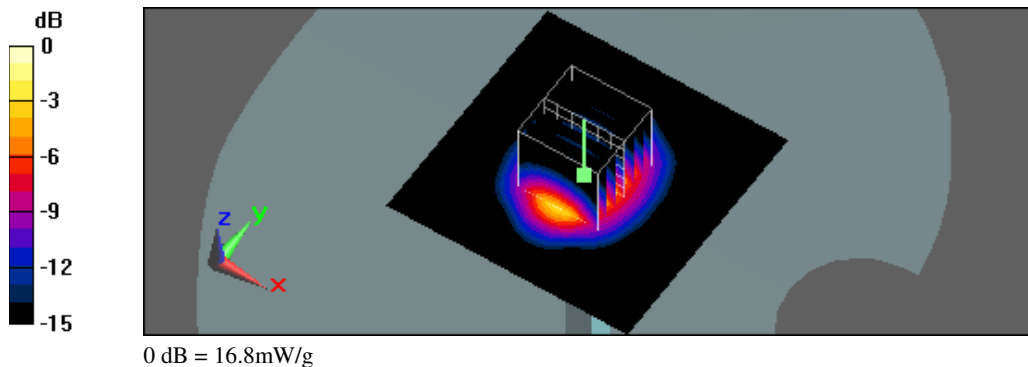



Appendix B - SAR Measurement Data

Test Laboratory: A Test Lab Techno Corp.
Date/Time: 7/5/2012 1:34:22 AM

RC_GSM 850 CH128

DUT: PM66100; Type: Smartphone; FCC ID: NM8PM66100

Communication System: GSM850; Frequency: 824.2 MHz; Duty Cycle: 1:8
Medium parameters used (interpolated): $f = 824.2$ MHz; $\sigma = 0.903$ mho/m; $\epsilon_r = 41$; $\rho = 1000$ kg/m³
Phantom section: Right Section
Measurement Standard: DASYS (IEEE/IEC)

DASY5 Configuration:

- Area Scan setting - Find Secondary Maximum Within: 2.0dB and with a peak SAR value greater than 0.5 W/Kg
- Probe: EX3DV4 - SN3847; ConvF(9.34, 9.34, 9.34); Calibrated: 3/21/2012
- Sensor-Surface: 3mm (Mechanical Surface Detection)
- Electronics: DAE4 Sn779; Calibrated: 1/23/2012
- Phantom: SAM 12; Type: SAM v4.0; Serial: TP:1009
- Measurement SW: DASY5, V5.0 Build 125; SEMCAD X Version 13.4 Build 125

Right Cheek/Area Scan (71x101x1):

Measurement grid: dx=15mm, dy=15mm
Maximum value of SAR (interpolated) = 0.358 mW/g

Right Cheek/Zoom Scan (7x7x9)/Cube 0:

Measurement grid: dx=5mm, dy=5mm, dz=3mm
Reference Value = 5.35 V/m; Power Drift = 0.037 dB
Peak SAR (extrapolated) = 0.395 W/kg
SAR(1 g) = 0.314 mW/g; SAR(10 g) = 0.230 mW/g
Maximum value of SAR (measured) = 0.348 mW/g

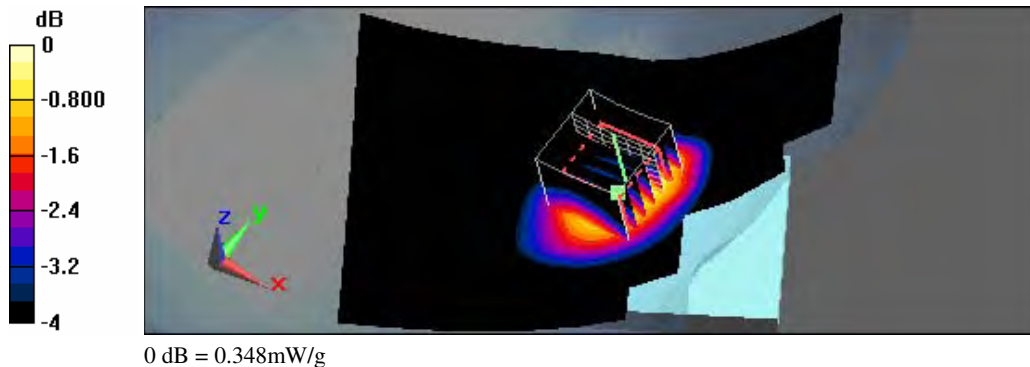



Test Laboratory: A Test Lab Techno Corp.
Date/Time: 7/5/2012 2:03:30 AM

RT_GSM 850 CH128

DUT: PM66100; Type: Smartphone; FCC ID: NM8PM66100

Communication System: GSM850; Frequency: 824.2 MHz; Duty Cycle: 1:8
Medium parameters used (interpolated): $f = 824.2$ MHz; $\sigma = 0.903$ mho/m; $\epsilon_r = 41$; $\rho = 1000$ kg/m³
Phantom section: Right Section
Measurement Standard: DASYS (IEEE/IEC)

DASY5 Configuration:

- Area Scan setting - Find Secondary Maximum Within: 2.0dB and with a peak SAR value greater than 0.5 W/Kg
- Probe: EX3DV4 - SN3847; ConvF(9.34, 9.34, 9.34); Calibrated: 3/21/2012
- Sensor-Surface: 3mm (Mechanical Surface Detection)
- Electronics: DAE4 Sn779; Calibrated: 1/23/2012
- Phantom: SAM 12; Type: SAM v4.0; Serial: TP:1009
- Measurement SW: DASYS, V5.0 Build 125; SEMCAD X Version 13.4 Build 125

Right Tilted/Area Scan (71x101x1):

Measurement grid: dx=15mm, dy=15mm
Maximum value of SAR (interpolated) = 0.188 mW/g

Right Tilted/Zoom Scan (7x7x9)/Cube 0:

Measurement grid: dx=5mm, dy=5mm, dz=3mm
Reference Value = 10.1 V/m; Power Drift = 0.045 dB
Peak SAR (extrapolated) = 0.206 W/kg
SAR(1 g) = 0.168 mW/g; SAR(10 g) = 0.126 mW/g
Maximum value of SAR (measured) = 0.184 mW/g

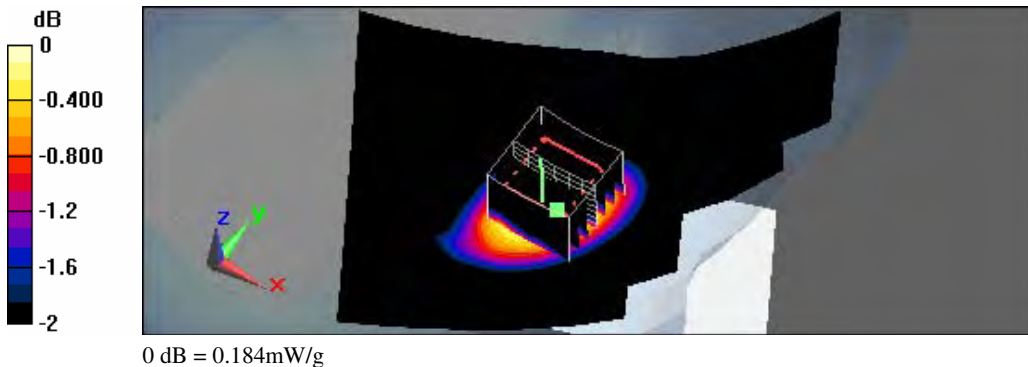

Test Laboratory: A Test Lab Techno Corp.
Date/Time: 7/5/2012 2:30:59 AM

LC_GSM 850 CH128

DUT: PM66100; Type: Smartphone; FCC ID: NM8PM66100

Communication System: GSM850; Frequency: 824.2 MHz; Duty Cycle: 1:8
Medium parameters used (interpolated): $f = 824.2$ MHz; $\sigma = 0.903$ mho/m; $\epsilon_r = 41$; $\rho = 1000$ kg/m³
Phantom section: Left Section
Measurement Standard: DASYS (IEEE/IEC)

DASY5 Configuration:

- Area Scan setting - Find Secondary Maximum Within: 2.0dB and with a peak SAR value greater than 0.5 W/Kg
- Probe: EX3DV4 - SN3847; ConvF(9.34, 9.34, 9.34); Calibrated: 3/21/2012
- Sensor-Surface: 3mm (Mechanical Surface Detection)
- Electronics: DAE4 Sn779; Calibrated: 1/23/2012
- Phantom: SAM 12; Type: SAM v4.0; Serial: TP:1009
- Measurement SW: DASY5, V5.0 Build 125; SEMCAD X Version 13.4 Build 125

Left Cheek/Area Scan (71x101x1):

Measurement grid: dx=15mm, dy=15mm
Maximum value of SAR (interpolated) = 0.220 mW/g

Left Cheek/Zoom Scan (7x7x9)/Cube 0:

Measurement grid: dx=5mm, dy=5mm, dz=3mm
Reference Value = 6.84 V/m; Power Drift = 0.026 dB
Peak SAR (extrapolated) = 0.237 W/kg
SAR(1 g) = 0.200 mW/g; SAR(10 g) = 0.153 mW/g
Maximum value of SAR (measured) = 0.232 mW/g

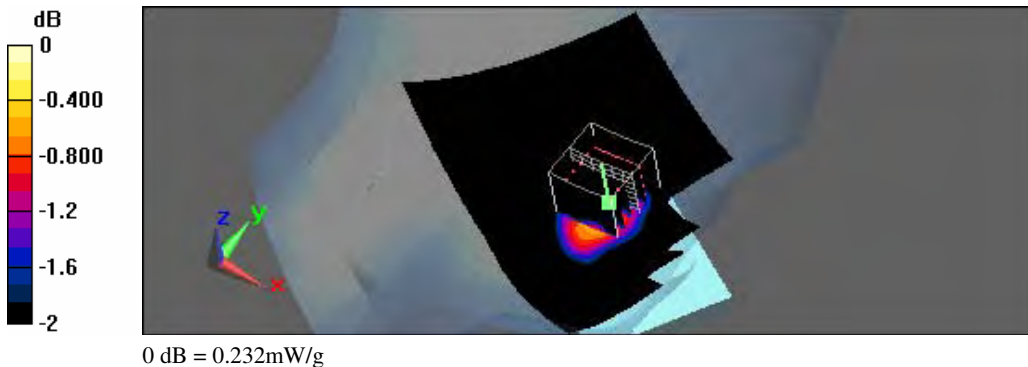



Test Laboratory: A Test Lab Techno Corp.
Date/Time: 7/5/2012 3:03:01 AM

LT_GSM 850 CH128

DUT: PM66100; Type: Smartphone; FCC ID: NM8PM66100

Communication System: GSM850; Frequency: 824.2 MHz; Duty Cycle: 1:8
Medium parameters used (interpolated): $f = 824.2$ MHz; $\sigma = 0.903$ mho/m; $\epsilon_r = 41$; $\rho = 1000$ kg/m³
Phantom section: Left Section
Measurement Standard: DASYS (IEEE/IEC)

DASY5 Configuration:

- Area Scan setting - Find Secondary Maximum Within: 2.0dB and with a peak SAR value greater than 0.5 W/Kg
- Probe: EX3DV4 - SN3847; ConvF(9.34, 9.34, 9.34); Calibrated: 3/21/2012
- Sensor-Surface: 3mm (Mechanical Surface Detection)
- Electronics: DAE4 Sn779; Calibrated: 1/23/2012
- Phantom: SAM 12; Type: SAM v4.0; Serial: TP:1009
- Measurement SW: DASY5, V5.0 Build 125; SEMCAD X Version 13.4 Build 125

Left Tilted/Area Scan (71x101x1):

Measurement grid: dx=15mm, dy=15mm
Maximum value of SAR (interpolated) = 0.166 mW/g

Left Tilted/Zoom Scan (7x7x9)/Cube 0:

Measurement grid: dx=5mm, dy=5mm, dz=3mm
Reference Value = 10.8 V/m; Power Drift = -0.032 dB
Peak SAR (extrapolated) = 0.173 W/kg
SAR(1 g) = 0.127 mW/g; SAR(10 g) = 0.094 mW/g
Maximum value of SAR (measured) = 0.150 mW/g

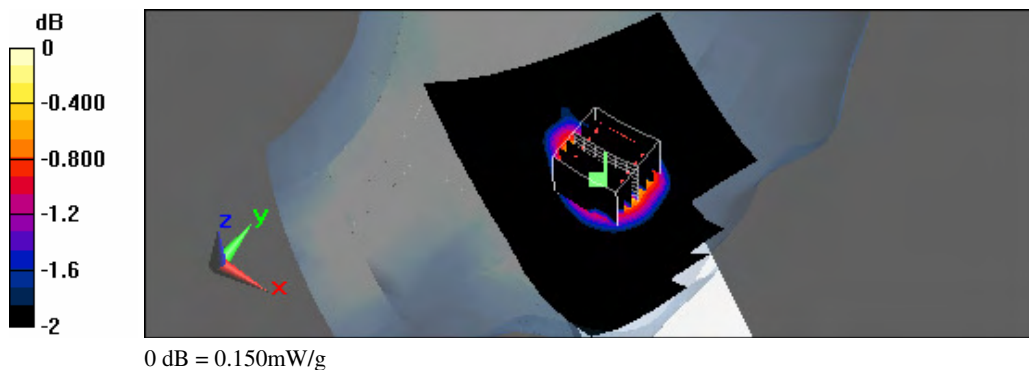



Test Laboratory: A Test Lab Techno Corp.
Date/Time: 6/26/2012 9:14:47 PM

RC_GPRS 850 CH128_2D3U

DUT: PM66100; Type: Smartphone; FCC ID: NM8PM66100

Communication System: GPRS 850 (2Down, 3Up); Frequency: 824.2 MHz;Duty Cycle: 1:2.67

Medium parameters used (interpolated): $f = 824.2$ MHz; $\sigma = 0.903$ mho/m; $\epsilon_r = 41$; $\rho = 1000$ kg/m³

Phantom section: Right Section

Measurement Standard: DASYS (IEEE/IEC)

DASY5 Configuration:

- Area Scan setting - Find Secondary Maximum Within:2.0dB and with a peak SAR value greater than 0.5 W/Kg
- Probe: EX3DV4 - SN3847; ConvF(9.34, 9.34, 9.34); Calibrated: 3/21/2012
- Sensor-Surface: 3mm (Mechanical Surface Detection)
- Electronics: DAE4 Sn779; Calibrated: 1/23/2012
- Phantom: SAM 12; Type: SAM v4.0; Serial: TP:1009
- Measurement SW: DASY5, V5.0 Build 125;SEMCAD X Version 13.4 Build 125

Right Cheek/Area Scan (71x101x1):

Measurement grid: dx=15mm, dy=15mm
Maximum value of SAR (interpolated) = 0.427 mW/g

Right Cheek/Zoom Scan (7x7x9)/Cube 0:

Measurement grid: dx=5mm, dy=5mm, dz=3mm
Reference Value = 5.31 V/m; Power Drift = 0.098 dB
Peak SAR (extrapolated) = 0.446 W/kg
SAR(1 g) = 0.361 mW/g; SAR(10 g) = 0.265 mW/g
Maximum value of SAR (measured) = 0.401 mW/g

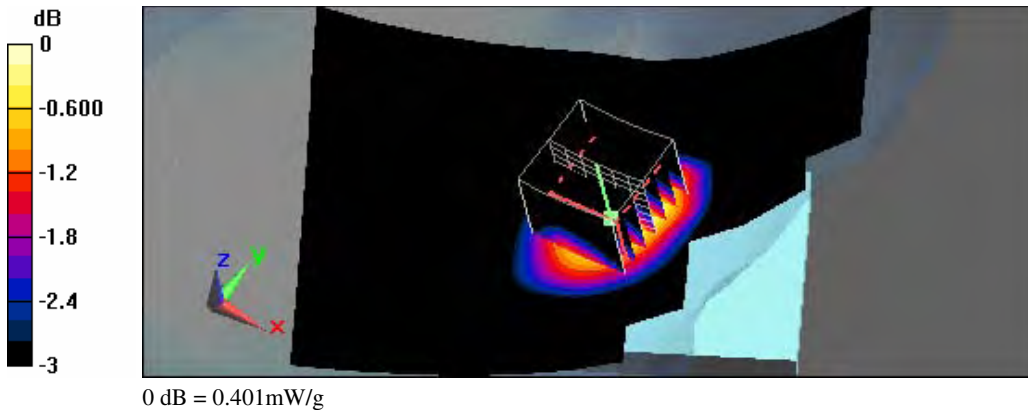

Test Laboratory: A Test Lab Techno Corp.
Date/Time: 6/26/2012 9:44:21 PM

RT_GPRS 850 CH128_2D3U

DUT: PM66100; Type: Smartphone; FCC ID: NM8PM66100

Communication System: GPRS 850 (2Down, 3Up); Frequency: 824.2 MHz; Duty Cycle: 1:2.67

Medium parameters used (interpolated): $f = 824.2$ MHz; $\sigma = 0.903$ mho/m; $\epsilon_r = 41$; $\rho = 1000$ kg/m³

Phantom section: Right Section

Measurement Standard: DASYS (IEEE/IEC)

DASY5 Configuration:

- Area Scan setting - Find Secondary Maximum Within: 2.0dB and with a peak SAR value greater than 0.5 W/Kg
- Probe: EX3DV4 - SN3847; ConvF(9.34, 9.34, 9.34); Calibrated: 3/21/2012
- Sensor-Surface: 3mm (Mechanical Surface Detection)
- Electronics: DAE4 Sn779; Calibrated: 1/23/2012
- Phantom: SAM 12; Type: SAM v4.0; Serial: TP:1009
- Measurement SW: DASY5, V5.0 Build 125; SEMCAD X Version 13.4 Build 125

Right Tilted/Area Scan (71x101x1):

Measurement grid: dx=15mm, dy=15mm

Maximum value of SAR (interpolated) = 0.203 mW/g

Right Tilted/Zoom Scan (7x7x9)/Cube 0:

Measurement grid: dx=5mm, dy=5mm, dz=3mm

Reference Value = 10.2 V/m; Power Drift = 0.151 dB

Peak SAR (extrapolated) = 0.235 W/kg

SAR(1 g) = 0.196 mW/g; SAR(10 g) = 0.151 mW/g

Maximum value of SAR (measured) = 0.213 mW/g

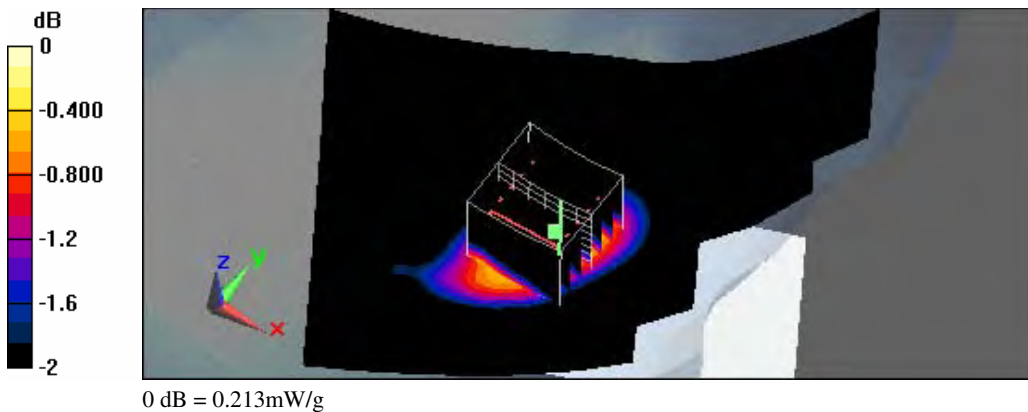

Test Laboratory: A Test Lab Techno Corp.
Date/Time: 6/26/2012 10:38:38 PM

LC_GPRS 850 CH128_2D3U

DUT: PM66100; Type: Smartphone; FCC ID: NM8PM66100

Communication System: GPRS 850 (2Down, 3Up); Frequency: 824.2 MHz; Duty Cycle: 1:2.67

Medium parameters used (interpolated): $f = 824.2$ MHz; $\sigma = 0.903$ mho/m; $\epsilon_r = 41$; $\rho = 1000$ kg/m³

Phantom section: Left Section

Measurement Standard: DASYS (IEEE/IEC)

DASY5 Configuration:

- Area Scan setting - Find Secondary Maximum Within:2.0dB and with a peak SAR value greater than 0.5 W/Kg
- Probe: EX3DV4 - SN3847; ConvF(9.34, 9.34, 9.34); Calibrated: 3/21/2012
- Sensor-Surface: 3mm (Mechanical Surface Detection)
- Electronics: DAE4 Sn779; Calibrated: 1/23/2012
- Phantom: SAM 12; Type: SAM v4.0; Serial: TP:1009
- Measurement SW: DASY5, V5.0 Build 125; SEMCAD X Version 13.4 Build 125

Left Cheek/Area Scan (71x101x1):

Measurement grid: dx=15mm, dy=15mm
Maximum value of SAR (interpolated) = 0.318 mW/g

Left Cheek/Zoom Scan (7x7x9)/Cube 0:

Measurement grid: dx=5mm, dy=5mm, dz=3mm
Reference Value = 6.85 V/m; Power Drift = -0.094 dB
Peak SAR (extrapolated) = 0.332 W/kg
SAR(1 g) = 0.260 mW/g; SAR(10 g) = 0.194 mW/g
Maximum value of SAR (measured) = 0.289 mW/g

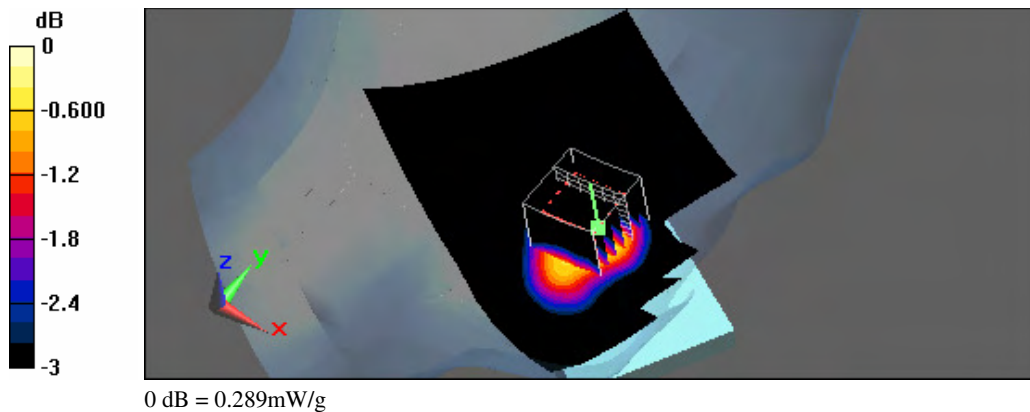

Test Laboratory: A Test Lab Techno Corp.
Date/Time: 6/26/2012 11:39:28 PM

LT_GPRS 850 CH128_2D3U

DUT: PM66100; Type: Smartphone; FCC ID: NM8PM66100

Communication System: GPRS 850 (2Down, 3Up); Frequency: 824.2 MHz; Duty Cycle: 1:2.67

Medium parameters used (interpolated): $f = 824.2$ MHz; $\sigma = 0.903$ mho/m; $\epsilon_r = 41$; $\rho = 1000$ kg/m³

Phantom section: Left Section

Measurement Standard: DASYS (IEEE/IEC)

DASY5 Configuration:

- Area Scan setting - Find Secondary Maximum Within:2.0dB and with a peak SAR value greater than 0.5 W/Kg
- Probe: EX3DV4 - SN3847; ConvF(9.34, 9.34, 9.34); Calibrated: 3/21/2012
- Sensor-Surface: 3mm (Mechanical Surface Detection)
- Electronics: DAE4 Sn779; Calibrated: 1/23/2012
- Phantom: SAM 12; Type: SAM v4.0; Serial: TP:1009
- Measurement SW: DASY5, V5.0 Build 125; SEMCAD X Version 13.4 Build 125

Left Tilted/Area Scan (71x101x1):

Measurement grid: dx=15mm, dy=15mm
Maximum value of SAR (interpolated) = 0.199 mW/g

Left Tilted/Zoom Scan (7x7x9)/Cube 0:

Measurement grid: dx=5mm, dy=5mm, dz=3mm
Reference Value = 11.2 V/m; Power Drift = 0.052 dB
Peak SAR (extrapolated) = 0.232 W/kg
SAR(1 g) = 0.185 mW/g; SAR(10 g) = 0.140 mW/g
Maximum value of SAR (measured) = 0.202 mW/g

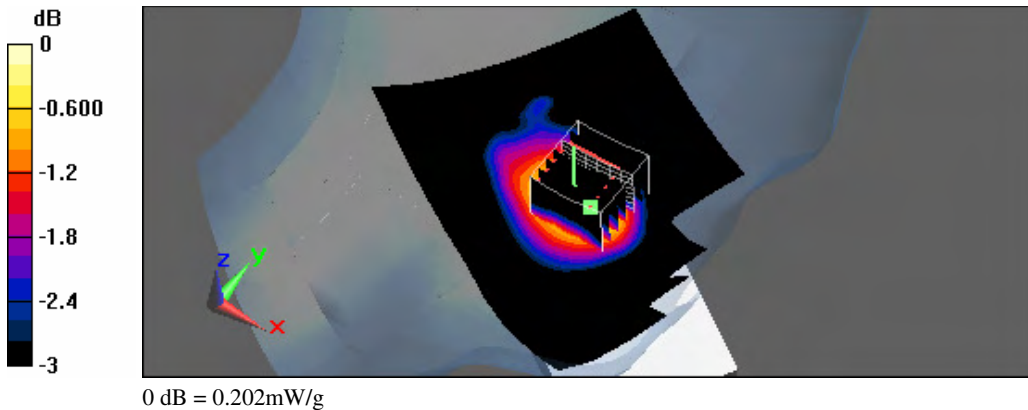



Test Laboratory: A Test Lab Techno Corp.
Date/Time: 6/27/2012 1:07:29 AM

RC_DTM 850 CH128_2D3U

DUT: PM66100; Type: Smartphone; FCC ID: NM8PM66100

Communication System: DTM 850 (2Down, 3Up); Frequency: 824.2 MHz; Duty Cycle: 1:2.8
Medium parameters used (interpolated): $f = 824.2$ MHz; $\sigma = 0.903$ mho/m; $\epsilon_r = 41$; $\rho = 1000$ kg/m³
Phantom section: Right Section
Measurement Standard: DASYS (IEEE/IEC)

DASY5 Configuration:

- Area Scan setting - Find Secondary Maximum Within: 2.0dB and with a peak SAR value greater than 0.5 W/Kg
- Probe: EX3DV4 - SN3847; ConvF(9.34, 9.34, 9.34); Calibrated: 3/21/2012
- Sensor-Surface: 3mm (Mechanical Surface Detection)
- Electronics: DAE4 Sn779; Calibrated: 1/23/2012
- Phantom: SAM 12; Type: SAM v4.0; Serial: TP:1009
- Measurement SW: DASY5, V5.0 Build 125; SEMCAD X Version 13.4 Build 125

Right Cheek/Area Scan (71x101x1):

Measurement grid: dx=15mm, dy=15mm
Maximum value of SAR (interpolated) = 0.477 mW/g

Right Cheek/Zoom Scan (7x7x9)/Cube 0:

Measurement grid: dx=5mm, dy=5mm, dz=3mm
Reference Value = 5.87 V/m; Power Drift = 0.031 dB
Peak SAR (extrapolated) = 0.386 W/kg
SAR(1 g) = 0.304 mW/g; SAR(10 g) = 0.220 mW/g
Maximum value of SAR (measured) = 0.337 mW/g

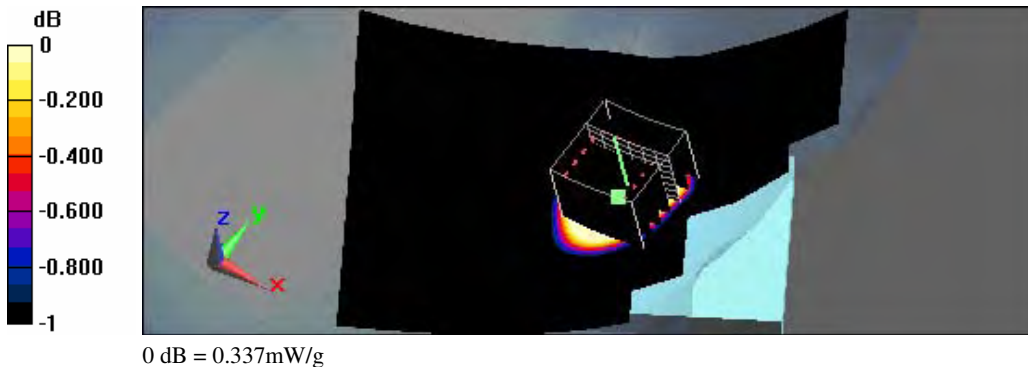

Test Laboratory: A Test Lab Techno Corp.
Date/Time: 6/27/2012 1:59:51 AM

RT_DTM 850 CH128_2D3U

DUT: PM66100; Type: Smartphone; FCC ID: NM8PM66100

Communication System: DTM 850 (2Down, 3Up); Frequency: 824.2 MHz; Duty Cycle: 1:2.8
Medium parameters used (interpolated): $f = 824.2 \text{ MHz}$; $\sigma = 0.903 \text{ mho/m}$; $\epsilon_r = 41$; $\rho = 1000 \text{ kg/m}^3$

Phantom section: Right Section
Measurement Standard: DASYS (IEEE/IEC)

DASY5 Configuration:

- Area Scan setting - Find Secondary Maximum Within: 2.0dB and with a peak SAR value greater than 0.5 W/Kg
- Probe: EX3DV4 - SN3847; ConvF(9.34, 9.34, 9.34); Calibrated: 3/21/2012
- Sensor-Surface: 3mm (Mechanical Surface Detection)
- Electronics: DAE4 Sn779; Calibrated: 1/23/2012
- Phantom: SAM 12; Type: SAM v4.0; Serial: TP:1009
- Measurement SW: DASY5, V5.0 Build 125; SEMCAD X Version 13.4 Build 125

Right Tilted/Area Scan (71x101x1):

Measurement grid: $dx=15\text{mm}$, $dy=15\text{mm}$
Maximum value of SAR (interpolated) = 0.188 mW/g

Right Tilted/Zoom Scan (7x7x9)/Cube 0:

Measurement grid: $dx=5\text{mm}$, $dy=5\text{mm}$, $dz=3\text{mm}$
Reference Value = 9.68 V/m; Power Drift = 0.060 dB
Peak SAR (extrapolated) = 0.206 W/kg
SAR(1 g) = 0.167 mW/g; SAR(10 g) = 0.126 mW/g
Maximum value of SAR (measured) = 0.183 mW/g

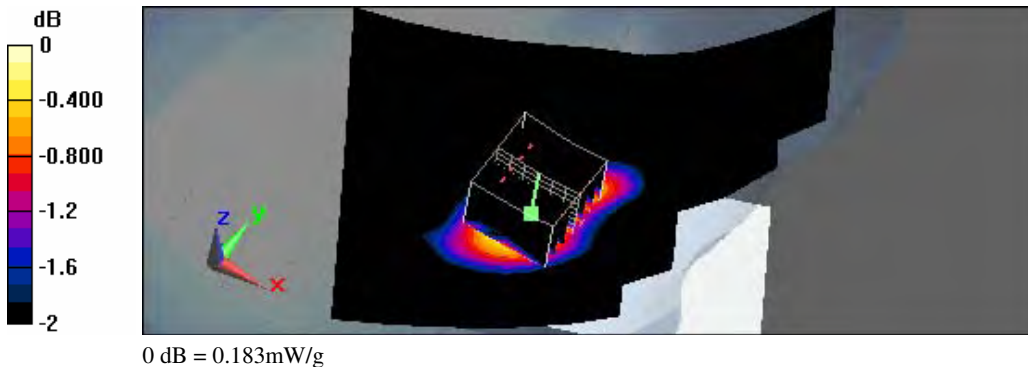



Test Laboratory: A Test Lab Techno Corp.
Date/Time: 6/27/2012 2:29:07 AM

LC_DTM 850 CH128_2D3U

DUT: PM66100; Type: Smartphone; FCC ID: NM8PM66100

Communication System: DTM 850 (2Down, 3Up); Frequency: 824.2 MHz; Duty Cycle: 1:2.8
Medium parameters used (interpolated): $f = 824.2$ MHz; $\sigma = 0.903$ mho/m; $\epsilon_r = 41$; $\rho = 1000$ kg/m³

Phantom section: Left Section

Measurement Standard: DASYS (IEEE/IEC)

DASY5 Configuration:

- Area Scan setting - Find Secondary Maximum Within: 2.0dB and with a peak SAR value greater than 0.5 W/Kg
- Probe: EX3DV4 - SN3847; ConvF(9.34, 9.34, 9.34); Calibrated: 3/21/2012
- Sensor-Surface: 3mm (Mechanical Surface Detection)
- Electronics: DAE4 Sn779; Calibrated: 1/23/2012
- Phantom: SAM 12; Type: SAM v4.0; Serial: TP:1009
- Measurement SW: DASY5, V5.0 Build 125; SEMCAD X Version 13.4 Build 125

Left Cheek/Area Scan (71x101x1):

Measurement grid: dx=15mm, dy=15mm
Maximum value of SAR (interpolated) = 0.204 mW/g

Left Cheek/Zoom Scan (7x7x9)/Cube 0:

Measurement grid: dx=5mm, dy=5mm, dz=3mm
Reference Value = 6.04 V/m; Power Drift = -0.020 dB
Peak SAR (extrapolated) = 0.231 W/kg
SAR(1 g) = 0.189 mW/g; SAR(10 g) = 0.140 mW/g
Maximum value of SAR (measured) = 0.207 mW/g

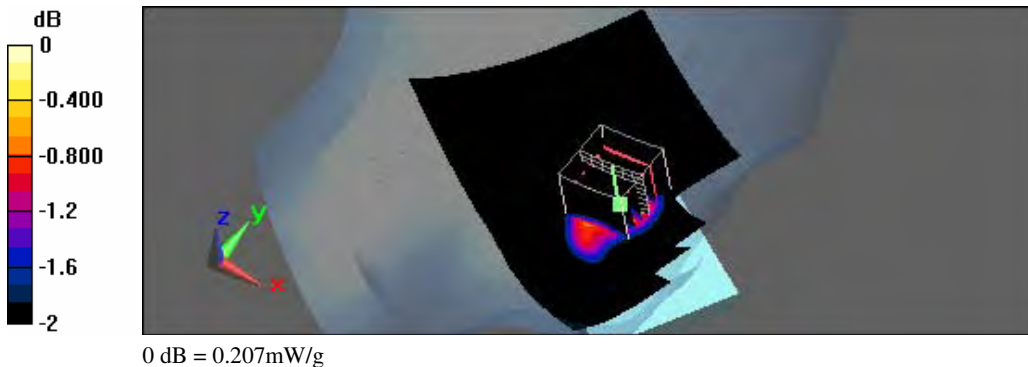



Test Laboratory: A Test Lab Techno Corp.
Date/Time: 6/27/2012 2:55:14 AM

LT_DTM 850 CH128_2D3U

DUT: PM66100; Type: Smartphone; FCC ID: NM8PM66100

Communication System: DTM 850 (2Down, 3Up); Frequency: 824.2 MHz; Duty Cycle: 1:2.8
Medium parameters used (interpolated): $f = 824.2$ MHz; $\sigma = 0.903$ mho/m; $\epsilon_r = 41$; $\rho = 1000$ kg/m³

Phantom section: Left Section
Measurement Standard: DASYS (IEEE/IEC)

DASY5 Configuration:

- Area Scan setting - Find Secondary Maximum Within: 2.0dB and with a peak SAR value greater than 0.5 W/Kg
- Probe: EX3DV4 - SN3847; ConvF(9.34, 9.34, 9.34); Calibrated: 3/21/2012
- Sensor-Surface: 3mm (Mechanical Surface Detection)
- Electronics: DAE4 Sn779; Calibrated: 1/23/2012
- Phantom: SAM 12; Type: SAM v4.0; Serial: TP:1009
- Measurement SW: DASY5, V5.0 Build 125; SEMCAD X Version 13.4 Build 125

Left Tilted/Area Scan (71x101x1):

Measurement grid: dx=15mm, dy=15mm
Maximum value of SAR (interpolated) = 0.149 mW/g

Left Tilted/Zoom Scan (7x7x9)/Cube 0:

Measurement grid: dx=5mm, dy=5mm, dz=3mm
Reference Value = 10.3 V/m; Power Drift = 0.010 dB
Peak SAR (extrapolated) = 0.173 W/kg
SAR(1 g) = 0.136 mW/g; SAR(10 g) = 0.102 mW/g
Maximum value of SAR (measured) = 0.150 mW/g

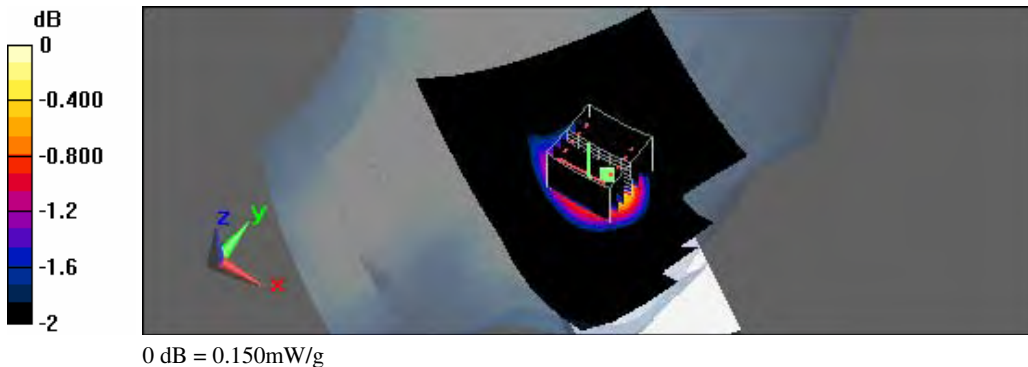

Test Laboratory: A Test Lab Techno Corp.
Date/Time: 6/27/2012 3:31:58 PM

RC_PCS CH661

DUT: PM66100; Type: Smartphone; FCC ID: NM8PM66100

Communication System: PCS; Frequency: 1880 MHz; Duty Cycle: 1:8
Medium parameters used: $f = 1880 \text{ MHz}$; $\sigma = 1.37 \text{ mho/m}$; $\epsilon_r = 39.1$; $\rho = 1000 \text{ kg/m}^3$
Phantom section: Right Section
Measurement Standard: DASYS (IEEE/IEC)

DASY5 Configuration:

- Area Scan setting - Find Secondary Maximum Within:2.0dB and with a peak SAR value greater than 0.5 W/Kg
- Probe: EX3DV4 - SN3847; ConvF(8.05, 8.05, 8.05); Calibrated: 3/21/2012
- Sensor-Surface: 3mm (Mechanical Surface Detection)
- Electronics: DAE4 Sn779; Calibrated: 1/23/2012
- Phantom: SAM 12; Type: SAM v4.0; Serial: TP:1009
- Measurement SW: DASY5, V5.0 Build 125; SEMCAD X Version 13.4 Build 125

Right Cheek/Area Scan (71x101x1):

Measurement grid: $dx=15\text{mm}$, $dy=15\text{mm}$
Maximum value of SAR (interpolated) = 0.467 mW/g

Right Cheek/Zoom Scan (7x7x9)/Cube 0:

Measurement grid: $dx=5\text{mm}$, $dy=5\text{mm}$, $dz=3\text{mm}$
Reference Value = 14.9 V/m; Power Drift = -0.081 dB
Peak SAR (extrapolated) = 0.564 W/kg
SAR(1 g) = 0.392 mW/g; SAR(10 g) = 0.263 mW/g
Maximum value of SAR (measured) = 0.453 mW/g

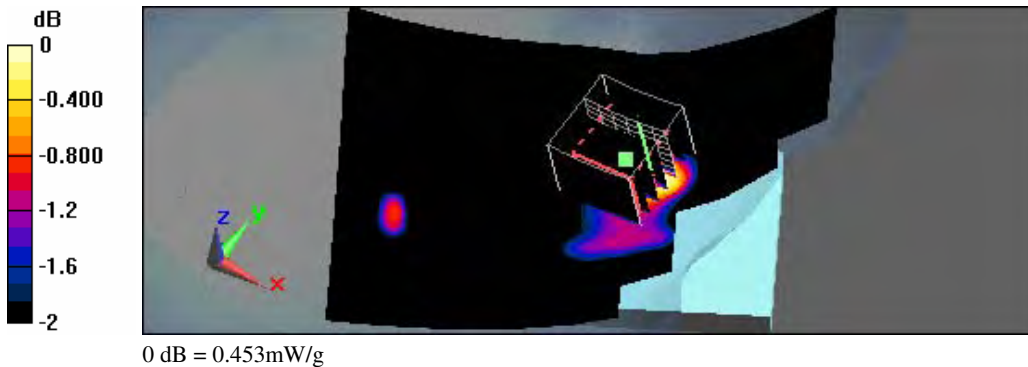

Test Laboratory: A Test Lab Techno Corp.
Date/Time: 6/27/2012 4:23:08 PM

RT_PCS CH661

DUT: PM66100; Type: Smartphone; FCC ID: NM8PM66100

Communication System: PCS; Frequency: 1880 MHz; Duty Cycle: 1:8
Medium parameters used: $f = 1880 \text{ MHz}$; $\sigma = 1.37 \text{ mho/m}$; $\epsilon_r = 39.1$; $\rho = 1000 \text{ kg/m}^3$
Phantom section: Right Section
Measurement Standard: DASYS (IEEE/IEC)

DASY5 Configuration:

- Area Scan setting - Find Secondary Maximum Within:2.0dB and with a peak SAR value greater than 0.5 W/Kg
- Probe: EX3DV4 - SN3847; ConvF(8.05, 8.05, 8.05); Calibrated: 3/21/2012
- Sensor-Surface: 3mm (Mechanical Surface Detection)
- Electronics: DAE4 Sn779; Calibrated: 1/23/2012
- Phantom: SAM 12; Type: SAM v4.0; Serial: TP:1009
- Measurement SW: DASY5, V5.0 Build 125; SEMCAD X Version 13.4 Build 125

Right Tilted/Area Scan (71x111x1):

Measurement grid: $dx=15\text{mm}$, $dy=15\text{mm}$
Maximum value of SAR (interpolated) = 0.635 mW/g

Right Tilted/Zoom Scan (7x7x9)/Cube 0:

Measurement grid: $dx=5\text{mm}$, $dy=5\text{mm}$, $dz=3\text{mm}$
Reference Value = 20.2 V/m; Power Drift = -0.122 dB
Peak SAR (extrapolated) = 0.947 W/kg
SAR(1 g) = 0.456 mW/g; SAR(10 g) = 0.219 mW/g
Maximum value of SAR (measured) = 0.580 mW/g

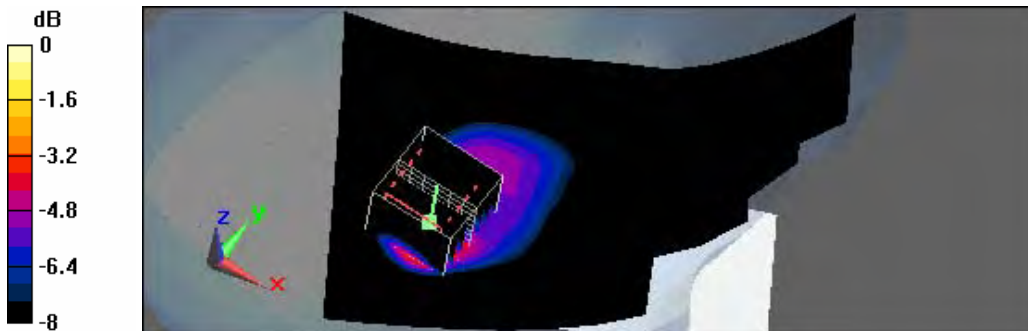

0 dB = 0.580mW/g

Test Laboratory: A Test Lab Techno Corp.
Date/Time: 6/27/2012 6:30:07 PM

LC_PCS CH661

DUT: PM66100; Type: Smartphone; FCC ID: NM8PM66100

Communication System: PCS; Frequency: 1880 MHz; Duty Cycle: 1:8
Medium parameters used: $f = 1880 \text{ MHz}$; $\sigma = 1.37 \text{ mho/m}$; $\epsilon_r = 39.1$; $\rho = 1000 \text{ kg/m}^3$
Phantom section: Left Section
Measurement Standard: DASYS (IEEE/IEC)

DASY5 Configuration:

- Area Scan setting - Find Secondary Maximum Within:2.0dB and with a peak SAR value greater than 0.5 W/Kg
- Probe: EX3DV4 - SN3847; ConvF(8.05, 8.05, 8.05); Calibrated: 3/21/2012
- Sensor-Surface: 3mm (Mechanical Surface Detection)
- Electronics: DAE4 Sn779; Calibrated: 1/23/2012
- Phantom: SAM 12; Type: SAM v4.0; Serial: TP:1009
- Measurement SW: DASY5, V5.0 Build 125; SEMCAD X Version 13.4 Build 125

Left Cheek/Area Scan (71x111x1):

Measurement grid: $dx=15\text{mm}$, $dy=15\text{mm}$
Maximum value of SAR (interpolated) = 0.700 mW/g

Left Cheek/Zoom Scan (7x7x9)/Cube 0:

Measurement grid: $dx=5\text{mm}$, $dy=5\text{mm}$, $dz=3\text{mm}$
Reference Value = 9.17 V/m; Power Drift = 0.055 dB
Peak SAR (extrapolated) = 0.947 W/kg
SAR(1 g) = 0.584 mW/g; SAR(10 g) = 0.345 mW/g
Maximum value of SAR (measured) = 0.708 mW/g

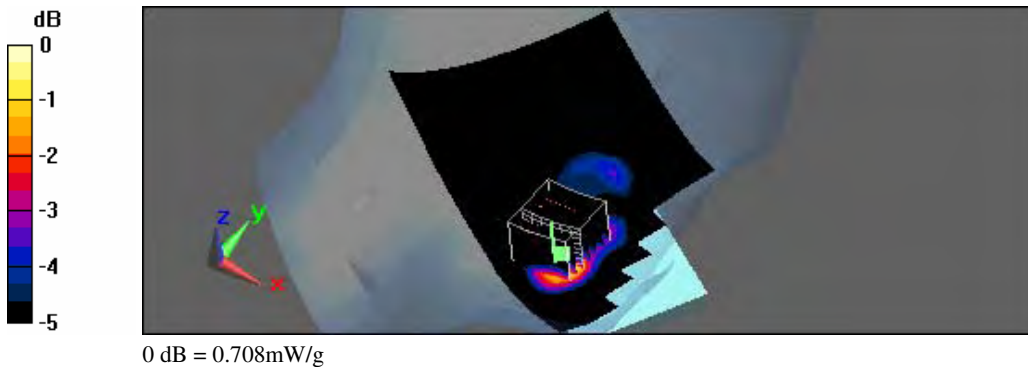



Test Laboratory: A Test Lab Techno Corp.
Date/Time: 6/27/2012 7:12:21 PM

LT_PCS CH661

DUT: PM66100; Type: Smartphone; FCC ID: NM8PM66100

Communication System: PCS; Frequency: 1880 MHz; Duty Cycle: 1:8
Medium parameters used: $f = 1880$ MHz; $\sigma = 1.37$ mho/m; $\epsilon_r = 39.1$; $\rho = 1000$ kg/m³
Phantom section: Left Section
Measurement Standard: DASYS (IEEE/IEC)

DASY5 Configuration:

- Area Scan setting - Find Secondary Maximum Within:2.0dB and with a peak SAR value greater than 0.5 W/Kg
- Probe: EX3DV4 - SN3847; ConvF(8.05, 8.05, 8.05); Calibrated: 3/21/2012
- Sensor-Surface: 3mm (Mechanical Surface Detection)
- Electronics: DAE4 Sn779; Calibrated: 1/23/2012
- Phantom: SAM 12; Type: SAM v4.0; Serial: TP:1009
- Measurement SW: DASY5, V5.0 Build 125; SEMCAD X Version 13.4 Build 125

Left Tilted/Area Scan (71x111x1):

Measurement grid: dx=15mm, dy=15mm
Maximum value of SAR (interpolated) = 0.424 mW/g

Left Tilted/Zoom Scan (7x7x9)/Cube 0:

Measurement grid: dx=5mm, dy=5mm, dz=3mm
Reference Value = 16.6 V/m; Power Drift = -0.014 dB
Peak SAR (extrapolated) = 0.650 W/kg
SAR(1 g) = 0.327 mW/g; SAR(10 g) = 0.171 mW/g
Maximum value of SAR (measured) = 0.435 mW/g

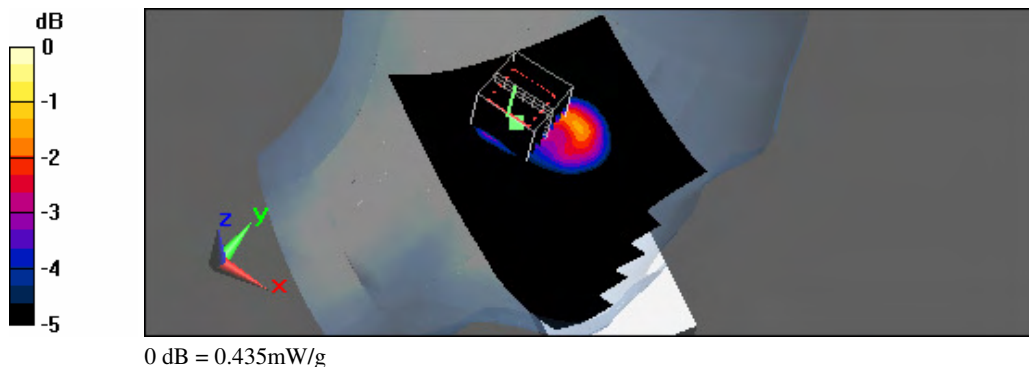

Test Laboratory: A Test Lab Techno Corp.
Date/Time: 6/28/2012 4:23:00 AM

RC_GPRS PCS CH512_2D3U

DUT: PM66100; Type: Smartphone; FCC ID: NM8PM66100

Communication System: GPRS PCS (2Down,3Up); Frequency: 1850.2 MHz;Duty Cycle: 1:2.67

Medium parameters used (interpolated): $f = 1850.2 \text{ MHz}$; $\sigma = 1.34 \text{ mho/m}$; $\epsilon_r = 39.2$; $\rho = 1000 \text{ kg/m}^3$

Phantom section: Right Section

Measurement Standard: DASYS (IEEE/IEC)

DASY5 Configuration:

- Area Scan setting - Find Secondary Maximum Within:2.0dB and with a peak SAR value greater than 0.5 W/Kg
- Probe: EX3DV4 - SN3847; ConvF(8.05, 8.05, 8.05); Calibrated: 3/21/2012
- Sensor-Surface: 3mm (Mechanical Surface Detection)
- Electronics: DAE4 Sn779; Calibrated: 1/23/2012
- Phantom: SAM 12; Type: SAM v4.0; Serial: TP:1009
- Measurement SW: DASY5, V5.0 Build 125;SEMCAD X Version 13.4 Build 125

Right Cheek/Area Scan (71x101x1):

Measurement grid: $dx=15\text{mm}$, $dy=15\text{mm}$
Maximum value of SAR (interpolated) = 0.844 mW/g

Right Cheek/Zoom Scan (7x7x9)/Cube 0:

Measurement grid: $dx=5\text{mm}$, $dy=5\text{mm}$, $dz=3\text{mm}$
Reference Value = 17.5 V/m; Power Drift = -0.021 dB
Peak SAR (extrapolated) = 1.13 W/kg
SAR(1 g) = 0.748 mW/g; SAR(10 g) = 0.471 mW/g
Maximum value of SAR (measured) = 0.854 mW/g

Right Cheek/Zoom Scan (7x7x9)/Cube 1:

Measurement grid: $dx=5\text{mm}$, $dy=5\text{mm}$, $dz=3\text{mm}$
Reference Value = 17.5 V/m; Power Drift = -0.021 dB
Peak SAR (extrapolated) = 0.908 W/kg
SAR(1 g) = 0.597 mW/g; SAR(10 g) = 0.363 mW/g
Maximum value of SAR (measured) = 0.707 mW/g

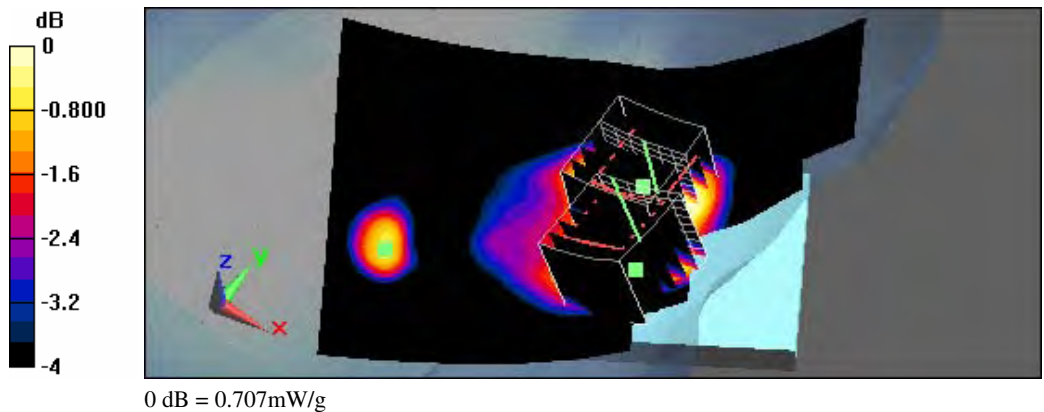

Test Laboratory: A Test Lab Techno Corp.
Date/Time: 6/27/2012 11:03:33 PM

RC_GPRS PCS CH661_2D3U

DUT: PM66100; Type: Smartphone; FCC ID: NM8PM66100

Communication System: GPRS PCS (2Down,3Up); Frequency: 1880 MHz;Duty Cycle: 1:2.67

Medium parameters used: $f = 1880 \text{ MHz}$; $\sigma = 1.37 \text{ mho/m}$; $\epsilon_r = 39.1$; $\rho = 1000 \text{ kg/m}^3$

Phantom section: Right Section

Measurement Standard: DASYS (IEEE/IEC)

DASY5 Configuration:

- Area Scan setting - Find Secondary Maximum Within:2.0dB and with a peak SAR value greater than 0.5 W/Kg
- Probe: EX3DV4 - SN3847; ConvF(8.05, 8.05, 8.05); Calibrated: 3/21/2012
- Sensor-Surface: 3mm (Mechanical Surface Detection)
- Electronics: DAE4 Sn779; Calibrated: 1/23/2012
- Phantom: SAM 12; Type: SAM v4.0; Serial: TP:1009
- Measurement SW: DASY5, V5.0 Build 125;SEMCAD X Version 13.4 Build 125

Right Cheek/Area Scan (71x101x1):

Measurement grid: dx=15mm, dy=15mm

Maximum value of SAR (interpolated) = 1.16 mW/g

Right Cheek/Zoom Scan (7x7x9)/Cube 0:

Measurement grid: dx=5mm, dy=5mm, dz=3mm

Reference Value = 16 V/m; Power Drift = -0.079 dB

Peak SAR (extrapolated) = 1.44 W/kg

SAR(1 g) = 0.961 mW/g; SAR(10 g) = 0.594 mW/g

Maximum value of SAR (measured) = 1.13 mW/g

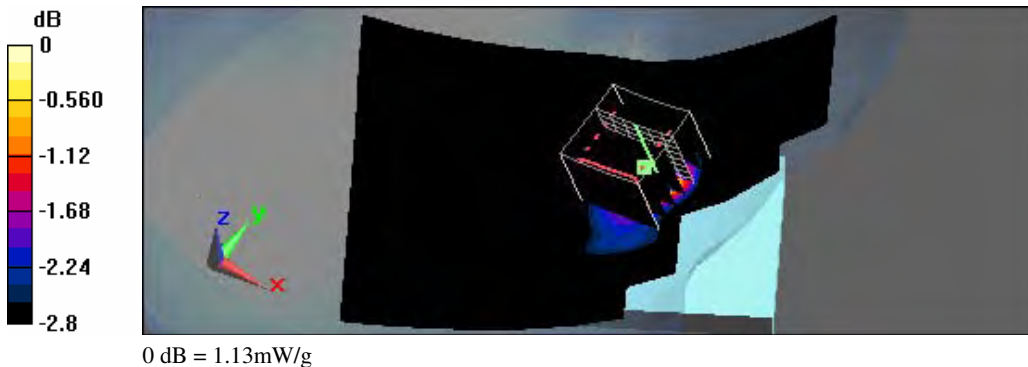

Test Laboratory: A Test Lab Techno Corp.
Date/Time: 6/28/2012 3:29:20 AM

RC_GPRS PCS CH810_2D3U

DUT: PM66100; Type: Smartphone; FCC ID: NM8PM66100

Communication System: GPRS PCS (2Down,3Up); Frequency: 1909.8 MHz;Duty Cycle: 1:2.67

Medium parameters used: $f = 1910$ MHz; $\sigma = 1.4$ mho/m; $\epsilon_r = 39$; $\rho = 1000$ kg/m³

Phantom section: Right Section

Measurement Standard: DASYS (IEEE/IEC)

DASY5 Configuration:

- Area Scan setting - Find Secondary Maximum Within:2.0dB and with a peak SAR value greater than 0.5 W/Kg
- Probe: EX3DV4 - SN3847; ConvF(8.05, 8.05, 8.05); Calibrated: 3/21/2012
- Sensor-Surface: 3mm (Mechanical Surface Detection)
- Electronics: DAE4 Sn779; Calibrated: 1/23/2012
- Phantom: SAM 12; Type: SAM v4.0; Serial: TP:1009
- Measurement SW: DASY5, V5.0 Build 125;SEMCAD X Version 13.4 Build 125

Right Cheek/Area Scan (71x101x1):

Measurement grid: dx=15mm, dy=15mm
Maximum value of SAR (interpolated) = 0.985 mW/g

Right Cheek/Zoom Scan (7x7x9)/Cube 0:

Measurement grid: dx=5mm, dy=5mm, dz=3mm
Reference Value = 14.5 V/m; Power Drift = -0.115 dB
Peak SAR (extrapolated) = 1.21 W/kg
SAR(1 g) = 0.794 mW/g; SAR(10 g) = 0.483 mW/g
Maximum value of SAR (measured) = 0.939 mW/g

Right Cheek/Zoom Scan (7x7x9)/Cube 1:

Measurement grid: dx=5mm, dy=5mm, dz=3mm
Reference Value = 14.5 V/m; Power Drift = -0.115 dB
Peak SAR (extrapolated) = 0.925 W/kg
SAR(1 g) = 0.608 mW/g; SAR(10 g) = 0.381 mW/g
Maximum value of SAR (measured) = 0.743 mW/g

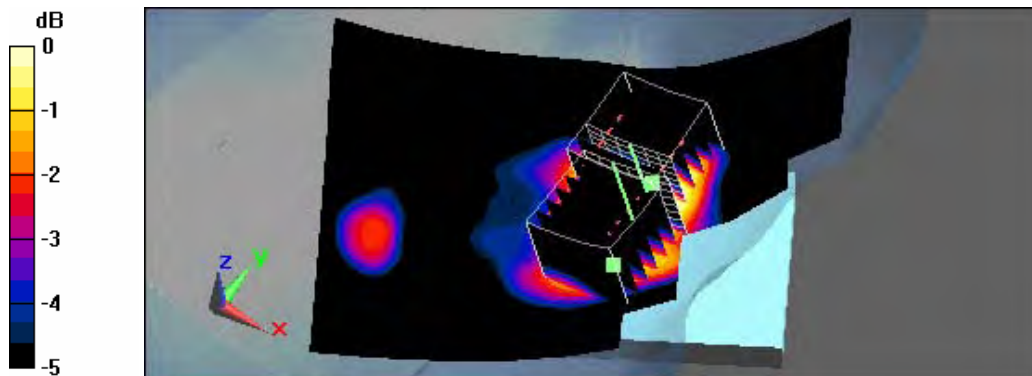

0 dB = 0.743mW/g

Test Laboratory: A Test Lab Techno Corp.
Date/Time: 6/28/2012 1:48:45 AM

RT_GPRS PCS CH512_2D3U

DUT: PM66100; Type: Smartphone; FCC ID: NM8PM66100

Communication System: GPRS PCS (2Down,3Up); Frequency: 1850.2 MHz;Duty Cycle: 1:2.67

Medium parameters used (interpolated): $f = 1850.2 \text{ MHz}$; $\sigma = 1.34 \text{ mho/m}$; $\epsilon_r = 39.2$; $\rho = 1000 \text{ kg/m}^3$

Phantom section: Right Section

Measurement Standard: DASYS (IEEE/IEC)

DASY5 Configuration:

- Area Scan setting - Find Secondary Maximum Within:2.0dB and with a peak SAR value greater than 0.5 W/Kg
- Probe: EX3DV4 - SN3847; ConvF(8.05, 8.05, 8.05); Calibrated: 3/21/2012
- Sensor-Surface: 3mm (Mechanical Surface Detection)
- Electronics: DAE4 Sn779; Calibrated: 1/23/2012
- Phantom: SAM 12; Type: SAM v4.0; Serial: TP:1009
- Measurement SW: DASY5, V5.0 Build 125;SEMCAD X Version 13.4 Build 125

Right Tilted/Area Scan (71x111x1):

Measurement grid: dx=15mm, dy=15mm

Maximum value of SAR (interpolated) = 1.04 mW/g

Right Tilted/Zoom Scan (7x7x9)/Cube 0:

Measurement grid: dx=5mm, dy=5mm, dz=3mm

Reference Value = 25.4 V/m; Power Drift = 0.000452 dB

Peak SAR (extrapolated) = 1.62 W/kg

SAR(1 g) = 0.788 mW/g; SAR(10 g) = 0.387 mW/g

Maximum value of SAR (measured) = 1.06 mW/g

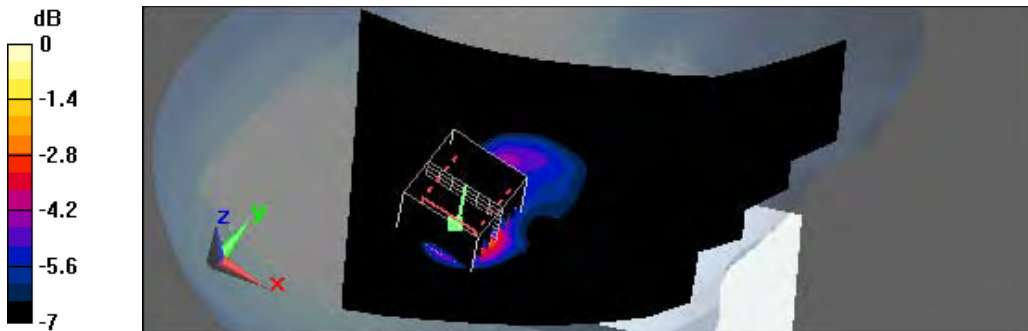

0 dB = 1.06mW/g



Test Laboratory: A Test Lab Techno Corp.
Date/Time: 6/28/2012 1:20:06 AM

RT_GPRS PCS CH661_2D3U

DUT: PM66100; Type: Smartphone; FCC ID: NM8PM66100

Communication System: GPRS PCS (2Down,3Up); Frequency: 1880 MHz;Duty Cycle: 1:2.67

Medium parameters used: $f = 1880 \text{ MHz}$; $\sigma = 1.37 \text{ mho/m}$; $\epsilon_r = 39.1$; $\rho = 1000 \text{ kg/m}^3$

Phantom section: Right Section

Measurement Standard: DASYS (IEEE/IEC)

DASY5 Configuration:

- Area Scan setting - Find Secondary Maximum Within:2.0dB and with a peak SAR value greater than 0.5 W/Kg
- Probe: EX3DV4 - SN3847; ConvF(8.05, 8.05, 8.05); Calibrated: 3/21/2012
- Sensor-Surface: 3mm (Mechanical Surface Detection)
- Electronics: DAE4 Sn779; Calibrated: 1/23/2012
- Phantom: SAM 12; Type: SAM v4.0; Serial: TP:1009
- Measurement SW: DASY5, V5.0 Build 125;SEMCAD X Version 13.4 Build 125

Right Tilted/Area Scan (71x111x1):

Measurement grid: dx=15mm, dy=15mm

Maximum value of SAR (interpolated) = 1.07 mW/g

Right Tilted/Zoom Scan (7x7x9)/Cube 0:

Measurement grid: dx=5mm, dy=5mm, dz=3mm

Reference Value = 25.6 V/m; Power Drift = -0.00125 dB

Peak SAR (extrapolated) = 1.68 W/kg

SAR(1 g) = 0.817 mW/g; SAR(10 g) = 0.396 mW/g

Maximum value of SAR (measured) = 1.08 mW/g

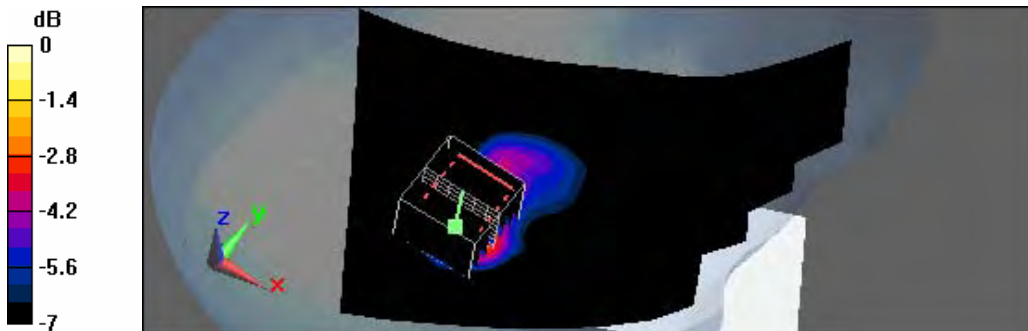

0 dB = 1.08mW/g



Test Laboratory: A Test Lab Techno Corp.
Date/Time: 6/28/2012 2:15:26 AM

RT_GPRS PCS CH810_2D3U

DUT: PM66100; Type: Smartphone; FCC ID: NM8PM66100

Communication System: GPRS PCS (2Down,3Up); Frequency: 1909.8 MHz;Duty Cycle: 1:2.67

Medium parameters used: $f = 1910$ MHz; $\sigma = 1.4$ mho/m; $\epsilon_r = 39$; $\rho = 1000$ kg/m³

Phantom section: Right Section

Measurement Standard: DASYS (IEEE/IEC)

DASY5 Configuration:

- Area Scan setting - Find Secondary Maximum Within:2.0dB and with a peak SAR value greater than 0.5 W/Kg
- Probe: EX3DV4 - SN3847; ConvF(8.05, 8.05, 8.05); Calibrated: 3/21/2012
- Sensor-Surface: 3mm (Mechanical Surface Detection)
- Electronics: DAE4 Sn779; Calibrated: 1/23/2012
- Phantom: SAM 12; Type: SAM v4.0; Serial: TP:1009
- Measurement SW: DASY5, V5.0 Build 125;SEMCAD X Version 13.4 Build 125

Right Tilted/Area Scan (71x111x1):

Measurement grid: dx=15mm, dy=15mm

Maximum value of SAR (interpolated) = 0.914 mW/g

Right Tilted/Zoom Scan (7x7x9)/Cube 0:

Measurement grid: dx=5mm, dy=5mm, dz=3mm

Reference Value = 23.4 V/m; Power Drift = -0.00811 dB

Peak SAR (extrapolated) = 1.44 W/kg

SAR(1 g) = 0.713 mW/g; SAR(10 g) = 0.338 mW/g

Maximum value of SAR (measured) = 0.956 mW/g

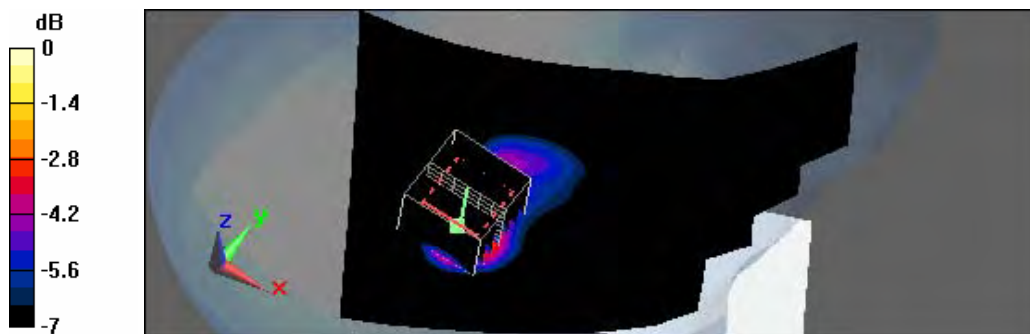

0 dB = 0.956mW/g

Test Laboratory: A Test Lab Techno Corp.
Date/Time: 6/28/2012 5:53:49 AM

LC_GPRS PCS CH512_2D3U

DUT: PM66100; Type: Smartphone; FCC ID: NM8PM66100

Communication System: GPRS PCS (2Down,3Up); Frequency: 1850.2 MHz;Duty Cycle: 1:2.67

Medium parameters used (interpolated): $f = 1850.2 \text{ MHz}$; $\sigma = 1.34 \text{ mho/m}$; $\epsilon_r = 39.2$; $\rho = 1000 \text{ kg/m}^3$

Phantom section: Left Section

Measurement Standard: DASYS (IEEE/IEC)

DASY5 Configuration:

- Area Scan setting - Find Secondary Maximum Within:2.0dB and with a peak SAR value greater than 0.5 W/Kg
- Probe: EX3DV4 - SN3847; ConvF(8.05, 8.05, 8.05); Calibrated: 3/21/2012
- Sensor-Surface: 3mm (Mechanical Surface Detection)
- Electronics: DAE4 Sn779; Calibrated: 1/23/2012
- Phantom: SAM 12; Type: SAM v4.0; Serial: TP:1009
- Measurement SW: DASY5, V5.0 Build 125;SEMCAD X Version 13.4 Build 125

Left Cheek/Area Scan (71x101x1):

Measurement grid: $dx=15\text{mm}$, $dy=15\text{mm}$

Maximum value of SAR (interpolated) = 1.24 mW/g

Left Cheek/Zoom Scan (7x7x9)/Cube 0:

Measurement grid: $dx=5\text{mm}$, $dy=5\text{mm}$, $dz=3\text{mm}$

Reference Value = 12.6 V/m; Power Drift = -0.137 dB

Peak SAR (extrapolated) = 1.69 W/kg

SAR(1 g) = 1.04 mW/g; SAR(10 g) = 0.621 mW/g

Maximum value of SAR (measured) = 1.25 mW/g

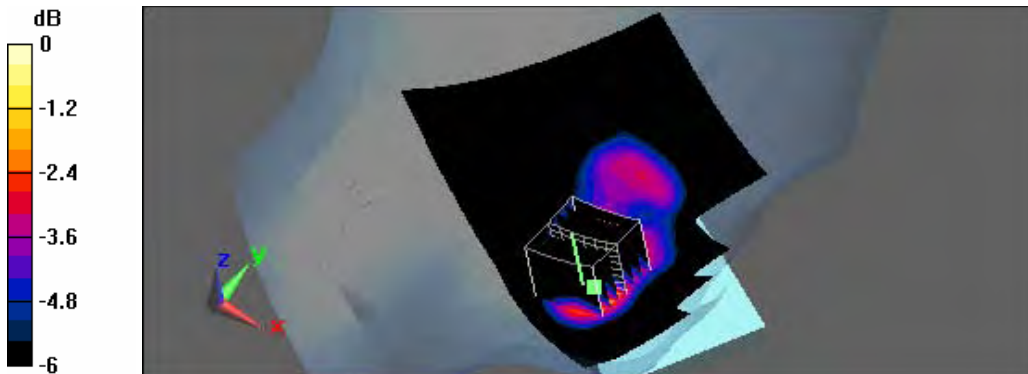

0 dB = 1.25mW/g

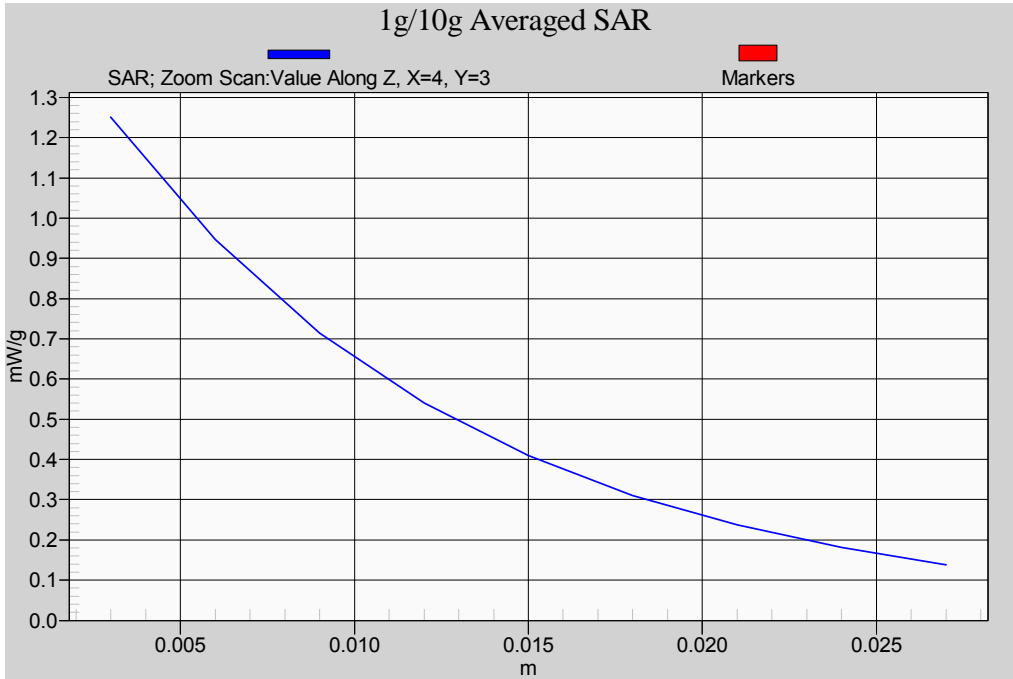

Test Laboratory: A Test Lab Techno Corp.
Date/Time: 6/28/2012 5:08:54 AM

LC_GPRS PCS CH661_2D3U

DUT: PM66100; Type: Smartphone; FCC ID: NM8PM66100

Communication System: GPRS PCS (2Down,3Up); Frequency: 1880 MHz;Duty Cycle: 1:2.67

Medium parameters used: $f = 1880 \text{ MHz}$; $\sigma = 1.37 \text{ mho/m}$; $\epsilon_r = 39.1$; $\rho = 1000 \text{ kg/m}^3$

Phantom section: Left Section

Measurement Standard: DASYS (IEEE/IEC)

DASY5 Configuration:

- Area Scan setting - Find Secondary Maximum Within:2.0dB and with a peak SAR value greater than 0.5 W/Kg
- Probe: EX3DV4 - SN3847; ConvF(8.05, 8.05, 8.05); Calibrated: 3/21/2012
- Sensor-Surface: 3mm (Mechanical Surface Detection)
- Electronics: DAE4 Sn779; Calibrated: 1/23/2012
- Phantom: SAM 12; Type: SAM v4.0; Serial: TP:1009
- Measurement SW: DASY5, V5.0 Build 125;SEMCAD X Version 13.4 Build 125

Left Cheek/Area Scan (71x101x1):

Measurement grid: $dx=15\text{mm}$, $dy=15\text{mm}$

Maximum value of SAR (interpolated) = 1.32 mW/g

Left Cheek/Zoom Scan (7x7x9)/Cube 0:

Measurement grid: $dx=5\text{mm}$, $dy=5\text{mm}$, $dz=3\text{mm}$

Reference Value = 13.4 V/m; Power Drift = -0.078 dB

Peak SAR (extrapolated) = 1.64 W/kg

SAR(1 g) = 1.03 mW/g; SAR(10 g) = 0.621 mW/g

Maximum value of SAR (measured) = 1.27 mW/g

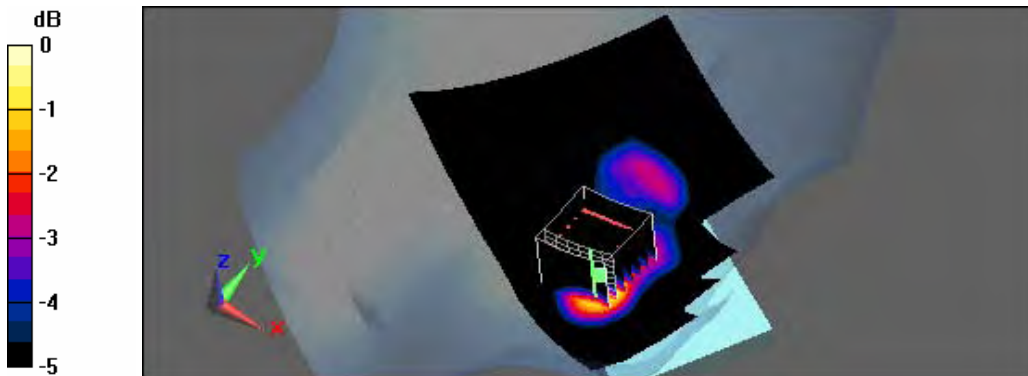

0 dB = 1.27mW/g

Test Laboratory: A Test Lab Techno Corp.
Date/Time: 6/28/2012 6:18:32 AM

LC_GPRS PCS CH810_2D3U

DUT: PM66100; Type: Smartphone; FCC ID: NM8PM66100

Communication System: GPRS PCS (2Down,3Up); Frequency: 1909.8 MHz;Duty Cycle: 1:2.67

Medium parameters used: $f = 1910 \text{ MHz}$; $\sigma = 1.4 \text{ mho/m}$; $\epsilon_r = 39$; $\rho = 1000 \text{ kg/m}^3$

Phantom section: Left Section

Measurement Standard: DASY5 (IEEE/IEC)

DASY5 Configuration:

- Area Scan setting - Find Secondary Maximum Within:2.0dB and with a peak SAR value greater than 0.5 W/Kg
- Probe: EX3DV4 - SN3847; ConvF(8.05, 8.05, 8.05); Calibrated: 3/21/2012
- Sensor-Surface: 3mm (Mechanical Surface Detection)
- Electronics: DAE4 Sn779; Calibrated: 1/23/2012
- Phantom: SAM 12; Type: SAM v4.0; Serial: TP:1009
- Measurement SW: DASY5, V5.0 Build 125;SEMCAD X Version 13.4 Build 125

Left Cheek/Area Scan (71x101x1):

Measurement grid: $dx=15\text{mm}$, $dy=15\text{mm}$

Maximum value of SAR (interpolated) = 1.02 mW/g

Left Cheek/Zoom Scan (7x7x9)/Cube 0:

Measurement grid: $dx=5\text{mm}$, $dy=5\text{mm}$, $dz=3\text{mm}$

Reference Value = 13.1 V/m; Power Drift = -0.023 dB

Peak SAR (extrapolated) = 1.39 W/kg

SAR(1 g) = 0.834 mW/g; SAR(10 g) = 0.488 mW/g

Maximum value of SAR (measured) = 1.02 mW/g

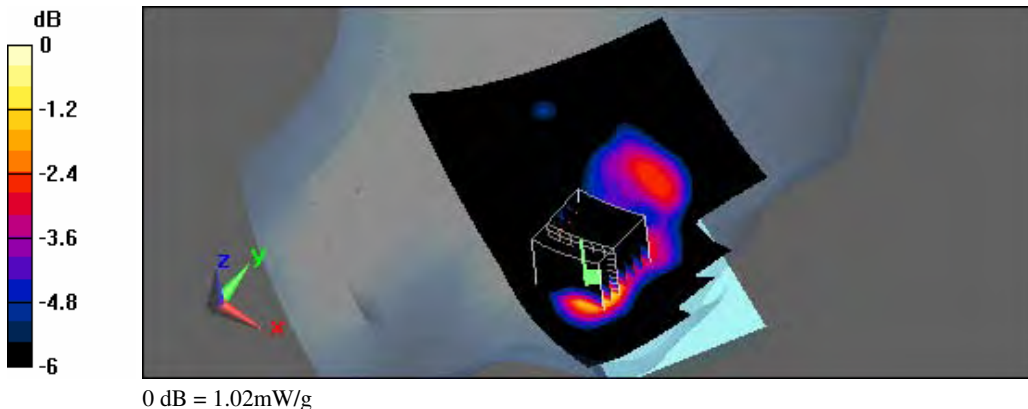



Test Laboratory: A Test Lab Techno Corp.
Date/Time: 6/28/2012 6:45:50 AM

LT_GPRS PCS CH661_2D3U

DUT: PM66100; Type: Smartphone; FCC ID: NM8PM66100

Communication System: GPRS PCS (2Down,3Up); Frequency: 1880 MHz;Duty Cycle: 1:2.67

Medium parameters used: $f = 1880$ MHz; $\sigma = 1.37$ mho/m; $\epsilon_r = 39.1$; $\rho = 1000$ kg/m³

Phantom section: Left Section

Measurement Standard: DASYS (IEEE/IEC)

DASY5 Configuration:

- Area Scan setting - Find Secondary Maximum Within:2.0dB and with a peak SAR value greater than 0.5 W/Kg
- Probe: EX3DV4 - SN3847; ConvF(8.05, 8.05, 8.05); Calibrated: 3/21/2012
- Sensor-Surface: 3mm (Mechanical Surface Detection)
- Electronics: DAE4 Sn779; Calibrated: 1/23/2012
- Phantom: SAM 12; Type: SAM v4.0; Serial: TP:1009
- Measurement SW: DASYS, V5.0 Build 125;SEMCAD X Version 13.4 Build 125

Left Tilted/Area Scan (71x101x1):

Measurement grid: dx=15mm, dy=15mm

Maximum value of SAR (interpolated) = 0.784 mW/g

Left Tilted/Zoom Scan (7x7x9)/Cube 0:

Measurement grid: dx=5mm, dy=5mm, dz=3mm

Reference Value = 23.1 V/m; Power Drift = -0.063 dB

Peak SAR (extrapolated) = 1.28 W/kg

SAR(1 g) = 0.582 mW/g; SAR(10 g) = 0.310 mW/g

Maximum value of SAR (measured) = 0.751 mW/g

Left Tilted/Zoom Scan (7x7x9)/Cube 1:

Measurement grid: dx=5mm, dy=5mm, dz=3mm

Reference Value = 23.1 V/m; Power Drift = -0.063 dB

Peak SAR (extrapolated) = 0.782 W/kg

SAR(1 g) = 0.503 mW/g; SAR(10 g) = 0.304 mW/g

Maximum value of SAR (measured) = 0.603 mW/g

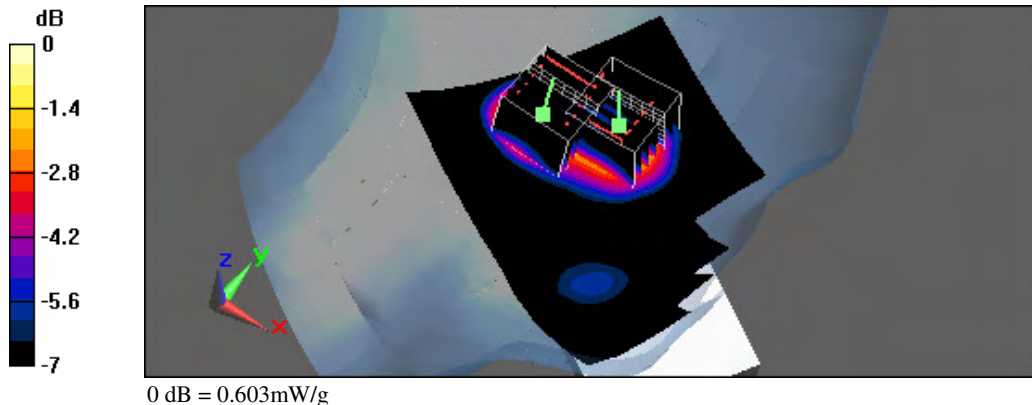

Test Laboratory: A Test Lab Techno Corp.
Date/Time: 6/28/2012 10:06:05 AM

RC_DTM PCS CH661_2D3U

DUT: PM66100; Type: Smartphone; FCC ID: NM8PM66100

Communication System: DTM PCS (2Down,3Up); Frequency: 1880 MHz;Duty Cycle: 1:2.8
Medium parameters used: $f = 1880 \text{ MHz}$; $\sigma = 1.37 \text{ mho/m}$; $\epsilon_r = 39.1$; $\rho = 1000 \text{ kg/m}^3$
Phantom section: Right Section
Measurement Standard: DASYS (IEEE/IEC)

DASY5 Configuration:

- Area Scan setting - Find Secondary Maximum Within:2.0dB and with a peak SAR value greater than 0.5 W/Kg
- Probe: EX3DV4 - SN3847; ConvF(8.05, 8.05, 8.05); Calibrated: 3/21/2012
- Sensor-Surface: 3mm (Mechanical Surface Detection)
- Electronics: DAE4 Sn779; Calibrated: 1/23/2012
- Phantom: SAM 12; Type: SAM v4.0; Serial: TP:1009
- Measurement SW: DASY5, V5.0 Build 125;SEMCAD X Version 13.4 Build 125

Right Cheek/Area Scan (71x111x1):

Measurement grid: $dx=15\text{mm}$, $dy=15\text{mm}$
Maximum value of SAR (interpolated) = 1.01 mW/g

Right Cheek/Zoom Scan (7x7x9)/Cube 0:

Measurement grid: $dx=5\text{mm}$, $dy=5\text{mm}$, $dz=3\text{mm}$
Reference Value = 19.6 V/m; Power Drift = -0.017 dB
Peak SAR (extrapolated) = 1.16 W/kg
SAR(1 g) = 0.792 mW/g; SAR(10 g) = 0.515 mW/g
Maximum value of SAR (measured) = 0.925 mW/g

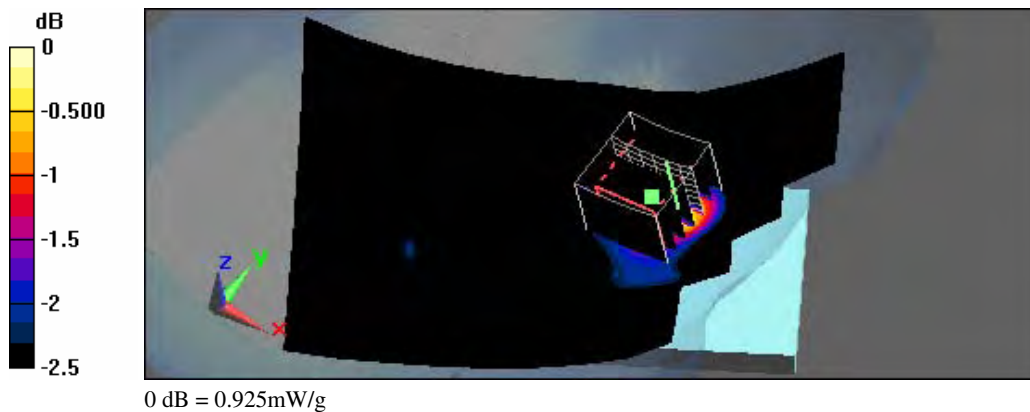

Test Laboratory: A Test Lab Techno Corp.
Date/Time: 6/28/2012 11:23:16 AM

RT_DTM PCS CH512_2D3U

DUT: PM66100; Type: Smartphone; FCC ID: NM8PM66100

Communication System: DTM PCS (2Down,3Up); Frequency: 1850.2 MHz;Duty Cycle: 1:2.8

Medium parameters used (interpolated): $f = 1850.2$ MHz; $\sigma = 1.34$ mho/m; $\epsilon_r = 39.2$; $\rho = 1000$ kg/m³

Phantom section: Right Section

Measurement Standard: DASYS (IEEE/IEC)

DASY5 Configuration:

- Area Scan setting - Find Secondary Maximum Within:2.0dB and with a peak SAR value greater than 0.5 W/Kg
- Probe: EX3DV4 - SN3847; ConvF(8.05, 8.05, 8.05); Calibrated: 3/21/2012
- Sensor-Surface: 3mm (Mechanical Surface Detection)
- Electronics: DAE4 Sn779; Calibrated: 1/23/2012
- Phantom: SAM 12; Type: SAM v4.0; Serial: TP:1009
- Measurement SW: DASY5, V5.0 Build 125;SEMCAD X Version 13.4 Build 125

Right Tilted/Area Scan (71x111x1):

Measurement grid: dx=15mm, dy=15mm
Maximum value of SAR (interpolated) = 0.982 mW/g

Right Tilted/Zoom Scan (7x7x9)/Cube 0:

Measurement grid: dx=5mm, dy=5mm, dz=3mm
Reference Value = 26.6 V/m; Power Drift = 0.119 dB
Peak SAR (extrapolated) = 1.56 W/kg
SAR(1 g) = 0.766 mW/g; SAR(10 g) = 0.356 mW/g
Maximum value of SAR (measured) = 1.02 mW/g

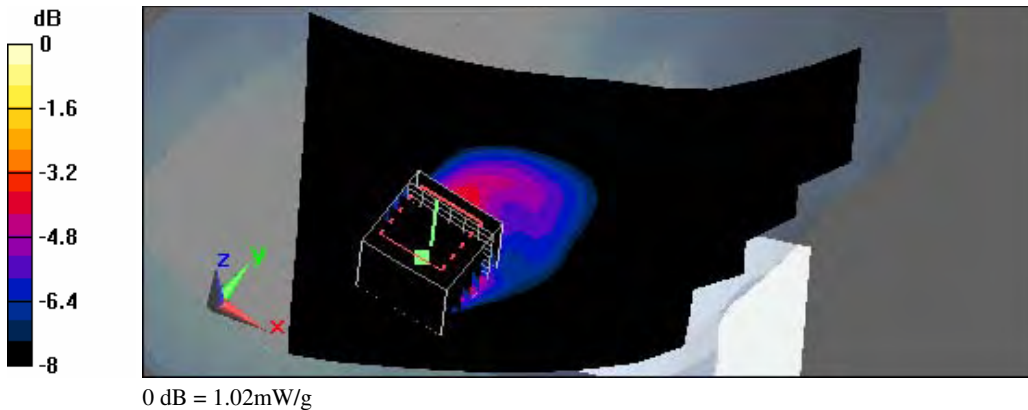



Test Laboratory: A Test Lab Techno Corp.
Date/Time: 6/28/2012 10:47:37 AM

RT_DTM PCS CH661_2D3U

DUT: PM66100; Type: Smartphone; FCC ID: NM8PM66100

Communication System: DTM PCS (2Down,3Up); Frequency: 1880 MHz;Duty Cycle: 1:2.8
Medium parameters used: $f = 1880$ MHz; $\sigma = 1.37$ mho/m; $\epsilon_r = 39.1$; $\rho = 1000$ kg/m³
Phantom section: Right Section
Measurement Standard: DASYS (IEEE/IEC)

DASY5 Configuration:

- Area Scan setting - Find Secondary Maximum Within:2.0dB and with a peak SAR value greater than 0.5 W/Kg
- Probe: EX3DV4 - SN3847; ConvF(8.05, 8.05, 8.05); Calibrated: 3/21/2012
- Sensor-Surface: 3mm (Mechanical Surface Detection)
- Electronics: DAE4 Sn779; Calibrated: 1/23/2012
- Phantom: SAM 12; Type: SAM v4.0; Serial: TP:1009
- Measurement SW: DASYS, V5.0 Build 125;SEMCAD X Version 13.4 Build 125

Right Tilted/Area Scan (71x111x1):

Measurement grid: dx=15mm, dy=15mm
Maximum value of SAR (interpolated) = 0.995 mW/g

Right Tilted/Zoom Scan (7x7x9)/Cube 0:

Measurement grid: dx=5mm, dy=5mm, dz=3mm
Reference Value = 26.7 V/m; Power Drift = -0.040 dB
Peak SAR (extrapolated) = 1.68 W/kg
SAR(1 g) = 0.804 mW/g; SAR(10 g) = 0.370 mW/g
Maximum value of SAR (measured) = 1.05 mW/g

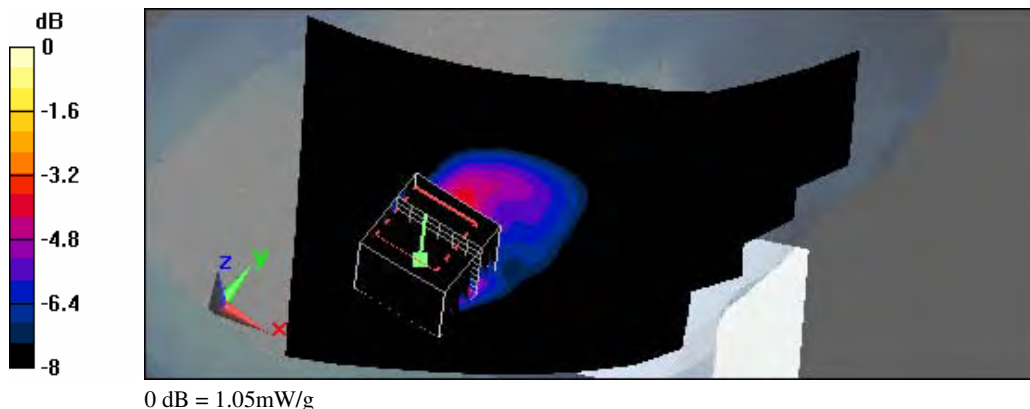

Test Laboratory: A Test Lab Techno Corp.
Date/Time: 6/28/2012 11:54:07 AM

RT_DTM PCS CH810_2D3U

DUT: PM66100; Type: Smartphone; FCC ID: NM8PM66100

Communication System: DTM PCS (2Down,3Up); Frequency: 1909.8 MHz;Duty Cycle: 1:2.8

Medium parameters used: $f = 1910$ MHz; $\sigma = 1.4$ mho/m; $\epsilon_r = 39$; $\rho = 1000$ kg/m³

Phantom section: Right Section

Measurement Standard: DASYS (IEEE/IEC)

DASY5 Configuration:

- Area Scan setting - Find Secondary Maximum Within:2.0dB and with a peak SAR value greater than 0.5 W/Kg
- Probe: EX3DV4 - SN3847; ConvF(8.05, 8.05, 8.05); Calibrated: 3/21/2012
- Sensor-Surface: 3mm (Mechanical Surface Detection)
- Electronics: DAE4 Sn779; Calibrated: 1/23/2012
- Phantom: SAM 12; Type: SAM v4.0; Serial: TP:1009
- Measurement SW: DASY5, V5.0 Build 125;SEMCAD X Version 13.4 Build 125

Right Tilted/Area Scan (71x111x1):

Measurement grid: dx=15mm, dy=15mm

Maximum value of SAR (interpolated) = 0.816 mW/g

Right Tilted/Zoom Scan (7x7x9)/Cube 0:

Measurement grid: dx=5mm, dy=5mm, dz=3mm

Reference Value = 24.2 V/m; Power Drift = -0.011 dB

Peak SAR (extrapolated) = 1.43 W/kg

SAR(1 g) = 0.687 mW/g; SAR(10 g) = 0.317 mW/g

Maximum value of SAR (measured) = 0.924 mW/g

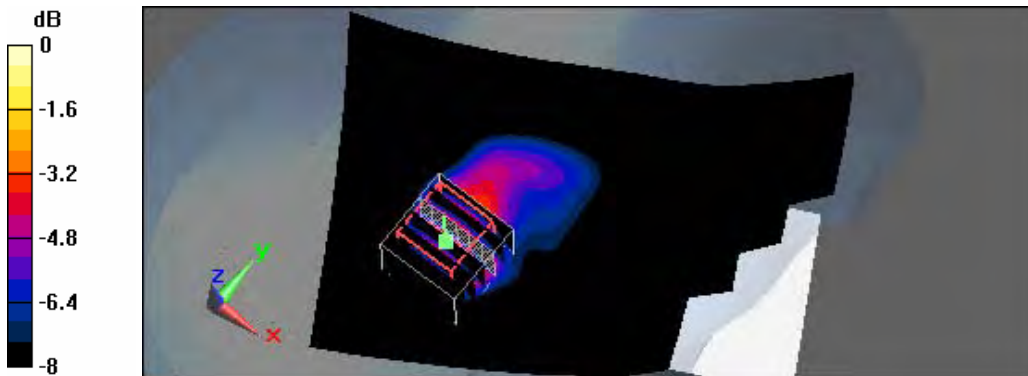

0 dB = 0.924mW/g

Test Laboratory: A Test Lab Techno Corp.
Date/Time: 6/28/2012 2:38:03 PM

LC_DTM PCS CH512_2D3U

DUT: PM66100; Type: Smartphone; FCC ID: NM8PM66100

Communication System: DTM PCS (2Down,3Up); Frequency: 1850.2 MHz;Duty Cycle: 1:2.8

Medium parameters used (interpolated): $f = 1850.2 \text{ MHz}$; $\sigma = 1.34 \text{ mho/m}$; $\epsilon_r = 39.2$; $\rho = 1000 \text{ kg/m}^3$

Phantom section: Left Section

Measurement Standard: DASYS (IEEE/IEC)

DASY5 Configuration:

- Area Scan setting - Find Secondary Maximum Within:2.0dB and with a peak SAR value greater than 0.5 W/Kg
- Probe: EX3DV4 - SN3847; ConvF(8.05, 8.05, 8.05); Calibrated: 3/21/2012
- Sensor-Surface: 3mm (Mechanical Surface Detection)
- Electronics: DAE4 Sn779; Calibrated: 1/23/2012
- Phantom: SAM 12; Type: SAM v4.0; Serial: TP:1009
- Measurement SW: DASY5, V5.0 Build 125;SEMCAD X Version 13.4 Build 125

Left Cheek/Area Scan (71x111x1):

Measurement grid: dx=15mm, dy=15mm

Maximum value of SAR (interpolated) = 1.25 mW/g

Left Cheek/Zoom Scan (7x7x9)/Cube 0:

Measurement grid: dx=5mm, dy=5mm, dz=3mm

Reference Value = 12.9 V/m; Power Drift = 0.018 dB

Peak SAR (extrapolated) = 1.53 W/kg

SAR(1 g) = 0.973 mW/g; SAR(10 g) = 0.595 mW/g

Maximum value of SAR (measured) = 1.15 mW/g

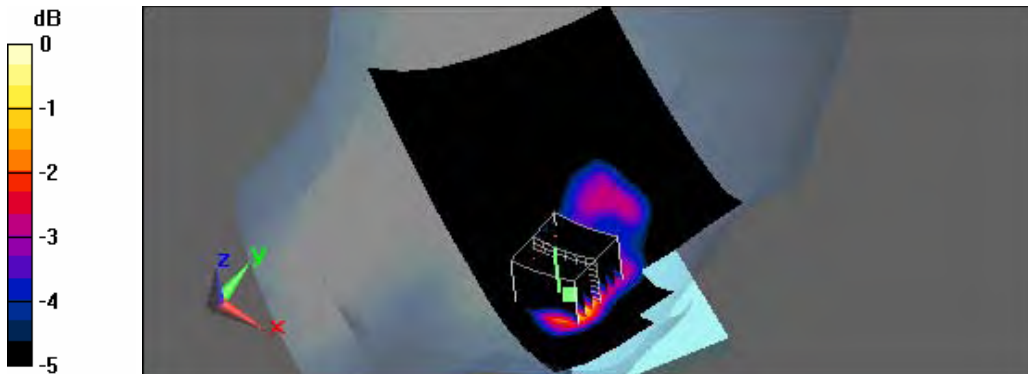

0 dB = 1.15mW/g



Test Laboratory: A Test Lab Techno Corp.
Date/Time: 6/28/2012 1:26:48 PM

LC_DTM PCS CH661_2D3U

DUT: PM66100; Type: Smartphone; FCC ID: NM8PM66100

Communication System: DTM PCS (2Down,3Up); Frequency: 1880 MHz;Duty Cycle: 1:2.8
Medium parameters used: $f = 1880$ MHz; $\sigma = 1.37$ mho/m; $\epsilon_r = 39.1$; $\rho = 1000$ kg/m³
Phantom section: Left Section
Measurement Standard: DASYS (IEEE/IEC)

DASY5 Configuration:

- Area Scan setting - Find Secondary Maximum Within:2.0dB and with a peak SAR value greater than 0.5 W/Kg
- Probe: EX3DV4 - SN3847; ConvF(8.05, 8.05, 8.05); Calibrated: 3/21/2012
- Sensor-Surface: 3mm (Mechanical Surface Detection)
- Electronics: DAE4 Sn779; Calibrated: 1/23/2012
- Phantom: SAM 12; Type: SAM v4.0; Serial: TP:1009
- Measurement SW: DASY5, V5.0 Build 125;SEMCAD X Version 13.4 Build 125

Left Cheek/Area Scan (71x111x1):

Measurement grid: dx=15mm, dy=15mm
Maximum value of SAR (interpolated) = 1.07 mW/g

Left Cheek/Zoom Scan (7x7x9)/Cube 0:

Measurement grid: dx=5mm, dy=5mm, dz=3mm
Reference Value = 13.2 V/m; Power Drift = -0.00676 dB
Peak SAR (extrapolated) = 1.32 W/kg
SAR(1 g) = 0.844 mW/g; SAR(10 g) = 0.515 mW/g
Maximum value of SAR (measured) = 1.01 mW/g

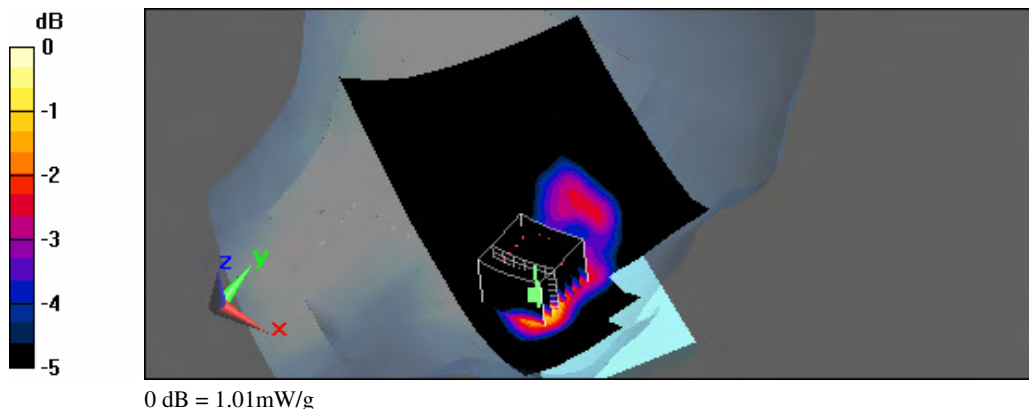

Test Laboratory: A Test Lab Techno Corp.
Date/Time: 6/28/2012 2:06:16 PM

LC_DTM PCS CH810_2D3U

DUT: PM66100; Type: Smartphone; FCC ID: NM8PM66100

Communication System: DTM PCS (2Down,3Up); Frequency: 1909.8 MHz;Duty Cycle: 1:2.8

Medium parameters used: $f = 1910$ MHz; $\sigma = 1.4$ mho/m; $\epsilon_r = 39$; $\rho = 1000$ kg/m³

Phantom section: Left Section

Measurement Standard: DASYS (IEEE/IEC)

DASY5 Configuration:

- Area Scan setting - Find Secondary Maximum Within:2.0dB and with a peak SAR value greater than 0.5 W/Kg
- Probe: EX3DV4 - SN3847; ConvF(8.05, 8.05, 8.05); Calibrated: 3/21/2012
- Sensor-Surface: 3mm (Mechanical Surface Detection)
- Electronics: DAE4 Sn779; Calibrated: 1/23/2012
- Phantom: SAM 12; Type: SAM v4.0; Serial: TP:1009
- Measurement SW: DASY5, V5.0 Build 125;SEMCAD X Version 13.4 Build 125

Left Cheek/Area Scan (71x111x1):

Measurement grid: dx=15mm, dy=15mm

Maximum value of SAR (interpolated) = 1.03 mW/g

Left Cheek/Zoom Scan (7x7x9)/Cube 0:

Measurement grid: dx=5mm, dy=5mm, dz=3mm

Reference Value = 13.4 V/m; Power Drift = -0.024 dB

Peak SAR (extrapolated) = 1.32 W/kg

SAR(1 g) = 0.814 mW/g; SAR(10 g) = 0.487 mW/g

Maximum value of SAR (measured) = 0.975 mW/g

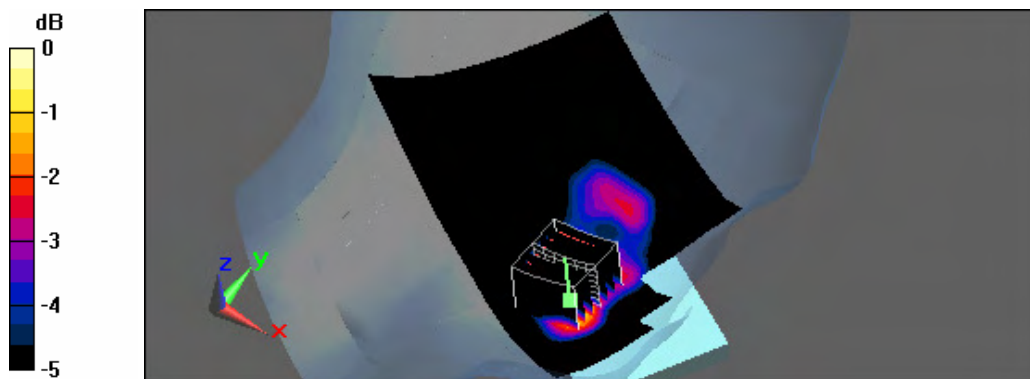

Test Laboratory: A Test Lab Techno Corp.
Date/Time: 6/28/2012 3:06:35 PM

LT_DTM PCS CH661_2D3U

DUT: PM66100; Type: Smartphone; FCC ID: NM8PM66100

Communication System: DTM PCS (2Down,3Up); Frequency: 1880 MHz;Duty Cycle: 1:2.8
Medium parameters used: $f = 1880 \text{ MHz}$; $\sigma = 1.37 \text{ mho/m}$; $\epsilon_r = 39.1$; $\rho = 1000 \text{ kg/m}^3$
Phantom section: Left Section
Measurement Standard: DASYS (IEEE/IEC)

DASY5 Configuration:

- Area Scan setting - Find Secondary Maximum Within:2.0dB and with a peak SAR value greater than 0.5 W/Kg
- Probe: EX3DV4 - SN3847; ConvF(8.05, 8.05, 8.05); Calibrated: 3/21/2012
- Sensor-Surface: 3mm (Mechanical Surface Detection)
- Electronics: DAE4 Sn779; Calibrated: 1/23/2012
- Phantom: SAM 12; Type: SAM v4.0; Serial: TP:1009
- Measurement SW: DASY5, V5.0 Build 125;SEMCAD X Version 13.4 Build 125

Left Tilted/Area Scan (71x111x1):

Measurement grid: $dx=15\text{mm}$, $dy=15\text{mm}$
Maximum value of SAR (interpolated) = 0.690 mW/g

Left Tilted/Zoom Scan (7x7x9)/Cube 0:

Measurement grid: $dx=5\text{mm}$, $dy=5\text{mm}$, $dz=3\text{mm}$
Reference Value = 23.1 V/m; Power Drift = -0.043 dB
Peak SAR (extrapolated) = 1.1 W/kg
SAR(1 g) = 0.577 mW/g; SAR(10 g) = 0.302 mW/g
Maximum value of SAR (measured) = 0.725 mW/g

Left Tilted/Zoom Scan (7x7x9)/Cube 1:

Measurement grid: $dx=5\text{mm}$, $dy=5\text{mm}$, $dz=3\text{mm}$
Reference Value = 23.1 V/m; Power Drift = -0.043 dB
Peak SAR (extrapolated) = 0.683 W/kg
SAR(1 g) = 0.447 mW/g; SAR(10 g) = 0.277 mW/g
Maximum value of SAR (measured) = 0.528 mW/g

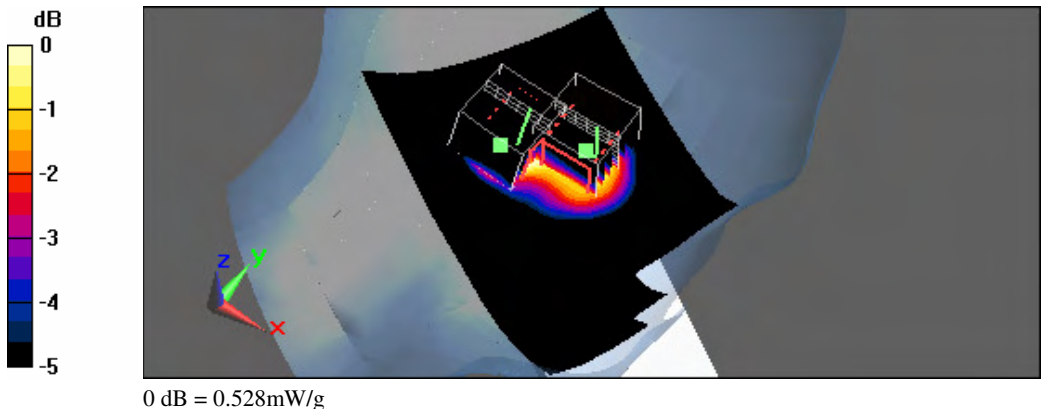

Test Laboratory: A Test Lab Techno Corp.
Date/Time: 6/26/2012 6:28:02 PM

RC_WCDMA Band V CH4233

DUT: PM66100; Type: Smartphone; FCC ID: NM8PM66100

Communication System: WCDMA Band V; Frequency: 846.6 MHz; Duty Cycle: 1:1
Medium parameters used: $f = 847 \text{ MHz}$; $\sigma = 0.925 \text{ mho/m}$; $\epsilon_r = 40.9$; $\rho = 1000 \text{ kg/m}^3$
Phantom section: Right Section
Measurement Standard: DASYS (IEEE/IEC)

DASY5 Configuration:

- Area Scan setting - Find Secondary Maximum Within:2.0dB and with a peak SAR value greater than 0.5 W/Kg
- Probe: EX3DV4 - SN3847; ConvF(9.34, 9.34, 9.34); Calibrated: 3/21/2012
- Sensor-Surface: 3mm (Mechanical Surface Detection)
- Electronics: DAE4 Sn779; Calibrated: 1/23/2012
- Phantom: SAM 12; Type: SAM v4.0; Serial: TP:1009
- Measurement SW: DASYS, V5.0 Build 125; SEMCAD X Version 13.4 Build 125

Right Cheek/Area Scan (71x101x1):

Measurement grid: $dx=15\text{mm}$, $dy=15\text{mm}$
Maximum value of SAR (interpolated) = 0.215 mW/g

Right Cheek/Zoom Scan (7x7x9)/Cube 0:

Measurement grid: $dx=5\text{mm}$, $dy=5\text{mm}$, $dz=3\text{mm}$
Reference Value = 3.42 V/m; Power Drift = -0.00264 dB
Peak SAR (extrapolated) = 0.236 W/kg
SAR(1 g) = 0.191 mW/g; SAR(10 g) = 0.140 mW/g
Maximum value of SAR (measured) = 0.211 mW/g

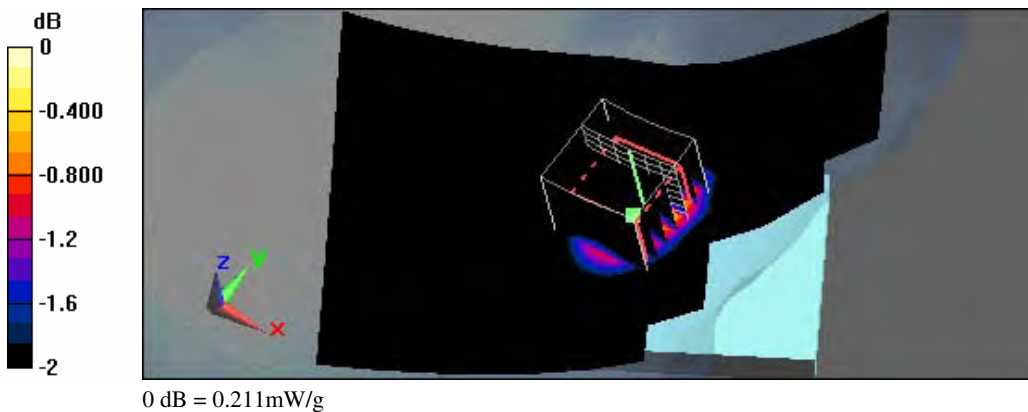

Test Laboratory: A Test Lab Techno Corp.
Date/Time: 6/26/2012 7:02:10 PM

RT_WCDMA Band V CH4233

DUT: PM66100; Type: Smartphone; FCC ID: NM8PM66100

Communication System: WCDMA Band V; Frequency: 846.6 MHz; Duty Cycle: 1:1
Medium parameters used: $f = 847 \text{ MHz}$; $\sigma = 0.925 \text{ mho/m}$; $\epsilon_r = 40.9$; $\rho = 1000 \text{ kg/m}^3$
Phantom section: Right Section
Measurement Standard: DASYS (IEEE/IEC)

DASY5 Configuration:

- Area Scan setting - Find Secondary Maximum Within:2.0dB and with a peak SAR value greater than 0.5 W/Kg
- Probe: EX3DV4 - SN3847; ConvF(9.34, 9.34, 9.34); Calibrated: 3/21/2012
- Sensor-Surface: 3mm (Mechanical Surface Detection)
- Electronics: DAE4 Sn779; Calibrated: 1/23/2012
- Phantom: SAM 12; Type: SAM v4.0; Serial: TP:1009
- Measurement SW: DASY5, V5.0 Build 125; SEMCAD X Version 13.4 Build 125

Right Tilted/Area Scan (71x101x1):

Measurement grid: $dx=15\text{mm}$, $dy=15\text{mm}$
Maximum value of SAR (interpolated) = 0.111 mW/g

Right Tilted/Zoom Scan (7x7x9)/Cube 0:

Measurement grid: $dx=5\text{mm}$, $dy=5\text{mm}$, $dz=3\text{mm}$
Reference Value = 7.37 V/m; Power Drift = 0.095 dB
Peak SAR (extrapolated) = 0.126 W/kg
SAR(1 g) = 0.101 mW/g; SAR(10 g) = 0.076 mW/g
Maximum value of SAR (measured) = 0.111 mW/g

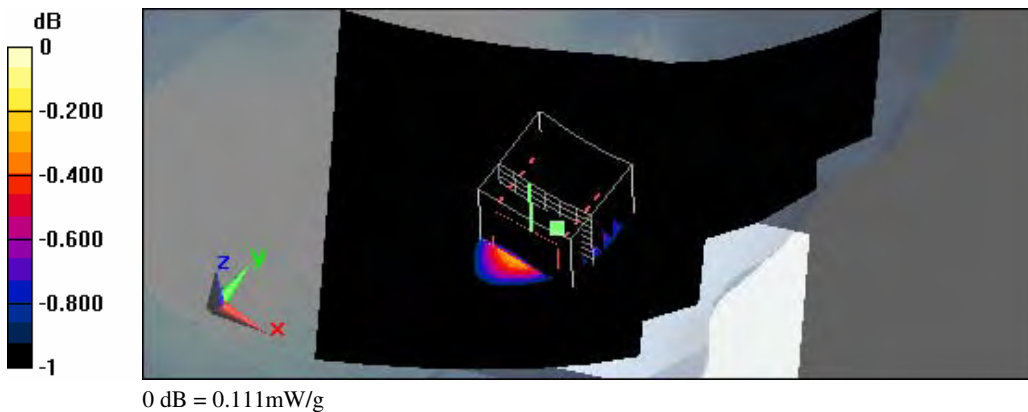

Test Laboratory: A Test Lab Techno Corp.
Date/Time: 6/26/2012 7:38:16 PM

LC_WCDMA Band V CH4233

DUT: PM66100; Type: Smartphone; FCC ID: NM8PM66100

Communication System: WCDMA Band V; Frequency: 846.6 MHz; Duty Cycle: 1:1
Medium parameters used: $f = 847 \text{ MHz}$; $\sigma = 0.925 \text{ mho/m}$; $\epsilon_r = 40.9$; $\rho = 1000 \text{ kg/m}^3$
Phantom section: Left Section
Measurement Standard: DASYS (IEEE/IEC)

DASY5 Configuration:

- Area Scan setting - Find Secondary Maximum Within:2.0dB and with a peak SAR value greater than 0.5 W/Kg
- Probe: EX3DV4 - SN3847; ConvF(9.34, 9.34, 9.34); Calibrated: 3/21/2012
- Sensor-Surface: 3mm (Mechanical Surface Detection)
- Electronics: DAE4 Sn779; Calibrated: 1/23/2012
- Phantom: SAM 12; Type: SAM v4.0; Serial: TP:1009
- Measurement SW: DASY5, V5.0 Build 125; SEMCAD X Version 13.4 Build 125

Left Cheek/Area Scan (71x101x1):

Measurement grid: $dx=15\text{mm}$, $dy=15\text{mm}$
Maximum value of SAR (interpolated) = 0.146 mW/g

Left Cheek/Zoom Scan (7x7x9)/Cube 0:

Measurement grid: $dx=5\text{mm}$, $dy=5\text{mm}$, $dz=3\text{mm}$
Reference Value = 4.43 V/m; Power Drift = -0.036 dB
Peak SAR (extrapolated) = 0.152 W/kg
SAR(1 g) = 0.128 mW/g; SAR(10 g) = 0.097 mW/g
Maximum value of SAR (measured) = 0.139 mW/g

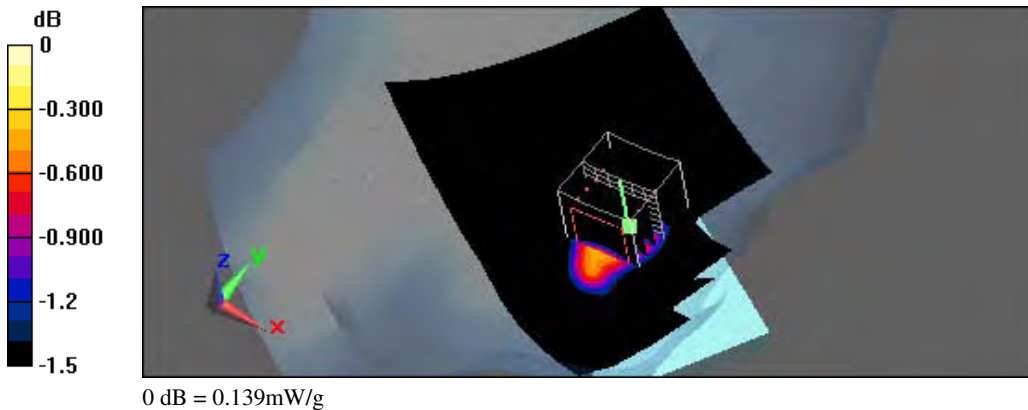



Test Laboratory: A Test Lab Techno Corp.
Date/Time: 6/26/2012 8:07:25 PM

LT_WCDMA Band V CH4233

DUT: PM66100; Type: Smartphone; FCC ID: NM8PM66100

Communication System: WCDMA Band V; Frequency: 846.6 MHz; Duty Cycle: 1:1
Medium parameters used: $f = 847 \text{ MHz}$; $\sigma = 0.925 \text{ mho/m}$; $\epsilon_r = 40.9$; $\rho = 1000 \text{ kg/m}^3$
Phantom section: Left Section
Measurement Standard: DASYS (IEEE/IEC)

DASY5 Configuration:

- Area Scan setting - Find Secondary Maximum Within:2.0dB and with a peak SAR value greater than 0.5 W/Kg
- Probe: EX3DV4 - SN3847; ConvF(9.34, 9.34, 9.34); Calibrated: 3/21/2012
- Sensor-Surface: 3mm (Mechanical Surface Detection)
- Electronics: DAE4 Sn779; Calibrated: 1/23/2012
- Phantom: SAM 12; Type: SAM v4.0; Serial: TP:1009
- Measurement SW: DASY5, V5.0 Build 125; SEMCAD X Version 13.4 Build 125

Left Tilted/Area Scan (71x101x1):

Measurement grid: $dx=15\text{mm}$, $dy=15\text{mm}$
Maximum value of SAR (interpolated) = 0.095 mW/g

Left Tilted/Zoom Scan (7x7x9)/Cube 0:

Measurement grid: $dx=5\text{mm}$, $dy=5\text{mm}$, $dz=3\text{mm}$
Reference Value = 7.76 V/m; Power Drift = 0.093 dB
Peak SAR (extrapolated) = 0.106 W/kg
SAR(1 g) = 0.086 mW/g; SAR(10 g) = 0.066 mW/g
Maximum value of SAR (measured) = 0.094 mW/g

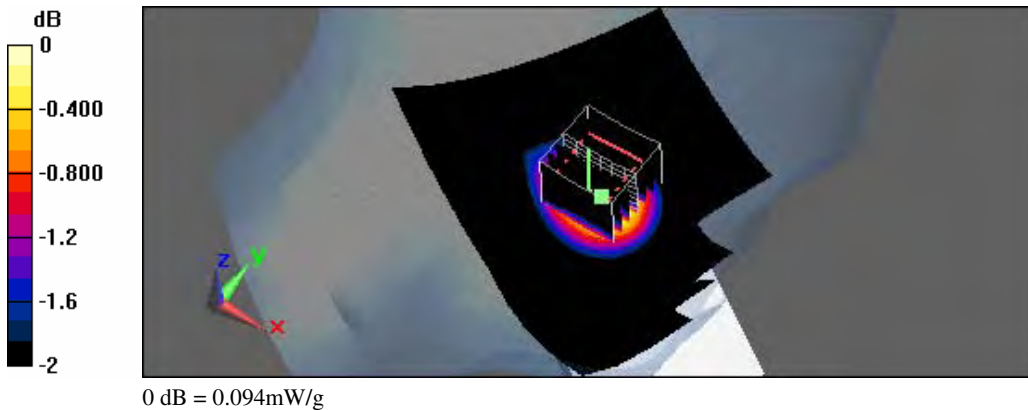

Test Laboratory: A Test Lab Techno Corp.
Date/Time: 7/3/2012 10:32:56 AM

RC_802.11b CH11_1M

DUT: PM66100; Type: Smartphone; FCC ID: NM8PM66100

Communication System: IEEE 802.11b; Frequency: 2462 MHz; Duty Cycle: 1:1
Medium parameters used: $f = 2462$ MHz; $\sigma = 1.83$ mho/m; $\epsilon_r = 39.5$; $\rho = 1000$ kg/m³
Phantom section: Right Section
Measurement Standard: DASYS (IEEE/IEC)

DASY5 Configuration:

- Area Scan setting - Find Secondary Maximum Within:2.0dB and with a peak SAR value greater than 0.5 W/Kg
- Probe: EX3DV4 - SN3847; ConvF(7.17, 7.17, 7.17); Calibrated: 3/21/2012
- Sensor-Surface: 3mm (Mechanical Surface Detection)
- Electronics: DAE4 Sn779; Calibrated: 1/23/2012
- Phantom: SAM 12; Type: SAM v4.0; Serial: TP:1009
- Measurement SW: DASY5, V5.0 Build 125; SEMCAD X Version 13.4 Build 125

Right Cheek/Area Scan (71x111x1):

Measurement grid: dx=15mm, dy=15mm
Maximum value of SAR (interpolated) = 0.391 mW/g

Right Cheek/Zoom Scan (7x7x9)/Cube 0:

Measurement grid: dx=5mm, dy=5mm, dz=3mm
Reference Value = 14.8 V/m; Power Drift = 0.070 dB
Peak SAR (extrapolated) = 0.620 W/kg
SAR(1 g) = 0.323 mW/g; SAR(10 g) = 0.172 mW/g
Maximum value of SAR (measured) = 0.403 mW/g

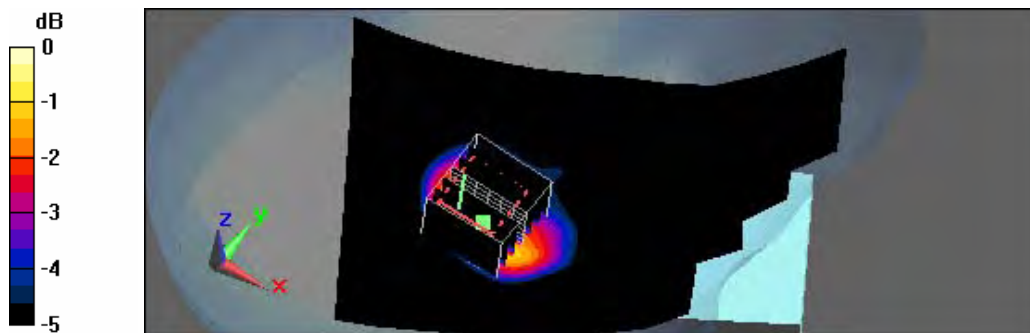

0 dB = 0.403mW/g



Test Laboratory: A Test Lab Techno Corp.
Date/Time: 7/3/2012 11:16:48 AM

RT_802.11b CH11_1M

DUT: PM66100; Type: Smartphone; FCC ID: NM8PM66100

Communication System: IEEE 802.11b; Frequency: 2462 MHz; Duty Cycle: 1:1
Medium parameters used: $f = 2462$ MHz; $\sigma = 1.83$ mho/m; $\epsilon_r = 39.5$; $\rho = 1000$ kg/m³
Phantom section: Right Section
Measurement Standard: DASYS (IEEE/IEC)

DASY5 Configuration:

- Area Scan setting - Find Secondary Maximum Within:2.0dB and with a peak SAR value greater than 0.5 W/Kg
- Probe: EX3DV4 - SN3847; ConvF(7.17, 7.17, 7.17); Calibrated: 3/21/2012
- Sensor-Surface: 3mm (Mechanical Surface Detection)
- Electronics: DAE4 Sn779; Calibrated: 1/23/2012
- Phantom: SAM 12; Type: SAM v4.0; Serial: TP:1009
- Measurement SW: DASYS, V5.0 Build 125; SEMCAD X Version 13.4 Build 125

Right Tilted/Area Scan (71x11x1):

Measurement grid: dx=15mm, dy=15mm
Maximum value of SAR (interpolated) = 0.522 mW/g

Right Tilted/Zoom Scan (7x7x9)/Cube 0:

Measurement grid: dx=5mm, dy=5mm, dz=3mm
Reference Value = 17.4 V/m; Power Drift = -0.000607 dB
Peak SAR (extrapolated) = 0.886 W/kg
SAR(1 g) = 0.445 mW/g; SAR(10 g) = 0.217 mW/g
Maximum value of SAR (measured) = 0.574 mW/g

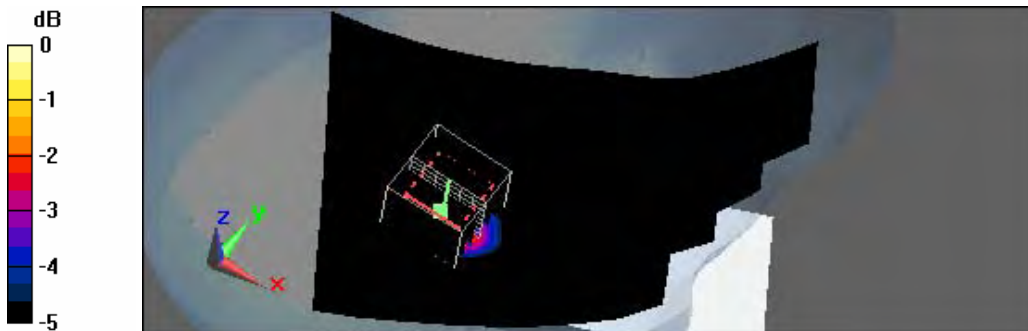

0 dB = 0.574mW/g

Test Laboratory: A Test Lab Techno Corp.
Date/Time: 7/3/2012 11:44:53 AM

LC_802.11b CH11_1M

DUT: PM66100; Type: Smartphone; FCC ID: NM8PM66100

Communication System: IEEE 802.11b; Frequency: 2462 MHz; Duty Cycle: 1:1
Medium parameters used: $f = 2462$ MHz; $\sigma = 1.83$ mho/m; $\epsilon_r = 39.5$; $\rho = 1000$ kg/m³
Phantom section: Left Section
Measurement Standard: DASYS (IEEE/IEC)

DASY5 Configuration:

- Area Scan setting - Find Secondary Maximum Within:2.0dB and with a peak SAR value greater than 0.5 W/Kg
- Probe: EX3DV4 - SN3847; ConvF(7.17, 7.17, 7.17); Calibrated: 3/21/2012
- Sensor-Surface: 3mm (Mechanical Surface Detection)
- Electronics: DAE4 Sn779; Calibrated: 1/23/2012
- Phantom: SAM 12; Type: SAM v4.0; Serial: TP:1009
- Measurement SW: DASY5, V5.0 Build 125; SEMCAD X Version 13.4 Build 125

Left Cheek/Area Scan (71x111x1):

Measurement grid: dx=15mm, dy=15mm
Maximum value of SAR (interpolated) = 0.424 mW/g

Left Cheek/Zoom Scan (7x7x9)/Cube 0:

Measurement grid: dx=5mm, dy=5mm, dz=3mm
Reference Value = 13.3 V/m; Power Drift = 0.00945 dB
Peak SAR (extrapolated) = 0.858 W/kg
SAR(1 g) = 0.391 mW/g; SAR(10 g) = 0.177 mW/g
Maximum value of SAR (measured) = 0.528 mW/g

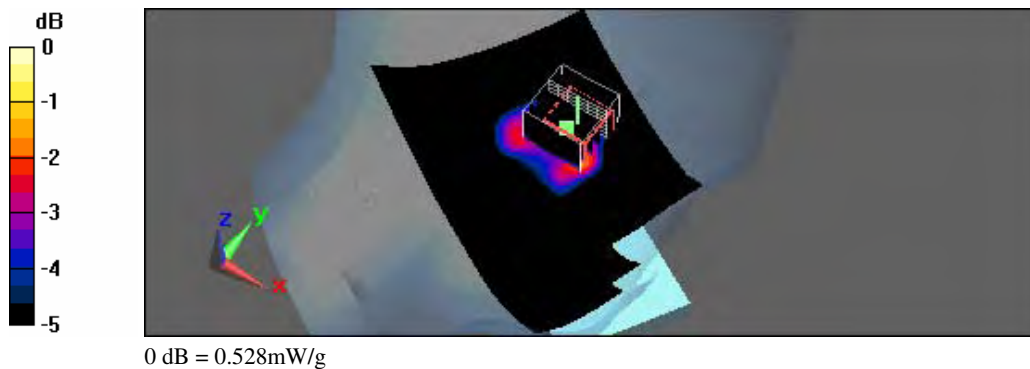

Test Laboratory: A Test Lab Techno Corp.
Date/Time: 7/3/2012 1:33:36 PM

LT_802.11b CH11_1M

DUT: PM66100; Type: Smartphone; FCC ID: NM8PM66100

Communication System: IEEE 802.11b; Frequency: 2462 MHz; Duty Cycle: 1:1
Medium parameters used: $f = 2462$ MHz; $\sigma = 1.83$ mho/m; $\epsilon_r = 39.5$; $\rho = 1000$ kg/m³
Phantom section: Left Section
Measurement Standard: DASYS (IEEE/IEC)

DASY5 Configuration:

- Area Scan setting - Find Secondary Maximum Within:2.0dB and with a peak SAR value greater than 0.5 W/Kg
- Probe: EX3DV4 - SN3847; ConvF(7.17, 7.17, 7.17); Calibrated: 3/21/2012
- Sensor-Surface: 3mm (Mechanical Surface Detection)
- Electronics: DAE4 Sn779; Calibrated: 1/23/2012
- Phantom: SAM 12; Type: SAM v4.0; Serial: TP:1009
- Measurement SW: DASY5, V5.0 Build 125; SEMCAD X Version 13.4 Build 125

Left Tilted/Area Scan (71x111x1):

Measurement grid: dx=15mm, dy=15mm
Maximum value of SAR (interpolated) = 0.405 mW/g

Left Tilted/Zoom Scan (7x7x9)/Cube 0:

Measurement grid: dx=5mm, dy=5mm, dz=3mm
Reference Value = 16.1 V/m; Power Drift = -0.016 dB
Peak SAR (extrapolated) = 0.750 W/kg
SAR(1 g) = 0.365 mW/g; SAR(10 g) = 0.176 mW/g
Maximum value of SAR (measured) = 0.468 mW/g

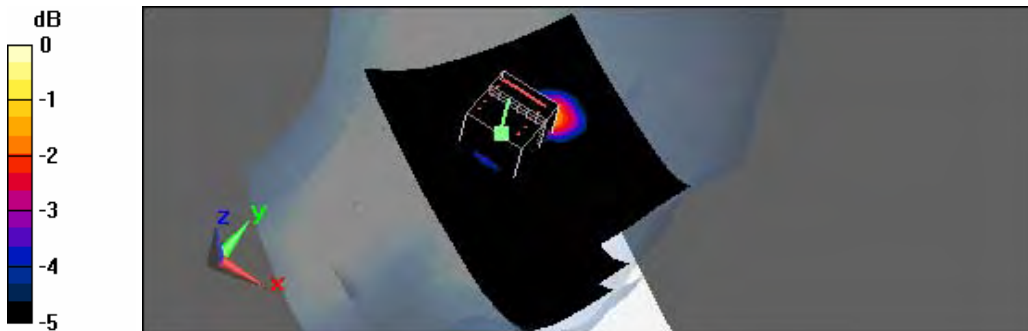

0 dB = 0.468mW/g

Test Laboratory: A Test Lab Techno Corp.
Date/Time: 6/29/2012 1:23:25 AM

Flat_GSM 850 CH128_Front Surface to Phantom_10mm_Headset

DUT: PM66100; Type: Smartphone; FCC ID: NM8PM66100

Communication System: GSM850; Frequency: 824.2 MHz; Duty Cycle: 1:8
Medium parameters used (interpolated): $f = 824.2$ MHz; $\sigma = 0.98$ mho/m; $\epsilon_r = 55.1$; $\rho = 1000$ kg/m³
Phantom section: Flat Section
Measurement Standard: DASYS (IEEE/IEC)

DASY5 Configuration:

- Area Scan setting - Find Secondary Maximum Within: 2.0dB and with a peak SAR value greater than 0.5 W/Kg
- Probe: EX3DV4 - SN3847; ConvF(9.24, 9.24, 9.24); Calibrated: 3/21/2012
- Sensor-Surface: 3mm (Mechanical Surface Detection)
- Electronics: DAE4 Sn779; Calibrated: 1/23/2012
- Phantom: SAM 12; Type: SAM v4.0; Serial: TP:1009
- Measurement SW: DASY5, V5.0 Build 125; SEMCAD X Version 13.4 Build 125

Flat/Area Scan (71x101x1):

Measurement grid: dx=15mm, dy=15mm
Maximum value of SAR (interpolated) = 0.207 mW/g

Flat/Zoom Scan (7x7x9)/Cube 0:

Measurement grid: dx=5mm, dy=5mm, dz=3mm
Reference Value = 13.1 V/m; Power Drift = -0.013 dB
Peak SAR (extrapolated) = 0.232 W/kg
SAR(1 g) = 0.179 mW/g; SAR(10 g) = 0.138 mW/g
Maximum value of SAR (measured) = 0.195 mW/g

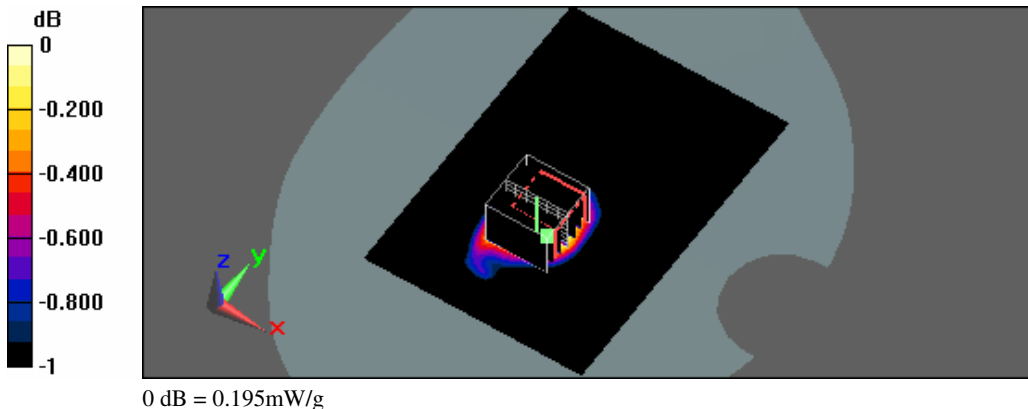

Test Laboratory: A Test Lab Techno Corp.
Date/Time: 6/29/2012 12:53:00 AM

Flat_GSM 850 CH128_Back Surface to Phantom_10mm_Headset

DUT: PM66100; Type: Smartphone; FCC ID: NM8PM66100

Communication System: GSM850; Frequency: 824.2 MHz; Duty Cycle: 1:8
Medium parameters used (interpolated): $f = 824.2$ MHz; $\sigma = 0.98$ mho/m; $\epsilon_r = 55.1$; $\rho = 1000$ kg/m³
Phantom section: Flat Section
Measurement Standard: DASYS (IEEE/IEC)

DASY5 Configuration:

- Area Scan setting - Find Secondary Maximum Within: 2.0dB and with a peak SAR value greater than 0.5 W/Kg
- Probe: EX3DV4 - SN3847; ConvF(9.24, 9.24, 9.24); Calibrated: 3/21/2012
- Sensor-Surface: 3mm (Mechanical Surface Detection)
- Electronics: DAE4 Sn779; Calibrated: 1/23/2012
- Phantom: SAM 12; Type: SAM v4.0; Serial: TP:1009
- Measurement SW: DASY5, V5.0 Build 125; SEMCAD X Version 13.4 Build 125

Flat/Area Scan (71x101x1):

Measurement grid: dx=15mm, dy=15mm
Maximum value of SAR (interpolated) = 0.372 mW/g

Flat/Zoom Scan (7x7x9)/Cube 0:

Measurement grid: dx=5mm, dy=5mm, dz=3mm
Reference Value = 18.5 V/m; Power Drift = -0.027 dB
Peak SAR (extrapolated) = 0.423 W/kg
SAR(1 g) = 0.326 mW/g; SAR(10 g) = 0.248 mW/g
Maximum value of SAR (measured) = 0.362 mW/g

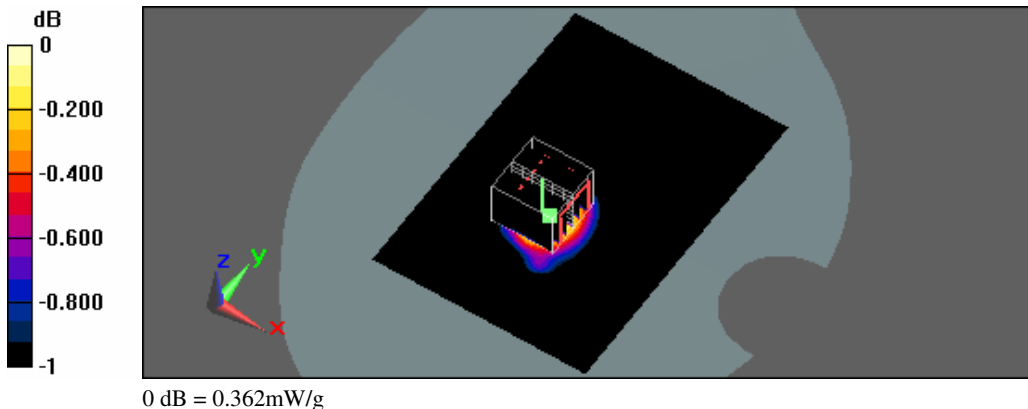

Test Laboratory: A Test Lab Techno Corp.
Date/Time: 6/29/2012 1:55:29 AM

Flat_GPRS 850 CH128_2D3U_Front Surface to Phantom_10mm

DUT: PM66100; Type: Smartphone; FCC ID: NM8PM66100

Communication System: GPRS 850 (2Down, 3Up); Frequency: 824.2 MHz; Duty Cycle: 1:2.67

Medium parameters used (interpolated): $f = 824.2$ MHz; $\sigma = 0.98$ mho/m; $\epsilon_r = 55.1$; $\rho = 1000$ kg/m³

Phantom section: Flat Section

Measurement Standard: DASYS (IEEE/IEC)

DASY5 Configuration:

- Area Scan setting - Find Secondary Maximum Within: 2.0dB and with a peak SAR value greater than 0.5 W/Kg
- Probe: EX3DV4 - SN3847; ConvF(9.24, 9.24, 9.24); Calibrated: 3/21/2012
- Sensor-Surface: 3mm (Mechanical Surface Detection)
- Electronics: DAE4 Sn779; Calibrated: 1/23/2012
- Phantom: SAM 12; Type: SAM v4.0; Serial: TP:1009
- Measurement SW: DASYS, V5.0 Build 125; SEMCAD X Version 13.4 Build 125

Flat/Area Scan (71x101x1):

Measurement grid: dx=15mm, dy=15mm
Maximum value of SAR (interpolated) = 0.354 mW/g

Flat/Zoom Scan (7x7x9)/Cube 0:

Measurement grid: dx=5mm, dy=5mm, dz=3mm
Reference Value = 15 V/m; Power Drift = -0.182 dB
Peak SAR (extrapolated) = 0.407 W/kg
SAR(1 g) = 0.311 mW/g; SAR(10 g) = 0.239 mW/g
Maximum value of SAR (measured) = 0.349 mW/g

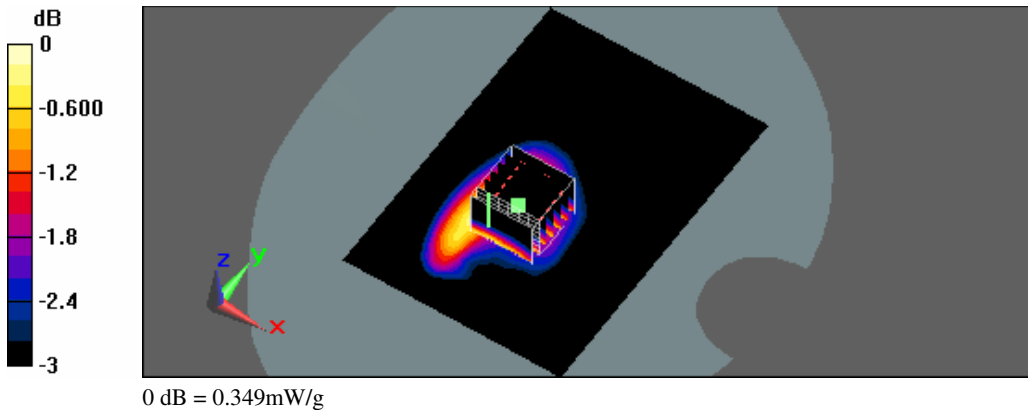

Test Laboratory: A Test Lab Techno Corp.
Date/Time: 6/29/2012 12:22:59 AM

Flat_GPRS 850 CH128_2D3U_Back Surface to Phantom_10mm

DUT: PM66100; Type: Smartphone; FCC ID: NM8PM66100

Communication System: GPRS 850 (2Down, 3Up); Frequency: 824.2 MHz; Duty Cycle: 1:2.67

Medium parameters used (interpolated): $f = 824.2$ MHz; $\sigma = 0.98$ mho/m; $\epsilon_r = 55.1$; $\rho = 1000$ kg/m³

Phantom section: Flat Section

Measurement Standard: DASY5 (IEEE/IEC)

DASY5 Configuration:

- Area Scan setting - Find Secondary Maximum Within: 2.0dB and with a peak SAR value greater than 0.5 W/Kg
- Probe: EX3DV4 - SN3847; ConvF(9.24, 9.24, 9.24); Calibrated: 3/21/2012
- Sensor-Surface: 3mm (Mechanical Surface Detection)
- Electronics: DAE4 Sn779; Calibrated: 1/23/2012
- Phantom: SAM 12; Type: SAM v4.0; Serial: TP:1009
- Measurement SW: DASY5, V5.0 Build 125; SEMCAD X Version 13.4 Build 125

Flat/Area Scan (71x101x1):

Measurement grid: dx=15mm, dy=15mm

Maximum value of SAR (interpolated) = 0.471 mW/g

Flat/Zoom Scan (7x7x9)/Cube 0:

Measurement grid: dx=5mm, dy=5mm, dz=3mm

Reference Value = 25.7 V/m; Power Drift = -0.00232 dB

Peak SAR (extrapolated) = 0.524 W/kg

SAR(1 g) = 0.425 mW/g; SAR(10 g) = 0.325 mW/g

Maximum value of SAR (measured) = 0.463 mW/g

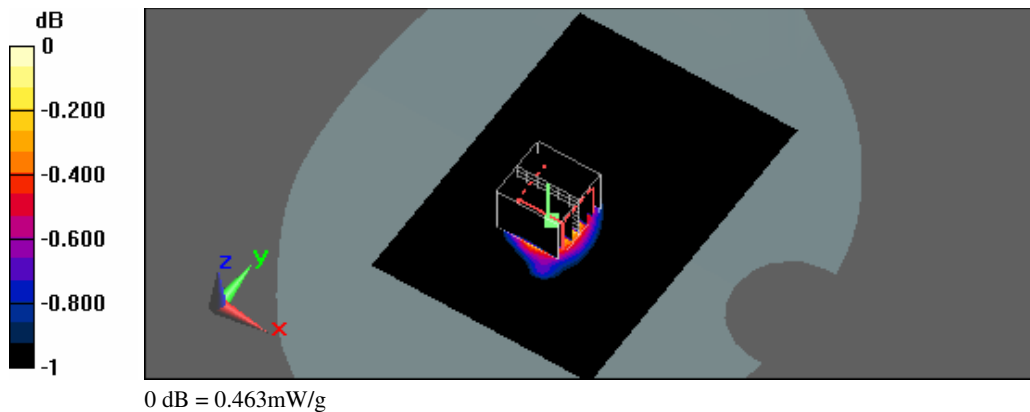

Test Laboratory: A Test Lab Techno Corp.
Date/Time: 6/29/2012 4:26:52 AM

Flat_GPRS 850 CH128_2D3U_Edge Bottom to phantom 10mm

DUT: PM66100; Type: Smartphone; FCC ID: NM8PM66100

Communication System: GPRS 850 (2Down, 3Up); Frequency: 824.2 MHz; Duty Cycle: 1:2.67

Medium parameters used (interpolated): $f = 824.2$ MHz; $\sigma = 0.98$ mho/m; $\epsilon_r = 55.1$; $\rho = 1000$ kg/m³

Phantom section: Flat Section

Measurement Standard: DASYS (IEEE/IEC)

DASY5 Configuration:

- Area Scan setting - Find Secondary Maximum Within: 2.0dB and with a peak SAR value greater than 0.5 W/Kg
- Probe: EX3DV4 - SN3847; ConvF(9.24, 9.24, 9.24); Calibrated: 3/21/2012
- Sensor-Surface: 3mm (Mechanical Surface Detection)
- Electronics: DAE4 Sn779; Calibrated: 1/23/2012
- Phantom: SAM 12; Type: SAM v4.0; Serial: TP:1009
- Measurement SW: DASY5, V5.0 Build 125; SEMCAD X Version 13.4 Build 125

Flat/Area Scan (41x71x1):

Measurement grid: dx=15mm, dy=15mm
Maximum value of SAR (interpolated) = 0.032 mW/g

Flat/Zoom Scan (7x7x9)/Cube 0:

Measurement grid: dx=5mm, dy=5mm, dz=3mm
Reference Value = 11.8 V/m; Power Drift = -0.086 dB
Peak SAR (extrapolated) = 0.048 W/kg
SAR(1 g) = 0.027 mW/g; SAR(10 g) = 0.016 mW/g
Maximum value of SAR (measured) = 0.032 mW/g

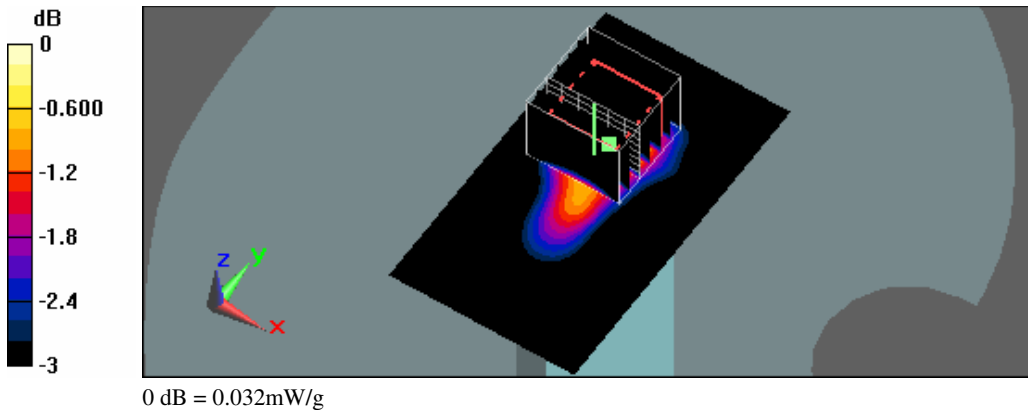

Test Laboratory: A Test Lab Techno Corp.
Date/Time: 6/29/2012 3:34:20 AM

Flat_GPRS 850 CH128_2D3U_Edge Right to phantom 10mm

DUT: PM66100; Type: Smartphone; FCC ID: NM8PM66100

Communication System: GPRS 850 (2Down, 3Up); Frequency: 824.2 MHz; Duty Cycle: 1:2.67

Medium parameters used (interpolated): $f = 824.2$ MHz; $\sigma = 0.98$ mho/m; $\epsilon_r = 55.1$; $\rho = 1000$ kg/m³

Phantom section: Flat Section

Measurement Standard: DASYS (IEEE/IEC)

DASY5 Configuration:

- Area Scan setting - Find Secondary Maximum Within: 2.0dB and with a peak SAR value greater than 0.5 W/Kg
- Probe: EX3DV4 - SN3847; ConvF(9.24, 9.24, 9.24); Calibrated: 3/21/2012
- Sensor-Surface: 3mm (Mechanical Surface Detection)
- Electronics: DAE4 Sn779; Calibrated: 1/23/2012
- Phantom: SAM 12; Type: SAM v4.0; Serial: TP:1009
- Measurement SW: DASY5, V5.0 Build 125; SEMCAD X Version 13.4 Build 125

Flat/Area Scan (41x101x1):

Measurement grid: dx=15mm, dy=15mm
Maximum value of SAR (interpolated) = 0.277 mW/g

Flat/Zoom Scan (7x7x9)/Cube 0:

Measurement grid: dx=5mm, dy=5mm, dz=3mm
Reference Value = 26.3 V/m; Power Drift = 0.010 dB
Peak SAR (extrapolated) = 0.386 W/kg
SAR(1 g) = 0.247 mW/g; SAR(10 g) = 0.165 mW/g
Maximum value of SAR (measured) = 0.296 mW/g

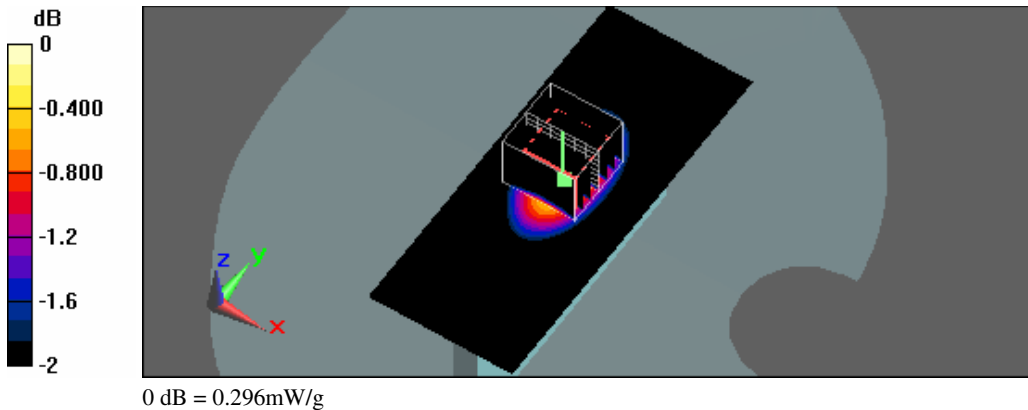

Test Laboratory: A Test Lab Techno Corp.
Date/Time: 6/29/2012 4:01:38 AM

Flat_GPRS 850 CH128_2D3U_Edge Left to phantom 10mm

DUT: PM66100; Type: Smartphone; FCC ID: NM8PM66100

Communication System: GPRS 850 (2Down, 3Up); Frequency: 824.2 MHz; Duty Cycle: 1:2.67

Medium parameters used (interpolated): $f = 824.2$ MHz; $\sigma = 0.98$ mho/m; $\epsilon_r = 55.1$; $\rho = 1000$ kg/m³

Phantom section: Flat Section

Measurement Standard: DASYS (IEEE/IEC)

DASY5 Configuration:

- Area Scan setting - Find Secondary Maximum Within: 2.0dB and with a peak SAR value greater than 0.5 W/Kg
- Probe: EX3DV4 - SN3847; ConvF(9.24, 9.24, 9.24); Calibrated: 3/21/2012
- Sensor-Surface: 3mm (Mechanical Surface Detection)
- Electronics: DAE4 Sn779; Calibrated: 1/23/2012
- Phantom: SAM 12; Type: SAM v4.0; Serial: TP:1009
- Measurement SW: DASY5, V5.0 Build 125; SEMCAD X Version 13.4 Build 125

Flat/Area Scan (41x101x1):

Measurement grid: dx=15mm, dy=15mm

Maximum value of SAR (interpolated) = 0.273 mW/g

Flat/Zoom Scan (7x7x9)/Cube 0:

Measurement grid: dx=5mm, dy=5mm, dz=3mm

Reference Value = 16 V/m; Power Drift = 0.039 dB

Peak SAR (extrapolated) = 0.346 W/kg

SAR(1 g) = 0.231 mW/g; SAR(10 g) = 0.152 mW/g

Maximum value of SAR (measured) = 0.269 mW/g

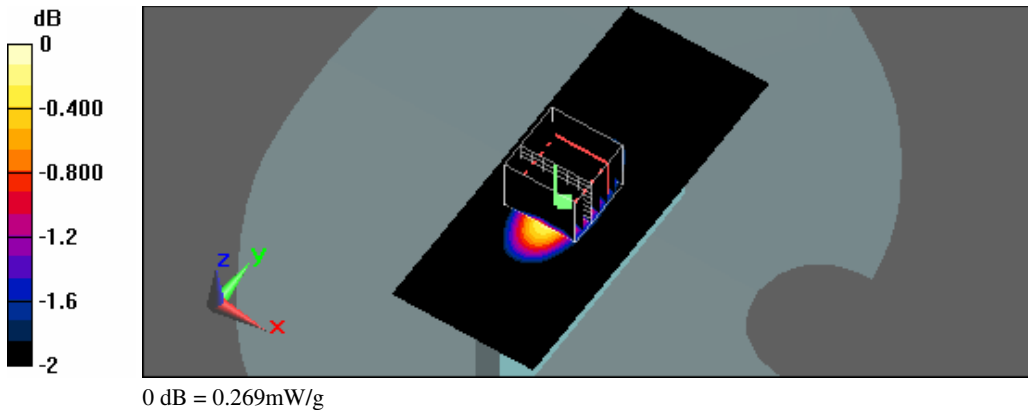

Test Laboratory: A Test Lab Techno Corp.
Date/Time: 6/28/2012 10:08:00 PM

Flat_DTM 850 CH128_2D3U_Front Surface to Phantom_10mm_Headset

DUT: PM66100; Type: Smartphone; FCC ID: NM8PM66100

Communication System: DTM 850 (2Down, 3Up); Frequency: 824.2 MHz; Duty Cycle: 1:2.8
Medium parameters used (interpolated): $f = 824.2$ MHz; $\sigma = 0.98$ mho/m; $\epsilon_r = 55.1$; $\rho = 1000$ kg/m³

Phantom section: Flat Section
Measurement Standard: DASYS (IEEE/IEC)

DASY5 Configuration:

- Area Scan setting - Find Secondary Maximum Within:2.0dB and with a peak SAR value greater than 0.5 W/Kg
- Probe: EX3DV4 - SN3847; ConvF(9.24, 9.24, 9.24); Calibrated: 3/21/2012
- Sensor-Surface: 3mm (Mechanical Surface Detection)
- Electronics: DAE4 Sn779; Calibrated: 1/23/2012
- Phantom: SAM 12; Type: SAM v4.0; Serial: TP:1009
- Measurement SW: DASY5, V5.0 Build 125; SEMCAD X Version 13.4 Build 125

Flat/Area Scan (71x101x1):

Measurement grid: dx=15mm, dy=15mm
Maximum value of SAR (interpolated) = 0.396 mW/g

Flat/Zoom Scan (7x7x9)/Cube 0:

Measurement grid: dx=5mm, dy=5mm, dz=3mm
Reference Value = 18.4 V/m; Power Drift = -0.149 dB
Peak SAR (extrapolated) = 0.455 W/kg
SAR(1 g) = 0.350 mW/g; SAR(10 g) = 0.274 mW/g
Maximum value of SAR (measured) = 0.391 mW/g

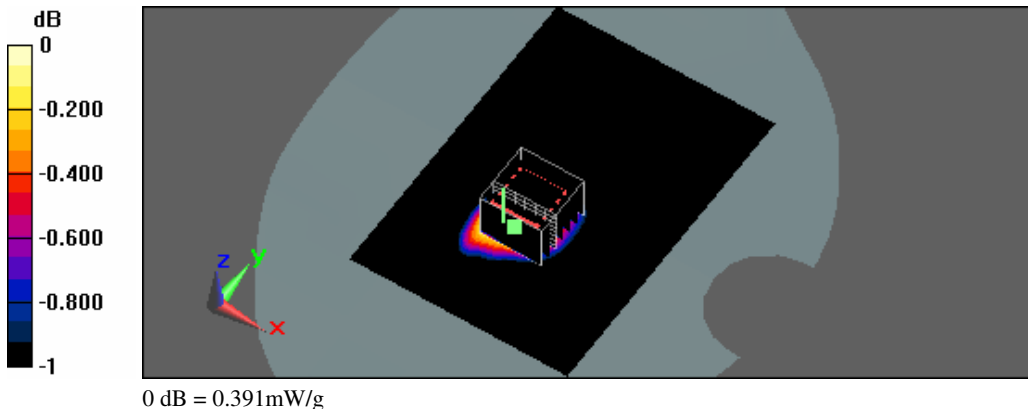

Test Laboratory: A Test Lab Techno Corp.
Date/Time: 6/28/2012 11:01:11 PM

Flat_DTM 850 CH128_2D3U_Back Surface to Phantom_10mm_Headset

DUT: PM66100; Type: Smartphone; FCC ID: NM8PM66100

Communication System: DTM 850 (2Down, 3Up); Frequency: 824.2 MHz; Duty Cycle: 1:2.8
Medium parameters used (interpolated): $f = 824.2$ MHz; $\sigma = 0.98$ mho/m; $\epsilon_r = 55.1$; $\rho = 1000$ kg/m³

Phantom section: Flat Section
Measurement Standard: DASYS (IEEE/IEC)

DASY5 Configuration:

- Area Scan setting - Find Secondary Maximum Within:2.0dB and with a peak SAR value greater than 0.5 W/Kg
- Probe: EX3DV4 - SN3847; ConvF(9.24, 9.24, 9.24); Calibrated: 3/21/2012
- Sensor-Surface: 3mm (Mechanical Surface Detection)
- Electronics: DAE4 Sn779; Calibrated: 1/23/2012
- Phantom: SAM 12; Type: SAM v4.0; Serial: TP:1009
- Measurement SW: DASY5, V5.0 Build 125; SEMCAD X Version 13.4 Build 125

Flat/Area Scan (71x101x1):

Measurement grid: dx=15mm, dy=15mm
Maximum value of SAR (interpolated) = 0.677 mW/g

Flat/Zoom Scan (7x7x9)/Cube 0:

Measurement grid: dx=5mm, dy=5mm, dz=3mm
Reference Value = 30.1 V/m; Power Drift = -0.164 dB
Peak SAR (extrapolated) = 0.739 W/kg
SAR(1 g) = 0.584 mW/g; SAR(10 g) = 0.446 mW/g
Maximum value of SAR (measured) = 0.655 mW/g

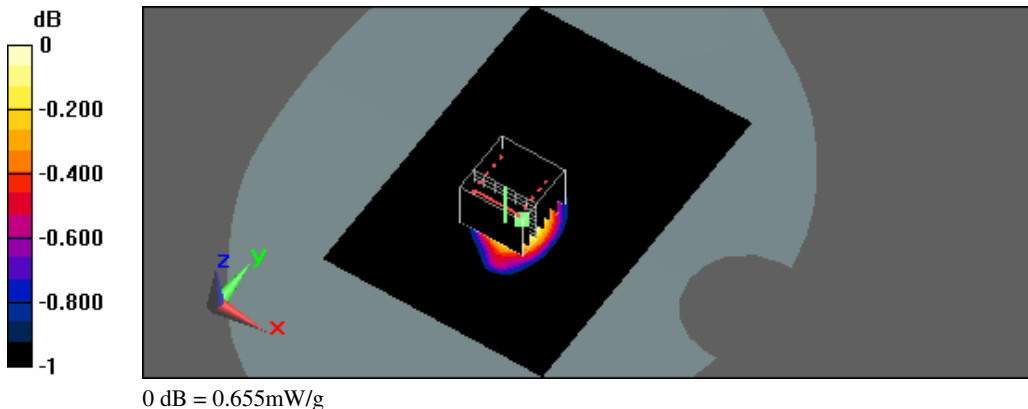



Test Laboratory: A Test Lab Techno Corp.
Date/Time: 6/29/2012 9:54:21 PM

Flat_PCS CH661_Front Surface to Phantom_10mm_Headset

DUT: PM66100; Type: Smartphone; FCC ID: NM8PM66100

Communication System: PCS; Frequency: 1880 MHz; Duty Cycle: 1:8
Medium parameters used: $f = 1880$ MHz; $\sigma = 1.48$ mho/m; $\epsilon_r = 51.2$; $\rho = 1000$ kg/m³
Phantom section: Flat Section
Measurement Standard: DASYS (IEEE/IEC)

DASY5 Configuration:

- Area Scan setting - Find Secondary Maximum Within:2.0dB and with a peak SAR value greater than 0.5 W/Kg
- Probe: EX3DV4 - SN3847; ConvF(7.2, 7.2, 7.2); Calibrated: 3/21/2012
- Sensor-Surface: 3mm (Mechanical Surface Detection)
- Electronics: DAE4 Sn779; Calibrated: 1/23/2012
- Phantom: SAM 12; Type: SAM v4.0; Serial: TP:1009
- Measurement SW: DASYS, V5.0 Build 125; SEMCAD X Version 13.4 Build 125

Flat/Area Scan (71x101x1):

Measurement grid: dx=15mm, dy=15mm
Maximum value of SAR (interpolated) = 0.659 mW/g

Flat/Zoom Scan (7x7x9)/Cube 0:

Measurement grid: dx=5mm, dy=5mm, dz=3mm
Reference Value = 8.8 V/m; Power Drift = 0.098 dB
Peak SAR (extrapolated) = 0.787 W/kg
SAR(1 g) = 0.510 mW/g; SAR(10 g) = 0.303 mW/g
Maximum value of SAR (measured) = 0.619 mW/g

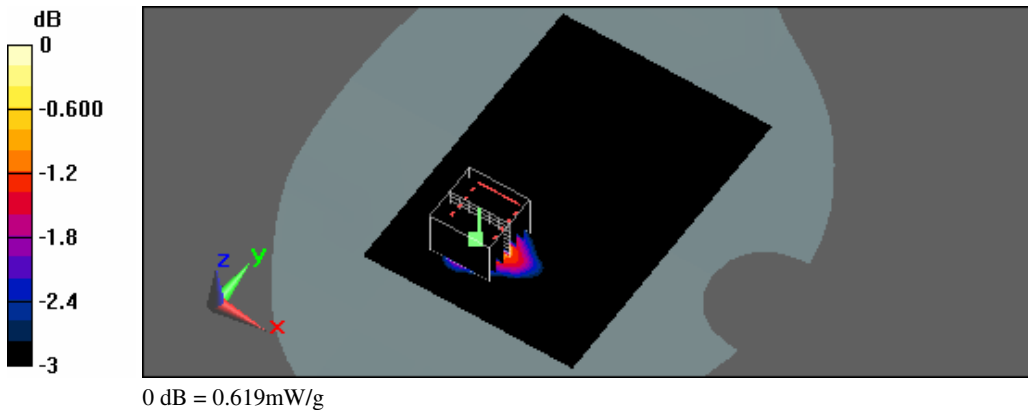



Test Laboratory: A Test Lab Techno Corp.
Date/Time: 6/29/2012 9:18:54 PM

Flat_PCS CH661_Back Surface to Phantom_10mm_Headset

DUT: PM66100; Type: Smartphone; FCC ID: NM8PM66100

Communication System: PCS; Frequency: 1880 MHz; Duty Cycle: 1:8
Medium parameters used: $f = 1880$ MHz; $\sigma = 1.48$ mho/m; $\epsilon_r = 51.2$; $\rho = 1000$ kg/m³
Phantom section: Flat Section
Measurement Standard: DASYS (IEEE/IEC)

DASY5 Configuration:

- Area Scan setting - Find Secondary Maximum Within:2.0dB and with a peak SAR value greater than 0.5 W/Kg
- Probe: EX3DV4 - SN3847; ConvF(7.2, 7.2, 7.2); Calibrated: 3/21/2012
- Sensor-Surface: 3mm (Mechanical Surface Detection)
- Electronics: DAE4 Sn779; Calibrated: 1/23/2012
- Phantom: SAM 12; Type: SAM v4.0; Serial: TP:1009
- Measurement SW: DASYS, V5.0 Build 125; SEMCAD X Version 13.4 Build 125

Flat/Area Scan (71x101x1):

Measurement grid: dx=15mm, dy=15mm
Maximum value of SAR (interpolated) = 0.829 mW/g

Flat/Zoom Scan (7x7x9)/Cube 0:

Measurement grid: dx=5mm, dy=5mm, dz=3mm
Reference Value = 9.87 V/m; Power Drift = 0.030 dB
Peak SAR (extrapolated) = 1.01 W/kg
SAR(1 g) = 0.658 mW/g; SAR(10 g) = 0.402 mW/g
Maximum value of SAR (measured) = 0.776 mW/g

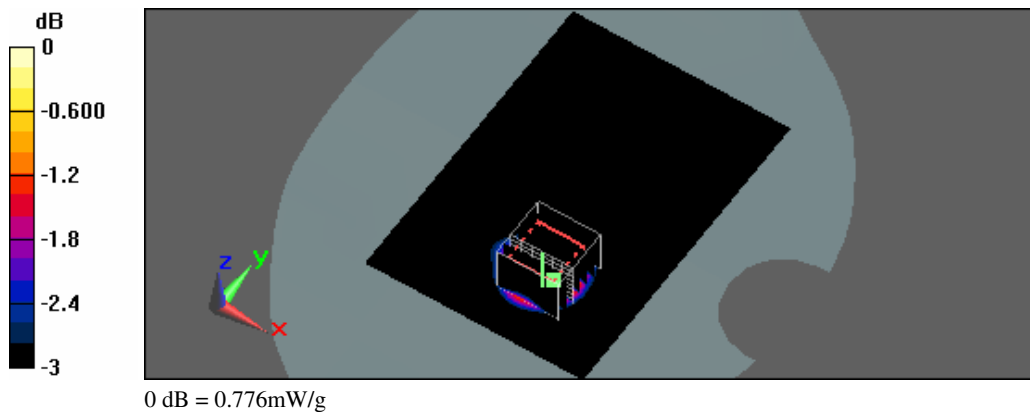

Test Laboratory: A Test Lab Techno Corp.
Date/Time: 6/29/2012 11:39:56 PM

Flat_GPRS PCS CH512_2D3U_Front Surface to Phantom_10mm

DUT: PM66100; Type: Smartphone; FCC ID: NM8PM66100

Communication System: GPRS PCS (2Down,3Up); Frequency: 1850.2 MHz;Duty Cycle: 1:2.67

Medium parameters used (interpolated): $f = 1850.2 \text{ MHz}$; $\sigma = 1.46 \text{ mho/m}$; $\epsilon_r = 51.1$; $\rho = 1000 \text{ kg/m}^3$

Phantom section: Flat Section

Measurement Standard: DASYS (IEEE/IEC)

DASY5 Configuration:

- Area Scan setting - Find Secondary Maximum Within:2.0dB and with a peak SAR value greater than 0.5 W/Kg
- Probe: EX3DV4 - SN3847; ConvF(7.2, 7.2, 7.2); Calibrated: 3/21/2012
- Sensor-Surface: 3mm (Mechanical Surface Detection)
- Electronics: DAE4 Sn779; Calibrated: 1/23/2012
- Phantom: SAM 12; Type: SAM v4.0; Serial: TP:1009
- Measurement SW: DASY5, V5.0 Build 125;SEMCAD X Version 13.4 Build 125

Flat/Area Scan (71x101x1):

Measurement grid: $dx=15\text{mm}$, $dy=15\text{mm}$

Maximum value of SAR (interpolated) = 1.24 mW/g

Flat/Zoom Scan (7x7x9)/Cube 0:

Measurement grid: $dx=5\text{mm}$, $dy=5\text{mm}$, $dz=3\text{mm}$

Reference Value = 13.4 V/m; Power Drift = -0.037 dB

Peak SAR (extrapolated) = 1.72 W/kg

SAR(1 g) = 1.05 mW/g; SAR(10 g) = 0.587 mW/g

Maximum value of SAR (measured) = 1.31 mW/g

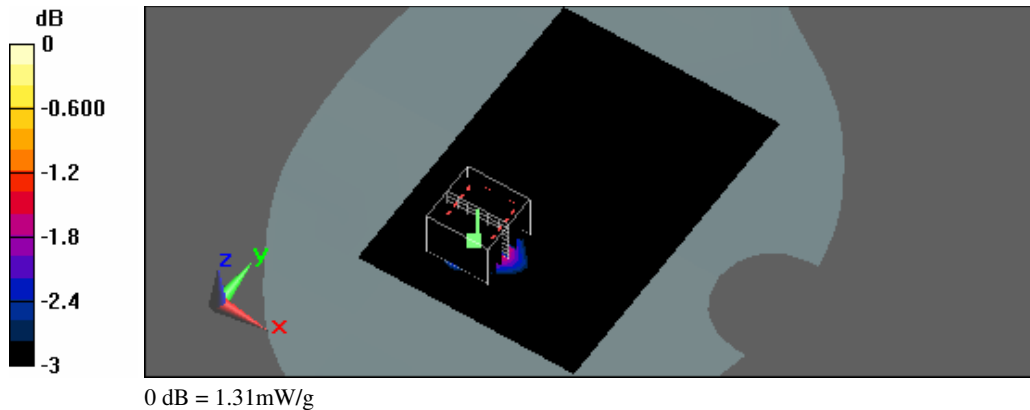

Test Laboratory: A Test Lab Techno Corp.
Date/Time: 6/30/2012 12:39:44 AM

Flat_GPRS PCS CH512_2D3U_Back Surface to Phantom_10mm

DUT: PM66100; Type: Smartphone; FCC ID: NM8PM66100

Communication System: GPRS PCS (2Down,3Up); Frequency: 1850.2 MHz;Duty Cycle: 1:2.67

Medium parameters used (interpolated): $f = 1850.2 \text{ MHz}$; $\sigma = 1.46 \text{ mho/m}$; $\epsilon_r = 51.1$; $\rho = 1000 \text{ kg/m}^3$

Phantom section: Flat Section

Measurement Standard: DASYS (IEEE/IEC)

DASY5 Configuration:

- Area Scan setting - Find Secondary Maximum Within:2.0dB and with a peak SAR value greater than 0.5 W/Kg
- Probe: EX3DV4 - SN3847; ConvF(7.2, 7.2, 7.2); Calibrated: 3/21/2012
- Sensor-Surface: 3mm (Mechanical Surface Detection)
- Electronics: DAE4 Sn779; Calibrated: 1/23/2012
- Phantom: SAM 12; Type: SAM v4.0; Serial: TP:1009
- Measurement SW: DASY5, V5.0 Build 125;SEMCAD X Version 13.4 Build 125

Flat/Area Scan (71x101x1):

Measurement grid: $dx=15\text{mm}$, $dy=15\text{mm}$

Maximum value of SAR (interpolated) = 1.27 mW/g

Flat/Zoom Scan (7x7x9)/Cube 0:

Measurement grid: $dx=5\text{mm}$, $dy=5\text{mm}$, $dz=3\text{mm}$

Reference Value = 9.88 V/m; Power Drift = -0.121 dB

Peak SAR (extrapolated) = 1.59 W/kg

SAR(1 g) = 1.01 mW/g; SAR(10 g) = 0.602 mW/g

Maximum value of SAR (measured) = 1.2 mW/g

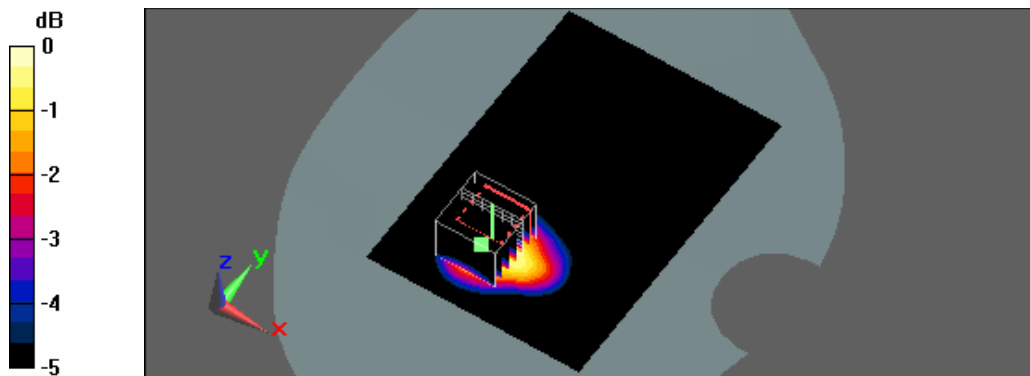

0 dB = 1.2mW/g



Test Laboratory: A Test Lab Techno Corp.
Date/Time: 6/29/2012 10:44:12 PM

Flat_GPRS PCS CH661_2D3U_Front Surface to Phantom_10mm

DUT: PM66100; Type: Smartphone; FCC ID: NM8PM66100

Communication System: GPRS PCS (2Down,3Up); Frequency: 1880 MHz;Duty Cycle: 1:2.67

Medium parameters used: $f = 1880$ MHz; $\sigma = 1.48$ mho/m; $\epsilon_r = 51.2$; $\rho = 1000$ kg/m³

Phantom section: Flat Section

Measurement Standard: DASYS (IEEE/IEC)

DASY5 Configuration:

- Area Scan setting - Find Secondary Maximum Within:2.0dB and with a peak SAR value greater than 0.5 W/Kg
- Probe: EX3DV4 - SN3847; ConvF(7.2, 7.2, 7.2); Calibrated: 3/21/2012
- Sensor-Surface: 3mm (Mechanical Surface Detection)
- Electronics: DAE4 Sn779; Calibrated: 1/23/2012
- Phantom: SAM 12; Type: SAM v4.0; Serial: TP:1009
- Measurement SW: DASY5, V5.0 Build 125;SEMCAD X Version 13.4 Build 125

Flat/Area Scan (71x101x1):

Measurement grid: dx=15mm, dy=15mm

Maximum value of SAR (interpolated) = 1.17 mW/g

Flat/Zoom Scan (7x7x9)/Cube 0:

Measurement grid: dx=5mm, dy=5mm, dz=3mm

Reference Value = 12.4 V/m; Power Drift = -0.075 dB

Peak SAR (extrapolated) = 1.44 W/kg

SAR(1 g) = 0.905 mW/g; SAR(10 g) = 0.544 mW/g

Maximum value of SAR (measured) = 1.11 mW/g

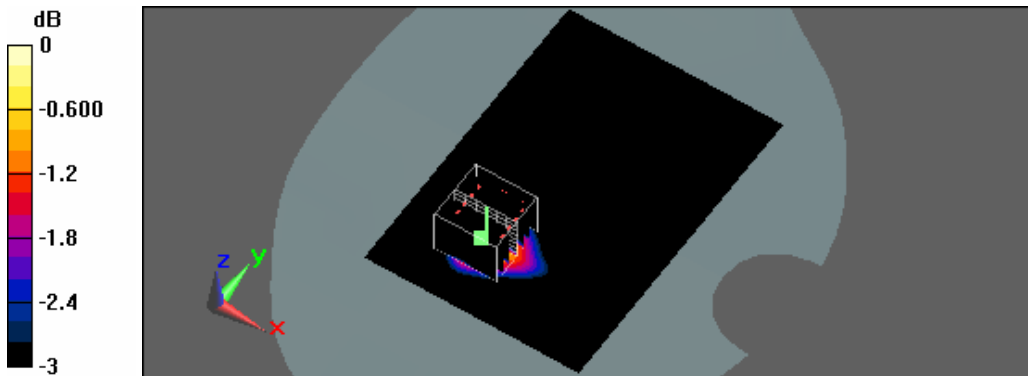

0 dB = 1.11mW/g

Test Laboratory: A Test Lab Techno Corp.
Date/Time: 6/29/2012 7:49:04 PM

Flat_GPRS PCS CH661_2D3U_Back Surface to Phantom_10mm

DUT: PM66100; Type: Smartphone; FCC ID: NM8PM66100

Communication System: GPRS PCS (2Down,3Up); Frequency: 1880 MHz;Duty Cycle: 1:2.67

Medium parameters used: $f = 1880 \text{ MHz}$; $\sigma = 1.48 \text{ mho/m}$; $\epsilon_r = 51.2$; $\rho = 1000 \text{ kg/m}^3$

Phantom section: Flat Section

Measurement Standard: DASYS (IEEE/IEC)

DASY5 Configuration:

- Area Scan setting - Find Secondary Maximum Within:2.0dB and with a peak SAR value greater than 0.5 W/Kg
- Probe: EX3DV4 - SN3847; ConvF(7.2, 7.2, 7.2); Calibrated: 3/21/2012
- Sensor-Surface: 3mm (Mechanical Surface Detection)
- Electronics: DAE4 Sn779; Calibrated: 1/23/2012
- Phantom: SAM 12; Type: SAM v4.0; Serial: TP:1009
- Measurement SW: DASYS, V5.0 Build 125;SEMCAD X Version 13.4 Build 125

Flat/Area Scan (71x101x1):

Measurement grid: dx=15mm, dy=15mm

Maximum value of SAR (interpolated) = 1.58 mW/g

Flat/Zoom Scan (7x7x9)/Cube 0:

Measurement grid: dx=5mm, dy=5mm, dz=3mm

Reference Value = 13.9 V/m; Power Drift = 0.035 dB

Peak SAR (extrapolated) = 1.91 W/kg

SAR(1 g) = 1.23 mW/g; SAR(10 g) = 0.749 mW/g

Maximum value of SAR (measured) = 1.47 mW/g

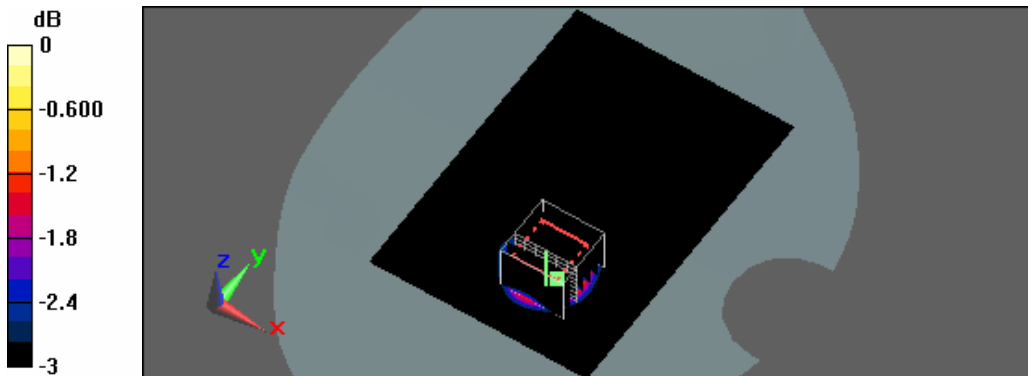

0 dB = 1.47mW/g

Test Laboratory: A Test Lab Techno Corp.
Date/Time: 6/30/2012 3:46:18 AM

Flat_GPRS PCS CH661_2D3U_Edge Bottom to phantom 10mm

DUT: PM66100; Type: Smartphone; FCC ID: NM8PM66100

Communication System: GPRS PCS (2Down,3Up); Frequency: 1880 MHz;Duty Cycle: 1:2.67

Medium parameters used: $f = 1880 \text{ MHz}$; $\sigma = 1.48 \text{ mho/m}$; $\epsilon_r = 51.2$; $\rho = 1000 \text{ kg/m}^3$

Phantom section: Flat Section

Measurement Standard: DASYS (IEEE/IEC)

DASY5 Configuration:

- Area Scan setting - Find Secondary Maximum Within:2.0dB and with a peak SAR value greater than 0.5 W/Kg
- Probe: EX3DV4 - SN3847; ConvF(7.2, 7.2, 7.2); Calibrated: 3/21/2012
- Sensor-Surface: 3mm (Mechanical Surface Detection)
- Electronics: DAE4 Sn779; Calibrated: 1/23/2012
- Phantom: SAM 12; Type: SAM v4.0; Serial: TP:1009
- Measurement SW: DASY5, V5.0 Build 125;SEMCAD X Version 13.4 Build 125

Flat/Area Scan (71x71x1):

Measurement grid: $dx=15\text{mm}$, $dy=15\text{mm}$

Maximum value of SAR (interpolated) = 0.537 mW/g

Flat/Zoom Scan (7x7x9)/Cube 0:

Measurement grid: $dx=5\text{mm}$, $dy=5\text{mm}$, $dz=3\text{mm}$

Reference Value = 16.9 V/m; Power Drift = 0.020 dB

Peak SAR (extrapolated) = 0.767 W/kg

SAR(1 g) = 0.467 mW/g; SAR(10 g) = 0.263 mW/g

Maximum value of SAR (measured) = 0.563 mW/g

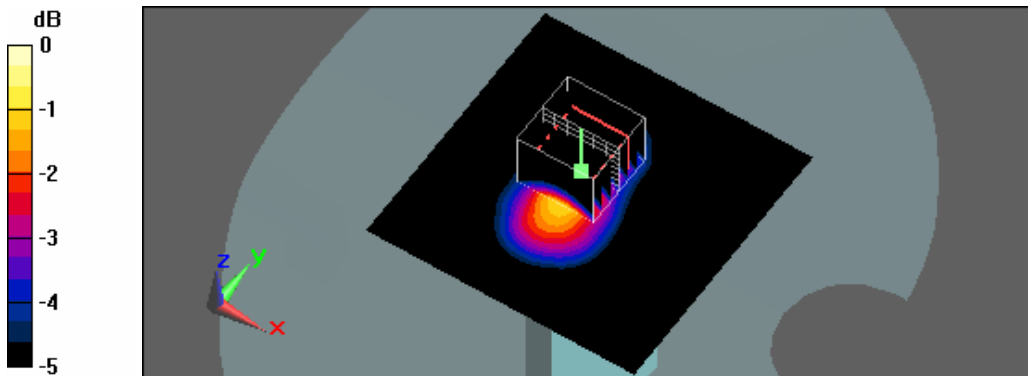

0 dB = 0.563mW/g



Test Laboratory: A Test Lab Techno Corp.
Date/Time: 6/30/2012 1:35:31 AM

Flat_GPRS PCS CH661_2D3U_Edge Right to phantom 10mm

DUT: PM66100; Type: Smartphone; FCC ID: NM8PM66100

Communication System: GPRS PCS (2Down,3Up); Frequency: 1880 MHz;Duty Cycle: 1:2.67

Medium parameters used: $f = 1880$ MHz; $\sigma = 1.48$ mho/m; $\epsilon_r = 51.2$; $\rho = 1000$ kg/m³

Phantom section: Flat Section

Measurement Standard: DASYS (IEEE/IEC)

DASY5 Configuration:

- Area Scan setting - Find Secondary Maximum Within:2.0dB and with a peak SAR value greater than 0.5 W/Kg
- Probe: EX3DV4 - SN3847; ConvF(7.2, 7.2, 7.2); Calibrated: 3/21/2012
- Sensor-Surface: 3mm (Mechanical Surface Detection)
- Electronics: DAE4 Sn779; Calibrated: 1/23/2012
- Phantom: SAM 12; Type: SAM v4.0; Serial: TP:1009
- Measurement SW: DASY5, V5.0 Build 125;SEMCAD X Version 13.4 Build 125

Flat/Area Scan (71x101x1):

Measurement grid: dx=15mm, dy=15mm

Maximum value of SAR (interpolated) = 0.473 mW/g

Flat/Zoom Scan (7x7x9)/Cube 0:

Measurement grid: dx=5mm, dy=5mm, dz=3mm

Reference Value = 12.2 V/m; Power Drift = -0.042 dB

Peak SAR (extrapolated) = 0.593 W/kg

SAR(1 g) = 0.362 mW/g; SAR(10 g) = 0.210 mW/g

Maximum value of SAR (measured) = 0.446 mW/g

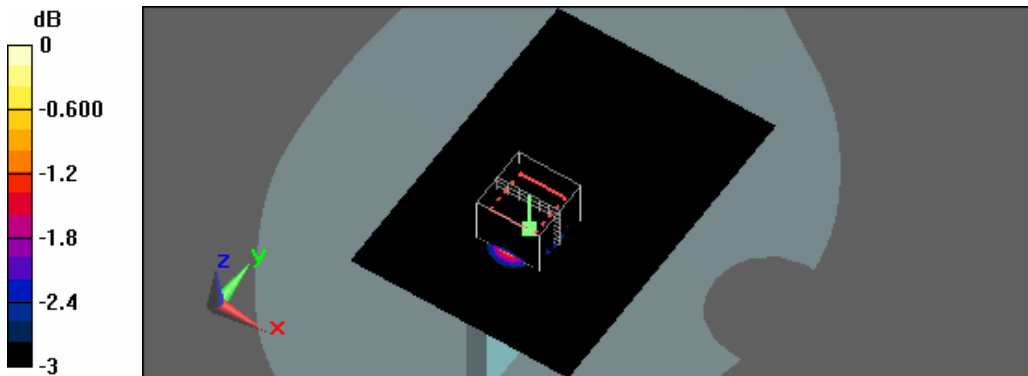

0 dB = 0.446mW/g

Test Laboratory: A Test Lab Techno Corp.
Date/Time: 6/30/2012 2:18:57 AM

Flat_GPRS PCS CH661_2D3U_Edge Left to phantom 10mm

DUT: PM66100; Type: Smartphone; FCC ID: NM8PM66100

Communication System: GPRS PCS (2Down,3Up); Frequency: 1880 MHz;Duty Cycle: 1:2.67

Medium parameters used: $f = 1880 \text{ MHz}$; $\sigma = 1.48 \text{ mho/m}$; $\epsilon_r = 51.2$; $\rho = 1000 \text{ kg/m}^3$

Phantom section: Flat Section

Measurement Standard: DASYS (IEEE/IEC)

DASY5 Configuration:

- Area Scan setting - Find Secondary Maximum Within:2.0dB and with a peak SAR value greater than 0.5 W/Kg
- Probe: EX3DV4 - SN3847; ConvF(7.2, 7.2, 7.2); Calibrated: 3/21/2012
- Sensor-Surface: 3mm (Mechanical Surface Detection)
- Electronics: DAE4 Sn779; Calibrated: 1/23/2012
- Phantom: SAM 12; Type: SAM v4.0; Serial: TP:1009
- Measurement SW: DASY5, V5.0 Build 125;SEMCAD X Version 13.4 Build 125

Flat/Area Scan (71x101x1):

Measurement grid: $dx=15\text{mm}$, $dy=15\text{mm}$

Maximum value of SAR (interpolated) = 0.361 mW/g

Flat/Zoom Scan (7x7x9)/Cube 0:

Measurement grid: $dx=5\text{mm}$, $dy=5\text{mm}$, $dz=3\text{mm}$

Reference Value = 8.27 V/m; Power Drift = 0.00657 dB

Peak SAR (extrapolated) = 0.812 W/kg

SAR(1 g) = 0.291 mW/g; SAR(10 g) = 0.170 mW/g

Maximum value of SAR (measured) = 0.354 mW/g

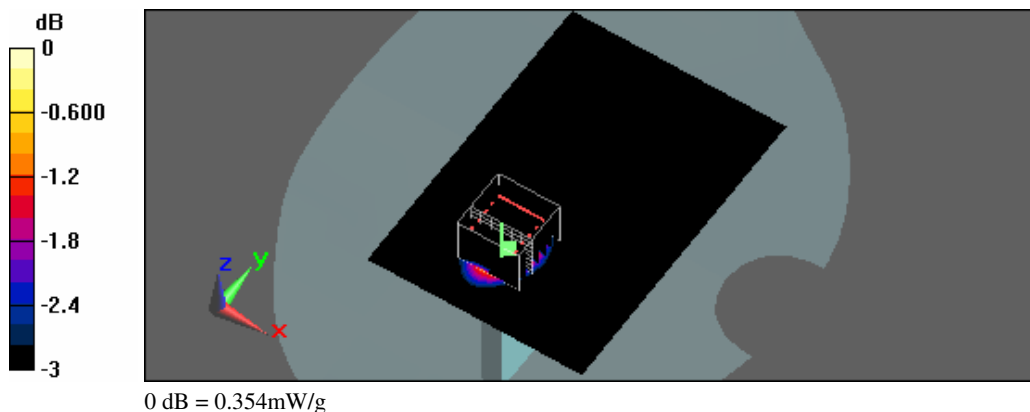

Test Laboratory: A Test Lab Techno Corp.
Date/Time: 6/30/2012 12:09:47 AM

Flat_GPRS PCS CH810_2D3U_Front Surface to Phantom_10mm

DUT: PM66100; Type: Smartphone; FCC ID: NM8PM66100

Communication System: GPRS PCS (2Down,3Up); Frequency: 1909.8 MHz;Duty Cycle: 1:2.67

Medium parameters used: $f = 1910 \text{ MHz}$; $\sigma = 1.5 \text{ mho/m}$; $\epsilon_r = 51$; $\rho = 1000 \text{ kg/m}^3$

Phantom section: Flat Section

Measurement Standard: DASYS (IEEE/IEC)

DASY5 Configuration:

- Area Scan setting - Find Secondary Maximum Within:2.0dB and with a peak SAR value greater than 0.5 W/Kg
- Probe: EX3DV4 - SN3847; ConvF(7.2, 7.2, 7.2); Calibrated: 3/21/2012
- Sensor-Surface: 3mm (Mechanical Surface Detection)
- Electronics: DAE4 Sn779; Calibrated: 1/23/2012
- Phantom: SAM 12; Type: SAM v4.0; Serial: TP:1009
- Measurement SW: DASY5, V5.0 Build 125;SEMCAD X Version 13.4 Build 125

Flat/Area Scan (71x101x1):

Measurement grid: $dx=15\text{mm}$, $dy=15\text{mm}$

Maximum value of SAR (interpolated) = 1.32 mW/g

Flat/Zoom Scan (7x7x9)/Cube 0:

Measurement grid: $dx=5\text{mm}$, $dy=5\text{mm}$, $dz=3\text{mm}$

Reference Value = 9.58 V/m; Power Drift = -0.121 dB

Peak SAR (extrapolated) = 1.4 W/kg

SAR(1 g) = 0.886 mW/g; SAR(10 g) = 0.514 mW/g

Maximum value of SAR (measured) = 1.09 mW/g

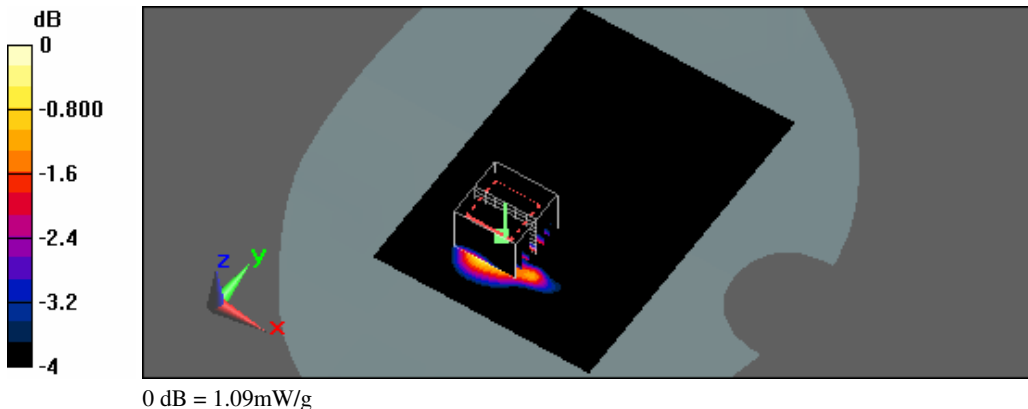

Test Laboratory: A Test Lab Techno Corp.
Date/Time: 6/29/2012 8:42:14 PM

Flat_GPRS PCS CH810_2D3U_Back Surface to Phantom_10mm

DUT: PM66100; Type: Smartphone; FCC ID: NM8PM66100

Communication System: GPRS PCS (2Down,3Up); Frequency: 1909.8 MHz;Duty Cycle: 1:2.67

Medium parameters used: $f = 1910$ MHz; $\sigma = 1.5$ mho/m; $\epsilon_r = 51$; $\rho = 1000$ kg/m³

Phantom section: Flat Section

Measurement Standard: DASYS (IEEE/IEC)

DASY5 Configuration:

- Area Scan setting - Find Secondary Maximum Within:2.0dB and with a peak SAR value greater than 0.5 W/Kg
- Probe: EX3DV4 - SN3847; ConvF(7.2, 7.2, 7.2); Calibrated: 3/21/2012
- Sensor-Surface: 3mm (Mechanical Surface Detection)
- Electronics: DAE4 Sn779; Calibrated: 1/23/2012
- Phantom: SAM 12; Type: SAM v4.0; Serial: TP:1009
- Measurement SW: DASY5, V5.0 Build 125;SEMCAD X Version 13.4 Build 125

Flat/Area Scan (71x101x1):

Measurement grid: dx=15mm, dy=15mm

Maximum value of SAR (interpolated) = 1.27 mW/g

Flat/Zoom Scan (7x7x9)/Cube 0:

Measurement grid: dx=5mm, dy=5mm, dz=3mm

Reference Value = 12.1 V/m; Power Drift = -0.000288 dB

Peak SAR (extrapolated) = 1.6 W/kg

SAR(1 g) = 1 mW/g; SAR(10 g) = 0.603 mW/g

Maximum value of SAR (measured) = 1.21 mW/g

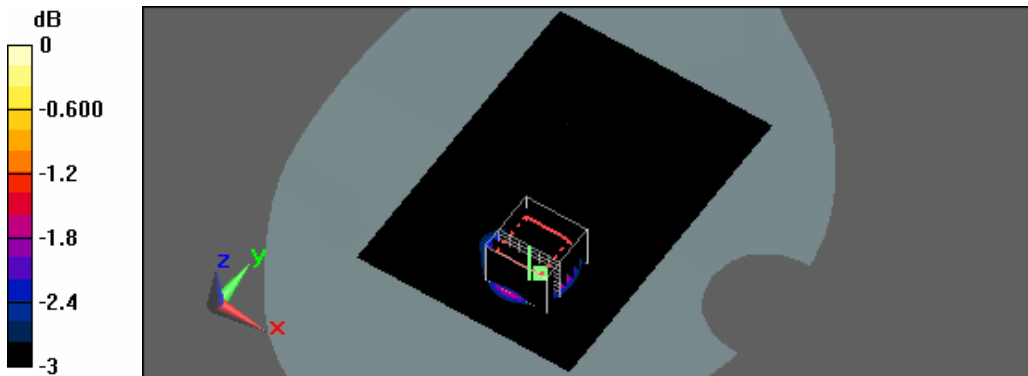

0 dB = 1.21mW/g

Test Laboratory: A Test Lab Techno Corp.
Date/Time: 6/30/2012 3:22:36 PM

Flat_DTM PCS CH512_2D3U_Front Surface to Phantom_10mm_Headset

DUT: PM66100; Type: Smartphone; FCC ID: NM8PM66100

Communication System: DTM PCS (2Down,3Up); Frequency: 1850.2 MHz;Duty Cycle: 1:2.8

Medium parameters used (interpolated): $f = 1850.2 \text{ MHz}$; $\sigma = 1.46 \text{ mho/m}$; $\epsilon_r = 51.1$; $\rho = 1000 \text{ kg/m}^3$

Phantom section: Flat Section

Measurement Standard: DASYS (IEEE/IEC)

DASY5 Configuration:

- Area Scan setting - Find Secondary Maximum Within:2.0dB and with a peak SAR value greater than 0.5 W/Kg
- Probe: EX3DV4 - SN3847; ConvF(7.2, 7.2, 7.2); Calibrated: 3/21/2012
- Sensor-Surface: 3mm (Mechanical Surface Detection)
- Electronics: DAE4 Sn779; Calibrated: 1/23/2012
- Phantom: SAM 12; Type: SAM v4.0; Serial: TP:1009
- Measurement SW: DASY5, V5.0 Build 125;SEMCAD X Version 13.4 Build 125

Flat/Area Scan (71x101x1):

Measurement grid: $dx=15\text{mm}$, $dy=15\text{mm}$

Maximum value of SAR (interpolated) = 1 mW/g

Flat/Zoom Scan (7x7x9)/Cube 0:

Measurement grid: $dx=5\text{mm}$, $dy=5\text{mm}$, $dz=3\text{mm}$

Reference Value = 13 V/m; Power Drift = -0.088 dB

Peak SAR (extrapolated) = 1.24 W/kg

SAR(1 g) = 0.807 mW/g; SAR(10 g) = 0.490 mW/g

Maximum value of SAR (measured) = 0.969 mW/g

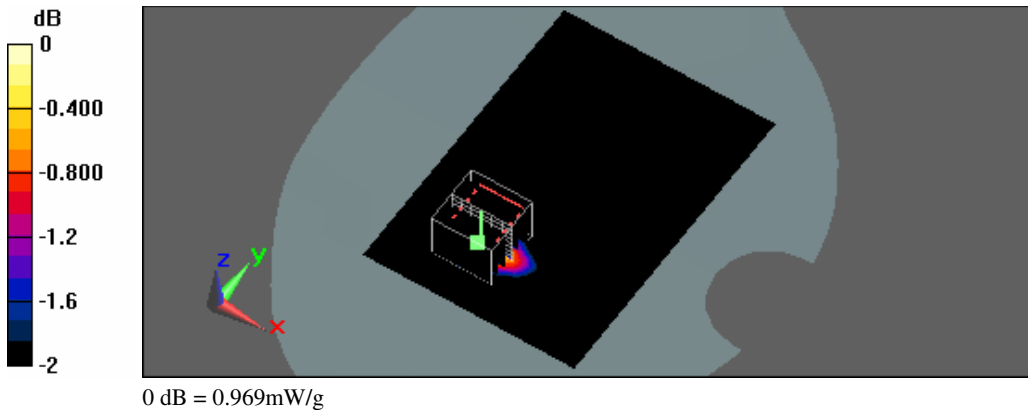

Test Laboratory: A Test Lab Techno Corp.
Date/Time: 7/1/2012 9:44:46 PM

Flat_DTM PCS CH512_2D3U_Back Surface to Phantom_10mm_Headset

DUT: PM66100; Type: Smartphone; FCC ID: NM8PM66100

Communication System: DTM PCS (2Down,3Up); Frequency: 1850.2 MHz;Duty Cycle: 1:2.8

Medium parameters used (interpolated): $f = 1850.2 \text{ MHz}$; $\sigma = 1.46 \text{ mho/m}$; $\epsilon_r = 51.1$; $\rho = 1000 \text{ kg/m}^3$

Phantom section: Flat Section

Measurement Standard: DASYS (IEEE/IEC)

DASY5 Configuration:

- Area Scan setting - Find Secondary Maximum Within:2.0dB and with a peak SAR value greater than 0.5 W/Kg
- Probe: EX3DV4 - SN3847; ConvF(7.2, 7.2, 7.2); Calibrated: 3/21/2012
- Sensor-Surface: 3mm (Mechanical Surface Detection)
- Electronics: DAE4 Sn779; Calibrated: 1/23/2012
- Phantom: SAM 12; Type: SAM v4.0; Serial: TP:1009
- Measurement SW: DASY5, V5.0 Build 125;SEMCAD X Version 13.4 Build 125

Flat/Area Scan (71x101x1):

Measurement grid: $dx=15\text{mm}$, $dy=15\text{mm}$

Maximum value of SAR (interpolated) = 1.76 mW/g

Flat/Zoom Scan (7x7x9)/Cube 0:

Measurement grid: $dx=5\text{mm}$, $dy=5\text{mm}$, $dz=3\text{mm}$

Reference Value = 14.9 V/m; Power Drift = 0.026 dB

Peak SAR (extrapolated) = 2.06 W/kg

SAR(1 g) = 1.34 mW/g; SAR(10 g) = 0.823 mW/g

Maximum value of SAR (measured) = 1.59 mW/g

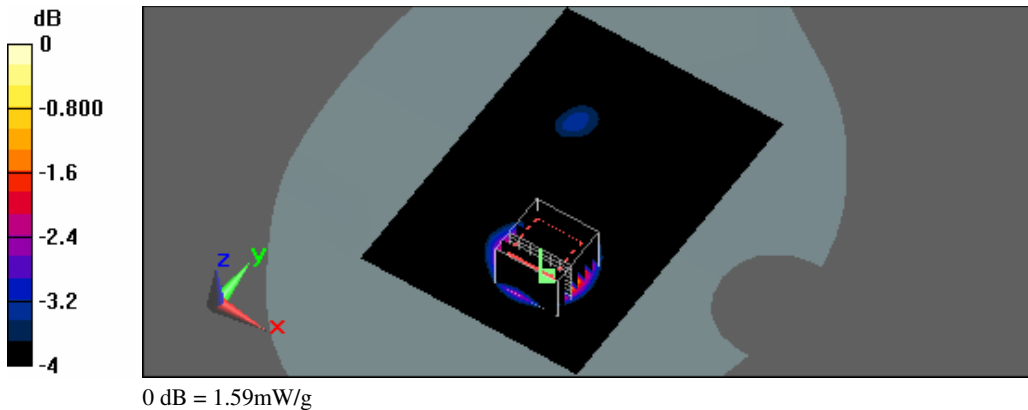



Test Laboratory: A Test Lab Techno Corp.
Date/Time: 6/30/2012 1:22:04 PM

Flat_DTM PCS CH661_2D3U_Front Surface to Phantom_10mm_Headset

DUT: PM66100; Type: Smartphone; FCC ID: NM8PM66100

Communication System: DTM PCS (2Down,3Up); Frequency: 1880 MHz;Duty Cycle: 1:2.8
Medium parameters used: $f = 1880$ MHz; $\sigma = 1.48$ mho/m; $\epsilon_r = 51.2$; $\rho = 1000$ kg/m³
Phantom section: Flat Section
Measurement Standard: DASYS (IEEE/IEC)

DASY5 Configuration:

- Area Scan setting - Find Secondary Maximum Within:2.0dB and with a peak SAR value greater than 0.5 W/Kg
- Probe: EX3DV4 - SN3847; ConvF(7.2, 7.2, 7.2); Calibrated: 3/21/2012
- Sensor-Surface: 3mm (Mechanical Surface Detection)
- Electronics: DAE4 Sn779; Calibrated: 1/23/2012
- Phantom: SAM 12; Type: SAM v4.0; Serial: TP:1009
- Measurement SW: DASYS, V5.0 Build 125;SEMCAD X Version 13.4 Build 125

Flat/Area Scan (71x101x1):

Measurement grid: dx=15mm, dy=15mm
Maximum value of SAR (interpolated) = 1.22 mW/g

Flat/Zoom Scan (7x7x9)/Cube 0:

Measurement grid: dx=5mm, dy=5mm, dz=3mm
Reference Value = 12.2 V/m; Power Drift = -0.059 dB
Peak SAR (extrapolated) = 1.38 W/kg
SAR(1 g) = 0.922 mW/g; SAR(10 g) = 0.570 mW/g
Maximum value of SAR (measured) = 1.1 mW/g

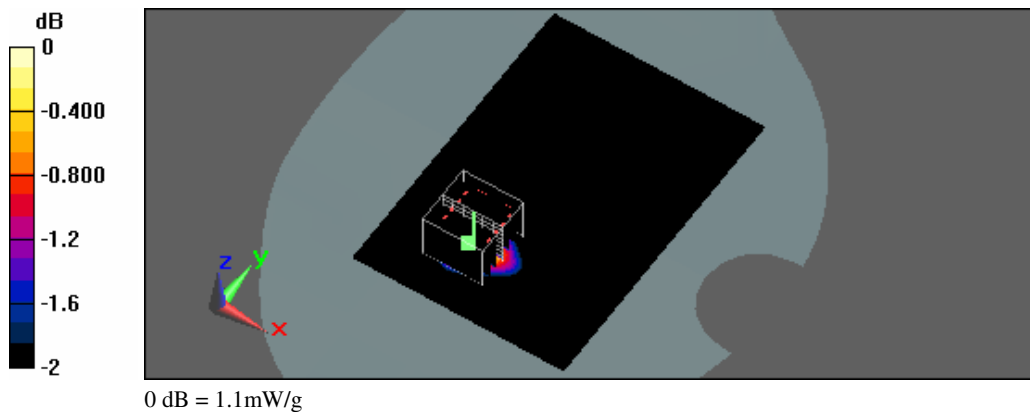

Test Laboratory: A Test Lab Techno Corp.
Date/Time: 7/1/2012 9:14:51 PM

Flat_DTM PCS CH661_2D3U_Back Surface to Phantom_10mm_Headset

DUT: PM66100; Type: Smartphone; FCC ID: NM8PM66100

Communication System: DTM PCS (2Down,3Up); Frequency: 1880 MHz;Duty Cycle: 1:2.8
Medium parameters used: $f = 1880 \text{ MHz}$; $\sigma = 1.48 \text{ mho/m}$; $\epsilon_r = 51.2$; $\rho = 1000 \text{ kg/m}^3$
Phantom section: Flat Section
Measurement Standard: DASYS (IEEE/IEC)

DASY5 Configuration:

- Area Scan setting - Find Secondary Maximum Within:2.0dB and with a peak SAR value greater than 0.5 W/Kg
- Probe: EX3DV4 - SN3847; ConvF(7.2, 7.2, 7.2); Calibrated: 3/21/2012
- Sensor-Surface: 3mm (Mechanical Surface Detection)
- Electronics: DAE4 Sn779; Calibrated: 1/23/2012
- Phantom: SAM 12; Type: SAM v4.0; Serial: TP:1009
- Measurement SW: DASYS, V5.0 Build 125;SEMCAD X Version 13.4 Build 125

Flat/Area Scan (71x101x1):

Measurement grid: $dx=15\text{mm}$, $dy=15\text{mm}$
Maximum value of SAR (interpolated) = 1.77 mW/g

Flat/Zoom Scan (7x7x9)/Cube 0:

Measurement grid: $dx=5\text{mm}$, $dy=5\text{mm}$, $dz=3\text{mm}$
Reference Value = 14.4 V/m; Power Drift = 0.107 dB
Peak SAR (extrapolated) = 2.07 W/kg
SAR(1 g) = 1.35 mW/g; SAR(10 g) = 0.818 mW/g
Maximum value of SAR (measured) = 1.61 mW/g

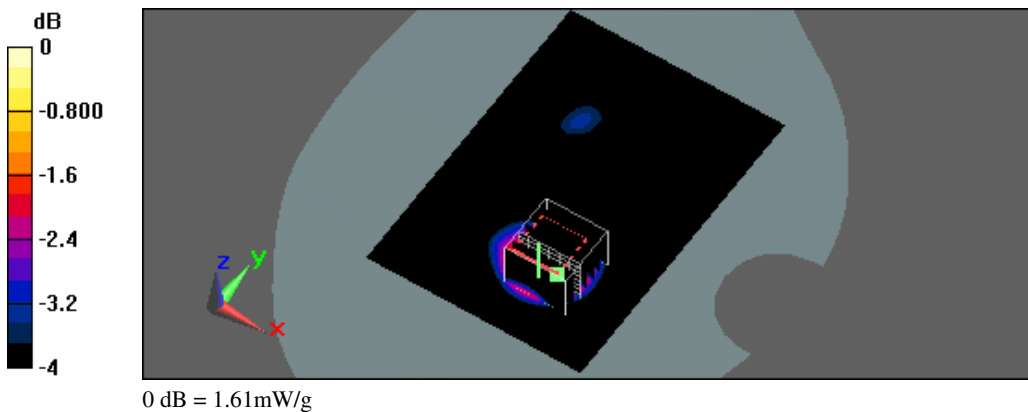

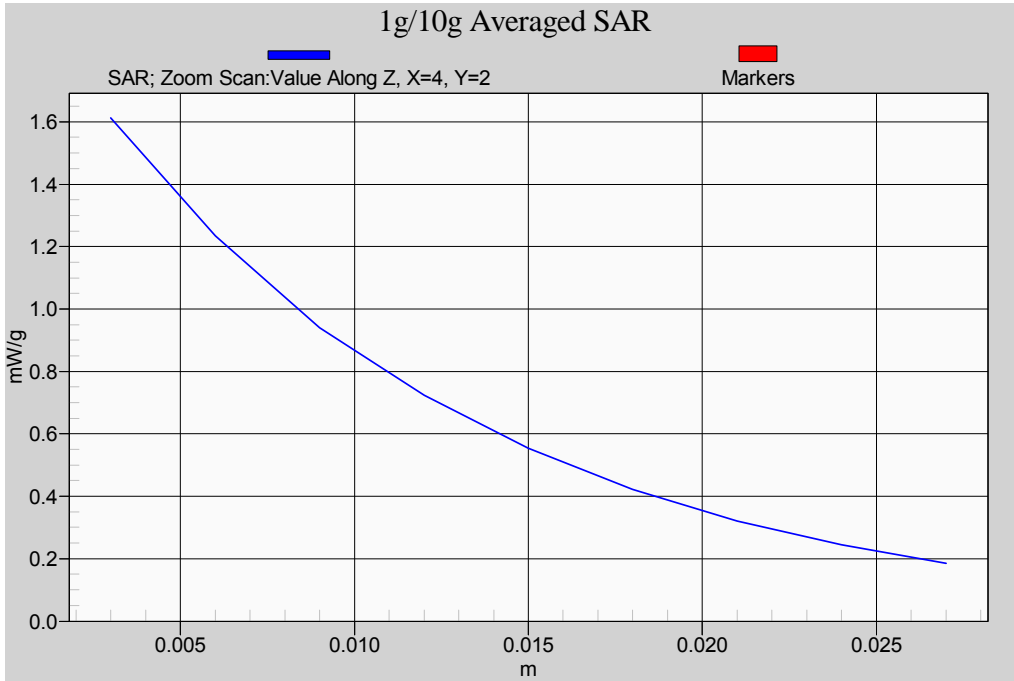



Test Laboratory: A Test Lab Techno Corp.
Date/Time: 6/30/2012 3:59:16 PM

Flat_DTM PCS CH810_2D3U_Front Surface to Phantom_10mm_Headset

DUT: PM66100; Type: Smartphone; FCC ID: NM8PM66100

Communication System: DTM PCS (2Down,3Up); Frequency: 1909.8 MHz;Duty Cycle: 1:2.8

Medium parameters used: $f = 1910$ MHz; $\sigma = 1.5$ mho/m; $\epsilon_r = 51$; $\rho = 1000$ kg/m³

Phantom section: Flat Section

Measurement Standard: DASYS (IEEE/IEC)

DASY5 Configuration:

- Area Scan setting - Find Secondary Maximum Within:2.0dB and with a peak SAR value greater than 0.5 W/Kg
- Probe: EX3DV4 - SN3847; ConvF(7.2, 7.2, 7.2); Calibrated: 3/21/2012
- Sensor-Surface: 3mm (Mechanical Surface Detection)
- Electronics: DAE4 Sn779; Calibrated: 1/23/2012
- Phantom: SAM 12; Type: SAM v4.0; Serial: TP:1009
- Measurement SW: DASYS, V5.0 Build 125;SEMCAD X Version 13.4 Build 125

Flat/Area Scan (71x101x1):

Measurement grid: dx=15mm, dy=15mm

Maximum value of SAR (interpolated) = 0.871 mW/g

Flat/Zoom Scan (7x7x9)/Cube 0:

Measurement grid: dx=5mm, dy=5mm, dz=3mm

Reference Value = 10.6 V/m; Power Drift = -0.054 dB

Peak SAR (extrapolated) = 1.24 W/kg

SAR(1 g) = 0.815 mW/g; SAR(10 g) = 0.487 mW/g

Maximum value of SAR (measured) = 0.971 mW/g

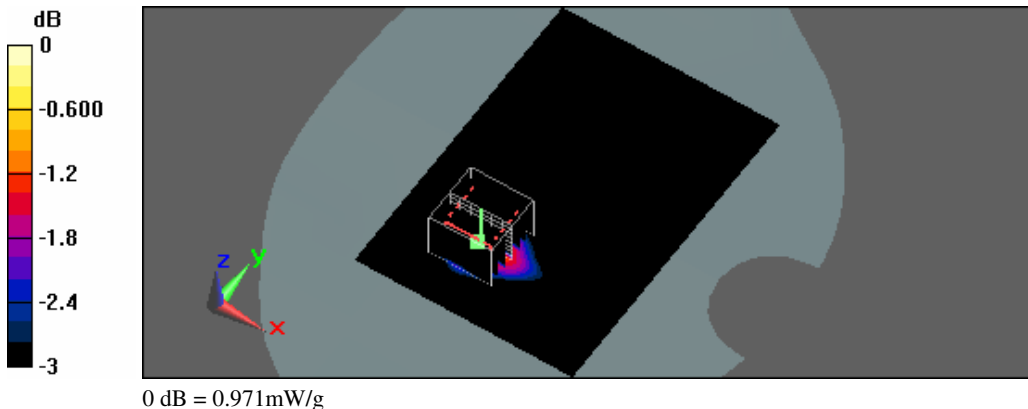

Test Laboratory: A Test Lab Techno Corp.
Date/Time: 7/1/2012 10:17:17 PM

Flat_DTM PCS CH810_2D3U_Back Surface to Phantom_10mm_Headset

DUT: PM66100; Type: Smartphone; FCC ID: NM8PM66100

Communication System: DTM PCS (2Down,3Up); Frequency: 1909.8 MHz;Duty Cycle: 1:2.8

Medium parameters used: $f = 1910 \text{ MHz}$; $\sigma = 1.5 \text{ mho/m}$; $\epsilon_r = 51$; $\rho = 1000 \text{ kg/m}^3$

Phantom section: Flat Section

Measurement Standard: DASYS (IEEE/IEC)

DASY5 Configuration:

- Area Scan setting - Find Secondary Maximum Within:2.0dB and with a peak SAR value greater than 0.5 W/Kg
- Probe: EX3DV4 - SN3847; ConvF(7.2, 7.2, 7.2); Calibrated: 3/21/2012
- Sensor-Surface: 3mm (Mechanical Surface Detection)
- Electronics: DAE4 Sn779; Calibrated: 1/23/2012
- Phantom: SAM 12; Type: SAM v4.0; Serial: TP:1009
- Measurement SW: DASYS, V5.0 Build 125;SEMCAD X Version 13.4 Build 125

Flat/Area Scan (71x101x1):

Measurement grid: dx=15mm, dy=15mm

Maximum value of SAR (interpolated) = 1.38 mW/g

Flat/Zoom Scan (7x7x9)/Cube 0:

Measurement grid: dx=5mm, dy=5mm, dz=3mm

Reference Value = 12.7 V/m; Power Drift = -0.00652 dB

Peak SAR (extrapolated) = 1.71 W/kg

SAR(1 g) = 1.08 mW/g; SAR(10 g) = 0.649 mW/g

Maximum value of SAR (measured) = 1.3 mW/g

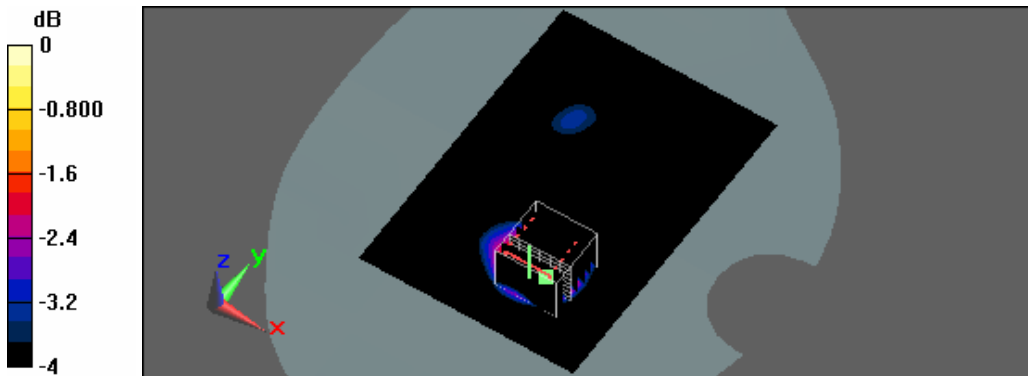

0 dB = 1.3mW/g



Test Laboratory: A Test Lab Techno Corp.
Date/Time: 6/29/2012 6:47:40 AM

Flat_WCDMA Band V CH4233_Front Surface to Phantom_10mm

DUT: PM66100; Type: Smartphone; FCC ID: NM8PM66100

Communication System: WCDMA Band V; Frequency: 846.6 MHz; Duty Cycle: 1:1
Medium parameters used: $f = 847 \text{ MHz}$; $\sigma = 1 \text{ mho/m}$; $\epsilon_r = 55$; $\rho = 1000 \text{ kg/m}^3$
Phantom section: Flat Section
Measurement Standard: DASYS (IEEE/IEC)

DASY5 Configuration:

- Area Scan setting - Find Secondary Maximum Within:2.0dB and with a peak SAR value greater than 0.5 W/Kg
- Probe: EX3DV4 - SN3847; ConvF(9.24, 9.24, 9.24); Calibrated: 3/21/2012
- Sensor-Surface: 3mm (Mechanical Surface Detection)
- Electronics: DAE4 Sn779; Calibrated: 1/23/2012
- Phantom: SAM 12; Type: SAM v4.0; Serial: TP:1009
- Measurement SW: DASYS, V5.0 Build 125; SEMCAD X Version 13.4 Build 125

Flat/Area Scan (71x101x1):

Measurement grid: $dx=15\text{mm}$, $dy=15\text{mm}$
Maximum value of SAR (interpolated) = 0.196 mW/g

Flat/Zoom Scan (7x7x9)/Cube 0:

Measurement grid: $dx=5\text{mm}$, $dy=5\text{mm}$, $dz=3\text{mm}$
Reference Value = 13 V/m; Power Drift = -0.014 dB
Peak SAR (extrapolated) = 0.226 W/kg
SAR(1 g) = 0.178 mW/g; SAR(10 g) = 0.138 mW/g
Maximum value of SAR (measured) = 0.196 mW/g

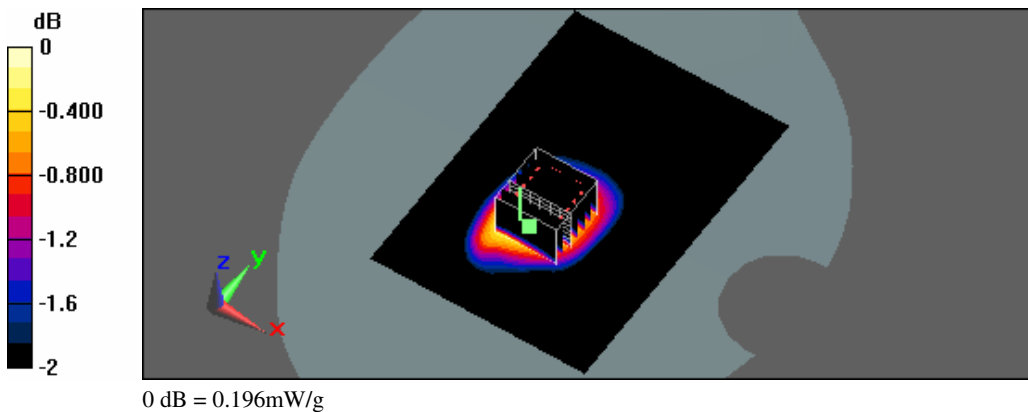

Test Laboratory: A Test Lab Techno Corp.
Date/Time: 6/29/2012 6:15:40 AM

Flat_WCDMA Band V CH4233_Back Surface to Phantom_10mm

DUT: PM66100; Type: Smartphone; FCC ID: NM8PM66100

Communication System: WCDMA Band V; Frequency: 846.6 MHz; Duty Cycle: 1:1
Medium parameters used: $f = 847 \text{ MHz}$; $\sigma = 1 \text{ mho/m}$; $\epsilon_r = 55$; $\rho = 1000 \text{ kg/m}^3$
Phantom section: Flat Section
Measurement Standard: DASYS (IEEE/IEC)

DASY5 Configuration:

- Area Scan setting - Find Secondary Maximum Within:2.0dB and with a peak SAR value greater than 0.5 W/Kg
- Probe: EX3DV4 - SN3847; ConvF(9.24, 9.24, 9.24); Calibrated: 3/21/2012
- Sensor-Surface: 3mm (Mechanical Surface Detection)
- Electronics: DAE4 Sn779; Calibrated: 1/23/2012
- Phantom: SAM 12; Type: SAM v4.0; Serial: TP:1009
- Measurement SW: DASY5, V5.0 Build 125; SEMCAD X Version 13.4 Build 125

Flat/Area Scan (71x101x1):

Measurement grid: $dx=15\text{mm}$, $dy=15\text{mm}$
Maximum value of SAR (interpolated) = 0.349 mW/g

Flat/Zoom Scan (7x7x9)/Cube 0:

Measurement grid: $dx=5\text{mm}$, $dy=5\text{mm}$, $dz=3\text{mm}$
Reference Value = 18 V/m; Power Drift = -0.042 dB
Peak SAR (extrapolated) = 0.391 W/kg
SAR(1 g) = 0.314 mW/g; SAR(10 g) = 0.239 mW/g
Maximum value of SAR (measured) = 0.345 mW/g

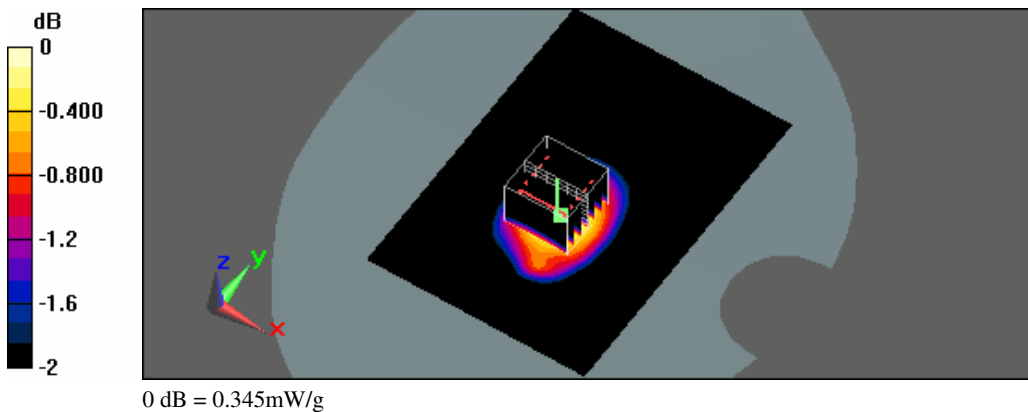

Test Laboratory: A Test Lab Techno Corp.
Date/Time: 6/29/2012 4:57:28 AM

Flat_WCDMA Band V CH4233_Edge Bottom to phantom 10mm

DUT: PM66100; Type: Smartphone; FCC ID: NM8PM66100

Communication System: WCDMA Band V; Frequency: 846.6 MHz; Duty Cycle: 1:1
Medium parameters used: $f = 847 \text{ MHz}$; $\sigma = 1 \text{ mho/m}$; $\epsilon_r = 55$; $\rho = 1000 \text{ kg/m}^3$
Phantom section: Flat Section
Measurement Standard: DASYS (IEEE/IEC)

DASY5 Configuration:

- Area Scan setting - Find Secondary Maximum Within:2.0dB and with a peak SAR value greater than 0.5 W/Kg
- Probe: EX3DV4 - SN3847; ConvF(9.24, 9.24, 9.24); Calibrated: 3/21/2012
- Sensor-Surface: 3mm (Mechanical Surface Detection)
- Electronics: DAE4 Sn779; Calibrated: 1/23/2012
- Phantom: SAM 12; Type: SAM v4.0; Serial: TP:1009
- Measurement SW: DASY5, V5.0 Build 125; SEMCAD X Version 13.4 Build 125

Flat/Area Scan (41x71x1):

Measurement grid: $dx=15\text{mm}$, $dy=15\text{mm}$
Maximum value of SAR (interpolated) = 0.020 mW/g

Flat/Zoom Scan (7x7x9)/Cube 0:

Measurement grid: $dx=5\text{mm}$, $dy=5\text{mm}$, $dz=3\text{mm}$
Reference Value = 3.84 V/m; Power Drift = -0.162 dB
Peak SAR (extrapolated) = 0.037 W/kg
SAR(1 g) = 0.017 mW/g; SAR(10 g) = 0.00927 mW/g
Maximum value of SAR (measured) = 0.021 mW/g

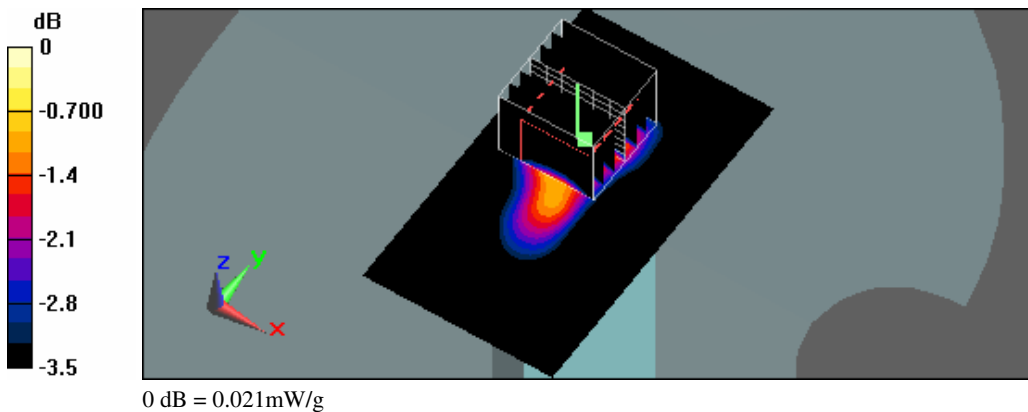

Test Laboratory: A Test Lab Techno Corp.
Date/Time: 6/29/2012 5:22:33 AM

Flat_WCDMA Band V CH4233_Edge Right to phantom 10mm

DUT: PM66100; Type: Smartphone; FCC ID: NM8PM66100

Communication System: WCDMA Band V; Frequency: 846.6 MHz; Duty Cycle: 1:1
Medium parameters used: $f = 847 \text{ MHz}$; $\sigma = 1 \text{ mho/m}$; $\epsilon_r = 55$; $\rho = 1000 \text{ kg/m}^3$
Phantom section: Flat Section
Measurement Standard: DASYS (IEEE/IEC)

DASY5 Configuration:

- Area Scan setting - Find Secondary Maximum Within:2.0dB and with a peak SAR value greater than 0.5 W/Kg
- Probe: EX3DV4 - SN3847; ConvF(9.24, 9.24, 9.24); Calibrated: 3/21/2012
- Sensor-Surface: 3mm (Mechanical Surface Detection)
- Electronics: DAE4 Sn779; Calibrated: 1/23/2012
- Phantom: SAM 12; Type: SAM v4.0; Serial: TP:1009
- Measurement SW: DASY5, V5.0 Build 125; SEMCAD X Version 13.4 Build 125

Flat/Area Scan (41x101x1):

Measurement grid: $dx=15\text{mm}$, $dy=15\text{mm}$
Maximum value of SAR (interpolated) = 0.132 mW/g

Flat/Zoom Scan (7x7x9)/Cube 0:

Measurement grid: $dx=5\text{mm}$, $dy=5\text{mm}$, $dz=3\text{mm}$
Reference Value = 11.5 V/m; Power Drift = 0.042 dB
Peak SAR (extrapolated) = 0.177 W/kg
SAR(1 g) = 0.115 mW/g; SAR(10 g) = 0.079 mW/g
Maximum value of SAR (measured) = 0.133 mW/g

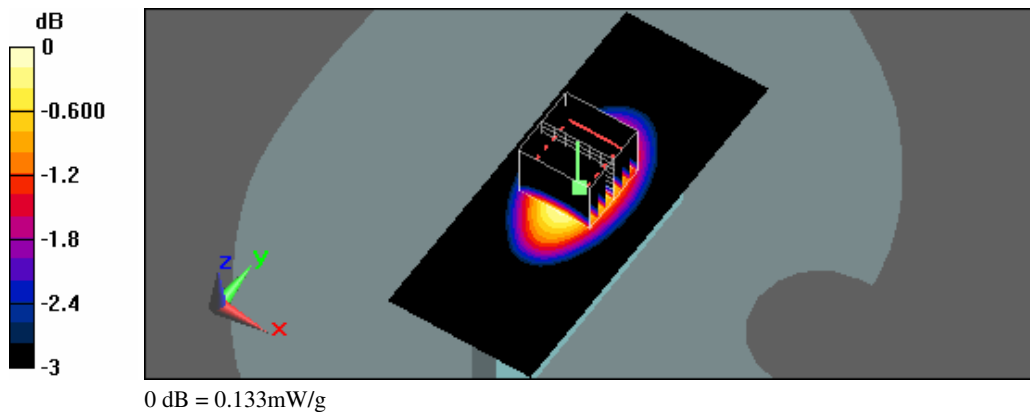



Test Laboratory: A Test Lab Techno Corp.
Date/Time: 6/29/2012 5:50:43 AM

Flat_WCDMA Band V CH4233_Edge Left to phantom 10mm

DUT: PM66100; Type: Smartphone; FCC ID: NM8PM66100

Communication System: WCDMA Band V; Frequency: 846.6 MHz; Duty Cycle: 1:1
Medium parameters used: $f = 847 \text{ MHz}$; $\sigma = 1 \text{ mho/m}$; $\epsilon_r = 55$; $\rho = 1000 \text{ kg/m}^3$
Phantom section: Flat Section
Measurement Standard: DASYS (IEEE/IEC)

DASY5 Configuration:

- Area Scan setting - Find Secondary Maximum Within:2.0dB and with a peak SAR value greater than 0.5 W/Kg
- Probe: EX3DV4 - SN3847; ConvF(9.24, 9.24, 9.24); Calibrated: 3/21/2012
- Sensor-Surface: 3mm (Mechanical Surface Detection)
- Electronics: DAE4 Sn779; Calibrated: 1/23/2012
- Phantom: SAM 12; Type: SAM v4.0; Serial: TP:1009
- Measurement SW: DASYS, V5.0 Build 125; SEMCAD X Version 13.4 Build 125

Flat/Area Scan (41x101x1):

Measurement grid: $dx=15\text{mm}$, $dy=15\text{mm}$
Maximum value of SAR (interpolated) = 0.157 mW/g

Flat/Zoom Scan (7x7x9)/Cube 0:

Measurement grid: $dx=5\text{mm}$, $dy=5\text{mm}$, $dz=3\text{mm}$
Reference Value = 12.2 V/m; Power Drift = 0.034 dB
Peak SAR (extrapolated) = 0.198 W/kg
SAR(1 g) = 0.136 mW/g; SAR(10 g) = 0.092 mW/g
Maximum value of SAR (measured) = 0.156 mW/g

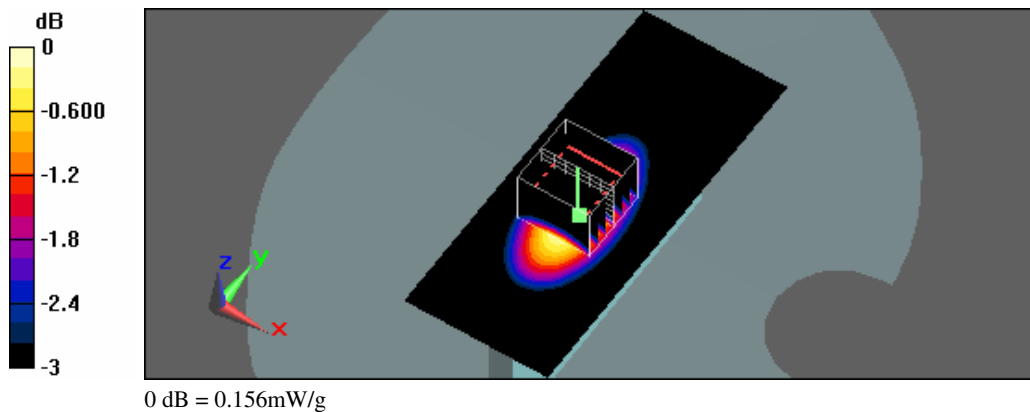

Test Laboratory: A Test Lab Techno Corp.
Date/Time: 7/2/2012 9:28:20 PM

Flat_802.11b CH11_1M_Front Surface to Phantom_10mm

DUT: PM66100; Type: Smartphone; FCC ID: NM8PM66100

Communication System: IEEE 802.11b; Frequency: 2462 MHz; Duty Cycle: 1:1
Medium parameters used: $f = 2462 \text{ MHz}$; $\sigma = 2 \text{ mho/m}$; $\epsilon_r = 51.3$; $\rho = 1000 \text{ kg/m}^3$
Phantom section: Flat Section
Measurement Standard: DASYS (IEEE/IEC)

DASY5 Configuration:

- Area Scan setting - Find Secondary Maximum Within:2.0dB and with a peak SAR value greater than 0.5 W/Kg
- Probe: EX3DV4 - SN3847; ConvF(6.85, 6.85, 6.85); Calibrated: 3/21/2012
- Sensor-Surface: 3mm (Mechanical Surface Detection)
- Electronics: DAE4 Sn779; Calibrated: 1/23/2012
- Phantom: SAM 12; Type: SAM v4.0; Serial: TP:1009
- Measurement SW: DASY5, V5.0 Build 125; SEMCAD X Version 13.4 Build 125

Flat/Area Scan (71x101x1):

Measurement grid: $dx=15\text{mm}$, $dy=15\text{mm}$
Maximum value of SAR (interpolated) = 0.176 mW/g

Flat/Zoom Scan (7x7x9)/Cube 0:

Measurement grid: $dx=5\text{mm}$, $dy=5\text{mm}$, $dz=3\text{mm}$
Reference Value = 5.57 V/m; Power Drift = 0.039 dB
Peak SAR (extrapolated) = 0.262 W/kg
SAR(1 g) = 0.141 mW/g; SAR(10 g) = 0.081 mW/g
Maximum value of SAR (measured) = 0.171 mW/g

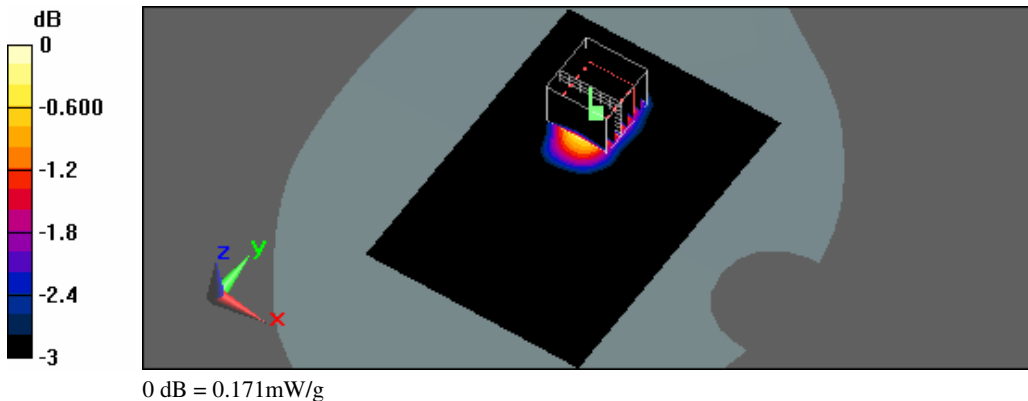

Test Laboratory: A Test Lab Techno Corp.
Date/Time: 7/2/2012 7:55:27 PM

Flat_802.11b CH11_1M_Back Surface to Phantom_10mm

DUT: PM66100; Type: Smartphone; FCC ID: NM8PM66100

Communication System: IEEE 802.11b; Frequency: 2462 MHz; Duty Cycle: 1:1
Medium parameters used: $f = 2462 \text{ MHz}$; $\sigma = 2 \text{ mho/m}$; $\epsilon_r = 51.3$; $\rho = 1000 \text{ kg/m}^3$
Phantom section: Flat Section
Measurement Standard: DASYS (IEEE/IEC)

DASY5 Configuration:

- Area Scan setting - Find Secondary Maximum Within:2.0dB and with a peak SAR value greater than 0.5 W/Kg
- Probe: EX3DV4 - SN3847; ConvF(6.85, 6.85, 6.85); Calibrated: 3/21/2012
- Sensor-Surface: 3mm (Mechanical Surface Detection)
- Electronics: DAE4 Sn779; Calibrated: 1/23/2012
- Phantom: SAM 12; Type: SAM v4.0; Serial: TP:1009
- Measurement SW: DASY5, V5.0 Build 125; SEMCAD X Version 13.4 Build 125

Flat/Area Scan (71x101x1):

Measurement grid: $dx=15\text{mm}$, $dy=15\text{mm}$
Maximum value of SAR (interpolated) = 0.371 mW/g

Flat/Zoom Scan (7x7x9)/Cube 0:

Measurement grid: $dx=5\text{mm}$, $dy=5\text{mm}$, $dz=3\text{mm}$
Reference Value = 8.98 V/m; Power Drift = 0.068 dB
Peak SAR (extrapolated) = 0.565 W/kg
SAR(1 g) = 0.309 mW/g; SAR(10 g) = 0.173 mW/g
Maximum value of SAR (measured) = 0.379 mW/g

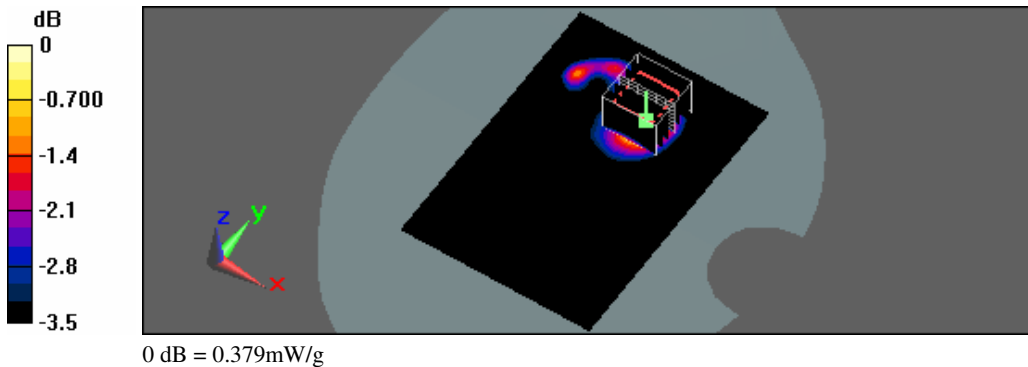



Test Laboratory: A Test Lab Techno Corp.
Date/Time: 7/2/2012 8:24:53 PM

Flat_802.11b CH11_1M_Edge Top to phantom 10mm

DUT: PM66100; Type: Smartphone; FCC ID: NM8PM66100

Communication System: IEEE 802.11b; Frequency: 2462 MHz; Duty Cycle: 1:1
Medium parameters used: $f = 2462$ MHz; $\sigma = 2$ mho/m; $\epsilon_r = 51.3$; $\rho = 1000$ kg/m³
Phantom section: Flat Section
Measurement Standard: DASYS (IEEE/IEC)

DASY5 Configuration:

- Area Scan setting - Find Secondary Maximum Within:2.0dB and with a peak SAR value greater than 0.5 W/Kg
- Probe: EX3DV4 - SN3847; ConvF(6.85, 6.85, 6.85); Calibrated: 3/21/2012
- Sensor-Surface: 3mm (Mechanical Surface Detection)
- Electronics: DAE4 Sn779; Calibrated: 1/23/2012
- Phantom: SAM 12; Type: SAM v4.0; Serial: TP:1009
- Measurement SW: DASY5, V5.0 Build 125; SEMCAD X Version 13.4 Build 125

Flat/Area Scan (41x71x1):

Measurement grid: dx=15mm, dy=15mm
Maximum value of SAR (interpolated) = 0.331 mW/g

Flat/Zoom Scan (7x7x9)/Cube 0:

Measurement grid: dx=5mm, dy=5mm, dz=3mm
Reference Value = 12.7 V/m; Power Drift = 0.026 dB
Peak SAR (extrapolated) = 0.512 W/kg
SAR(1 g) = 0.264 mW/g; SAR(10 g) = 0.137 mW/g
Maximum value of SAR (measured) = 0.331 mW/g

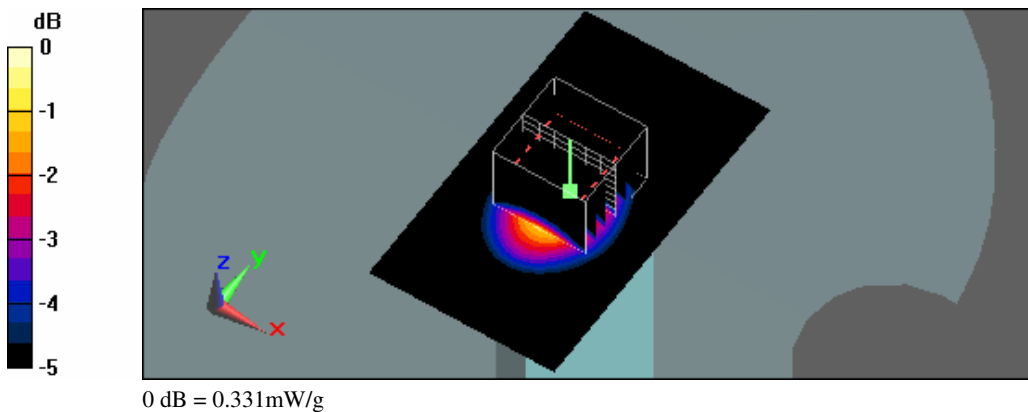



Test Laboratory: A Test Lab Techno Corp.
Date/Time: 7/2/2012 9:00:30 PM

Flat_802.11b CH11_1M_Edge Right to phantom 10mm

DUT: PM66100; Type: Smartphone; FCC ID: NM8PM66100

Communication System: IEEE 802.11b; Frequency: 2462 MHz; Duty Cycle: 1:1
Medium parameters used: $f = 2462$ MHz; $\sigma = 2$ mho/m; $\epsilon_r = 51.3$; $\rho = 1000$ kg/m³
Phantom section: Flat Section
Measurement Standard: DASYS (IEEE/IEC)

DASY5 Configuration:

- Area Scan setting - Find Secondary Maximum Within:2.0dB and with a peak SAR value greater than 0.5 W/Kg
- Probe: EX3DV4 - SN3847; ConvF(6.85, 6.85, 6.85); Calibrated: 3/21/2012
- Sensor-Surface: 3mm (Mechanical Surface Detection)
- Electronics: DAE4 Sn779; Calibrated: 1/23/2012
- Phantom: SAM 12; Type: SAM v4.0; Serial: TP:1009
- Measurement SW: DASYS, V5.0 Build 125; SEMCAD X Version 13.4 Build 125

Flat/Area Scan (41x101x1):

Measurement grid: dx=15mm, dy=15mm
Maximum value of SAR (interpolated) = 0.209 mW/g

Flat/Zoom Scan (7x7x9)/Cube 0:

Measurement grid: dx=5mm, dy=5mm, dz=3mm
Reference Value = 3.77 V/m; Power Drift = 0.147 dB
Peak SAR (extrapolated) = 0.378 W/kg
SAR(1 g) = 0.170 mW/g; SAR(10 g) = 0.078 mW/g
Maximum value of SAR (measured) = 0.222 mW/g

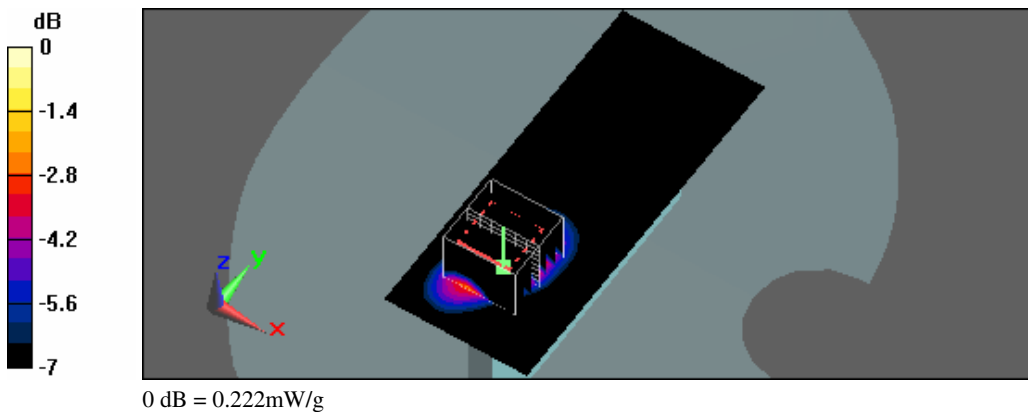

Test Laboratory: A Test Lab Techno Corp.
Date/Time: 7/3/2012 2:48:21 PM

Flat_802.11b CH11_1M_Edge Left to phantom 10mm

DUT: PM66100; Type: Smartphone; FCC ID: NM8PM66100

Communication System: IEEE 802.11b; Frequency: 2462 MHz; Duty Cycle: 1:1
Medium parameters used: $f = 2462 \text{ MHz}$; $\sigma = 2 \text{ mho/m}$; $\epsilon_r = 51.3$; $\rho = 1000 \text{ kg/m}^3$
Phantom section: Flat Section
Measurement Standard: DASYS (IEEE/IEC)

DASY5 Configuration:

- Area Scan setting - Find Secondary Maximum Within:2.0dB and with a peak SAR value greater than 0.5 W/Kg
- Probe: EX3DV4 - SN3847; ConvF(6.85, 6.85, 6.85); Calibrated: 3/21/2012
- Sensor-Surface: 3mm (Mechanical Surface Detection)
- Electronics: DAE4 Sn779; Calibrated: 1/23/2012
- Phantom: SAM 12; Type: SAM v4.0; Serial: TP:1009
- Measurement SW: DASY5, V5.0 Build 125; SEMCAD X Version 13.4 Build 125

Flat/Area Scan (61x101x1):

Measurement grid: $dx=15\text{mm}$, $dy=15\text{mm}$
Maximum value of SAR (interpolated) = 0.044 mW/g

Flat/Zoom Scan (7x7x9)/Cube 0:

Measurement grid: $dx=5\text{mm}$, $dy=5\text{mm}$, $dz=3\text{mm}$
Reference Value = 4.17 V/m; Power Drift = 0.054 dB
Peak SAR (extrapolated) = 0.076 W/kg
SAR(1 g) = 0.038 mW/g; SAR(10 g) = 0.021 mW/g
Maximum value of SAR (measured) = 0.048 mW/g

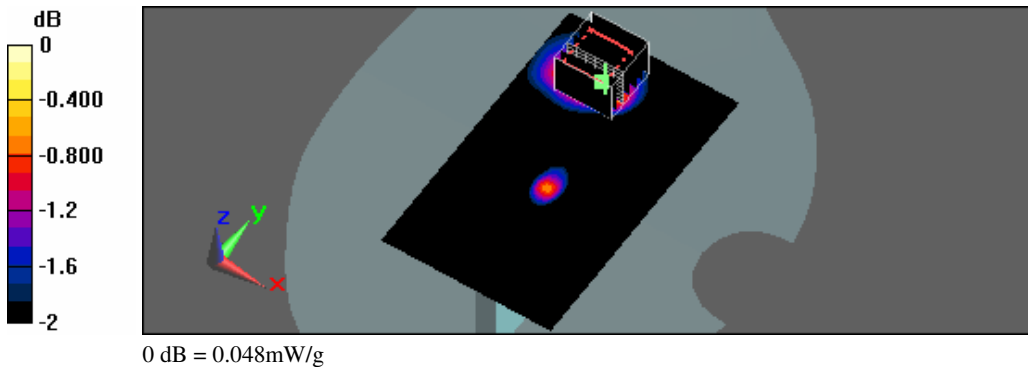



Test Laboratory: A Test Lab Techno Corp.
Date/Time: 7/3/2012 10:20:30 PM

Flat_BT CH39_BT 3.0_Front Surface to Phantom_10mm

DUT: PM66100; Type: Smartphone; FCC ID: NM8PM66100

Communication System: Bluetooth; Frequency: 2441 MHz; Duty Cycle: 1:1
Medium parameters used: $f = 2441$ MHz; $\sigma = 1.96$ mho/m; $\epsilon_r = 51.2$; $\rho = 1000$ kg/m³
Phantom section: Flat Section
Measurement Standard: DASYS (IEEE/IEC)

DASY5 Configuration:

- Area Scan setting - Find Secondary Maximum Within:2.0dB and with a peak SAR value greater than 0.5 W/Kg
- Probe: EX3DV4 - SN3847; ConvF(6.85, 6.85, 6.85); Calibrated: 3/21/2012
- Sensor-Surface: 3mm (Mechanical Surface Detection)
- Electronics: DAE4 Sn779; Calibrated: 1/23/2012
- Phantom: SAM 12; Type: SAM v4.0; Serial: TP:1009
- Measurement SW: DASYS, V5.0 Build 125; SEMCAD X Version 13.4 Build 125

Flat/Area Scan (71x101x1):

Measurement grid: dx=15mm, dy=15mm
Maximum value of SAR (interpolated) = 0.00874 mW/g

Flat/Zoom Scan (7x7x9)/Cube 0:

Measurement grid: dx=5mm, dy=5mm, dz=3mm
Reference Value = 0.733 V/m; Power Drift = 0.161 dB
Peak SAR (extrapolated) = 0.033 W/kg
SAR(1 g) = 0.00513 mW/g; SAR(10 g) = 0.00197 mW/g
Maximum value of SAR (measured) = 0.00713 mW/g

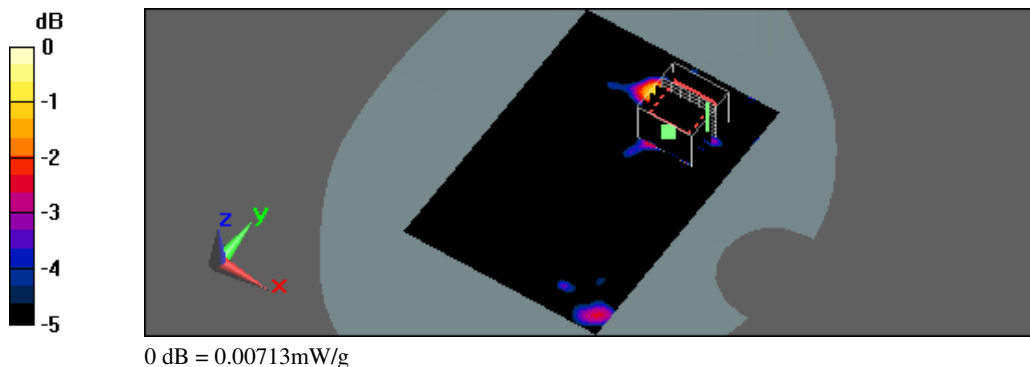

Test Laboratory: A Test Lab Techno Corp.
Date/Time: 7/3/2012 9:10:51 PM

Flat_BT CH39_BT 3.0_Back Surface to Phantom_10mm

DUT: PM66100; Type: Smartphone; FCC ID: NM8PM66100

Communication System: Bluetooth; Frequency: 2441 MHz; Duty Cycle: 1:1
Medium parameters used: $f = 2441$ MHz; $\sigma = 1.96$ mho/m; $\epsilon_r = 51.2$; $\rho = 1000$ kg/m³
Phantom section: Flat Section
Measurement Standard: DASYS (IEEE/IEC)

DASY5 Configuration:

- Area Scan setting - Find Secondary Maximum Within:2.0dB and with a peak SAR value greater than 0.5 W/Kg
- Probe: EX3DV4 - SN3847; ConvF(6.85, 6.85, 6.85); Calibrated: 3/21/2012
- Sensor-Surface: 3mm (Mechanical Surface Detection)
- Electronics: DAE4 Sn779; Calibrated: 1/23/2012
- Phantom: SAM 12; Type: SAM v4.0; Serial: TP:1009
- Measurement SW: DASYS, V5.0 Build 125; SEMCAD X Version 13.4 Build 125

Flat/Area Scan (71x101x1):

Measurement grid: dx=15mm, dy=15mm
Maximum value of SAR (interpolated) = 0.017 mW/g

Flat/Zoom Scan (7x7x9)/Cube 0:

Measurement grid: dx=5mm, dy=5mm, dz=3mm
Reference Value = 0.412 V/m; Power Drift = 0.041 dB
Peak SAR (extrapolated) = 0.070 W/kg
SAR(1 g) = 0.021 mW/g; SAR(10 g) = 0.00676 mW/g
Maximum value of SAR (measured) = 0.038 mW/g

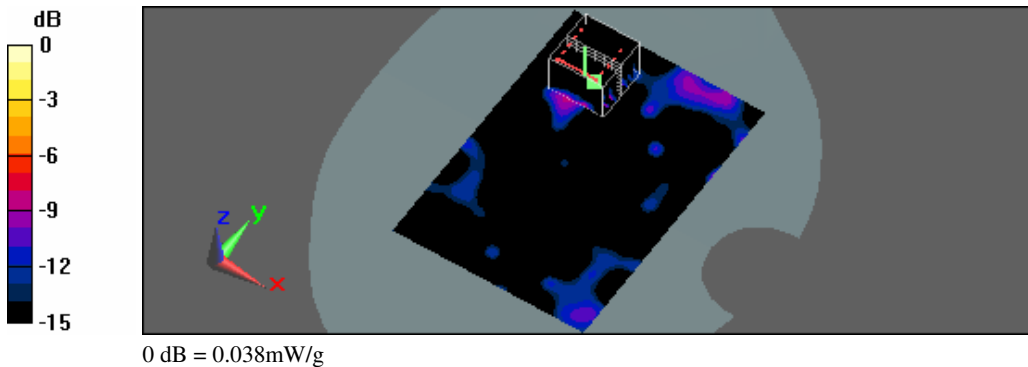



Test Laboratory: A Test Lab Techno Corp.
Date/Time: 7/3/2012 11:05:22 PM

Flat_BT CH19_BT 4.0_Front Surface to Phantom_10mm

DUT: PM66100; Type: Smartphone; FCC ID: NM8PM66100

Communication System: Bluetooth 4.0; Frequency: 2440 MHz; Duty Cycle: 1:1
Medium parameters used: $f = 2440$ MHz; $\sigma = 1.96$ mho/m; $\epsilon_r = 51.2$; $\rho = 1000$ kg/m³
Phantom section: Flat Section
Measurement Standard: DASYS (IEEE/IEC)

DASY5 Configuration:

- Area Scan setting - Find Secondary Maximum Within:2.0dB and with a peak SAR value greater than 0.5 W/Kg
- Probe: EX3DV4 - SN3847; ConvF(6.85, 6.85, 6.85); Calibrated: 3/21/2012
- Sensor-Surface: 3mm (Mechanical Surface Detection)
- Electronics: DAE4 Sn779; Calibrated: 1/23/2012
- Phantom: SAM 12; Type: SAM v4.0; Serial: TP:1009
- Measurement SW: DASYS, V5.0 Build 125; SEMCAD X Version 13.4 Build 125

Flat/Area Scan (71x101x1):

Measurement grid: dx=15mm, dy=15mm
Maximum value of SAR (interpolated) = 0.00812 mW/g

Flat/Zoom Scan (7x7x9)/Cube 0:

Measurement grid: dx=5mm, dy=5mm, dz=3mm
Reference Value = 0.412 V/m; Power Drift = 0.041 dB
Peak SAR (extrapolated) = 0.027 W/kg
SAR(1 g) = 0.00417 mW/g; SAR(10 g) = 0.00172 mW/g
Maximum value of SAR (measured) = 0.00675 mW/g

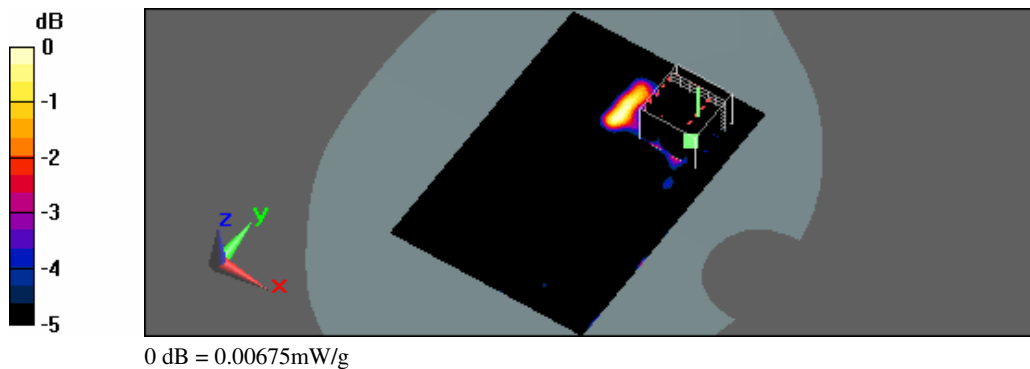

Test Laboratory: A Test Lab Techno Corp.
Date/Time: 7/3/2012 9:50:42 PM

Flat_BT CH19_BT 4.0_Back Surface to Phantom_10mm

DUT: PM66100; Type: Smartphone; FCC ID: NM8PM66100

Communication System: Bluetooth 4.0; Frequency: 2440 MHz; Duty Cycle: 1:1
Medium parameters used: $f = 2440$ MHz; $\sigma = 1.96$ mho/m; $\epsilon_r = 51.2$; $\rho = 1000$ kg/m³
Phantom section: Flat Section
Measurement Standard: DASYS (IEEE/IEC)

DASY5 Configuration:

- Area Scan setting - Find Secondary Maximum Within:2.0dB and with a peak SAR value greater than 0.5 W/Kg
- Probe: EX3DV4 - SN3847; ConvF(6.85, 6.85, 6.85); Calibrated: 3/21/2012
- Sensor-Surface: 3mm (Mechanical Surface Detection)
- Electronics: DAE4 Sn779; Calibrated: 1/23/2012
- Phantom: SAM 12; Type: SAM v4.0; Serial: TP:1009
- Measurement SW: DASY5, V5.0 Build 125;SEMCAD X Version 13.4 Build 125

Flat/Area Scan (71x101x1):

Measurement grid: dx=15mm, dy=15mm
Maximum value of SAR (interpolated) = 0.033 mW/g

Flat/Zoom Scan (7x7x9)/Cube 0:

Measurement grid: dx=5mm, dy=5mm, dz=3mm
Reference Value = 0.824 V/m; Power Drift = 0.127 dB
Peak SAR (extrapolated) = 0.062 W/kg
SAR(1 g) = 0.0198 mW/g; SAR(10 g) = 0.00644 mW/g
Maximum value of SAR (measured) = 0.038 mW/g

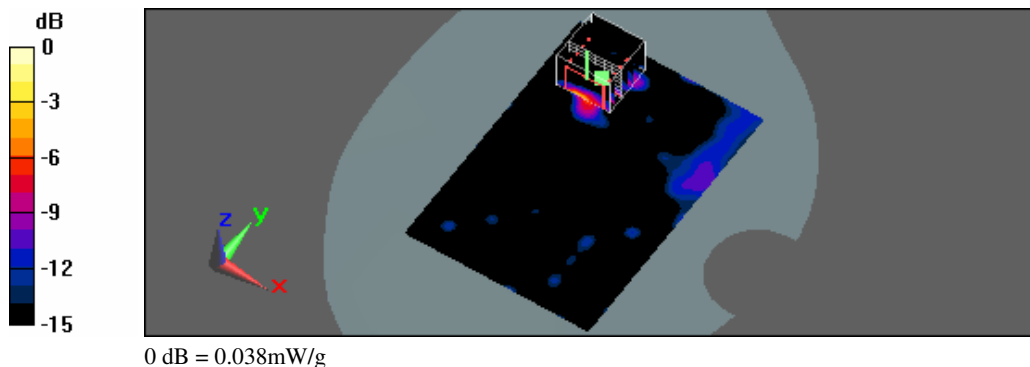



Appendix C - Calibration

All of the instruments Calibration information are listed below.

- Dipole _ D835V2 SN:4d082 Calibration No.D835V2-4d082_Jul11
- Dipole _ D1900V2 SN:5d111 Calibration No.D1900V2-5d111_Jul11
- Dipole _ D2450V2 SN:712 Calibration No.D2450V2-712_Feb12
- Probe _ EX3DV4 SN:3847 Calibration No.EX3-3847_Mar12
- DAE _ DAE4 SN:779 Calibration No.DAE4-779_Jan12



**Calibration Laboratory of
Schmid & Partner
Engineering AG**
Zeughausstrasse 43, 8004 Zurich, Switzerland



S Schweizerischer Kalibrierdienst
C Service suisse d'étalonnage
S Servizio svizzero di taratura
S Swiss Calibration Service

Accredited by the Swiss Accreditation Service (SAS)
The Swiss Accreditation Service is one of the signatories to the EA
Multilateral Agreement for the recognition of calibration certificates

Accreditation No.: **SCS 108**

Client **ATL (Auden)**

Certificate No: **D835V2-4d082_Jul11**

CALIBRATION CERTIFICATE

Object: **D835V2 - SN: 4d082**

Calibration procedure(s): **QA CAL-05.v8
Calibration procedure for dipole validation kits above 700 MHz**

Calibration date: **July 19, 2011**

This calibration certificate documents the traceability to national standards, which realize the physical units of measurements (SI).
The measurements and the uncertainties with confidence probability are given on the following pages and are part of the certificate.

All calibrations have been conducted in the closed laboratory facility: environment temperature (22 ± 3)°C and humidity < 70%.

Calibration Equipment used (M&TE critical for calibration)

Primary Standards	ID #	Cal Date (Certificate No.)	Scheduled Calibration
Power meter EPM-442A	GB37480704	06-Oct-10 (No. 217-01266)	Oct-11
Power sensor HP 8481A	US37292783	06-Oct-10 (No. 217-01266)	Oct-11
Reference 20 dB Attenuator	SN: S5086 (20b)	29-Mar-11 (No. 217-01367)	Apr-12
Type-N mismatch combination	SN: 5047.2 / 06327	29-Mar-11 (No. 217-01371)	Apr-12
Reference Probe ES3DV3	SN: 3205	29-Apr-11 (No. ES3-3205_Apr11)	Apr-12
DAE4	SN: 601	04-Jul-11 (No. DAE4-601_Jul11)	Jul-12
Secondary Standards	ID #	Check Date (in house)	Scheduled Check
Power sensor HP 8481A	MY41092317	18-Oct-02 (in house check Oct-09)	In house check: Oct-11
RF generator R&S SMT-06	100005	04-Aug-99 (in house check Oct-09)	In house check: Oct-11
Network Analyzer HP 8753E	US37390585 S4206	18-Oct-01 (in house check Oct-10)	In house check: Oct-11

Calibrated by: **Name: Claudio Leubler, Function: Laboratory Technician, Signature: [Signature]**

Approved by: **Name: Katja Pokovic, Function: Technical Manager, Signature: [Signature]**

Issued: July 19, 2011

This calibration certificate shall not be reproduced except in full without written approval of the laboratory.

Calibration Laboratory of
Schmid & Partner
Engineering AG
Zeughausstrasse 43, 8004 Zurich, Switzerland



S Schweizerischer Kalibrierdienst
C Service suisse d'étalonnage
S Servizio svizzero di taratura
S Swiss Calibration Service

Accredited by the Swiss Accreditation Service (SAS)
The Swiss Accreditation Service is one of the signatories to the EA
Multilateral Agreement for the recognition of calibration certificates

Accreditation No.: **SCS 108**

Glossary:

TSL	tissue simulating liquid
ConvF	sensitivity in TSL / NORM x,y,z
N/A	not applicable or not measured

Calibration is Performed According to the Following Standards:

- IEEE Std 1528-2003, "IEEE Recommended Practice for Determining the Peak Spatial-Averaged Specific Absorption Rate (SAR) in the Human Head from Wireless Communications Devices: Measurement Techniques", December 2003
- IEC 62209-1, "Procedure to measure the Specific Absorption Rate (SAR) for hand-held devices used in close proximity to the ear (frequency range of 300 MHz to 3 GHz)", February 2005
- Federal Communications Commission Office of Engineering & Technology (FCC OET), "Evaluating Compliance with FCC Guidelines for Human Exposure to Radiofrequency Electromagnetic Fields; Additional Information for Evaluating Compliance of Mobile and Portable Devices with FCC Limits for Human Exposure to Radiofrequency Emissions", Supplement C (Edition 01-01) to Bulletin 65

Additional Documentation:

- DASY4/5 System Handbook

Methods Applied and Interpretation of Parameters:

- Measurement Conditions:** Further details are available from the Validation Report at the end of the certificate. All figures stated in the certificate are valid at the frequency indicated.
- Antenna Parameters with TSL:** The dipole is mounted with the spacer to position its feed point exactly below the center marking of the flat phantom section, with the arms oriented parallel to the body axis.
- Feed Point Impedance and Return Loss:** These parameters are measured with the dipole positioned under the liquid filled phantom. The impedance stated is transformed from the measurement at the SMA connector to the feed point. The Return Loss ensures low reflected power. No uncertainty required.
- Electrical Delay:** One-way delay between the SMA connector and the antenna feed point. No uncertainty required.
- SAR measured:** SAR measured at the stated antenna input power.
- SAR normalized:** SAR as measured, normalized to an input power of 1 W at the antenna connector.
- SAR for nominal TSL parameters:** The measured TSL parameters are used to calculate the nominal SAR result.



Measurement Conditions

DASY system configuration, as far as not given on page 1.

DASY Version	DASY5	V52.6.2
Extrapolation	Advanced Extrapolation	
Phantom	Modular Flat Phantom	
Distance Dipole Center - TSL	15 mm	with Spacer
Zoom Scan Resolution	dx, dy, dz = 5 mm	
Frequency	835 MHz \pm 1 MHz	

Head TSL parameters

The following parameters and calculations were applied.

	Temperature	Permittivity	Conductivity
Nominal Head TSL parameters	22.0 °C	41.5	0.90 mho/m
Measured Head TSL parameters	(22.0 \pm 0.2) °C	41.0 \pm 6 %	0.88 mho/m \pm 6 %
Head TSL temperature change during test	< 0.5 °C	----	----

SAR result with Head TSL

SAR averaged over 1 cm ³ (1 g) of Head TSL	Condition	
SAR measured	250 mW input power	2.28 mW / g
SAR for nominal Head TSL parameters	normalized to 1W	9.25 mW / g \pm 17.0 % (k=2)

SAR averaged over 10 cm ³ (10 g) of Head TSL	condition	
SAR measured	250 mW input power	1.50 mW / g
SAR for nominal Head TSL parameters	normalized to 1W	6.07 mW / g \pm 16.5 % (k=2)

Body TSL parameters

The following parameters and calculations were applied.

	Temperature	Permittivity	Conductivity
Nominal Body TSL parameters	22.0 °C	55.2	0.97 mho/m
Measured Body TSL parameters	(22.0 \pm 0.2) °C	53.8 \pm 6 %	0.98 mho/m \pm 6 %
Body TSL temperature change during test	< 0.5 °C	----	----

SAR result with Body TSL

SAR averaged over 1 cm ³ (1 g) of Body TSL	Condition	
SAR measured	250 mW input power	2.39 mW / g
SAR for nominal Body TSL parameters	normalized to 1W	9.43 mW / g \pm 17.0 % (k=2)

SAR averaged over 10 cm ³ (10 g) of Body TSL	condition	
SAR measured	250 mW input power	1.57 mW / g
SAR for nominal Body TSL parameters	normalized to 1W	6.22 mW / g \pm 16.5 % (k=2)



Appendix

Antenna Parameters with Head TSL

Impedance, transformed to feed point	50.4 Ω - 7.0 j Ω
Return Loss	- 23.1 dB

Antenna Parameters with Body TSL

Impedance, transformed to feed point	46.1 Ω - 8.8 j Ω
Return Loss	- 20.0 dB

General Antenna Parameters and Design

Electrical Delay (one direction)	1.389 ns
----------------------------------	----------

After long term use with 100W radiated power, only a slight warming of the dipole near the feedpoint can be measured.

The dipole is made of standard semirigid coaxial cable. The center conductor of the feeding line is directly connected to the second arm of the dipole. The antenna is therefore short-circuited for DC-signals.

No excessive force must be applied to the dipole arms, because they might bend or the soldered connections near the feedpoint may be damaged.

Additional EUT Data

Manufactured by	SPEAG
Manufactured on	October 17, 2008

DASY5 Validation Report for Head TSL

Date: 18.07.2011

Test Laboratory: SPEAG, Zurich, Switzerland

DUT: Dipole 835 MHz; Type: D835V2; Serial: D835V2 - SN: 4d082

Communication System: CW; Frequency: 835 MHz

Medium parameters used: $f = 835$ MHz; $\sigma = 0.88$ mho/m; $\epsilon_r = 41$; $\rho = 1000$ kg/m³

Phantom section: Flat Section

Measurement Standard: DASY5 (IEEE/IEC/ANSI C63.19-2007)

DASY52 Configuration:

- Probe: ES3DV3 - SN3205; ConvF(6.07, 6.07, 6.07); Calibrated: 29.04.2011
- Sensor-Surface: 3mm (Mechanical Surface Detection)
- Electronics: DAE4 Sn601; Calibrated: 04.07.2011
- Phantom: Flat Phantom 4.9L; Type: QD000P49AA; Serial: 1001
- DASY52 52.6.2(482); SEMCAD X 14.4.5(3634)

Dipole Calibration for Head Tissue/Pin=250 mW, d=15mm/Zoom Scan (7x7x7)/Cube 0:

Measurement grid: dx=5mm, dy=5mm, dz=5mm

Reference Value = 56.745 V/m; Power Drift = 0.03 dB

Peak SAR (extrapolated) = 3.357 W/kg

SAR(1 g) = 2.28 mW/g; SAR(10 g) = 1.5 mW/g

Maximum value of SAR (measured) = 2.657 mW/g

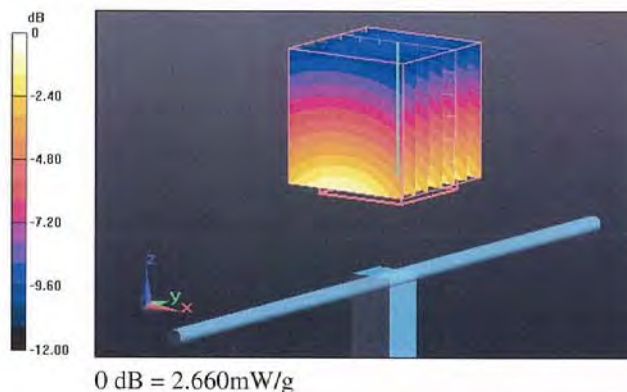



Impedance Measurement Plot for Head TSL

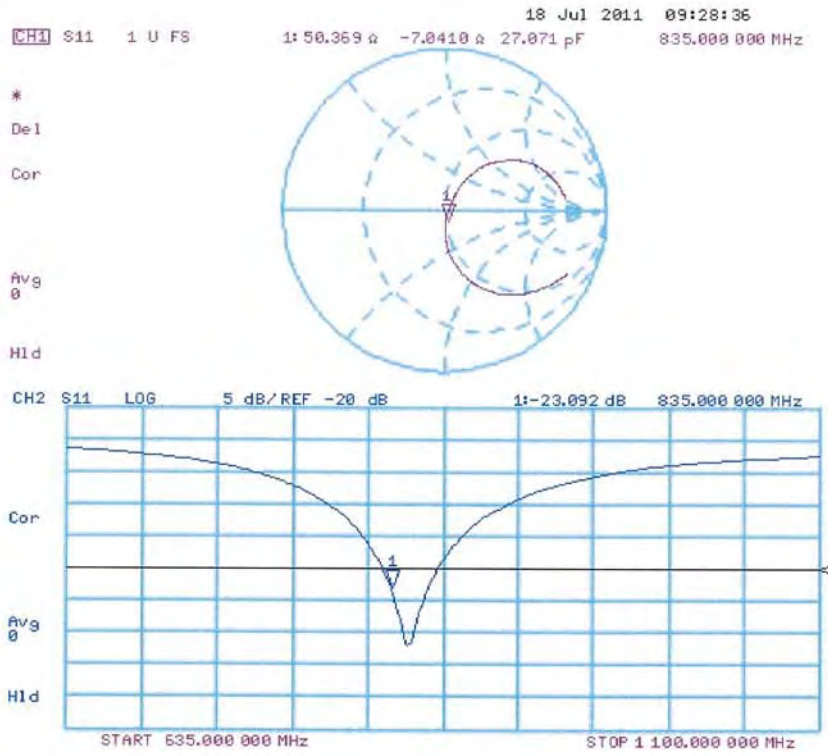

DASY5 Validation Report for Body TSL

Date: 19.07.2011

Test Laboratory: SPEAG, Zurich, Switzerland

DUT: Dipole 835 MHz; Type: D835V2; Serial: D835V2 - SN: 4d082

Communication System: CW; Frequency: 835 MHz

Medium parameters used: $f = 835 \text{ MHz}$; $\sigma = 0.98 \text{ mho/m}$; $\epsilon_r = 53.8$; $\rho = 1000 \text{ kg/m}^3$

Phantom section: Flat Section

Measurement Standard: DASY5 (IEEE/IEC/ANSI C63.19-2007)

DASY52 Configuration:

- Probe: ES3DV3 - SN3205; ConvF(6.02, 6.02, 6.02); Calibrated: 29.04.2011
- Sensor-Surface: 3mm (Mechanical Surface Detection)
- Electronics: DAE4 Sn601; Calibrated: 04.07.2011
- Phantom: Flat Phantom 4.9L; Type: QD000P49AA; Serial: 1001
- DASY52 52.6.2(482); SEMCAD X 14.4.5(3634)

Dipole Calibration for Body Tissue/Pin=250 mW, $d=15\text{mm}$ /Zoom Scan (7x7x7)/Cube 0:

Measurement grid: $dx=5\text{mm}$, $dy=5\text{mm}$, $dz=5\text{mm}$

Reference Value = 54.883 V/m; Power Drift = 0.06 dB

Peak SAR (extrapolated) = 3.464 W/kg

SAR(1 g) = 2.39 mW/g; SAR(10 g) = 1.57 mW/g

Maximum value of SAR (measured) = 2.762 mW/g

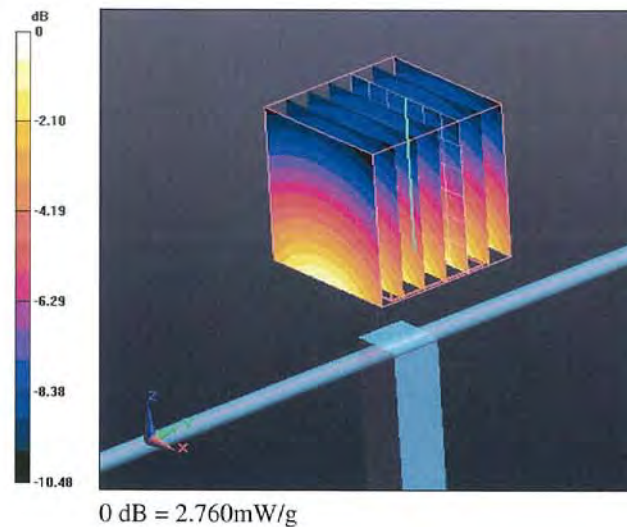



Impedance Measurement Plot for Body TSL

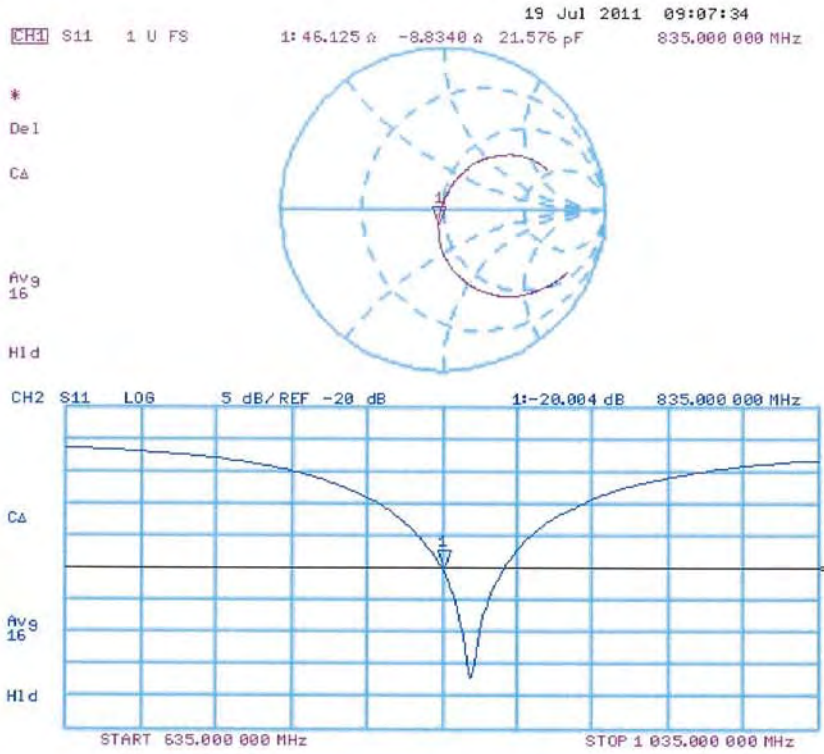



**Calibration Laboratory of
Schmid & Partner
Engineering AG**
Zeughausstrasse 43, 8004 Zurich, Switzerland



S Schweizerischer Kalibrierdienst
C Service suisse d'étalonnage
S Servizio svizzero di taratura
S Swiss Calibration Service

Accredited by the Swiss Accreditation Service (SAS)
The Swiss Accreditation Service is one of the signatories to the EA
Multilateral Agreement for the recognition of calibration certificates

Accreditation No.: **SCS 108**

Client **ATL (Auden)**

Certificate No: **D1900V2-5d111_Jul11**

CALIBRATION CERTIFICATE																																															
Object	D1900V2 - SN: 5d111																																														
Calibration procedure(s)	QA CAL-05.v8 Calibration procedure for dipole validation kits above 700 MHz																																														
Calibration date:	July 22, 2011																																														
<p>This calibration certificate documents the traceability to national standards, which realize the physical units of measurements (SI). The measurements and the uncertainties with confidence probability are given on the following pages and are part of the certificate.</p> <p>All calibrations have been conducted in the closed laboratory facility: environment temperature (22 ± 3)°C and humidity < 70%.</p> <p>Calibration Equipment used (M&TE critical for calibration)</p> <table border="1"> <thead> <tr> <th>Primary Standards</th> <th>ID #</th> <th>Cal Date (Certificate No.)</th> <th>Scheduled Calibration</th> </tr> </thead> <tbody> <tr> <td>Power meter EPM-442A</td> <td>GB37480704</td> <td>06-Oct-10 (No. 217-01266)</td> <td>Oct-11</td> </tr> <tr> <td>Power sensor HP 8481A</td> <td>US37292783</td> <td>06-Oct-10 (No. 217-01266)</td> <td>Oct-11</td> </tr> <tr> <td>Reference 20 dB Attenuator</td> <td>SN: S5086 (20b)</td> <td>29-Mar-11 (No. 217-01367)</td> <td>Apr-12</td> </tr> <tr> <td>Type-N mismatch combination</td> <td>SN: 5047.2 / 06327</td> <td>29-Mar-11 (No. 217-01371)</td> <td>Apr-12</td> </tr> <tr> <td>Reference Probe ES3DV3</td> <td>SN: 3205</td> <td>29-Apr-11 (No. ES3-3205_Apr11)</td> <td>Apr-12</td> </tr> <tr> <td>DAE4</td> <td>SN: 601</td> <td>04-Jul-11 (No. DAE4-601_Jul11)</td> <td>Jul-12</td> </tr> </tbody> </table> <table border="1"> <thead> <tr> <th>Secondary Standards</th> <th>ID #</th> <th>Check Date (in house)</th> <th>Scheduled Check</th> </tr> </thead> <tbody> <tr> <td>Power sensor HP 8481A</td> <td>MY41092317</td> <td>18-Oct-02 (in house check Oct-09)</td> <td>In house check: Oct-11</td> </tr> <tr> <td>RF generator R&S SMT-06</td> <td>100005</td> <td>04-Aug-99 (in house check Oct-09)</td> <td>In house check: Oct-11</td> </tr> <tr> <td>Network Analyzer HP 8753E</td> <td>US37390585 S4206</td> <td>18-Oct-01 (in house check Oct-10)</td> <td>In house check: Oct-11</td> </tr> </tbody> </table>				Primary Standards	ID #	Cal Date (Certificate No.)	Scheduled Calibration	Power meter EPM-442A	GB37480704	06-Oct-10 (No. 217-01266)	Oct-11	Power sensor HP 8481A	US37292783	06-Oct-10 (No. 217-01266)	Oct-11	Reference 20 dB Attenuator	SN: S5086 (20b)	29-Mar-11 (No. 217-01367)	Apr-12	Type-N mismatch combination	SN: 5047.2 / 06327	29-Mar-11 (No. 217-01371)	Apr-12	Reference Probe ES3DV3	SN: 3205	29-Apr-11 (No. ES3-3205_Apr11)	Apr-12	DAE4	SN: 601	04-Jul-11 (No. DAE4-601_Jul11)	Jul-12	Secondary Standards	ID #	Check Date (in house)	Scheduled Check	Power sensor HP 8481A	MY41092317	18-Oct-02 (in house check Oct-09)	In house check: Oct-11	RF generator R&S SMT-06	100005	04-Aug-99 (in house check Oct-09)	In house check: Oct-11	Network Analyzer HP 8753E	US37390585 S4206	18-Oct-01 (in house check Oct-10)	In house check: Oct-11
Primary Standards	ID #	Cal Date (Certificate No.)	Scheduled Calibration																																												
Power meter EPM-442A	GB37480704	06-Oct-10 (No. 217-01266)	Oct-11																																												
Power sensor HP 8481A	US37292783	06-Oct-10 (No. 217-01266)	Oct-11																																												
Reference 20 dB Attenuator	SN: S5086 (20b)	29-Mar-11 (No. 217-01367)	Apr-12																																												
Type-N mismatch combination	SN: 5047.2 / 06327	29-Mar-11 (No. 217-01371)	Apr-12																																												
Reference Probe ES3DV3	SN: 3205	29-Apr-11 (No. ES3-3205_Apr11)	Apr-12																																												
DAE4	SN: 601	04-Jul-11 (No. DAE4-601_Jul11)	Jul-12																																												
Secondary Standards	ID #	Check Date (in house)	Scheduled Check																																												
Power sensor HP 8481A	MY41092317	18-Oct-02 (in house check Oct-09)	In house check: Oct-11																																												
RF generator R&S SMT-06	100005	04-Aug-99 (in house check Oct-09)	In house check: Oct-11																																												
Network Analyzer HP 8753E	US37390585 S4206	18-Oct-01 (in house check Oct-10)	In house check: Oct-11																																												
Calibrated by:	Name Dimce Iliev	Function Laboratory Technician	Signature 																																												
Approved by:	Name Katja Pokovic	Function Technical Manager	Signature 																																												
			Issued: July 22, 2011																																												
This calibration certificate shall not be reproduced except in full without written approval of the laboratory.																																															

**Calibration Laboratory of
Schmid & Partner
Engineering AG**
Zeughausstrasse 43, 8004 Zurich, Switzerland



S Schweizerischer Kalibrierdienst
C Service suisse d'étalonnage
S Servizio svizzero di taratura
S Swiss Calibration Service

Accredited by the Swiss Accreditation Service (SAS)
The Swiss Accreditation Service is one of the signatories to the EA
Multilateral Agreement for the recognition of calibration certificates

Accreditation No.: **SCS 108**

Glossary:

TSL	tissue simulating liquid
ConvF	sensitivity in TSL / NORM x,y,z
N/A	not applicable or not measured

Calibration is Performed According to the Following Standards:

- IEEE Std 1528-2003, "IEEE Recommended Practice for Determining the Peak Spatial-Averaged Specific Absorption Rate (SAR) in the Human Head from Wireless Communications Devices: Measurement Techniques", December 2003
- IEC 62209-1, "Procedure to measure the Specific Absorption Rate (SAR) for hand-held devices used in close proximity to the ear (frequency range of 300 MHz to 3 GHz)", February 2005
- Federal Communications Commission Office of Engineering & Technology (FCC OET), "Evaluating Compliance with FCC Guidelines for Human Exposure to Radiofrequency Electromagnetic Fields; Additional Information for Evaluating Compliance of Mobile and Portable Devices with FCC Limits for Human Exposure to Radiofrequency Emissions", Supplement C (Edition 01-01) to Bulletin 65

Additional Documentation:

- DASY4/5 System Handbook

Methods Applied and Interpretation of Parameters:

- Measurement Conditions:** Further details are available from the Validation Report at the end of the certificate. All figures stated in the certificate are valid at the frequency indicated.
- Antenna Parameters with TSL:** The dipole is mounted with the spacer to position its feed point exactly below the center marking of the flat phantom section, with the arms oriented parallel to the body axis.
- Feed Point Impedance and Return Loss:** These parameters are measured with the dipole positioned under the liquid filled phantom. The impedance stated is transformed from the measurement at the SMA connector to the feed point. The Return Loss ensures low reflected power. No uncertainty required.
- Electrical Delay:** One-way delay between the SMA connector and the antenna feed point. No uncertainty required.
- SAR measured:** SAR measured at the stated antenna input power.
- SAR normalized:** SAR as measured, normalized to an input power of 1 W at the antenna connector.
- SAR for nominal TSL parameters:** The measured TSL parameters are used to calculate the nominal SAR result.



Measurement Conditions

DASY system configuration, as far as not given on page 1.

DASY Version	DASY5	V52.6.2
Extrapolation	Advanced Extrapolation	
Phantom	Modular Flat Phantom	
Distance Dipole Center - TSL	10 mm	with Spacer
Zoom Scan Resolution	dx, dy, dz = 5 mm	
Frequency	1900 MHz \pm 1 MHz	

Head TSL parameters

The following parameters and calculations were applied.

	Temperature	Permittivity	Conductivity
Nominal Head TSL parameters	22.0 °C	40.0	1.40 mho/m
Measured Head TSL parameters	(22.0 \pm 0.2) °C	39.1 \pm 6 %	1.42 mho/m \pm 6 %
Head TSL temperature change during test	< 0.5 °C	----	----

SAR result with Head TSL

SAR averaged over 1 cm ³ (1 g) of Head TSL	Condition	
SAR measured	250 mW input power	10.1 mW / g
SAR for nominal Head TSL parameters	normalized to 1W	39.9 mW / g \pm 17.0 % (k=2)

SAR averaged over 10 cm ³ (10 g) of Head TSL	condition	
SAR measured	250 mW input power	5.25 mW / g
SAR for nominal Head TSL parameters	normalized to 1W	20.8 mW / g \pm 16.5 % (k=2)

Body TSL parameters

The following parameters and calculations were applied.

	Temperature	Permittivity	Conductivity
Nominal Body TSL parameters	22.0 °C	53.3	1.52 mho/m
Measured Body TSL parameters	(22.0 \pm 0.2) °C	52.3 \pm 6 %	1.53 mho/m \pm 6 %
Body TSL temperature change during test	< 0.5 °C	----	----

SAR result with Body TSL

SAR averaged over 1 cm ³ (1 g) of Body TSL	Condition	
SAR measured	250 mW input power	10.3 mW / g
SAR for nominal Body TSL parameters	normalized to 1W	40.9 mW / g \pm 17.0 % (k=2)

SAR averaged over 10 cm ³ (10 g) of Body TSL	condition	
SAR measured	250 mW input power	5.39 mW / g
SAR for nominal Body TSL parameters	normalized to 1W	21.5 mW / g \pm 16.5 % (k=2)



Appendix

Antenna Parameters with Head TSL

Impedance, transformed to feed point	$51.3 \Omega + 6.7 j\Omega$
Return Loss	- 23.5 dB

Antenna Parameters with Body TSL

Impedance, transformed to feed point	$45.9 \Omega + 6.6 j\Omega$
Return Loss	- 21.8 dB

General Antenna Parameters and Design

Electrical Delay (one direction)	1.201 ns
----------------------------------	----------

After long term use with 100W radiated power, only a slight warming of the dipole near the feedpoint can be measured.

The dipole is made of standard semirigid coaxial cable. The center conductor of the feeding line is directly connected to the second arm of the dipole. The antenna is therefore short-circuited for DC-signals.

No excessive force must be applied to the dipole arms, because they might bend or the soldered connections near the feedpoint may be damaged.

Additional EUT Data

Manufactured by	SPEAG
Manufactured on	March 28, 2008

DASY5 Validation Report for Head TSL

Date: 20.07.2011

Test Laboratory: SPEAG, Zurich, Switzerland

DUT: Dipole 1900 MHz; Type: D1900V2; Serial: D1900V2 - SN: 5d111

Communication System: CW; Frequency: 1900 MHz

Medium parameters used: $f = 1900$ MHz; $\sigma = 1.42$ mho/m; $\epsilon_r = 39.1$; $\rho = 1000$ kg/m³

Phantom section: Flat Section

Measurement Standard: DASY5 (IEEE/IEC/ANSI C63.19-2007)

DASY52 Configuration:

- Probe: ES3DV3 - SN3205; ConvF(5.01, 5.01, 5.01); Calibrated: 29.04.2011
- Sensor-Surface: 3mm (Mechanical Surface Detection)
- Electronics: DAE4 Sn601; Calibrated: 04.07.2011
- Phantom: Flat Phantom 5.0 (front); Type: QD000P50AA; Serial: 1001
- DASY52 52.6.2(482); SEMCAD X 14.4.5(3634)

Dipole Calibration for Head Tissue/Pin=250 mW, d=10mm/Zoom Scan (7x7x7)/Cube 0:

Measurement grid: dx=5mm, dy=5mm, dz=5mm

Reference Value = 98.068 V/m; Power Drift = 0.03 dB

Peak SAR (extrapolated) = 18.391 W/kg

SAR(1 g) = 10.1 mW/g; SAR(10 g) = 5.25 mW/g

Maximum value of SAR (measured) = 12.667 mW/g

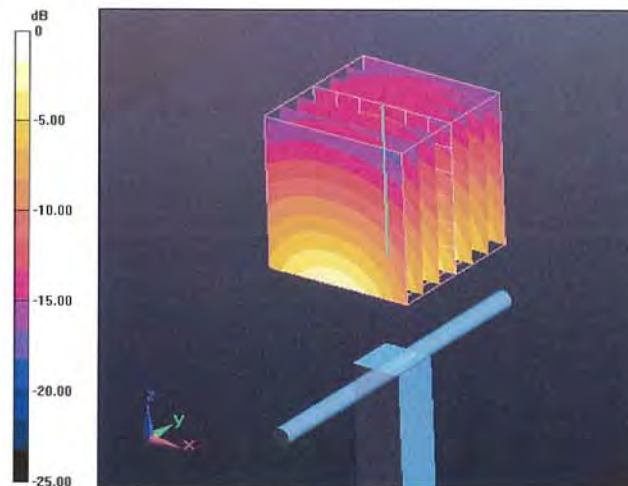

0 dB = 12.670mW/g



Impedance Measurement Plot for Head TSL

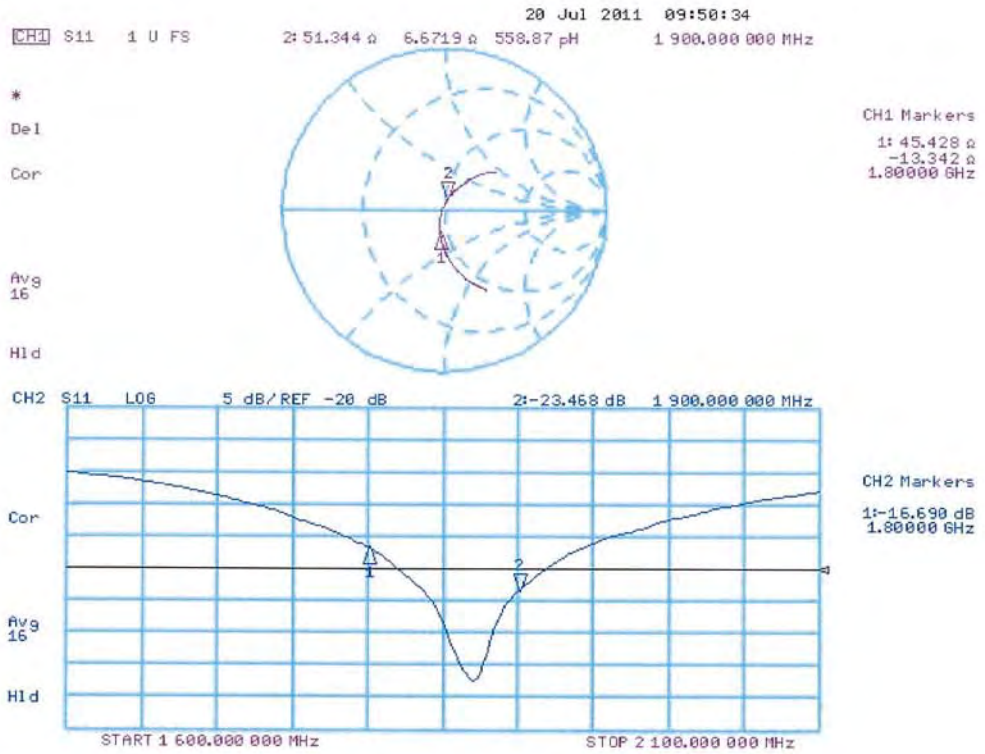

DASY5 Validation Report for Body TSL

Date: 22.07.2011

Test Laboratory: SPEAG, Zurich, Switzerland

DUT: Dipole 1900 MHz; Type: D1900V2; Serial: D1900V2 - SN: 5d111

Communication System: CW; Frequency: 1900 MHz

Medium parameters used: $f = 1900$ MHz; $\sigma = 1.53$ mho/m; $\epsilon_r = 52.3$; $\rho = 1000$ kg/m³

Phantom section: Flat Section

Measurement Standard: DASY5 (IEEE/IEC/ANSI C63.19-2007)

DASY52 Configuration:

- Probe: ES3DV3 - SN3205; ConvF(4.62, 4.62, 4.62); Calibrated: 29.04.2011
- Sensor-Surface: 3mm (Mechanical Surface Detection)
- Electronics: DAE4 Sn601; Calibrated: 04.07.2011
- Phantom: Flat Phantom 5.0 (back); Type: QD000P50AA; Serial: 1002
- DASY52 52.6.2(482); SEMCAD X 14.4.5(3634)

Dipole Calibration for Body Tissue/Pin=250 mW, d=10mm/Zoom Scan (7x7x7)/Cube 0:

Measurement grid: dx=5mm, dy=5mm, dz=5mm

Reference Value = 95.720 V/m; Power Drift = 0.01 dB

Peak SAR (extrapolated) = 18.122 W/kg

SAR(1 g) = 10.3 mW/g; SAR(10 g) = 5.39 mW/g

Maximum value of SAR (measured) = 12.882 mW/g

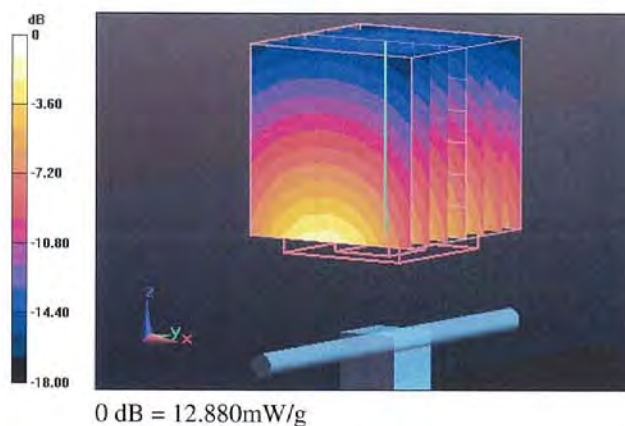



Impedance Measurement Plot for Body TSL

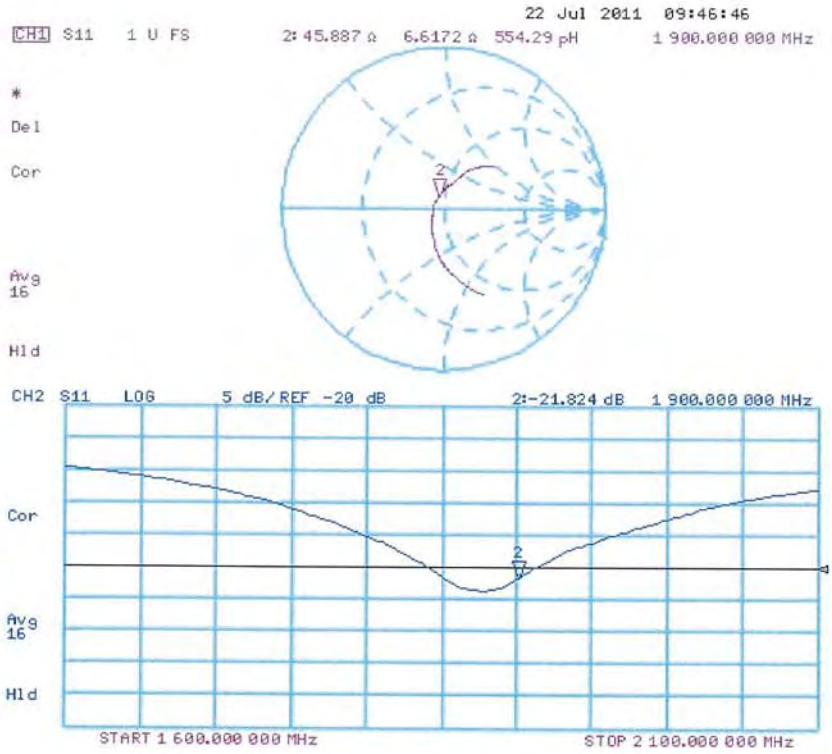



**Calibration Laboratory of
Schmid & Partner
Engineering AG**
Zeughausstrasse 43, 8004 Zurich, Switzerland



S Schweizerischer Kalibrierdienst
C Service suisse d'étalonnage
S Servizio svizzero di taratura
S Swiss Calibration Service

Accredited by the Swiss Accreditation Service (SAS)
The Swiss Accreditation Service is one of the signatories to the EA
Multilateral Agreement for the recognition of calibration certificates

Accreditation No.: **SCS 108**

Client **ATL (Auden)**

Certificate No: **D2450V2-712_Feb12**

CALIBRATION CERTIFICATE

Object **D2450V2 - SN: 712**

Calibration procedure(s) **QA CAL-05.v8
Calibration procedure for dipole validation kits above 700 MHz**

Calibration date: **February 23, 2012**

This calibration certificate documents the traceability to national standards, which realize the physical units of measurements (SI).
The measurements and the uncertainties with confidence probability are given on the following pages and are part of the certificate.

All calibrations have been conducted in the closed laboratory facility: environment temperature (22 ± 3)°C and humidity < 70%.

Calibration Equipment used (M&TE critical for calibration)

Primary Standards	ID #	Cal Date (Certificate No.)	Scheduled Calibration
Power meter EPM-442A	GB37480704	05-Oct-11 (No. 217-01451)	Oct-12
Power sensor HP 8481A	US37292783	05-Oct-11 (No. 217-01451)	Oct-12
Reference 20 dB Attenuator	SN: 5086 (20g)	29-Mar-11 (No. 217-01368)	Apr-12
Type-N mismatch combination	SN: 5047.2 / 06327	29-Mar-11 (No. 217-01371)	Apr-12
Reference Probe ES3DV3	SN: 3205	30-Dec-11 (No. ES3-3205_Dec11)	Dec-12
DAE4	SN: 601	04-Jul-11 (No. DAE4-601_Jul11)	Jul-12
Secondary Standards	ID #	Check Date (in house)	Scheduled Check
Power sensor HP 8481A	MY41092317	18-Oct-02 (in house check Oct-11)	In house check: Oct-13
RF generator R&S SMT-06	100005	04-Aug-99 (in house check Oct-11)	In house check: Oct-13
Network Analyzer HP 8753E	US37390585 S4206	18-Oct-01 (in house check Oct-11)	In house check: Oct-12

	Name	Function	Signature
Calibrated by:	Israe El-Naouq	Laboratory Technician	
Approved by:	Katja Pokovic	Technical Manager	

Issued: February 23, 2012

This calibration certificate shall not be reproduced except in full without written approval of the laboratory.

**Calibration Laboratory of
Schmid & Partner
Engineering AG**
Zeughausstrasse 43, 8004 Zurich, Switzerland



S Schweizerischer Kalibrierdienst
S Service suisse d'étalonnage
C Servizio svizzero di taratura
S Swiss Calibration Service

Accredited by the Swiss Accreditation Service (SAS)
The Swiss Accreditation Service is one of the signatories to the EA
Multilateral Agreement for the recognition of calibration certificates

Accreditation No.: **SCS 108**

Glossary:

TSL	tissue simulating liquid
ConvF	sensitivity in TSL / NORM x,y,z
N/A	not applicable or not measured

Calibration is Performed According to the Following Standards:

- a) IEEE Std 1528-2003, "IEEE Recommended Practice for Determining the Peak Spatial-Averaged Specific Absorption Rate (SAR) in the Human Head from Wireless Communications Devices: Measurement Techniques", December 2003
- b) IEC 62209-1, "Procedure to measure the Specific Absorption Rate (SAR) for hand-held devices used in close proximity to the ear (frequency range of 300 MHz to 3 GHz)", February 2005
- c) Federal Communications Commission Office of Engineering & Technology (FCC OET), "Evaluating Compliance with FCC Guidelines for Human Exposure to Radiofrequency Electromagnetic Fields; Additional Information for Evaluating Compliance of Mobile and Portable Devices with FCC Limits for Human Exposure to Radiofrequency Emissions", Supplement C (Edition 01-01) to Bulletin 65

Additional Documentation:

- d) DASY4/5 System Handbook

Methods Applied and Interpretation of Parameters:

- *Measurement Conditions:* Further details are available from the Validation Report at the end of the certificate. All figures stated in the certificate are valid at the frequency indicated.
- *Antenna Parameters with TSL:* The dipole is mounted with the spacer to position its feed point exactly below the center marking of the flat phantom section, with the arms oriented parallel to the body axis.
- *Feed Point Impedance and Return Loss:* These parameters are measured with the dipole positioned under the liquid filled phantom. The impedance stated is transformed from the measurement at the SMA connector to the feed point. The Return Loss ensures low reflected power. No uncertainty required.
- *Electrical Delay:* One-way delay between the SMA connector and the antenna feed point. No uncertainty required.
- *SAR measured:* SAR measured at the stated antenna input power.
- *SAR normalized:* SAR as measured, normalized to an input power of 1 W at the antenna connector.
- *SAR for nominal TSL parameters:* The measured TSL parameters are used to calculate the nominal SAR result.



Measurement Conditions

DASY system configuration, as far as not given on page 1.

DASY Version	DASY5	V52.8.0
Extrapolation	Advanced Extrapolation	
Phantom	Modular Flat Phantom	
Distance Dipole Center - TSL	10 mm	with Spacer
Zoom Scan Resolution	dx, dy, dz = 5 mm	
Frequency	2450 MHz ± 1 MHz	

Head TSL parameters

The following parameters and calculations were applied.

	Temperature	Permittivity	Conductivity
Nominal Head TSL parameters	22.0 °C	39.2	1.80 mho/m
Measured Head TSL parameters	(22.0 ± 0.2) °C	38.9 ± 6 %	1.86 mho/m ± 6 %
Head TSL temperature change during test	< 0.5 °C	----	----

SAR result with Head TSL

SAR averaged over 1 cm ³ (1 g) of Head TSL	Condition	
SAR measured	250 mW input power	13.6 mW / g
SAR for nominal Head TSL parameters	normalized to 1W	53.5 mW / g ± 17.0 % (k=2)

SAR averaged over 10 cm ³ (10 g) of Head TSL	condition	
SAR measured	250 mW input power	6.26 mW / g
SAR for nominal Head TSL parameters	normalized to 1W	24.8 mW / g ± 16.5 % (k=2)

Body TSL parameters

The following parameters and calculations were applied.

	Temperature	Permittivity	Conductivity
Nominal Body TSL parameters	22.0 °C	52.7	1.95 mho/m
Measured Body TSL parameters	(22.0 ± 0.2) °C	52.3 ± 6 %	2.02 mho/m ± 6 %
Body TSL temperature change during test	< 0.5 °C	----	----

SAR result with Body TSL

SAR averaged over 1 cm ³ (1 g) of Body TSL	Condition	
SAR measured	250 mW input power	12.7 mW / g
SAR for nominal Body TSL parameters	normalized to 1W	49.9 mW / g ± 17.0 % (k=2)

SAR averaged over 10 cm ³ (10 g) of Body TSL	condition	
SAR measured	250 mW input power	5.95 mW / g
SAR for nominal Body TSL parameters	normalized to 1W	23.6 mW / g ± 16.5 % (k=2)



Appendix

Antenna Parameters with Head TSL

Impedance, transformed to feed point	55.0 Ω + 2.5 j Ω
Return Loss	- 25.5 dB

Antenna Parameters with Body TSL

Impedance, transformed to feed point	51.7 Ω + 4.9 j Ω
Return Loss	- 25.8 dB

General Antenna Parameters and Design

Electrical Delay (one direction)	1.144 ns
----------------------------------	----------

After long term use with 100W radiated power, only a slight warming of the dipole near the feedpoint can be measured.

The dipole is made of standard semirigid coaxial cable. The center conductor of the feeding line is directly connected to the second arm of the dipole. The antenna is therefore short-circuited for DC-signals. On some of the dipoles, small end caps are added to the dipole arms in order to improve matching when loaded according to the position as explained in the "Measurement Conditions" paragraph. The SAR data are not affected by this change. The overall dipole length is still according to the Standard.

No excessive force must be applied to the dipole arms, because they might bend or the soldered connections near the feedpoint may be damaged.

Additional EUT Data

Manufactured by	SPEAG
Manufactured on	July 05, 2002

DASY5 Validation Report for Head TSL

Date: 23.02.2012

Test Laboratory: SPEAG, Zurich, Switzerland

DUT: Dipole 2450 MHz; Type: D2450V2; Serial: D2450V2 - SN: 712

Communication System: CW; Frequency: 2450 MHz

Medium parameters used: $f = 2450$ MHz; $\sigma = 1.86$ mho/m; $\epsilon_r = 38.9$; $\rho = 1000$ kg/m³

Phantom section: Flat Section

Measurement Standard: DASY5 (IEEE/IEC/ANSI C63.19-2007)

DASY52 Configuration:

- Probe: ES3DV3 - SN3205; ConvF(4.45, 4.45, 4.45); Calibrated: 30.12.2011
- Sensor-Surface: 3mm (Mechanical Surface Detection)
- Electronics: DAE4 Sn601; Calibrated: 04.07.2011
- Phantom: Flat Phantom 5.0 (front); Type: QD000P50AA; Serial: 1001
- DASY52 52.8.0(692); SEMCAD X 14.6.4(4989)

Dipole Calibration for Head Tissue/Pin=250 mW, d=10mm/Zoom Scan (7x7x7)/Cube 0:

Measurement grid: dx=5mm, dy=5mm, dz=5mm

Reference Value = 100.1 V/m; Power Drift = 0.06 dB

Peak SAR (extrapolated) = 28.3820

SAR(1 g) = 13.6 mW/g; SAR(10 g) = 6.26 mW/g

Maximum value of SAR (measured) = 17.534 mW/g

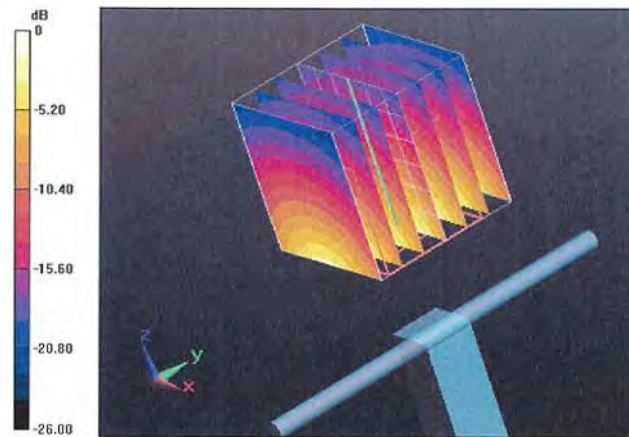

0 dB = 17.530mW/g = 24.88 dB mW/g



Impedance Measurement Plot for Head TSL

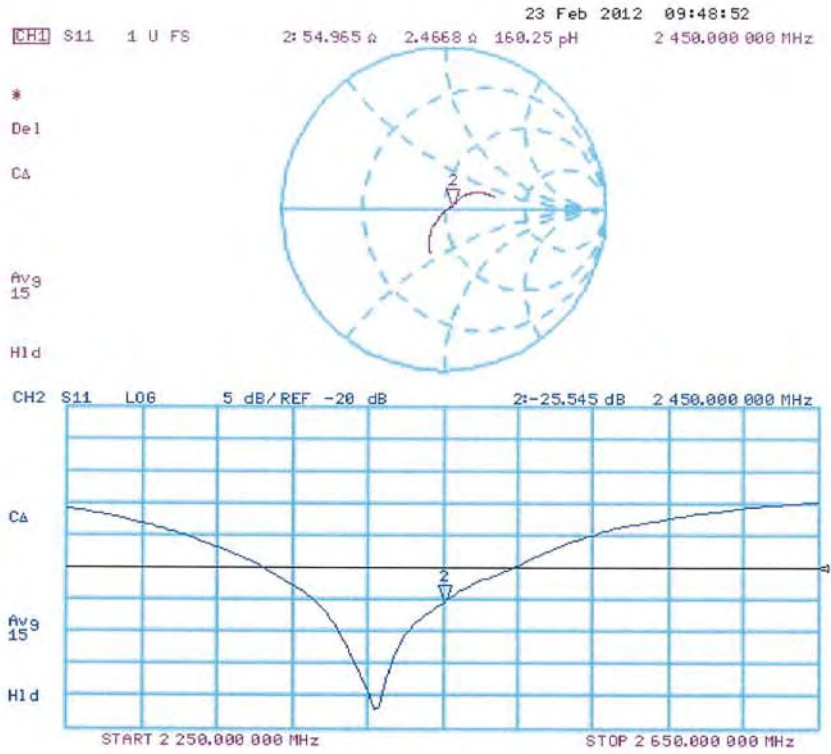

DASY5 Validation Report for Body TSL

Date: 23.02.2012

Test Laboratory: SPEAG, Zurich, Switzerland

DUT: Dipole 2450 MHz; Type: D2450V2; Serial: D2450V2 - SN: 712

Communication System: CW; Frequency: 2450 MHz

Medium parameters used: $f = 2450$ MHz; $\sigma = 2.02$ mho/m; $\epsilon_r = 52.3$; $\rho = 1000$ kg/m³

Phantom section: Flat Section

Measurement Standard: DASY5 (IEEE/IEC/ANSI C63.19-2007)

DASY52 Configuration:

- Probe: ES3DV3 - SN3205; ConvF(4.26, 4.26, 4.26); Calibrated: 30.12.2011
- Sensor-Surface: 3mm (Mechanical Surface Detection)
- Electronics: DAE4 Sn601; Calibrated: 04.07.2011
- Phantom: Flat Phantom 5.0 (back); Type: QD000P50AA; Serial: 1002
- DASY52 52.8.0(692); SEMCAD X 14.6.4(4989)

Dipole Calibration for Body Tissue/Pin=250 mW, d=10mm/Zoom Scan (7x7x7)/Cube 0:

Measurement grid: dx=5mm, dy=5mm, dz=5mm

Reference Value = 94.094 V/m; Power Drift = 0.0032 dB

Peak SAR (extrapolated) = 26.0450

SAR(1 g) = 12.7 mW/g; SAR(10 g) = 5.95 mW/g

Maximum value of SAR (measured) = 16.700 mW/g

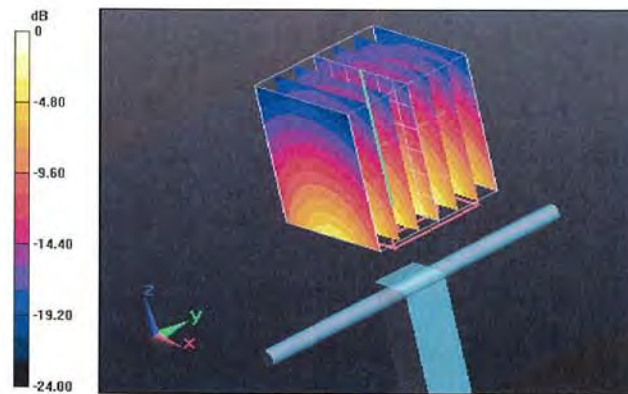

0 dB = 16.700mW/g = 24.45 dB mW/g



Impedance Measurement Plot for Body TSL

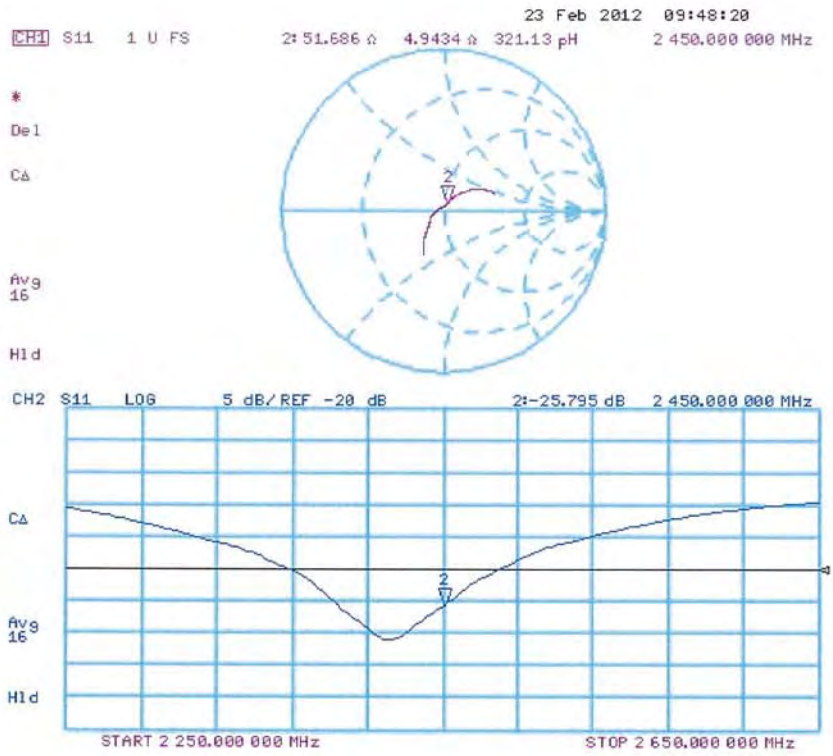



**Calibration Laboratory of
Schmid & Partner
Engineering AG**
Zeughausstrasse 43, 8004 Zurich, Switzerland



S Schweizerischer Kalibrierdienst
S Service suisse d'étalonnage
S Servizio svizzero di taratura
S Swiss Calibration Service

Accredited by the Swiss Accreditation Service (SAS)
The Swiss Accreditation Service is one of the signatories to the EA
Multilateral Agreement for the recognition of calibration certificates

Accreditation No.: **SCS 108**

Client **ATL (Auden)**

Certificate No: **EX3-3847_Mar12**

CALIBRATION CERTIFICATE

Object **EX3DV4 - SN:3847**

Calibration procedure(s) **QA CAL-01.v8, QA CAL-23.v4, QA CAL-25.v4
Calibration procedure for dosimetric E-field probes**

Calibration date: **March 21, 2012**

This calibration certificate documents the traceability to national standards, which realize the physical units of measurements (SI).
The measurements and the uncertainties with confidence probability are given on the following pages and are part of the certificate.

All calibrations have been conducted in the closed laboratory facility: environment temperature (22 ± 3)°C and humidity < 70%.

Calibration Equipment used (M&TE critical for calibration)

Primary Standards	ID	Cal Date (Certificate No.)	Scheduled Calibration
Power meter E4419B	GB41293874	31-Mar-11 (No. 217-01372)	Apr-12
Power sensor E4412A	MY41498087	31-Mar-11 (No. 217-01372)	Apr-12
Reference 3 dB Attenuator	SN: S5054 (3c)	29-Mar-11 (No. 217-01369)	Apr-12
Reference 20 dB Attenuator	SN: S5086 (20b)	29-Mar-11 (No. 217-01367)	Apr-12
Reference 30 dB Attenuator	SN: S5129 (30b)	29-Mar-11 (No. 217-01370)	Apr-12
Reference Probe ES3DV2	SN: 3013	29-Dec-11 (No. ES3-3013_Dec11)	Dec-12
DAE4	SN: 654	3-May-11 (No. DAE4-654_May11)	May-12
Secondary Standards	ID	Check Date (in house)	Scheduled Check
RF generator HP 8648C	US3642U01700	4-Aug-99 (in house check Apr-11)	In house check: Apr-13
Network Analyzer HP 8753E	US37390585	18-Oct-01 (in house check Oct-11)	In house check: Oct-12

	Name	Function	Signature
Calibrated by:	Jeton Kastrati	Laboratory Technician	
Approved by:	Katja Pokovic	Technical Manager	
			Issued: March 21, 2012

This calibration certificate shall not be reproduced except in full without written approval of the laboratory.

Calibration Laboratory of
Schmid & Partner
Engineering AG
Zeughausstrasse 43, 8004 Zurich, Switzerland



S Schweizerischer Kalibrierdienst
C Service suisse d'étalonnage
S Servizio svizzero di taratura
S Swiss Calibration Service

Accredited by the Swiss Accreditation Service (SAS)
The Swiss Accreditation Service is one of the signatories to the EA
Multilateral Agreement for the recognition of calibration certificates

Accreditation No.: SCS 108

Glossary:

TSL	tissue simulating liquid
NORM _{x,y,z}	sensitivity in free space
ConvF	sensitivity in TSL / NORM _{x,y,z}
DCP	diode compression point
CF	crest factor (1/duty_cycle) of the RF signal
A, B, C	modulation dependent linearization parameters
Polarization φ	φ rotation around probe axis
Polarization ϑ	ϑ rotation around an axis that is in the plane normal to probe axis (at measurement center), i.e., $\vartheta = 0$ is normal to probe axis

Calibration is Performed According to the Following Standards:

- a) IEEE Std 1528-2003, "IEEE Recommended Practice for Determining the Peak Spatial-Averaged Specific Absorption Rate (SAR) in the Human Head from Wireless Communications Devices: Measurement Techniques", December 2003
- b) IEC 62209-1, "Procedure to measure the Specific Absorption Rate (SAR) for hand-held devices used in close proximity to the ear (frequency range of 300 MHz to 3 GHz)", February 2005

Methods Applied and Interpretation of Parameters:

- **NORM_{x,y,z}**: Assessed for E-field polarization $\vartheta = 0$ ($f \leq 900$ MHz in TEM-cell; $f > 1800$ MHz: R22 waveguide). NORM_{x,y,z} are only intermediate values, i.e., the uncertainties of NORM_{x,y,z} does not affect the E²-field uncertainty inside TSL (see below ConvF).
- **NORM(f)_{x,y,z}** = NORM_{x,y,z} * frequency_response (see Frequency Response Chart). This linearization is implemented in DASY4 software versions later than 4.2. The uncertainty of the frequency response is included in the stated uncertainty of ConvF.
- **DCP_{x,y,z}**: DCP are numerical linearization parameters assessed based on the data of power sweep with CW signal (no uncertainty required). DCP does not depend on frequency nor media.
- **PAR**: PAR is the Peak to Average Ratio that is not calibrated but determined based on the signal characteristics
- **A_{x,y,z}; B_{x,y,z}; C_{x,y,z}; VR_{x,y,z}**: A, B, C are numerical linearization parameters assessed based on the data of power sweep for specific modulation signal. The parameters do not depend on frequency nor media. VR is the maximum calibration range expressed in RMS voltage across the diode.
- **ConvF and Boundary Effect Parameters**: Assessed in flat phantom using E-field (or Temperature Transfer Standard for $f \leq 800$ MHz) and inside waveguide using analytical field distributions based on power measurements for $f > 800$ MHz. The same setups are used for assessment of the parameters applied for boundary compensation (alpha, depth) of which typical uncertainty values are given. These parameters are used in DASY4 software to improve probe accuracy close to the boundary. The sensitivity in TSL corresponds to NORM_{x,y,z} * ConvF whereby the uncertainty corresponds to that given for ConvF. A frequency dependent ConvF is used in DASY version 4.4 and higher which allows extending the validity from ± 50 MHz to ± 100 MHz.
- **Spherical isotropy (3D deviation from isotropy)**: in a field of low gradients realized using a flat phantom exposed by a patch antenna.
- **Sensor Offset**: The sensor offset corresponds to the offset of virtual measurement center from the probe tip (on probe axis). No tolerance required.



EX3DV4 – SN:3847

March 21, 2012

Probe EX3DV4

SN:3847

Manufactured: October 25, 2011
Calibrated: March 21, 2012

Calibrated for DASY/EASY Systems
(Note: non-compatible with DASY2 system!)



DASY/EASY - Parameters of Probe: EX3DV4 - SN:3847

Basic Calibration Parameters

	Sensor X	Sensor Y	Sensor Z	Unc (k=2)
Norm ($\mu\text{V}/(\text{V}/\text{m})^2$) ^A	0.46	0.35	0.42	$\pm 10.1 \%$
DCP (mV) ^B	100.3	102.1	94.4	

Modulation Calibration Parameters

UID	Communication System Name	PAR		A dB	B dB	C dB	VR mV	Unc ^E (k=2)
10000	CW	0.00	X	0.00	0.00	1.00	112.0	$\pm 3.0 \%$
			Y	0.00	0.00	1.00	94.0	
			Z	0.00	0.00	1.00	112.0	

The reported uncertainty of measurement is stated as the standard uncertainty of measurement multiplied by the coverage factor k=2, which for a normal distribution corresponds to a coverage probability of approximately 95%.

^A The uncertainties of NormX,Y,Z do not affect the E²-field uncertainty inside TSL (see Pages 5 and 6).

^B Numerical linearization parameter: uncertainty not required.

^E Uncertainty is determined using the max. deviation from linear response applying rectangular distribution and is expressed for the square of the field value.



DASY/EASY - Parameters of Probe: EX3DV4 - SN:3847

Calibration Parameter Determined in Head Tissue Simulating Media

f (MHz) ^C	Relative Permittivity ^F	Conductivity (S/m) ^F	ConvF X	ConvF Y	ConvF Z	Alpha	Depth (mm)	Unct. (k=2)
835	41.5	0.90	9.34	9.34	9.34	0.31	1.01	± 12.0 %
900	41.5	0.97	9.19	9.19	9.19	0.17	1.78	± 12.0 %
1750	40.1	1.37	8.29	8.29	8.29	0.64	0.66	± 12.0 %
1900	40.0	1.40	8.05	8.05	8.05	0.80	0.62	± 12.0 %
2450	39.2	1.80	7.17	7.17	7.17	0.47	0.79	± 12.0 %

^C Frequency validity of ± 100 MHz only applies for DASY v4.4 and higher (see Page 2), else it is restricted to ± 50 MHz. The uncertainty is the RSS of the ConvF uncertainty at calibration frequency and the uncertainty for the indicated frequency band.

^F At frequencies below 3 GHz, the validity of tissue parameters (ϵ and σ) can be relaxed to ± 10% if liquid compensation formula is applied to measured SAR values. At frequencies above 3 GHz, the validity of tissue parameters (ϵ and σ) is restricted to ± 5%. The uncertainty is the RSS of the ConvF uncertainty for indicated target tissue parameters.



DASY/EASY - Parameters of Probe: EX3DV4 - SN:3847

Calibration Parameter Determined in Body Tissue Simulating Media

f (MHz) ^C	Relative Permittivity ^F	Conductivity (S/m) ^F	ConvF X	ConvF Y	ConvF Z	Alpha	Depth (mm)	Unct. (k=2)
835	55.2	0.97	9.24	9.24	9.24	0.32	1.02	± 12.0 %
900	55.0	1.05	9.14	9.14	9.14	0.26	1.18	± 12.0 %
1750	53.4	1.49	7.70	7.70	7.70	0.38	1.00	± 12.0 %
1900	53.3	1.52	7.20	7.20	7.20	0.46	0.88	± 12.0 %
2450	52.7	1.95	6.85	6.85	6.85	0.77	0.61	± 12.0 %

^C Frequency validity of ± 100 MHz only applies for DASY v4.4 and higher (see Page 2), else it is restricted to ± 50 MHz. The uncertainty is the RSS of the ConvF uncertainty at calibration frequency and the uncertainty for the indicated frequency band.

^F At frequencies below 3 GHz, the validity of tissue parameters (ϵ and σ) can be relaxed to ± 10% if liquid compensation formula is applied to measured SAR values. At frequencies above 3 GHz, the validity of tissue parameters (ϵ and σ) is restricted to ± 5%. The uncertainty is the RSS of the ConvF uncertainty for indicated target tissue parameters.

Frequency Response of E-Field (TEM-Cell:ifi110 EXX, Waveguide: R22)

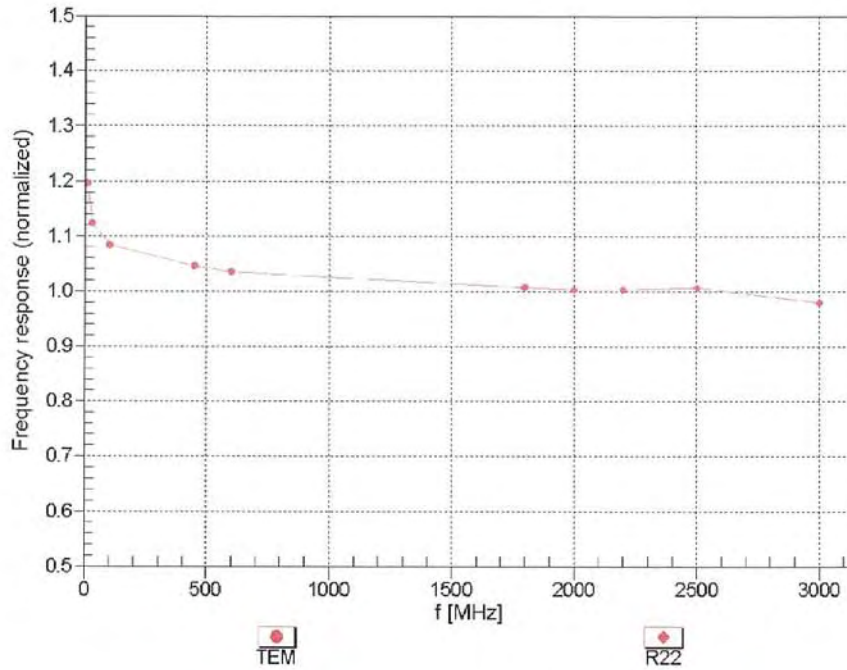

Uncertainty of Frequency Response of E-field: $\pm 6.3\%$ (k=2)

Receiving Pattern (ϕ), $\theta = 0^\circ$

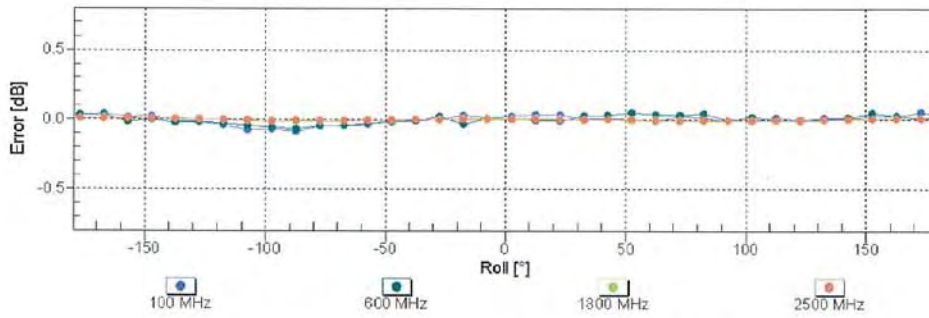
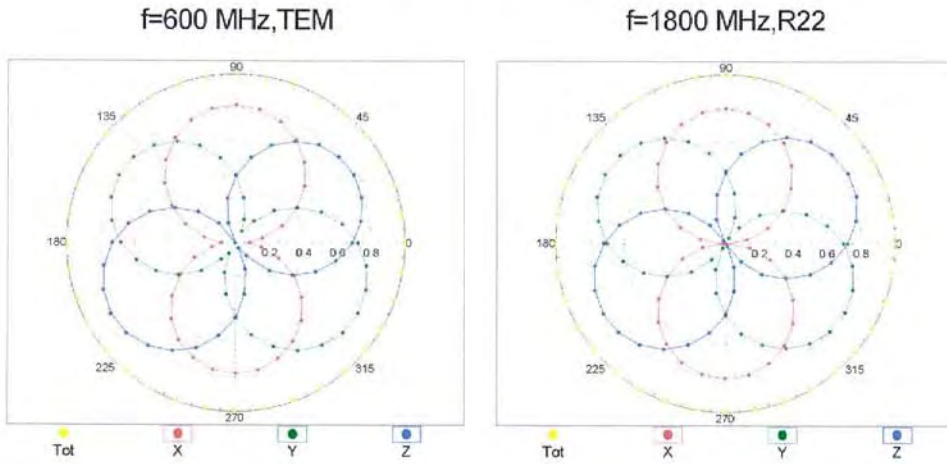

Uncertainty of Axial Isotropy Assessment: $\pm 0.5\%$ (k=2)

Dynamic Range $f(SAR_{head})$ (TEM cell , f = 900 MHz)

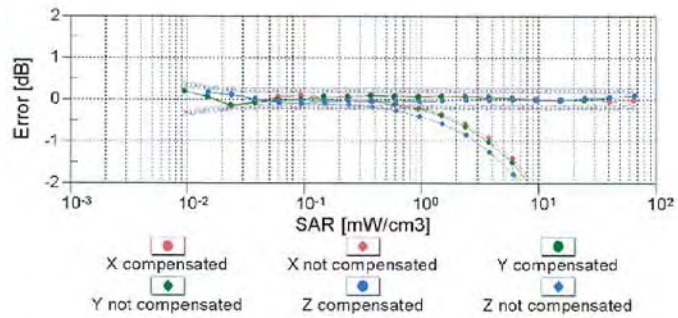
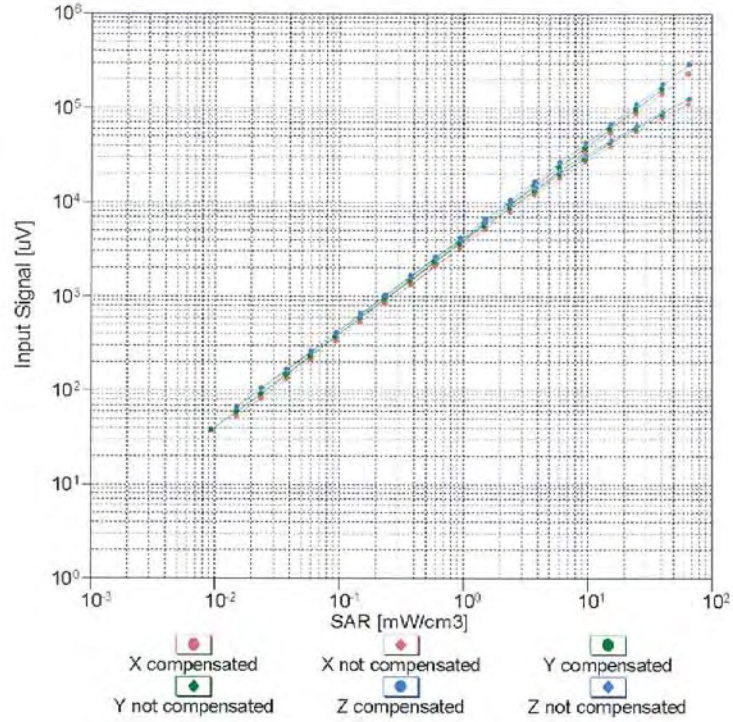

Uncertainty of Linearity Assessment: $\pm 0.6\%$ (k=2)

Conversion Factor Assessment

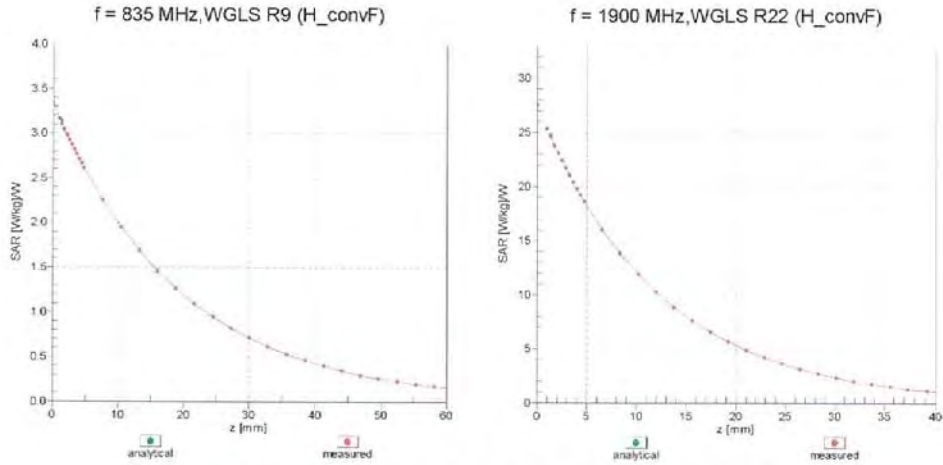

Deviation from Isotropy in Liquid Error (ϕ, ϑ), f = 900 MHz

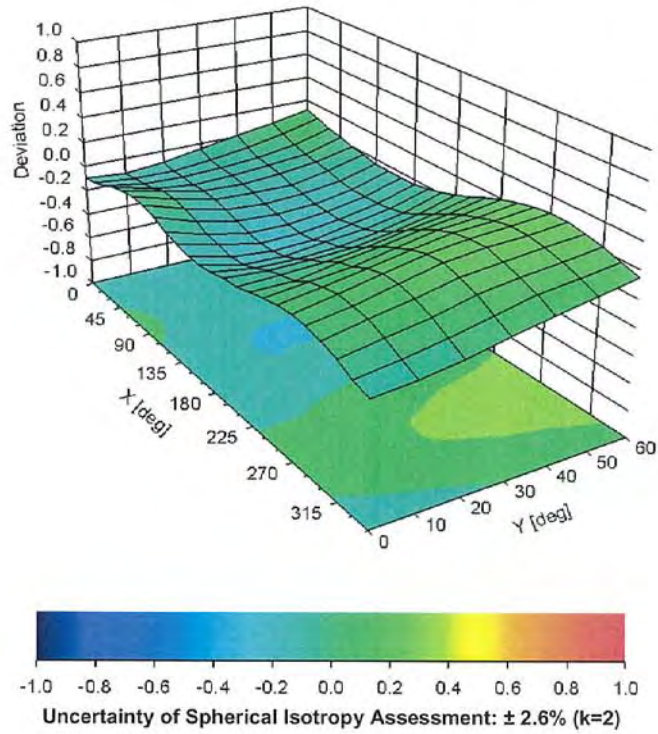



DASY/EASY - Parameters of Probe: EX3DV4 - SN:3847

Other Probe Parameters

Sensor Arrangement	Triangular
Connector Angle (°)	Not applicable
Mechanical Surface Detection Mode	enabled
Optical Surface Detection Mode	disabled
Probe Overall Length	337 mm
Probe Body Diameter	10 mm
Tip Length	9 mm
Tip Diameter	2.5 mm
Probe Tip to Sensor X Calibration Point	1 mm
Probe Tip to Sensor Y Calibration Point	1 mm
Probe Tip to Sensor Z Calibration Point	1 mm
Recommended Measurement Distance from Surface	2 mm



**Calibration Laboratory of
Schmid & Partner
Engineering AG**
Zeughausstrasse 43, 8004 Zurich, Switzerland



S Schweizerischer Kalibrierdienst
C Service suisse d'étalonnage
S Servizio svizzero di taratura
S Swiss Calibration Service

Accredited by the Swiss Accreditation Service (SAS)
The Swiss Accreditation Service is one of the signatories to the EA
Multilateral Agreement for the recognition of calibration certificates

Accreditation No.: **SCS 108**

Client **ATL (Auden)**

Certificate No: **DAE4-779_Jan12**

CALIBRATION CERTIFICATE

Object **DAE4 - SD 000 D04 BJ - SN: 779**

Calibration procedure(s) **QA CAL-06.v24
Calibration procedure for the data acquisition electronics (DAE)**

Calibration date: **January 23, 2012**

This calibration certificate documents the traceability to national standards, which realize the physical units of measurements (SI).
The measurements and the uncertainties with confidence probability are given on the following pages and are part of the certificate.

All calibrations have been conducted in the closed laboratory facility: environment temperature (22 ± 3)°C and humidity < 70%.

Calibration Equipment used (M&TE critical for calibration)

Primary Standards	ID #	Cal Date (Certificate No.)	Scheduled Calibration
Keithley Multimeter Type 2001	SN: 0810278	28-Sep-11 (No:11450)	Sep-12
Secondary Standards	ID #	Check Date (in house)	Scheduled Check
Calibrator Box V2.1	SE UWS 053 AA 1001	05-Jan-12 (in house check)	In house check: Jan-13

	Name	Function	Signature
Calibrated by:	Dominique Steffen	Technician	
Approved by:	Fin Bornholt	R&D Director	

Issued: January 23, 2012

This calibration certificate shall not be reproduced except in full without written approval of the laboratory.

**Calibration Laboratory of
Schmid & Partner
Engineering AG**
Zeughausstrasse 43, 8004 Zurich, Switzerland



S Schweizerischer Kalibrierdienst
C Service suisse d'étalonnage
S Servizio svizzero di taratura
S Swiss Calibration Service

Accredited by the Swiss Accreditation Service (SAS)
The Swiss Accreditation Service is one of the signatories to the EA
Multilateral Agreement for the recognition of calibration certificates

Accreditation No.: **SCS 108**

Glossary

DAE data acquisition electronics
Connector angle information used in DASY system to align probe sensor X to the robot coordinate system.

Methods Applied and Interpretation of Parameters

- *DC Voltage Measurement:* Calibration Factor assessed for use in DASY system by comparison with a calibrated instrument traceable to national standards. The figure given corresponds to the full scale range of the voltmeter in the respective range.
- *Connector angle:* The angle of the connector is assessed measuring the angle mechanically by a tool inserted. Uncertainty is not required.
- The following parameters as documented in the Appendix contain technical information as a result from the performance test and require no uncertainty.
 - *DC Voltage Measurement Linearity:* Verification of the Linearity at +10% and -10% of the nominal calibration voltage. Influence of offset voltage is included in this measurement.
 - *Common mode sensitivity:* Influence of a positive or negative common mode voltage on the differential measurement.
 - *Channel separation:* Influence of a voltage on the neighbor channels not subject to an input voltage.
 - *AD Converter Values with inputs shorted:* Values on the internal AD converter corresponding to zero input voltage
 - *Input Offset Measurement:* Output voltage and statistical results over a large number of zero voltage measurements.
 - *Input Offset Current:* Typical value for information; Maximum channel input offset current, not considering the input resistance.
 - *Input resistance:* Typical value for information: DAE input resistance at the connector, during internal auto-zeroing and during measurement.
 - *Low Battery Alarm Voltage:* Typical value for information. Below this voltage, a battery alarm signal is generated.
 - *Power consumption:* Typical value for information. Supply currents in various operating modes.



DC Voltage Measurement

A/D - Converter Resolution nominal

High Range: 1LSB = 6.1 μ V , full range = -100...+300 mV

Low Range: 1LSB = 61nV , full range = -1.....+3mV

DASY measurement parameters: Auto Zero Time: 3 sec; Measuring time: 3 sec

Calibration Factors	X	Y	Z
High Range	404.578 \pm 0.1% (k=2)	403.737 \pm 0.1% (k=2)	403.961 \pm 0.1% (k=2)
Low Range	3.96952 \pm 0.7% (k=2)	3.97827 \pm 0.7% (k=2)	3.99341 \pm 0.7% (k=2)

Connector Angle

Connector Angle to be used in DASY system	156.5 \pm 1 $^{\circ}$
---	--------------------------



Appendix

1. DC Voltage Linearity

High Range	Reading (μV)	Difference (μV)	Error (%)
Channel X + Input	199992.36	-2.42	-0.00
Channel X + Input	20002.90	2.80	0.01
Channel X - Input	-19995.39	5.40	-0.03
Channel Y + Input	199995.92	1.48	0.00
Channel Y + Input	20002.78	2.85	0.01
Channel Y - Input	-19998.45	2.56	-0.01
Channel Z + Input	199992.89	-1.72	-0.00
Channel Z + Input	19998.87	-1.11	-0.01
Channel Z - Input	-20000.07	0.90	-0.00

Low Range	Reading (μV)	Difference (μV)	Error (%)
Channel X + Input	1998.52	-1.94	-0.10
Channel X + Input	200.77	-0.18	-0.09
Channel X - Input	-199.69	-0.83	0.42
Channel Y + Input	1999.48	-0.80	-0.04
Channel Y + Input	200.34	-0.55	-0.27
Channel Y - Input	-198.10	0.97	-0.49
Channel Z + Input	1998.95	-1.37	-0.07
Channel Z + Input	199.48	-1.44	-0.71
Channel Z - Input	-199.41	-0.31	0.16

2. Common mode sensitivity

DASY measurement parameters: Auto Zero Time: 3 sec; Measuring time: 3 sec

	Common mode Input Voltage (mV)	High Range Average Reading (μV)	Low Range Average Reading (μV)
Channel X	200	-4.09	-4.76
	-200	6.36	4.04
Channel Y	200	14.06	13.41
	-200	-14.67	-14.92
Channel Z	200	3.23	1.98
	-200	-5.02	-4.73

3. Channel separation

DASY measurement parameters: Auto Zero Time: 3 sec; Measuring time: 3 sec

	Input Voltage (mV)	Channel X (μV)	Channel Y (μV)	Channel Z (μV)
Channel X	200	-	-1.52	-1.21
Channel Y	200	12.10	-	-1.51
Channel Z	200	0.25	12.60	-



4. AD-Converter Values with inputs shorted

DASY measurement parameters: Auto Zero Time: 3 sec; Measuring time: 3 sec

	High Range (LSB)	Low Range (LSB)
Channel X	15627	16393
Channel Y	15845	15908
Channel Z	16157	16150

5. Input Offset Measurement

DASY measurement parameters: Auto Zero Time: 3 sec; Measuring time: 3 sec

Input 10M Ω

	Average (μ V)	min. Offset (μ V)	max. Offset (μ V)	Std. Deviation (μ V)
Channel X	-1.27	-2.39	-0.17	0.45
Channel Y	0.05	-1.36	2.93	0.64
Channel Z	-1.16	-2.45	-0.25	0.41

6. Input Offset Current

Nominal Input circuitry offset current on all channels: <25fA

7. Input Resistance (Typical values for information)

	Zeroing (kOhm)	Measuring (MOhm)
Channel X	200	200
Channel Y	200	200
Channel Z	200	200

8. Low Battery Alarm Voltage (Typical values for information)

Typical values	Alarm Level (VDC)
Supply (+ Vcc)	+7.9
Supply (- Vcc)	-7.6

9. Power Consumption (Typical values for information)

Typical values	Switched off (mA)	Stand by (mA)	Transmitting (mA)
Supply (+ Vcc)	+0.01	+6	+14
Supply (- Vcc)	-0.01	-8	-9