



# FCC RF Test Report

**APPLICANT** : HTC Corporation  
**EQUIPMENT** : Windows Phone  
**MODEL NAME** : PM59110  
**FCC ID** : NM8PM59110  
**STANDARD** : FCC 47 CFR Part 2, 22(H), 24(E), 27(L)  
**CLASSIFICATION** : PCS Licensed Transmitter Held to Ear (PCE)

The product was received on Sep. 20, 2012 and completely tested on Oct. 20, 2012. We, SPORTON INTERNATIONAL INC., would like to declare that the tested sample has been evaluated in accordance with the procedures given in ANSI / TIA / EIA-603-C-2004 and shown compliance with the applicable technical standards.

The test results in this report apply exclusively to the tested model / sample. Without written approval of SPORTON INTERNATIONAL INC., the test report shall not be reproduced except in full.

Reviewed by:

Jones Tsai / Manager



## **SPORTON INTERNATIONAL INC.**

No. 52, Hwa Ya 1<sup>st</sup> Rd., Hwa Ya Technology Park, Kwei-Shan Hsiang, Tao Yuan Hsien, Taiwan, R.O.C.



# TABLE OF CONTENTS

**REVISION HISTORY..... 3**

**SUMMARY OF TEST RESULT ..... 4**

**1 GENERAL DESCRIPTION ..... 5**

    1.1 Applicant..... 5

    1.2 Manufacturer ..... 5

    1.3 Feature of Equipment Under Test..... 5

    1.4 Maximum ERP/EIRP Power, Frequency Tolerance, and Emission Designator ..... 6

    1.5 Testing Site..... 7

    1.6 Applied Standards ..... 7

    1.7 Ancillary Equipment List ..... 7

**2 TEST CONFIGURATION OF EQUIPMENT UNDER TEST ..... 8**

    2.1 Test Mode..... 8

    2.2 Connection Diagram of Test System ..... 10

**3 TEST RESULT ..... 11**

    3.1 Conducted Output Power Measurement..... 11

    3.2 Peak-to-Average Ratio ..... 13

    3.3 Effective Radiated Power and Effective Isotropic Radiated Power Measurement ..... 23

    3.4 Occupied Bandwidth and 26dB Bandwidth Measurement..... 30

    3.5 Band Edge Measurement..... 54

    3.6 Conducted Spurious Emission Measurement..... 69

    3.7 Field Strength of Spurious Radiation Measurement ..... 88

    3.8 Frequency Stability Measurement..... 111

**4 LIST OF MEASURING EQUIPMENTS..... 117**

**5 UNCERTAINTY OF EVALUATION ..... 118**

**APPENDIX A. SETUP PHOTOGRAPHS**





## SUMMARY OF TEST RESULT

Report Section	FCC Rule	IC Rule	Description	Limit	Result	Remark
3.1	§2.1046	N/A	Conducted Output Power	N/A	PASS	-
3.2	§24.232(d) §27.50(d)(5)	N/A	Peak-to-Average Ratio	< 13 dB	PASS	-
3.3	§22.913(a)(2)	RSS-132(4.4) SRSP-503(5.1.3)	Effective Radiated Power	< 7 Watts	PASS	-
3.3	§24.232(c)	RSS-133 (6.4) SRSP-510(5.1.2)	Equivalent Isotropic Radiated Power	< 2 Watts	PASS	-
3.3	§27.50(d)(4)	RSS-139 (6.4) SRSP-513(5.1.2)	Equivalent Isotropic Radiated Power	< 1 Watts	PASS	-
3.4	§2.1049 §22.917(a) §24.238(a) §27.53(h)	N/A	Occupied Bandwidth	N/A	PASS	-
3.5	§2.1051 §22.917(a) §24.238(a) §27.53(h)	RSS-132 (4.5.1) RSS-133 (6.5.1) RSS-139 (6.5)	Band Edge Measurement	< 43+10log <sub>10</sub> (P[Watts])	PASS	-
3.6	§2.1051 §22.917(a) §24.238(a) §27.53(h)	RSS-132 (4.5.1) RSS-133 (6.5.1) RSS-139 (6.5)	Conducted Emission	< 43+10log <sub>10</sub> (P[Watts])	PASS	-
3.7	§2.1053 §22.917(a) §24.238(a) §27.53(h)	RSS-132 (4.5.1) RSS-133 (6.5.1) RSS-139 (6.5)	Field Strength of Spurious Radiation	< 43+10log <sub>10</sub> (P[Watts])	PASS	Under limit 16.49 dB at 2509.000 MHz
3.8	§2.1055 §22.355 §24.235 §27.54	RSS-132 (4.3) RSS-133 (6.3) RSS-139 (6.3)	Frequency Stability for Temperature & Voltage	< 2.5 ppm	PASS	-

# 1 General Description

## 1.1 Applicant

HTC Corporation

No.23, Xinghua Rd., Taoyuan City, Taoyuan County 330, Taiwan.

## 1.2 Manufacturer

HTC Corporation

No.23, Xinghua Rd., Taoyuan City, Taoyuan County 330, Taiwan.

## 1.3 Feature of Equipment Under Test

Product Feature	
Equipment	Windows Phone
Model Name	PM59110
Sample 1	EUT with LCM, Main Camera 1 and Battery 1
Sample 2	EUT with LCM, Main Camera 2 and Battery 2
FCC ID	NM8PM59110
EUT supports Radios application	GSM / GPRS / EGPRS / WCDMA / HSPA / WLAN 11bgn/ Bluetooth
EUT Stage	Production Unit

**Remark:** The above EUT's information was declared by manufacturer. Please refer to the specifications or user's manual for more detailed description.



Product Specification subjective to this standard	
<b>Tx Frequency</b>	GSM850: 824.2 MHz ~ 848.8 MHz GSM1900: 1850.2 MHz ~ 1909.8MHz WCDMA Band V: 826.4 MHz ~ 846.6 MHz WCDMA Band IV : 1712.4 MHz ~ 1752.6 MHz WCDMA Band II: 1852.4 MHz ~ 1907.6 MHz
<b>Rx Frequency</b>	GSM850: 869.2 MHz ~ 893.8 MHz GSM1900: 1930.2 MHz ~ 1989.8 MHz WCDMA Band V: 871.4 MHz ~ 891.6 MHz WCDMA Band IV : 2112.4 MHz ~ 2152.6 MHz WCDMA Band II : 1932.4 MHz ~ 1987.6 MHz
<b>Maximum Output Power to Antenna</b>	GSM850 : 33.36 dBm GSM1900 : 30.40 dBm WCDMA Band V : 23.78 dBm WCDMA Band IV : 23.58 dBm WCDMA Band II : 23.77 dBm
<b>Antenna Type</b>	PIFA Antenna
<b>Type of Modulation</b>	GSM: GMSK GPRS: GMSK EDGE: GMSK / 8PSK WCDMA: QPSK (Uplink) HSDPA: QPSK (Uplink) HSUPA: QPSK (Uplink)

### 1.4 Maximum ERP/EIRP Power, Frequency Tolerance, and Emission Designator

FCC Rule	System	Type of Modulation	Maximum ERP/EIRP (W)	Frequency Tolerance (% , Hz, ppm)	Emission Designator
Part 22	GSM850 GSM	GMSK	0.8472	0.06 ppm	246KGXW
Part 22	GSM850 EDGE 8	8PSK	0.2489	0.06 ppm	246KG7W
Part 22	WCDMA Band V RMC 12.2Kbps	QPSK	0.0951	0.01 ppm	4M20F9W
Part 24	GSM1900 GSM	GMSK	1.1561	0.03 ppm	246KGXW
Part 24	GSM1900 EDGE 8	8PSK	0.4875	0.03 ppm	248KG7W
Part 24	WCDMA Band II RMC 12.2Kbps	QPSK	0.2218	0.01 ppm	4M18F9W
Part 27	WCDMA Band IV RMC 12.2Kbps	QPSK	0.3342	0.01 ppm	4M18F9W

## 1.5 Testing Site

<b>Test Site</b>	SPORTON INTERNATIONAL INC.		
<b>Test Site Location</b>	No. 52, Hwa Ya 1 <sup>st</sup> Rd., Hwa Ya Technology Park, Kwei-Shan Hsiang, Tao Yuan Hsien, Taiwan, R.O.C. TEL: +886-3-327-3456 FAX: +886-3-328-4978		
<b>Test Site No.</b>	<b>Sporton Site No.</b>		<b>FCC/IC Registration No.</b>
	TH03-HY	03CH05-HY	722060/4086B-1

## 1.6 Applied Standards

According to the specifications of the manufacturer, the EUT must comply with the requirements of the following standards:

- ♦ Preliminary Guidance for Receiving Applications for Certification of 3G Device. May 9, 2006.
- ♦ 47 CFR Part 2, 22(H), 24(E), 27(L)
- ♦ ANSI / TIA / EIA-603-C-2004
- ♦ FCC KDB 971168 D01 Power Meas. License Digital Systems v01
- ♦ IC RSS-132 Issue 2
- ♦ IC RSS-133 Issue 5
- ♦ IC RSS-139 Issue 2

**Remark:**

1. All test items were verified and recorded according to the standards and without any deviation during the test.
2. This EUT has also been tested and complied with the requirements of FCC Part 15, Subpart B, recorded in a separate test report.

## 1.7 Ancillary Equipment List

Item	Equipment	Trade Name	Model No.	FCC ID	Data Cable	Power Cord
1.	System Simulator	R&S	CMU200	N/A	N/A	Unshielded, 1.8 m

## 2 Test Configuration of Equipment Under Test

### 2.1 Test Mode

During all testing, EUT is in link mode with base station emulator at maximum power level. The spurious emission measurements were carried out in semi-anechoic chamber with 3-meter test range, and EUT is rotated on three test planes to find out the worst emission.

Frequency range investigated for radiated emission is as follows:

1. 30 MHz to 9000 MHz for GSM850 and WCDMA Band V.
2. 30 MHz to 18000 MHz for WCDMA Band IV.
3. 30 MHz to 19000 MHz for GSM1900 and WCDMA Band II.

Test Modes		
Band	Radiated TCs	Conducted TCs
<b>GSM 850</b>	<ul style="list-style-type: none"> <li>■ GSM Link for Sample 1</li> <li>■ GSM Link for Sample 2</li> <li>■ EDGE 8 Link for Sample 1</li> </ul>	<ul style="list-style-type: none"> <li>■ GSM Link</li> <li>■ EDGE 8 Link</li> </ul>
<b>GSM 1900</b>	<ul style="list-style-type: none"> <li>■ GSM Link for Sample 1</li> <li>■ GSM Link for Sample 2</li> <li>■ EDGE 8 Link for Sample 1</li> </ul>	<ul style="list-style-type: none"> <li>■ GSM Link</li> <li>■ EDGE 8 Link</li> </ul>
<b>WCDMA Band V</b>	<ul style="list-style-type: none"> <li>■ RMC 12.2Kbps Link for Sample 1</li> </ul>	<ul style="list-style-type: none"> <li>■ RMC 12.2Kbps Link</li> </ul>
<b>WCDMA Band IV</b>	<ul style="list-style-type: none"> <li>■ RMC 12.2Kbps Link for Sample 1</li> <li>■ RMC 12.2Kbps Link for Sample 2</li> </ul>	<ul style="list-style-type: none"> <li>■ RMC 12.2Kbps Link</li> </ul>
<b>WCDMA Band II</b>	<ul style="list-style-type: none"> <li>■ RMC 12.2Kbps Link for Sample 1</li> </ul>	<ul style="list-style-type: none"> <li>■ RMC 12.2Kbps Link</li> </ul>

**Note:**

1. The maximum power levels are GSM mode for GMSK link, EDGE multi-slot class 8 mode for 8PSK link, RMC 12.2Kbps mode for WCDMA band V, RMC 12.2Kbps mode for WCDMA band IV, and RMC 12.2Kbps mode for WCDMA band II, only these modes were used for all tests.
2. Because there are individual antennas for each WWAN, WLAN, and Bluetooth, the co-location test modes are not required.





The conducted power tables are as follows:

Conducted Power (*Unit: dBm)						
Band	GSM850			GSM1900		
Channel	128	189	251	512	661	810
Frequency	824.2	836.4	848.8	1850.2	1880	1909.8
GSM	33.13	33.27	33.36	30.18	30.40	30.27
GPRS 8	33.08	33.19	33.27	30.10	30.34	30.22
GPRS 10	31.00	31.02	31.11	28.80	29.20	29.07
GPRS 12	27.82	27.90	28.03	25.42	25.72	25.62
EGPRS 8	27.25	27.27	27.28	26.20	26.67	26.42
EGPRS 10	26.06	26.11	26.12	25.06	25.58	25.26
EGPRS 12	24.73	24.80	24.83	22.79	23.26	23.01

Conducted Power (*Unit: dBm)									
Band	WCDMA Band V			WCDMA Band II			WCDMA Band IV		
Tx Channel	4132	4182	4233	9262	9400	9538	1312	1413	1513
Rx Channel	4357	4408	4458	9662	9800	9938	1537	1638	1738
Frequency	826.4	836.4	846.6	1852.4	1880	1907.6	1712.4	1732.6	1752.6
RMC 12.2K	23.78	23.67	23.64	23.66	23.77	23.68	23.54	23.58	23.48
HSDPA Subtest-1	23.10	23.07	23.00	22.70	22.78	22.72	22.80	22.82	22.69
HSDPA Subtest-2	23.16	23.07	23.07	22.67	22.72	22.60	22.77	22.90	22.82
HSDPA Subtest-3	22.71	22.61	22.51	22.19	22.29	22.28	22.30	22.33	22.31
HSDPA Subtest-4	22.58	22.57	22.53	22.10	22.28	22.21	22.33	22.34	22.23
HSUPA Subtest-1	22.63	22.34	22.59	22.71	23.11	22.77	22.88	23.08	22.70
HSUPA Subtest-2	22.22	21.88	22.22	21.76	21.84	21.83	21.93	22.40	21.86
HSUPA Subtest-3	21.76	21.63	21.48	21.71	21.94	21.80	21.81	21.90	21.74
HSUPA Subtest-4	22.48	22.17	22.43	21.96	22.29	22.21	21.90	22.36	21.95
HSUPA Subtest-5	23.21	23.03	23.05	22.91	23.06	22.90	23.05	23.10	22.96

## 2.2 Connection Diagram of Test System

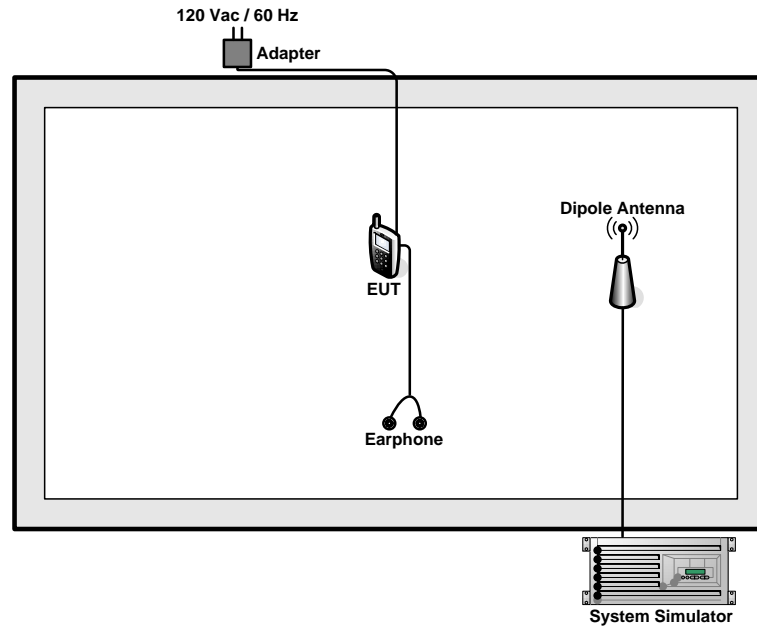

### 3 Test Result

#### 3.1 Conducted Output Power Measurement

##### 3.1.1 Description of the Conducted Output Power Measurement

A base station simulator was used to establish communication with the EUT. Its parameters were set to transmit the maximum power on the EUT. The measured power in the radio frequency on the transmitter output terminals shall be reported.

##### 3.1.2 Measuring Instruments

See list of measuring instruments of this test report.

##### 3.1.3 Test Procedures

1. The transmitter output port was connected to base station.
2. Set EUT at maximum power through base station.
3. Select lowest, middle, and highest channels for each band and different modulation.
4. Compare each band and different modulation combination to show the worst data rate.

##### 3.1.4 Test Setup

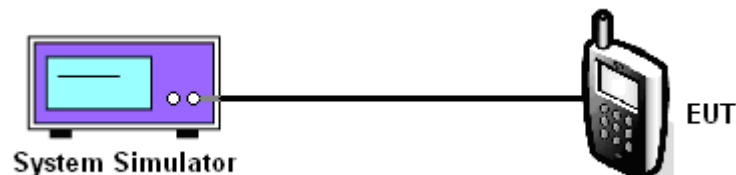

3.1.5 Test Result of Conducted Output Power

Cellular Band									
Modes	GSM850 (GSM)			GSM850 (EDGE 8)			WCDMA Band V (RMC 12.2Kbps)		
Channel	128 (Low)	189 (Mid)	251 (High)	128 (Low)	189 (Mid)	251 (High)	4132 (Low)	4182 (Mid)	4233 (High)
Frequency (MHz)	824.2	836.4	848.8	824.2	836.4	848.8	826.4	836.4	846.6
Conducted Power (dBm)	33.13	33.27	33.36	27.25	27.27	27.28	23.78	23.67	23.64
Conducted Power (Watts)	2.06	2.12	2.17	0.53	0.53	0.53	0.24	0.23	0.23

PCS Band									
Modes	GSM1900 (GSM)			GSM1900 (EDGE 8)			WCDMA Band II (RMC 12.2Kbps)		
Channel	512 (Low)	661 (Mid)	810 (High)	512 (Low)	661 (Mid)	810 (High)	9262 (Low)	9400 (Mid)	9538 (High)
Frequency (MHz)	1850.2	1880	1909.8	1850.2	1880	1909.8	1852.4	1880	1907.6
Conducted Power (dBm)	30.18	30.40	30.27	26.20	26.67	26.42	23.66	23.77	23.68
Conducted Power (Watts)	1.04	1.10	1.06	0.42	0.46	0.44	0.23	0.24	0.23

AWS Band			
Modes	WCDMA Band IV (RMC 12.2Kbps)		
Channel	1312(Low)	1413 (Mid)	1513 (High)
Frequency (MHz)	1712.4	1732.6	1752.6
Conducted Power (dBm)	23.54	23.58	23.48
Conducted Power (Watts)	0.23	0.23	0.22

Note: maximum burst average power for GSM, and maximum average power for WCDMA.

## **3.2 Peak-to-Average Ratio**

### **3.2.1 Description of the PAR Measurement**

The peak-to-average ratio (PAR) of the transmission may not exceed 13 dB.

### **3.2.2 Measuring Instruments**

See list of measuring instruments of this test report.

### **3.2.3 Test Procedures**

1. The EUT was connected to Spectrum Analyzer and Base Station via power divider.
2. The RF output of EUT was connected to the spectrum analyzer by RF cable and attenuator. The path loss was compensated to the results for each measurement.
3. For GSM/EGPRS operating modes:
  - a. Set the RBW = 1MHz, VBW = 1MHz, Peak detector in spectrum analyzer.
  - b. Set EUT in maximum power output, and triggered the burst signal.
  - c. Measured respectively the Peak level and Mean level, and the deviation was recorded as Peak to Average Ratio.
4. For UMTS operating modes:
  - a. Set the CCDF (Complementary Cumulative Distribution Function) option in spectrum analyzer.
  - b. The highest RF powers were measured and recorded the maximum PAPR level associated with a probability of 0.1 %.

### 3.2.4 Test Setup

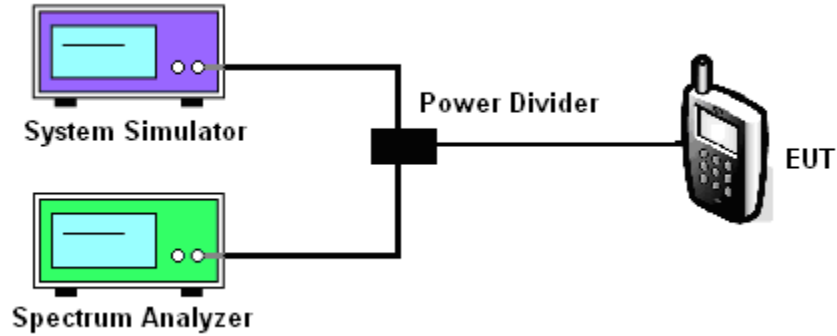

### 3.2.5 Test Result of Peak-to-Average Ratio

PCS Band									
Modes	GSM1900 (GSM)			GSM1900 (EDGE 8)			WCDMA Band II (RMC 12.2Kbps)		
Channel	512 (Low)	661 (Mid)	810 (High)	512 (Low)	661 (Mid)	810 (High)	9262 (Low)	9400 (Mid)	9538 (High)
Frequency (MHz)	1850.2	1880	1909.8	1850.2	1880	1909.8	1852.4	1880	1907.6
Peak-to-Average Ratio (dB)	0.14	0.11	0.11	0.54	0.51	0.46	2.68	2.80	2.96

AWS Band			
Modes	WCDMA Band IV (RMC 12.2Kbps)		
Channel	1312(Low)	1413 (Mid)	1513 (High)
Frequency (MHz)	1712.4	1732.6	1752.6
Peak-to-Average Ratio (dB)	2.88	2.92	2.96



### 3.2.6 Test Result (Plots) of Peak-to-Average Ratio

Band :	GSM 1900	Test Mode :	GSM Link
--------	----------	-------------	----------

Peak-to-Average Ratio on Channel 512 (1850.2 MHz)

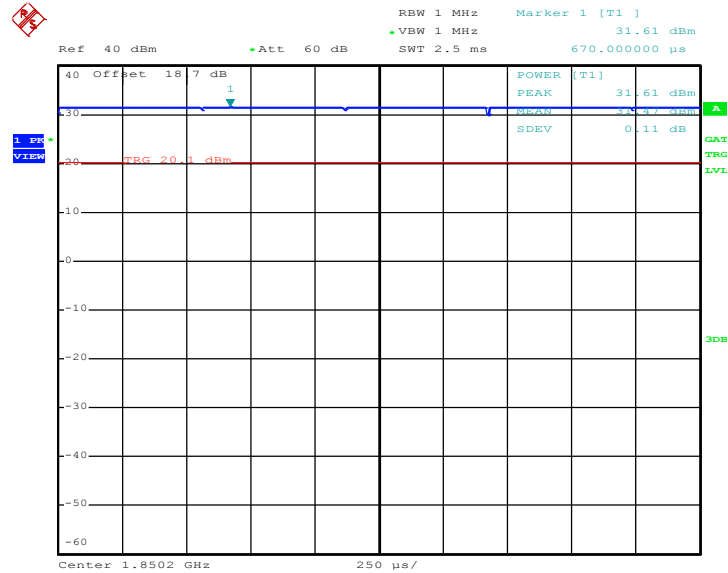

Date: 8.OCT.2012 14:58:47

Peak-to-Average Ratio on Channel 661 (1880.0 MHz)

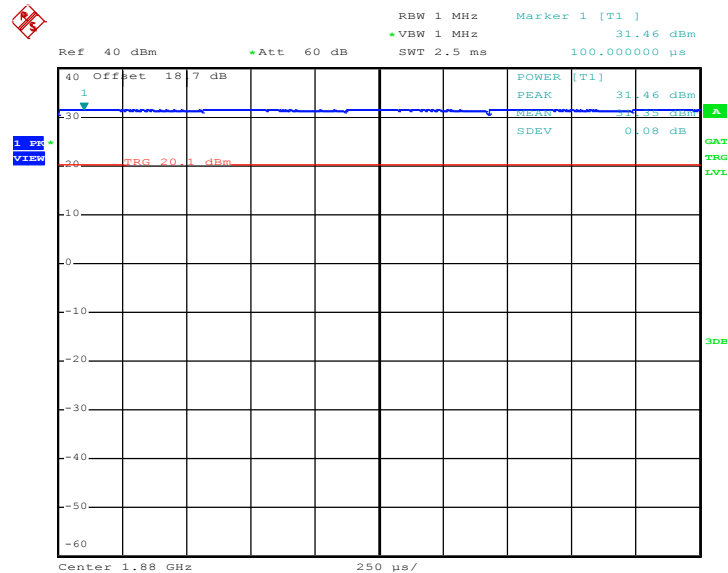

Date: 8.OCT.2012 14:59:28



Peak-to-Average Ratio on Channel 810 (1909.8 MHz)

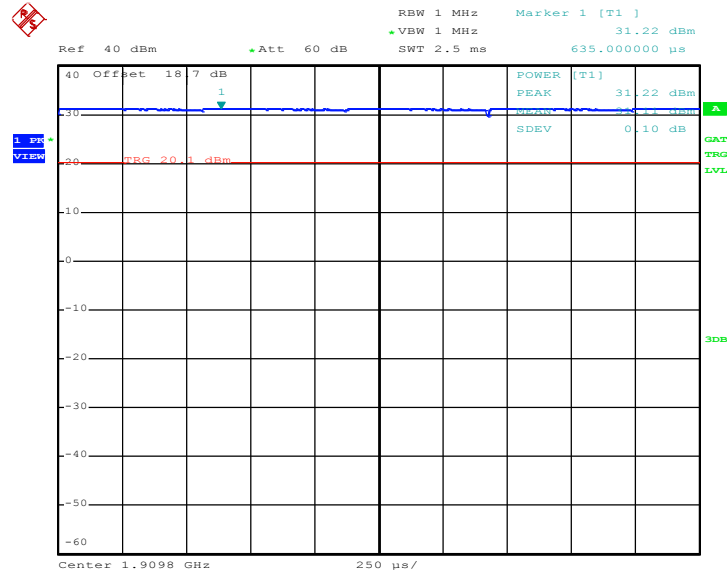

Date: 8.OCT.2012 14:59:58





Band :	GSM 1900	Test Mode :	EDGE 8 Link
--------	----------	-------------	-------------

Peak-to-Average Ratio on Channel 512 (1850.2 MHz)

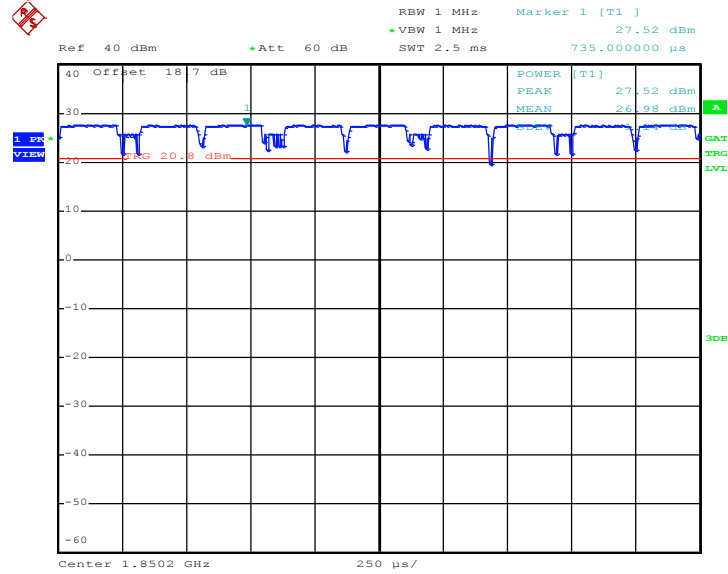

Date: 8.OCT.2012 14:30:30

Peak-to-Average Ratio on Channel 661 (1880.0 MHz)

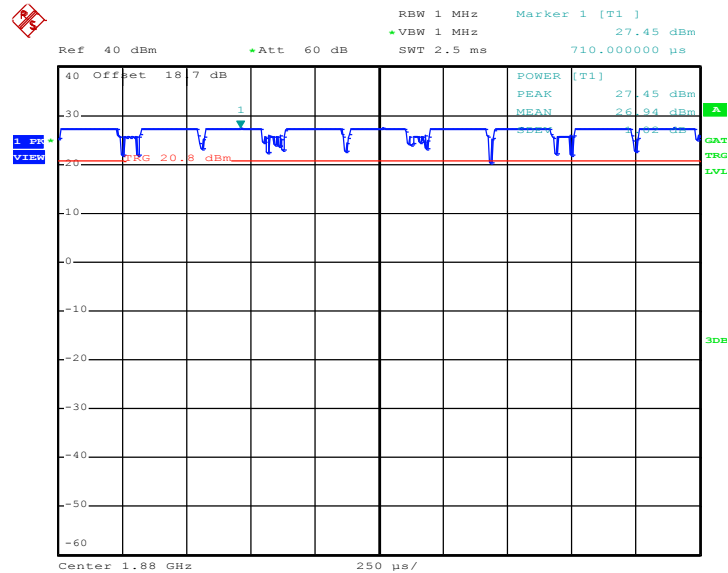

Date: 8.OCT.2012 14:29:48



Peak-to-Average Ratio on Channel 810 (1909.8 MHz)

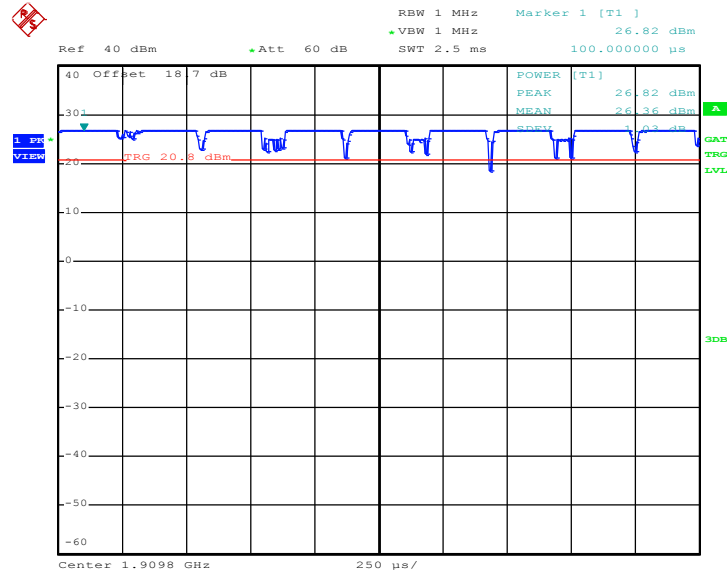

Date: 8.OCT.2012 14:29:01



<b>Band :</b>	WCDMA Band IV	<b>Test Mode :</b>	RMC 12.2Kbps Link
---------------	---------------	--------------------	-------------------

**Peak-to-Average Ratio on Channel 1312 (1712.4 MHz)**

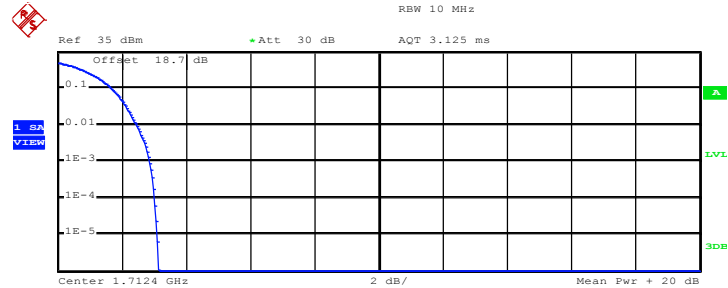

Complementary Cumulative Distribution Function (100000 samples)

Trace 1  
Mean 24.40 dBm  
Peak 27.56 dBm  
Crest 3.16 dB

10 %	1.68 dB
1 %	2.48 dB
.1 %	2.88 dB
.01 %	3.04 dB

Date: 8.OCT.2012 15:32:46

**Peak-to-Average Ratio on Channel 1413 (1732.6 MHz)**

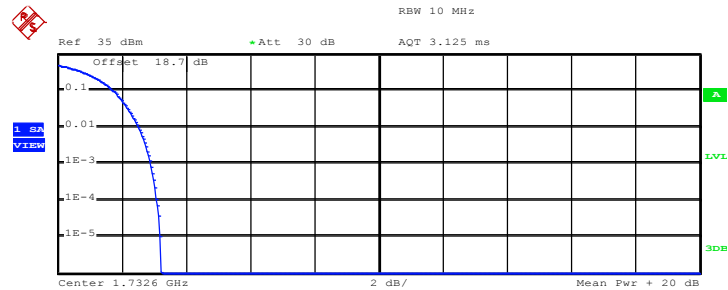

Complementary Cumulative Distribution Function (100000 samples)

Trace 1  
Mean 24.50 dBm  
Peak 27.70 dBm  
Crest 3.21 dB

10 %	1.76 dB
1 %	2.52 dB
.1 %	2.92 dB
.01 %	3.08 dB

Date: 8.OCT.2012 15:33:41



Peak-to-Average Ratio on Channel 1513 (1752.6 MHz)

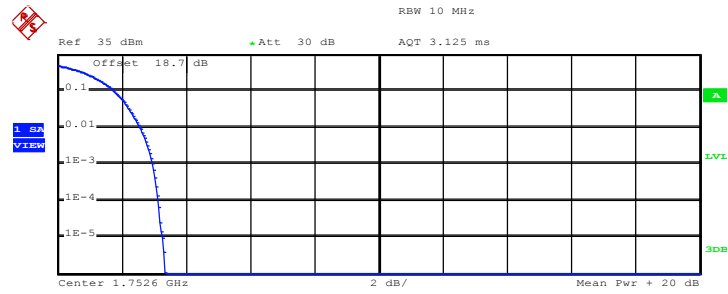

Complementary Cumulative Distribution Function (100000 samples)

Trace 1	
Mean	25.14 dBm
Peak	28.48 dBm
Crest	3.34 dB
10 %	1.76 dB
1 %	2.60 dB
.1 %	2.96 dB
.01 %	3.16 dB

Date: 8.OCT.2012 15:34:38



<b>Band :</b>	WCDMA Band II	<b>Test Mode :</b>	RMC 12.2Kbps Link
---------------	---------------	--------------------	-------------------

**Peak-to-Average Ratio on Channel 9262 (1852.4 MHz)**

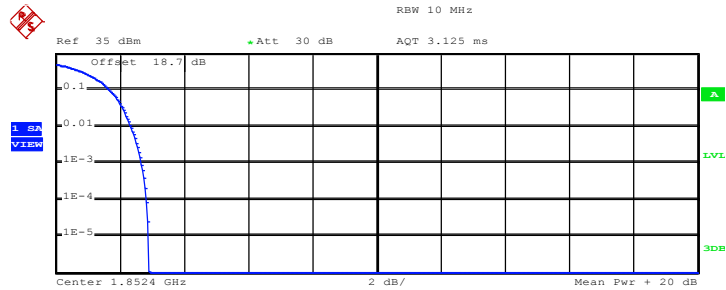

Complementary Cumulative Distribution Function (100000 samples)  
 Trace 1  
 Mean 24.74 dBm  
 Peak 27.63 dBm  
 Crest 2.89 dB

10 %	1.68 dB
1 %	2.36 dB
.1 %	2.68 dB
.01 %	2.84 dB

Date: 8.OCT.2012 15:28:28

**Peak-to-Average Ratio on Channel 9400 (1880.0 MHz)**

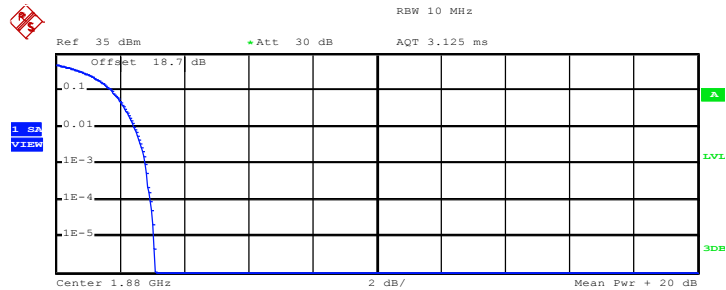

Complementary Cumulative Distribution Function (100000 samples)  
 Trace 1  
 Mean 24.69 dBm  
 Peak 27.78 dBm  
 Crest 3.09 dB

10 %	1.76 dB
1 %	2.44 dB
.1 %	2.80 dB
.01 %	2.96 dB

Date: 8.OCT.2012 15:27:09



Peak-to-Average Ratio on Channel 9538 (1907.6 MHz)

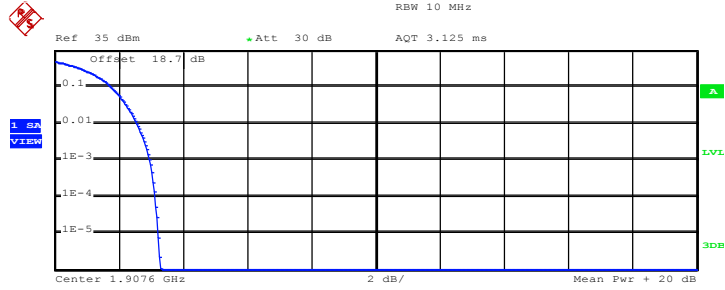

Complementary Cumulative Distribution Function (100000 samples)

Trace 1	
Mean	24.34 dBm
Peak	27.63 dBm
Crest	3.29 dB
10 %	1.76 dB
1 %	2.56 dB
.1 %	2.96 dB
.01 %	3.12 dB

Date: 8.OCT.2012 15:27:57



### **3.3 Effective Radiated Power and Effective Isotropic Radiated Power Measurement**

#### **3.3.1 Description of the ERP/EIRP Measurement**

The substitution method, in ANSI / TIA / EIA-603-C-2004, was used for ERP/EIRP measurement, and the spectrum analyzer configuration follows KDB 971168 D01 Power Meas. License Digital Systems v01. The ERP of mobile transmitters must not exceed 7 Watts and the EIRP of mobile transmitters are limited to 2 Watts.

#### **3.3.2 Measuring Instruments**

See list of measuring instruments of this test report.

#### **3.3.3 Test Procedures**

1. The EUT was placed on a non-conductive rotating platform with 0.8 meter height in a semi-anechoic chamber. The radiated emission at the fundamental frequency was measured at 3 m with a test antenna and a spectrum analyzer with RBW= 30kHz, VBW= 100kHz, and RMS detector settings per section 4.0 of KDB 971168 D01.
2. During the measurement, the EUT was enforced in maximum power and linked with a base station. The highest emission was recorded from analyzer power level (LVL) from the 360 degrees rotation of the turntable and the test antenna raised and lowered over a range from 1 to 4 meters in both horizontally and vertically polarized orientations.
3. Effective Isotropic Radiated Power (EIRP) was measured by substitution method according to TIA/EIA-603-C. The EUT was replaced by dipole antenna (substitution antenna) at same location, and then a known power from S.G. was applied into the dipole antenna through a Tx cable, and then recorded the maximum Analyzer reading through raised and lowered the test antenna. The correction factor (in dB) = S.G. - Tx Cable loss + Substitution antenna gain - Analyzer reading. Then the EUT's EIRP was calculated with the correction factor,  $EIRP = LVL + \text{Correction factor}$  and  $ERP = EIRP - 2.15$ .

### 3.3.4 Test Setup

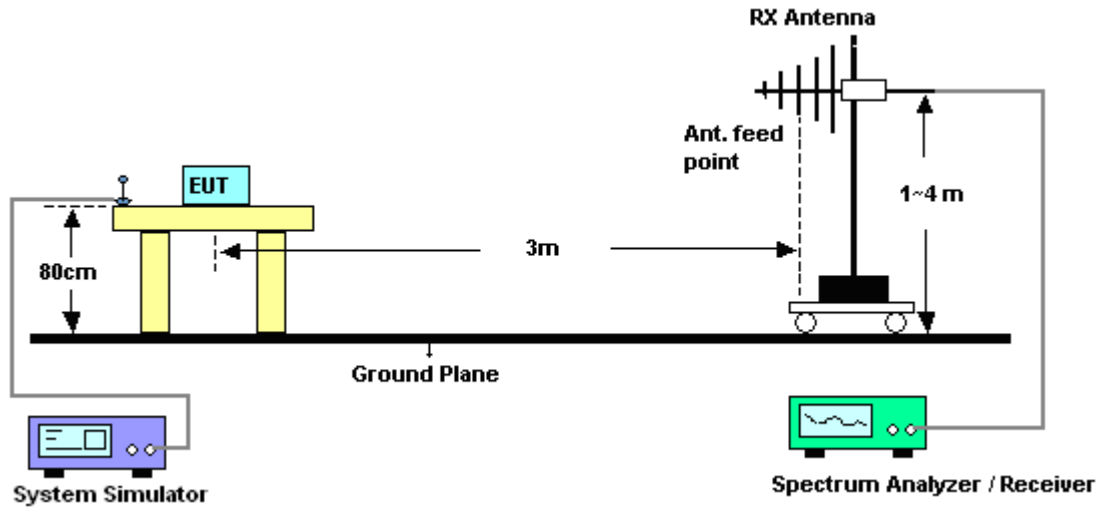



3.3.5 Test Result of ERP

<Sample1>

GSM850 (GSM) Radiated Power ERP				
Horizontal Polarization				
Frequency (MHz)	LVL (dBm)	Correction Factor (dB)	ERP (dBm)	ERP (W)
824.2	0.44	30.99	29.28	0.8472
836.4	0.11	30.89	28.85	0.7674
848.8	-0.44	31.22	28.63	0.7295
Vertical Polarization				
Frequency (MHz)	LVL (dBm)	Correction Factor (dB)	ERP (dBm)	ERP (W)
824.2	-7.42	34.67	25.10	0.3236
836.4	-7.97	34.88	24.76	0.2992
848.8	-8.13	34.74	24.46	0.2793

\* ERP = LVL (dBm) + Correction Factor (dB) – 2.15

GSM850 (EDGE 8) Radiated Power ERP				
Horizontal Polarization				
Frequency (MHz)	LVL (dBm)	Correction Factor (dB)	ERP (dBm)	ERP (W)
824.2	-4.88	30.99	23.96	0.2489
836.4	-5.08	30.89	23.66	0.2323
848.8	-5.66	31.22	23.41	0.2193
Vertical Polarization				
Frequency (MHz)	LVL (dBm)	Correction Factor (dB)	ERP (dBm)	ERP (W)
824.2	-12.85	34.67	19.67	0.0927
836.4	-13.44	34.88	19.29	0.0849
848.8	-13.75	34.74	18.84	0.0766

\* ERP = LVL (dBm) + Correction Factor (dB) – 2.15



WCDMA Band V (RMC 12.2Kbps) Radiated Power ERP				
Horizontal Polarization				
Frequency (MHz)	LVL (dBm)	Correction Factor (dB)	ERP (dBm)	ERP (W)
826.4	-8.81	30.74	19.78	0.0951
836.4	-9.37	30.89	19.37	0.0865
846.6	-10.04	31.29	19.10	0.0813
Vertical Polarization				
Frequency (MHz)	LVL (dBm)	Correction Factor (dB)	ERP (dBm)	ERP (W)
826.4	-17.10	34.94	15.69	0.0371
836.4	-17.28	34.88	15.45	0.0351
846.6	-17.80	34.67	14.72	0.0296

\* ERP = LVL (dBm) + Correction Factor (dB) – 2.15

<Sample2>

GSM850 (GSM) Radiated Power ERP				
Horizontal Polarization				
Frequency (MHz)	LVL (dBm)	Correction Factor (dB)	ERP (dBm)	ERP (W)
824.2	-0.32	30.99	28.52	0.7112
836.4	0.10	30.89	28.84	0.7656
848.8	-0.13	31.22	28.94	0.7834
Vertical Polarization				
Frequency (MHz)	LVL (dBm)	Correction Factor (dB)	ERP (dBm)	ERP (W)
824.2	-6.43	34.67	26.09	0.4064
836.4	-5.40	34.88	27.33	0.5408
848.8	-5.25	34.74	27.34	0.5420

\* ERP = LVL (dBm) + Correction Factor (dB) – 2.15

3.3.6 Test Result of EIRP

<Sample1>

GSM1900 (GSM) Radiated Power EIRP				
Horizontal Polarization				
Frequency (MHz)	LVL (dBm)	Correction Factor (dB)	EIRP (dBm)	EIRP (W)
1850.2	-11.27	40.70	29.43	0.8770
1880.0	-11.89	41.91	30.02	1.0046
1909.8	-11.10	41.73	30.63	1.1561
Vertical Polarization				
Frequency (MHz)	LVL (dBm)	Correction Factor (dB)	EIRP (dBm)	EIRP (W)
1850.2	-19.80	42.78	22.98	0.1986
1880.0	-19.72	43.75	24.03	0.2529
1909.8	-18.60	43.06	24.46	0.2793

\* EIRP = LVL (dBm) + Correction Factor (dB)

GSM1900 (EDGE 8) Radiated Power EIRP				
Horizontal Polarization				
Frequency (MHz)	LVL (dBm)	Correction Factor (dB)	EIRP (dBm)	EIRP (W)
1850.2	-15.10	40.70	25.60	0.3631
1880.0	-15.31	41.91	26.60	0.4571
1909.8	-14.85	41.73	26.88	0.4875
Vertical Polarization				
Frequency (MHz)	LVL (dBm)	Correction Factor (dB)	EIRP (dBm)	EIRP (W)
1850.2	-23.56	42.78	19.22	0.0836
1880.0	-23.30	43.75	20.45	0.1109
1909.8	-22.24	43.06	20.82	0.1208

\* EIRP = LVL (dBm) + Correction Factor (dB)



WCDMA Band IV (RMC 12.2Kbps) Radiated Power EIRP				
Horizontal Polarization				
Frequency (MHz)	LVL (dBm)	Correction Factor (dB)	EIRP (dBm)	EIRP (W)
1712.4	-17.77	39.34	21.57	0.1435
1732.6	-17.45	39.89	22.44	0.1754
1752.6	-16.99	39.86	22.87	0.1936
Vertical Polarization				
Frequency (MHz)	LVL (dBm)	Correction Factor (dB)	EIRP (dBm)	EIRP (W)
1712.4	-18.34	42.85	24.51	0.2825
1732.6	-17.43	42.13	24.70	0.2951
1752.6	-16.35	41.59	25.24	0.3342

\* EIRP = LVL (dBm) + Correction Factor (dB)

WCDMA Band II (RMC 12.2Kbps) Radiated Power EIRP				
Horizontal Polarization				
Frequency (MHz)	LVL (dBm)	Correction Factor (dB)	EIRP (dBm)	EIRP (W)
1852.4	-18.19	40.40	22.21	0.1663
1880.0	-18.45	41.91	23.46	0.2218
1907.6	-18.40	41.59	23.19	0.2084
Vertical Polarization				
Frequency (MHz)	LVL (dBm)	Correction Factor (dB)	EIRP (dBm)	EIRP (W)
1852.4	-26.58	42.69	16.11	0.0408
1880.0	-26.48	43.75	17.27	0.0533
1907.6	-26.13	43.02	16.89	0.0489

\* EIRP = LVL (dBm) + Correction Factor (dB)



<Sample2>

GSM1900 (GSM) Radiated Power EIRP				
Horizontal Polarization				
Frequency (MHz)	LVL (dBm)	Correction Factor (dB)	EIRP (dBm)	EIRP (W)
1850.2	-11.09	40.70	29.61	0.9141
1880.0	-11.54	41.91	30.37	1.0889
1909.8	-11.27	41.73	30.46	1.1117
Vertical Polarization				
Frequency (MHz)	LVL (dBm)	Correction Factor (dB)	EIRP (dBm)	EIRP (W)
1850.2	-14.96	42.78	27.82	0.6053
1880.0	-14.98	43.75	28.77	0.7534
1909.8	-14.12	43.06	28.94	0.7834

\* EIRP = LVL (dBm) + Correction Factor (dB)

WCDMA Band IV (RMC 12.2Kbps) Radiated Power EIRP				
Horizontal Polarization				
Frequency (MHz)	LVL (dBm)	Correction Factor (dB)	EIRP (dBm)	EIRP (W)
1712.4	-15.36	39.34	23.98	0.2500
1732.6	-16.07	39.89	23.82	0.2410
1752.6	-15.96	39.86	23.90	0.2455
Vertical Polarization				
Frequency (MHz)	LVL (dBm)	Correction Factor (dB)	EIRP (dBm)	EIRP (W)
1712.4	-22.64	42.85	20.21	0.1050
1732.6	-22.70	42.13	19.43	0.0877
1752.6	-21.97	41.59	19.62	0.0916

\* EIRP = LVL (dBm) + Correction Factor (dB)

## 3.4 Occupied Bandwidth and 26dB Bandwidth Measurement

### 3.4.1 Description of Occupied Bandwidth and 26dB Bandwidth Measurement

The occupied bandwidth is the width of a frequency band such that, below the lower and above the upper frequency limits, the mean powers emitted are each equal to a specified percentage 0.5% of the total mean transmitted power.

The emission bandwidth is defined as the width of the signal between two points, located at the 2 sides of the carrier frequency, outside of which all emissions are attenuated at least 26 dB below the transmitter power.

### 3.4.2 Measuring Instruments

See list of measuring instruments of this test report.

### 3.4.3 Test Procedures

1. The EUT was connected to Spectrum Analyzer and Base Station via power divider.
2. The RF output of EUT was connected to the spectrum analyzer by RF cable and attenuator. The path loss was compensated to the results for each measurement.
3. The 99% occupied bandwidth and 26 dB bandwidth of the middle channel for the highest RF powers were measured.

### 3.4.4 Test Setup

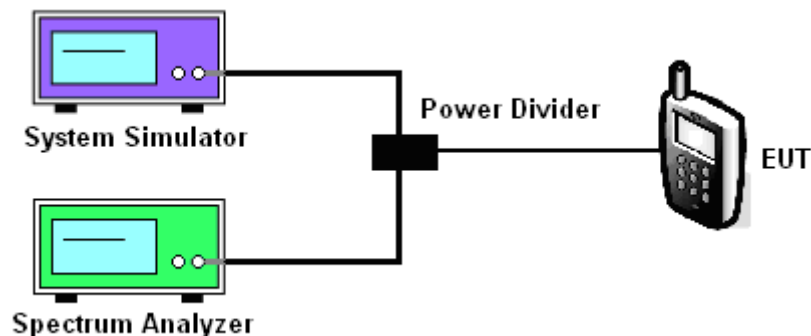



3.4.5 Test Result of Occupied Bandwidth and 26dB Bandwidth

Cellular Band						
Modes	GSM850 (GSM)			GSM850 (EDGE 8)		
Channel	128 (Low)	189 (Mid)	251 (High)	128 (Low)	189 (Mid)	251 (High)
Frequency (MHz)	824.2	836.4	848.8	824.2	836.4	848.8
99% OBW (KHz)	238.00	246.00	242.00	246.00	246.00	242.00
26dB BW (KHz)	298.00	302.00	302.00	294.00	306.00	302.00

PCS Band						
Modes	GSM1900 (GSM)			GSM1900 (EDGE 8)		
Channel	512 (Low)	661 (Mid)	810 (High)	512 (Low)	661 (Mid)	810 (High)
Frequency (MHz)	1850.2	1880	1909.8	1850.2	1880	1909.8
99% OBW (KHz)	244.00	246.00	244.00	240.00	248.00	242.00
26dB BW (KHz)	302.00	302.00	296.00	290.00	308.00	302.00



<b>Cellular Band</b>			
<b>Modes</b>	<b>WCDMA Band V (RMC 12.2Kbps)</b>		
<b>Channel</b>	<b>4132 (Low)</b>	<b>4182 (Mid)</b>	<b>4233 (High)</b>
<b>Frequency (MHz)</b>	<b>826.4</b>	<b>836.4</b>	<b>846.6</b>
<b>99% OBW (MHz)</b>	4.14	4.20	4.18
<b>26dB BW (MHz)</b>	4.68	4.70	4.68

<b>AWS Band</b>			
<b>Modes</b>	<b>WCDMA Band IV (RMC 12.2Kbps)</b>		
<b>Channel</b>	<b>1312(Low)</b>	<b>1413 (Mid)</b>	<b>1513 (High)</b>
<b>Frequency (MHz)</b>	<b>1712.4</b>	<b>1732.6</b>	<b>1752.6</b>
<b>99% OBW (MHz)</b>	4.18	4.16	4.18
<b>26dB BW (MHz)</b>	4.68	4.68	4.68

<b>PCS Band</b>			
<b>Modes</b>	<b>WCDMA Band II (RMC 12.2Kbps)</b>		
<b>Channel</b>	<b>9262 (Low)</b>	<b>9400 (Mid)</b>	<b>9538 (High)</b>
<b>Frequency (MHz)</b>	<b>1852.4</b>	<b>1880.0</b>	<b>1907.6</b>
<b>99% OBW (MHz)</b>	4.16	4.18	4.16
<b>26dB BW (MHz)</b>	4.68	4.68	4.68





### 3.4.6 Test Result (Plots) of Occupied Bandwidth and 26dB Bandwidth

Band :	GSM 850	Test Mode :	GSM Link
--------	---------	-------------	----------

99% Occupied Bandwidth Plot on Channel 128 (824.2 MHz)

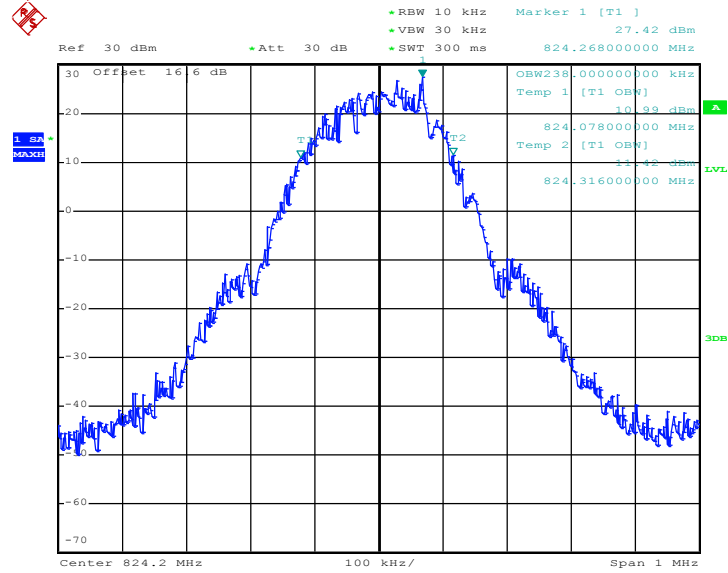

Date: 8.OCT.2012 11:25:33

26dB Bandwidth Plot on Channel 128 (824.2 MHz)

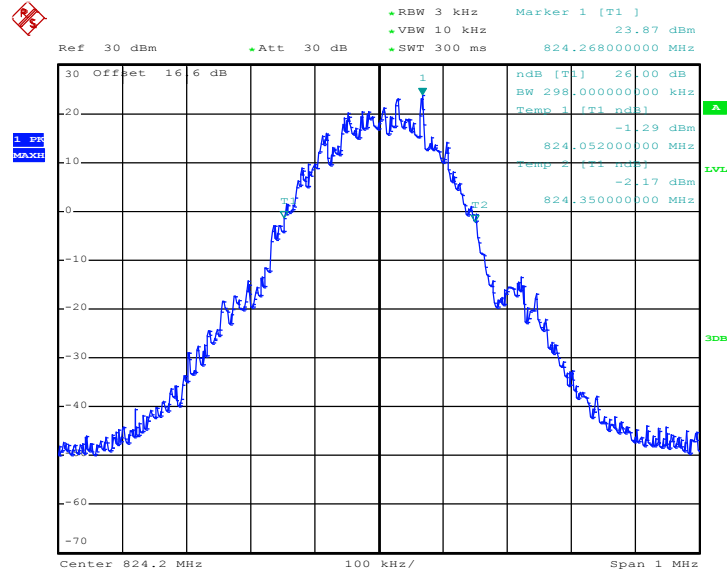

Date: 8.OCT.2012 11:24:14



99% Occupied Bandwidth Plot on Channel 189 (836.4 MHz)

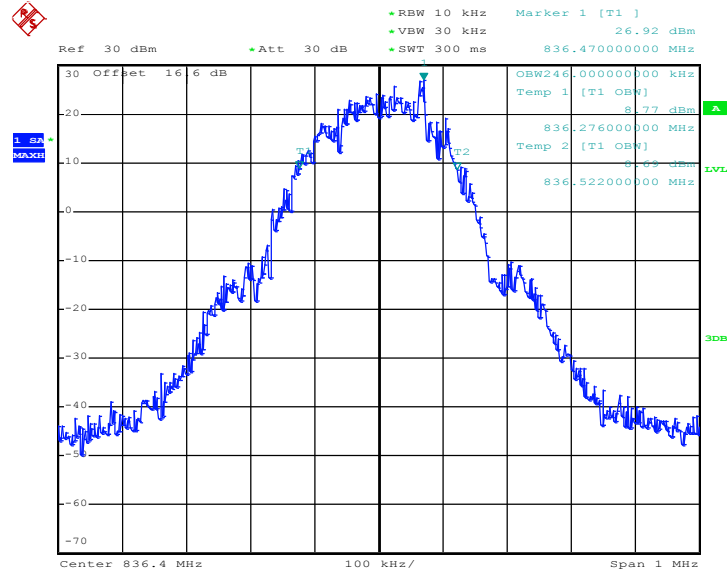

Date: 8.OCT.2012 11:25:58

26dB Bandwidth Plot on Channel 189 (836.4 MHz)

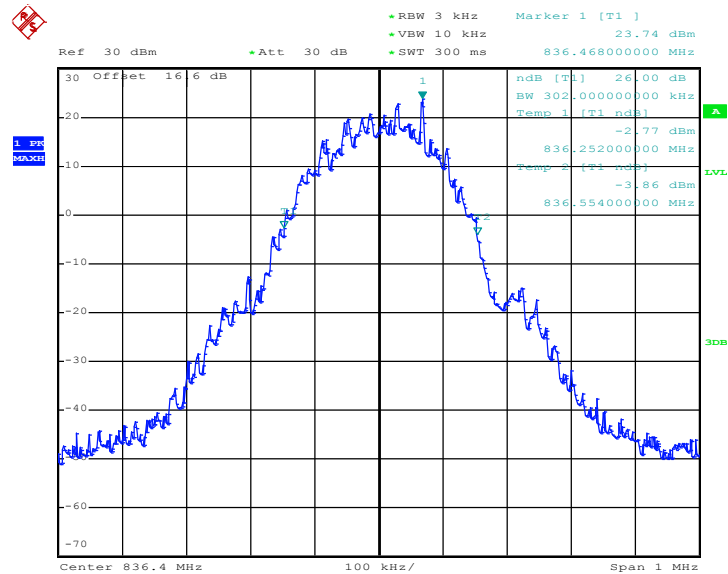

Date: 8.OCT.2012 11:24:40



99% Occupied Bandwidth Plot on Channel 251 (848.8 MHz)

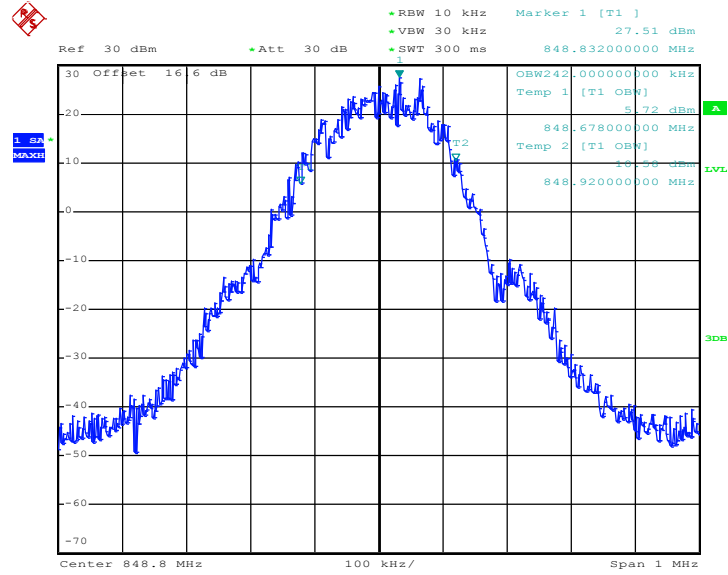

Date: 8.OCT.2012 11:26:24

26dB Bandwidth Plot on Channel 251 (848.8 MHz)

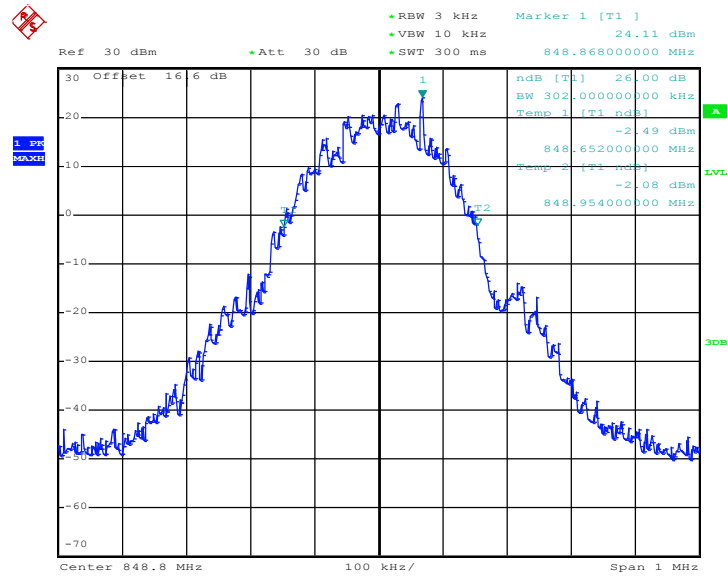

Date: 8.OCT.2012 11:25:06



Band :	GSM 850	Test Mode :	EDGE 8 Link
--------	---------	-------------	-------------

99% Occupied Bandwidth Plot on Channel 128 (824.2 MHz)

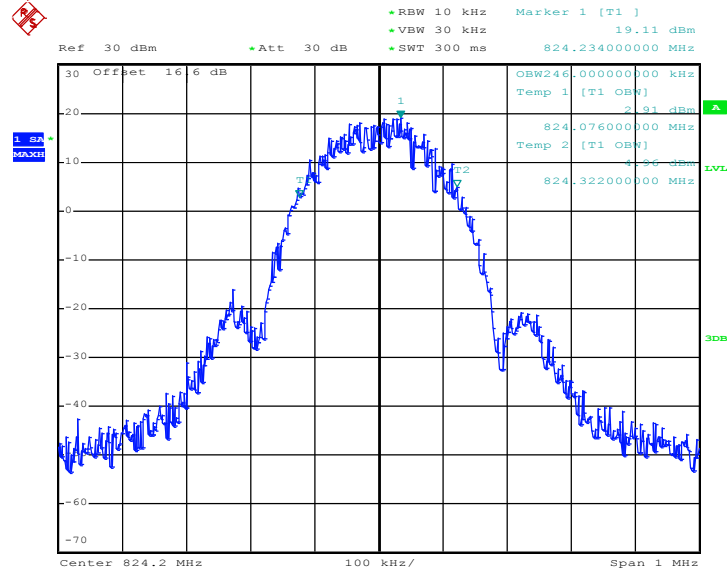

Date: 8.OCT.2012 13:38:04

26dB Bandwidth Plot on Channel 128 (824.2 MHz)

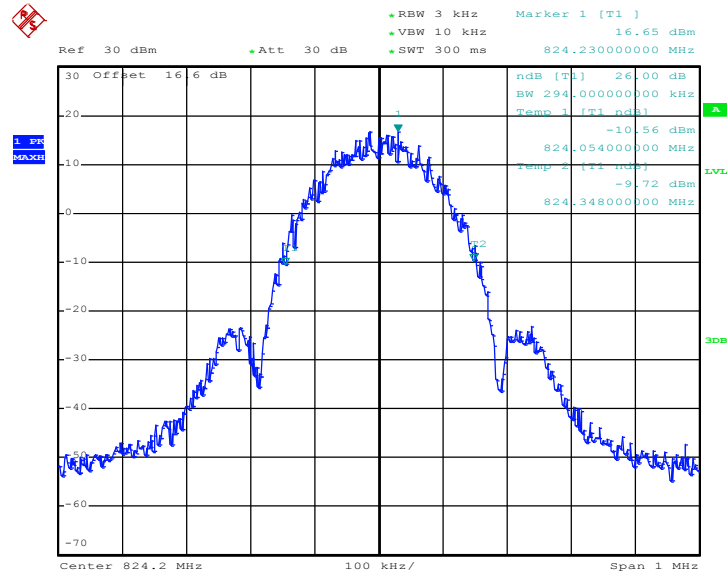

Date: 8.OCT.2012 13:36:45



### 99% Occupied Bandwidth Plot on Channel 189 (836.4 MHz)

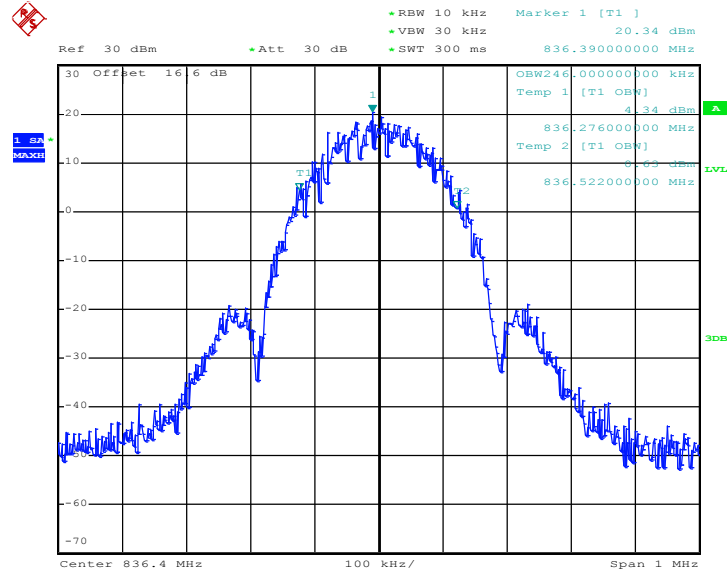

Date: 8.OCT.2012 13:38:30

### 26dB Bandwidth Plot on Channel 189 (836.4 MHz)

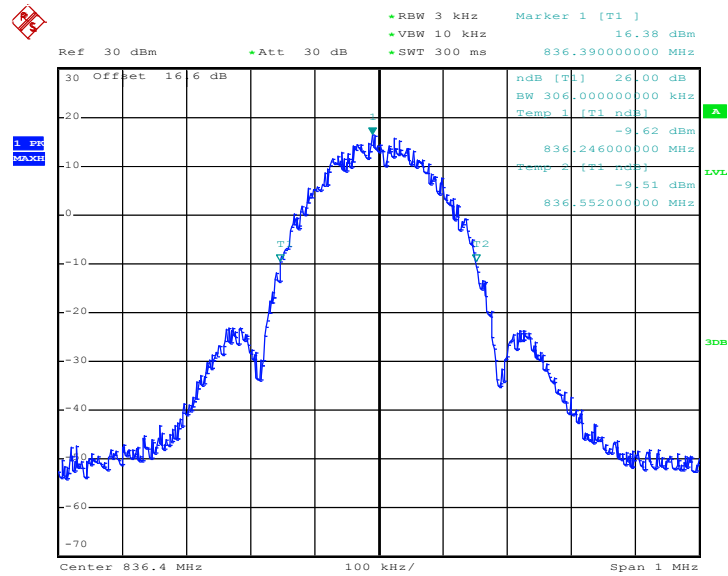

Date: 8.OCT.2012 13:37:11



99% Occupied Bandwidth Plot on Channel 251 (848.8 MHz)

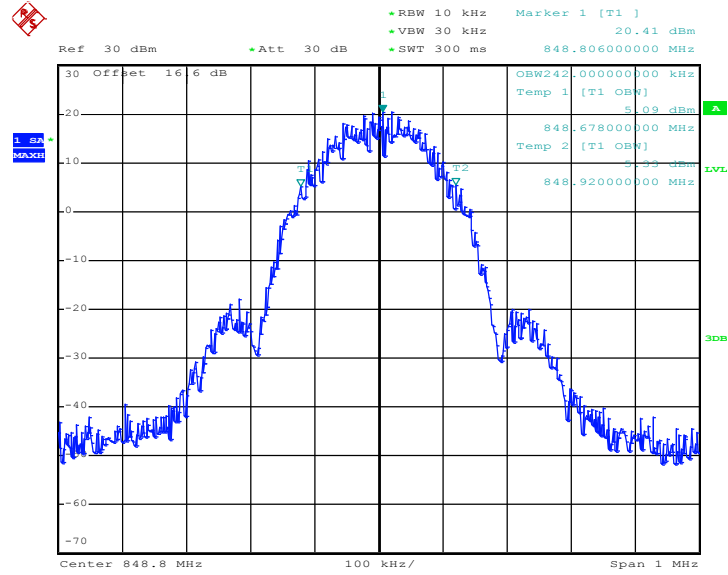

Date: 8.OCT.2012 13:38:56

26dB Bandwidth Plot on Channel 251 (848.8 MHz)

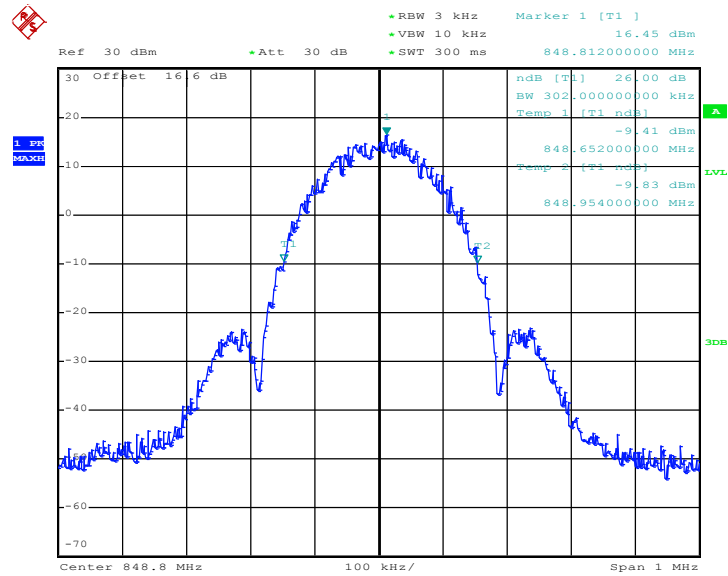

Date: 8.OCT.2012 13:37:38



Band :	GSM 1900	Test Mode :	GSM Link
--------	----------	-------------	----------

99% Occupied Bandwidth Plot on Channel 512 (1850.2 MHz)

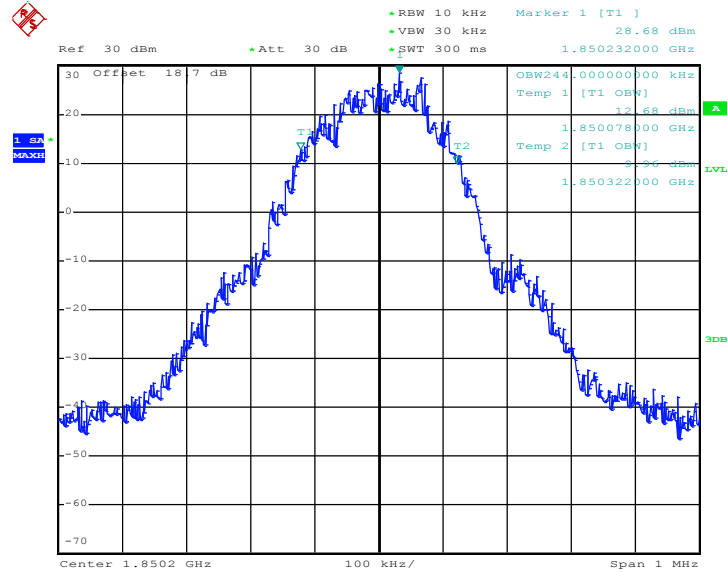

Date: 8.OCT.2012 15:02:04

26dB Bandwidth Plot on Channel 512 (1850.2 MHz)

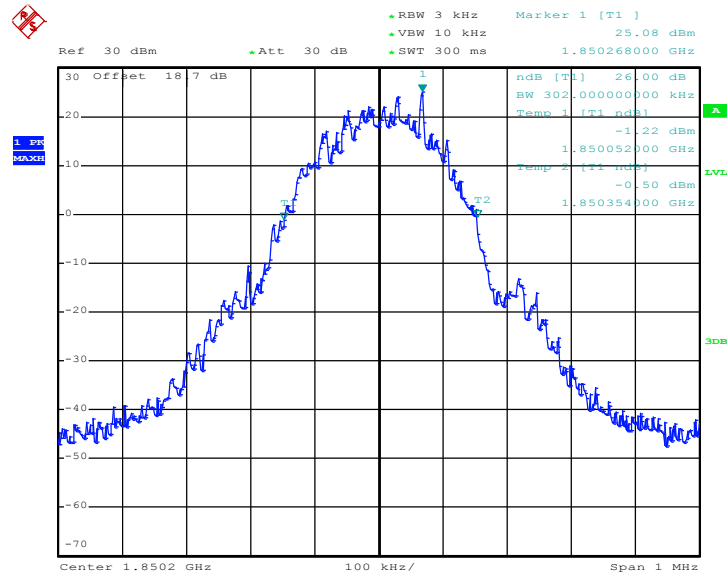

Date: 8.OCT.2012 15:00:45



### 99% Occupied Bandwidth Plot on Channel 661 (1880.0 MHz)

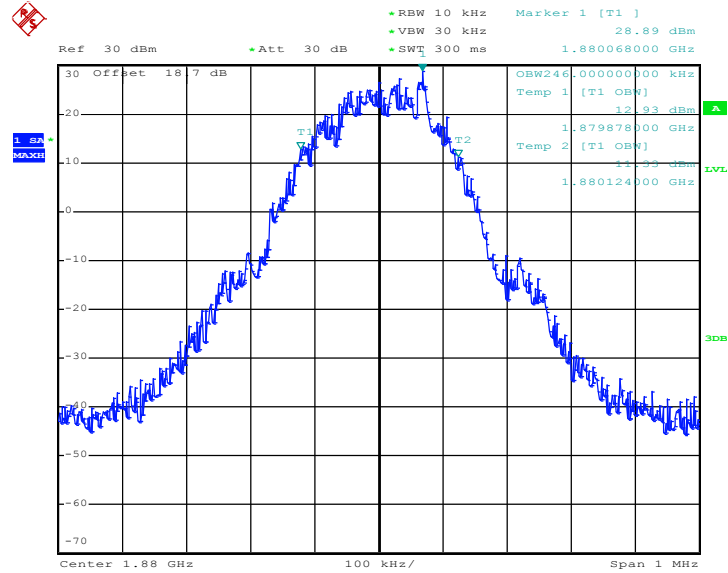

Date: 8.OCT.2012 15:02:30

### 26dB Bandwidth Plot on Channel 661 (1880.0 MHz)

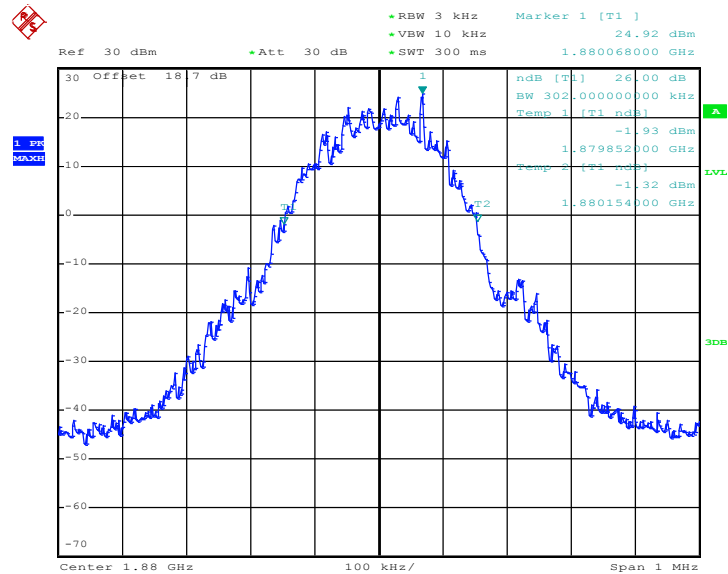

Date: 8.OCT.2012 15:01:11





99% Occupied Bandwidth Plot on Channel 810 (1909.8 MHz)

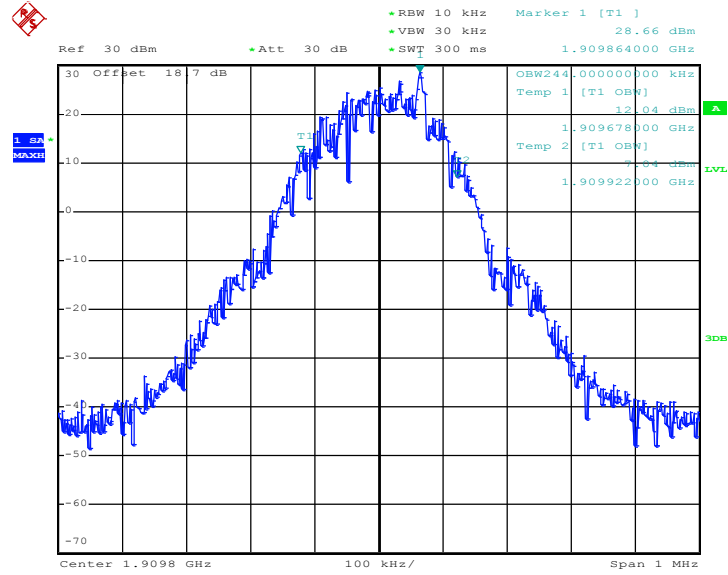

Date: 8.OCT.2012 15:02:56

26dB Bandwidth Plot on Channel 810 (1909.8 MHz)

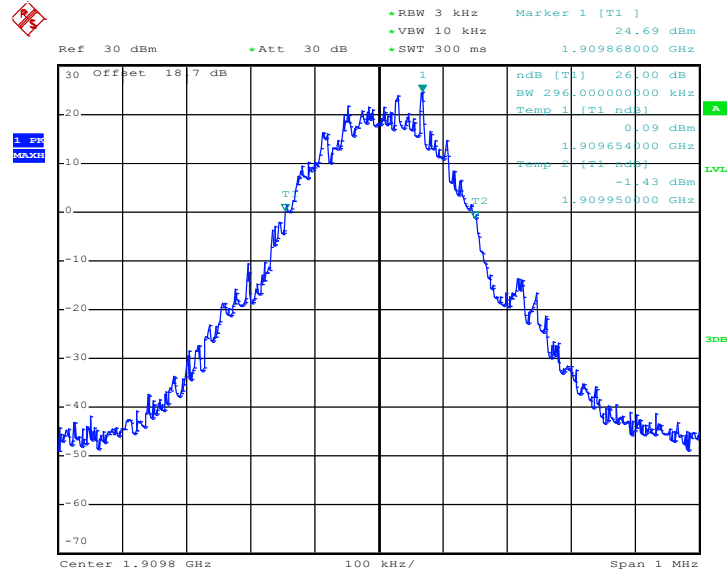

Date: 8.OCT.2012 15:01:38



<b>Band :</b>	GSM 1900	<b>Test Mode :</b>	EDGE 8 Link
---------------	----------	--------------------	-------------

99% Occupied Bandwidth Plot on Channel 512 (1850.2 MHz)

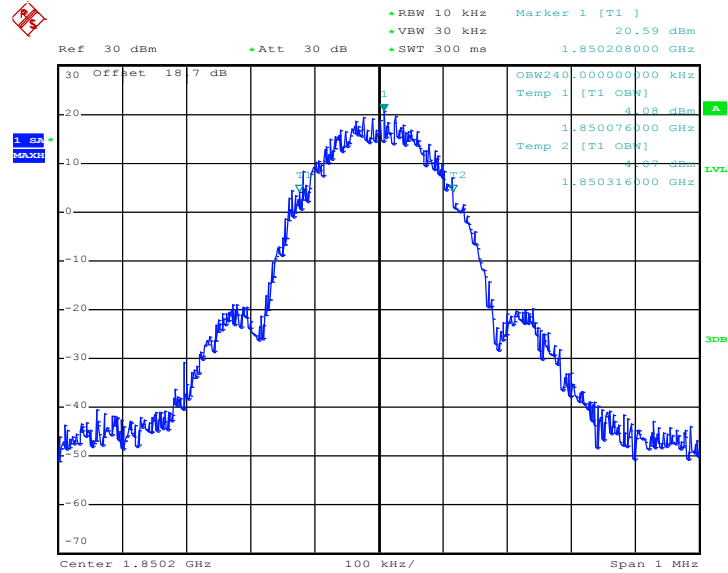

Date: 8.OCT.2012 14:23:39

26dB Bandwidth Plot on Channel 512 (1850.2 MHz)

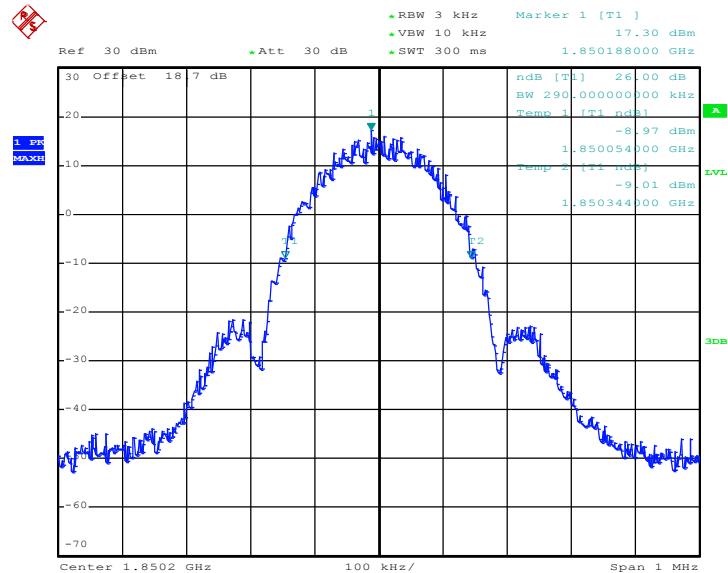

Date: 8.OCT.2012 14:22:20



99% Occupied Bandwidth Plot on Channel 661 (1880.0 MHz)

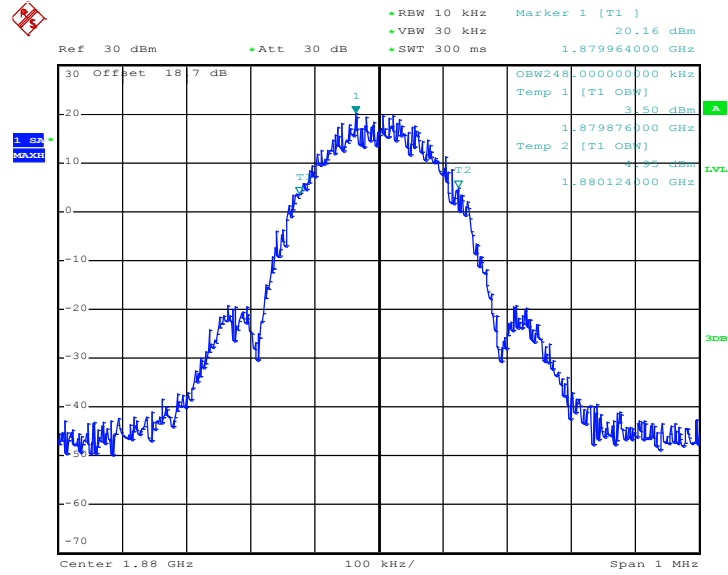

Date: 8.OCT.2012 14:24:05

26dB Bandwidth Plot on Channel 661 (1880.0 MHz)

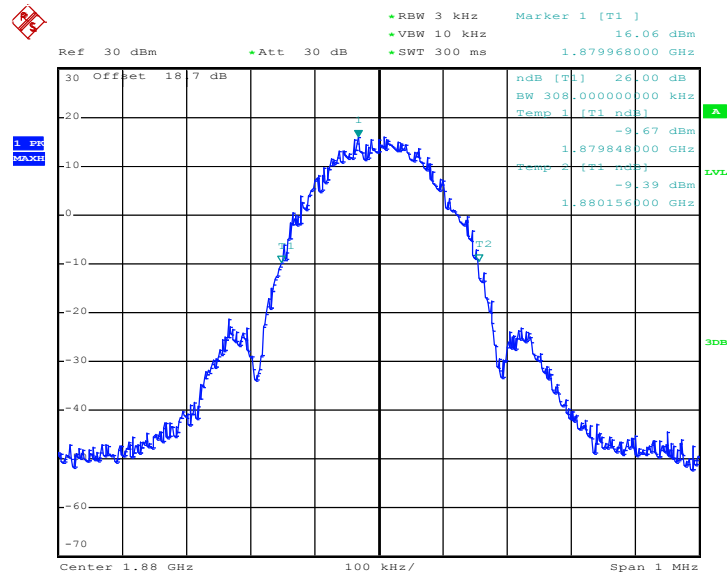

Date: 8.OCT.2012 14:22:46



99% Occupied Bandwidth Plot on Channel 810 (1909.8 MHz)

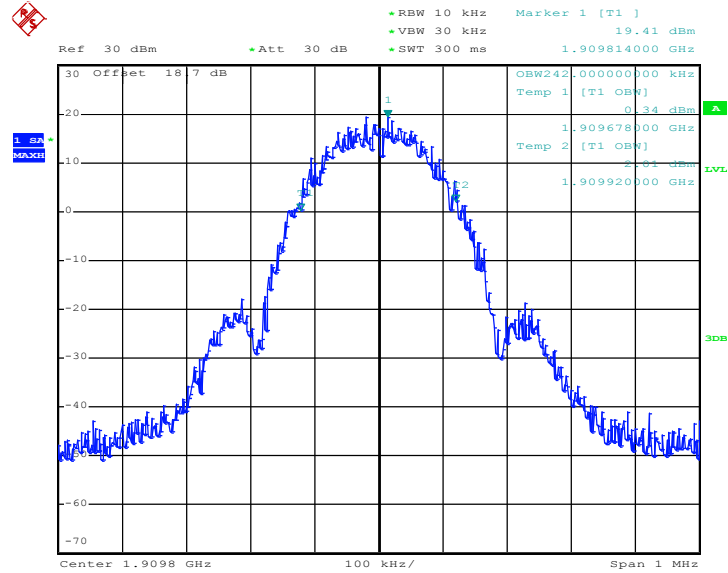

Date: 8.OCT.2012 14:24:31

26dB Bandwidth Plot on Channel 810 (1909.8 MHz)

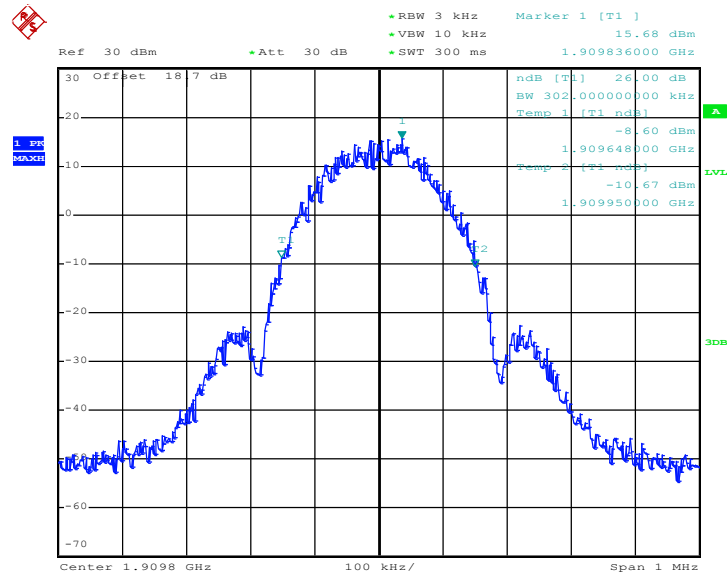

Date: 8.OCT.2012 14:23:12



Band :	WCDMA Band V	Test Mode :	RMC 12.2Kbps Link
--------	--------------	-------------	-------------------

99% Occupied Bandwidth Plot on Channel 4132 (826.4 MHz)

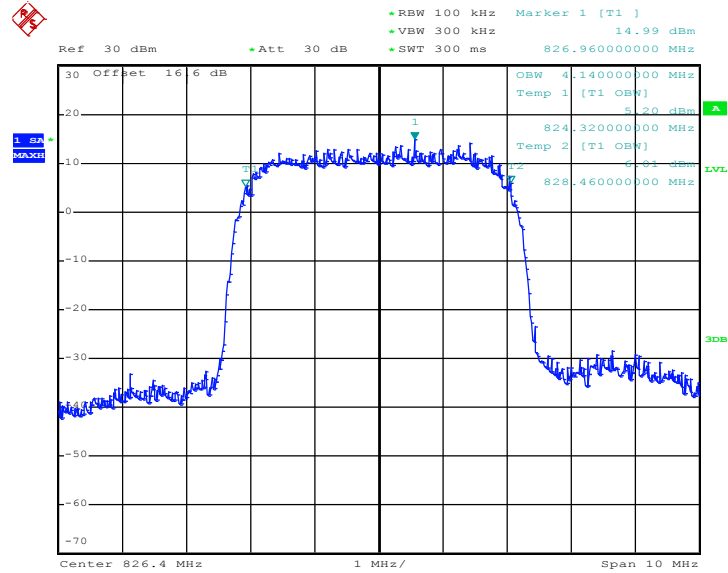

Date: 8.OCT.2012 15:52:54

26dB Bandwidth Plot on Channel 4132 (826.4 MHz)

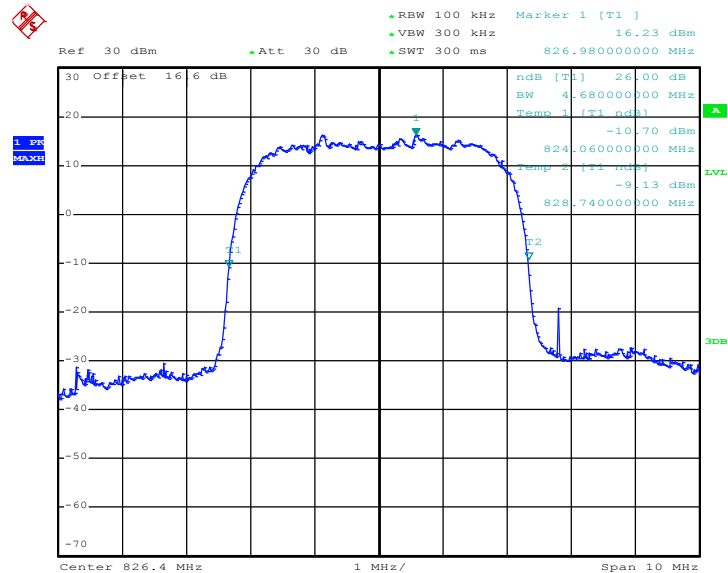

Date: 8.OCT.2012 15:51:35



99% Occupied Bandwidth Plot on Channel 4182 (836.4 MHz)

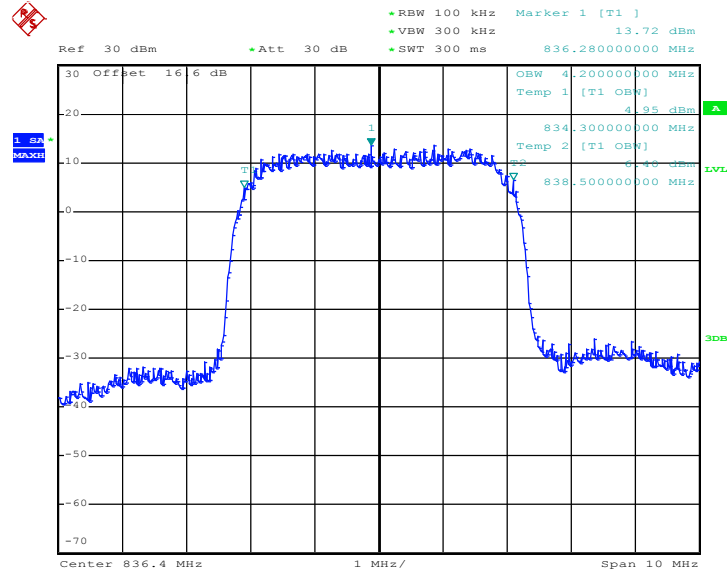

Date: 8.OCT.2012 15:53:20

26dB Bandwidth Plot on Channel 4182 (836.4 MHz)

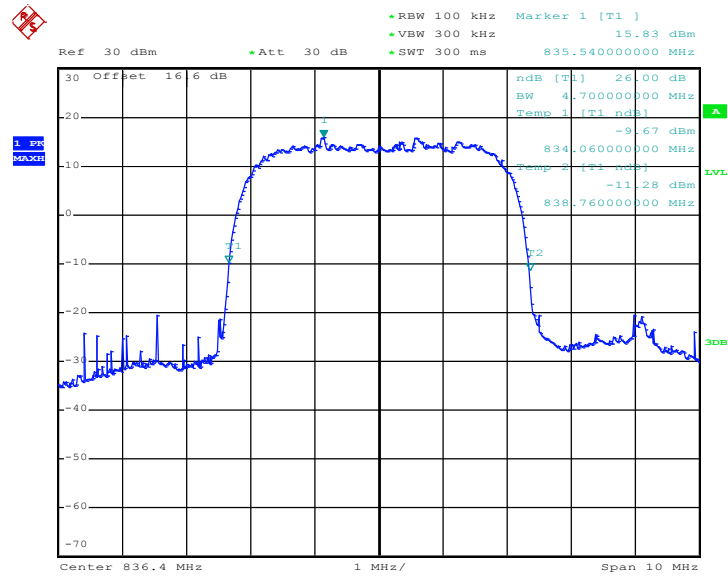

Date: 8.OCT.2012 15:52:01



99% Occupied Bandwidth Plot on Channel 4233 (846.6 MHz)

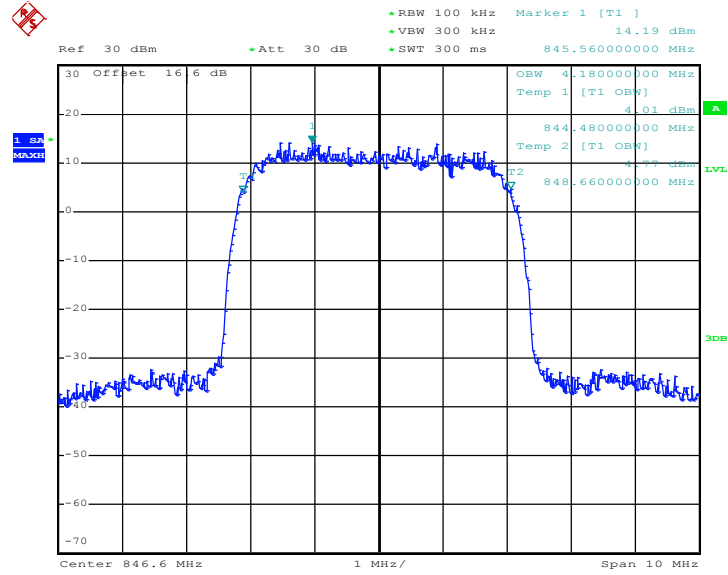

Date: 8.OCT.2012 15:53:45

26dB Bandwidth Plot on Channel 4233 (846.6 MHz)

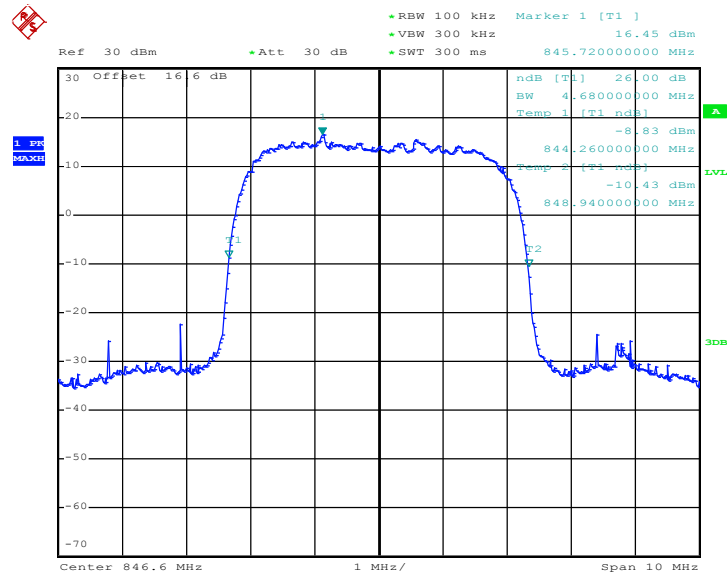

Date: 8.OCT.2012 15:52:27



Band :	WCDMA Band IV	Test Mode :	RMC 12.2Kbps Link
--------	---------------	-------------	-------------------

99% Occupied Bandwidth Plot on Channel 1312 (1712.4 MHz)

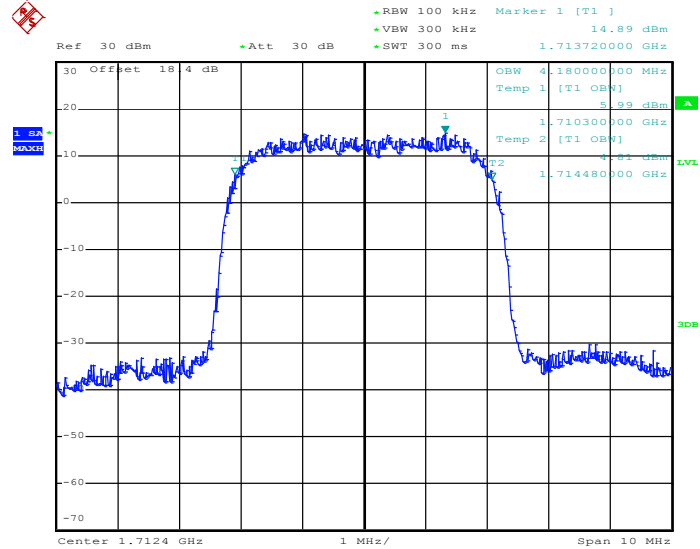

Date: 8.OCT.2012 15:37:05

26dB Bandwidth Plot on Channel 1312 (1712.4 MHz)

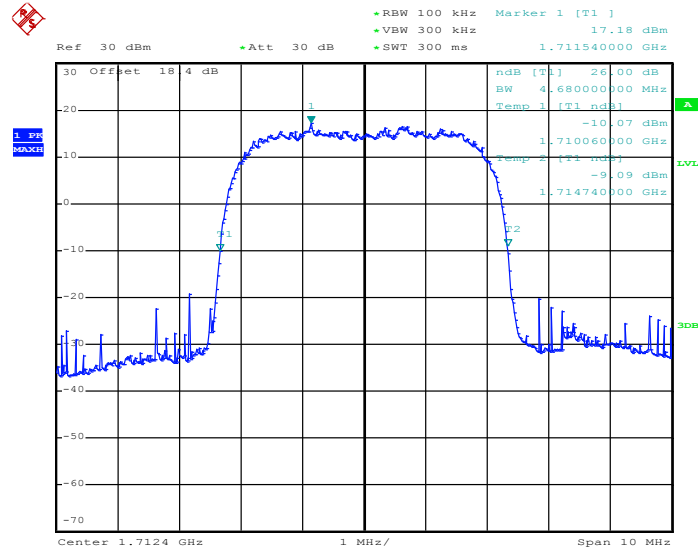

Date: 8.OCT.2012 15:35:47





### 99% Occupied Bandwidth Plot on Channel 1413 (1732.6 MHz)

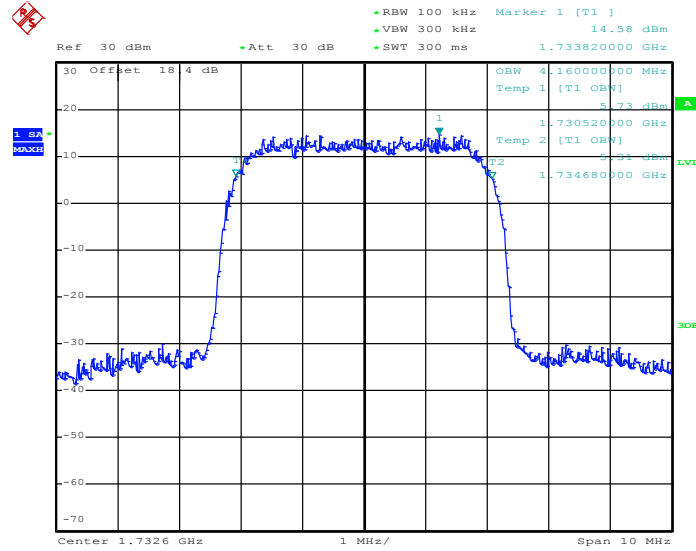

Date: 8.OCT.2012 15:37:31

### 26dB Bandwidth Plot on Channel 1413 (1732.6 MHz)

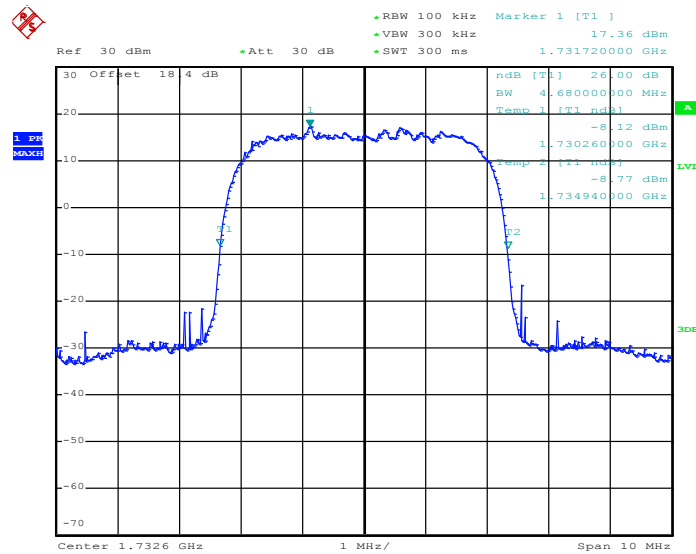

Date: 8.OCT.2012 15:36:13



### 99% Occupied Bandwidth Plot on Channel 1513 (1752.6 MHz)

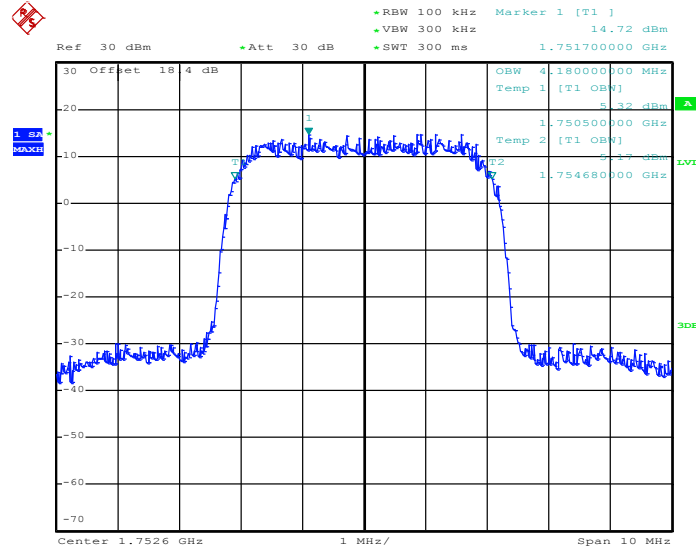

Date: 8.OCT.2012 15:37:57

### 26dB Bandwidth Plot on Channel 1513 (1752.6 MHz)

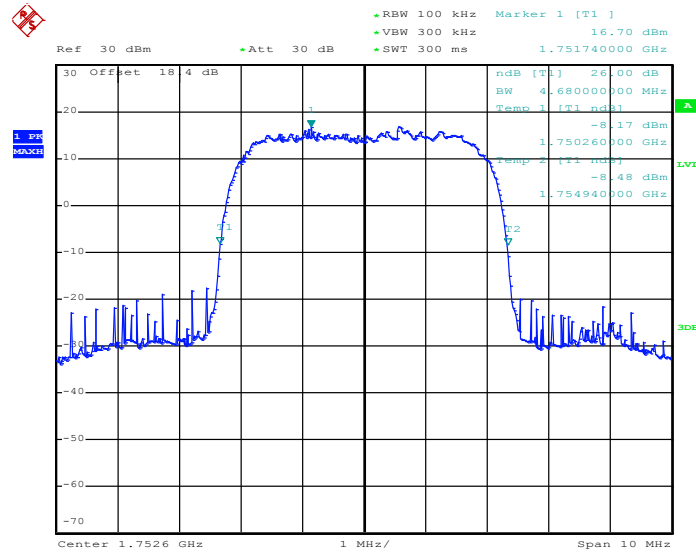

Date: 8.OCT.2012 15:36:39



<b>Band :</b>	WCDMA Band II	<b>Test Mode :</b>	RMC 12.2Kbps Link
---------------	---------------	--------------------	-------------------

99% Occupied Bandwidth Plot on Channel 9262 (1852.4 MHz)

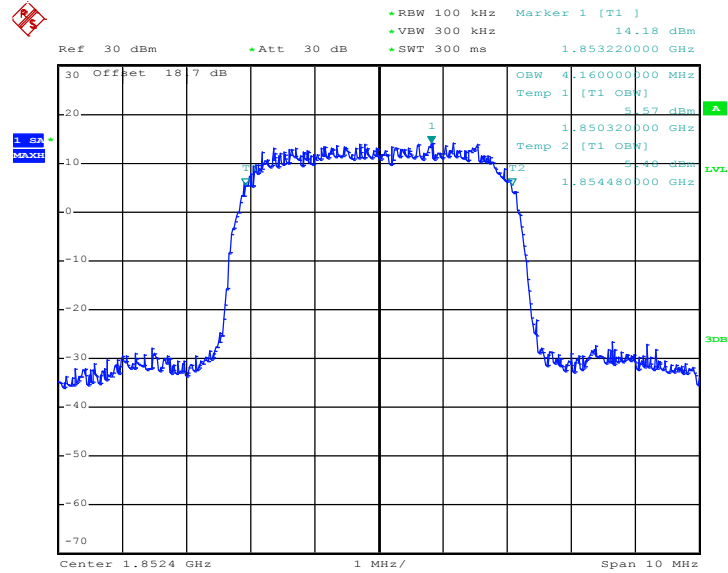

Date: 8.OCT.2012 15:19:09

26dB Bandwidth Plot on Channel 9262 (1852.4 MHz)

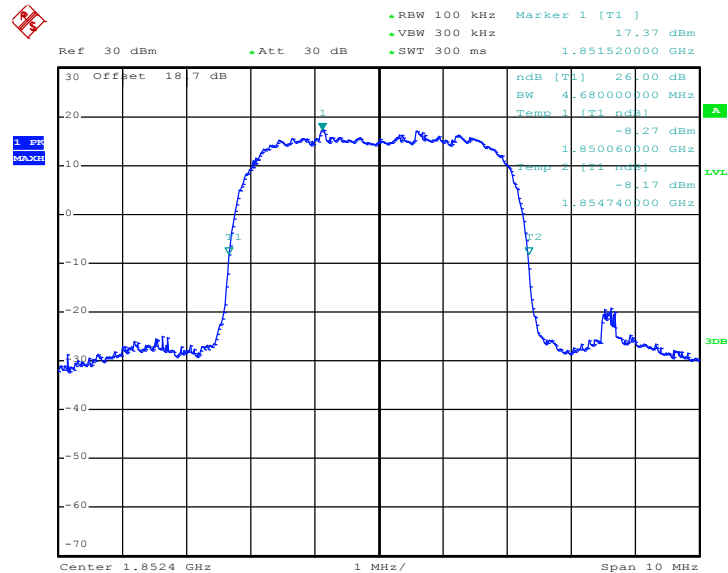

Date: 8.OCT.2012 15:17:50



### 99% Occupied Bandwidth Plot on Channel 9400 (1880.0 MHz)

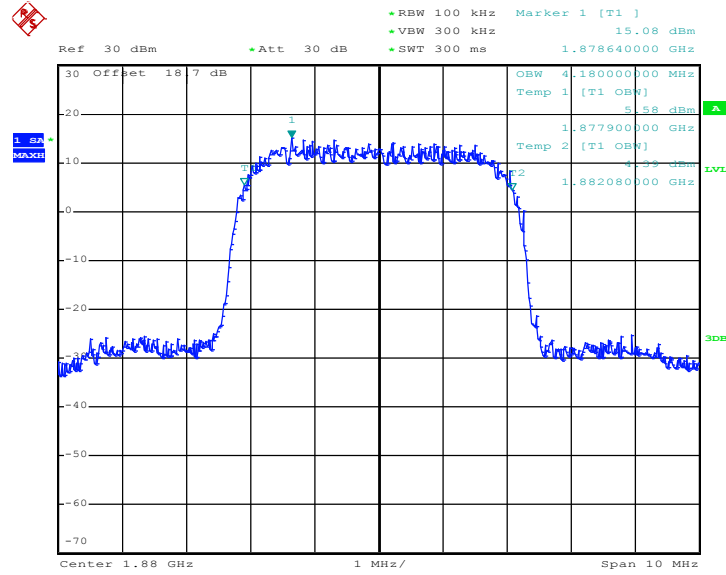

Date: 8.OCT.2012 15:19:35

### 26dB Bandwidth Plot on Channel 9400 (1880.0 MHz)

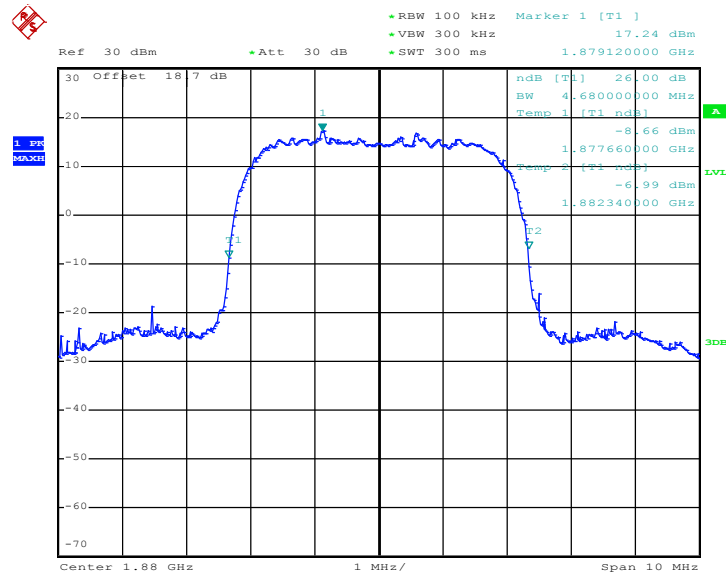

Date: 8.OCT.2012 15:18:16



99% Occupied Bandwidth Plot on Channel 9538 (1907.6 MHz)

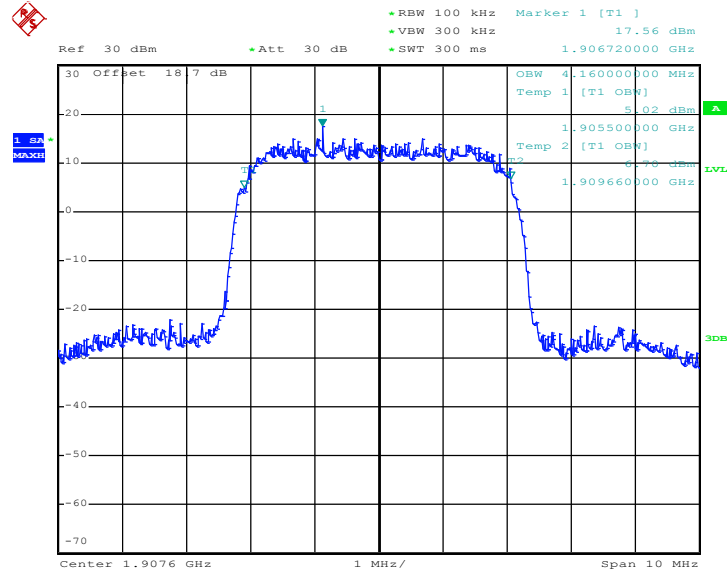

Date: 8.OCT.2012 15:20:01

26dB Bandwidth Plot on Channel 9538 (1907.6 MHz)

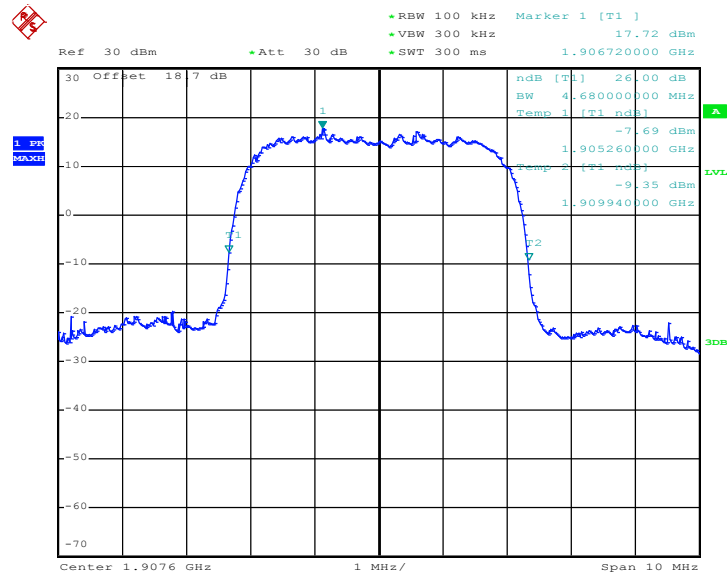

Date: 8.OCT.2012 15:18:42

## 3.5 Band Edge Measurement

### 3.5.1 Description of Band Edge Measurement

The power of any emission outside of the authorized operating frequency ranges must be lower than the transmitter power (P) by a factor of at least  $43 + 10 \log (P)$  dB.

### 3.5.2 Measuring Instruments

See list of measuring instruments of this test report.

### 3.5.3 Test Procedures

1. The EUT was connected to Spectrum Analyzer and Base Station via power divider.
2. The RF output of EUT was connected to the spectrum analyzer by RF cable and attenuator. The path loss was compensated to the results for each measurement.
3. The band edges of low and high channels for the highest RF powers were measured. Setting RBW as roughly  $BW/100$ .

### 3.5.4 Test Setup

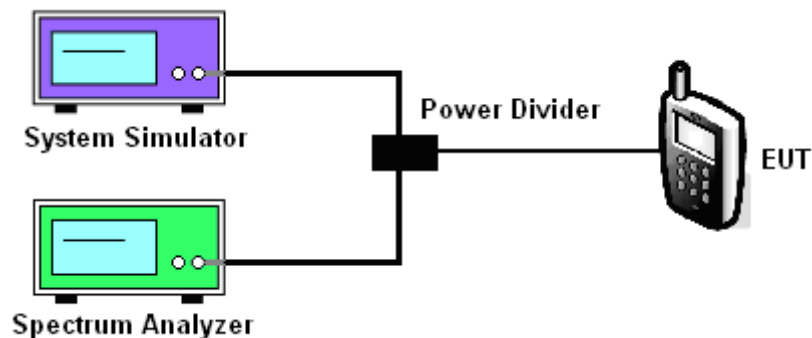



3.5.5 Test Result (Plots) of Conducted Band Edge

Band :	GSM850	Test Mode :	GSM Link
Correction Factor :	0.03dB	Maximum 26dB Bandwidth :	0.302MHz
Band Edge :	-15.90dBm	Measurement Value :	-15.93dBm

Lower Band Edge Plot on Channel 128 (824.2 MHz)

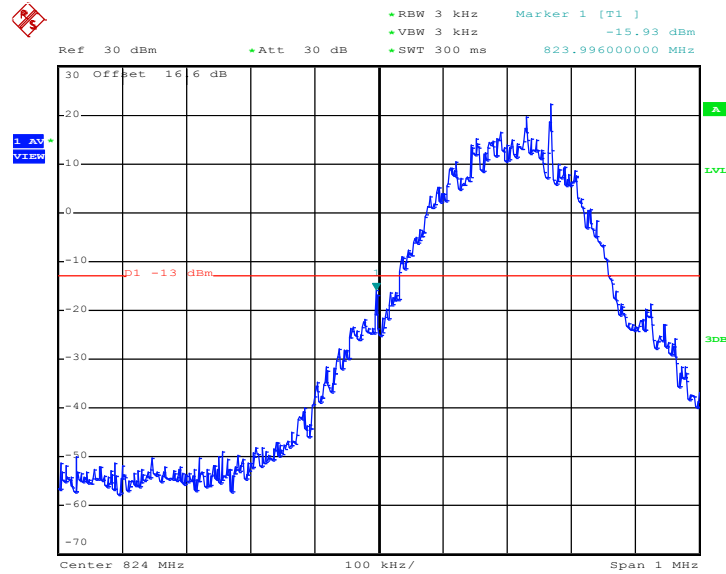

Date: 8.OCT.2012 11:27:50

1. Correction Factor(dB)= 10log(1% Emission BW/RBW)
  2. Band Edge= Measurement Value + Correction Factor(dB)
- For example, -15.93dBm + 0.03dB = -15.90dBm



Band :	GSM850	Test Mode :	GSM Link
Correction Factor :	0.03dB	Maximum 26dB Bandwidth :	0.302MHz
Band Edge :	-19.63dBm	Measurement Value :	-19.66dBm

Higher Band Edge Plot on Channel 251 (848.8 MHz)

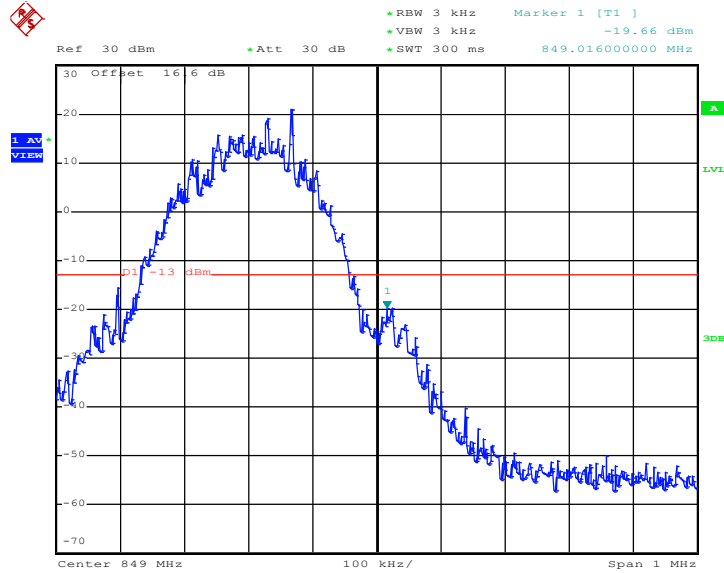

Date: 8.OCT.2012 11:28:16

1. Correction Factor(dB)=  $10\log(1\% \text{ Emission BW/RBW})$
2. Band Edge= Measurement Value + Correction Factor(dB)





Band :	GSM850	Test Mode :	EDGE 8 Link
Correction Factor :	0.09dB	Maximum 26dB Bandwidth :	0.306MHz
Band Edge :	-27.93dBm	Measurement Value :	-28.02dBm

Lower Band Edge Plot on Channel 128 (824.2 MHz)

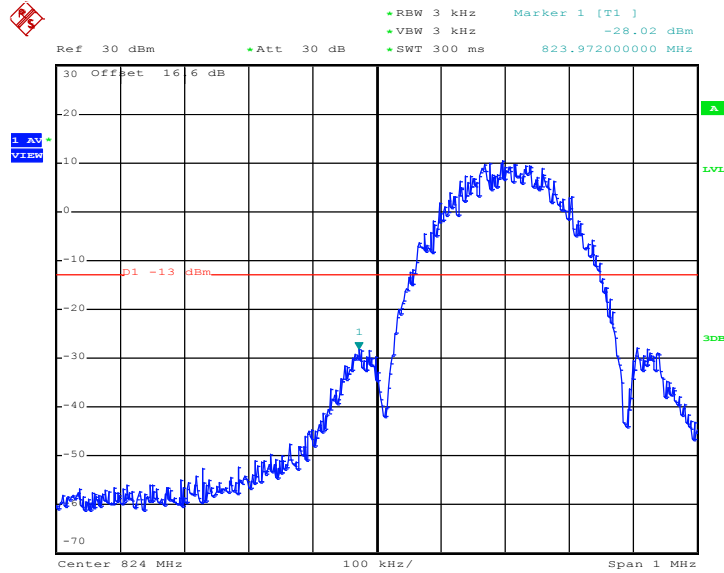

Date: 8.OCT.2012 13:40:22

1. Correction Factor(dB)=  $10\log(1\% \text{ Emission BW/RBW})$
2. Band Edge= Measurement Value + Correction Factor(dB)



Band :	GSM850	Test Mode :	EDGE 8 Link
Correction Factor :	0.09dB	Maximum 26dB Bandwidth :	0.306MHz
Band Edge :	-28.81dBm	Measurement Value :	-28.90dBm

Higher Band Edge Plot on Channel 251 (848.8 MHz)

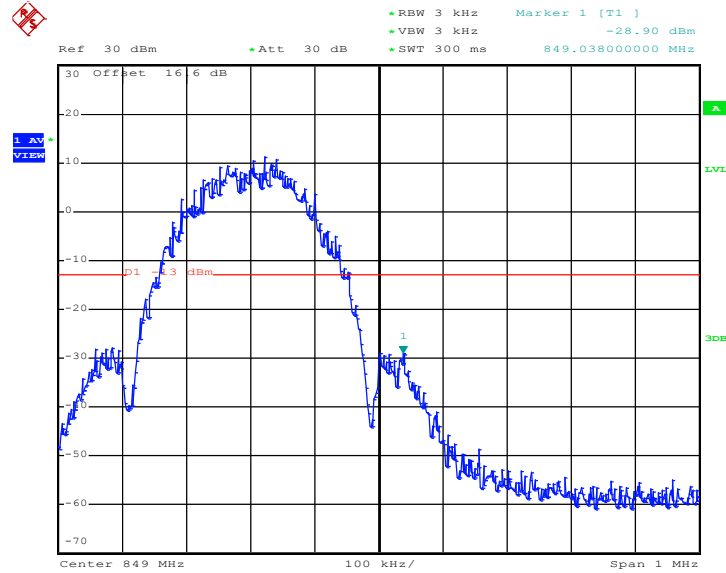

Date: 8.OCT.2012 13:40:48

1. Correction Factor(dB)=  $10\log(1\% \text{ Emission BW/RBW})$
2. Band Edge= Measurement Value + Correction Factor(dB)



Band :	GSM1900	Test Mode :	GSM Link
Correction Factor :	0.03dB	Maximum 26dB Bandwidth :	0.302MHz
Band Edge :	-14.45dBm	Measurement Value :	-14.48dBm

Lower Band Edge Plot on Channel 512 (1850.2 MHz)

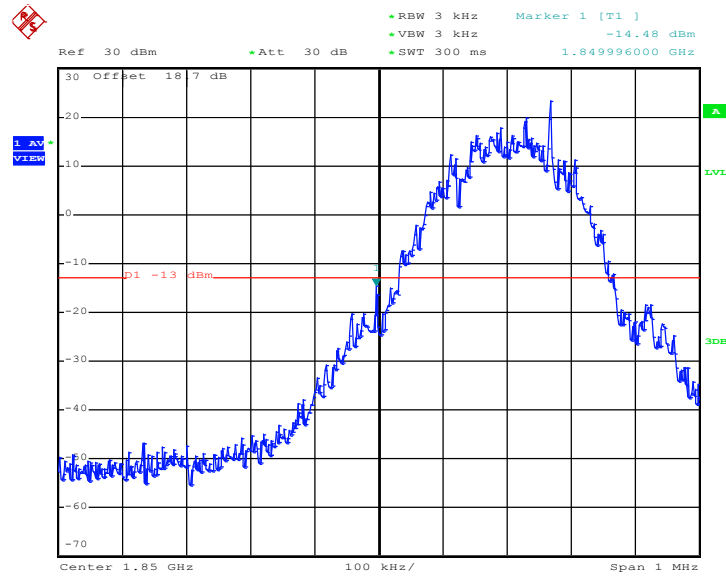

Date: 8.OCT.2012 15:04:21

1. Correction Factor(dB)= 10log(1% Emission BW/RBW)
2. Band Edge= Measurement Value + Correction Factor(dB)



Band :	GSM1900	Test Mode :	GSM Link
Correction Factor :	0.03dB	Maximum 26dB Bandwidth :	0.302MHz
Band Edge :	-18.65dBm	Measurement Value :	-18.68dBm

Higher Band Edge Plot on Channel 810 (1909.8 MHz)

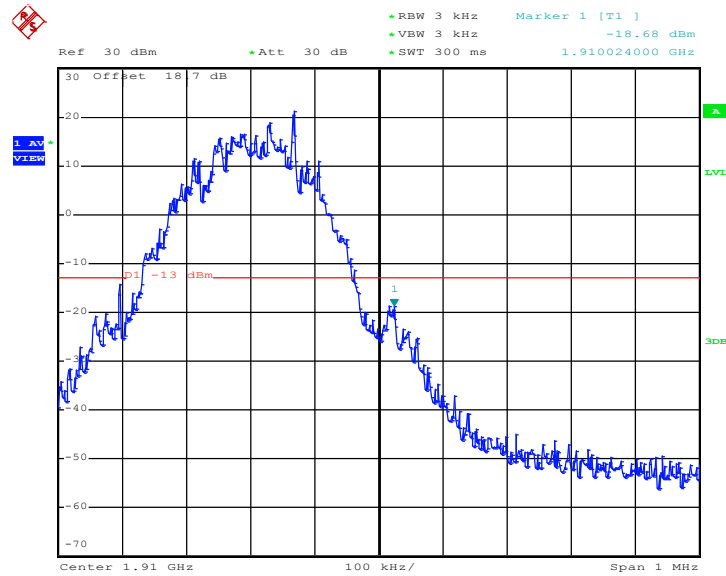

Date: 8.OCT.2012 15:04:48

1. Correction Factor(dB)= 10log(1% Emission BW/RBW)
2. Band Edge= Measurement Value + Correction Factor(dB)



Band :	GSM1900	Test Mode :	EDGE 8 Link
Correction Factor :	0.11dB	Maximum 26dB Bandwidth :	0.308MHz
Band Edge :	-26.63dBm	Measurement Value :	-26.74dBm

Lower Band Edge Plot on Channel 512 (1850.2 MHz)

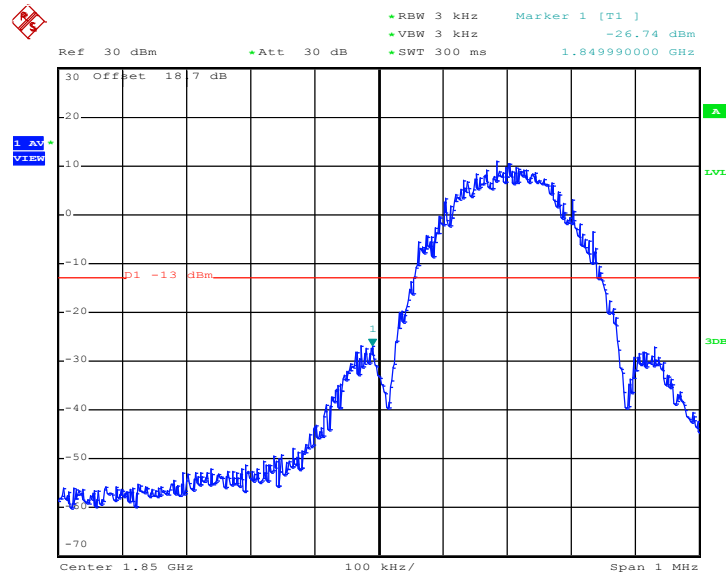

Date: 8.OCT.2012 14:25:56

1. Correction Factor(dB)= 10log(1% Emission BW/RBW)
2. Band Edge= Measurement Value + Correction Factor(dB)



Band :	GSM1900	Test Mode :	EDGE 8 Link
Correction Factor :	0.11dB	Maximum 26dB Bandwidth :	0.308MHz
Band Edge :	-29.73dBm	Measurement Value :	-29.84dBm

Higher Band Edge Plot on Channel 810 (1909.8 MHz)

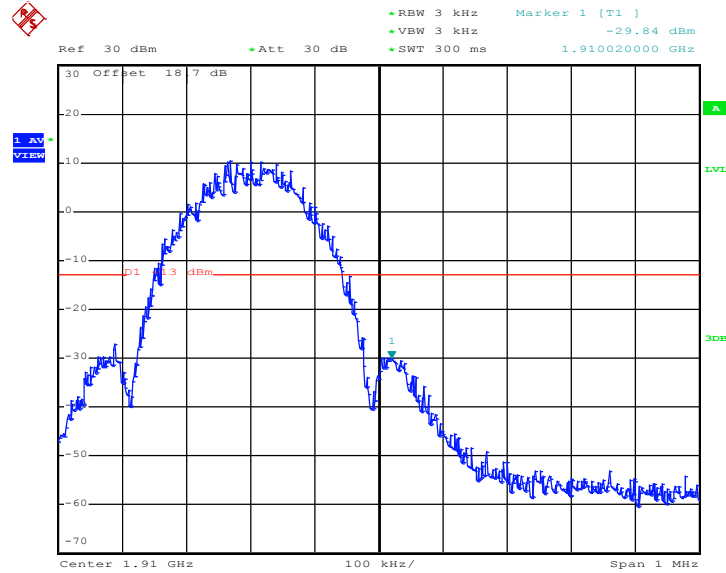

Date: 8.OCT.2012 14:26:23

1. Correction Factor(dB)=  $10\log(1\% \text{ Emission BW/RBW})$
2. Band Edge= Measurement Value + Correction Factor(dB)



Band :	WCDMA Band V	Test Mode :	RMC 12.2Kbps Link
Correction Factor :	-3.28dB	Maximum 26dB Bandwidth :	4.70MHz
Band Edge :	-34.59dBm	Measurement Value :	-31.31dBm

Lower Band Edge Plot on Channel 4132 (826.4 MHz)

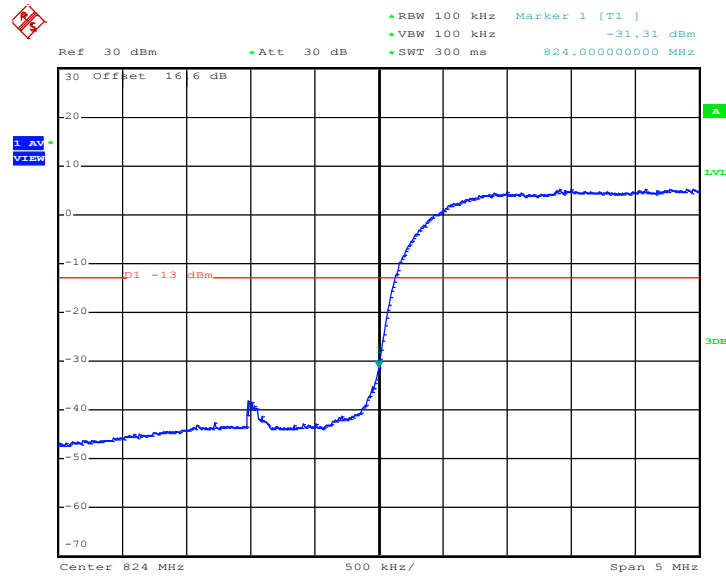

Date: 8.OCT.2012 15:55:13

1. Correction Factor(dB)= 10log(1% Emission BW/RBW)
2. Band Edge= Measurement Value + Correction Factor(dB)



Band :	WCDMA Band V	Test Mode :	RMC 12.2Kbps Link
Correction Factor :	-3.28dB	Maximum 26dB Bandwidth :	4.70MHz
Band Edge :	-33.82dBm	Measurement Value :	-30.54dBm

Higher Band Edge Plot on Channel 4233 (846.6 MHz)

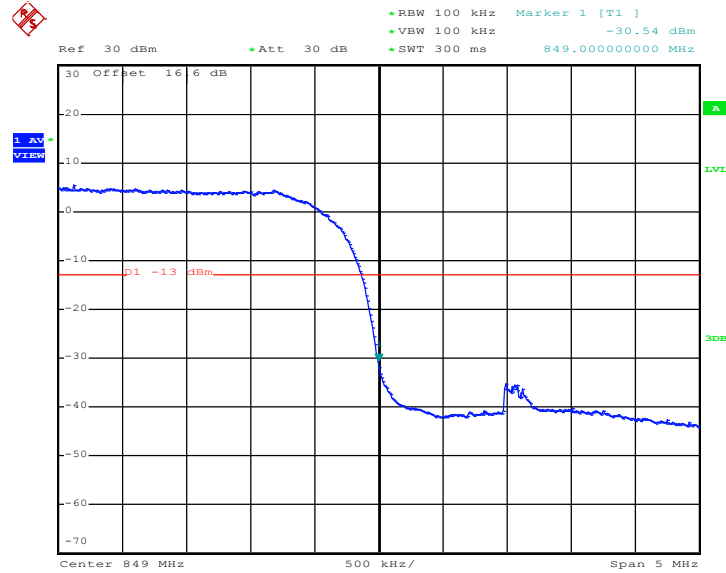

Date: 8.OCT.2012 15:55:40

1. Correction Factor(dB)=  $10\log(1\% \text{ Emission BW/RBW})$
2. Band Edge= Measurement Value + Correction Factor(dB)





Band :	WCDMA Band IV	Test Mode :	RMC 12.2Kbps Link
Correction Factor :	-3.30dB	Maximum 26dB Bandwidth :	4.68MHz
Band Edge :	-32.69dBm	Measurement Value :	-29.39dBm

Lower Band Edge Plot on Channel 1312 (1712.4 MHz)

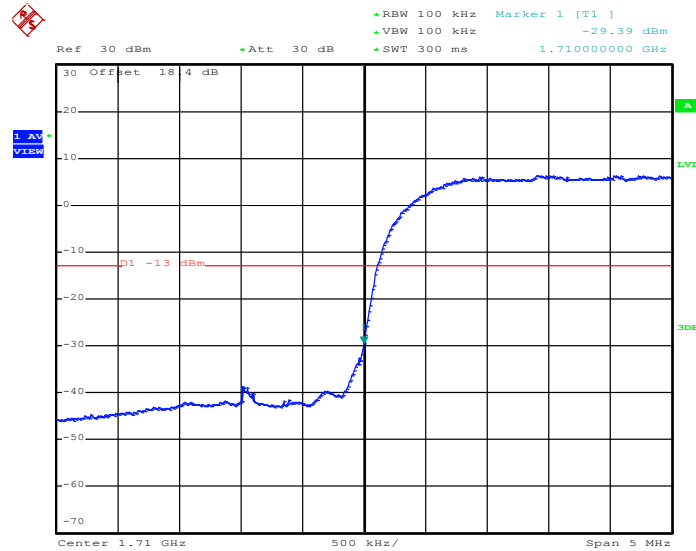

Date: 8.OCT.2012 15:39:25

1. Correction Factor(dB)=  $10\log(1\% \text{ Emission BW/RBW})$
2. Band Edge= Measurement Value + Correction Factor(dB)



Band :	WCDMA Band IV	Test Mode :	RMC 12.2Kbps Link
Correction Factor :	-3.30dB	Maximum 26dB Bandwidth :	4.68MHz
Band Edge :	-31.97dBm	Measurement Value :	-28.67dBm

Higher Band Edge Plot on Channel 1513 (1752.6 MHz)

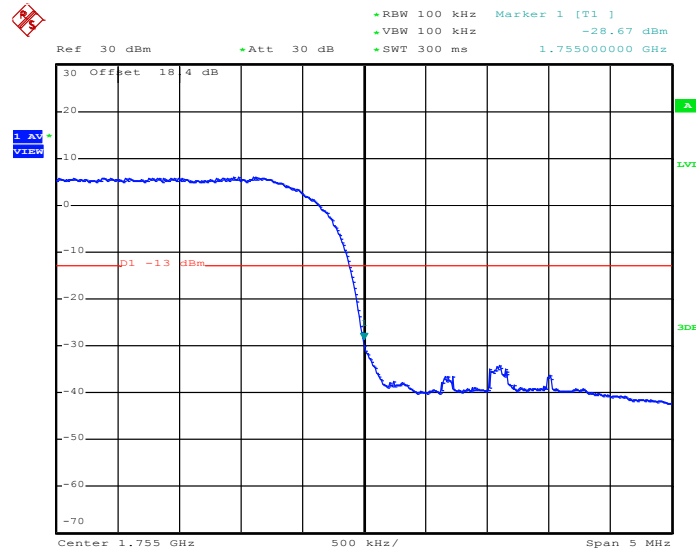

Date: 8.OCT.2012 15:39:51

1. Correction Factor(dB)=  $10\log(1\% \text{ Emission BW/RBW})$
2. Band Edge= Measurement Value + Correction Factor(dB)



Band :	WCDMA Band II	Test Mode :	RMC 12.2Kbps Link
Correction Factor :	-3.30dB	Maximum 26dB Bandwidth :	4.68MHz
Band Edge :	-32.13dBm	Measurement Value :	-28.83dBm

Lower Band Edge Plot on Channel 9262 (1852.4 MHz)

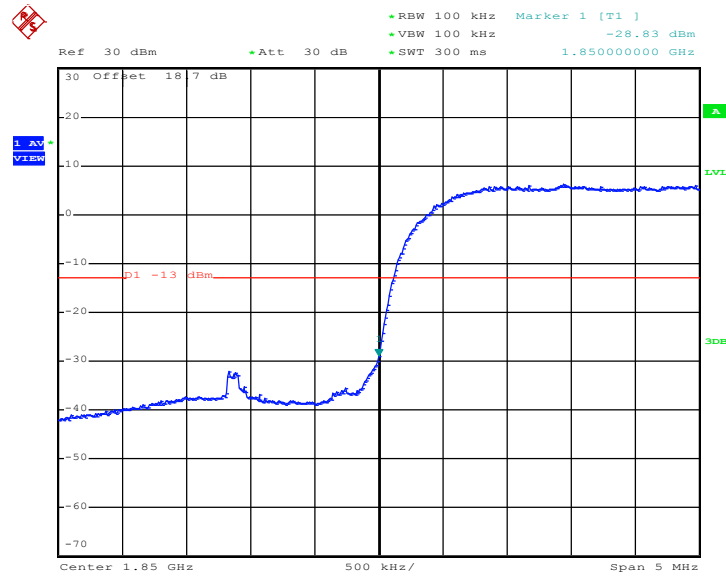

Date: 8.OCT.2012 15:21:29

1. Correction Factor(dB)=  $10\log(1\% \text{ Emission BW/RBW})$
2. Band Edge= Measurement Value + Correction Factor(dB)



Band :	WCDMA Band II	Test Mode :	RMC 12.2Kbps Link
Correction Factor :	-3.30dB	Maximum 26dB Bandwidth :	4.68MHz
Band Edge :	-30.61dBm	Measurement Value :	-27.31dBm

Higher Band Edge Plot on Channel 9538 (1907.6 MHz)

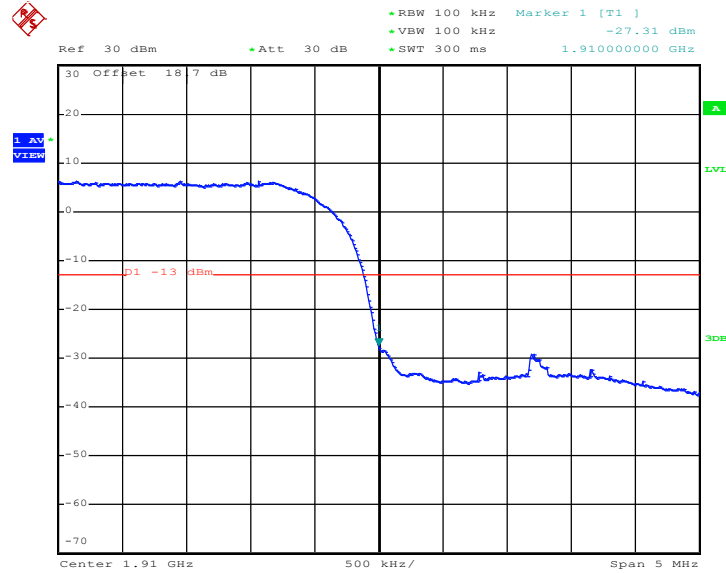

Date: 8.OCT.2012 15:21:55

1. Correction Factor(dB)=  $10\log(1\% \text{ Emission BW/RBW})$
2. Band Edge= Measurement Value + Correction Factor(dB)

## 3.6 Conducted Spurious Emission Measurement

### 3.6.1 Description of Conducted Spurious Emission Measurement

The power of any emission outside of the authorized operating frequency ranges must be lower than the transmitter power (P) by a factor of at least  $43 + 10 \log (P)$  dB.

It is measured by means of a calibrated spectrum analyzer and scanned from 30 MHz up to a frequency including its 10<sup>th</sup> harmonic.

### 3.6.2 Measuring Instruments

See list of measuring instruments of this test report.

### 3.6.3 Test Procedures

1. The EUT was connected to spectrum analyzer and base station via power divider.
2. The RF output of EUT was connected to the spectrum analyzer by RF cable and attenuator. The path loss was compensated to the results for each measurement.
3. The middle channel for the highest RF power within the transmitting frequency was measured.
4. The conducted spurious emission for the whole frequency range was taken.

### 3.6.4 Test Setup

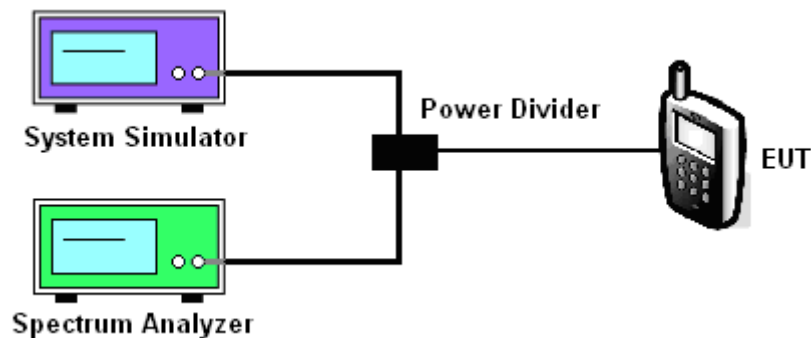

### 3.6.5 Test Result (Plots) of Conducted Emission

Band :	GSM850	Channel :	CH189
Test Mode :	GSM Link	Frequency :	836.4 MHz

Conducted Spurious Emission Plot between 30MHz ~ 1GHz

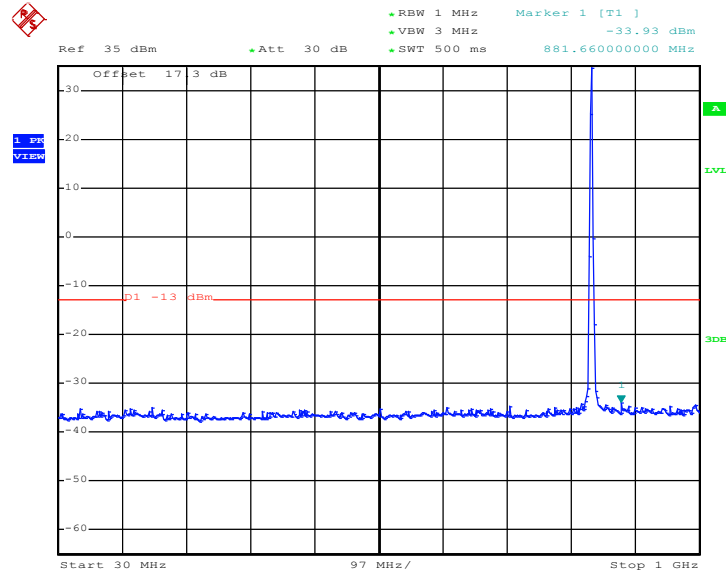

Date: 8.OCT.2012 11:13:37

Conducted Spurious Emission Plot between 1GHz ~ 3GHz

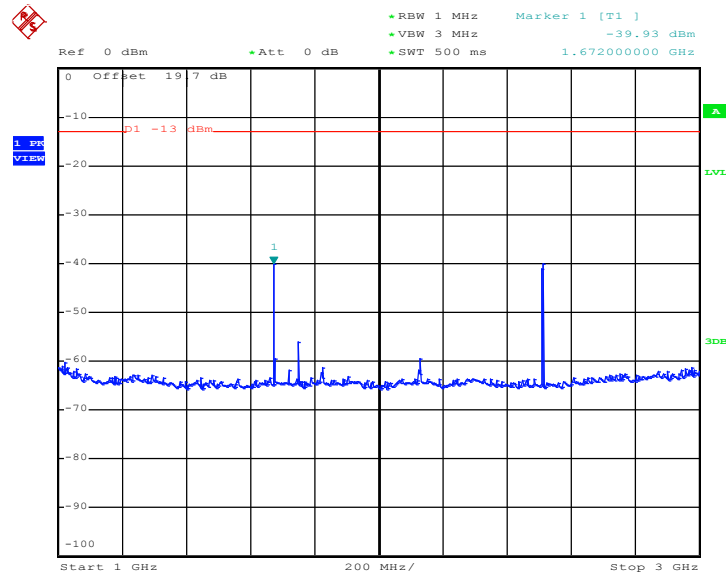

Date: 8.OCT.2012 11:13:52



### Conducted Spurious Emission Plot between 3GHz ~ 7GHz

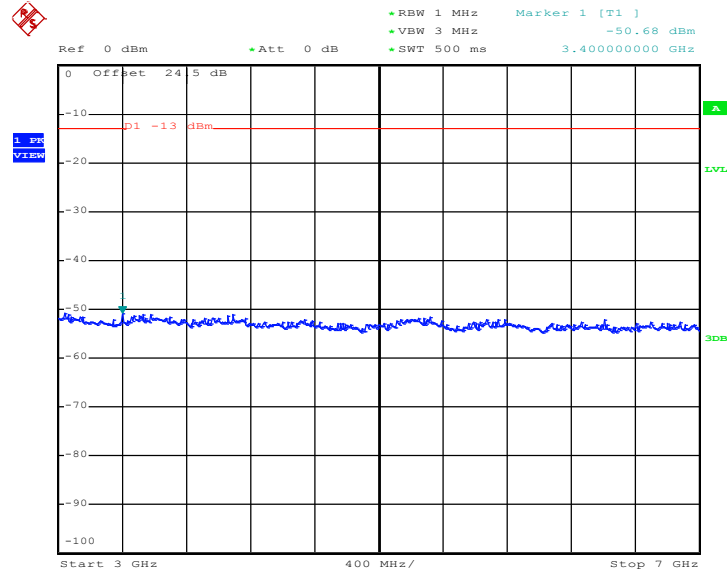

Date: 8.OCT.2012 11:14:05

### Conducted Spurious Emission Plot between 7GHz ~ 9GHz

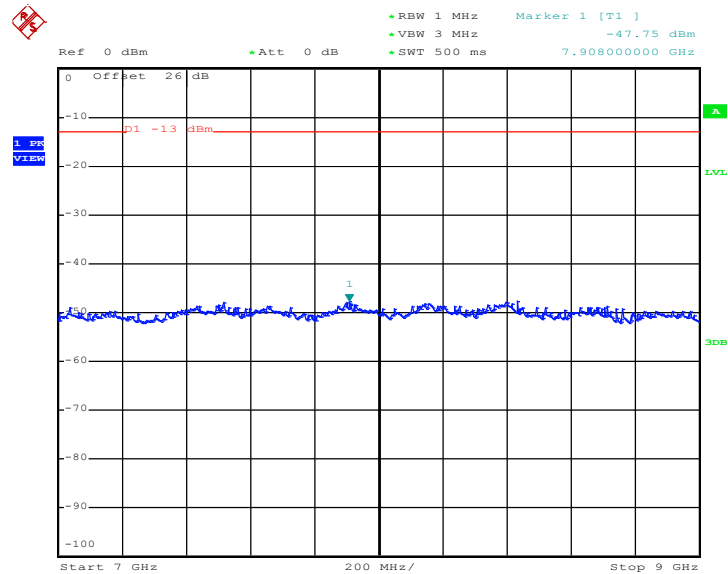

Date: 8.OCT.2012 11:14:17



Band :	GSM850	Channel :	CH189
Test Mode :	EDGE 8 Link	Frequency :	836.4 MHz

Conducted Spurious Emission Plot between 30MHz ~ 1GHz

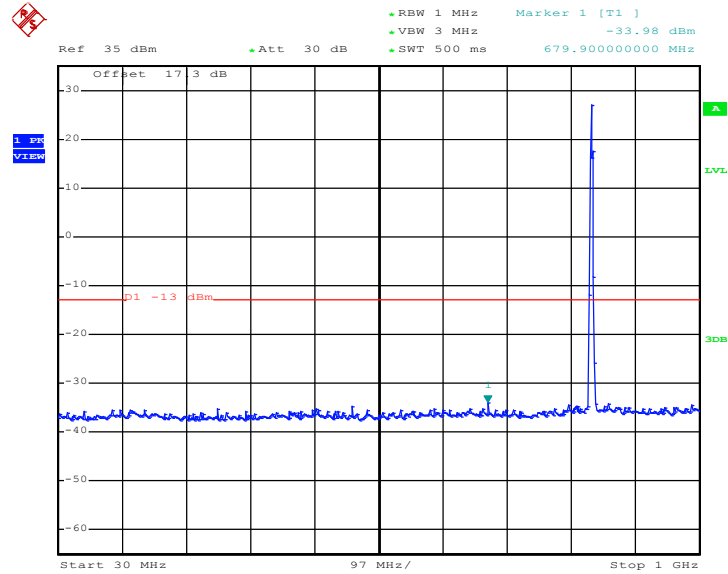

Date: 8.OCT.2012 13:43:57

Conducted Spurious Emission Plot between 1GHz ~ 3GHz

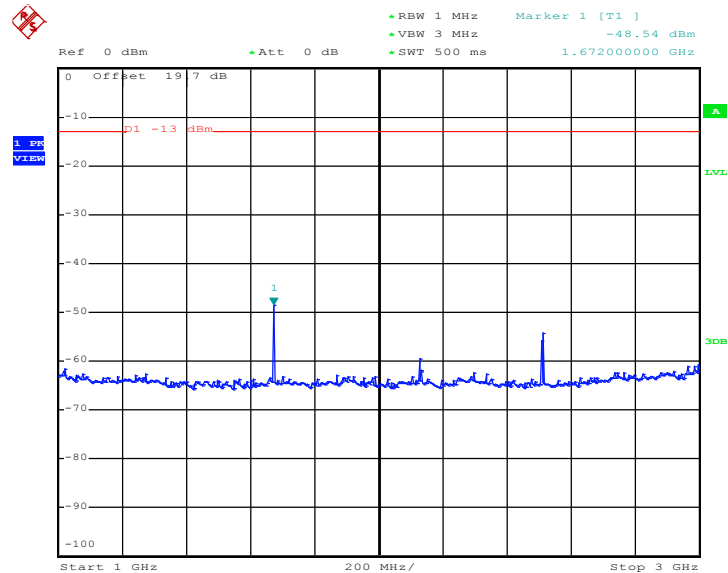

Date: 8.OCT.2012 13:44:12





### Conducted Spurious Emission Plot between 3GHz ~ 7GHz

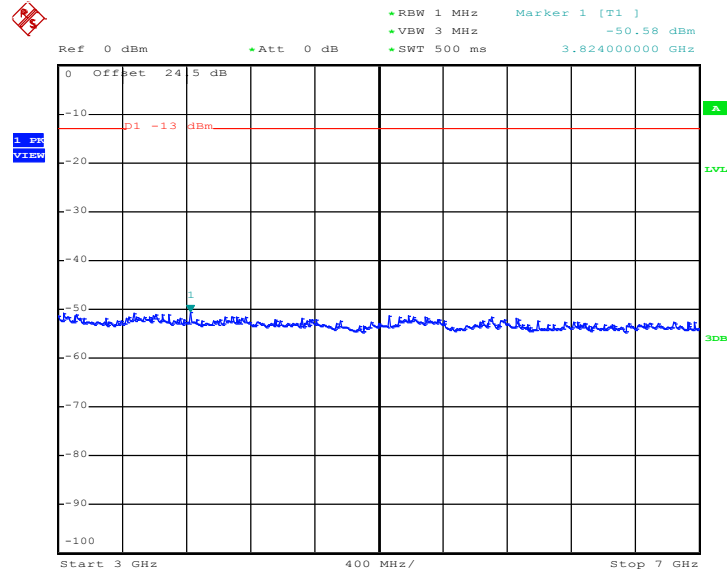

Date: 8.OCT.2012 13:44:25

### Conducted Spurious Emission Plot between 7GHz ~ 9GHz

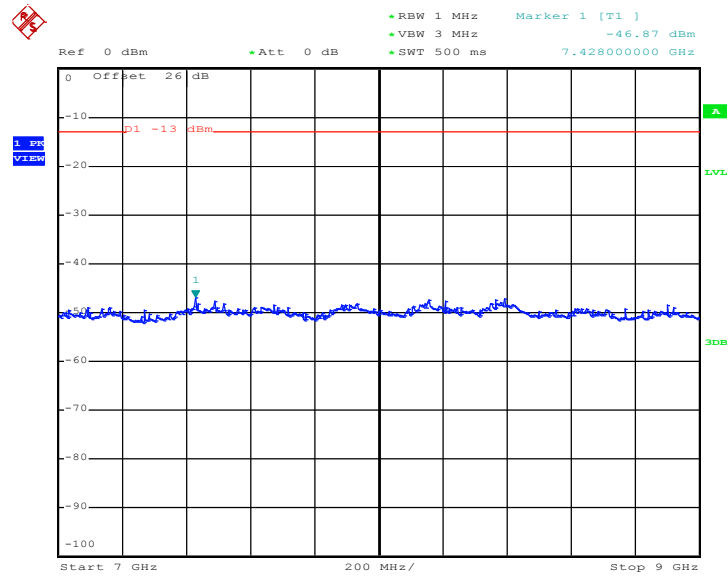

Date: 8.OCT.2012 13:44:37



Band :	GSM1900	Channel :	CH661
Test Mode :	GSM Link	Frequency :	1880.0 MHz

Conducted Spurious Emission Plot between 30MHz ~ 1GHz

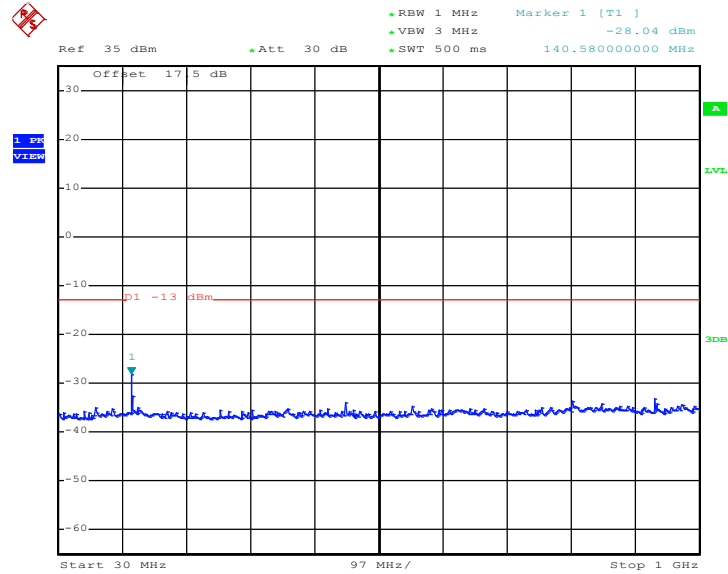

Date: 8.OCT.2012 15:06:23

Conducted Spurious Emission Plot between 1GHz ~ 3GHz

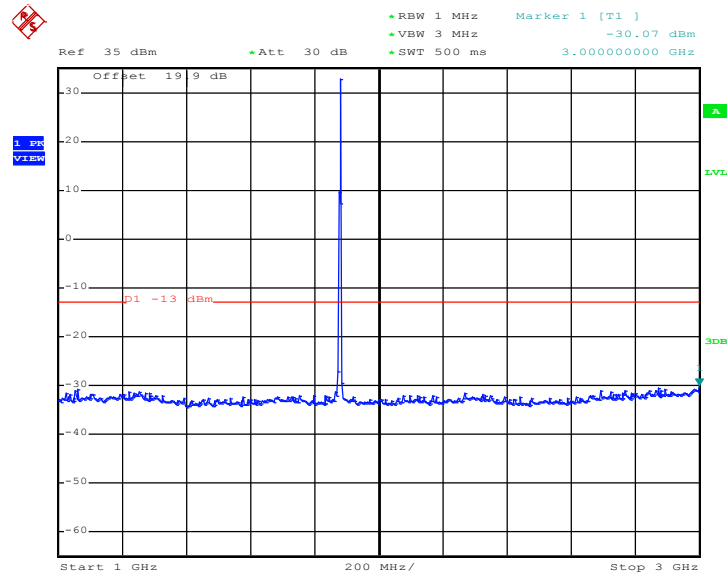

Date: 8.OCT.2012 15:06:35



### Conducted Spurious Emission Plot between 3GHz ~ 7GHz

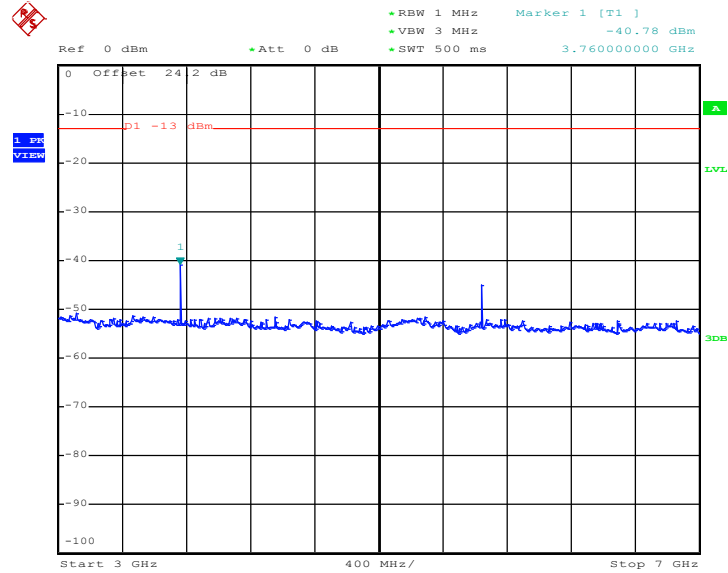

Date: 8.OCT.2012 15:06:52

### Conducted Spurious Emission Plot between 7GHz ~ 13.6G

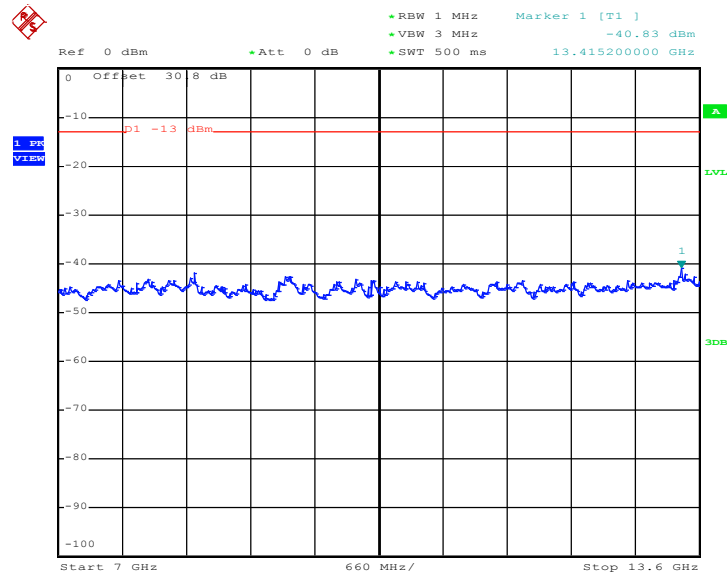

Date: 8.OCT.2012 15:07:05



Conducted Spurious Emission Plot between 13.6GHz ~ 19.1GHz

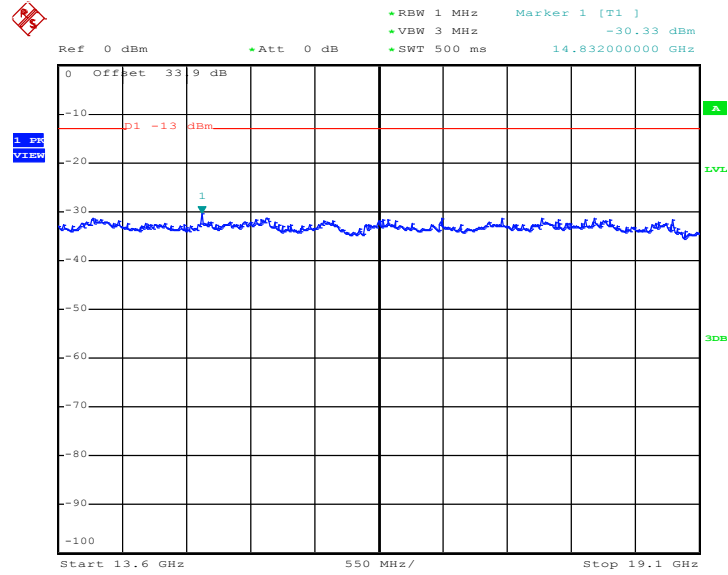

Date: 8.OCT.2012 15:07:17



Band :	GSM1900	Channel :	CH661
Test Mode :	EDGE 8 Link	Frequency :	1880.0 MHz

Conducted Spurious Emission Plot between 30MHz ~ 1GHz

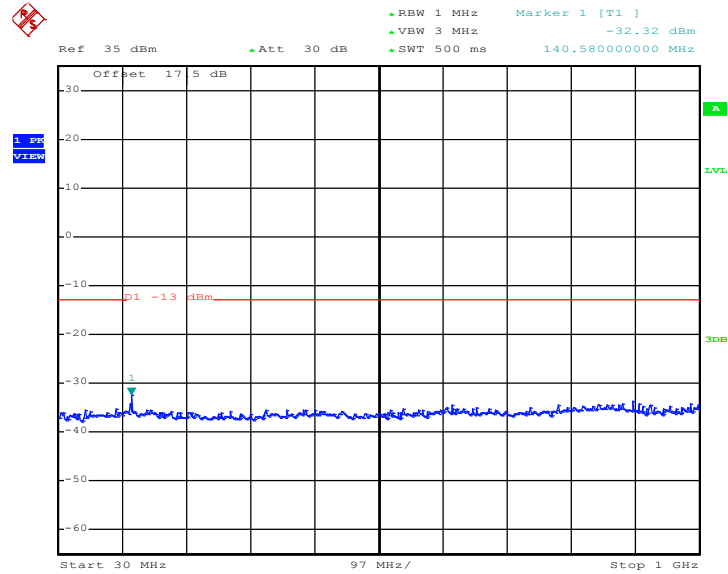

Date: 8.OCT.2012 14:20:20

Conducted Spurious Emission Plot between 1GHz ~ 3GHz

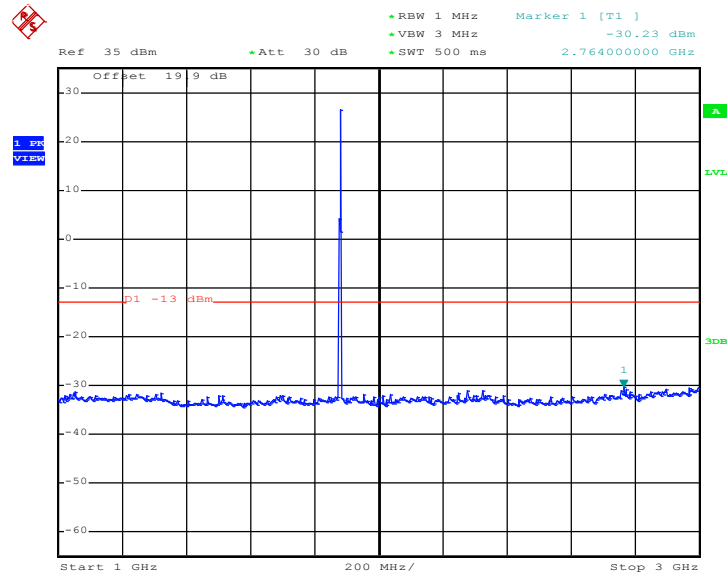

Date: 8.OCT.2012 14:20:32



### Conducted Spurious Emission Plot between 3GHz ~ 7GHz

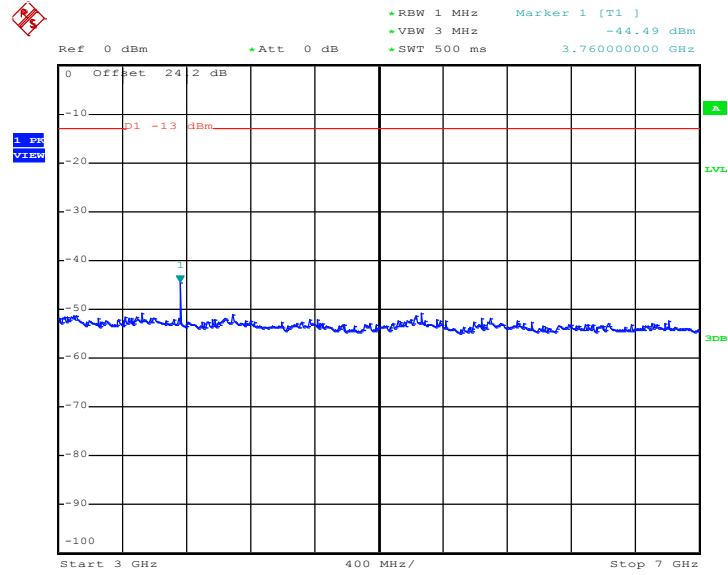

Date: 8.OCT.2012 14:20:52

### Conducted Spurious Emission Plot between 7GHz ~ 13.6GHz

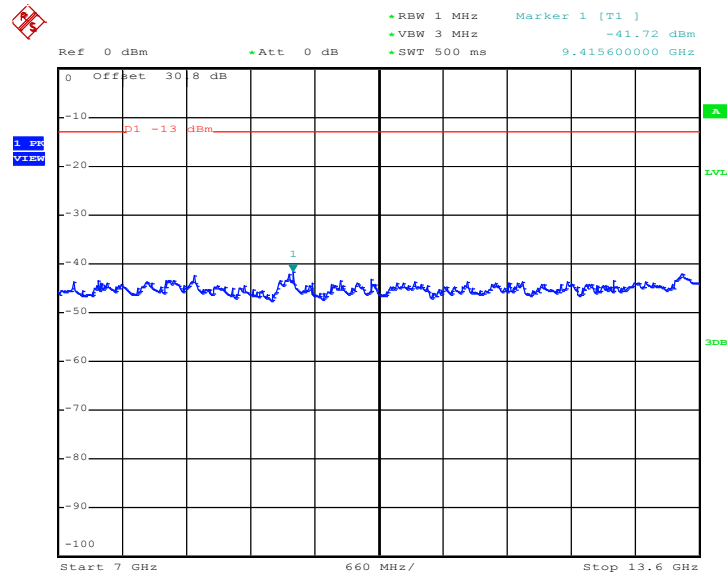

Date: 8.OCT.2012 14:21:05



Conducted Spurious Emission Plot between 13.6GHz ~ 19.1GHz

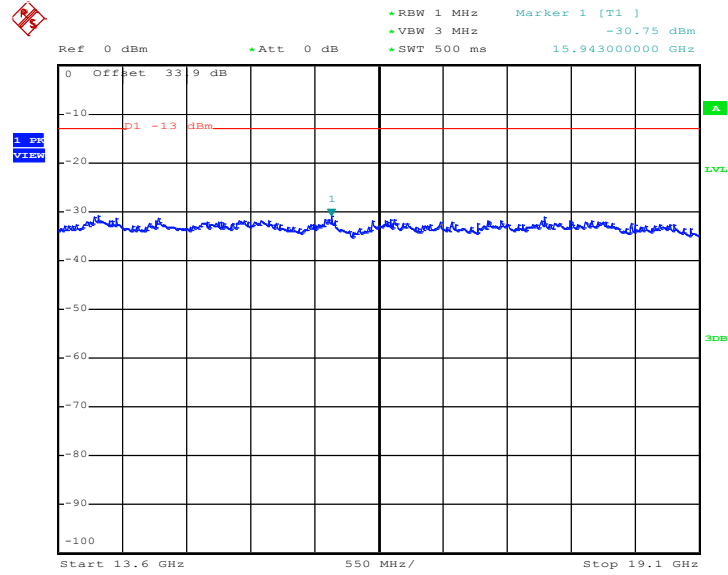

Date: 8.OCT.2012 14:21:17



Band :	WCDMA Band V	Channel :	CH4182
Test Mode :	RMC 12.2Kbps Link	Frequency :	836.4 MHz

Conducted Spurious Emission Plot between 30MHz ~ 1GHz

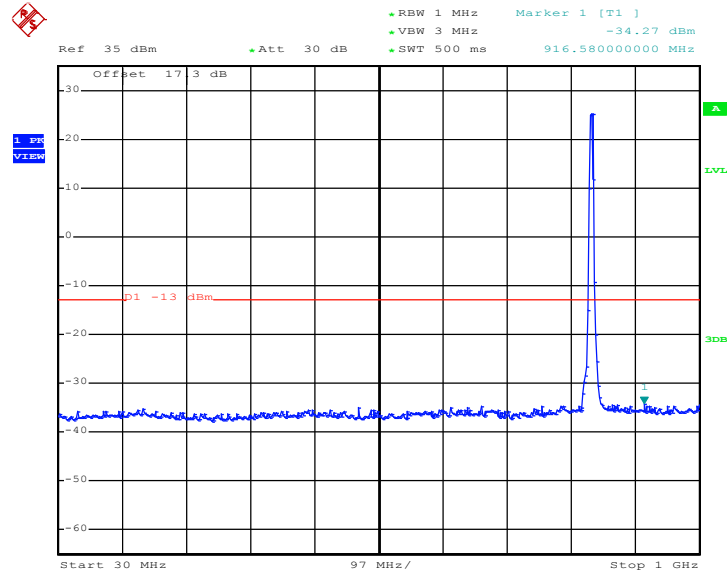

Date: 8.OCT.2012 15:47:35

Conducted Spurious Emission Plot between 1GHz ~ 3GHz

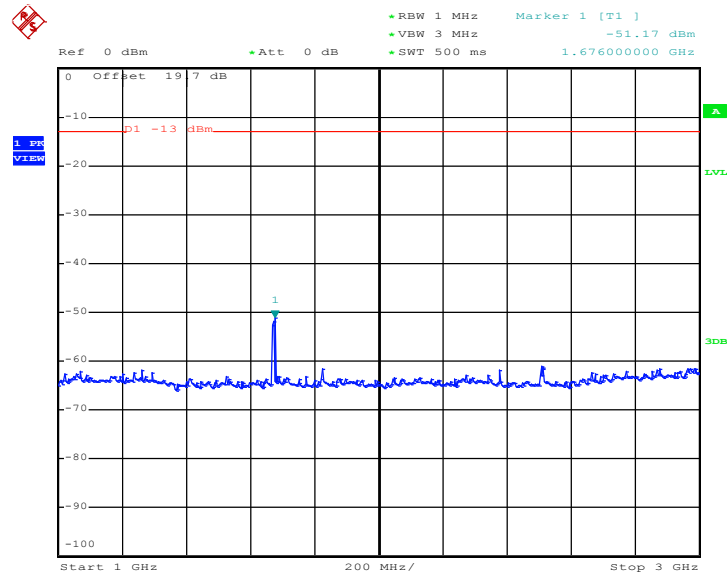

Date: 8.OCT.2012 15:47:51





### Conducted Spurious Emission Plot between 3GHz ~ 7GHz

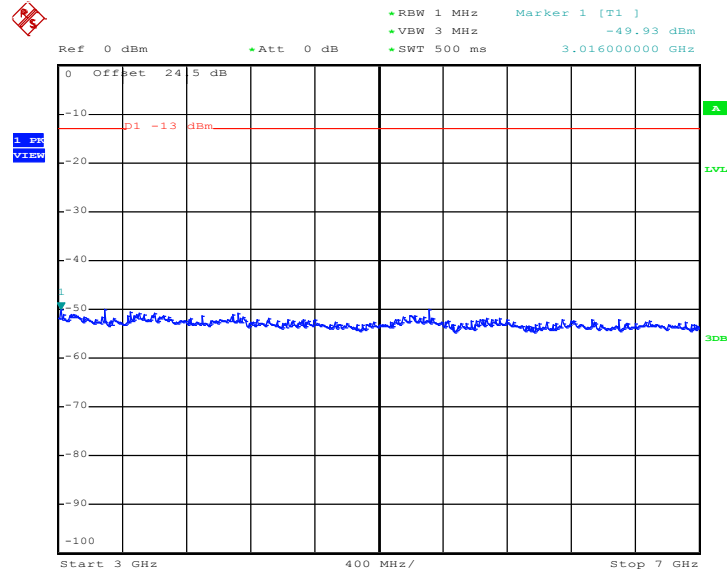

Date: 8.OCT.2012 15:48:04

### Conducted Spurious Emission Plot between 7GHz ~ 9GHz

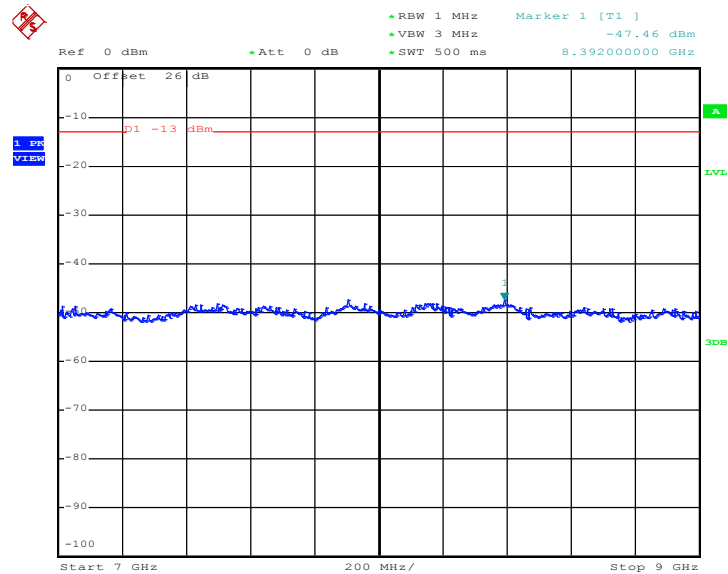

Date: 8.OCT.2012 15:48:16



Band :	WCDMA Band IV	Channel :	CH1413
Test Mode :	RMC 12.2Kbps Link	Frequency :	1732.6 MHz

Conducted Spurious Emission Plot between 30MHz ~ 1GHz

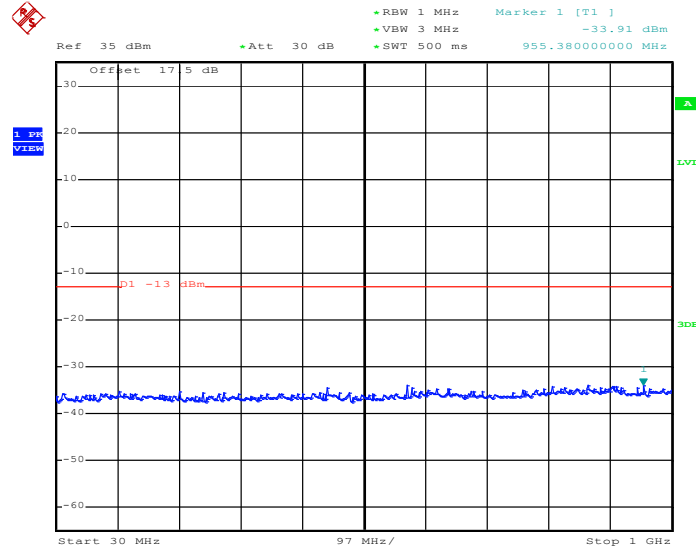

Date: 8.OCT.2012 15:41:36

Conducted Spurious Emission Plot between 1GHz ~ 3GHz

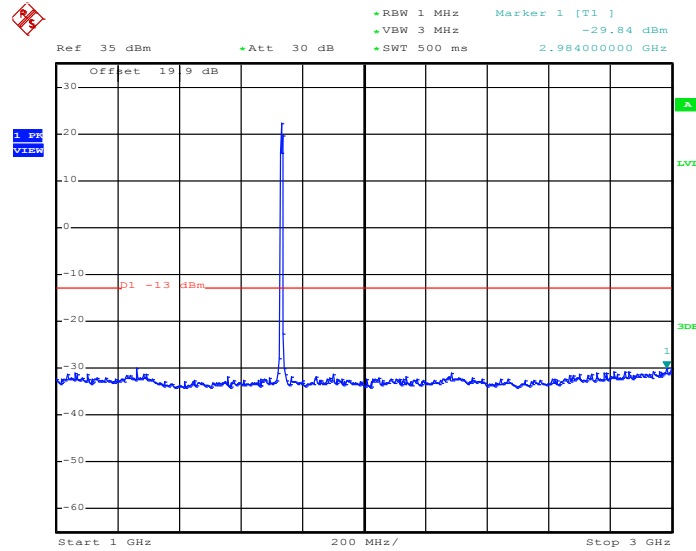

Date: 8.OCT.2012 15:41:48



### Conducted Spurious Emission Plot between 3GHz ~ 7GHz

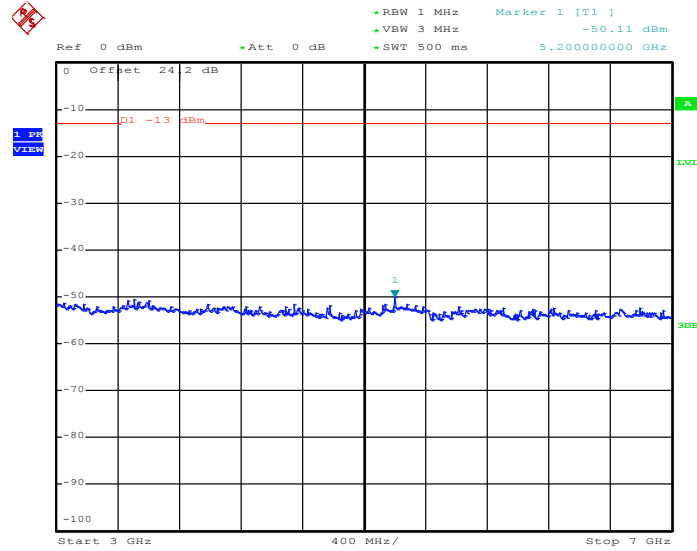

Date: 8.OCT.2012 15:42:05

### Conducted Spurious Emission Plot between 7GHz ~ 13.6GHz

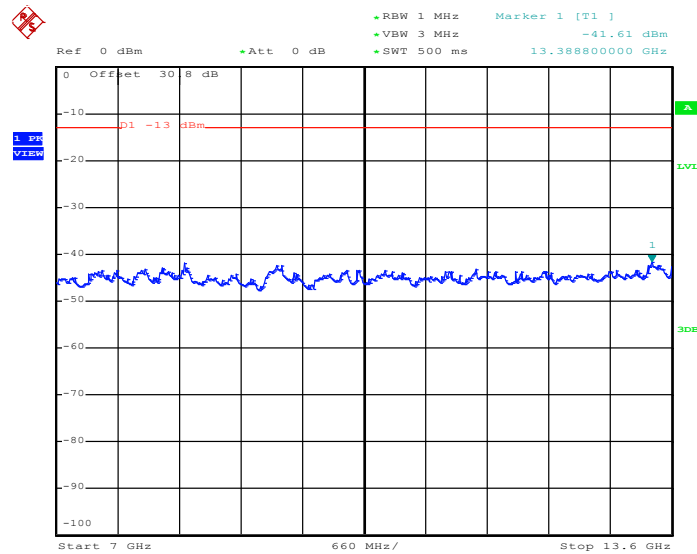

Date: 8.OCT.2012 15:42:17



Conducted Spurious Emission Plot between 13.6GHz ~ 18GHz

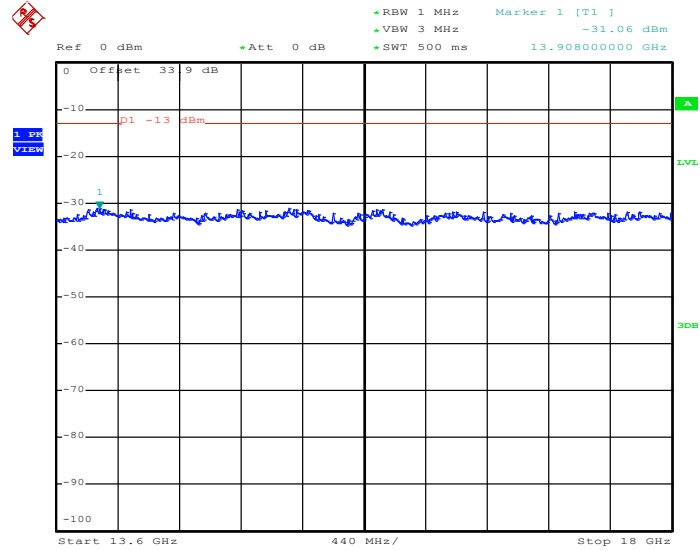

Date: 8.OCT.2012 15:42:30



Band :	WCDMA Band II	Channel :	CH9400
Test Mode :	RMC 12.2Kbps Link	Frequency :	1880.0 MHz

Conducted Spurious Emission Plot between 30MHz ~ 1GHz

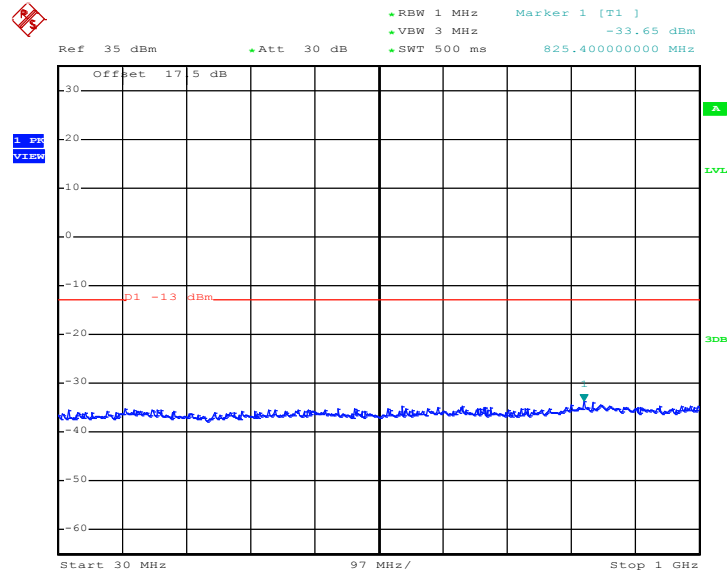

Date: 8.OCT.2012 15:16:15

Conducted Spurious Emission Plot between 1GHz ~ 3GHz

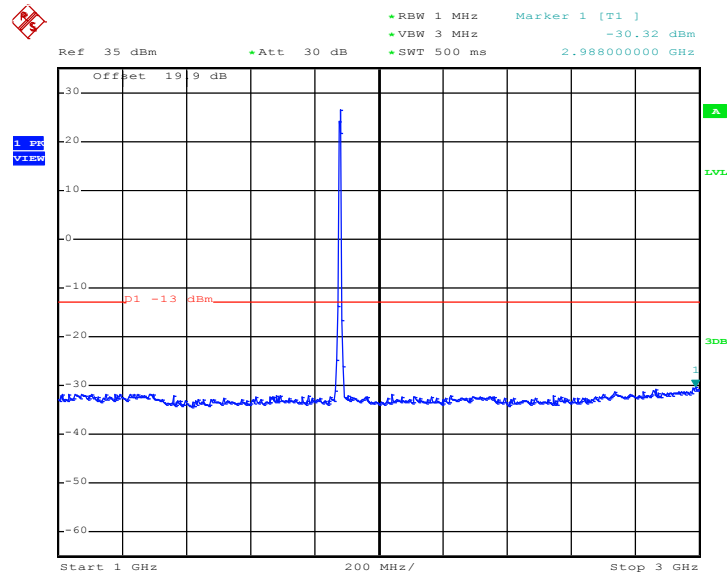

Date: 8.OCT.2012 15:16:28



### Conducted Spurious Emission Plot between 3GHz ~ 7GHz

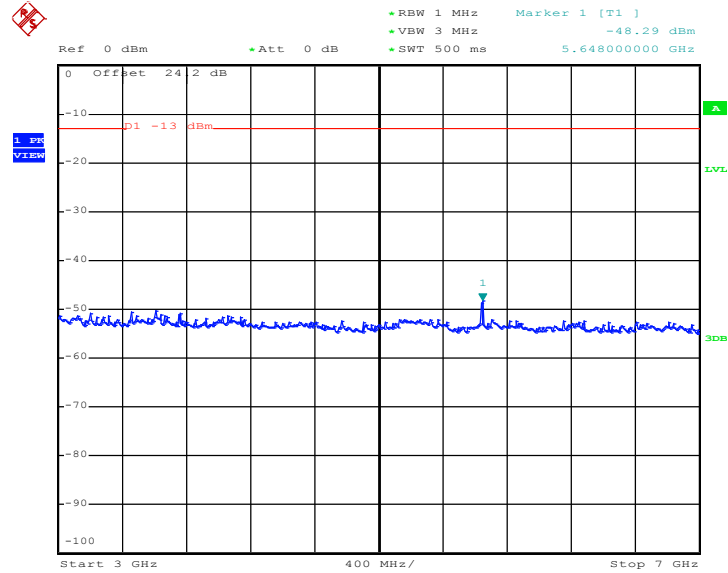

Date: 8.OCT.2012 15:16:49

### Conducted Spurious Emission Plot between 7GHz ~ 13.6GHz

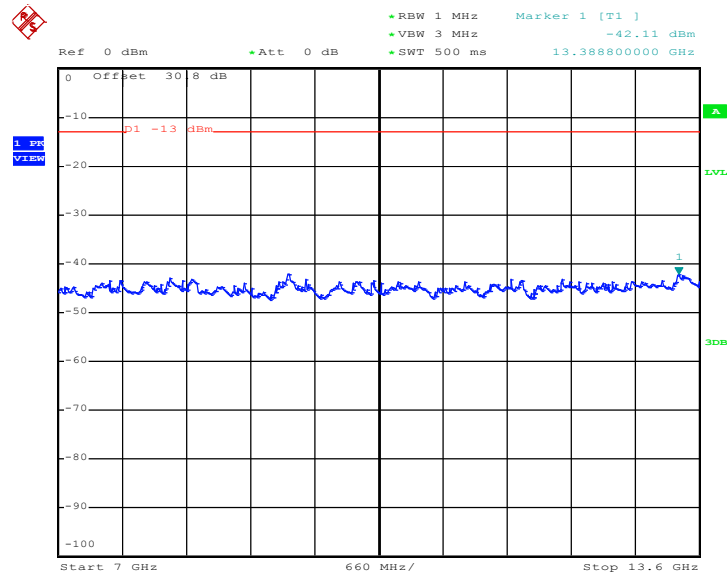

Date: 8.OCT.2012 15:17:01



Conducted Spurious Emission Plot between 13.6GHz ~ 19.1GHz

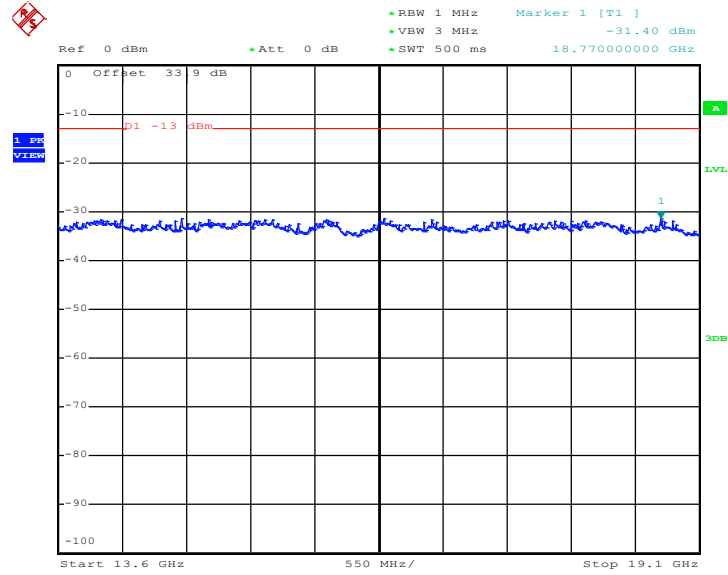

Date: 8.OCT.2012 15:17:13

## 3.7 Field Strength of Spurious Radiation Measurement

### 3.7.1 Description of Field Strength of Spurious Radiated Measurement

The power of any emission outside of the authorized operating frequency ranges must be attenuated below the transmitter power (P) by a factor of at least  $43 + 10 \log (P)$  dB. The spectrum is scanned from 30 MHz up to a frequency including its 10th harmonic.

### 3.7.2 Measuring Instruments

See list of measuring instruments of this test report.

### 3.7.3 Test Procedures

1. The EUT was placed on a rotatable wooden table with 0.8 meter above ground.
2. The EUT was set 3 meters from the receiving antenna, which was mounted on the antenna tower.
3. The table was rotated 360 degrees to determine the position of the highest spurious emission.
4. The height of the receiving antenna is varied between one meter and four meters to search the maximum spurious emission for both horizontal and vertical polarizations.
5. Make the measurement with the spectrum analyzer's RBW = 1MHz, VBW = 3MHz, taking the record of maximum spurious emission.
6. A horn antenna was substituted in place of the EUT and was driven by a signal generator.
7. Tune the output power of signal generator to the same emission level with EUT maximum spurious emission.
8. Taking the record of output power at antenna port.
9. Repeat step 7 to step 8 for another polarization.
10.  $EIRP \text{ (dBm)} = S.G. \text{ Power} - Tx \text{ Cable Loss} + Tx \text{ Antenna Gain}$
11.  $ERP \text{ (dBm)} = EIRP - 2.15$



### 3.7.4 Test Setup

For radiated emissions below 30MHz

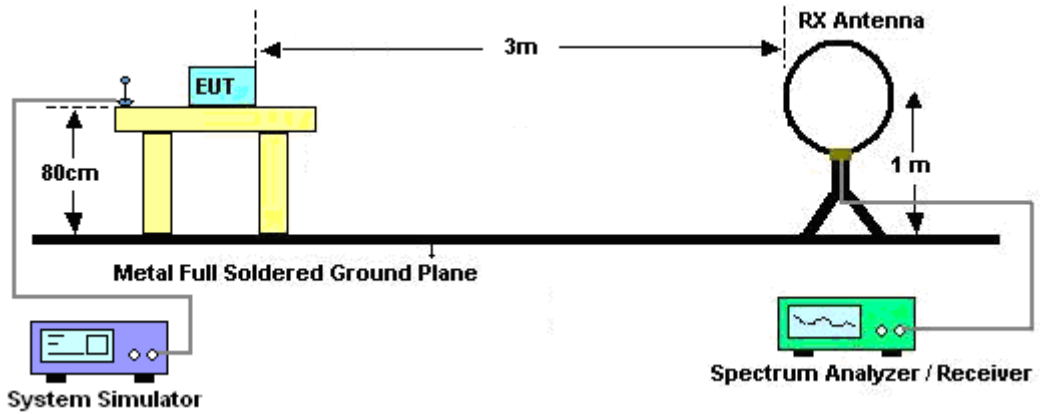

For radiated emissions from 30MHz to 1GHz

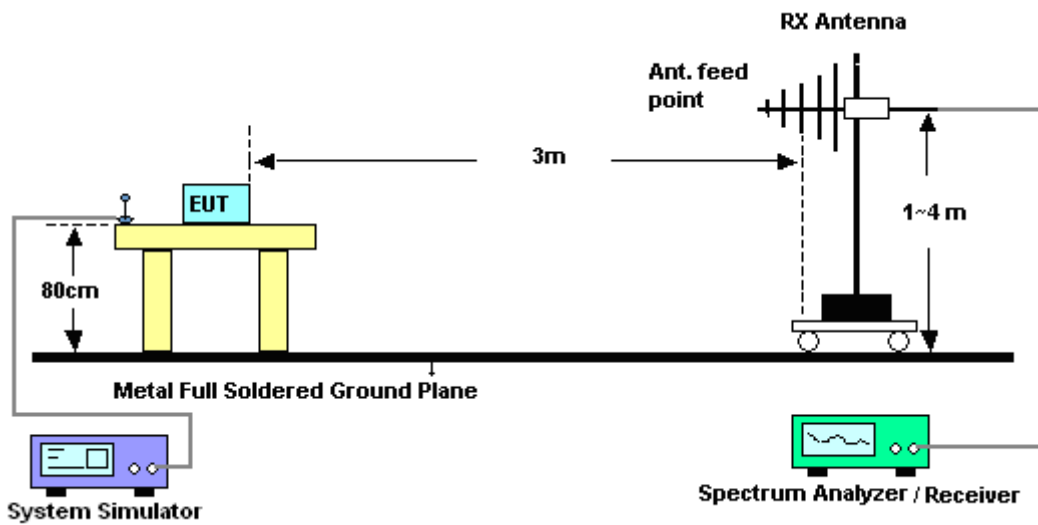

For radiated emissions above 1GHz

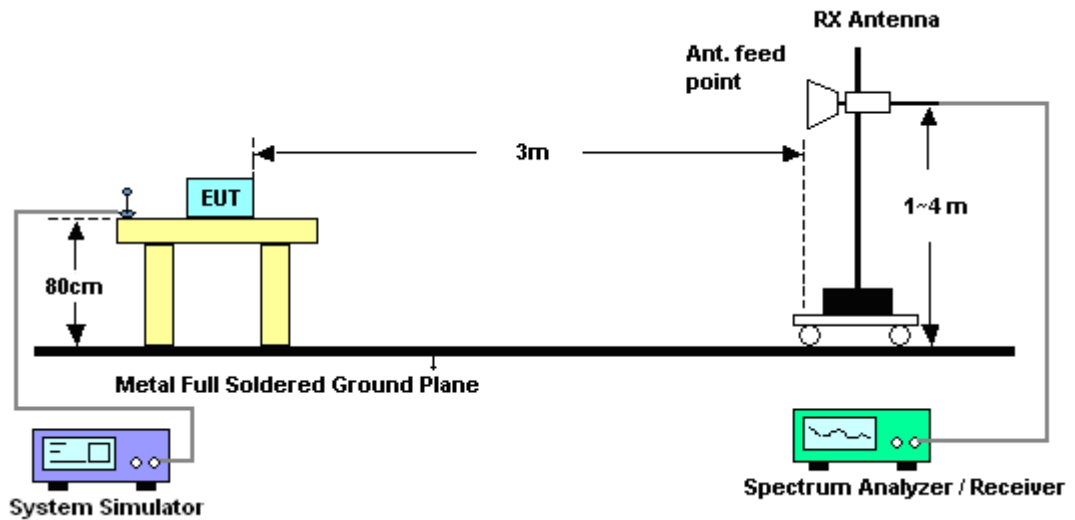

### 3.7.5 Test Results of Radiated Emissions (9 KHz ~ 30 MHz)

The low frequency, which started from 9 KHz to 30MHz, was pre-scanned and the result which was 20dB lower than the limit line per 15.31(o) was not reported.



3.7.6 Test Result of Field Strength of Spurious Radiated

<Sample1>

Band :	GSM850	Temperature :	20~22°C
Test Mode :	GSM Link	Relative Humidity :	40~42%
Test Engineer :	David Ke	Polarization :	Horizontal
Remark :	Spurious emissions within 30-1000MHz were found more than 20dB below limit line.		

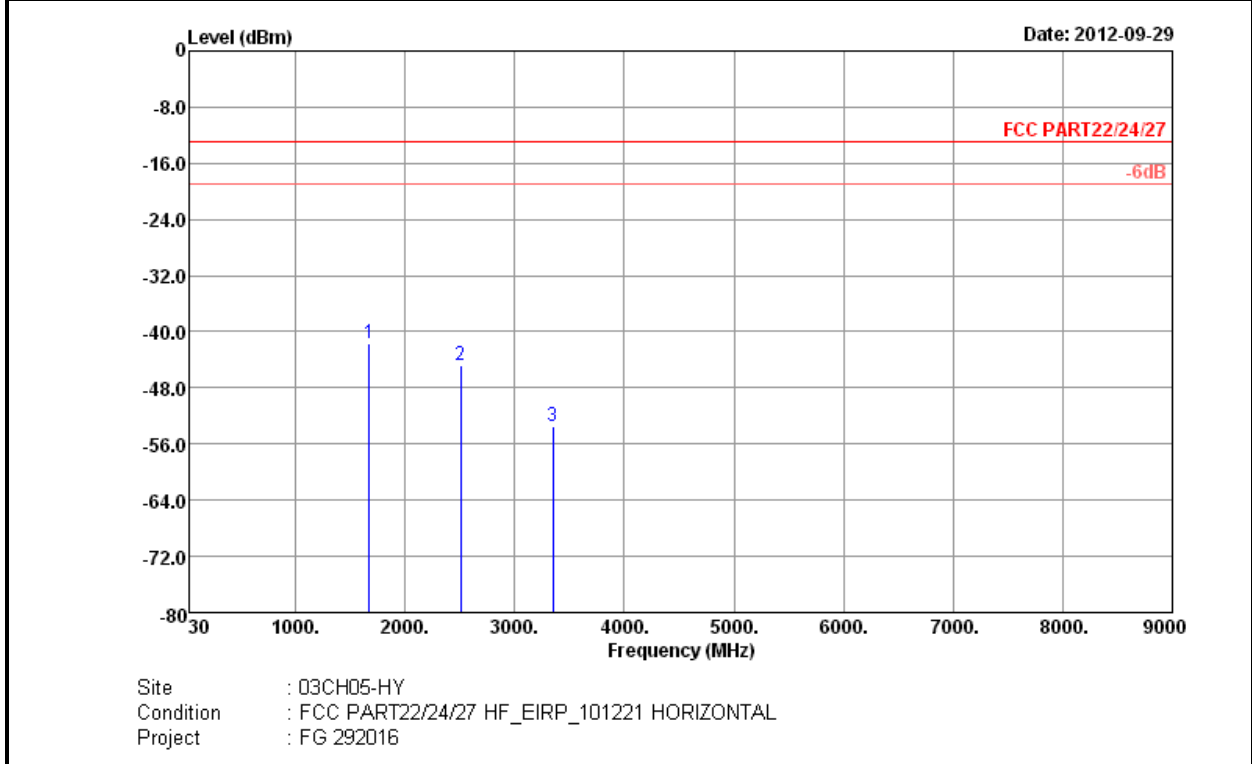

Frequency ( MHz )	ERP ( dBm )	Limit ( dBm )	Over Limit ( dB )	SPA Reading ( dBm )	S.G. Power ( dBm )	TX Cable loss ( dB )	TX Antenna Gain ( dBi )	Polarization ( H/V )	Result
1672	-41.74	-13	-28.74	-47.67	-43.5	1.35	5.25	H	Pass
2509	-44.72	-13	-31.72	-54.21	-47.1	1.58	6.11	H	Pass
3346	-53.40	-13	-40.40	-65.06	-57.25	1.94	7.94	H	Pass



<b>Band :</b>	GSM850	<b>Temperature :</b>	20~22°C
<b>Test Mode :</b>	GSM Link	<b>Relative Humidity :</b>	40~42%
<b>Test Engineer :</b>	David Ke	<b>Polarization :</b>	Vertical
<b>Remark :</b>	Spurious emissions within 30-1000MHz were found more than 20dB below limit line.		

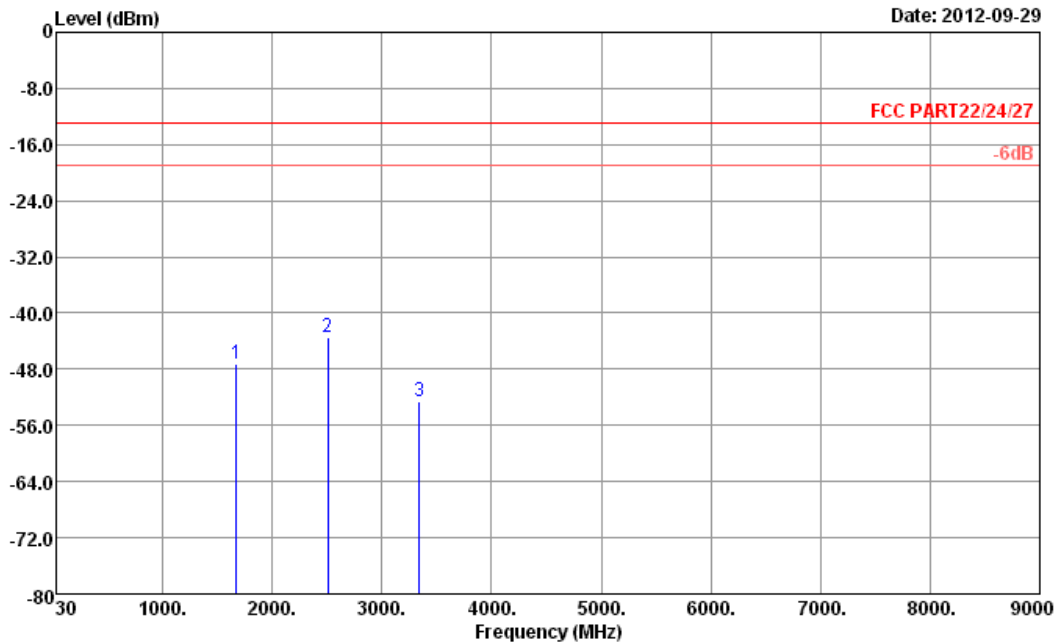

Site : 03CH05-HY  
 Condition : FCC PART22/24/27 HF\_EIRP\_101221 VERTICAL  
 Project : FG 292016

Frequency ( MHz )	ERP ( dBm )	Limit ( dBm )	Over Limit ( dB )	SPA Reading ( dBm )	S.G. Power ( dBm )	TX Cable loss ( dB )	TX Antenna Gain ( dBi )	Polarization ( H/V )	Result
1672	-47.24	-13	-34.24	-53.22	-49	1.35	5.25	V	Pass
2509	-43.45	-13	-30.45	-52.73	-45.83	1.58	6.11	V	Pass
3345	-52.57	-13	-39.57	-64.23	-56.42	1.94	7.94	V	Pass



<Sample2>

<b>Band :</b>	GSM850	<b>Temperature :</b>	20~22°C
<b>Test Mode :</b>	GSM Link	<b>Relative Humidity :</b>	40~42%
<b>Test Engineer :</b>	David Ke	<b>Polarization :</b>	Horizontal
<b>Remark :</b>	Spurious emissions within 30-1000MHz were found more than 20dB below limit line.		

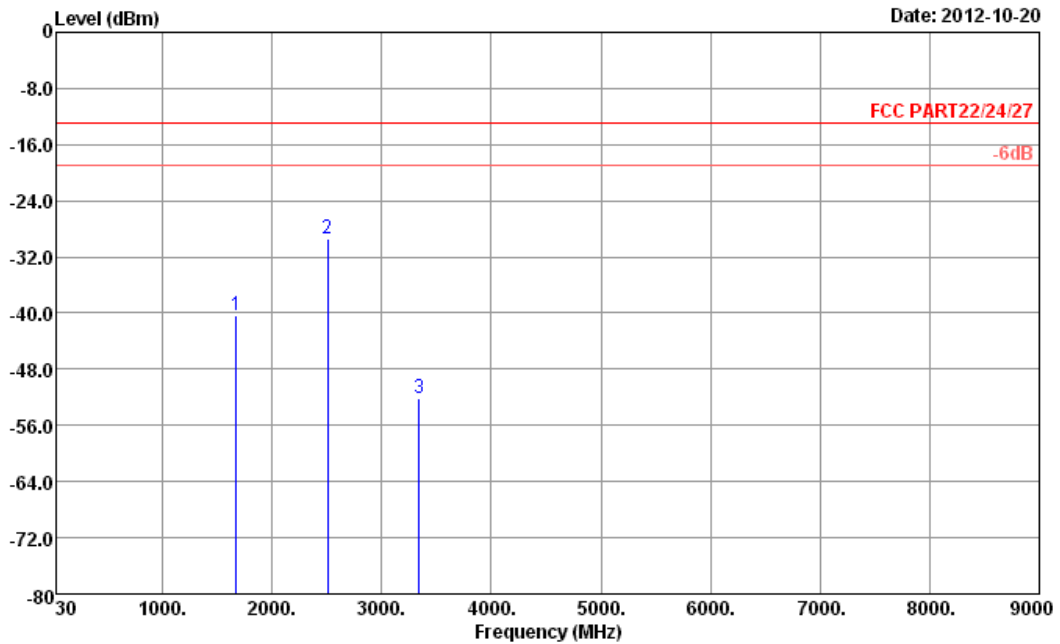

Site : 03CH05-HY  
 Condition : FCC PART22/24/27 HF\_EIRP\_101221 HORIZONTAL  
 Project : FG 292016

Frequency ( MHz )	ERP ( dBm )	Limit ( dBm )	Over Limit ( dB )	SPA Reading ( dBm )	S.G. Power ( dBm )	TX Cable loss ( dB )	TX Antenna Gain ( dBi )	Polarization ( H/V )	Result
1672	-40.39	-13	-27.39	-46.53	-42.15	1.35	5.25	H	Pass
2509	-29.49	-13	-16.49	-38.41	-31.87	1.58	6.11	H	Pass
3345	-52.12	-13	-39.12	-63.96	-55.97	1.94	7.94	H	Pass



<b>Band :</b>	GSM850	<b>Temperature :</b>	20~22°C
<b>Test Mode :</b>	GSM Link	<b>Relative Humidity :</b>	40~42%
<b>Test Engineer :</b>	David Ke	<b>Polarization :</b>	Vertical
<b>Remark :</b>	Spurious emissions within 30-1000MHz were found more than 20dB below limit line.		

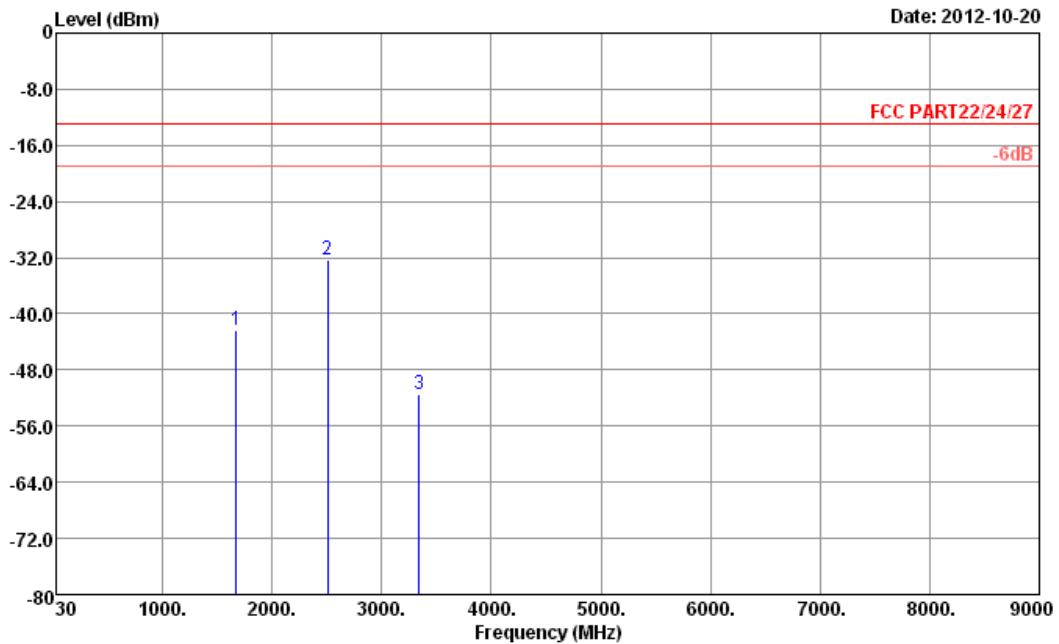

Site : 03CH05-HY  
 Condition : FCC PART22/24/27 HF\_EIRP\_101221 VERTICAL  
 Project : FG 292016

Frequency ( MHz )	ERP ( dBm )	Limit ( dBm )	Over Limit ( dB )	SPA Reading ( dBm )	S.G. Power ( dBm )	TX Cable loss ( dB )	TX Antenna Gain ( dBi )	Polarization ( H/V )	Result
1672	-42.45	-13	-29.45	-49.11	-44.21	1.35	5.25	V	Pass
2509	-32.30	-13	-19.30	-42.35	-34.68	1.58	6.11	V	Pass
3345	-51.53	-13	-38.53	-63.89	-55.38	1.94	7.94	V	Pass



<Sample 1>

<b>Band :</b>	GSM850	<b>Temperature :</b>	20~22°C
<b>Test Mode :</b>	EDGE 8 Link	<b>Relative Humidity :</b>	40~42%
<b>Test Engineer :</b>	David Ke	<b>Polarization :</b>	Horizontal
<b>Remark :</b>	Spurious emissions within 30-1000MHz were found more than 20dB below limit line.		

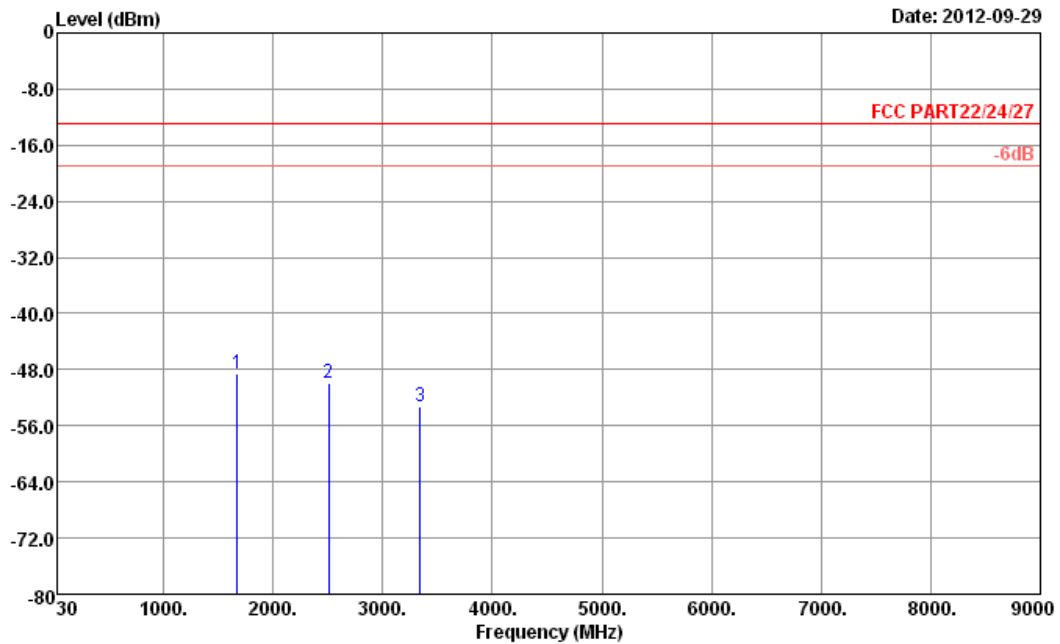

Site : 03CH05-HY  
 Condition : FCC PART22/24/27 HF\_EIRP\_101221 HORIZONTAL  
 Project : FG 292016

Frequency ( MHz )	ERP ( dBm )	Limit ( dBm )	Over Limit ( dB )	SPA Reading ( dBm )	S.G. Power ( dBm )	TX Cable loss ( dB )	TX Antenna Gain ( dBi )	Polarization ( H/V )	Result
1672	-48.58	-13	-35.58	-54.91	-50.34	1.35	5.25	H	Pass
2509	-50.00	-13	-37.00	-59.25	-52.38	1.58	6.11	H	Pass
3345	-53.16	-13	-40.16	-64.68	-57.01	1.94	7.94	H	Pass



<b>Band :</b>	GSM850	<b>Temperature :</b>	20~22°C
<b>Test Mode :</b>	EDGE 8 Link	<b>Relative Humidity :</b>	40~42%
<b>Test Engineer :</b>	David Ke	<b>Polarization :</b>	Vertical
<b>Remark :</b>	Spurious emissions within 30-1000MHz were found more than 20dB below limit line.		

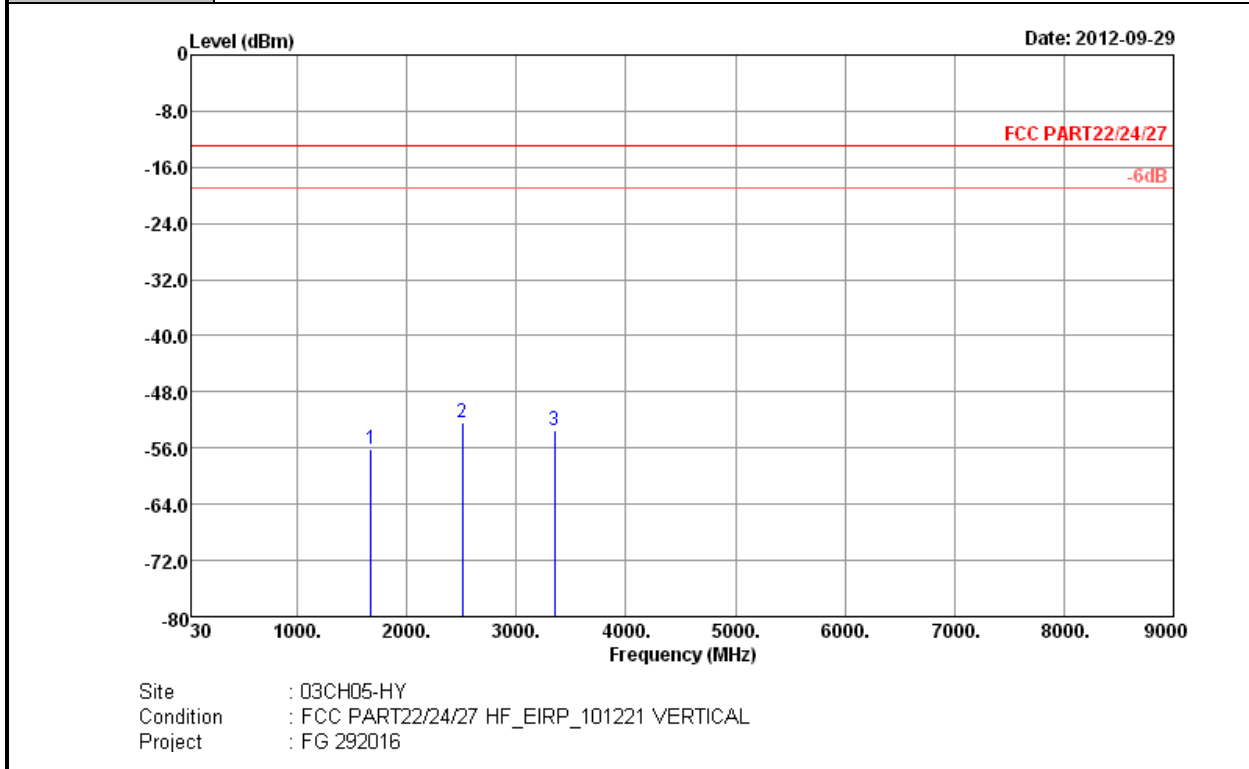

Frequency ( MHz )	ERP ( dBm )	Limit ( dBm )	Over Limit ( dB )	SPA Reading ( dBm )	S.G. Power ( dBm )	TX Cable loss ( dB )	TX Antenna Gain ( dBi )	Polarization ( H/V )	Result
1672	-56.08	-13	-43.08	-62.04	-57.84	1.35	5.25	V	Pass
2509	-52.30	-13	-39.30	-61.62	-54.68	1.58	6.11	V	Pass
3346	-53.54	-13	-40.54	-65.12	-57.39	1.94	7.94	V	Pass





<Sample 1>

<b>Band :</b>	GSM1900	<b>Temperature :</b>	20~22°C
<b>Test Mode :</b>	GSM Link	<b>Relative Humidity :</b>	40~42%
<b>Test Engineer :</b>	David Ke	<b>Polarization :</b>	Horizontal
<b>Remark :</b>	Spurious emissions within 30-1000MHz were found more than 20dB below limit line.		

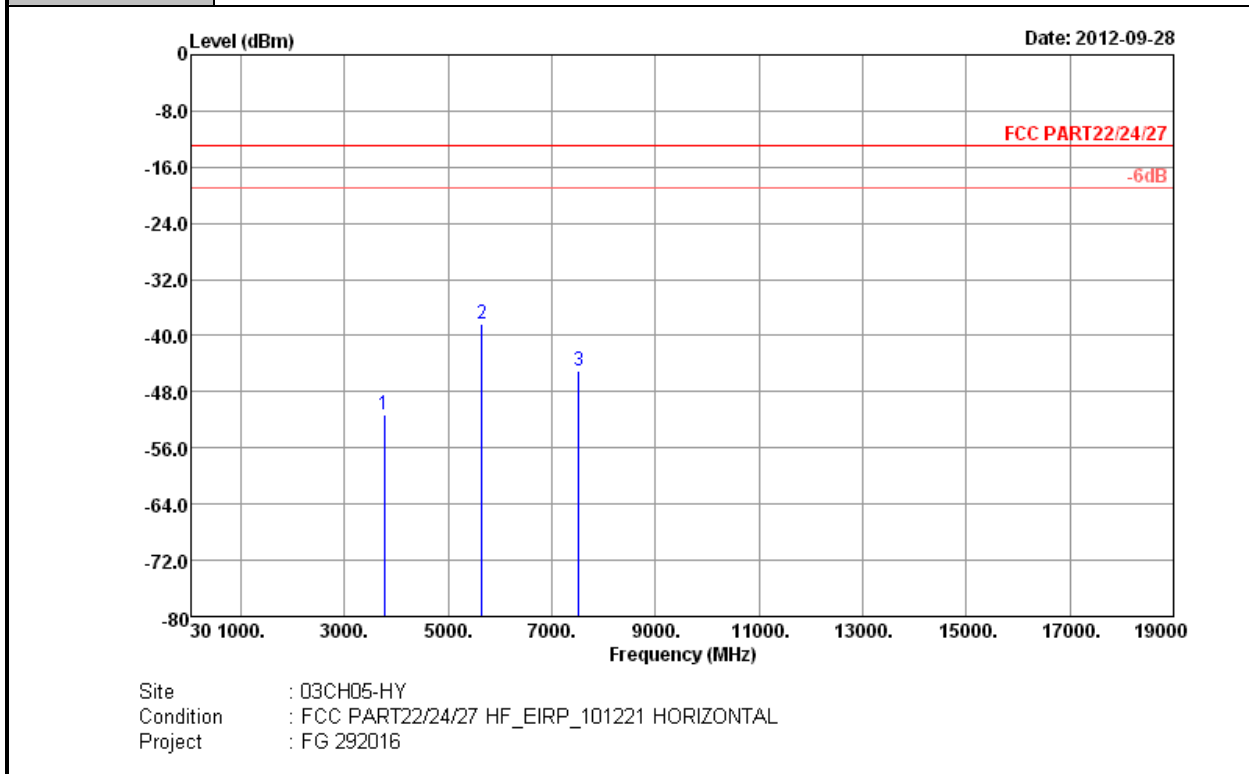

Frequency ( MHz )	EIRP ( dBm )	Limit ( dBm )	Over Limit ( dB )	SPA Reading ( dBm )	S.G. Power ( dBm )	TX Cable loss ( dB )	TX Antenna Gain ( dBi )	Polarization ( H/V )	Result
3760	-51.29	-13	-38.29	-64.99	-58	2.00	8.71	H	Pass
5640	-38.36	-13	-25.36	-57.3	-47	2.13	10.77	H	Pass
7520	-45.06	-13	-32.06	-67.1	-54.6	2.68	12.22	H	Pass



<b>Band :</b>	GSM1900	<b>Temperature :</b>	20~22°C
<b>Test Mode :</b>	GSM Link	<b>Relative Humidity :</b>	40~42%
<b>Test Engineer :</b>	David Ke	<b>Polarization :</b>	Vertical
<b>Remark :</b>	Spurious emissions within 30-1000MHz were found more than 20dB below limit line.		

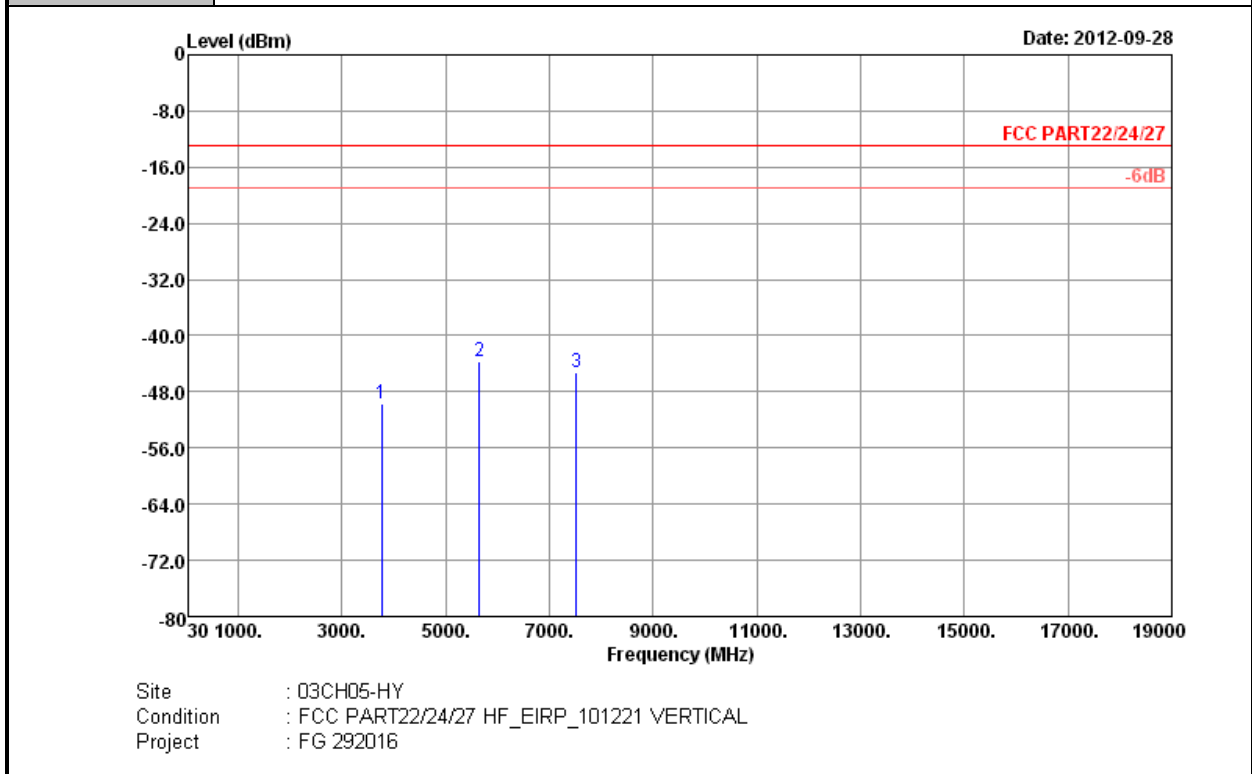

Frequency ( MHz )	EIRP ( dBm )	Limit ( dBm )	Over Limit ( dB )	SPA Reading ( dBm )	S.G. Power ( dBm )	TX Cable loss ( dB )	TX Antenna Gain ( dBi )	Polarization ( H/V )	Result
3760	-49.79	-13	-36.79	-63.41	-56.5	2.00	8.71	V	Pass
5640	-43.76	-13	-30.76	-62.67	-52.4	2.13	10.77	V	Pass
7520	-45.26	-13	-32.26	-67.24	-54.8	2.68	12.22	V	Pass



<Sample 2>

<b>Band :</b>	GSM1900	<b>Temperature :</b>	20~22°C
<b>Test Mode :</b>	GSM Link	<b>Relative Humidity :</b>	40~42%
<b>Test Engineer :</b>	David Ke	<b>Polarization :</b>	Horizontal
<b>Remark :</b>	Spurious emissions within 30-1000MHz were found more than 20dB below limit line.		

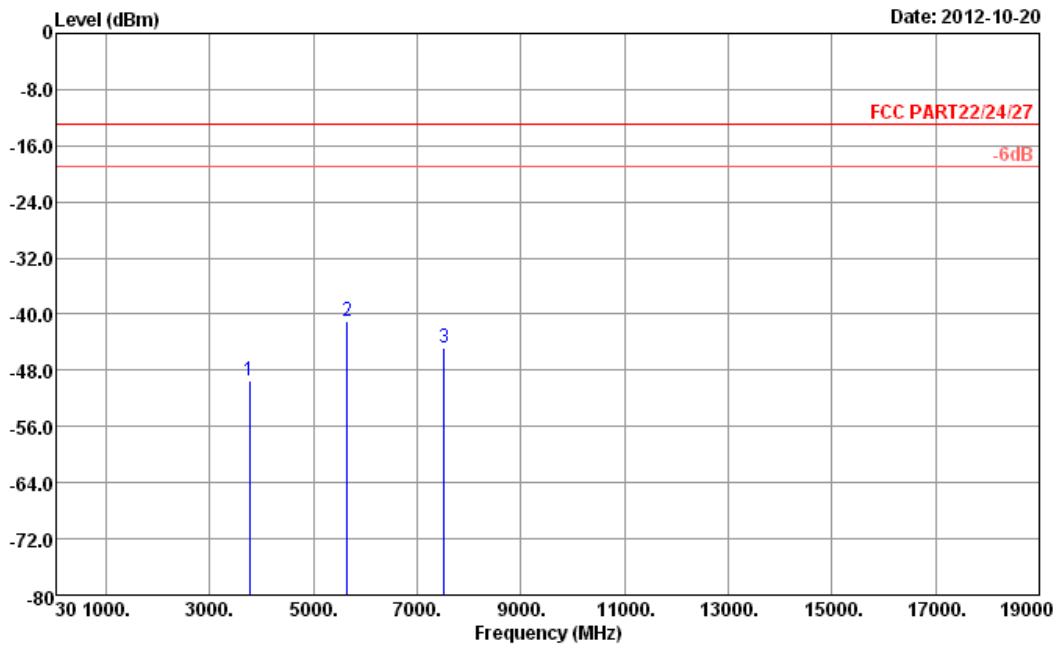

Site : 03CH05-HY  
 Condition : FCC PART22/24/27 HF\_EIRP\_101221 HORIZONTAL  
 Project : FG 292016

Frequency ( MHz )	EIRP ( dBm )	Limit ( dBm )	Over Limit ( dB )	SPA Reading ( dBm )	S.G. Power ( dBm )	TX Cable loss ( dB )	TX Antenna Gain ( dBi )	Polarization ( H/V )	Result
3760	-49.53	-13	-36.53	-63.95	-56.24	2.00	8.71	H	Pass
5640	-41.04	-13	-28.04	-60.97	-49.68	2.13	10.77	H	Pass
7520	-44.85	-13	-31.85	-67.17	-54.39	2.68	12.22	H	Pass



<b>Band :</b>	GSM1900	<b>Temperature :</b>	20~22°C
<b>Test Mode :</b>	GSM Link	<b>Relative Humidity :</b>	40~42%
<b>Test Engineer :</b>	David Ke	<b>Polarization :</b>	Vertical
<b>Remark :</b>	Spurious emissions within 30-1000MHz were found more than 20dB below limit line.		

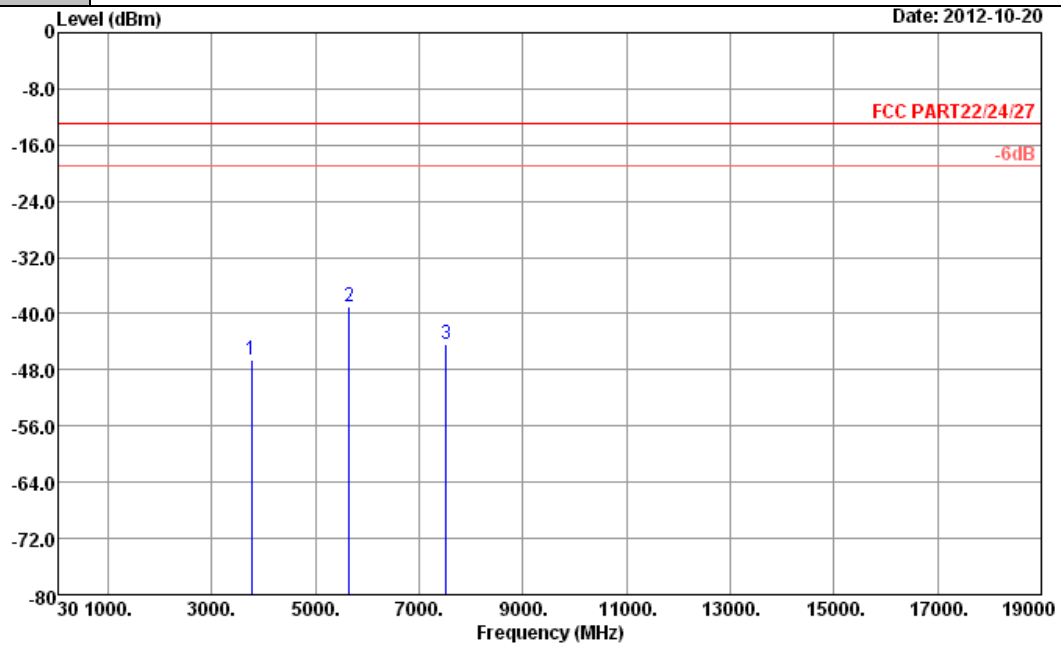

Site : 03CH05-HY  
 Condition : FCC PART22/24/27 HF\_EIRP\_101221 VERTICAL  
 Project : FG 292016

Frequency ( MHz )	EIRP ( dBm )	Limit ( dBm )	Over Limit ( dB )	SPA Reading ( dBm )	S.G. Power ( dBm )	TX Cable loss ( dB )	TX Antenna Gain ( dBi )	Polarization ( H/V )	Result
3760	-46.56	-13	-33.56	-61.13	-53.27	2.00	8.71	V	Pass
5640	-38.94	-13	-25.94	-58.23	-47.58	2.13	10.77	V	Pass
7520	-44.27	-13	-31.27	-67.28	-53.81	2.68	12.22	V	Pass



<Sample 1>

<b>Band :</b>	GSM1900	<b>Temperature :</b>	20~22°C
<b>Test Mode :</b>	EDGE 8 Link	<b>Relative Humidity :</b>	40~42%
<b>Test Engineer :</b>	David Ke	<b>Polarization :</b>	Horizontal
<b>Remark :</b>	Spurious emissions within 30-1000MHz were found more than 20dB below limit line.		

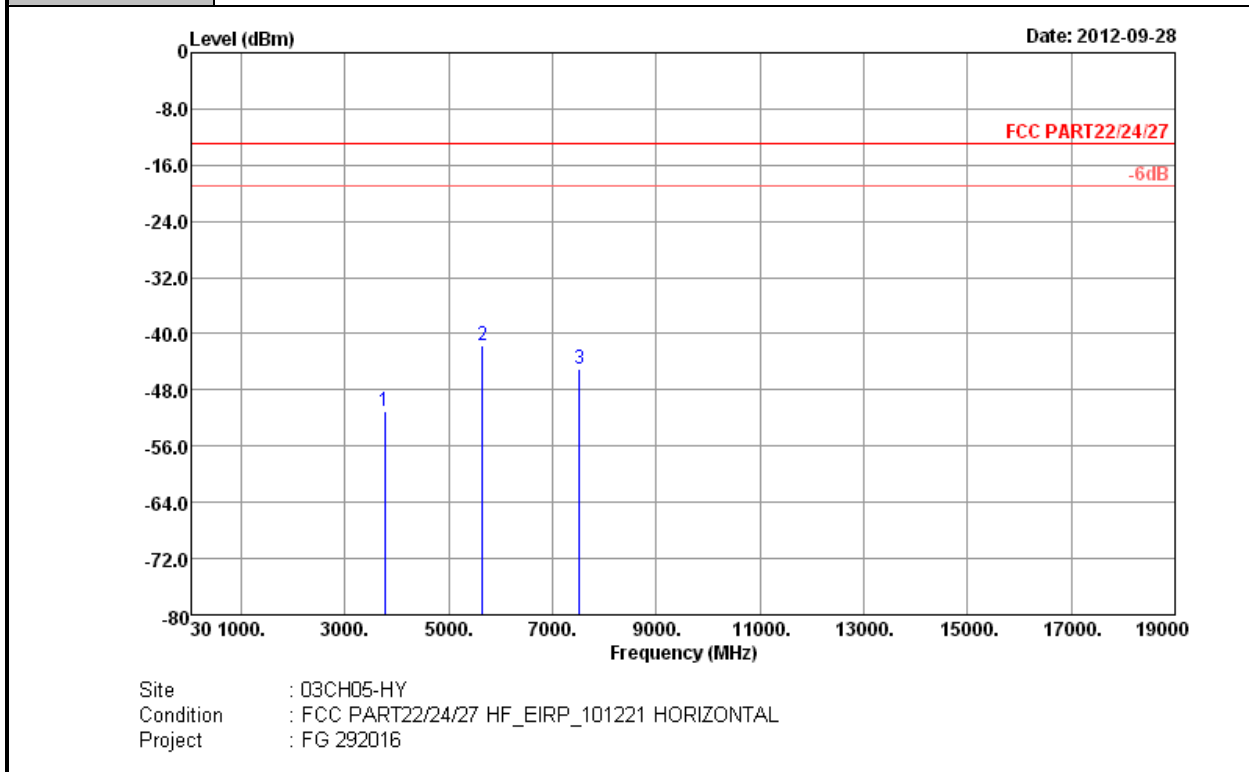

Frequency ( MHz )	EIRP ( dBm )	Limit ( dBm )	Over Limit ( dB )	SPA Reading ( dBm )	S.G. Power ( dBm )	TX Cable loss ( dB )	TX Antenna Gain ( dBi )	Polarization ( H/V )	Result
3760	-50.99	-13	-37.99	-64.44	-57.7	2.00	8.71	H	Pass
5640	-41.76	-13	-28.76	-60.63	-50.4	2.13	10.77	H	Pass
7520	-45.06	-13	-32.06	-67.04	-54.6	2.68	12.22	H	Pass



<b>Band :</b>	GSM1900	<b>Temperature :</b>	20~22°C
<b>Test Mode :</b>	EDGE 8 Link	<b>Relative Humidity :</b>	40~42%
<b>Test Engineer :</b>	David Ke	<b>Polarization :</b>	Vertical
<b>Remark :</b>	Spurious emissions within 30-1000MHz were found more than 20dB below limit line.		

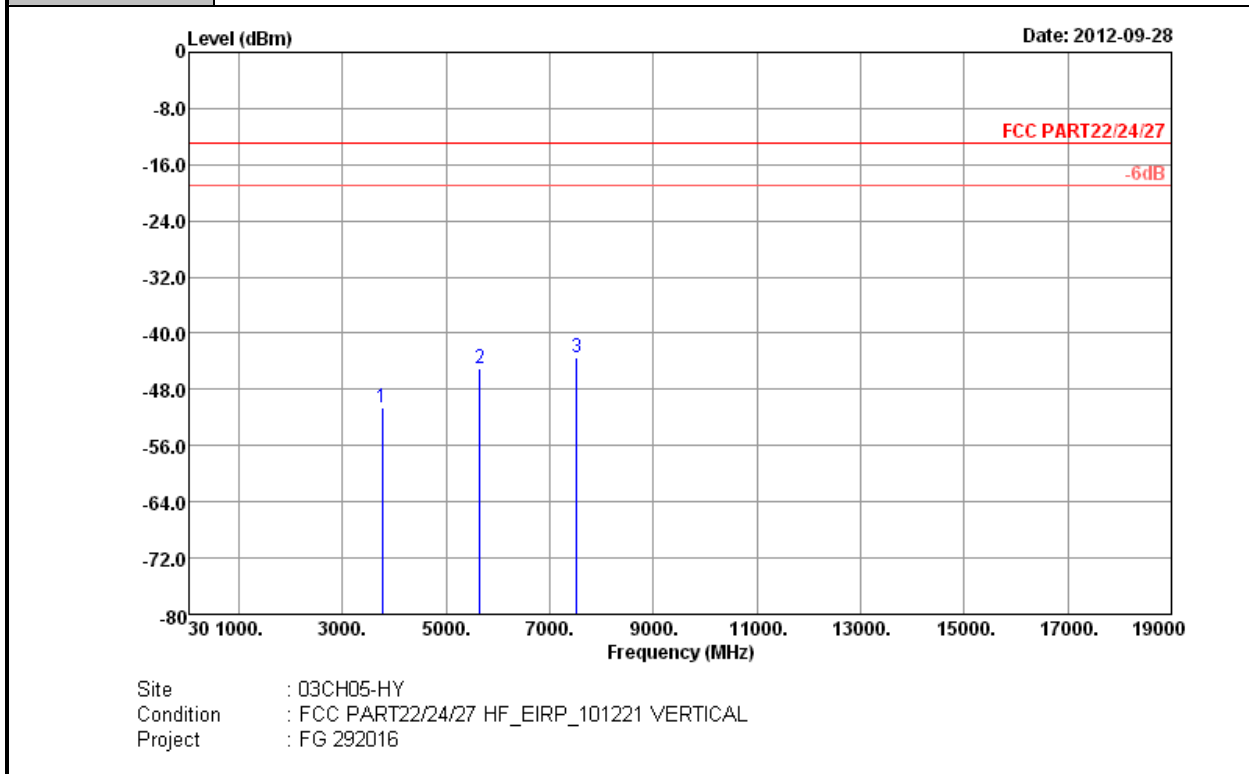

Frequency ( MHz )	EIRP ( dBm )	Limit ( dBm )	Over Limit ( dB )	SPA Reading ( dBm )	S.G. Power ( dBm )	TX Cable loss ( dB )	TX Antenna Gain ( dBi )	Polarization ( H/V )	Result
3760	-50.59	-13	-37.59	-64.03	-57.3	2.00	8.71	V	Pass
5640	-44.96	-13	-31.96	-63.84	-53.6	2.13	10.77	V	Pass
7520	-43.56	-13	-30.56	-65.56	-53.1	2.68	12.22	V	Pass



<Sample 1>

<b>Band :</b>	WCDMA Band V	<b>Temperature :</b>	20~22°C
<b>Test Mode :</b>	RMC 12.2Kbps Link	<b>Relative Humidity :</b>	40~42%
<b>Test Engineer :</b>	David Ke	<b>Polarization :</b>	Horizontal
<b>Remark :</b>	Spurious emissions within 30-1000MHz were found more than 20dB below limit line.		

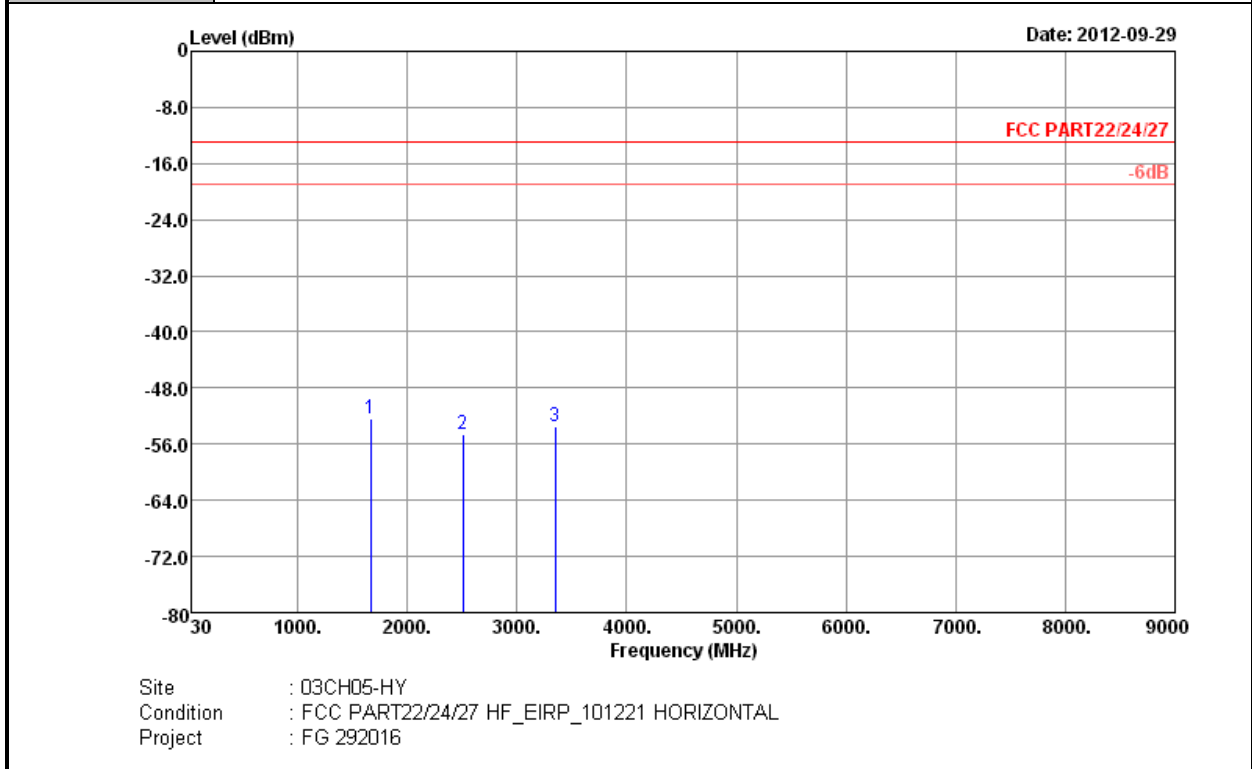

Frequency ( MHz )	ERP ( dBm )	Limit ( dBm )	Over Limit ( dB )	SPA Reading ( dBm )	S.G. Power ( dBm )	TX Cable loss ( dB )	TX Antenna Gain ( dBi )	Polarization ( H/V )	Result
1669	-52.43	-13	-39.43	-58.38	-54.19	1.35	5.25	H	Pass
2509	-54.67	-13	-41.67	-63.97	-57.05	1.58	6.11	H	Pass
3346	-53.52	-13	-40.52	-65.13	-57.37	1.94	7.94	H	Pass



<b>Band :</b>	WCDMA Band V	<b>Temperature :</b>	20~22°C
<b>Test Mode :</b>	RMC 12.2Kbps Link	<b>Relative Humidity :</b>	40~42%
<b>Test Engineer :</b>	David Ke	<b>Polarization :</b>	Vertical
<b>Remark :</b>	Spurious emissions within 30-1000MHz were found more than 20dB below limit line.		

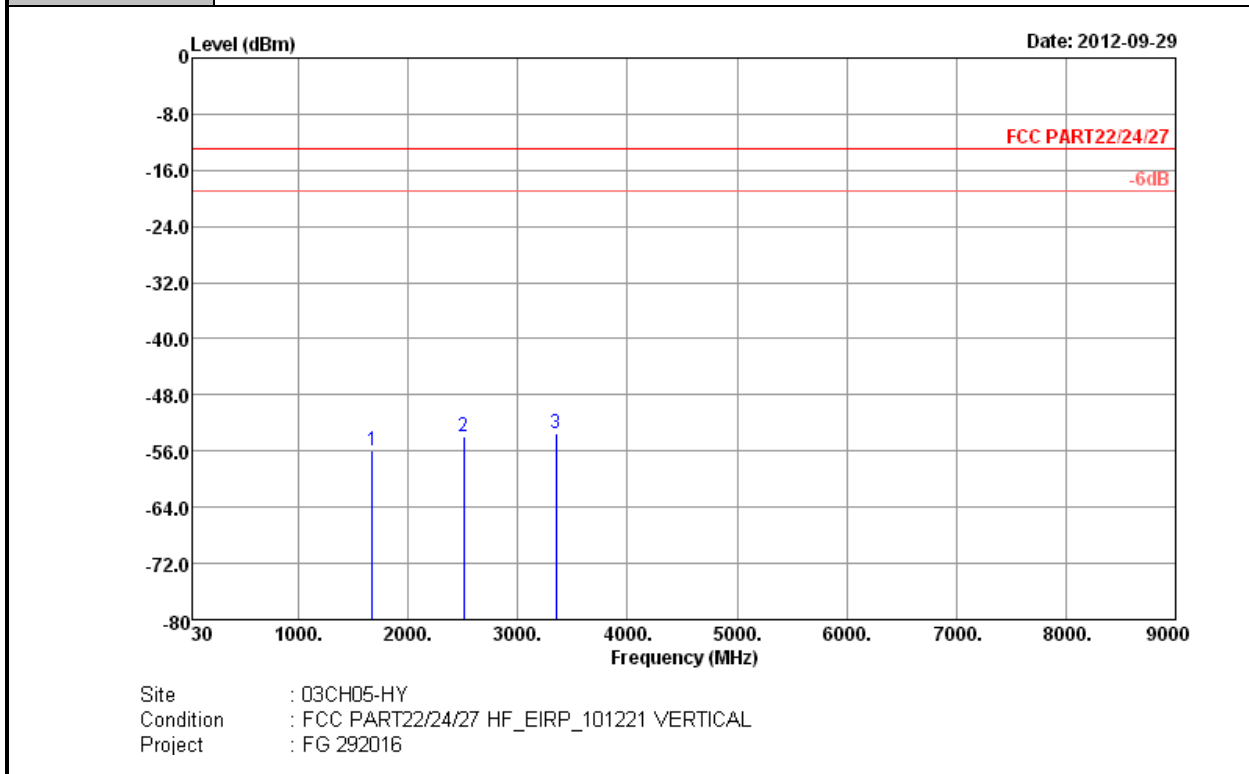

Frequency ( MHz )	ERP ( dBm )	Limit ( dBm )	Over Limit ( dB )	SPA Reading ( dBm )	S.G. Power ( dBm )	TX Cable loss ( dB )	TX Antenna Gain ( dBi )	Polarization ( H/V )	Result
1672	-55.97	-13	-42.97	-61.9	-57.73	1.35	5.25	V	Pass
2509	-54.01	-13	-41.01	-63.43	-56.39	1.58	6.11	V	Pass
3346	-53.38	-13	-40.38	-64.96	-57.23	1.94	7.94	V	Pass





<Sample 1>

<b>Band :</b>	WCDMA Band IV	<b>Temperature :</b>	20~22°C
<b>Test Mode :</b>	RMC 12.2Kbps Link	<b>Relative Humidity :</b>	40~42%
<b>Test Engineer :</b>	David Ke	<b>Polarization :</b>	Horizontal
<b>Remark :</b>	Spurious emissions within 30-1000MHz were found more than 20dB below limit line.		

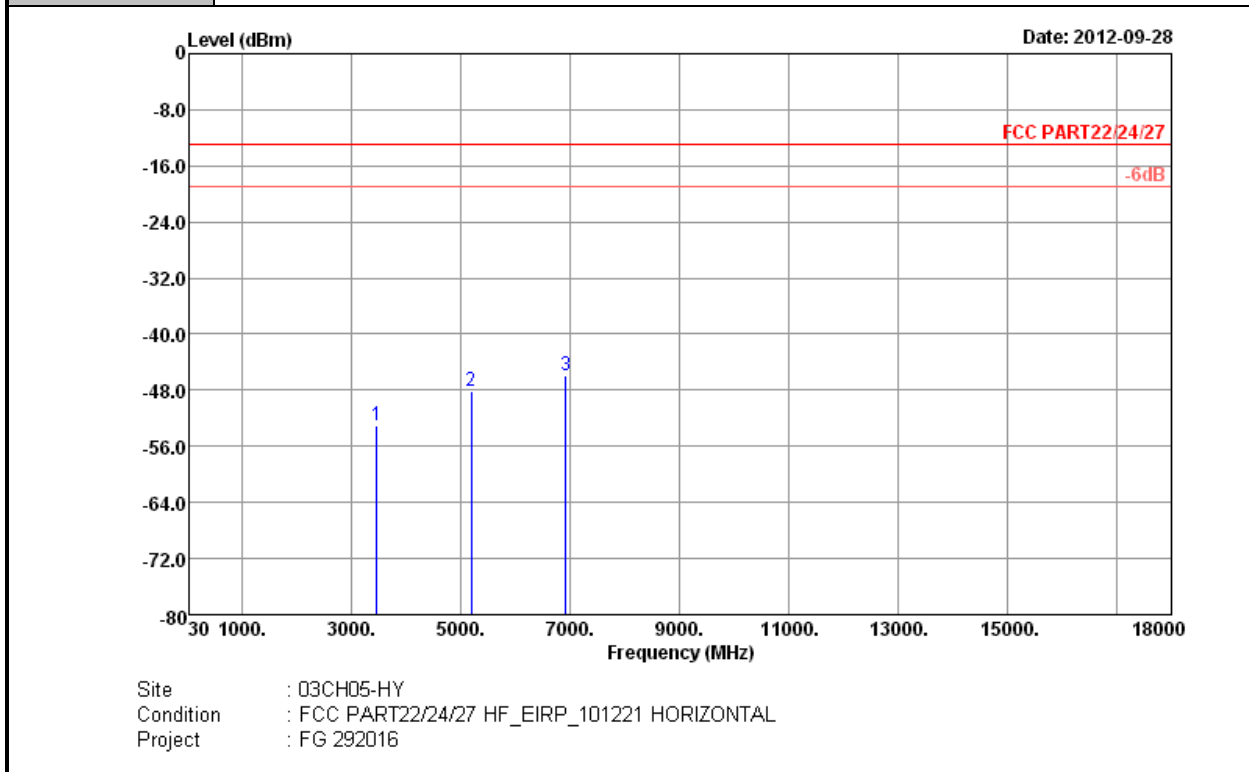

Frequency ( MHz )	EIRP ( dBm )	Limit ( dBm )	Over Limit ( dB )	SPA Reading ( dBm )	S.G. Power ( dBm )	TX Cable loss ( dB )	TX Antenna Gain ( dBi )	Polarization ( H/V )	Result
3464	-53.11	-13	-40.11	-64.94	-59.4	2.01	8.30	H	Pass
5196	-48.03	-13	-35.03	-65.76	-56.5	2.09	10.56	H	Pass
6928	-45.88	-13	-32.88	-67.05	-55	2.38	11.50	H	Pass



<b>Band :</b>	WCDMA Band IV	<b>Temperature :</b>	20~22°C
<b>Test Mode :</b>	RMC 12.2Kbps Link	<b>Relative Humidity :</b>	40~42%
<b>Test Engineer :</b>	David Ke	<b>Polarization :</b>	Vertical
<b>Remark :</b>	Spurious emissions within 30-1000MHz were found more than 20dB below limit line.		

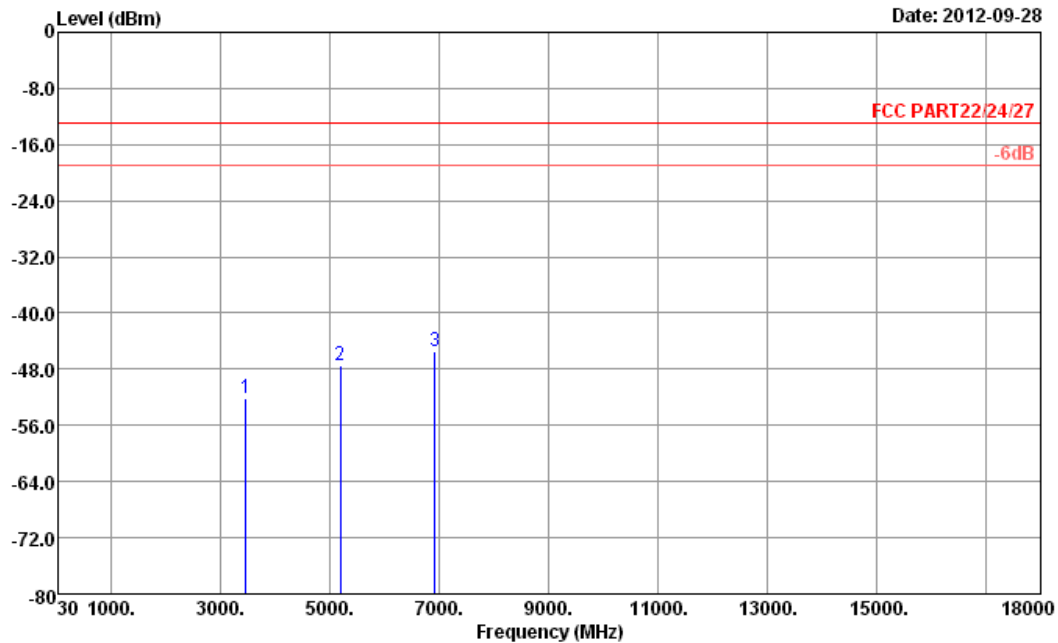

Site : 03CH05-HY  
 Condition : FCC PART22/24/27 HF\_EIRP\_101221 VERTICAL  
 Project : FG 292016

Frequency ( MHz )	EIRP ( dBm )	Limit ( dBm )	Over Limit ( dB )	SPA Reading ( dBm )	S.G. Power ( dBm )	TX Cable loss ( dB )	TX Antenna Gain ( dBi )	Polarization ( H/V )	Result
3464	-52.21	-13	-39.21	-64.04	-58.5	2.01	8.30	V	Pass
5200	-47.53	-13	-34.53	-65.28	-56	2.09	10.56	V	Pass
6928	-45.38	-13	-32.38	-66.7	-54.5	2.38	11.50	V	Pass



<Sample 2>

Band :	WCDMA Band IV	Temperature :	20~22°C
Test Mode :	RMC 12.2Kbps Link	Relative Humidity :	40~42%
Test Engineer :	David Ke	Polarization :	Horizontal
Remark :	Spurious emissions within 30-1000MHz were found more than 20dB below limit line.		

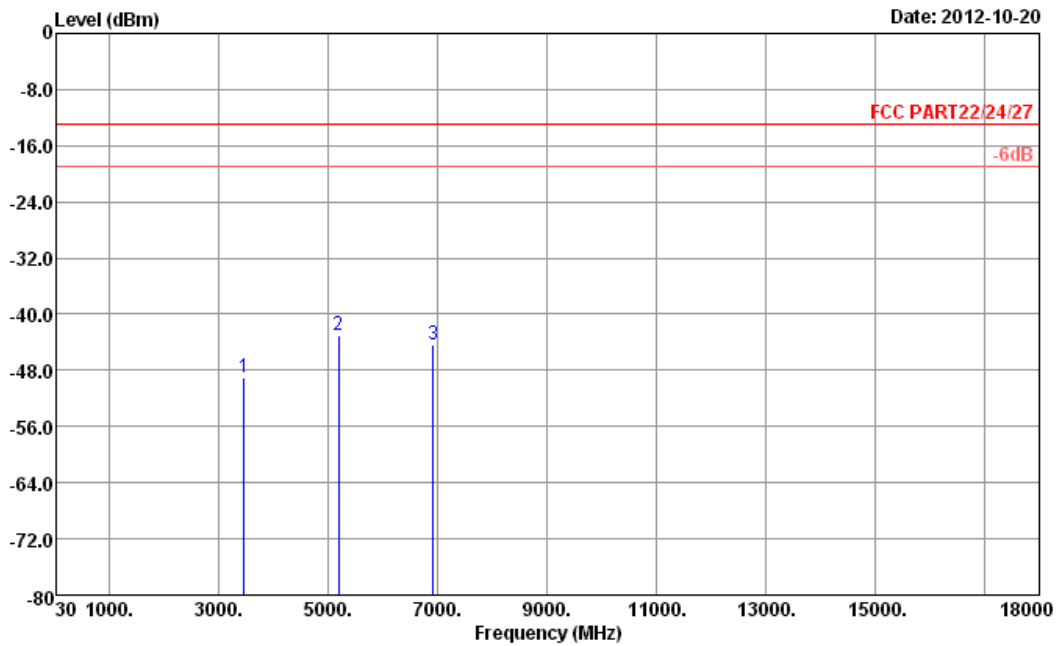

Site : 03CH05-HY  
 Condition : FCC PART22/24/27 HF\_EIRP\_101221 HORIZONTAL  
 Project : FG 292016

Frequency ( MHz )	EIRP ( dBm )	Limit ( dBm )	Over Limit ( dB )	SPA Reading ( dBm )	S.G. Power ( dBm )	TX Cable loss ( dB )	TX Antenna Gain ( dBi )	Polarization ( H/V )	Result
3464	-49.05	-13	-36.05	-62.22	-55.34	2.01	8.30	H	Pass
5196	-43.02	-13	-30.02	-61.2	-51.49	2.09	10.56	H	Pass
6928	-44.27	-13	-31.27	-66.83	-53.39	2.38	11.50	H	Pass



<b>Band :</b>	WCDMA Band IV	<b>Temperature :</b>	20~22°C
<b>Test Mode :</b>	RMC 12.2Kbps Link	<b>Relative Humidity :</b>	40~42%
<b>Test Engineer :</b>	David Ke	<b>Polarization :</b>	Vertical
<b>Remark :</b>	Spurious emissions within 30-1000MHz were found more than 20dB below limit line.		

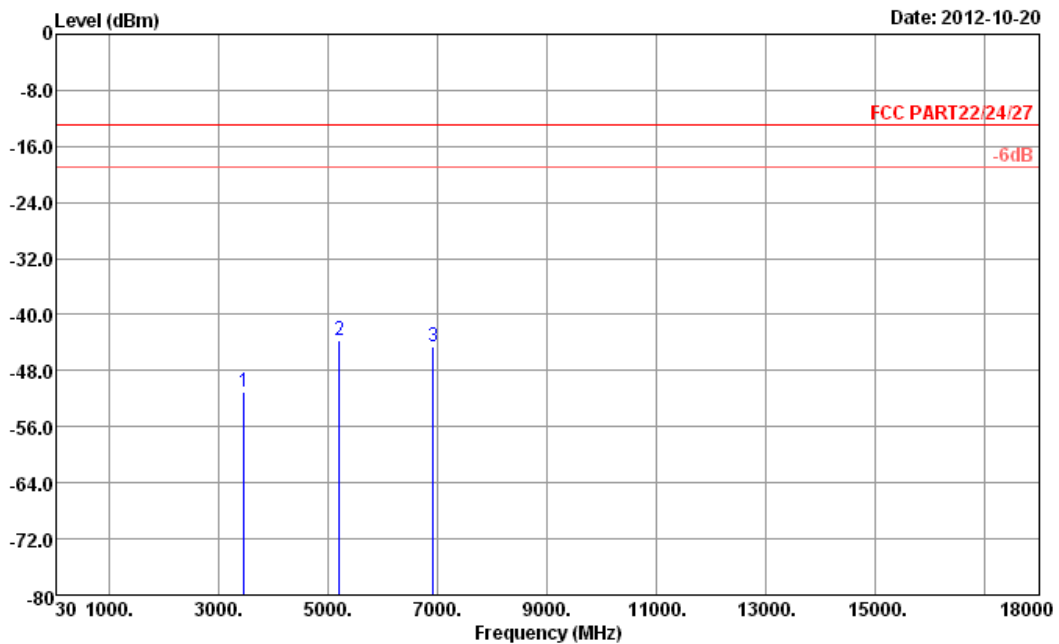

Site : 03CH05-HY  
 Condition : FCC PART22/24/27 HF\_EIRP\_101221 VERTICAL  
 Project : FG 292016

Frequency ( MHz )	EIRP ( dBm )	Limit ( dBm )	Over Limit ( dB )	SPA Reading ( dBm )	S.G. Power ( dBm )	TX Cable loss ( dB )	TX Antenna Gain ( dBi )	Polarization ( H/V )	Result
3464	-50.99	-13	-37.99	-63.96	-57.28	2.01	8.30	V	Pass
5204	-43.60	-13	-30.60	-62.08	-52.07	2.09	10.56	V	Pass
6928	-44.55	-13	-31.55	-66.97	-53.67	2.38	11.50	V	Pass



<Sample 1>

<b>Band :</b>	WCDMA Band II	<b>Temperature :</b>	20~22°C
<b>Test Mode :</b>	RMC 12.2Kbps Link	<b>Relative Humidity :</b>	40~42%
<b>Test Engineer :</b>	David Ke	<b>Polarization :</b>	Horizontal
<b>Remark :</b>	Spurious emissions within 30-1000MHz were found more than 20dB below limit line.		

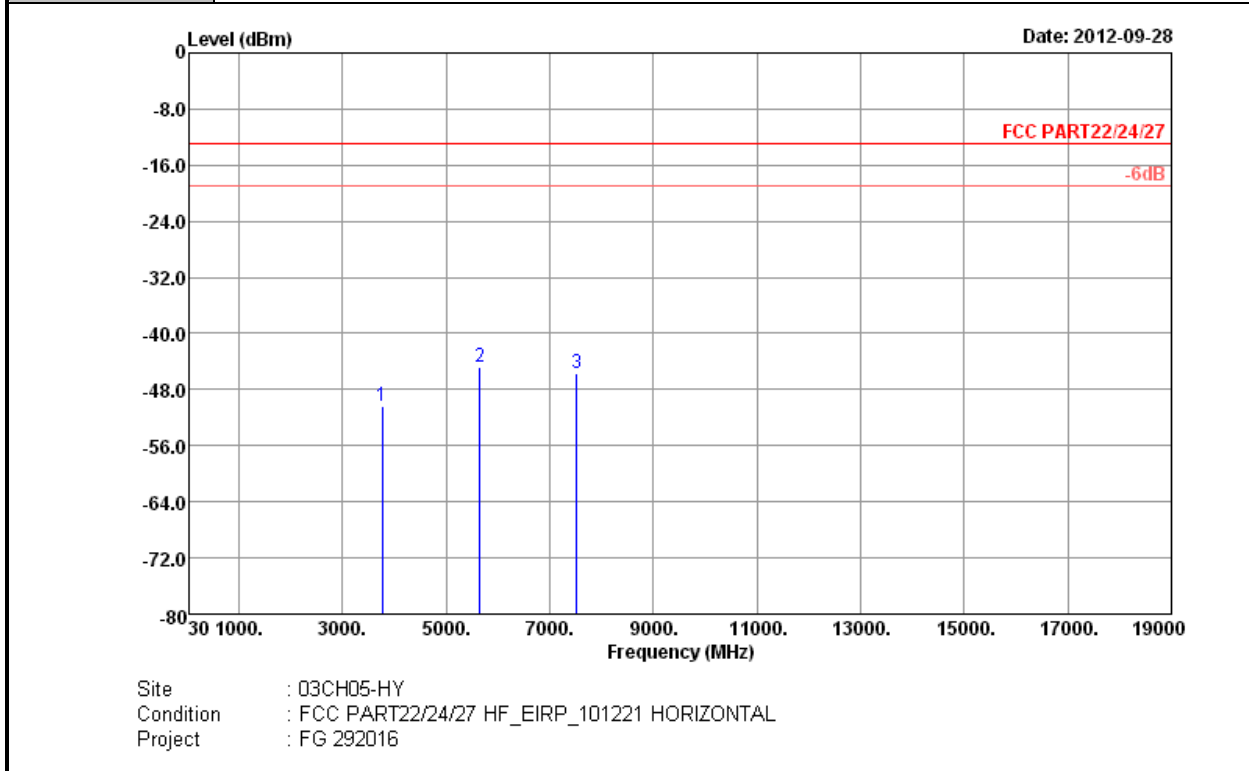

Frequency ( MHz )	EIRP ( dBm )	Limit ( dBm )	Over Limit ( dB )	SPA Reading ( dBm )	S.G. Power ( dBm )	TX Cable loss ( dB )	TX Antenna Gain ( dBi )	Polarization ( H/V )	Result
3760	-50.39	-13	-37.39	-63.82	-57.1	2.00	8.71	H	Pass
5640	-44.76	-13	-31.76	-63.76	-53.4	2.13	10.77	H	Pass
7520	-45.66	-13	-32.66	-67.77	-55.2	2.68	12.22	H	Pass



<b>Band :</b>	WCDMA Band II	<b>Temperature :</b>	20~22°C
<b>Test Mode :</b>	RMC 12.2Kbps Link	<b>Relative Humidity :</b>	40~42%
<b>Test Engineer :</b>	David Ke	<b>Polarization :</b>	Vertical
<b>Remark :</b>	Spurious emissions within 30-1000MHz were found more than 20dB below limit line.		

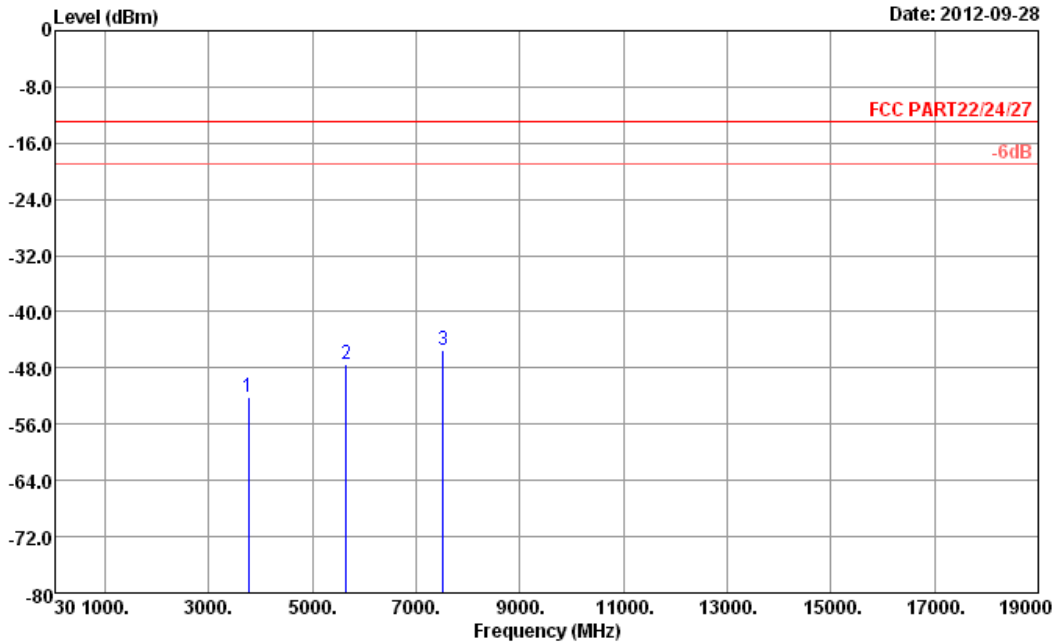

Site : 03CH05-HY  
 Condition : FCC PART22/24/27 HF\_EIRP\_101221 VERTICAL  
 Project : FG 292016

Frequency ( MHz )	EIRP ( dBm )	Limit ( dBm )	Over Limit ( dB )	SPA Reading ( dBm )	S.G. Power ( dBm )	TX Cable loss ( dB )	TX Antenna Gain ( dBi )	Polarization ( H/V )	Result
3760	-52.09	-13	-39.09	-65.65	-58.8	2.00	8.71	V	Pass
5640	-47.36	-13	-34.36	-66.36	-56	2.13	10.77	V	Pass
7520	-45.56	-13	-32.56	-67.49	-55.1	2.68	12.22	V	Pass

## 3.8 Frequency Stability Measurement

### 3.8.1 Description of Frequency Stability Measurement

The frequency stability shall be measured by variation of ambient temperature and variation of primary supply voltage to ensure that the fundamental emission stays within the authorized frequency block. The frequency stability of the transmitter shall be maintained within  $\pm 0.00025\%$  ( $\pm 2.5\text{ppm}$ ) of the center frequency.

### 3.8.2 Measuring Instruments

See list of measuring instruments of this test report.

### 3.8.3 Test Procedures for Temperature Variation

1. The EUT was set up in the thermal chamber and connected with the base station.
2. With power OFF, the temperature was decreased to  $-30^{\circ}\text{C}$  and the EUT was stabilized before testing. Power was applied and the maximum change in frequency was recorded within one minute.
3. With power OFF, the temperature was raised in  $10^{\circ}\text{C}$  step up to  $50^{\circ}\text{C}$ . The EUT was stabilized at each step for at least half an hour. Power was applied and the maximum frequency change was recorded within one minute.
4. If the EUT cannot be turned on at  $-30^{\circ}\text{C}$ , the testing lowest temperature will be raised in  $10^{\circ}\text{C}$  step until the EUT can be turned on.

### 3.8.4 Test Procedures for Voltage Variation

1. The EUT was placed in a temperature chamber at  $25\pm 5^{\circ}\text{C}$  and connected with the base station.
2. The power supply voltage to the EUT was varied from BEP to 115% of the nominal value measured at the input to the EUT.
3. The variation in frequency was measured for the worst case.

### 3.8.5 Test Setup

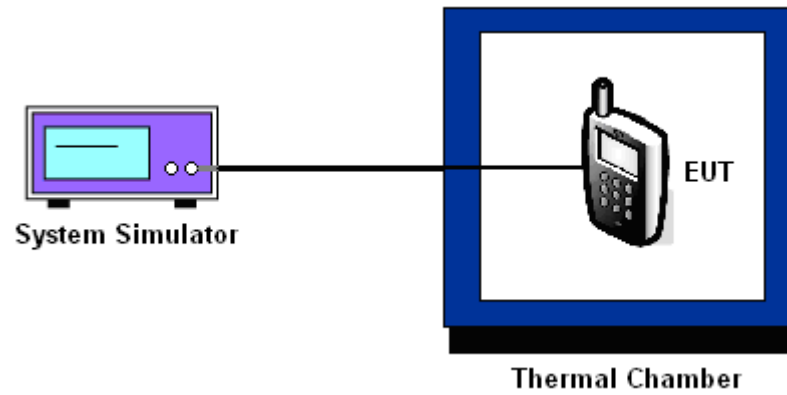





3.8.6 Test Result of Temperature Variation

Band :	GSM 850	Channel :	189
Limit (ppm) :	2.5	Frequency :	836.4 MHz

Temperature (°C)	GSM		EDGE 8		Result
	Freq. Dev. (Hz)	Deviation (ppm)	Freq. Dev. (Hz)	Deviation (ppm)	
-30	48	0.06	-54	-0.06	PASS
-20	-47	-0.06	-45	-0.05	
-10	43	0.05	-39	-0.05	
0	54	0.06	50	0.06	
10	-48	-0.06	-55	-0.06	
20	-46	-0.05	-42	-0.05	
30	-51	-0.06	-41	-0.05	
40	-36	-0.04	-51	-0.06	
50	-43	-0.05	-53	-0.06	

Band :	GSM 1900	Channel :	661
Limit (ppm) :	2.5	Frequency :	1880.0 MHz

Temperature (°C)	GSM		EDGE 8		Result
	Freq. Dev. (Hz)	Deviation (ppm)	Freq. Dev. (Hz)	Deviation (ppm)	
-30	53	0.03	-56	-0.03	PASS
-20	-50	-0.03	-62	-0.03	
-10	-32	-0.02	-47	-0.02	
0	47	0.02	59	0.03	
10	-29	-0.02	-50	-0.03	
20	42	0.02	46	0.02	
30	44	0.02	-60	-0.03	
40	-43	-0.02	43	0.02	
50	-25	-0.01	-52	-0.03	



<b>Band :</b>	WCDMA Band V	<b>Channel :</b>	4182
<b>Limit (ppm) :</b>	2.5	<b>Frequency :</b>	836.4 MHz

Temperature (°C)	RMC 12.2Kbps		Result
	Freq. Dev. (Hz)	Deviation (ppm)	
-30	-10	-0.01	PASS
-20	8	0.01	
-10	9	0.01	
0	7	0.01	
10	-6	-0.01	
20	7	0.01	
30	9	0.01	
40	10	0.01	
50	10	0.01	

<b>Band :</b>	WCDMA Band IV	<b>Channel :</b>	1413
<b>Limit (ppm) :</b>	2.5	<b>Frequency :</b>	1732.6 MHz

Temperature (°C)	RMC 12.2Kbps		Result
	Freq. Dev. (Hz)	Deviation (ppm)	
-30	15	0.01	PASS
-20	13	0.01	
-10	-13	-0.01	
0	14	0.01	
10	12	0.01	
20	12	0.01	
30	11	0.01	
40	14	0.01	
50	13	0.01	



Band :	WCDMA Band II	Channel :	9400
Limit (ppm) :	2.5	Frequency :	836.4 MHz

Temperature (°C)	RMC 12.2Kbps		Result
	Freq. Dev. (Hz)	Deviation (ppm)	
-30	-17	-0.01	PASS
-20	-15	-0.01	
-10	-14	-0.01	
0	-16	-0.01	
10	-15	-0.01	
20	-15	-0.01	
30	-17	-0.01	
40	-16	-0.01	
50	-15	-0.01	



3.8.7 Test Result of Voltage Variation

Band & Channel	Mode	Voltage (Volt)	Freq. Dev. (Hz)	Deviation (ppm)	Limit (ppm)	Result
GSM 850 CH189	GSM	3.8	-47	-0.06	2.5	PASS
		BEP	-50	-0.06		
		4.2	-54	-0.06		
	EDGE 8	3.8	-50	-0.06		
		BEP	-46	-0.05		
		4.2	-43	-0.05		
GSM 1900 CH661	GSM	3.8	-35	-0.02		
		BEP	-40	-0.02		
		4.2	46	0.02		
	EDGE 8	3.8	-44	-0.02		
		BEP	37	0.02		
		4.2	39	0.02		
WCDMA Band V CH4182	RMC 12.2Kbps	3.8	7	0.01		
		BEP	6	0.01		
		4.2	8	0.01		
WCDMA Band IV CH1413	RMC 12.2Kbps	3.8	11	0.01		
		BEP	14	0.01		
		4.2	-12	-0.01		
WCDMA Band II CH9400	RMC 12.2Kbps	3.8	-16	-0.01		
		BEP	-14	-0.01		
		4.2	-13	-0.01		

Note:

1. Normal Voltage = 3.8V.
2. Battery End Point (BEP) = 3.6 V.



## 4 List of Measuring Equipments

Instrument	Manufacturer	Model No.	Serial No.	Characteristics	Calibration Date	Test Date	Due Date	Remark
Spectrum Analyzer	R&S	FSP40	100055	9kHz~40GHz	Jun. 06, 2012	Oct. 08, 2012	Jun. 05, 2013	Conducted (TH03-HY)
Thermal Chamber	Ten Billion	TTH-D3SP	TBN-930701	N/A	Jul. 23, 2012	Oct. 08, 2012	Jul. 22, 2013	Conducted (TH03-HY)
EMI Test Receiver	R&S	ESVS10	834468/003	20MHz ~ 1000MHz	May 04, 2012	Sep. 28, 2012~ Oct. 20, 2012	May. 03, 2013	Radiation (03CH05-HY)
Spectrum Analyzer	R&S	ESU26	100390	20Hz ~ 26.5GHz	Dec. 22, 2011	Sep. 28, 2012~ Oct. 20, 2012	Dec. 21, 2012	Radiation (03CH05-HY)
Bilog Antenna	SCHAFFNER	CBL6111C	2725	30MHz ~ 2GHz	Oct. 22, 2011	Sep. 28, 2012~ Oct. 20, 2012	Oct. 21, 2012	Radiation (03CH05-HY)
Turn Table	HD	Deis HD 2000	420/611	0 ~ 360 degree	N/A	Sep. 28, 2012~ Oct. 20, 2012	N/A	Radiation (03CH05-HY)
Antenna Mast	HD	MA 240	240/666	1 m ~ 4 m	N/A	Sep. 28, 2012~ Oct. 20, 2012	N/A	Radiation (03CH05-HY)
Horn Antenna	ESCO	3117	66584	1GHz~18GHz	Aug. 10, 2012	Sep. 28, 2012~ Oct. 20, 2012	Aug. 09, 2013	Radiation (03CH05-HY)
Pre Amplifier	Agilent	8449B	3008A02665	1GHz~26.5GHz	Aug. 28, 2012	Sep. 28, 2012~ Oct. 20, 2012	Aug. 27, 2013	Radiation (03CH05-HY)
Pre Amplifier	COM-POWER	PA-103	161075	10-1000MHz.32dB.GAIN	Feb. 27, 2012	Sep. 28, 2012~ Oct. 20, 2012	Feb. 26, 2013	Radiation (03CH05-HY)
SHF-EHF Horn Antenna	SCHWARZBECK	BBHA 9170	BBHA9170251	15GHz ~ 40GHz	Sep. 28, 2012	Sep. 28, 2012~ Oct. 20, 2012	Sep. 27, 2013	Radiation (03CH05-HY)
Loop Antenna	R&S	HFH2-Z2	860004/001	9KHz ~ 30MHz	Jul. 03, 2012	Sep. 28, 2012~ Oct. 20, 2012	Jul. 02, 2014	Radiation (03CH05-HY)
System Simulator	R&S	CMU200	117995	N/A	Jul. 30, 2012	Sep. 28, 2012~ Oct. 20, 2012	Jul. 29, 2013	-



## 5 Uncertainty of Evaluation

### Uncertainty of Radiated Emission Measurement (30 MHz ~ 1000 MHz)

Measuring Uncertainty for a Level of Confidence of 95% ( $U = 2Uc(y)$ )	2.54
---	------

### Uncertainty of Radiated Emission Measurement (1 GHz ~ 40 GHz)

Measuring Uncertainty for a Level of Confidence of 95% ( $U = 2Uc(y)$ )	4.72
---	------