



FCC SAR Test Report

APPLICANT : HTC Corporation
EQUIPMENT : Windows Phone
MODEL NAME : PM59100
FCC ID : NM8PM59100
STANDARD : FCC 47 CFR Part 2 (2.1093)
ANSI/IEEE C95.1-1992
IEEE 1528-2003
FCC OET Bulletin 65 Supplement C (Edition 01-01)

The product was completely tested on Sep. 29, 2012. We, SPORTON INTERNATIONAL INC., would like to declare that the tested sample has been evaluated in accordance with the procedures and shown the compliance with the applicable technical standards.

The test results in this report apply exclusively to the tested model / sample. Without written approval of SPORTON INTERNATIONAL INC., the test report shall not be reproduced except in full.

Reviewed by:

Jones Tsai / Manager



SPORTON INTERNATIONAL INC.

No. 52, Hwa Ya 1st Rd., Hwa Ya Technology Park, Kwei-Shan Hsiang, Tao Yuan Hsien, Taiwan, R.O.C.



Table of Contents

1. Statement of Compliance 4
2. Administration Data 5
2.1 Testing Laboratory 5
2.2 Applicant 5
2.3 Manufacturer 5
2.4 Application Details 5
3. General Information 6
3.1 Description of Equipment Under Test (EUT) 6
3.2 Applied Standard 7
3.3 Device Category and SAR Limits 7
3.4 Test Conditions 7
4. Specific Absorption Rate (SAR) 8
4.1 Introduction 8
4.2 SAR Definition 8
5. SAR Measurement System 9
5.1 E-Field Probe 10
5.2 Data Acquisition Electronics (DAE) 11
5.3 Robot 11
5.4 Measurement Server 11
5.5 Phantom 12
5.6 Device Holder 13
5.7 Data Storage and Evaluation 14
5.8 Test Equipment List 16
6. Tissue Simulating Liquids 17
7. SAR Measurement Evaluation 19
7.1 Purpose of System Performance check 19
7.2 System Setup 19
7.3 Validation Results 20
8. EUT Testing Position 21
8.1 Define two imaginary lines on the handset 21
8.2 Cheek Position 22
8.3 Tilted Position 22
8.4 Body Worn Position 23
9. Measurement Procedures 24
9.1 Spatial Peak SAR Evaluation 24
9.2 Area & Zoom Scan Procedures 24
9.3 Volume Scan Procedures 25
9.4 SAR Averaged Methods 25
9.5 Power Drift Monitoring 25
10. SAR Test Configurations 26
10.1 Exposure Positions Consideration 26
10.2 Conducted RF Output Power (Unit: dBm) 28
11. SAR Test Results 31
11.1 Test Records for Head SAR Test 31
11.2 Test Records for Hotspot SAR Test 32
11.3 Test Records for Body-worn SAR Test 33
11.4 Simultaneous Multi-band Transmission Analysis 34
11.5 Simultaneous analysis - SPLSR calculation 35
12. Uncertainty Assessment 37
13. References 39

- Appendix A. Plots of System Performance Check
Appendix B. Plots of SAR Measurement
Appendix C. DASY Calibration Certificate
Appendix D. Test Setup Photos



Revision History

REPORT NO.	VERSION	DESCRIPTION	ISSUED DATE
FA290531-01	Rev. 01	Initial issue of report	Oct. 29, 2012



1. Statement of Compliance

The maximum results of Specific Absorption Rate (SAR) found during testing for **HTC Corporation Windows Phone, PM59100**, are as follows.

<Highest standalone SAR Summary>

Band	Position	SAR _{1g} (W/kg)	Scaled SAR _{1g} (W/kg)
GSM850	Head	0.357	0.387
GSM1900	Head	0.552	0.594
WLAN 2.4G	Head	0.793	0.828
GSM850	Hotspot (1 cm Gap)	0.573	0.614
GSM1900	Hotspot (1 cm Gap)	1.2	1.328
WLAN 2.4G	Hotspot (1 cm Gap)	0.408	0.426
GSM850	Body-worn (1 cm Gap)	0.573	0.614
GSM1900	Body-worn (1 cm Gap)	1.2	1.328
WLAN 2.4G	Body-worn (1 cm Gap)	0.408	0.426

This device is in compliance with Specific Absorption Rate (SAR) for general population/uncontrolled exposure limits (1.6 W/kg) specified in FCC 47 CFR part 2 (2.1093) and ANSI/IEEE C95.1-1992, and had been tested in accordance with the measurement methods and procedures specified in IEEE 1528-2003 and FCC OET Bulletin 65 Supplement C (Edition 01-01).



2. Administration Data

2.1 Testing Laboratory

Test Site	SPORTON INTERNATIONAL INC.
Test Site Location	No. 52, Hwa Ya 1 st Rd., Hwa Ya Technology Park, Kwei-Shan Hsiang, Tao Yuan Hsien, Taiwan, R.O.C. TEL: +886-3-327-3456 FAX: +886-3-328-4978

2.2 Applicant

Company Name	HTC Corporation
Address	No. 23, Xinghua Rd., Taoyuan City, Taoyuan County 330, Taiwan

2.3 Manufacturer

Company Name	HTC Corporation
Address	No. 23, Xinghua Rd., Taoyuan City, Taoyuan County 330, Taiwan

2.4 Application Details

Date of Start during the Test	Sep. 12, 2012
Date of End during the Test	Sep. 29, 2012

3. General Information

3.1 Description of Equipment Under Test (EUT)

Product Feature & Specification	
EUT	Windows Phone
Model Name	PM59100
FCC ID	NM8PM59100
IMEI Code	35519500000017
Sample 1	EUT with Main Camera 1, and Battery 1
Sample 2	EUT with Main Camera 2, and Battery 2
Tx Frequency	GSM850: 824.2 MHz ~ 848.8 MHz GSM1900: 1850.2 MHz ~ 1909.8 MHz WLAN2.4G: 2412 MHz ~ 2462 MHz Bluetooth: 2402 MHz ~ 2480 MHz
Maximum Average Output Power to Antenna	GSM850: 33.39 dBm GSM1900: 30.52 dBm 802.11b: 18.31 dBm 802.11g: 12.29 dBm 802.11n-HT20 (2.4GHz) : 12.15 dBm Bluetooth: 0.96 dBm
Antenna Type	WWAN: PIFA Antenna WLAN: PIFA Antenna Bluetooth: PIFA Antenna
Uplink Modulations	GSM: GMSK GPRS: GMSK EDGE: GMSK / 8PSK 802.11b: DSSS (BPSK / QPSK / CCK) 802.11g/n: OFDM (BPSK / QPSK / 16QAM / 64QAM) Bluetooth : GFSK Bluetooth EDR : $\pi/4$ -DQPSK, 8-DPSK
Dual Transfer Mode (DTM) Category	Class A – EUT can support Packet Switched and Circuit Switched Network simultaneously.
EUT Stage	Production Unit
Remark: The above EUT's information was declared by manufacturer. Please refer to the specifications or user's manual for more detailed description.	

Per KDB 941225 D04 requirement, the required test configuration for this device is as below:

1. This EUT is class A device
2. This EUT supports (E)GPRS multi-slot class 12 (max. uplink : 4, max. downlink : 4, total timeslots : 5)
3. This EUT supports DTM multi-slot class 11 (max. uplink : 3 for 1 CS & 2 PS, max. downlink : 4, total timeslots : 5)
4. The measured maximum conducted power can be referred to section 10.2 of this report
5. For DTM multi-slot class 11 link mode, the device was linked with system emulator (Agilent E5515C) and transmit maximum power on maximum number of Tx slots (one CS timeslot and two PS timeslots per frame).



3.2 Applied Standard

The Specific Absorption Rate (SAR) testing specification, method, and procedure for this device is in accordance with the following standards:

- FCC 47 CFR Part 2 (2.1093)
- ANSI/IEEE C95.1-1992
- IEEE 1528-2003
- FCC OET Bulletin 65 Supplement C (Edition 01-01)
- FCC KDB 447498 D01 v04
- FCC KDB 648474 D01 v01r05
- FCC KDB 941225 D03 v01
- FCC KDB 941225 D04 v01
- FCC KDB 941225 D06 v01
- FCC KDB 248227 D01 v01r02

3.3 Device Category and SAR Limits

This device belongs to portable device category because its radiating structure is allowed to be used within 20 centimeters of the body of the user. Limit for General Population/Uncontrolled exposure should be applied for this device, it is 1.6 W/kg as averaged over any 1 gram of tissue.

3.4 Test Conditions

3.4.1 Ambient Condition

Ambient Temperature	20 to 24 °C
Humidity	< 60 %

3.4.2 Test Configuration

The device was controlled by using a base station emulator. Communication between the device and the emulator was established by air link. The distance between the EUT and the antenna of the emulator is larger than 50 cm and the output power radiated from the emulator antenna is at least 30 dB smaller than the output power of EUT. The EUT was set from the emulator to radiate maximum output power during all tests.

For WLAN SAR testing, WLAN engineering testing software installed on the EUT can provide continuous transmitting RF signal.

The maximum rated power of WWAN is listed in "Tune-Up Procedure" exhibit, and the maximum rated power of WLAN is listed in "Operational Description" exhibit; the scaling factor is calculated according to the difference between measured output power and maximum tolerance power on this device.

4. Specific Absorption Rate (SAR)

4.1 Introduction

SAR is related to the rate at which energy is absorbed per unit mass in an object exposed to a radio field. The SAR distribution in a biological body is complicated and is usually carried out by experimental techniques or numerical modeling. The standard recommends limits for two tiers of groups, occupational/controlled and general population/uncontrolled, based on a person's awareness and ability to exercise control over his or her exposure. In general, occupational/controlled exposure limits are higher than the limits for general population/uncontrolled.

4.2 SAR Definition

The SAR definition is the time derivative (rate) of the incremental energy (dW) absorbed by (dissipated in) an incremental mass (dm) contained in a volume element (dv) of a given density (ρ). The equation description is as below:

$$\text{SAR} = \frac{d}{dt} \left(\frac{dW}{dm} \right) = \frac{d}{dt} \left(\frac{dW}{\rho dv} \right)$$

SAR is expressed in units of Watts per kilogram (W/kg)

SAR measurement can be either related to the temperature elevation in tissue by

$$\text{SAR} = C \left(\frac{\delta T}{\delta t} \right)$$

Where: C is the specific heat capacity, δT is the temperature rise and δt is the exposure duration, or related to the electrical field in the tissue by

$$\text{SAR} = \frac{\sigma |E|^2}{\rho}$$

Where: σ is the conductivity of the tissue, ρ is the mass density of the tissue and E is the RMS electrical field strength.

However for evaluating SAR of low power transmitter, electrical field measurement is typically applied.

5. SAR Measurement System

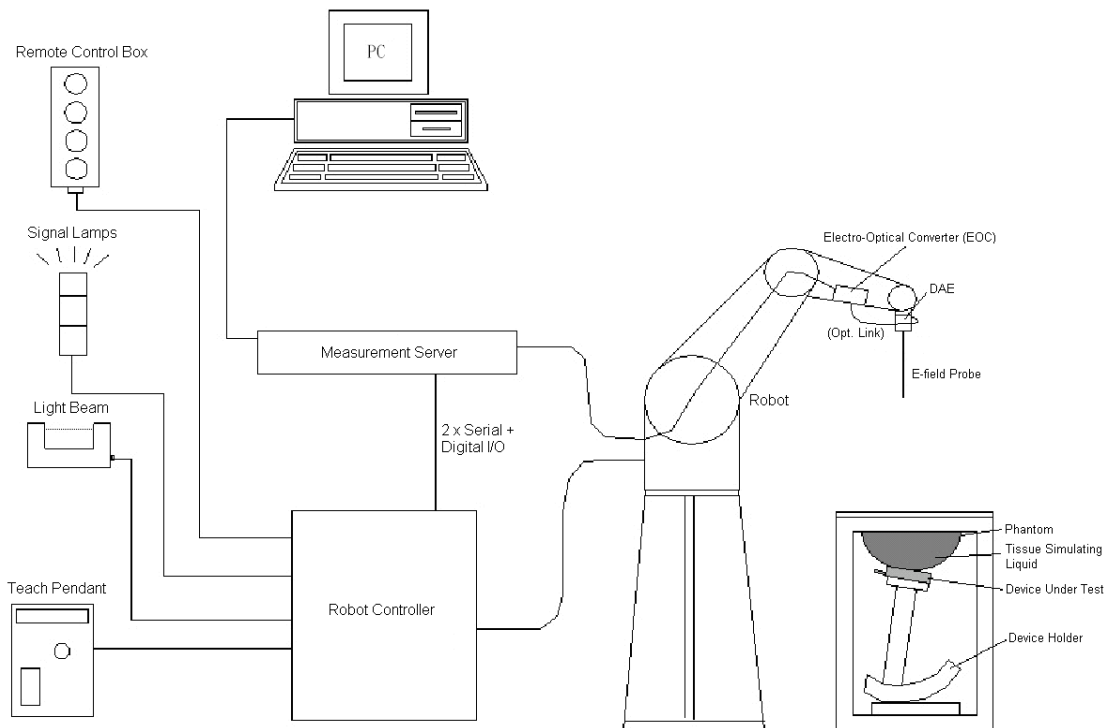

Fig 5.1 SPEAG DASY System Configurations

The DASY system for performance compliance tests is illustrated above graphically. This system consists of the following items:

- A standard high precision 6-axis robot with controller, a teach pendant and software
- A data acquisition electronic (DAE) attached to the robot arm extension
- A dosimetric probe equipped with an optical surface detector system
- The electro-optical converter (EOC) performs the conversion between optical and electrical signals
- A measurement server performs the time critical tasks such as signal filtering, control of the robot operation and fast movement interrupts.
- A probe alignment unit which improves the accuracy of the probe positioning
- A computer operating Windows XP
- DASY software
- Remote control with teach pendant and additional circuitry for robot safety such as warning lamps, etc.
- The SAM twin phantom
- A device holder
- Tissue simulating liquid
- Dipole for evaluating the proper functioning of the system

Component details are described in in the following sub-sections.

5.1 E-Field Probe

The SAR measurement is conducted with the dosimetric probe (manufactured by SPEAG). The probe is specially designed and calibrated for use in liquid with high permittivity. The dosimetric probe has special calibration in liquid at different frequency. This probe has a built in optical surface detection system to prevent from collision with phantom.

5.1.1 E-Field Probe Specification

<ET3DV6 / ET3DV6R Probe >

Construction	Symmetrical design with triangular core Built-in optical fiber for surface detection system. Built-in shielding against static charges. PEEK enclosure material (resistant to organic solvents, e.g., DGBE)	 <p>Fig 5.2 Photo of ET3DV6/ET3DV6</p>
Frequency	10 MHz to 3 GHz; Linearity: ± 0.2 dB	
Directivity	± 0.2 dB in HSL (rotation around probe axis) ± 0.4 dB in HSL (rotation normal to probe axis)	
Dynamic Range	5 μ W/g to 100 mW/g; Linearity: ± 0.2 dB	
Dimensions	Overall length: 330 mm (Tip: 16 mm) Tip diameter: 6.8 mm (Body: 12 mm) Distance from probe tip to dipole centers: 2.7 mm	

<EX3DV4 / ES3DV4 Probe >

Construction	Symmetrical design with triangular core Built-in shielding against static charges PEEK enclosure material (resistant to organic solvents, e.g., DGBE)	 <p>Fig 5.3 Photo of EX3DV4/ES3DV4</p>
Frequency	10 MHz to 6 GHz; Linearity: ± 0.2 dB	
Directivity	± 0.3 dB in HSL (rotation around probe axis) ± 0.5 dB in tissue material (rotation normal to probe axis)	
Dynamic Range	10 μ W/g to 100 mW/g; Linearity: ± 0.2 dB (noise: typically < 1 μ W/g)	
Dimensions	Overall length: 330 mm (Tip: 20 mm) Tip diameter: 2.5 mm (Body: 12 mm) Typical distance from probe tip to dipole centers: 1 mm	

5.1.2 E-Field Probe Calibration

Each probe needs to be calibrated according to a dosimetric assessment procedure with accuracy better than $\pm 10\%$. The spherical isotropy shall be evaluated and within ± 0.25 dB. The sensitivity parameters (NormX, NormY, and NormZ), the diode compression parameter (DCP) and the conversion factor (ConvF) of the probe are tested. The calibration data can be referred to appendix C of this report.

5.2 Data Acquisition Electronics (DAE)

The data acquisition electronics (DAE) consists of a highly sensitive electrometer-grade preamplifier with auto-zeroing, a channel and gain-switching multiplexer, a fast 16 bit AD-converter and a command decoder and control logic unit. Transmission to the measurement server is accomplished through an optical downlink for data and status information as well as an optical uplink for commands and the clock. The input impedance of the DAE is 200 MOhm; the inputs are symmetrical and floating. Common mode rejection is above 80 dB.



Fig 5.4 Photo of DAE

5.3 Robot

The SPEAG DASY system uses the high precision robots (DASY4: RX90BL; DASY5: TX90XL) type from Stäubli SA (France). For the 6-axis controller system, the robot controller version (DASY4: CS7MB; DASY5: CS8c) from Stäubli is used. The Stäubli robot series have many features that are important for our application:

- High precision (repeatability ± 0.035 mm)
- High reliability (industrial design)
- Jerk-free straight movements
- Low ELF interference (the closed metallic construction shields against motor control fields)

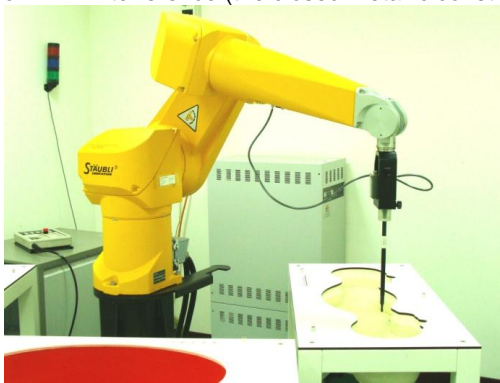

Fig 5.5 Photo of DASY4



Fig 5.6 Photo of DASY5

5.4 Measurement Server

The measurement server is based on a PC/104 CPU board with CPU (DASY4: 166 MHz, Intel Pentium; DASY5: 400 MHz, Intel Celeron), chipdisk (DASY4: 32 MB; DASY5: 128 MB), RAM (DASY4: 64 MB, DASY5: 128 MB). The necessary circuits for communication with the DAE electronic box, as well as the 16 bit AD converter system for optical detection and digital I/O interface are contained on the DASY I/O board, which is directly connected to the PC/104 bus of the CPU board.

The measurement server performs all the real-time data evaluation for field measurements and surface detection, controls robot movements and handles safety operations.



Fig 5.7 Photo of Server for DASY4



Fig 5.8 Photo of Server for DASY5

5.5 Phantom

<SAM Twin Phantom>

Shell Thickness	2 ± 0.2 mm; Center ear point: 6 ± 0.2 mm	 <p>Fig 5.9 Photo of SAM Phantom</p>
Filling Volume	Approx. 25 liters	
Dimensions	Length: 1000 mm; Width: 500 mm; Height: adjustable feet	
Measurement Areas	Left Hand, Right Hand, Flat Phantom	

The bottom plate contains three pair of bolts for locking the device holder. The device holder positions are adjusted to the standard measurement positions in the three sections. A white cover is provided to tap the phantom during off-periods to prevent water evaporation and changes in the liquid parameters. On the phantom top, three reference markers are provided to identify the phantom position with respect to the robot.

<ELI4 Phantom>

Shell Thickness	2 ± 0.2 mm (sagging: <1%)	 <p>Fig 5.10 Photo of ELI4 Phantom</p>
Filling Volume	Approx. 30 liters	
Dimensions	Major ellipse axis: 600 mm Minor axis: 400 mm	

The ELI4 phantom is intended for compliance testing of handheld and body-mounted wireless devices in the frequency range of 30 MHz to 6 GHz. ELI4 is fully compatible with standard and all known tissue simulating liquids.

5.6 Device Holder

<Device Holder for SAM Twin Phantom>

The SAR in the phantom is approximately inversely proportional to the square of the distance between the source and the liquid surface. For a source at 5 mm distance, a positioning uncertainty of ± 0.5 mm would produce a SAR uncertainty of ± 20 %. Accurate device positioning is therefore crucial for accurate and repeatable measurements. The positions in which the devices must be measured are defined by the standards.

The DASY device holder is designed to cope with different positions given in the standard. It has two scales for the device rotation (with respect to the body axis) and the device inclination (with respect to the line between the ear reference points). The rotation center for both scales is the ear reference point (ERP). Thus the device needs no repositioning when changing the angles.

The DASY device holder is constructed of low-loss POM material having the following dielectric parameters: relative permittivity $\epsilon = 3$ and loss tangent $\delta = 0.02$. The amount of dielectric material has been reduced in the closest vicinity of the device, since measurements have suggested that the influence of the clamp on the test results could thus be lowered.



Fig 5.11 Device Holder

<Laptop Extension Kit>

The extension is lightweight and made of POM, acrylic glass and foam. It fits easily on the upper part of the mounting device in place of the phone positioned. The extension is fully compatible with the SAM Twin and ELI phantoms.

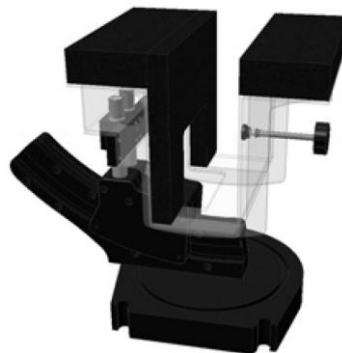

Fig 5.12 Laptop Extension Kit



5.7 Data Storage and Evaluation

5.7.1 Data Storage

The DASY software stores the assessed data from the data acquisition electronics as raw data (in microvolt readings from the probe sensors), together with all the necessary software parameters for the data evaluation (probe calibration data, liquid parameters and device frequency and modulation data) in measurement files. The post-processing software evaluates the desired unit and format for output each time the data is visualized or exported. This allows verification of the complete software setup even after the measurement and allows correction of erroneous parameter settings. For example, if a measurement has been performed with an incorrect crest factor parameter in the device setup, the parameter can be corrected afterwards and the data can be reevaluated.

The measured data can be visualized or exported in different units or formats, depending on the selected probe type (e.g., [V/m], [A/m], [mW/g]). Some of these units are not available in certain situations or give meaningless results, e.g., a SAR-output in a non-lose media, will always be zero. Raw data can also be exported to perform the evaluation with other software packages.

5.7.2 Data Evaluation

The DASY post-processing software (SEMCAD) automatically executes the following procedures to calculate the field units from the microvolt readings at the probe connector. The parameters used in the evaluation are stored in the configuration modules of the software :

Probe parameters :	- Sensitivity	Norm _i , a _{i0} , a _{i1} , a _{i2}
	- Conversion factor	ConvF _i
	- Diode compression point	dcp _i
Device parameters :	- Frequency	f
	- Crest factor	cf
Media parameters :	- Conductivity	σ
	- Density	ρ

These parameters must be set correctly in the software. They can be found in the component documents or they can be imported into the software from the configuration files issued for the DASY components. In the direct measuring mode of the multi-meter option, the parameters of the actual system setup are used. In the scan visualization and export modes, the parameters stored in the corresponding document files are used.

The first step of the evaluation is a linearization of the filtered input signal to account for the compression characteristics of the detector diode. The compensation depends on the input signal, the diode type and the DC-transmission factor from the diode to the evaluation electronics. If the exciting field is pulsed, the crest factor of the signal must be known to correctly compensate for peak power.



The formula for each channel can be given as :

$$V_i = U_i + U_i^2 \cdot \frac{cf}{dcp_i}$$

- with V_i = compensated signal of channel i, (i = x, y, z)
- U_i = input signal of channel i, (i = x, y, z)
- cf = crest factor of exciting field (DASY parameter)
- dcp_i = diode compression point (DASY parameter)

From the compensated input signals, the primary field data for each channel can be evaluated :

$$\text{E-field Probes : } E_i = \sqrt{\frac{V_i}{\text{Norm}_i \cdot \text{ConvF}}}$$

$$\text{H-field Probes : } H_i = \sqrt{V_i \cdot \frac{a_{i0} + a_{i1}f + a_{i2}f^2}{f}}$$

- with V_i = compensated signal of channel i, (i = x, y, z)
- Norm_i = sensor sensitivity of channel i, (i = x, y, z), $\mu\text{V}/(\text{V/m})^2$ for E-field Probes
- ConvF = sensitivity enhancement in solution
- a_{ij} = sensor sensitivity factors for H-field probes
- f = carrier frequency [GHz]
- E_i = electric field strength of channel i in V/m
- H_i = magnetic field strength of channel i in A/m

The RSS value of the field components gives the total field strength (Hermitian magnitude) :

$$E_{\text{tot}} = \sqrt{E_x^2 + E_y^2 + E_z^2}$$

The primary field data are used to calculate the derived field units.

$$\text{SAR} = E_{\text{tot}}^2 \cdot \frac{\sigma}{\rho \cdot 1000}$$

- with SAR = local specific absorption rate in mW/g
- E_{tot} = total field strength in V/m
- σ = conductivity in [mho/m] or [Siemens/m]
- ρ = equivalent tissue density in g/cm^3

Note that the density is set to 1, to account for actual head tissue density rather than the density of the tissue simulating liquid.



5.8 Test Equipment List

Manufacturer	Name of Equipment	Type/Model	Serial Number	Calibration	
				Last Cal.	Due Date
SPEAG	835MHz System Validation Kit	D835V2	499	Mar. 22, 2010	Mar. 21, 2013
SPEAG	1900MHz System Validation Kit	D1900V2	5d041	Mar. 23, 2010	Mar. 22, 2013
SPEAG	2450MHz System Validation Kit	D2450V2	736	Jul. 25, 2011	Jul. 24, 2013
SPEAG	Data Acquisition Electronics	DAE4	778	Aug. 27, 2012	Aug. 26, 2013
SPEAG	Data Acquisition Electronics	DAE4	1338	Jun. 12, 2012	Jun. 11, 2013
SPEAG	Dosimetric E-Field Probe	ET3DV6	1787	May 29, 2012	May 28, 2013
SPEAG	Dosimetric E-Field Probe	EX3DV4	3820	Dec. 16, 2011	Dec. 15, 2012
SPEAG	Device Holder	N/A	N/A	NCR	NCR
SPEAG	SAM Phantom	QD 000 P40 C	TP-1303	NCR	NCR
SPEAG	SAM Phantom	QD 000 P40 C	TP-1383	NCR	NCR
SPEAG	SAM Phantom	QD 000 P40 C	TP-1446	NCR	NCR
SPEAG	SAM Phantom	QD 000 P40 C	TP-1478	NCR	NCR
SPEAG	SAM Phantom	QD 000 P41 C	TP-1150	NCR	NCR
SPEAG	SAM Phantom	QD 000 P40 CD	TP-1644	NCR	NCR
SPEAG	SAM Phantom	SM 000 T01 DA	TP-1542	NCR	NCR
Agilent	Network Analyzer	E5071C	MY46101588	May 11, 2012	May 10, 2013
Agilent	ESG Vector Series Signal Generator	E4438C	MY49070755	Oct. 17, 2011	Oct. 16, 2012
Anritsu	Power Meter	ML2495A	1132003	Aug. 14, 2012	Aug. 13, 2013
Anritsu	Radio Communication Analyzer	MT8820C	6201074414	Dec. 21, 2011	Dec. 20, 2012
Agilent	Wireless Communication Test Set	E5515C	MY48360820	Jan. 05, 2012	Jan. 04, 2014
Agilent	Wireless Communication Test Set	E5515C	GB46311322	Mar. 23, 2011	Mar. 22, 2013
Agilent	Wireless Communication Test Set	E5515C	MY50264370	Apr. 19, 2011	Apr. 18, 2013
Agilent	Wireless Communication Test Set	E5515C	MY50266977	Nov. 13, 2011	Nov. 12, 2013
R&S	Universal Digital Radiocommunication Tester	CMU200	106656	Jun. 28, 2012	Jun. 27, 2013
R&S	Spectrum Analyzer	FSP	101131	Jul. 23, 2012	Jul. 22, 2013

Table 5.1 Test Equipment List

Note:

1. The calibration certificate of DASY can be referred to appendix C of this report.
2. Referring to KDB 450824 D02, the dipole calibration interval can be extended to 3 years with justification. The dipoles are also not physically damaged, or repaired during the interval.
3. The justification data of dipole D835V2, SN: 499, D1900V2, SN: 5d041 D2450V2, SN: 736 can be found in appendix C. The return loss is < -20dB, within 20% of prior calibration, the impedance is within 5 ohm of prior calibration.

6. Tissue Simulating Liquids

For the measurement of the field distribution inside the SAM phantom with DASY, the phantom must be filled with around 25 liters of homogeneous body tissue simulating liquid. For head SAR testing, the liquid height from the ear reference point (ERP) of the phantom to the liquid top surface is larger than 15 cm, which is shown in Fig. 6.1. For body SAR testing, the liquid height from the center of the flat phantom to the liquid top surface is larger than 15 cm, which is shown in Fig. 6.2.

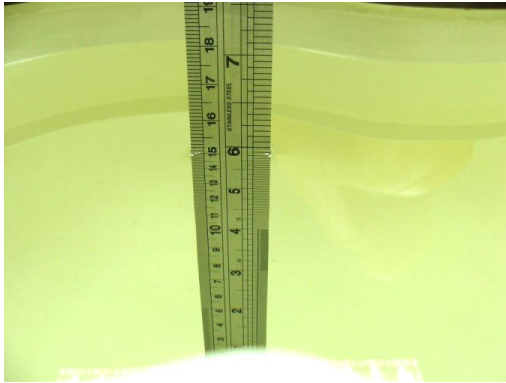

Fig 6.1 Photo of Liquid Height for Head SAR



Fig 6.2 Photo of Liquid Height for Body SAR

The following table gives the recipes for tissue simulating liquid.

Frequency (MHz)	Water (%)	Sugar (%)	Cellulose (%)	Salt (%)	Preventol (%)	DGBE (%)	Conductivity (σ)	Permittivity (ϵ_r)
For Head								
835	40.3	57.9	0.2	1.4	0.2	0	0.90	41.5
1800, 1900, 2000	55.2	0	0	0.3	0	44.5	1.40	40.0
2450	55.0	0	0	0	0	45.0	1.80	39.2
For Body								
835	50.8	48.2	0	0.9	0.1	0	0.97	55.2
1800, 1900, 2000	70.2	0	0	0.4	0	29.4	1.52	53.3
2450	68.6	0	0	0	0	31.4	1.95	52.7

Table 6.1 Recipes of Tissue Simulating Liquid



The dielectric parameters of the liquids were verified prior to the SAR evaluation using an Agilent 85070D Dielectric Probe Kit and an Agilent Network Analyzer.

The following table shows the measuring results for simulating liquid.

Freq. (MHz)	Liquid Type	Temp. (°C)	Conductivity (σ)	Permittivity (ϵ_r)	Conductivity Target (σ)	Permittivity Target (ϵ_r)	Delta (σ) (%)	Delta (ϵ_r) (%)	Limit (%)	Date
835	Head	21.5	0.904	40.5	0.90	41.5	0.44	-2.41	±5	Sep. 12, 2012
835	Head	21.2	0.885	42	0.9	41.5	-1.67	1.20	±5	Sep. 28, 2012
835	Body	21.5	0.962	54.6	0.97	55.2	-0.82	-1.09	±5	Sep. 12, 2012
835	Body	21.4	0.963	54.5	0.97	55.2	-0.72	-1.27	±5	Sep. 29, 2012
1900	Head	21.4	1.45	38.5	1.40	40.0	3.57	-3.75	±5	Sep. 12, 2012
1900	Head	21.4	1.43	39	1.4	40	2.14	-2.50	±5	Sep. 29, 2012
1900	Body	21.4	1.55	51.9	1.52	53.3	1.97	-2.63	±5	Sep. 12, 2012
1900	Body	21.4	1.53	52.3	1.52	53.3	0.66	-1.88	±5	Sep. 29, 2012
2450	Head	21.2	1.86	39.2	1.80	39.2	3.33	0.00	±5	Sep. 27, 2012
2450	Body	21.2	2.01	53.9	1.95	52.7	3.08	2.28	±5	Sep. 27, 2012

Table 6.2 Measuring Results for Simulating Liquid

7. SAR Measurement Evaluation

Each DASY system is equipped with one or more system validation kits. These units, together with the predefined measurement procedures within the DASY software, enable the user to conduct the system performance check and system validation. System validation kit includes a dipole, tripod holder to fix it underneath the flat phantom and a corresponding distance holder.

7.1 Purpose of System Performance check

The system performance check verifies that the system operates within its specifications. System and operator errors can be detected and corrected. It is recommended that the system performance check be performed prior to any usage of the system in order to guarantee reproducible results. The system performance check uses normal SAR measurements in a simplified setup with a well characterized source. This setup was selected to give a high sensitivity to all parameters that might fail or vary over time. The system check does not intend to replace the calibration of the components, but indicates situations where the system uncertainty is exceeded due to drift or failure.

7.2 System Setup

In the simplified setup for system evaluation, the EUT is replaced by a calibrated dipole and the power source is replaced by a continuous wave that comes from a signal generator. The calibrated dipole must be placed beneath the flat phantom section of the SAM twin phantom with the correct distance holder. The distance holder should touch the phantom surface with a light pressure at the reference marking and be oriented parallel to the long side of the phantom. The equipment setup is shown below:

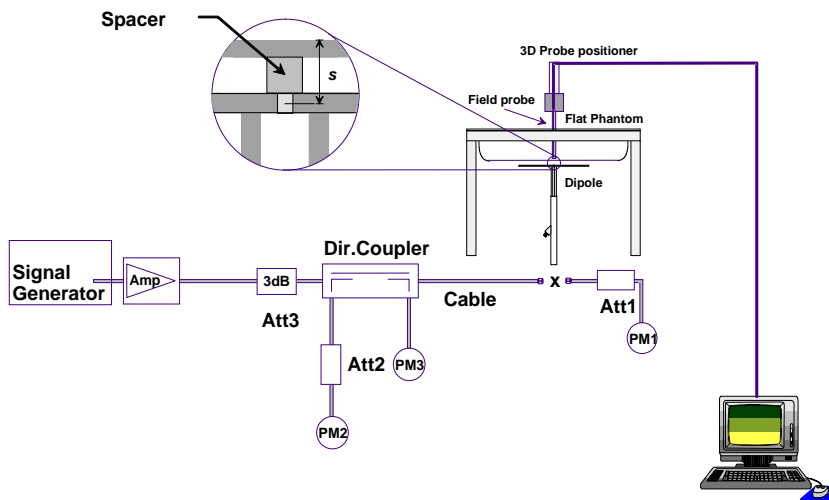

Fig 7.1 System Setup for System Evaluation



Fig 7.2 Photo of Dipole Setup

1. Signal Generator
2. Amplifier
3. Directional Coupler
4. Power Meter
5. Calibrated Dipole

The output power on dipole port must be calibrated to 24 dBm (250 mW) before dipole is connected.



7.3 Validation Results

Comparing to the original SAR value provided by SPEAG, the validation data should be within its specification of 10 %. Table 7.1 shows the target SAR and measured SAR after normalized to 1W input power. The table below indicates the system performance check can meet the variation criterion and the plots can be referred to Appendix A of this report.

Measurement Date	Frequency (MHz)	Liquid Type	Targeted SAR _{1g} (W/kg)	Measured SAR _{1g} (W/kg)	Normalized SAR _{1g} (W/kg)	Deviation (%)
Sep. 12, 2012	835	Head	9.71	2.48	9.92	2.16
Sep. 28, 2012	835	Head	9.71	2.38	9.52	-1.96
Sep. 12, 2012	835	Body	9.82	2.41	9.64	-1.83
Sep. 29, 2012	835	Body	9.82	2.52	10.08	2.65
Sep. 12, 2012	1900	Head	39.8	9.48	37.92	-4.72
Sep. 29, 2012	1900	Head	39.8	9.35	37.40	-6.03
Sep. 12, 2012	1900	Body	40	9.76	39.04	-2.40
Sep. 29, 2012	1900	Body	40	10.2	40.80	2.00
Sep. 27, 2012	2450	Head	54.8	14	56.00	2.19
Sep. 27, 2012	2450	Body	52.3	14	56.00	7.07

Table 7.1 Target and Measurement SAR after Normalized

8. EUT Testing Position

8.1 Define two imaginary lines on the handset

- The vertical centerline passes through two points on the front side of the handset - the midpoint of the width w_t of the handset at the level of the acoustic output, and the midpoint of the width w_b of the bottom of the handset.
- The horizontal line is perpendicular to the vertical centerline and passes through the center of the acoustic output. The horizontal line is also tangential to the face of the handset at point A.
- The two lines intersect at point A. Note that for many handsets, point A coincides with the center of the acoustic output; however, the acoustic output may be located elsewhere on the horizontal line. Also note that the vertical centerline is not necessarily parallel to the front face of the handset, especially for clamshell handsets, handsets with flip covers, and other irregularly shaped handsets.

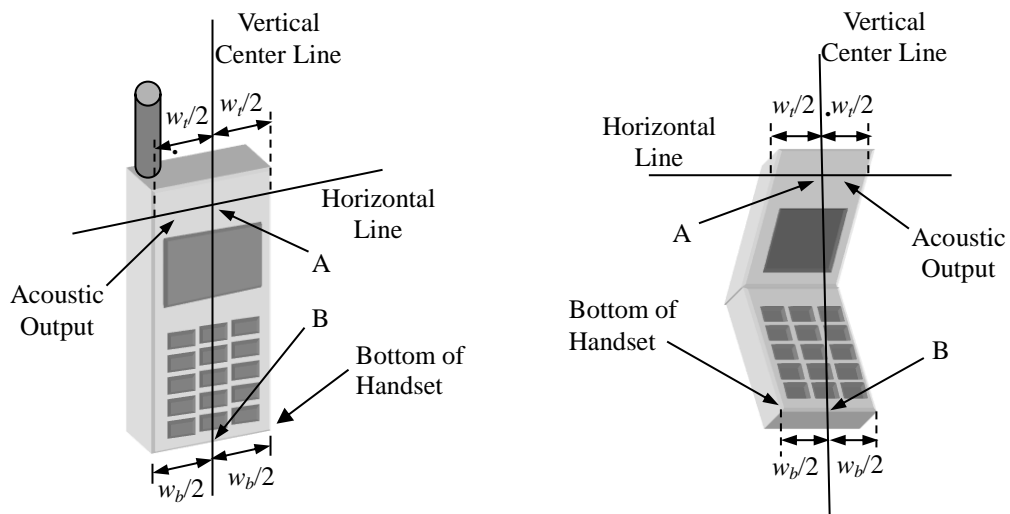

Fig 8.1 Illustration for Handset Vertical and Horizontal Reference Lines

8.2 Cheek Position

- (a) To position the device with the vertical center line of the body of the device and the horizontal line crossing the center piece in a plane parallel to the sagittal plane of the phantom. While maintaining the device in this plane, align the vertical center line with the reference plane containing the three ear and mouth reference point (M: Mouth, RE: Right Ear, and LE: Left Ear) and align the center of the ear piece with the line RE-LE.
- (b) To move the device towards the phantom with the ear piece aligned with the line LE-RE until the phone touched the ear. While maintaining the device in the reference plane and maintaining the phone contact with the ear, move the bottom of the phone until any point on the front side is in contact with the cheek of the phantom or until contact with the ear is lost (see Fig. 9.2).

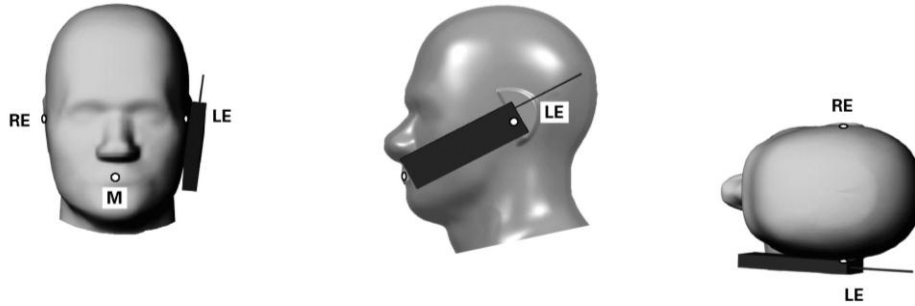

Fig 8.2 Illustration for Cheek Position

8.3 Tilted Position

- (a) To position the device in the “cheek” position described above.
- (b) While maintaining the device the reference plane described above and pivoting against the ear, moves it outward away from the mouth by an angle of 15 degrees or until contact with the ear is lost (see Fig. 9.3).

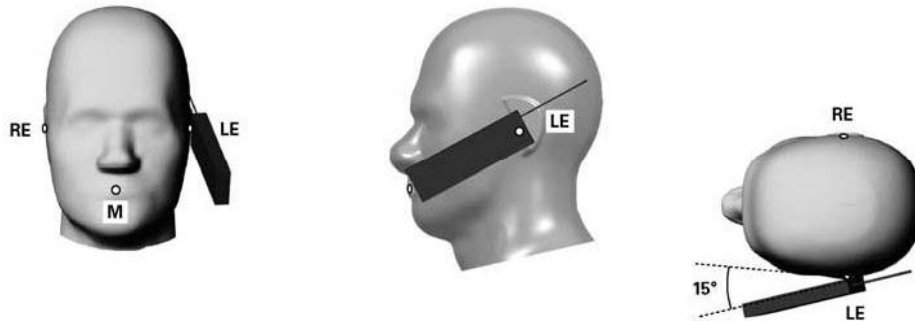

Fig 8.3 Illustration for Tilted Position

8.4 Body Worn Position

- (a) To position the device parallel to the phantom surface with either keypad up or down.
- (b) To adjust the device parallel to the flat phantom.
- (c) To adjust the distance between the device surface and the flat phantom to 1 cm.

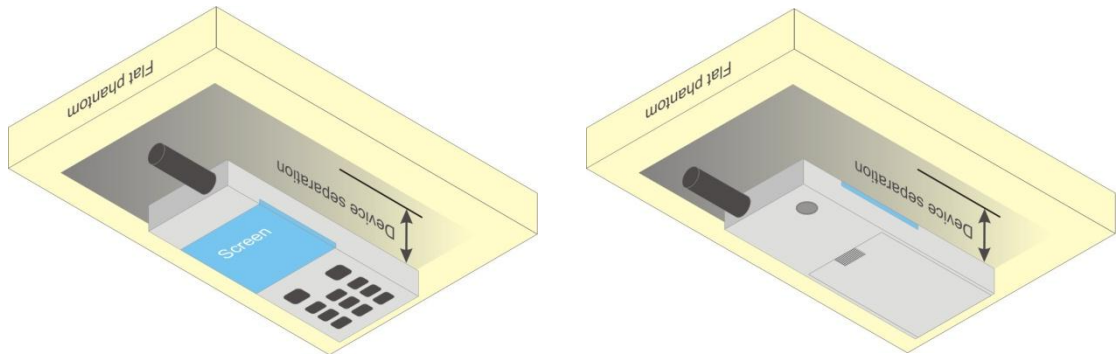

Fig 8.4 Illustration for Body Worn Position

<EUT Setup Photos>

Please refer to Appendix D for the test setup photos.



9. Measurement Procedures

The measurement procedures are as follows:

- (a) Use base station simulator (if applicable) or engineering software to transmit RF power continuously (continuous Tx) in the highest power channel.
- (b) Keep EUT to radiate maximum output power or 100% duty factor (if applicable)
- (c) Measure output power through RF cable and power meter.
- (d) Place the EUT in the positions as Appendix D demonstrates.
- (e) Set scan area, grid size and other setting on the DASY software.
- (f) Measure SAR results for the highest power channel on each testing position.
- (g) Find out the largest SAR result on these testing positions of each band
- (h) Measure SAR results for other channels in worst SAR testing position if the SAR of highest power channel is larger than 0.8 W/kg

According to the test standard, the recommended procedure for assessing the peak spatial-average SAR value consists of the following steps:

- (a) Power reference measurement
- (b) Area scan
- (c) Zoom scan
- (d) Power drift measurement

9.1 Spatial Peak SAR Evaluation

The procedure for spatial peak SAR evaluation has been implemented according to the test standard. It can be conducted for 1g and 10g, as well as for user-specific masses. The DASY software includes all numerical procedures necessary to evaluate the spatial peak SAR value.

The base for the evaluation is a "cube" measurement. The measured volume must include the 1g and 10g cubes with the highest averaged SAR values. For that purpose, the center of the measured volume is aligned to the interpolated peak SAR value of a previously performed area scan.

The entire evaluation of the spatial peak values is performed within the post-processing engine (SEMCAD). The system always gives the maximum values for the 1g and 10g cubes. The algorithm to find the cube with highest averaged SAR is divided into the following stages:

- (a) Extraction of the measured data (grid and values) from the Zoom Scan
- (b) Calculation of the SAR value at every measurement point based on all stored data (A/D values and measurement parameters)
- (c) Generation of a high-resolution mesh within the measured volume
- (d) Interpolation of all measured values from the measurement grid to the high-resolution grid
- (e) Extrapolation of the entire 3-D field distribution to the phantom surface over the distance from sensor to surface
- (f) Calculation of the averaged SAR within masses of 1g and 10g

9.2 Area & Zoom Scan Procedures

First Area Scan is used to locate the approximate location(s) of the local peak SAR value(s). The measurement grid within an Area Scan is defined by the grid extent, grid step size and grid offset. Next, in order to determine the EM field distribution in a three-dimensional spatial extension, Zoom Scan is required. The Zoom Scan measures 5x5x7 points with step size 8, 8 and 5 mm for 300 MHz to 3 GHz, and 8x8x8 points with step size 4, 4 and 2.5 mm for 3 GHz to 6 GHz. The Zoom Scan is performed around the highest E-field value to determine the averaged SAR-distribution over 10 g.



9.3 Volume Scan Procedures

The volume scan is used to assess overlapping SAR distributions for antennas transmitting in different frequency bands. It is equivalent to an oversized zoom scan used in standalone measurements. The measurement volume will be used to enclose all the simultaneous transmitting antennas. For antennas transmitting simultaneously in different frequency bands, the volume scan is measured separately in each frequency band. In order to sum correctly to compute the 1g aggregate SAR, the EUT remains in the same test position for all measurements and all volume scans use the same spatial resolution and grid spacing (step-size is 4, 4 and 2.5 mm). When all volume scans are completed, the software, SEMCAD postprocessor can combine and subsequently superpose these measurement data to calculate the multiband SAR.

9.4 SAR Averaged Methods

In DASy, the interpolation and extrapolation are both based on the modified Quadratic Shepard's method. The interpolation scheme combines a least-square fitted function method and a weighted average method which are the two basic types of computational interpolation and approximation.

Extrapolation routines are used to obtain SAR values between the lowest measurement points and the inner phantom surface. The extrapolation distance is determined by the surface detection distance and the probe sensor offset. The uncertainty increases with the extrapolation distance. To keep the uncertainty within 1% for the 1 g and 10 g cubes, the extrapolation distance should not be larger than 5 mm.

9.5 Power Drift Monitoring

All SAR testing is under the EUT installed full charged battery and transmit maximum output power. In DASy measurement software, the power reference measurement and power drift measurement procedures are used for monitoring the power drift of EUT during SAR test. Both these procedures measure the field at a specified reference position before and after the SAR testing. The software will calculate the field difference in dB. If the power drifts more than 5%, the SAR will be retested.

10. SAR Test Configurations

10.1 Exposure Positions Consideration

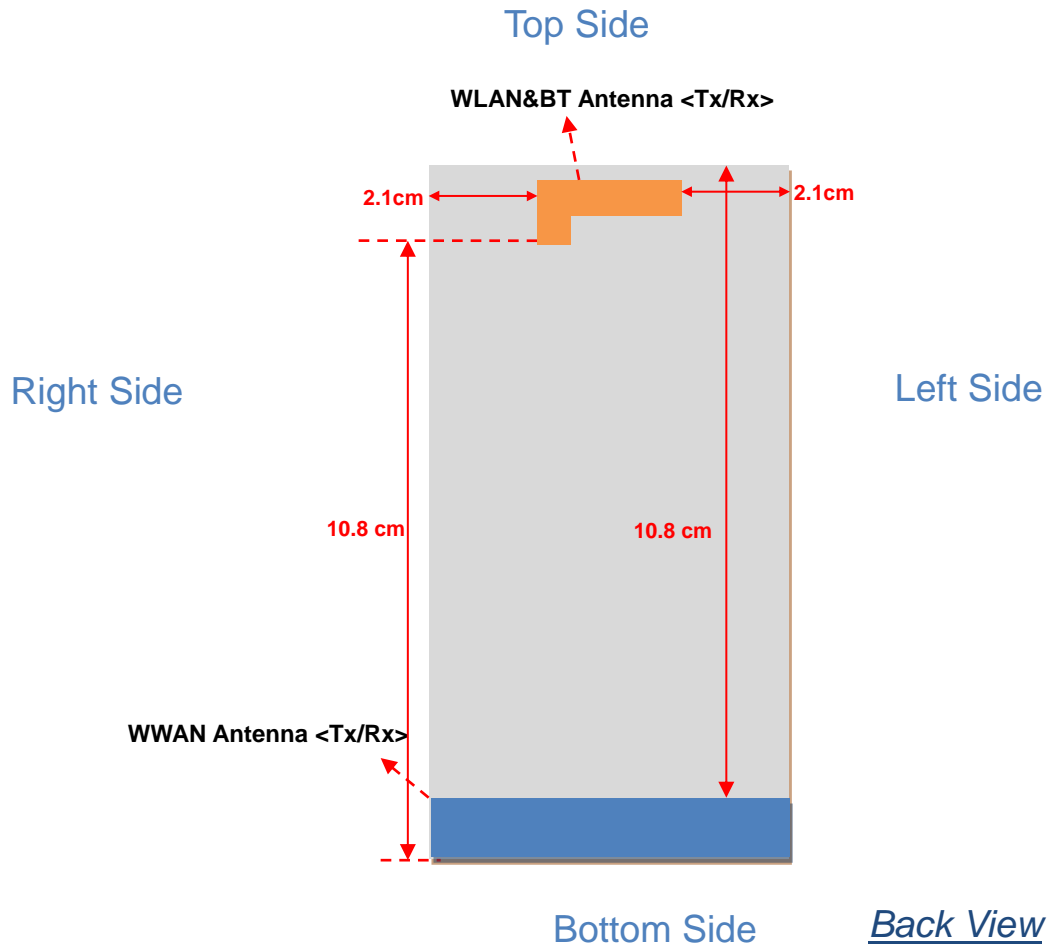

Antennas	Wireless Interface
WWAN Antenna (Tx / Rx)	GSM850 GSM1900
BT&WLAN Antenna (Tx / Rx)	WLAN 2.4GHz Bluetooth



Sides for SAR tests; Hotspot mode						
Test distance: 10 mm						
Antennas	Back	Front	Top Side	Bottom Side	Right Side	Left Side
WWAN	YES	YES	NO	YES	YES	YES
BT&WLAN	YES	YES	YES	NO	YES	YES

Note:

1. Head/Body-worn/Hotspot mode SAR assessments are required.
2. Referring to KDB 941225 D06, when the overall device length and width are $\geq 9\text{cm} \times 5\text{cm}$, the test distance is 10 mm. SAR must be measured for all sides and surfaces with a transmitting antenna located within 25mm from that surface or edge.
3. For WWAN antenna, SAR measurements at Top side is not required since the distance between the transmitting antenna and surface of device is $> 25\text{mm}$.
4. For BT&WLAN antenna, SAR measurements Bottom sides is not required since the distance between the transmitting antenna and surface of device is $> 25\text{mm}$.
5. Per KDB 648474 D01, Bluetooth output power $\leq 2 \cdot P_{\text{Ref}}$ and the distance to other antennas $\geq 5\text{cm}$, therefore, stand-alone SAR is not required.



10.2 Conducted RF Output Power (Unit: dBm)

<GSM Conducted Power>

Band: GSM850		Burst Average Power (dBm)			Frame-Average Power (dBm)		
Channel		128	189	251	128	189	251
Frequency (MHz)		824.2	836.4	848.8	824.2	836.4	848.8
GSM (GMSK, 1 Tx slot)		33.25	33.39	33.09	24.25	24.39	24.09
GPRS (GMSK, 1 Tx slot) – CS1		33.24	33.38	33.05	24.24	24.38	24.05
GPRS (GMSK, 2 Tx slots) – CS1		31.08	31.20	30.64	25.08	25.20	24.64
GPRS (GMSK, 3 Tx slots) – CS1		29.35	29.28	28.98	25.09	25.02	24.72
GPRS (GMSK, 4 Tx slots) – CS1		27.78	28.01	27.57	24.78	25.01	24.57
EDGE (GMSK, 1 Tx slot) – MCS1		33.24	33.37	33.03	24.24	24.37	24.03
EDGE (GMSK, 2 Tx slots) – MCS1		31.07	31.19	30.67	25.07	25.19	24.67
EDGE (GMSK, 3 Tx slots) – MCS1		29.34	29.27	29.00	25.08	25.01	24.74
EDGE (GMSK, 4 Tx slots) – MCS1		27.76	28.00	27.54	24.76	25.00	24.54
EDGE (8PSK, 1 Tx slot) – MCS5		26.88	26.82	26.89	17.88	17.82	17.89
EDGE (8PSK, 2 Tx slots) – MCS5		25.75	25.80	25.73	19.75	19.80	19.73
EDGE (8PSK, 3 Tx slots) – MCS5		25.62	25.59	25.65	21.36	21.33	21.39
EDGE (8PSK, 4 Tx slots) – MCS5		24.49	24.52	24.55	21.49	21.52	21.55
DTM 5	GSM (GMSK, 1 Tx slot)	31.06	31.15	30.63	25.03	25.11	24.60
	GPRS (GMSK, 1 Tx slot) – CS1	31.05	31.11	30.62			
DTM 9	GSM (GMSK, 1 Tx slot)	31.05	31.12	30.62	25.01	25.10	24.59
	GPRS (GMSK, 1 Tx slot) – CS1	31.02	31.13	30.60			
DTM 11	GSM (GMSK, 1 Tx slot)	29.30	29.25	28.96	25.02	24.98	24.69
	GPRS (GMSK, 2 Tx slots) – CS1	29.27	29.24	28.95			
DTM 5	GSM (GMSK, 1 Tx slot)	31.07	31.16	30.63	23.16	23.23	22.81
	EDGE (8PSK, 1 Tx slot) – MCS5	25.74	25.78	25.70			
DTM 9	GSM (GMSK, 1 Tx slot)	31.05	31.14	30.62	23.14	23.22	22.80
	EDGE (8PSK, 1 Tx slot) – MCS5	25.73	25.77	25.68			
DTM 11	GSM (GMSK, 1 Tx slot)	29.29	29.24	28.96	22.95	22.90	22.78
	EDGE (8PSK, 2 Tx slots) – MCS5	25.61	25.56	25.63			

Remark: The frame-averaged power is linearly scaled the maximum burst averaged power over 8 time slots.
The calculated method are shown as below:
Frame-averaged power = Maximum burst averaged power (1 Tx slots) - 9 dB
Frame-averaged power = Maximum burst averaged power (2 Tx slots) - 6 dB
Frame-averaged power = Maximum burst averaged power (3 Tx slots) - 4.26 dB
Frame-averaged power = Maximum burst averaged power (4 Tx slots) - 3 dB

Note:

1. For Head SAR testing, GSM and DTM should be evaluated, therefore the EUT was set in DTM Multi-slot class 5 for GSM850 due to its highest frame-average power.
2. For Body SAR testing, GSM, GPRS, EDGE and DTM should be evaluated, therefore the EUT was set in GPRS 2 Tx slots for GSM850 due to its highest frame-average power.
3. Per KDB 447498, the maximum output power channel is used for SAR testing and for further SAR test reduction.



Band: GSM1900		Burst Average Power (dBm)			Frame-Average Power (dBm)		
Channel		512	661	810	512	661	810
Frequency (MHz)		1850.2	1880.0	1909.8	1850.2	1880.0	1909.8
GSM (GMSK, 1 Tx slot)		30.34	30.52	30.28	21.34	21.52	21.28
GPRS (GMSK, 1 Tx slot) – CS1		30.33	30.51	30.26	21.33	21.51	21.26
GPRS (GMSK, 2 Tx slots) – CS1		28.45	28.71	28.56	22.45	22.71	22.56
GPRS (GMSK, 3 Tx slots) – CS1		26.50	26.53	26.58	22.24	22.27	22.32
GPRS (GMSK, 4 Tx slots) – CS1		25.10	25.19	25.31	22.10	22.19	22.31
EDGE (GMSK, 1 Tx slot) – MCS1		30.21	30.36	30.28	21.21	21.36	21.28
EDGE (GMSK, 2 Tx slots) – MCS1		28.44	28.68	28.53	22.44	22.68	22.53
EDGE (GMSK, 3 Tx slots) – MCS1		26.51	26.54	26.59	22.25	22.28	22.33
EDGE (GMSK, 4 Tx slots) – MCS1		25.10	25.19	25.30	22.10	22.19	22.30
EDGE (8PSK, 1 Tx slot) – MCS5		26.20	26.24	26.23	17.20	17.24	17.23
EDGE (8PSK, 2 Tx slots) – MCS5		25.18	25.22	25.12	19.18	19.22	19.12
EDGE (8PSK, 3 Tx slots) – MCS5		24.07	24.09	24.08	19.81	19.83	19.82
EDGE (8PSK, 4 Tx slots) – MCS5		22.96	22.97	22.99	19.96	19.97	19.99
DTM 5	GSM (GMSK, 1 Tx slot)	28.44	28.68	28.53	22.41	22.65	22.50
	GPRS (GMSK, 1 Tx slot) – CS1	28.43	28.67	28.51			
DTM 9	GSM (GMSK, 1 Tx slot)	28.44	28.65	28.52	22.41	22.62	22.49
	GPRS (GMSK, 1 Tx slot) – CS1	28.42	28.64	28.51			
DTM 11	GSM (GMSK, 1 Tx slot)	26.46	26.52	26.55	22.19	22.25	22.28
	GPRS (GMSK, 2 Tx slots) – CS1	26.45	26.50	26.53			
DTM 5	GSM (GMSK, 1 Tx slot)	28.43	28.66	28.52	21.08	21.25	21.11
	EDGE (8PSK, 1 Tx slot) – MCS5	25.16	25.20	25.09			
DTM 9	GSM (GMSK, 1 Tx slot)	28.42	28.65	28.51	21.07	21.23	21.10
	EDGE (8PSK, 1 Tx slot) – MCS5	25.16	25.18	25.08			
DTM 11	GSM (GMSK, 1 Tx slot)	26.45	26.51	26.53	20.75	20.77	20.79
	EDGE (8PSK, 2 Tx slots) – MCS5	24.05	24.04	24.07			

Remark: The frame-averaged power is linearly scaled the maximum burst averaged power over 8 time slots.
The calculated method are shown as below:
Frame-averaged power = Maximum burst averaged power (1 Tx slots) - 9 dB
Frame-averaged power = Maximum burst averaged power (2 Tx slots) - 6 dB
Frame-averaged power = Maximum burst averaged power (3 Tx slots) - 4.26 dB
Frame-averaged power = Maximum burst averaged power (4 Tx slots) - 3 dB

Note:

1. For Head SAR testing, GSM and DTM should be evaluated, therefore the EUT was set in DTM Multi-slot class 5 for GSM1900 due to its highest frame-average power.
2. For Body SAR testing, GSM, GPRS, EDGE and DTM should be evaluated, therefore the EUT was set in GPRS 2 Tx slots for GSM1900 due to its highest frame-average power.
3. Per KDB 447498, the maximum output power channel is used for SAR testing and for further SAR test reduction.



<WLAN 2.4GHz Conducted Power>

WLAN 2.4G 802.11b Average Power (dBm)						
Power vs. Channel			Power vs. Data Rate			
Channel	Frequency (MHz)	Data Rate (bps)	Channel	Data Rate (bps)		
		1M		2M	5.5M	11M
CH 01	2412	18.16	CH 11	18.15	18.30	18.28
CH 06	2437	17.94				
CH 11	2462	18.31				

WLAN 2.4G 802.11g Average Power (dBm)										
Power vs. Channel			Power vs. Data Rate							
Channel	Frequency (MHz)	Data Rate (bps)	Channel	Data Rate (bps)						
		6M		9M	12M	18M	24M	36M	48M	54M
CH 01	2412	12.09	CH 11	12.19	12.21	12.25	12.27	12.28	12.28	12.26
CH 06	2437	11.84								
CH 11	2462	12.29								

WLAN 2.4G 802.11n (BW 20MHz) Average Power (dBm)										
Power vs. Channel			Power vs. Data Rate							
Channel	Frequency (MHz)	MCS Index	Channel	MCS Index						
		MCS0		MCS1	MCS2	MCS3	MCS4	MCS5	MCS6	MCS7
CH 01	2412	12.14	CH 11	11.99	11.95	12.07	11.99	11.95	11.94	11.90
CH 06	2437	11.89								
CH 11	2462	12.15								

Note:

1. Per KDB 248227, choose the highest output power channel to test SAR and determine further SAR exclusion
2. Per KDB 248227, 11g and 11n-HT20 output power is less than 0.25dB higher than 11b mode, thus the SAR can be excluded.
3. For each frequency band, testing at higher data rates and higher order modulations is not required when the maximum average output power for each of these configurations is less than 0.25dB higher than those measured at the lowest data rate.

<Bluetooth Conducted Power>

Channel	Frequency (MHz)	Average power (dBm)		
		Mode		
		GFSK	π/4-DQPSK	8-DPSK
CH 0	2402	0.12	-1.15	-1.14
CH 39	2441	0.94	-0.30	-0.30
CH 78	2480	0.96	-0.35	-0.33



11. SAR Test Results

11.1 Test Records for Head SAR Test

<GSM SAR>

Plot No.	Band	Mode	Test Position	Ch.	Freq. (MHz)	Burst Average Power (dBm)	Tune-Up Limit (dBm)	Sample	Battery	Power Drift (dB)	SAR _{1g} (W/kg)	SAR _{10g} (W/kg)	Scaling Factor	Scaled SAR _{1g} (W/kg)
1	GSM850	DTM multi-slot calss 5	Right Cheek	189	836.4	31.15	31.5	1	1	0.027	0.357	0.27	1.084	0.387
2	GSM850	DTM multi-slot calss 5	Right Tilted	189	836.4	31.15	31.5	1	1	0.181	0.263	0.202	1.084	0.285
3	GSM850	DTM multi-slot calss 5	Left Cheek	189	836.4	31.15	31.5	1	1	-0.105	0.32	0.239	1.084	0.347
4	GSM850	DTM multi-slot calss 5	Left Tilted	189	836.4	31.15	31.5	1	1	-0.084	0.229	0.177	1.084	0.248
44	GSM850	DTM multi-slot calss 5	Right Cheek	189	836.4	31.15	31.5	2	2	0.165	0.346	0.269	1.084	0.375
7	GSM1900	DTM multi-slot calss 5	Right Cheek	661	1880	28.68	29	1	1	0.029	0.442	0.284	1.076	0.476
8	GSM1900	DTM multi-slot calss 5	Right Tilted	661	1880	28.68	29	1	1	-0.021	0.176	0.104	1.076	0.189
9	GSM1900	DTM multi-slot calss 5	Left Cheek	661	1880	28.68	29	1	1	-0.14	0.552	0.33	1.076	0.594
10	GSM1900	DTM multi-slot calss 5	Left Tilted	661	1880	28.68	29	1	1	-0.097	0.185	0.114	1.076	0.199
45	GSM1900	DTM multi-slot calss 5	Left Cheek	661	1880	28.68	29	2	2	-0.018	0.378	0.229	1.076	0.407
46	GSM1900	DTM multi-slot calss 5	Left Cheek	512	1850	28.44	29	2	2	-0.093	0.362	0.219	1.138	0.412
47	GSM1900	DTM multi-slot calss 5	Left Cheek	810	1910	28.53	29	2	2	0.072	0.406	0.243	1.114	0.452

Note: Per KDB 648474 and KDB 447498, if the highest output channel SAR for each exposure position ≤ 0.8 W/kg other channels SAR tests are not necessary.

<WLAN SAR>

Plot No.	Band	Mode	Test Position	Ch.	Freq. (MHz)	Average Power (dBm)	Tune-Up Limit (dBm)	Sample	Battery	Power Drift (dB)	SAR _{1g} (W/kg)	SAR _{10g} (W/kg)	Scaling Factor	Scaled SAR _{1g} (W/kg)
31	WLAN2.4G	802.11b	Right Cheek	11	2462	18.31	18.5	1	1	0.177	0.759	0.358	1.045	0.793
32	WLAN2.4G	802.11b	Right Tilted	11	2462	18.31	18.5	1	1	-0.074	0.793	0.349	1.045	0.828
33	WLAN2.4G	802.11b	Left Cheek	11	2462	18.31	18.5	1	1	-0.152	0.551	0.262	1.045	0.576
34	WLAN2.4G	802.11b	Left Tilted	11	2462	18.31	18.5	1	1	-0.046	0.638	0.294	1.045	0.667
43	WLAN2.4G	802.11b	Right Tilted	11	2462	18.31	18.5	2	2	-0.145	0.735	0.325	1.045	0.768

Note: Per KDB 648474 and KDB 248227, if the highest output channel SAR for each exposure position ≤ 0.8 W/kg other channels SAR tests are not necessary.



11.2 Test Records for Hotspot SAR Test

<GSM SAR>

Plot No.	Band	Mode	Test Position	Gap (cm)	Ch.	Freq. (MHz)	Burst Average Power (dBm)	Tune-Up Limit (dBm)	Sample	Battery	Power Drift (dB)	SAR _{1g} (W/kg)	SAR _{10g} (W/kg)	Scaling Factor	Scaled SAR _{1g} (W/kg)
11	GSM850	GPRS 2 Tx slots	Front	1	189	836.4	31.2	31.5	1	1	0.043	0.368	0.278	1.072	0.394
12	GSM850	GPRS 2 Tx slots	Back	1	189	836.4	31.2	31.5	1	1	-0.008	0.573	0.422	1.072	0.614
13	GSM850	GPRS 2 Tx slots	Left Side	1	189	836.4	31.2	31.5	1	1	-0.025	0.274	0.188	1.072	0.294
14	GSM850	GPRS 2 Tx slots	Right Side	1	189	836.4	31.2	31.5	1	1	0.038	0.403	0.278	1.072	0.432
16	GSM850	GPRS 2 Tx slots	Bottom Side	1	189	836.4	31.2	31.5	1	1	0.013	0.098	0.056	1.072	0.105
51	GSM850	GPRS 2 Tx slots	Back	1	189	836.4	31.2	31.5	2	2	-0.165	0.57	0.419	1.072	0.611
18	GSM1900	GPRS 2 Tx slots	Front	1	661	1880	28.71	29	1	1	0.012	0.687	0.431	1.069	0.734
19	GSM1900	GPRS 2 Tx slots	Back	1	661	1880	28.71	29	1	1	-0.004	1.04	0.62	1.069	1.112
20	GSM1900	GPRS 2 Tx slots	Back	1	512	1850.2	28.45	29	1	1	0.007	0.934	0.559	1.135	1.060
21	GSM1900	GPRS 2 Tx slots	Back	1	810	1909.8	28.56	29	1	1	-0.094	1.2	0.717	1.107	1.328
25	GSM1900	GPRS 2 Tx slots	Left Side	1	661	1880	28.71	29	1	1	0.084	0.187	0.103	1.069	0.200
26	GSM1900	GPRS 2 Tx slots	Right Side	1	661	1880	28.71	29	1	1	0	0.085	0.056	1.069	0.091
28	GSM1900	GPRS 2 Tx slots	Bottom Side	1	661	1880	28.71	29	1	1	-0.03	0.912	0.546	1.069	0.975
29	GSM1900	GPRS 2 Tx slots	Bottom Side	1	512	1850.2	28.45	29	1	1	0.014	0.954	0.574	1.135	1.083
30	GSM1900	GPRS 2 Tx slots	Bottom Side	1	810	1909.8	28.56	29	1	1	-0.056	0.877	0.517	1.107	0.971
48	GSM1900	GPRS 2 Tx slots	Back	1	661	1880	28.71	29	2	2	0.082	0.732	0.407	1.069	0.783
49	GSM1900	GPRS 2 Tx slots	Back	1	512	1850.2	28.45	29	2	2	0.127	0.873	0.484	1.135	0.991
50	GSM1900	GPRS 2 Tx slots	Back	1	810	1909.8	28.56	29	2	2	-0.016	0.724	0.405	1.107	0.801

Note:

- Per KDB 941225 D06, for EUT dimension ≥ 9cm*5cm, the test distance is 1cm. SAR must be measured for all surfaces and sides with a transmitting antenna located within 2.5cm from that surface or edge.
- As in (1), SAR for Front / Back / Bottom Side / Left Side / Right Side is necessary.
- Per KDB 648474 and KDB 447498 if the highest output channel SAR for each exposure position ≤ 0.8 W/kg other channels SAR tests are not necessary.

<WLAN SAR>

Plot No.	Band	Mode	Test Position	Gap (cm)	Ch.	Freq. (MHz)	Average Power (dBm)	Tune-Up Limit (dBm)	Sample	Battery	Power Drift (dB)	SAR _{1g} (W/kg)	SAR _{10g} (W/kg)	Scaling Factor	Scaled SAR _{1g} (W/kg)
35	WLAN2.4G	802.11b	Front	1	11	2462	18.31	18.5	1	1	-0.167	0.184	0.091	1.045	0.192
36	WLAN2.4G	802.11b	Back	1	11	2462	18.31	18.5	1	1	-0.086	0.408	0.197	1.045	0.426
37	WLAN2.4G	802.11b	Left Side	1	11	2462	18.31	18.5	1	1	-0.163	0.076	0.04	1.045	0.079
38	WLAN2.4G	802.11b	Right Side	1	11	2462	18.31	18.5	1	1	-0.134	0.021	0.00996	1.045	0.022
39	WLAN2.4G	802.11b	Top Side	1	11	2462	18.31	18.5	1	1	0.079	0.387	0.183	1.045	0.404
42	WLAN2.4G	802.11b	Back	1	11	2462	18.31	18.5	2	2	-0.138	0.398	0.193	1.045	0.416

Note:

- Per KDB 941225 D06, for EUT dimension ≥ 9cm*5cm, the test distance is 1cm. SAR must be measured for all surfaces and sides with a transmitting antenna located within 2.5cm from that surface or edge.
- As in (1), SAR for Front / Back / Top Side / Right Side / Left Side is necessary.
- Per KDB 648474 and KDB 248227, if the highest output channel SAR for each exposure position ≤ 0.8 W/kg other channels SAR tests are not necessary.



11.3 Test Records for Body-worn SAR Test

<GSM SAR>

Plot No.	Band	Mode	Test Position	Gap (cm)	Ch.	Freq. (MHz)	Burst Average Power (dBm)	Tune-Up Limit (dBm)	Sample	Battery	Headset	Power Drift (dB)	SAR _{1g} (W/kg)	SAR _{10g} (W/kg)	Scaling Factor	Scaled SAR _{1g} (W/kg)
11	GSM850	GPRS 2 Tx slots	Front	1	189	836.4	31.2	31.5	1	1	-	0.043	0.368	0.278	1.072	0.394
12	GSM850	GPRS 2 Tx slots	Back	1	189	836.4	31.2	31.5	1	1	-	-0.008	0.573	0.422	1.072	0.614
17	GSM850	GPRS 2 Tx slots	Back	1	189	836.4	31.2	31.5	1	1	v	-0.1	0.401	0.283	1.072	0.430
18	GSM1900	GPRS 2 Tx slots	Front	1	661	1880	28.71	29	1	1	-	0.012	0.687	0.431	1.069	0.734
19	GSM1900	GPRS 2 Tx slots	Back	1	661	1880	28.71	29	1	1	-	-0.004	1.04	0.62	1.069	1.112
20	GSM1900	GPRS 2 Tx slots	Back	1	512	1850.2	28.45	29	1	1	-	0.007	0.934	0.559	1.135	1.060
21	GSM1900	GPRS 2 Tx slots	Back	1	810	1909.8	28.56	29	1	1	-	-0.094	1.2	0.717	1.107	1.328
22	GSM1900	GPRS 2 Tx slots	Back	1	810	1909.8	28.56	29	1	1	v	-0.059	1.19	0.704	1.107	1.317
23	GSM1900	GPRS 2 Tx slots	Back	1	512	1850.2	28.45	29	1	1	v	0.092	0.905	0.542	1.135	1.027
24	GSM1900	GPRS 2 Tx slots	Back	1	661	1880	28.71	29	1	1	v	-0.075	1	0.596	1.069	1.069

Note:

- Per KDB 648474 and KDB 447498, if the highest output channel SAR for each exposure position ≤ 0.8 W/kg other channels SAR tests are not necessary.
- "V" in the Headset column means the Headset is plugged during SAR testing.

<WLAN SAR>

Plot No.	Band	Mode	Test Position	Gap (cm)	Ch.	Freq. (MHz)	Average Power (dBm)	Tune-Up Limit (dBm)	Sample	Battery	Headset	Power Drift (dB)	SAR _{1g} (W/kg)	SAR _{10g} (W/kg)	Scaling Factor	Scaled SAR _{1g} (W/kg)
35	WLAN2.4G	802.11b	Front	1	11	2462	18.31	18.5	1	1	-	-0.167	0.184	0.091	1.045	0.192
36	WLAN2.4G	802.11b	Back	1	11	2462	18.31	18.5	1	1	-	-0.086	0.408	0.197	1.045	0.426
41	WLAN2.4G	802.11b	Back	1	11	2462	18.31	18.5	1	1	v	-0.113	0.402	0.186	1.045	0.420

Note:

- Per KDB 648474 and KDB 248227, if the highest output channel SAR for each exposure position ≤ 0.8 W/kg other channels SAR tests are not necessary.
- "V" in the Headset column means the Headset is plugged during SAR testing.

11.4 Simultaneous Multi-band Transmission Analysis

No.	Applicable Simultaneous Transmission Combination
1.	2G + BT
2.	2G + WLAN 2.4G

Note:

1. WLAN and BT share the same antenna, and cannot transmit simultaneously.
2. The maximum SAR summation is calculated based on the same configuration and test position.
3. When stand-alone 1-g SAR is not required for a transmitter or antenna, its SAR is considered zero in the 1-g SAR summing process to determine simultaneous transmission SAR evaluation requirements
4. If 1g-SAR scalar summation < 1.6W/kg, simultaneous SAR measurement is not necessary.
5. If 1g-SAR summation > 1.6W/kg, SPLSR calculation is necessary.

<Head SAR>

Position	WWAN			Scaled WWAN				WLAN		Scaled WLAN				WWAN + WLAN	Scaled WWAN + Scaled WLAN
	WWAN Band	Plot No	Max. WWAN SAR (W/kg)	Average Power (dBm)	Tune-up Limit (dBm)	Scaling Factor	Scaled WWAN (W/kg)	Plot No	Max. WLAN SAR (W/kg)	Average Power (dBm)	Tune-up Limit (dBm)	Scaling Factor	Scaled WLAN (W/kg)		
Right Cheek	GSM850	1	0.357	31.15	31.5	1.084	0.387	31	0.759	18.31	18.5	1.045	0.793	1.12	1.18
	GSM1900	7	0.442	28.68	29	1.076	0.476	31	0.759	18.31	18.5	1.045	0.793	1.20	1.27
Right Tilted	GSM850	2	0.263	31.15	31.5	1.084	0.285	32	0.793	18.31	18.5	1.045	0.828	1.06	1.11
	GSM1900	8	0.176	28.68	29	1.076	0.189	32	0.793	18.31	18.5	1.045	0.828	0.97	1.02
Left Cheek	GSM850	3	0.32	31.15	31.5	1.084	0.347	33	0.551	18.31	18.5	1.045	0.576	0.87	0.92
	GSM1900	9	0.552	28.68	29	1.076	0.594	33	0.551	18.31	18.5	1.045	0.576	1.10	1.17
Left Tilted	GSM850	4	0.229	31.15	31.5	1.084	0.248	34	0.638	18.31	18.5	1.045	0.667	0.87	0.92
	GSM1900	10	0.185	28.68	29	1.076	0.199	34	0.638	18.31	18.5	1.045	0.667	0.82	0.87

<Hotspot SAR>

Position	WWAN			Scaled WWAN				WLAN		Scaled WLAN				WWAN + WLAN	Scaled WWAN + Scaled WLAN
	WWAN Band	Plot No	Max. WWAN SAR (W/kg)	Average Power (dBm)	Tune-up Limit (dBm)	Scaling Factor	Scaled WWAN (W/kg)	Plot No	Max. WLAN SAR (W/kg)	Average Power (dBm)	Tune-up Limit (dBm)	Scaling Factor	Scaled WLAN (W/kg)		
Front	GSM850	11	0.368	31.2	31.5	1.072	0.394	35	0.184	18.31	18.5	1.045	0.192	0.55	0.59
	GSM1900	18	0.687	28.71	29	1.069	0.734	35	0.184	18.31	18.5	1.045	0.192	0.87	0.93
Back	GSM850	12	0.573	31.2	31.5	1.072	0.614	36	0.408	18.31	18.5	1.045	0.426	0.98	1.04
	GSM1900	21	1.2	28.56	29	1.107	1.328	36	0.408	18.31	18.5	1.045	0.426	1.61	1.75
Left Side	GSM850	13	0.274	31.2	31.5	1.072	0.294	37	0.076	18.31	18.5	1.045	0.079	0.35	0.37
	GSM1900	25	0.187	28.71	29	1.069	0.200	37	0.076	18.31	18.5	1.045	0.079	0.26	0.28
Right Side	GSM850	14	0.403	31.2	31.5	1.072	0.432	38	0.021	18.31	18.5	1.045	0.022	0.42	0.45
	GSM1900	26	0.085	28.71	29	1.069	0.091	38	0.021	18.31	18.5	1.045	0.022	0.11	0.11
Top Side	GSM850							39	0.387	18.31	18.5	1.045	0.404	0.39	0.40
	GSM1900							39	0.387	18.31	18.5	1.045	0.404	0.39	0.40
Bottom Side	GSM850	16	0.098	31.2	31.5	1.072	0.105							0.10	0.11
	GSM1900	29	0.954	28.45	29	1.135	1.083							0.95	1.08

<Body-worn SAR>

Position	WWAN			Scaled WWAN				WLAN		Scaled WLAN				WWAN + WLAN	Scaled WWAN + Scaled WLAN
	WWAN Band	Plot No	Max. WWAN SAR (W/kg)	Average Power (dBm)	Tune-up Limit (dBm)	Scaling Factor	Scaled WWAN (W/kg)	Plot No	Max. WLAN SAR (W/kg)	Average Power (dBm)	Tune-up Limit (dBm)	Scaling Factor	Scaled WLAN (W/kg)		
Front	GSM850	11	0.368	31.2	31.5	1.072	0.394	35	0.184	18.31	18.5	1.045	0.192	0.55	0.59
	GSM1900	18	0.687	28.71	29	1.069	0.734	35	0.184	18.31	18.5	1.045	0.192	0.87	0.93
Back	GSM850	12	0.573	31.2	31.5	1.072	0.614	36	0.408	18.31	18.5	1.045	0.426	0.98	1.04
	GSM1900	21	1.2	28.56	29	1.107	1.328	36	0.408	18.31	18.5	1.045	0.426	1.61	1.75
Back (w/ Headset)	GSM850	17	0.401	31.2	31.5	1.072	0.430	41	0.402	18.31	18.5	1.045	0.420	0.80	0.85
	GSM1900	22	1.19	28.56	29	1.107	1.317	41	0.402	18.31	18.5	1.045	0.420	1.59	1.74

11.5 Simultaneous analysis - SPLSR calculation

Plot No	Band	Position	SAR (W/kg)	Gap (cm)	SAR peak location (m)			3D distance (cm)	Pair SAR sum (W/kg)	SPLSR	Simultaneous SAR
					X	Y	Z				
#21	GSM1900	Back	1.328	1	-0.022	-0.043	-0.202	10.0	1.75	0.17	Not required
#36	WLAN2.4G		0.426	1	-0.012	0.057	-0.202				

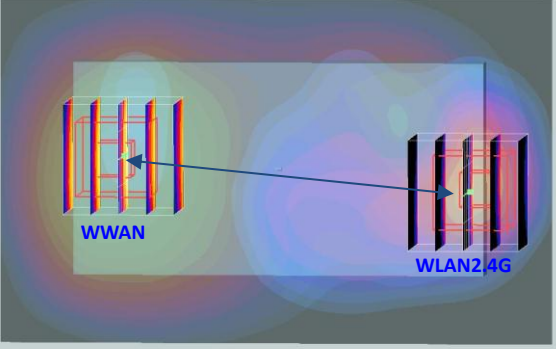

Plot No	Band	Position	SAR (W/kg)	Gap (cm)	SAR peak location (m)			3D distance (cm)	Pair SAR sum (W/kg)	SPLSR	Simultaneous SAR
					X	Y	Z				
#22	GSM1900	Back	1.317	1	-0.016	-0.049	-0.202	11.0	1.74	0.16	Not required
#41	WLAN2.4G		0.42	1	-0.014	0.061	-0.202				

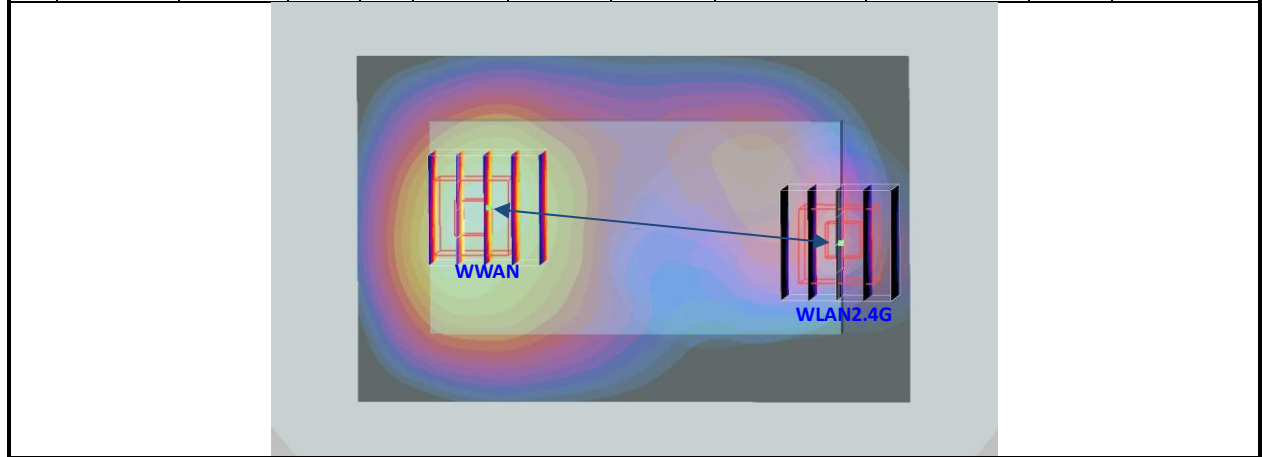

Note: Per KDB 447498, if SPLSR < 0.3, simultaneously transmission SAR is not necessary.

Test Engineer : Ken Li and Michael Yang

12. Uncertainty Assessment

The component of uncertainty may generally be categorized according to the methods used to evaluate them. The evaluation of uncertainty by the statistical analysis of a series of observations is termed a Type A evaluation of uncertainty. The evaluation of uncertainty by means other than the statistical analysis of a series of observations is termed a Type B evaluation of uncertainty. Each component of uncertainty, however evaluated, is represented by an estimated standard deviation, termed standard uncertainty, which is determined by the positive square root of the estimated variance.

A Type A evaluation of standard uncertainty may be based on any valid statistical method for treating data. This includes calculating the standard deviation of the mean of a series of independent observations; using the method of least squares to fit a curve to the data in order to estimate the parameter of the curve and their standard deviations; or carrying out an analysis of variance in order to identify and quantify random effects in certain kinds of measurement.

A type B evaluation of standard uncertainty is typically based on scientific judgment using all of the relevant information available. These may include previous measurement data, experience, and knowledge of the behavior and properties of relevant materials and instruments, manufacture’s specification, data provided in calibration reports and uncertainties assigned to reference data taken from handbooks. Broadly speaking, the uncertainty is either obtained from an outdoor source or obtained from an assumed distribution, such as the normal distribution, rectangular or triangular distributions indicated in Table 12.1

Uncertainty Distributions	Normal	Rectangular	Triangular	U-Shape
Multi-plying Factor ^(a)	1/k ^(b)	1/√3	1/√6	1/√2

(a) standard uncertainty is determined as the product of the multiplying factor and the estimated range of variations in the measured quantity

(b) κ is the coverage factor

Table 12.1 Standard Uncertainty for Assumed Distribution

The combined standard uncertainty of the measurement result represents the estimated standard deviation of the result. It is obtained by combining the individual standard uncertainties of both Type A and Type B evaluation using the usual “root-sum-squares” (RSS) methods of combining standard deviations by taking the positive square root of the estimated variances.

Expanded uncertainty is a measure of uncertainty that defines an interval about the measurement result within which the measured value is confidently believed to lie. It is obtained by multiplying the combined standard uncertainty by a coverage factor. Typically, the coverage factor ranges from 2 to 3. Using a coverage factor allows the true value of a measured quantity to be specified with a defined probability within the specified uncertainty range. For purpose of this document, a coverage factor two is used, which corresponds to confidence interval of about 95 %. The DASY uncertainty Budget is shown in the following tables.



Error Description	Uncertainty Value (±%)	Probability Distribution	Divisor	Ci (1g)	Ci (10g)	Standard Uncertainty (1g)	Standard Uncertainty (10g)
Measurement System							
Probe Calibration	6.0	Normal	1	1	1	± 6.0 %	± 6.0 %
Axial Isotropy	4.7	Rectangular	√3	0.7	0.7	± 1.9 %	± 1.9 %
Hemispherical Isotropy	9.6	Rectangular	√3	0.7	0.7	± 3.9 %	± 3.9 %
Boundary Effects	1.0	Rectangular	√3	1	1	± 0.6 %	± 0.6 %
Linearity	4.7	Rectangular	√3	1	1	± 2.7 %	± 2.7 %
System Detection Limits	1.0	Rectangular	√3	1	1	± 0.6 %	± 0.6 %
Readout Electronics	0.3	Normal	1	1	1	± 0.3 %	± 0.3 %
Response Time	0.8	Rectangular	√3	1	1	± 0.5 %	± 0.5 %
Integration Time	2.6	Rectangular	√3	1	1	± 1.5 %	± 1.5 %
RF Ambient Noise	3.0	Rectangular	√3	1	1	± 1.7 %	± 1.7 %
RF Ambient Reflections	3.0	Rectangular	√3	1	1	± 1.7 %	± 1.7 %
Probe Positioner	0.4	Rectangular	√3	1	1	± 0.2 %	± 0.2 %
Probe Positioning	2.9	Rectangular	√3	1	1	± 1.7 %	± 1.7 %
Max. SAR Eval.	1.0	Rectangular	√3	1	1	± 0.6 %	± 0.6 %
Test Sample Related							
Device Positioning	2.9	Normal	1	1	1	± 2.9 %	± 2.9 %
Device Holder	3.6	Normal	1	1	1	± 3.6 %	± 3.6 %
Power Drift	5.0	Rectangular	√3	1	1	± 2.9 %	± 2.9 %
Phantom and Setup							
Phantom Uncertainty	4.0	Rectangular	√3	1	1	± 2.3 %	± 2.3 %
Liquid Conductivity (Target)	5.0	Rectangular	√3	0.64	0.43	± 1.8 %	± 1.2 %
Liquid Conductivity (Meas.)	2.5	Normal	1	0.64	0.43	± 1.6 %	± 1.1 %
Liquid Permittivity (Target)	5.0	Rectangular	√3	0.6	0.49	± 1.7 %	± 1.4 %
Liquid Permittivity (Meas.)	2.5	Normal	1	0.6	0.49	± 1.5 %	± 1.2 %
Combined Standard Uncertainty						± 11.0 %	± 10.8 %
Coverage Factor for 95 %						K=2	
Expanded Uncertainty						± 22.0 %	± 21.5 %

Table 12.2 Uncertainty Budget of DASY for frequency range 300 MHz to 3 GHz



13. References

- [1] FCC 47 CFR Part 2 "Frequency Allocations and Radio Treaty Matters; General Rules and Regulations"
- [2] ANSI/IEEE Std. C95.1-1992, "IEEE Standard for Safety Levels with Respect to Human Exposure to Radio Frequency Electromagnetic Fields, 3 kHz to 300 GHz", September 1992
- [3] IEEE Std. 1528-2003, "Recommended Practice for Determining the Peak Spatial-Average Specific Absorption Rate (SAR) in the Human Head from Wireless Communications Devices: Measurement Techniques", December 2003
- [4] FCC OET Bulletin 65 (Edition 97-01) Supplement C (Edition 01-01), "Evaluating Compliance with FCC Guidelines for Human Exposure to Radiofrequency Electromagnetic Fields", June 2001
- [5] SPEAG DASY System Handbook
- [6] FCC KDB 248227 D01 v01r02, "SAR Measurement Procedures for 802.11 a/b/g Transmitters", May 2007
- [7] FCC KDB 447498 D01 v04, "Mobile and Portable Device RF Exposure Procedures and Equipment Authorization Policies", November 2009
- [8] FCC KDB 648474 D01 v01r05, "SAR Evaluation Considerations for Handsets with Multiple Transmitters and Antennas", September 2008
- [9] FCC KDB 941225 D01 v02, "SAR Measurement Procedures for 3G Devices – CDMA 2000 / Ev-Do / WCDMA / HSDPA / HSPA", October 2007
- [10] FCC KDB 941225 D03 v01, "Recommended SAR Test Reduction Procedures for GSM / GPRS / EDGE", December 2008
- [11] FCC KDB 941225 D04 v01, "Evaluating SAR for GSM/(E)GPRS Dual Transfer Mode", January 27 2010
- [12] FCC KDB 941225 D06 v01, "SAR Evaluation Procedures for Portable Devices with Wireless Router Capabilities", April 2011



Appendix A. Plots of System Performance Check

The plots are shown as follows.



Appendix B. Plots of SAR Measurement

The plots are shown as follows.



Appendix C. DAS Y Calibration Certificate

The DAS Y calibration certificates are shown as follows.