



FCC TEST REPORT (PART 22)

REPORT NO.: RF121225C13

MODEL NO.: PM33100

FCC ID: NM8PM33100

RECEIVED: Dec. 25, 2012

TESTED: Jan. 23, 2013 ~ Jan. 31, 2013

ISSUED: Feb. 08, 2013

APPLICANT: HTC Corporation

ADDRESS: 23, Xinghua Rd., Taoyuan 330, Taiwan, R.O.C.

ISSUED BY: Bureau Veritas Consumer Products Services
(H.K.) Ltd., Taoyuan Branch

LAB ADDRESS: No. 47, 14th Ling, Chia Pau Vil., Lin Kou Dist., New
Taipei City, Taiwan (R.O.C.)

TEST LOCATION: No. 19, Hwa Ya 2nd Rd, Wen Hwa Tsuen, Kwei
Shan Hsiang, Taoyuan Hsien 333, Taiwan, R.O.C.

This report should not be used by the client to claim
product certification, approval, or endorsement by TAF or
any government agencies.



This report is for your exclusive use. Any copying or replication of this report to or for any other person or entity, or use of our name or trademark, is permitted only with our prior written permission. This report sets forth our findings solely with respect to the test samples identified herein. The results set forth in this report are not indicative or representative of the quality or characteristics of the lot from which a test sample was taken or any similar or identical product unless specifically and expressly noted. Our report includes all of the tests requested by you and the results thereof based upon the information that you provided to us. You have 60 days from date of issuance of this report to notify us of any material error or omission caused by our negligence, provided, however, that such notice shall be in writing and shall specifically address the issue you wish to raise. A failure to raise such issue within the prescribed time shall constitute your unqualified acceptance of the completeness of this report, the tests conducted and the correctness of the report contents. Unless specific mention, the uncertainty of measurement has been explicitly taken into account to declare the compliance or non-compliance to the specification

TABLE OF CONTENTS

RELEASE CONTROL RECORD.....	4
1 CERTIFICATION	5
2 SUMMARY OF TEST RESULTS	6
2.1 MEASUREMENT UNCERTAINTY.....	6
2.2 TEST SITE AND INSTRUMENTS	7
3 GENERAL INFORMATION.....	8
3.1 GENERAL DESCRIPTION OF EUT	8
3.2 CONFIGURATION OF SYSTEM UNDER TEST	9
3.3 DESCRIPTION OF SUPPORT UNITS	9
3.4 TEST ITEM AND TEST CONFIGURATION.....	10
3.5 EUT OPERATING CONDITIONS	12
3.6 GENERAL DESCRIPTION OF APPLIED STANDARDS	12
4 TEST TYPES AND RESULTS.....	13
4.1 OUTPUT POWER MEASUREMENT.....	13
4.1.1 LIMITS OF OUTPUT POWER MEASUREMENT	13
4.1.2 TEST PROCEDURES	13
4.1.3 TEST SETUP.....	14
4.1.4 TEST RESULTS	15
4.2 FREQUENCY STABILITY MEASUREMENT.....	24
4.2.1 LIMITS OF FREQUENCY STABILITY MEASUREMENT	24
4.2.2 TEST PROCEDURE.....	24
4.2.3 TEST SETUP.....	24
4.2.4 TEST RESULTS	25
4.3 OCCUPIED BANDWIDTH MEASUREMENT	26
4.3.1 TEST PROCEDURES	26
4.3.2 TEST SETUP.....	26
4.3.3 TEST RESULTS	27
4.4 BAND EDGE MEASUREMENT	29
4.4.1 LIMITS OF BAND EDGE MEASUREMENT	29
4.4.2 TEST SETUP.....	29
4.4.3 TEST PROCEDURES	29
4.4.4 TEST RESULTS	30
4.5 CONDUCTED SPURIOUS EMISSIONS	33
4.5.1 LIMITS OF CONDUCTED SPURIOUS EMISSIONS MEASUREMENT.....	33
4.5.2 TEST PROCEDURE.....	33
4.5.3 TEST SETUP.....	33
4.5.4 TEST RESULTS	34
4.6 RADIATED EMISSION MEASUREMENT	35
4.6.1 LIMITS OF RADIATED EMISSION MEASUREMENT	35



A D T

4.6.2	TEST PROCEDURES	35
4.6.3	DEVIATION FROM TEST STANDARD.....	35
4.6.4	TEST SETUP.....	36
4.6.5	TEST RESULTS	37
5	PHOTOGRAPHS OF THE TEST CONFIGURATION.....	49
6	INFORMATION ON THE TESTING LABORATORIES.....	50
7	APPENDIX A – MODIFICATIONS RECORDERS FOR ENGINEERING CHANGES TO THE EUT BY THE LAB.....	51



A D T

RELEASE CONTROL RECORD

ISSUE NO.	REASON FOR CHANGE	DATE ISSUED
RF121225C13	Original release	Feb. 08, 2013



1 CERTIFICATION

PRODUCT: Smartphone

MODEL: PM33100

BRAND: HTC

APPLICANT: HTC Corporation

TESTED: Jan. 23, 2013 ~ Jan. 31, 2013

TEST SAMPLE: Production Unit

STANDARDS: FCC PART 22, Subpart H

The above equipment (model: PM33100) has been tested by **Bureau Veritas Consumer Products Services (H.K.) Ltd., Taoyuan Branch**, and found compliance with the requirement of the above standards. The test record, data evaluation & Equipment Under Test (EUT) configurations represented herein are true and accurate accounts of the measurements of the sample's EMC characteristics under the conditions specified in this report.

PREPARED BY : Ivonne Wu , **DATE** : Feb. 08, 2013
Ivonne Wu / Senior Specialist

APPROVED BY : Anderson Chiu , **DATE** : Feb. 08, 2013
Anderson Chiu / Senior Engineer

2 SUMMARY OF TEST RESULTS

The EUT has been tested according to the following specifications:

APPLIED STANDARD: FCC Part 22 & Part 2			
STANDARD SECTION	TEST TYPE	RESULT	REMARK
2.1046 22.913 (a)	Effective radiated power	PASS	Meet the requirement of limit.
2.1055 22.355	Frequency Stability	PASS	Meet the requirement of limit.
2.1049	Occupied Bandwidth	PASS	Meet the requirement of limit.
22.917	Band Edge Measurements	PASS	Meet the requirement of limit.
2.1051 22.917	Conducted Spurious Emissions	PASS	Meet the requirement of limit.
2.1053 22.917	Radiated Spurious Emissions	PASS	Meet the requirement of limit. Minimum passing margin is -16.73dB at 1672.80MHz.

2.1 MEASUREMENT UNCERTAINTY

Where relevant, the following measurement uncertainty levels have been estimated for tests performed on the EUT as specified in CISPR 16-4-2:

MEASUREMENT	FREQUENCY	UNCERTAINTY
Conducted emissions	150kHz~30MHz	2.44 dB
Radiated emissions	30MHz ~ 200MHz	2.93 dB
	200MHz ~1000MHz	2.95 dB
	1GHz ~ 18GHz	2.26 dB
	18GHz ~ 40GHz	1.94 dB

This uncertainty represents an expanded uncertainty expressed at approximately the 95% confidence level using a coverage factor of k=2.



2.2 TEST SITE AND INSTRUMENTS

DESCRIPTION & MANUFACTURER	MODEL NO.	SERIAL NO.	DATE OF CALIBRATION	DUE DATE OF CALIBRATION
Test Receiver ROHDE & SCHWARZ	ESCI	100744	Apr. 19, 2012	Apr. 18, 2013
Spectrum Analyzer ROHDE & SCHWARZ	FSU43	101261	Dec. 17, 2012	Dec. 16, 2013
BILOG Antenna SCHWARZBECK	VULB9168	9168-472	Apr. 03, 2012	Apr. 02, 2013
HORN Antenna SCHWARZBECK	BBHA 9120 D	9120D-969	Jan. 07, 2013	Jan. 06, 2014
HORN Antenna SCHWARZBECK	BBHA 9170	9170-480	Dec. 25, 2012	Dec. 24, 2013
Preamplifier EMCI	EMC 012645	980115	Dec. 28, 2012	Dec. 27, 2013
Preamplifier EMCI	EMC 184045	980116	Dec. 28, 2012	Dec. 27, 2013
Preamplifier EMCI	EMC 330H	980112	Dec. 28, 2012	Dec. 27, 2013
RF signal cable HUBER+SUHNNER	SUCOFLEX 104	309219/4	Oct. 19, 2012	Oct. 18, 2013
RF signal cable HUBER+SUHNNER	SUCOFLEX 104	250130/4	Oct. 19, 2012	Oct. 18, 2013
RF signal cable Worken	RG-213	NA	Dec. 29, 2012	Dec. 28, 2013
Software	E3 6.120103	NA	NA	NA
Antenna Tower MF	MFA-440H	NA	NA	NA
Turn Table MF	MFT-201SS	NA	NA	NA
Antenna Tower & Turn Table Controller MF	MF-7802	NA	NA	NA
Mini-Circuits Power Splitter	ZN2PD-9G	NA	Mar. 23, 2012	Mar. 22, 2013
JFW 20dB attenuation	50HF-020-SMA	NA	NA	NA
Communications Tester-Wireless	E5515C	MY52102049	Jun. 11, 2012	Jun. 10, 2013
Radio Communication Analyzer	MT8820C	6201168830	Jul. 17, 2012	Jul. 16, 2013

- NOTE:** 1. The calibration interval of the above test instruments is 12 months and the calibrations are traceable to NML/ROC and NIST/USA.
 2. The test was performed in HwaYa Chamber 9.
 3. The horn antenna and HP preamplifier (model: 8449B) are used only for the measurement of emission frequency above 1GHz if tested.
 4. The FCC Site Registration No. is 460141.
 5. The IC Site Registration No. is IC 7450F-4.

3 GENERAL INFORMATION

3.1 GENERAL DESCRIPTION OF EUT

EUT	Smartphone	
MODEL NO.	PM33100	
POWER SUPPLY	5.0Vdc (adapter or host equipment) 3.8Vdc (battery)	
MODULATION TYPE	GSM/GPRS	GMSK
	EDGE	8PSK
	WCDMA	BPSK
	LTE	QPSK, 16QAM
FREQUENCY RANGE	GSM/GPRS/EDGE	824.2MHz ~ 848.8MHz
	WCDMA	826.4MHz ~ 846.6MHz
	LTE (Channel Bandwidth: 5MHz)	826.5MHz ~ 846.5MHz
	LTE (Channel Bandwidth: 10MHz)	829MHz ~ 844MHz
MAX. ERP POWER	GSM	839.46mW
	EDGE	254.10mW
	WCDMA	105.20mW
	LTE	125.60mW
EMISSION DESIGNATOR	GSM	249KGXW
	EDGE	245KG7W
	WCDMA	4M18F9W
	LTE (Channel Bandwidth: 5MHz)	4M48G7D
	LTE (Channel Bandwidth: 10MHz)	8M92W7D
MULTI-SLOTS CLASS	10	
WCDMA RELEASE VERSION	8	
ANTENNA TYPE	Fixed Internal Antenna	
I/O PORTS	Refer to users' manual	
DATA CABLE	Refer to NOTE as below	
ACCESSORY DEVICES	Refer to NOTE as below	

NOTE:

1. The EUT's accessories list refers to Ext Pho.
2. The device has 2 configurations as below.
Main Sample (A): Battery 1 + Photo Camera 1
2nd Sample (B): Battery 2 + Photo Camera 2
3. The above EUT information was declared by manufacturer and for more detailed features description, please refer to the manufacturer's specifications or User's Manual.

3.2 CONFIGURATION OF SYSTEM UNDER TEST

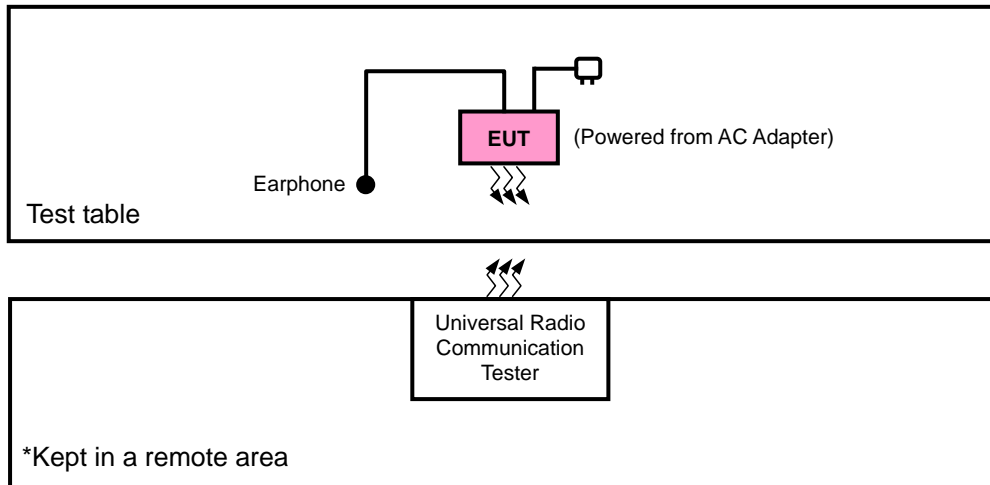

3.3 DESCRIPTION OF SUPPORT UNITS

The EUT has been tested as an independent unit together with other necessary accessories or support units.

3.4 TEST ITEM AND TEST CONFIGURATION

Pre-Scan has been conducted to determine the worst-case mode from all possible combinations between available modulations, data rates, XYZ axis and antenna ports. The worst case was found as listed below for radiated emission. Following channel(s) was (were) selected for the final test as listed below:

EUT CONFIGURE MODE	TEST ITEM	AXIS FOR RADIATED EMISSION
A	Main Sample	GSM / EDGE / WCDMA / LTE : Y
B	2 nd Sample	GSM : Y
		LTE : X

GSM MODE

EUT CONFIGURE MODE	TEST ITEM	AVAILABLE CHANNEL	TESTED CHANNEL	MODE
A, B	ERP	128 to 251	128, 189, 251	GSM, EDGE
A	FREQUENCY STABILITY	128 to 251	189	GSM, EDGE
A	OCCUPIED BANDWIDTH	128 to 251	128, 189, 251	GSM, EDGE
A	BAND EDGE	128 to 251	128, 251	GSM, EDGE
A	CONDCUDED EMISSION	128 to 251	189	GSM
A	RADIATED EMISSION	128 to 251	189	GSM, EDGE
B	RADIATED EMISSION	128 to 251	189	GSM

WCDMA MODE

EUT CONFIGURE MODE	TEST ITEM	AVAILABLE CHANNEL	TESTED CHANNEL	MODE
A, B	ERP	4132 to 4233	4132, 4182, 4233	WCDMA
A	FREQUENCY STABILITY	4132 to 4233	4182	WCDMA
A	OCCUPIED BANDWIDTH	4132 to 4233	4132, 4182, 4233	WCDMA
A	BAND EDGE	4132 to 4233	4132, 4233	WCDMA
A	CONDCUDED EMISSION	4132 to 4233	4182	WCDMA
A	RADIATED EMISSION	4132 to 4233	4182	WCDMA



A D T

LTE BAND 5 MODE

EUT CONFIGURE MODE	TEST ITEM	AVAILABLE CHANNEL	TESTED CHANNEL	CHANNEL BANDWIDTH	MODULATION	MODE
A	ERP	20425 to 20625	20425, 20525, 20625	5MHz	QPSK	1 RB / 12 RB Offset
B		20450 to 20600	20450, 20525, 20600	10MHz	QPSK	1 RB / 24 RB Offset
A	FREQUENCY STABILITY	20425 to 20625	20525	5MHz	QPSK	1 RB / 12 RB Offset
		20450 to 20600	20525	10MHz	QPSK	1 RB / 24 RB Offset
A	OCCUPIED BANDWIDTH	20425 to 20625	20425, 20525, 20625	5MHz	QPSK	25 RB / 0 RB Offset
					16QAM	25 RB / 0 RB Offset
		20450 to 20600	20450, 20525, 20600	10MHz	QPSK	50 RB / 0 RB Offset
					16QAM	50 RB / 0 RB Offset
A	BAND EDGE	20425 to 20626	20425	5MHz	QPSK	1 RB / 0 RB Offset
			20600	5MHz	QPSK	25 RB / 0 RB Offset
		20450 to 20600	20450	10MHz	QPSK	1 RB / 24 RB Offset
			20600	10MHz	QPSK	25 RB / 0 RB Offset
			20450	10MHz	QPSK	1 RB / 0 RB Offset
			20600	10MHz	QPSK	50 RB / 0 RB Offset
A	CONDCUDED EMISSION	20425 to 20625	20525	5MHz	QPSK	1 RB / 12 RB Offset
		20450 to 20600	20525	10MHz	QPSK	1 RB / 24 RB Offset
A	RADIATED EMISSION	20450 to 20600	20525	10MHz	QPSK	1 RB / 24 RB Offset
B	RADIATED EMISSION	20450 to 20600	20525	10MHz	QPSK	1 RB / 24 RB Offset

Note: This device was tested under all bandwidths, RB configurations and modulations. The worst case were found in QPSK modulation.

TEST CONDITION:

TEST ITEM	ENVIRONMENTAL CONDITIONS	INPUT POWER	TESTED BY
ERP	26deg. C, 58%RH	3.8Vdc	Howard Kao
FREQUENCY STABILITY	26deg. C, 58%RH	3.8Vdc	Howard Kao
OCCUPIED BANDWIDTH	26deg. C, 58%RH	3.8Vdc	Howard Kao
BAND EDGE	26deg. C, 58%RH	3.8Vdc	Howard Kao
CONDCUDED EMISSION	26deg. C, 58%RH	3.8Vdc	Howard Kao
RADIATED EMISSION	25deg. C, 65%RH	120Vac, 60Hz	Kay Wu



A D T

3.5 EUT OPERATING CONDITIONS

The EUT makes a call to the communication simulator. The communication simulator station system controlled a EUT to export maximum output power under transmission mode and specific channel frequency

3.6 GENERAL DESCRIPTION OF APPLIED STANDARDS

The EUT is a RF product. According to the specifications of the manufacturer, it must comply with the requirements of the following standards:

FCC 47 CFR Part 2

FCC 47 CFR Part 22

ANSI/TIA/EIA-603-C 2004

NOTE: All test items have been performed and recorded as per the above standards.

4 TEST TYPES AND RESULTS

4.1 OUTPUT POWER MEASUREMENT

4.1.1 LIMITS OF OUTPUT POWER MEASUREMENT

Mobile / Portable station are limited to 7 watts e.r.p.

4.1.2 TEST PROCEDURES

EIRP / ERP MEASUREMENT:

- a. The EUT was placed on a turntable with 1.727 meter height in a fully anechoic chamber.
- b. The EUT was set at 4.858 meters from the receiving antenna, which was mounted on the antenna tower.
- c. The EUT was rotated along 2 axis: Theta-axis: 180 degree and Phi-axis: 360 degree, Step Size: 15 degree.
- d. The height of the receiving antenna is fixed.
- e. Taking the record of received power.
- f. A dipole antenna was used in place of the EUT for pathloss calibration with a network analyzer.
- g. The gain of the dipole antenna and the insertion loss of the connected RF cable were applied into the pathloss calibration.
- h. The maximum ERP/EIRP was calculated with received power and pathloss.
- i. $ERP/EIRP = P_s + E_t - E_s + G_s = P_s + R_t - R_s + G_s$

P_s (dBm) : Input power to substitution antenna.

G_s (dBi or dBd) : Substitution antenna Gain.

$E_t = R_t + AF$

$E_s = R_s + AF$

AF (dB/m) : Receiver antenna factor

R_t : The highest received signal in spectrum analyzer for EUT.

R_s : The highest received signal in spectrum analyzer for substitution antenna.

CONDUCTED POWER MEASUREMENT:

The EUT was set up for the maximum power with GSM, GPRS, EDGE, WCDMA & CDMA link data modulation and link up with simulator. Set the EUT to transmit under low, middle and high channel and record the power level shown on simulator.

4.1.3 TEST SETUP

EIRP / ERP MEASUREMENT:

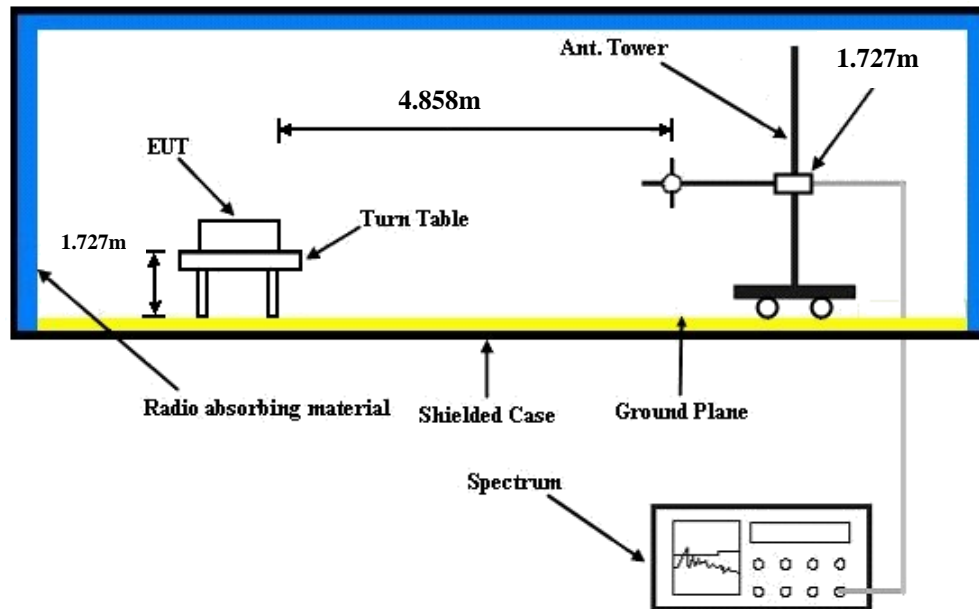

CONDUCTED POWER MEASUREMENT:

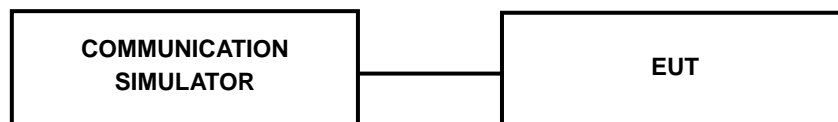

4.1.4 TEST RESULTS

CONDUCTED OUTPUT POWER (dBm)

Band	GPRS850		
	128	189	251
Channel	128	189	251
Frequency (MHz)	824.2	836.4	848.8
GSM (1 Uplink)	33.29	33.34	33.30
GPRS 8 (GMSK, 1 slot)	33.27	33.32	33.28
GPRS 10 (GMSK, 2 slot)	31.65	31.70	31.66
EDGE 8 (GMSK, 1 Uplink)	33.25	33.30	33.26
EDGE 10 (GMSK, 2 Uplink)	31.59	31.64	31.60
EDGE 8 (8PSK, 1 Uplink)	27.84	27.89	27.85
EDGE 10 (8PSK, 2 Uplink)	27.58	27.63	27.59

Band	WCDMA V		
	4132	4182	4233
Channel	4132	4182	4233
Frequency (MHz)	826.4	836.4	846.6
RMC 12.2K	23.66	23.65	23.92
HSDPA Subtest-1	23.55	23.40	23.58
HSDPA Subtest-2	23.47	23.32	23.50
HSDPA Subtest-3	22.97	22.82	23.00
HSDPA Subtest-4	23.04	22.89	23.07
HSUPA Subtest-1	23.09	22.94	23.14
HSUPA Subtest-2	22.04	21.88	22.07
HSUPA Subtest-3	21.95	21.80	21.98
HSUPA Subtest-4	22.64	22.49	22.67
HSUPA Subtest-5	23.51	23.36	23.54



A D T

LTE Band 5								
BW	Modulation	CH	Frequency	RB	RB Offset	MPR	Target	Measured
			(MHz)				Power	Power
5 MHz	QPSK	20425	826.5	1	0	0	24.2	23.85
		20525	836.5	1	0	0	24	23.36
		20625	846.5	1	0	0	24	23.48
		20425	826.5	1	12	0	24	23.91
		20525	836.5	1	12	0	24	23.42
		20625	846.5	1	12	0	24	23.54
		20425	826.5	1	24	0	24	23.24
		20525	836.5	1	24	0	24	23.05
		20625	846.5	1	24	0	24	23.07
		20425	826.5	12	0	1	24	23.12
		20525	836.5	12	0	1	24	22.43
		20625	846.5	12	0	1	24	22.55
		20425	826.5	12	6	1	24	22.89
		20525	836.5	12	6	1	24	22.4
		20625	846.5	12	6	1	24	22.52
	20425	826.5	12	13	1	24	22.51	
	20525	836.5	12	13	1	24	22.02	
	20625	846.5	12	13	1	24	22.14	
	20425	826.5	25	0	1	24	22.66	
	20525	836.5	25	0	1	24	22.17	
	20625	846.5	25	0	1	24	22.29	
	20425	826.5	1	0	1	24	22.74	
	20525	836.5	1	0	1	24	22.25	
	20625	846.5	1	0	1	24	22.37	
	20425	826.5	1	12	1	24	22.92	
	20525	836.5	1	12	1	24	22.43	
	20625	846.5	1	12	1	24	22.55	
	20425	826.5	1	24	1	24	22.15	
	20525	836.5	1	24	1	24	22.06	
	20625	846.5	1	24	1	24	22.08	
20425	826.5	12	0	2	24	21.85		
20525	836.5	12	0	2	24	21.36		
20625	846.5	12	0	2	24	21.48		
20425	826.5	12	6	2	24	21.75		
20525	836.5	12	6	2	24	21.26		
20625	846.5	12	6	2	24	21.38		
20425	826.5	12	13	2	24	21.5		
20525	836.5	12	13	2	24	21.01		
20625	846.5	12	13	2	24	21.13		
20425	826.5	25	0	2	24	21.63		
20525	836.5	25	0	2	24	21.14		
20625	846.5	25	0	2	24	21.26		



A D T

LTE Band 5									
BW	Modulation	CH	Frequency	RB	RB Offset	MPR	Target	Measured	
			(MHz)				Power	Power	
10MHz	QPSK	20450	829	1	0	0	24	23.65	
		20525	836.5	1	0	0	24	23.02	
		20600	844	1	0	0	24	23.8	
		20450	829	1	24	0	24	23.85	
		20525	836.5	1	24	0	24	23.07	
		20600	844	1	24	0	24	24	
		20450	829	1	49	0	24	23.53	
		20525	836.5	1	49	0	24	23.01	
		20600	844	1	49	0	24	23.68	
		20450	829	25	0	1	24	22.66	
		20525	836.5	25	0	1	24	22.14	
		20600	844	25	0	1	24	22.81	
		20450	829	25	12	1	24	22.76	
		20525	836.5	25	12	1	24	22.1	
		20600	844	25	12	1	24	22.91	
	20450	829	25	25	1	24	22.62		
	20525	836.5	25	25	1	24	22.01		
	20600	844	25	25	1	24	22.77		
	20450	829	50	0	1	24	22.64		
	20525	836.5	50	0	1	24	22.01		
	20600	844	50	0	1	24	22.79		
	20450	16QAM	20450	829	1	0	1	24	22.66
	20525		836.5	1	0	1	24	22.18	
	20600		844	1	0	1	24	22.81	
	20450		829	1	24	1	24	22.92	
	20525		836.5	1	24	1	24	22.14	
	20600		844	1	24	1	24	23.07	
	20450		829	1	49	1	24	22.56	
	20525		836.5	1	49	1	24	22.08	
	20600		844	1	49	1	24	22.71	
20450	829		25	0	2	24	21.89		
20525	836.5		25	0	2	24	21.11		
20600	844		25	0	2	24	22.04		
20450	829		25	12	2	24	21.91		
20525	836.5		25	12	2	24	21.13		
20600	844		25	12	2	24	22.06		
20450	829	25	25	2	24	21.87			
20525	836.5	25	25	2	24	21.09			
20600	844	25	25	2	24	22.02			
20450	829	50	0	2	24	21.8			
20525	836.5	50	0	2	24	21.02			
20600	844	50	0	2	24	21.95			



A D T

ERP POWER (dBm)

TEST MODE A

GSM

GSM Radiated Power ERP						
Horizontal Polarization						
Frequency (MHz)	Rt (dBm)	Rs (dBm)	Ps (dBm)	Gs (dBd)	ERP (dBm)	ERP (mW)
824.20	-17.92	-48.12	0.00	-1.08	29.12	816.58
836.40	-18.11	-48.28	0.00	-0.93	29.24	839.46
848.80	-18.76	-48.35	0.00	-0.76	28.83	763.84
Vertical Polarization						
Frequency (MHz)	Rt (dBm)	Rs (dBm)	Ps (dBm)	Gs (dBd)	ERP (dBm)	ERP (mW)
824.20	-35.08	-47.97	0.00	-1.08	11.81	15.17
836.40	-35.37	-48.01	0.00	-0.93	11.71	14.83
848.80	-36.14	-48.05	0.00	-0.76	11.15	13.03

EDGE

EDGE Radiated Power ERP						
Horizontal Polarization						
Frequency (MHz)	Rt (dBm)	Rs (dBm)	Ps (dBm)	Gs (dBd)	ERP (dBm)	ERP (mW)
824.20	-24.64	-48.12	0.00	-1.08	22.40	173.78
836.40	-24.83	-48.28	0.00	-0.93	22.52	178.65
848.80	-24.37	-48.35	0.00	-0.76	23.22	209.89
Vertical Polarization						
Frequency (MHz)	Rt (dBm)	Rs (dBm)	Ps (dBm)	Gs (dBd)	ERP (dBm)	ERP (mW)
824.20	-41.64	-47.97	0.00	-1.08	5.25	3.35
836.40	-41.76	-48.01	0.00	-0.93	5.32	3.40
848.80	-41.96	-48.05	0.00	-0.76	5.33	3.41

WCDMA (RMC 12.2K)

EDGE Radiated Power ERP						
Horizontal Polarization						
Frequency (MHz)	Rt (dBm)	Rs (dBm)	Ps (dBm)	Gs (dBd)	ERP (dBm)	ERP (mW)
826.40	-26.82	-48.12	0.00	-1.08	20.22	105.20
836.40	-28.17	-48.28	0.00	-0.93	19.18	82.79
846.60	-27.64	-48.35	0.00	-0.76	19.95	98.86
Vertical Polarization						
Frequency (MHz)	Rt (dBm)	Rs (dBm)	Ps (dBm)	Gs (dBd)	ERP (dBm)	ERP (mW)
826.40	-43.77	-47.97	0.00	-1.08	3.12	2.05
836.40	-45.26	-48.01	0.00	-0.93	1.82	1.52
846.60	-44.70	-48.05	0.00	-0.76	2.59	1.82

LTE BAND 5

CHANNEL BANDWIDTH: 5MHz QPSK

EDGE Radiated Power ERP						
Horizontal Polarization						
Frequency (MHz)	Rt (dBm)	Rs (dBm)	Ps (dBm)	Gs (dBd)	ERP (dBm)	ERP (mW)
826.5	-26.05	-48.12	0.00	-1.08	20.99	125.60
836.5	-28.13	-48.28	0.00	-0.93	19.22	83.56
846.5	-27.22	-48.35	0.00	-0.76	20.37	108.89
Vertical Polarization						
Frequency (MHz)	Rt (dBm)	Rs (dBm)	Ps (dBm)	Gs (dBd)	ERP (dBm)	ERP (mW)
826.5	-43.17	-47.97	0.00	-1.08	3.72	2.36
836.5	-44.40	-48.01	0.00	-0.93	2.68	1.85
846.5	-42.60	-48.05	0.00	-0.76	4.69	2.94

CHANNEL BANDWIDTH: 10MHz QPSK

EDGE Radiated Power ERP						
Horizontal Polarization						
Frequency (MHz)	Rt (dBm)	Rs (dBm)	Ps (dBm)	Gs (dBd)	ERP (dBm)	ERP (mW)
829	-26.43	-48.12	0.00	-1.08	20.61	115.08
836.5	-28.24	-48.28	0.00	-0.93	19.11	81.47
844	-27.04	-48.35	0.00	-0.76	20.55	113.50
Vertical Polarization						
Frequency (MHz)	Rt (dBm)	Rs (dBm)	Ps (dBm)	Gs (dBd)	ERP (dBm)	ERP (mW)
829	-43.64	-47.97	0.00	-1.08	3.25	2.11
836.5	-44.62	-48.01	0.00	-0.93	2.46	1.76
844	-42.83	-48.05	0.00	-0.76	4.46	2.79



A D T

TEST MODE B

GSM

GSM Radiated Power ERP						
Horizontal Polarization						
Frequency (MHz)	Rt (dBm)	Rs (dBm)	Ps (dBm)	Gs (dBd)	ERP (dBm)	ERP (mW)
824.20	-18.74	-48.12	0.00	-1.08	28.30	676.08
836.40	-19.00	-48.28	0.00	-0.93	28.35	683.91
848.80	-19.50	-48.35	0.00	-0.76	28.09	644.17
Vertical Polarization						
Frequency (MHz)	Rt (dBm)	Rs (dBm)	Ps (dBm)	Gs (dBd)	ERP (dBm)	ERP (mW)
824.20	-34.91	-47.97	0.00	-1.08	11.98	15.78
836.40	-34.85	-48.01	0.00	-0.93	12.23	16.71
848.80	-34.67	-48.05	0.00	-0.76	12.62	18.28

EDGE

EDGE Radiated Power ERP						
Horizontal Polarization						
Frequency (MHz)	Rt (dBm)	Rs (dBm)	Ps (dBm)	Gs (dBd)	ERP (dBm)	ERP (mW)
824.20	-23.04	-48.12	0.00	-1.08	24.00	251.19
836.40	-23.37	-48.28	0.00	-0.93	23.98	250.03
848.80	-23.54	-48.35	0.00	-0.76	24.05	254.10
Vertical Polarization						
Frequency (MHz)	Rt (dBm)	Rs (dBm)	Ps (dBm)	Gs (dBd)	ERP (dBm)	ERP (mW)
824.20	-39.22	-47.97	0.00	-1.08	7.67	5.85
836.40	-39.31	-48.01	0.00	-0.93	7.77	5.98
848.80	-38.80	-48.05	0.00	-0.76	8.49	7.06



A D T

WCDMA (RMC 12.2K)

EDGE Radiated Power ERP						
Horizontal Polarization						
Frequency (MHz)	Rt (dBm)	Rs (dBm)	Ps (dBm)	Gs (dBd)	ERP (dBm)	ERP (mW)
826.40	-26.86	-48.12	0.00	-1.08	20.18	104.23
836.40	-27.89	-48.28	0.00	-0.93	19.46	88.31
846.60	-27.48	-48.35	0.00	-0.76	20.11	102.57
Vertical Polarization						
Frequency (MHz)	Rt (dBm)	Rs (dBm)	Ps (dBm)	Gs (dBd)	ERP (dBm)	ERP (mW)
826.40	-43.36	-47.97	0.00	-1.08	3.53	2.25
836.40	-43.88	-48.01	0.00	-0.93	3.20	2.09
846.60	-42.99	-48.05	0.00	-0.76	4.30	2.69

LTE BAND 5

CHANNEL BANDWIDTH: 5MHz QPSK

EDGE Radiated Power ERP						
Horizontal Polarization						
Frequency (MHz)	Rt (dBm)	Rs (dBm)	Ps (dBm)	Gs (dBd)	ERP (dBm)	ERP (mW)
826.5	-26.27	-48.12	0.00	-1.08	20.77	119.40
836.5	-27.85	-48.28	0.00	-0.93	19.50	89.13
846.5	-26.83	-48.35	0.00	-0.76	20.76	119.12
Vertical Polarization						
Frequency (MHz)	Rt (dBm)	Rs (dBm)	Ps (dBm)	Gs (dBd)	ERP (dBm)	ERP (mW)
826.5	-42.56	-47.97	0.00	-1.08	4.33	2.71
836.5	-43.76	-48.01	0.00	-0.93	3.32	2.15
846.5	-43.25	-48.05	0.00	-0.76	4.04	2.54

CHANNEL BANDWIDTH: 10MHz QPSK

EDGE Radiated Power ERP						
Horizontal Polarization						
Frequency (MHz)	Rt (dBm)	Rs (dBm)	Ps (dBm)	Gs (dBd)	ERP (dBm)	ERP (mW)
829	-26.11	-48.12	0.00	-1.08	20.93	123.88
836.5	-28.11	-48.28	0.00	-0.93	19.24	83.95
844	-27.25	-48.35	0.00	-0.76	20.34	108.14
Vertical Polarization						
Frequency (MHz)	Rt (dBm)	Rs (dBm)	Ps (dBm)	Gs (dBd)	ERP (dBm)	ERP (mW)
829	-42.60	-47.97	0.00	-1.08	4.29	2.69
836.5	-44.00	-48.01	0.00	-0.93	3.08	2.03
844	-43.02	-48.05	0.00	-0.76	4.27	2.67

4.2 FREQUENCY STABILITY MEASUREMENT

4.2.1 LIMITS OF FREQUENCY STABILITY MEASUREMENT

1.5 ppm is for base and fixed station. 2.5 ppm is for mobile station.

4.2.2 TEST PROCEDURE

- Device is placed at the oven room. The oven room could control the temperatures and humidity. Power warm up is at least 15 min and power applied should perform before recording frequency error.
- EUT is connected the external power supply to control the DC input power. The test voltage range is from minimum to maximum working voltage. Each step shall be record the frequency error rate.
- The temperature range step is 10 degrees in this test items. All temperature levels shall be hold the $\pm 0.5^{\circ}\text{C}$ during the measurement testing. The each temperature step shall be at least 0.5 hours, consider the EUT could be test under the stability condition.

NOTE: The frequency error was recorded frequency error from the communication simulator.

4.2.3 TEST SETUP

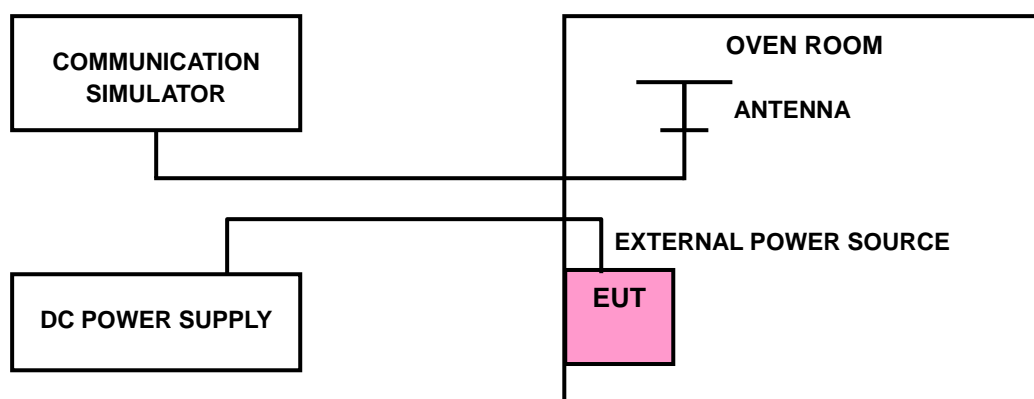

4.2.4 TEST RESULTS

FREQUENCY ERROR vs. VOLTAGE

VOLTAGE (Volts)	FREQUENCY ERROR (ppm)					LIMIT (ppm)
	GPRS	EDGE	WCDMA	LTE Band 5		
				5MHz	10MHz	
3.8	-0.013	0.009	-0.002	0.005	-0.003	2.5
3.6	-0.015	0.007	-0.002	0.006	-0.003	2.5
4.35	-0.013	0.008	-0.002	0.003	0.001	2.5

NOTE: The applicant defined the normal working voltage of the battery is from 3.6Vdc to 4.35Vdc.

FREQUENCY ERROR vs. TEMPERATURE.

TEMP. (°C)	FREQUENCY ERROR (ppm)					LIMIT (ppm)
	GPRS	EDGE	WCDMA	LTE Band 5		
				5MHz	10MHz	
-30	-0.006	-0.006	-0.002	-0.0019	-0.0008	2.5
-20	-0.007	0.005	-0.002	-0.0041	-0.0010	2.5
-10	-0.005	0.007	-0.002	-0.0007	-0.0016	2.5
0	-0.007	0.009	-0.002	-0.0048	0.0032	2.5
10	-0.007	0.008	-0.002	-0.0053	-0.0002	2.5
20	-0.009	0.009	-0.002	0.0038	-0.0023	2.5
30	-0.009	0.010	-0.002	-0.0045	0.0026	2.5
40	-0.009	0.010	-0.002	-0.0005	0.0010	2.5
50	-0.008	0.007	-0.002	0.0056	-0.0041	2.5
55	-0.009	0.007	-0.001	0.0035	-0.0017	2.5

4.3 OCCUPIED BANDWIDTH MEASUREMENT

4.3.1 TEST PROCEDURES

The EUT makes a call to the communication simulator. All measurements were done at low, middle and high operational frequency range. The communication simulator station system controlled a EUT to export maximum output power under transmission mode and specific channel frequency. Use OBW measurement function of Spectrum analyzer to measure 99 % occupied bandwidth.

4.3.2 TEST SETUP

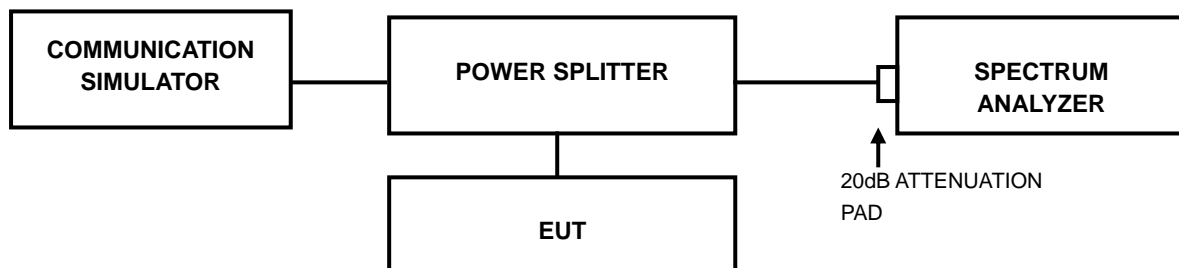



A D T

4.3.3 TEST RESULTS

CHANNEL	FREQUENCY (MHz)	99% OCCUPIED BANDWIDTH (kHz)		CHANNEL	FREQUENCY (MHz)	99% OCCUPIED BANDWIDTH (MHz)
		GPRS	EDGE			WCDMA
128	824.2	249.30	244.68	4132	826.4	4.1759
189	836.4	245.75	243.69	4182	836.4	4.1830
251	848.8	246.33	244.83	4233	846.6	4.1775

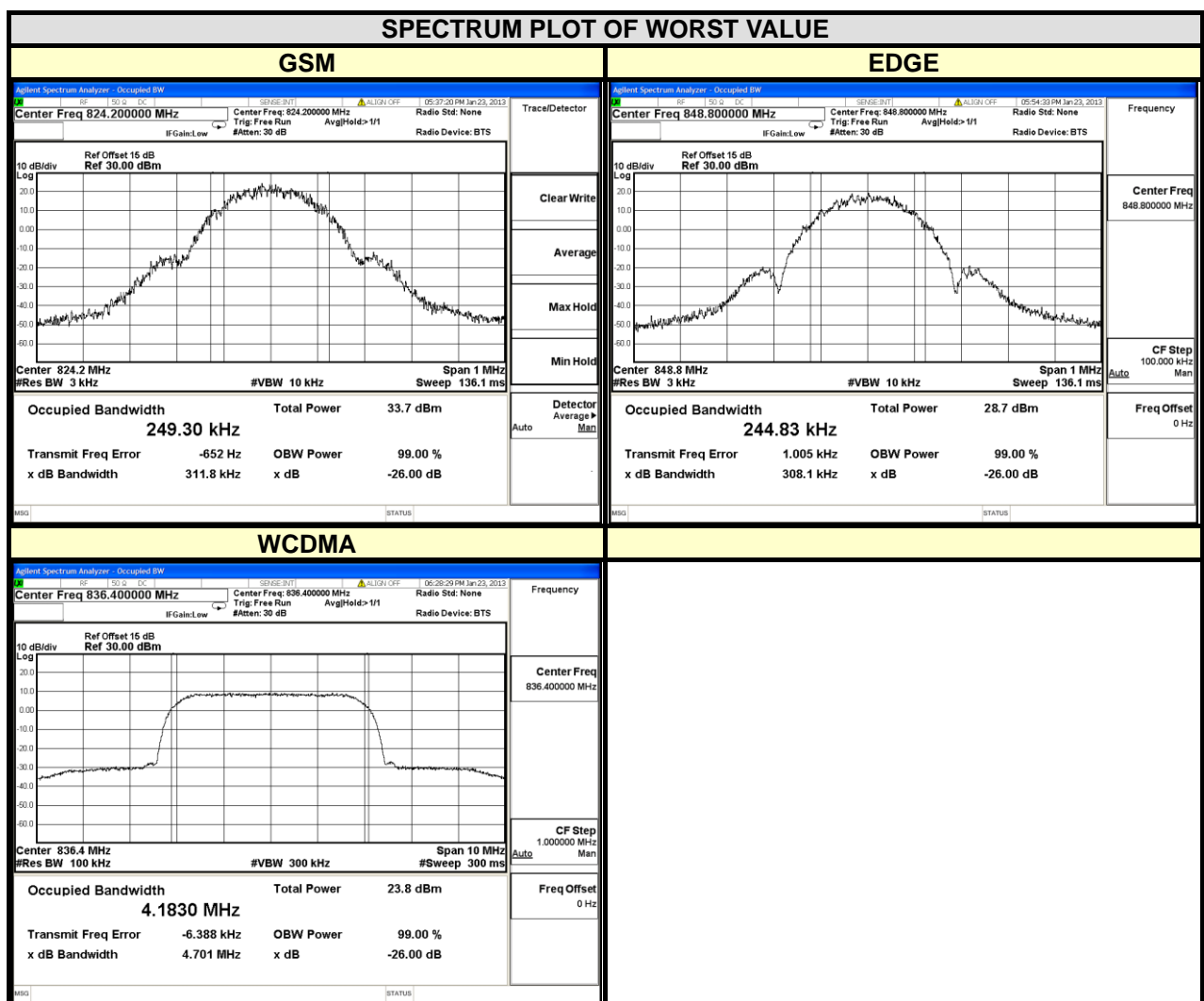



LTE BAND 5							
CHANNEL BANDWIDTH: 5MHz				CHANNEL BANDWIDTH: 10MHz			
CHANNEL	FREQUENCY (MHz)	99% OCCUPIED BANDWIDTH (MHz)		CHANNEL	FREQUENCY (MHz)	99% OCCUPIED BANDWIDTH (MHz)	
		QPSK	16QAM			QPSK	16QAM
20425	826.5	4.4721	4.4714	20450	829	8.9075	8.9208
20525	836.5	4.4742	4.4673	20525	836.5	8.9047	8.8935
20625	846.5	4.4762	4.4689	20600	844	8.9072	8.9012

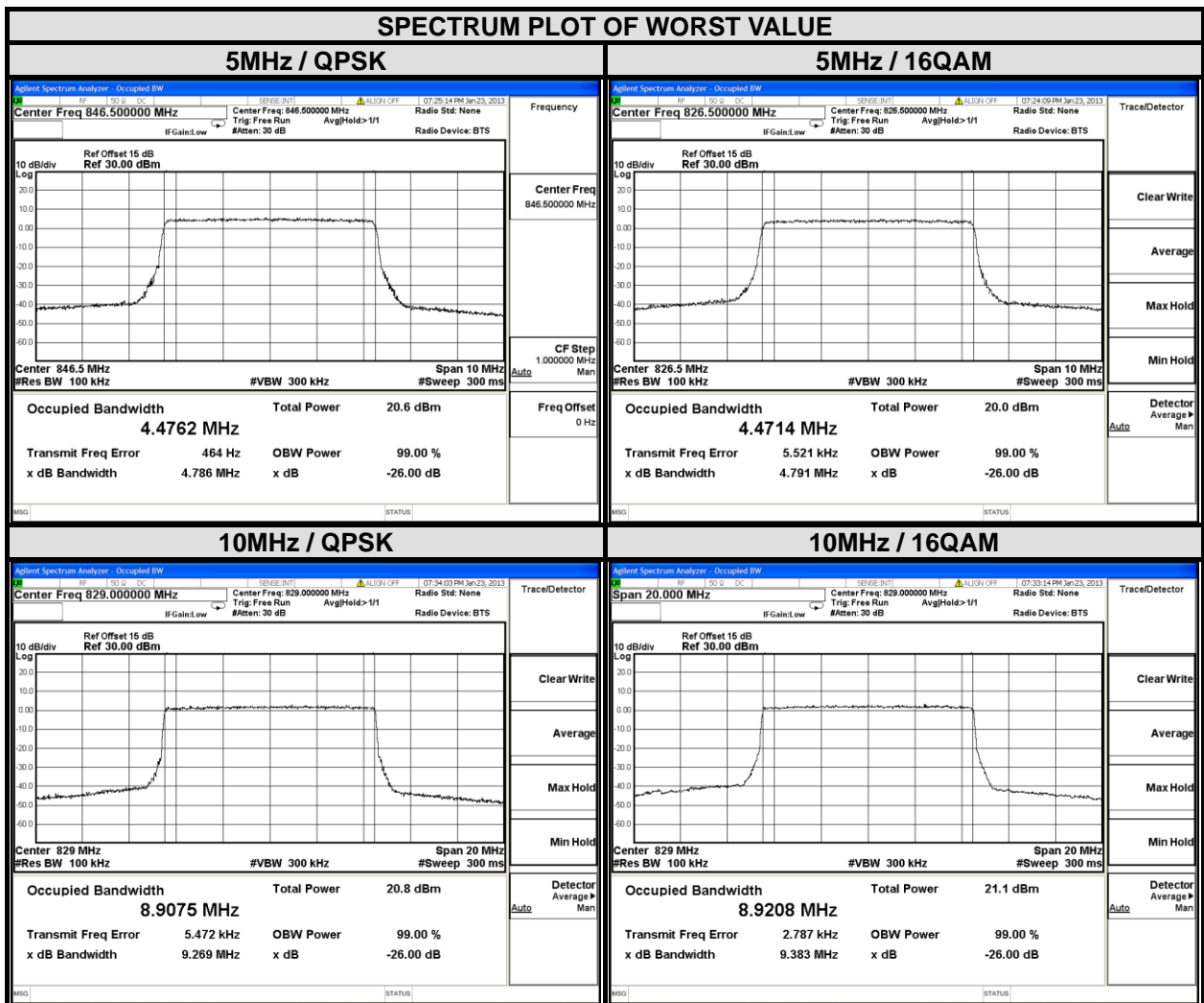

4.4 BAND EDGE MEASUREMENT

4.4.1 LIMITS OF BAND EDGE MEASUREMENT

Power of any emission outside of the authorized operating frequency ranges must be attenuated below the transmitting power (P) by a factor of at least $43 + 10 \log(P)$ dB. In the 1 MHz bands immediately outside and adjacent to the frequency block a resolution bandwidth of at least one percent of the emission bandwidth of the fundamental emission of the transmitter may be employed.

4.4.2 TEST SETUP

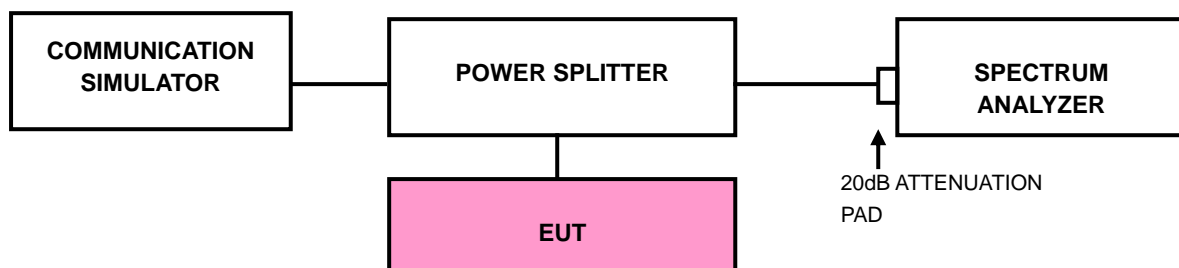

4.4.3 TEST PROCEDURES

- All measurements were done at low and high operational frequency range.
- The center frequency of spectrum is the band edge frequency and span is 1MHz. RB of the spectrum is 3kHz and VB of the spectrum is 10kHz (GSM/GPRS/ EDGE).
- The center frequency of spectrum is the band edge frequency and span is 5MHz. RB of the spectrum is 100kHz and VB of the spectrum is 300kHz (WCDMA/LTE).
- Record the max trace plot into the test report.



A D T

4.4.4 TEST RESULTS

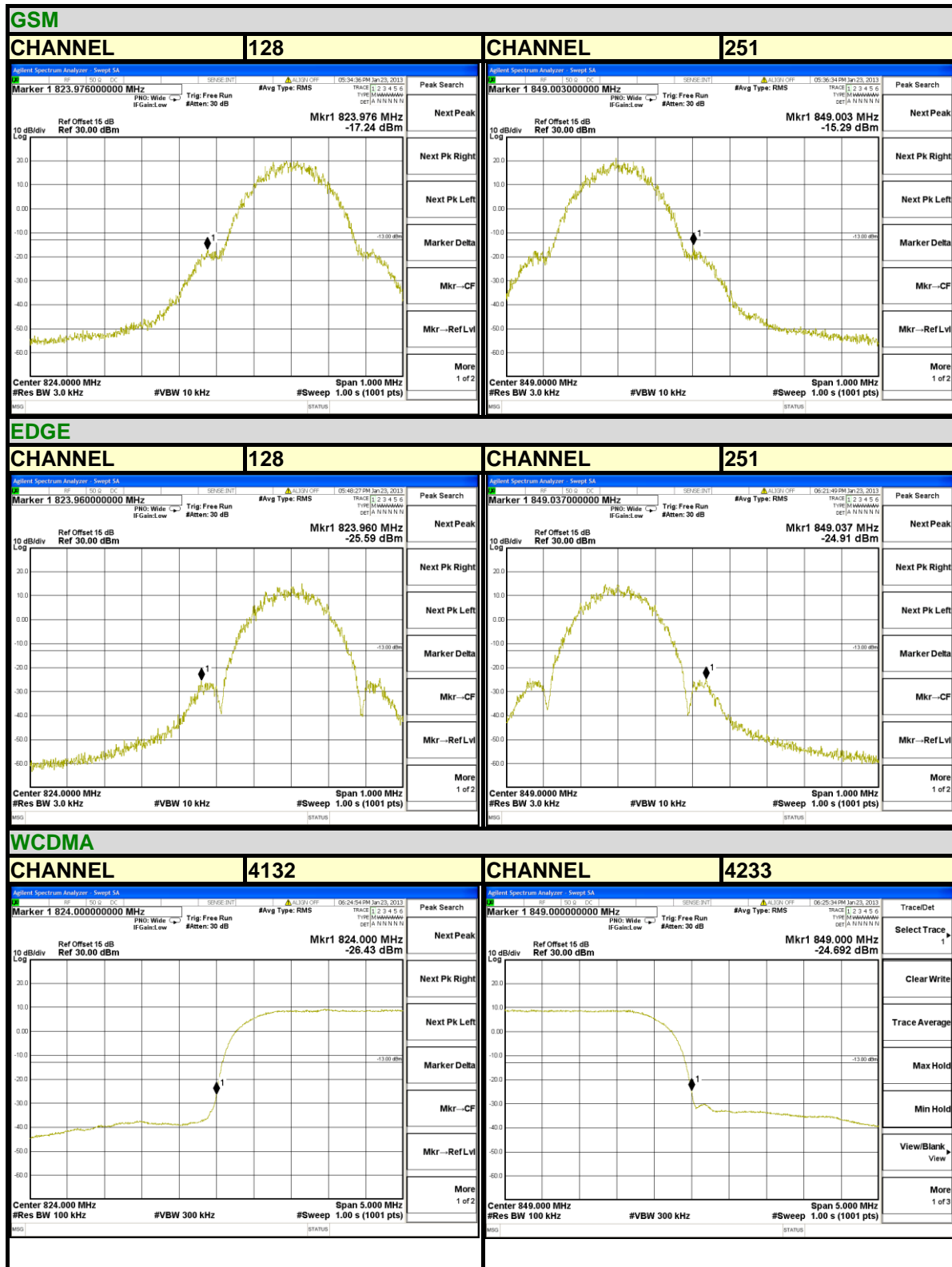



A D T

LTE Band 5 Channel Bandwidth: 5MHz

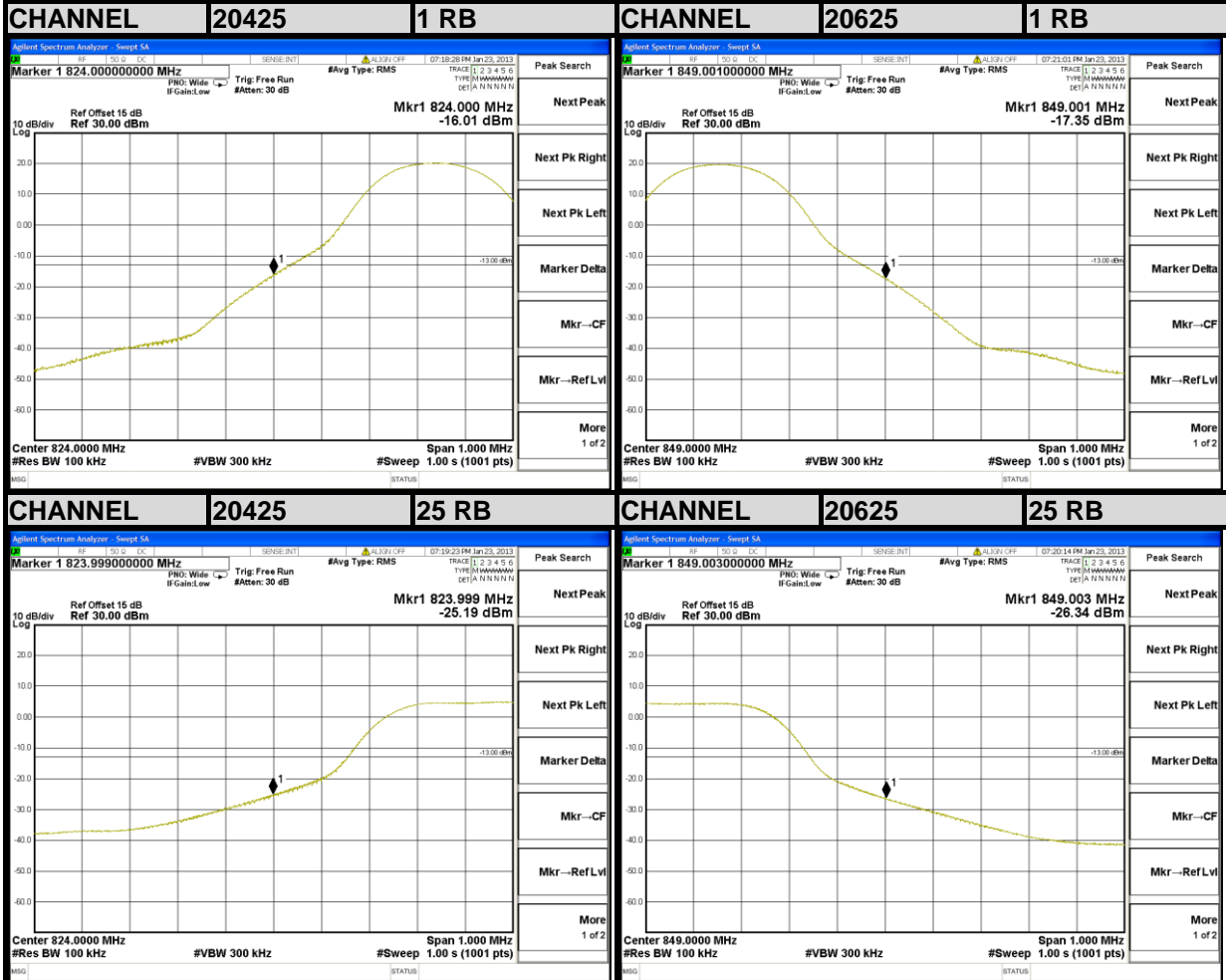



A D T

LTE Band 5 Channel Bandwidth: 10MHz

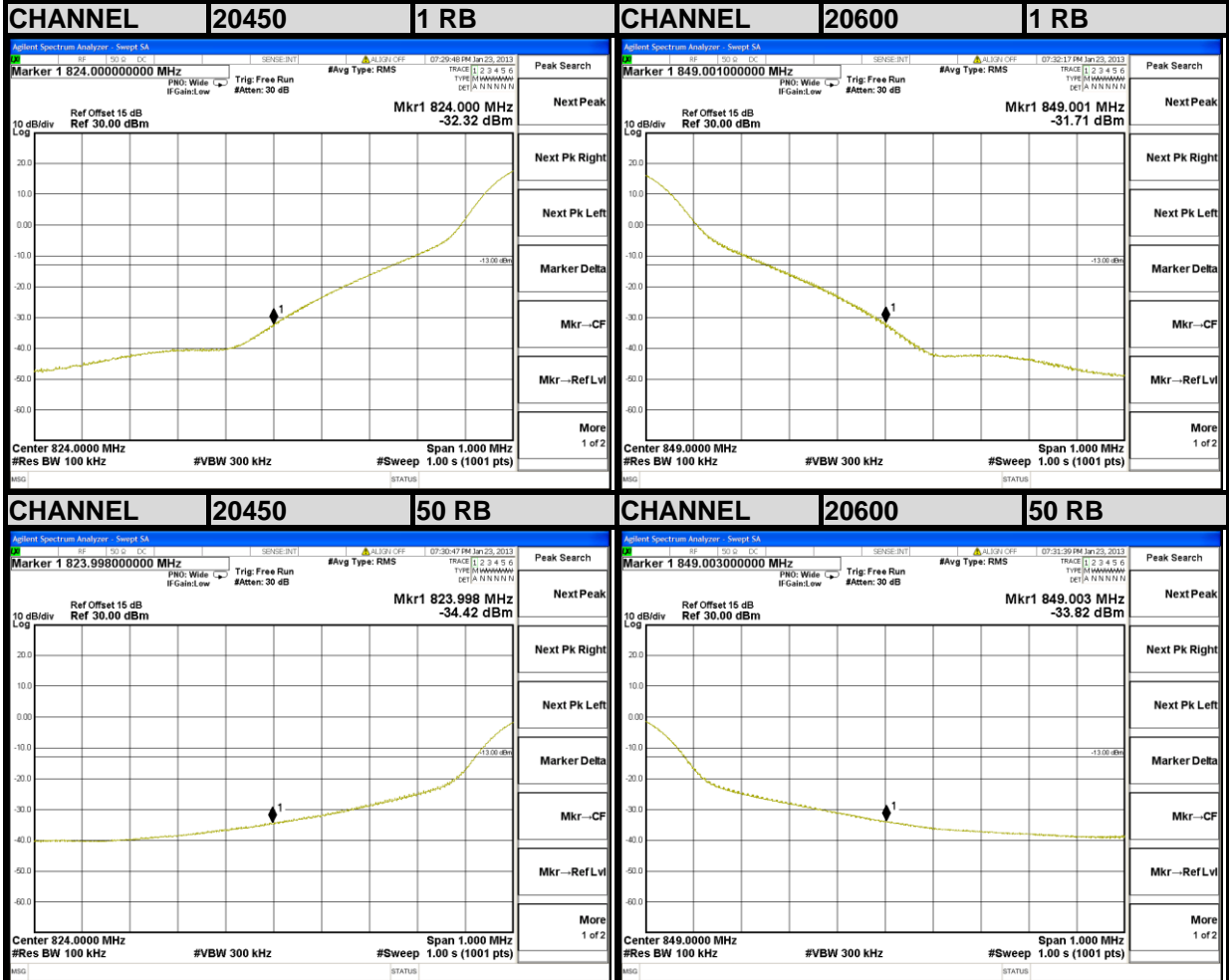

4.5 CONDUCTED SPURIOUS EMISSIONS

4.5.1 LIMITS OF CONDUCTED SPURIOUS EMISSIONS MEASUREMENT

The power of any emission outside of the authorized operating frequency ranges must be attenuated below the transmitting power (P) by a factor of at least $43 + 10 \log(P)$ dB. The emission limit equal to -13dBm .

4.5.2 TEST PROCEDURE

- The EUT makes a phone call to the communication simulator. All measurements were done at low, middle and high operational frequency range.
- Measuring frequency range is from 30 MHz to 9GHz. 10dB attenuation pad is connected with spectrum. RBW=1MHz and VBW=3MHz is used for conducted emission measurement.

4.5.3 TEST SETUP

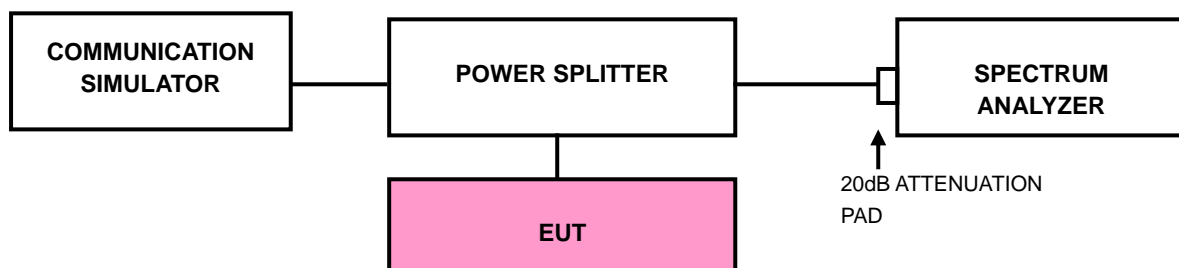



A D T

4.5.4 TEST RESULTS

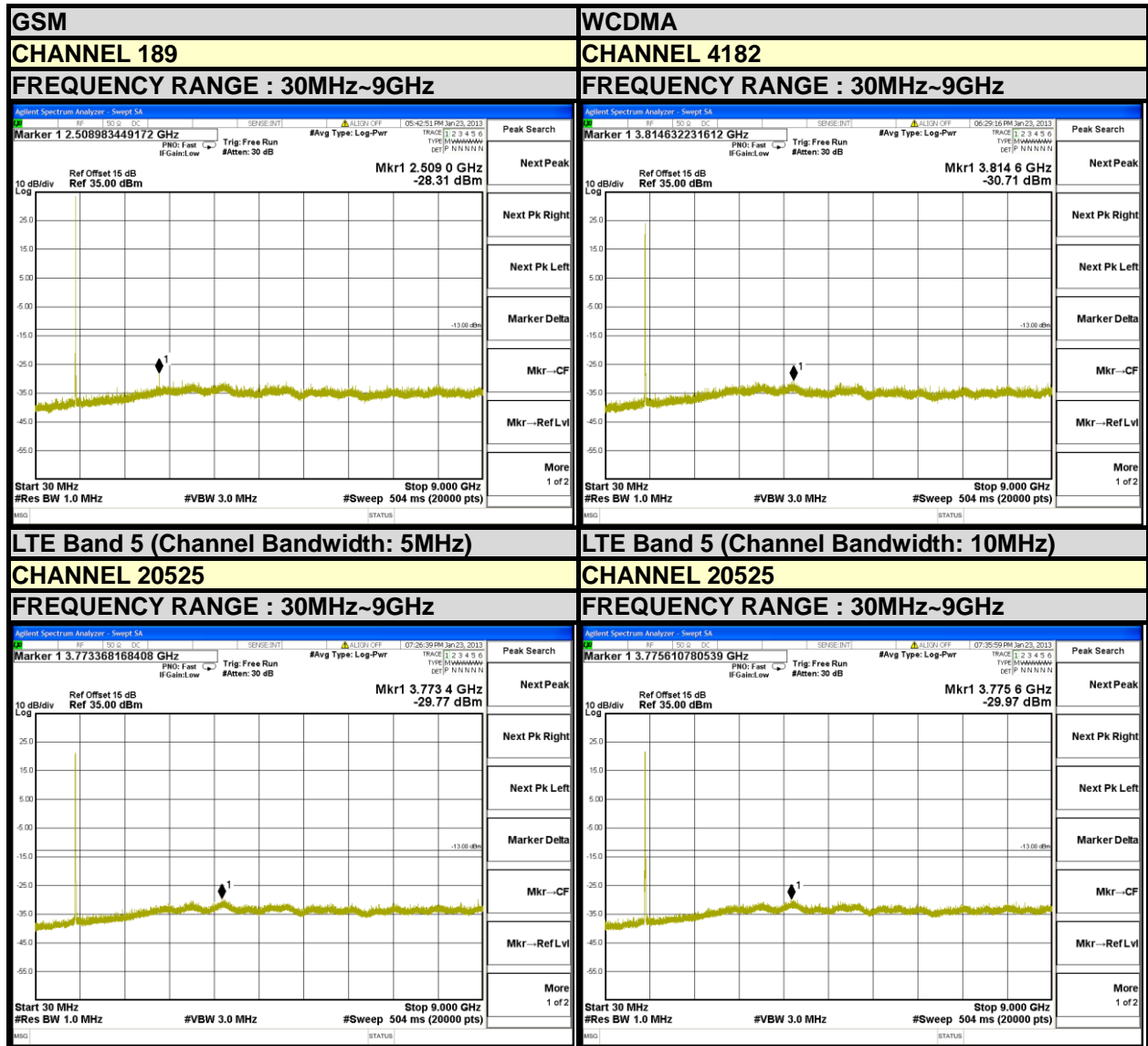

4.6 RADIATED EMISSION MEASUREMENT

4.6.1 LIMITS OF RADIATED EMISSION MEASUREMENT

The power of any emission outside of the authorized operating frequency ranges must be attenuated below the transmitting power (P) by a factor of at least $43 + 10 \log(P)$ dB. The emission limit equal to -13dBm .

4.6.2 TEST PROCEDURES

- a. Substitution method is used for E.I.R.P measurement. In the semi-anechoic chamber, EUT placed on the 0.8m height of Turn Table, rotated the table around 360 degrees to search the maximum radiation power and receiver antenna shall be rotated vertical and horizontal polarization and moved height from 1m to 4m to find the maximum polar radiated power. The “Read Value” is the spectrum reading the maximum power value.
- b. The substitution horn antenna is substituted for EUT at the same position and signals generator export the CW signal to the substitution antenna via a TX cable. Rotated the Turn Table and moved receiving antenna to find the maximum radiation power. Adjust output power level of S.G to get a Value of spectrum reading equal to “Read Value” of step a. Record the power level of S.G
- c. $\text{EIRP} = \text{Output power level of S.G} - \text{TX cable loss} + \text{Antenna gain of substitution horn}$.
- d. E.R.P power can be calculated form E.I.R.P power by subtracting the gain of dipole,
 $\text{E.R.P power} = \text{E.I.R.P power} - 2.15\text{dBi}$.

NOTE: The resolution bandwidth and video bandwidth of test receiver/spectrum analyzer is 1MHz/3MHz.

4.6.3 DEVIATION FROM TEST STANDARD

No deviation

4.6.4 TEST SETUP

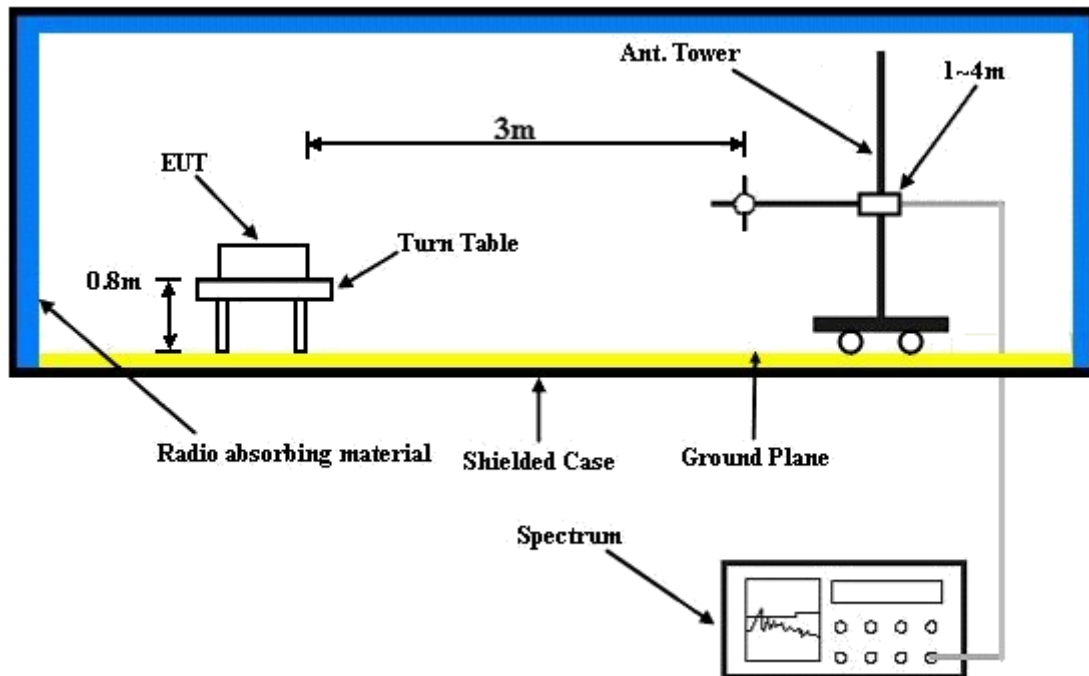

For the actual test configuration, please refer to the attached file (Test Setup Photo).

4.6.5 TEST RESULTS

TEST MODE A

GSM:



Bureau Veritas Consumer Products Services Ltd., Taoyuan Branch

A D T

Data: 9

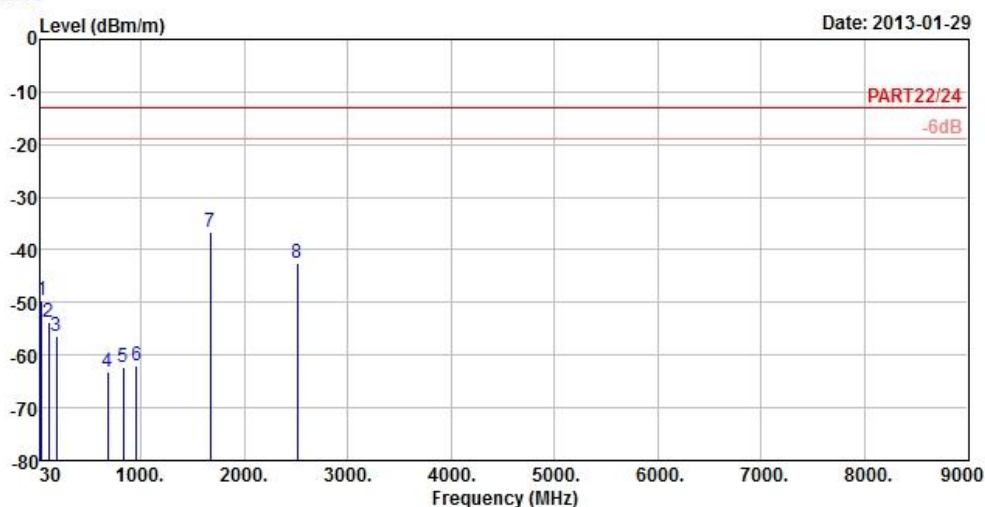

Site : 966 Chamber 5
 Condition : PART22/24 3m HORIZONTAL
 Brand/Model: 121225C13
 Remark : GSM850 Link
 Tested by : Kay Wu
 Temperature : 25°C
 Humidity : 65%
 Plane : Y

	Read	Limit	Over			
Freq	Level	Level	Line	Limit	Factor	Remark
MHz	dBm/m	dBm	dBm/m	dB	dB/m	
1	43.50	-49.46	-48.20	-13.00	-36.46	-1.26 Peak
2	106.68	-53.83	-43.28	-13.00	-40.83	-10.55 Peak
3	179.04	-56.42	-50.56	-13.00	-43.42	-5.86 Peak
4	680.80	-63.32	-64.42	-13.00	-50.32	1.10 Peak
5	825.70	-62.42	-64.69	-13.00	-49.42	2.27 Peak
6	953.10	-61.89	-65.64	-13.00	-48.89	3.75 Peak
7 pp	1672.80	-36.53	-23.71	-13.00	-23.53	-12.82 Peak
8	2509.20	-42.48	-33.31	-13.00	-29.48	-9.17 Peak



A D T



Bureau Veritas Consumer Products Services Ltd., Taoyuan Branch

A D T

Data: 10

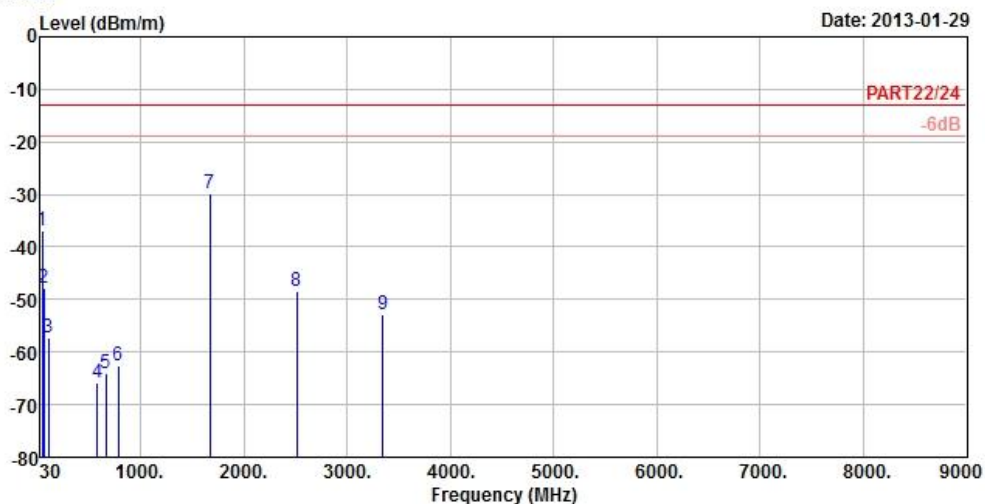

Site : 966 Chamber 5
 Condition : PART22/24 3m VERTICAL
 Brand/Model: 121225C13
 Remark : GSM850 Link
 Tested by : Kay Wu
 Temperature : 25°C
 Humidity : 65%
 Plane : Y

	Freq	Level	Read Level	Limit Line	Over Limit	Factor	Remark
	MHz	dBm/m	dBm	dBm/m	dB	dB/m	
1	44.58	-36.92	-35.73	-13.00	-23.92	-1.19	Peak
2	64.29	-47.84	-40.44	-13.00	-34.84	-7.40	Peak
3	106.68	-57.31	-46.76	-13.00	-44.31	-10.55	Peak
4	580.00	-65.91	-65.00	-13.00	-52.91	-0.91	Peak
5	662.60	-63.96	-64.73	-13.00	-50.96	0.77	Peak
6	784.40	-62.65	-64.67	-13.00	-49.65	2.02	Peak
7 pp	1672.80	-29.73	-16.91	-13.00	-16.73	-12.82	Peak
8	2509.20	-48.29	-39.12	-13.00	-35.29	-9.17	Peak
9	3345.60	-52.71	-44.90	-13.00	-39.71	-7.81	Peak

EDGE:



Bureau Veritas Consumer Products Services Ltd., Taoyuan Branch

A D T

Data: 5

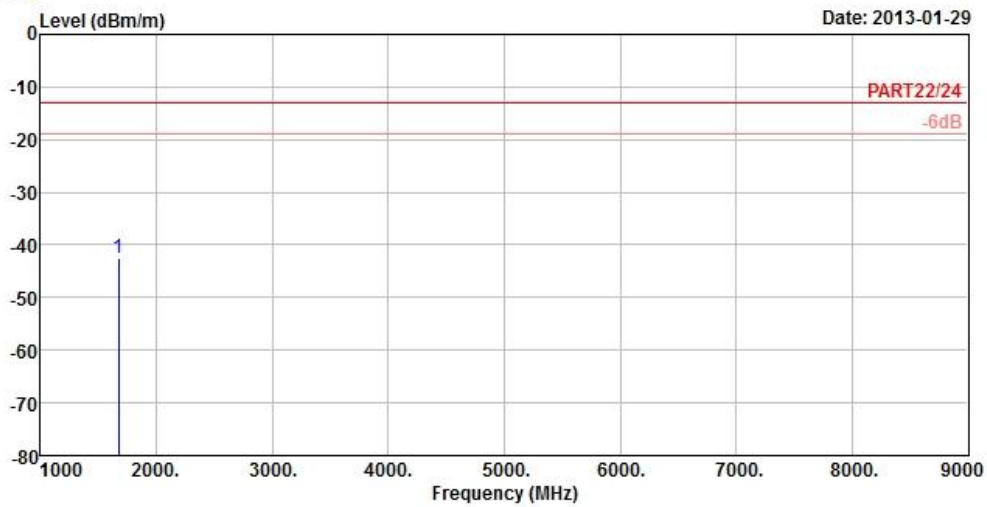

Site : 966 Chamber 5
 Condition : PART22/24 3m HORIZONTAL
 Brand/Model: 121225C13
 Remark : EDGE Link
 Tested by : Kay Wu
 Temperature : 25°C
 Humidity : 65%
 Plane : Y

Freq	Level	Read Level	Limit Line	Over Limit	Factor	Remark
MHz	dBm/m	dBm	dBm/m	dB	dB/m	
1 pp 1672.80	-42.62	-29.80	-13.00	-29.62	-12.82	Peak



A D T



Bureau Veritas Consumer Products Services Ltd., Taoyuan Branch

A D T

Data: 6

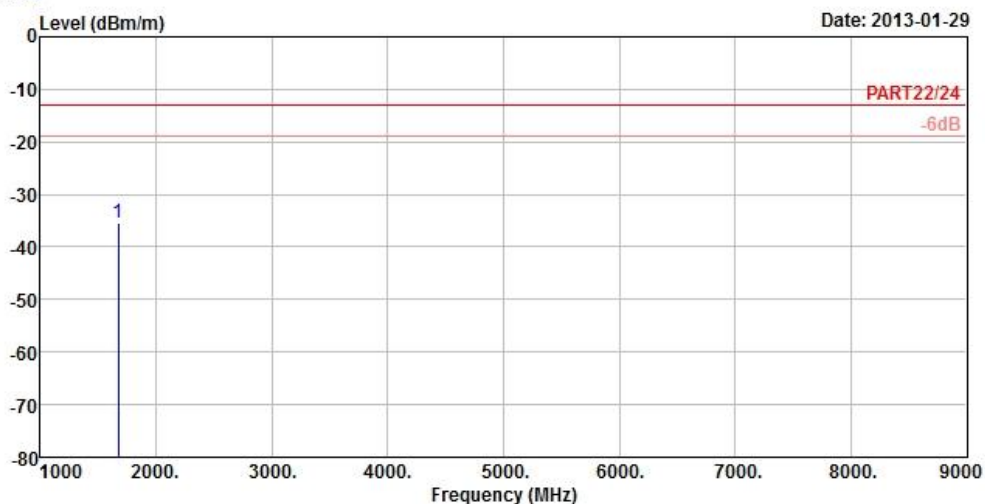

Site : 966 Chamber 5
 Condition : PART22/24 3m VERTICAL
 Brand/Model: 121225C13
 Remark : EDGE Link
 Tested by : Kay Wu
 Temperature : 25°C
 Humidity : 65%
 Plane : Y

Freq	Level	Read Level	Limit Line	Over Limit	Factor	Remark
MHz	dBm/m	dBm	dBm/m	dB	dB/m	
1 pp 1672.80	-35.34	-22.52	-13.00	-22.34	-12.82	Peak

WCDMA:



Bureau Veritas Consumer Products Services Ltd., Taoyuan Branch

A D T

Data: 5

Date: 2013-01-29

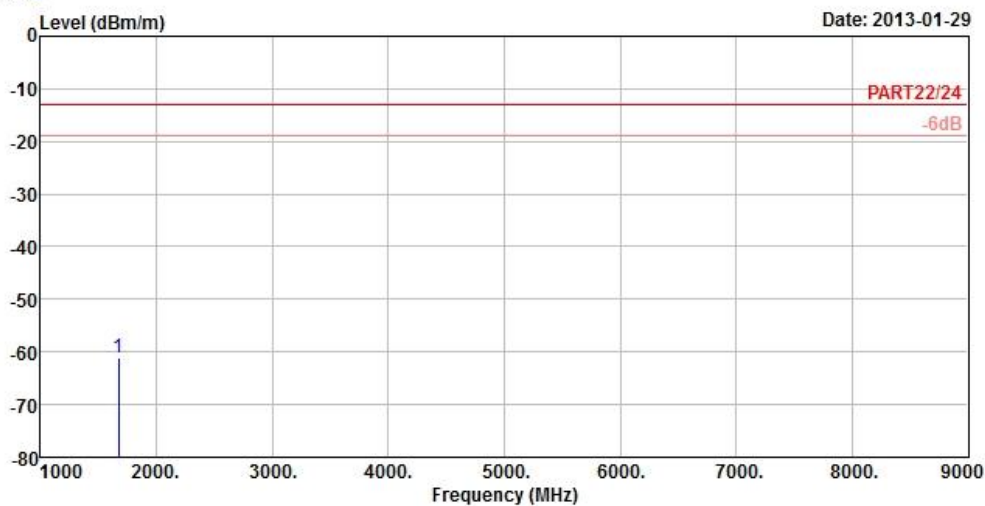

Site : 966 Chamber 5
 Condition : PART22/24 3m HORIZONTAL
 Brand/Model: 121225C13
 Remark : Band V Link
 Tested by : Kay Wu
 Temperature : 25°C
 Humidity : 65%
 Plane : Y

Freq	Level	Read Level	Limit Line	Over Limit	Factor	Remark
MHz	dBm/m	dBm	dBm/m	dB	dB/m	
1 pp 1672.80	-61.09	-48.27	-13.00	-48.09	-12.82	Peak



A D T



Bureau Veritas Consumer Products Services Ltd., Taoyuan Branch

A D T

Data: 6

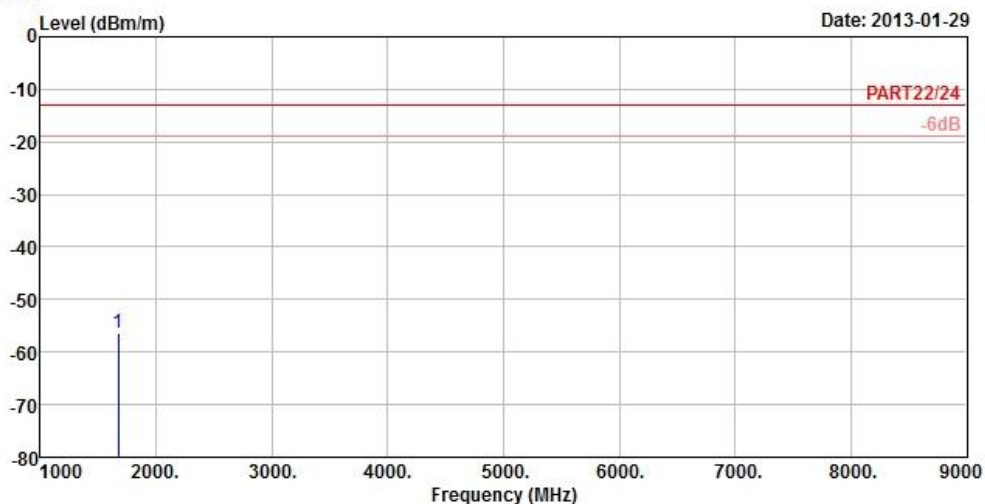

Site : 966 Chamber 5
 Condition : PART22/24 3m VERTICAL
 Brand/Model: 121225C13
 Remark : Band V Link
 Tested by : Kay Wu
 Temperature : 25°C
 Humidity : 65%
 Plane : Y

Freq	Level	Read Level	Limit Line	Over Limit	Factor	Remark
MHz	dBm/m	dBm	dBm/m	dB	dB/m	
1 pp 1672.80	-56.53	-43.71	-13.00	-43.53	-12.82	Peak

LTE BAND 5
CHANNEL BANDWIDTH: 10MHz / QPSK



Bureau Veritas Consumer Products Services Ltd., Taoyuan Branch

A D T

Data: 9

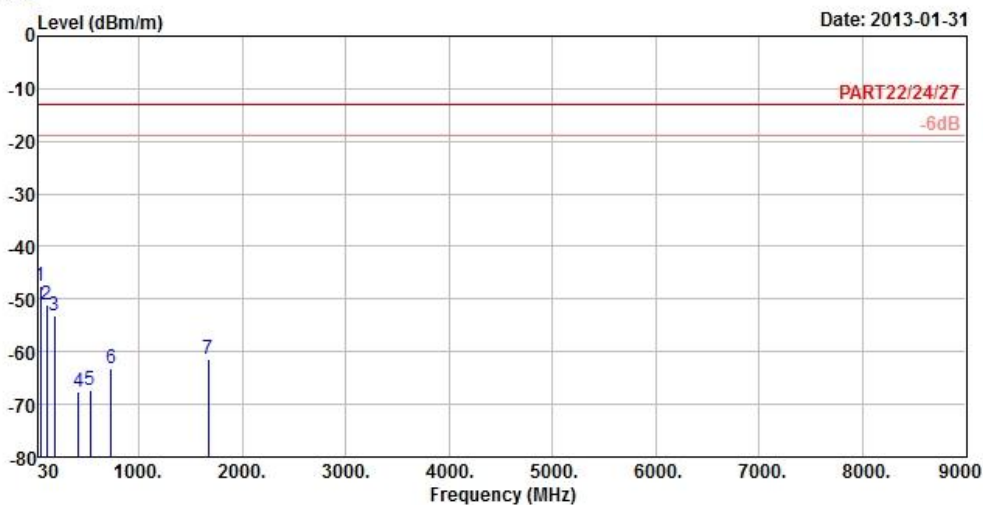

Site : 966 Chamber 5
 Condition : PART22/24/27 3m HORIZONTAL
 Brand/Model: 121225C13
 Remark : LTE_Band 5_10M_QPSK(1,24)
 Tested by : Kay Wu
 Temperature : 25°C
 Humidity : 65%
 Plane : Y

	Freq	Level	Read Level	Limit Line	Over Limit	Factor	Remark
	MHz	dBm/m	dBm	dBm/m	dB	dB/m	
1 pp	45.39	-47.61	-45.85	-13.00	-34.61	-1.76	Peak
2	110.73	-50.94	-40.31	-13.00	-37.94	-10.63	Peak
3	180.12	-53.04	-47.37	-13.00	-40.04	-5.67	Peak
4	418.30	-67.74	-62.57	-13.00	-54.74	-5.17	Peak
5	530.30	-67.20	-64.93	-13.00	-54.20	-2.27	Peak
6	727.70	-63.15	-64.78	-13.00	-50.15	1.63	Peak
7	1672.80	-61.51	-48.69	-13.00	-48.51	-12.82	Peak



A D T



Bureau Veritas Consumer Products Services Ltd., Taoyuan Branch

A D T

Data: 10

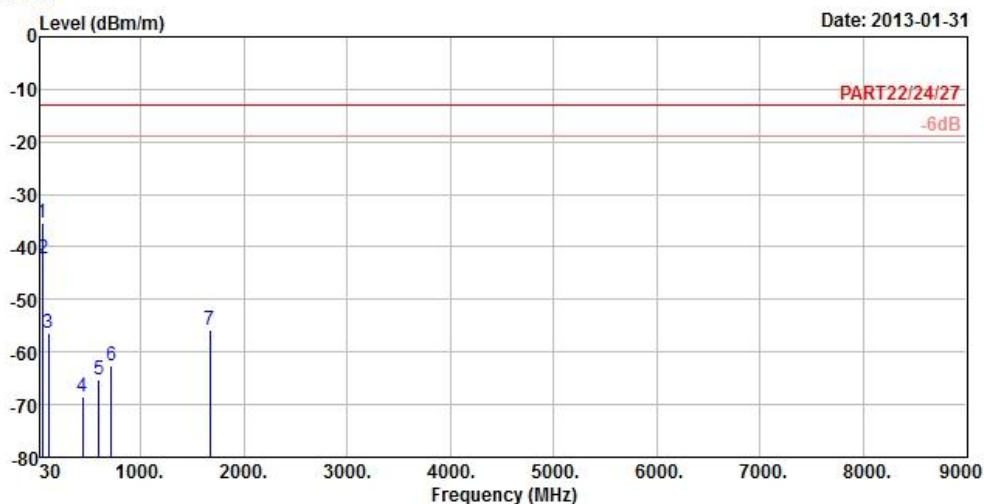

Site : 966 Chamber 5
 Condition : PART22/24/27 3m VERTICAL
 Brand/Model: 121225C13
 Remark : LTE_Band 5_10M_QPSK(1,24)
 Tested by : Kay Wu
 Temperature : 25°C
 Humidity : 65%
 Plane : Y

	Freq	Level	Read Level	Limit Line	Over Limit	Factor	Remark
	MHz	dBm/m	dBm	dBm/m	dB	dB/m	
1	pp	45.39	-35.44	-33.68	-13.00	-22.44	-1.76 Peak
2		58.08	-42.24	-36.44	-13.00	-29.24	-5.80 Peak
3		109.11	-56.24	-45.63	-13.00	-43.24	-10.61 Peak
4		438.60	-68.46	-63.80	-13.00	-55.46	-4.66 Peak
5		594.70	-65.23	-64.72	-13.00	-52.23	-0.51 Peak
6		719.30	-62.50	-64.08	-13.00	-49.50	1.58 Peak
7		1672.80	-55.77	-42.95	-13.00	-42.77	-12.82 Peak



A D T

TEST MODE B

GSM:



Bureau Veritas Consumer Products Services Ltd., Taoyuan Branch

A D T

Data: 9

Date: 2013-01-31

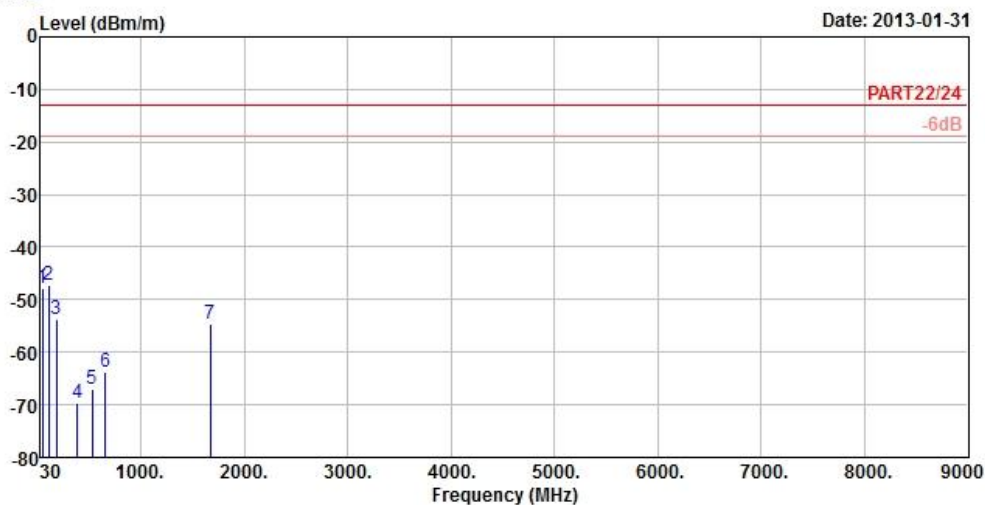

Site : 966 Chamber 5
 Condition : PART22/24 3m HORIZONTAL
 Brand/Model: 121225C13
 Remark : GSM850 Link
 Tested by : Kay Wu
 Temperature : 25°C
 Humidity : 65%
 Plane : Y
 Sample : 2nd

	Freq	Level	Read Level	Limit Line	Over Limit	Factor	Remark
	MHz	dBm/m	dBm	dBm/m	dB	dB/m	
1	45.66	-47.76	-46.00	-13.00	-34.76	-1.76	Peak
2 pp	110.19	-47.11	-36.48	-13.00	-34.11	-10.63	Peak
3	179.31	-53.75	-47.89	-13.00	-40.75	-5.86	Peak
4	383.30	-69.78	-64.02	-13.00	-56.78	-5.76	Peak
5	531.00	-67.07	-64.80	-13.00	-54.07	-2.27	Peak
6	652.80	-63.67	-64.26	-13.00	-50.67	0.59	Peak
7	1672.80	-54.53	-41.71	-13.00	-41.53	-12.82	Peak



A D T



Bureau Veritas Consumer Products Services Ltd., Taoyuan Branch

A D T

Data: 10

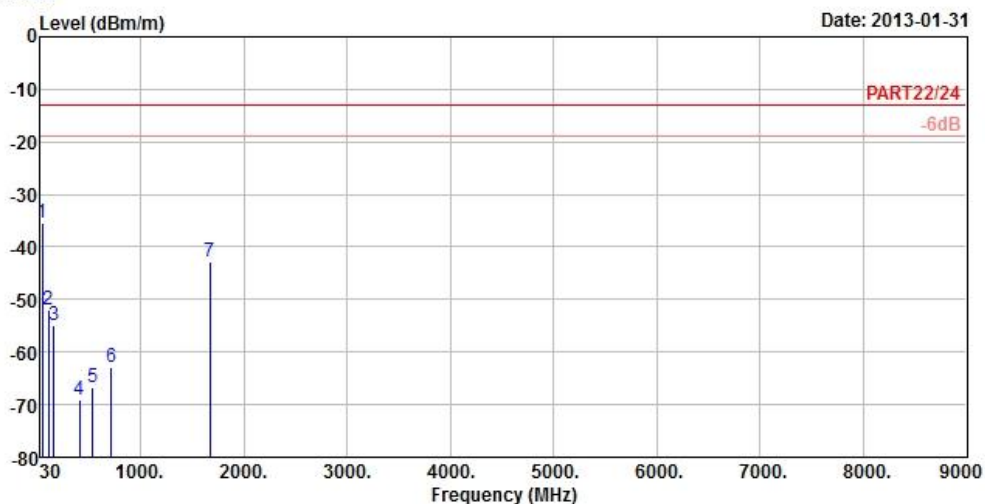

Site : 966 Chamber 5
 Condition : PART22/24 3m VERTICAL
 Brand/Model: 121225C13
 Remark : GSM850 Link
 Tested by : Kay Wu
 Temperature : 25°C
 Humidity : 65%
 Plane : Y
 Sample : 2nd

	Freq	Level	Read Level	Limit Line	Over Limit	Factor	Remark
	MHz	dBm/m	dBm	dBm/m	dB	dB/m	
1 pp	45.39	-35.37	-33.61	-13.00	-22.37	-1.76	Peak
2	110.19	-52.01	-41.38	-13.00	-39.01	-10.63	Peak
3	158.79	-55.05	-48.55	-13.00	-42.05	-6.50	Peak
4	409.90	-69.08	-63.71	-13.00	-56.08	-5.37	Peak
5	535.90	-66.68	-64.57	-13.00	-53.68	-2.11	Peak
6	718.60	-62.74	-64.32	-13.00	-49.74	1.58	Peak
7	1672.80	-42.74	-29.92	-13.00	-29.74	-12.82	Peak



A D T

LTE BAND 5
CHANNEL BANDWIDTH: 10MHz / QPSK



Bureau Veritas Consumer Products Services Ltd., Taoyuan Branch

A D T

Data: 9

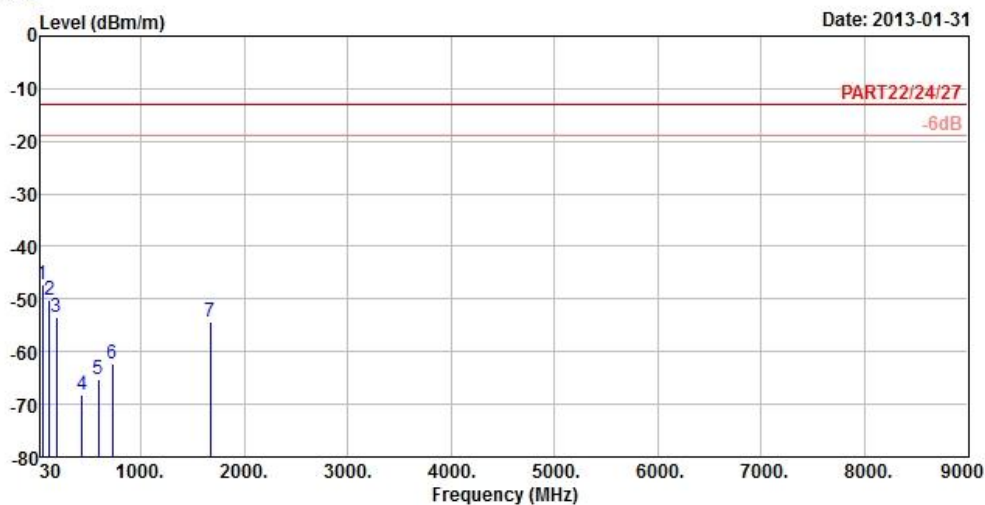

Site : 966 Chamber 5
 Condition : PART22/24/27 3m HORIZONTAL
 Brand/Model: 121225C13
 Remark : LTE_Band 5_10M_QPSK(1,24)
 Tested by : Kay Wu
 Temperature : 25°C
 Humidity : 65%
 Plane : X
 Sample : 2nd

	Freq MHz	Level dBm/m	Read	Limit	Over	Factor	Remark
			Level dBm	Line dBm/m	Limit dB		
1 pp	45.39	-47.30	-45.54	-13.00	-34.30	-1.76	Peak
2	111.27	-50.30	-39.65	-13.00	-37.30	-10.65	Peak
3	180.12	-53.38	-47.71	-13.00	-40.38	-5.67	Peak
4	432.30	-68.09	-63.28	-13.00	-55.09	-4.81	Peak
5	584.90	-65.10	-64.32	-13.00	-52.10	-0.78	Peak
6	720.00	-62.38	-63.96	-13.00	-49.38	1.58	Peak
7	1672.80	-54.33	-41.51	-13.00	-41.33	-12.82	Peak



A D T



Bureau Veritas Consumer Products Services Ltd., Taoyuan Branch

A D T

Data: 10

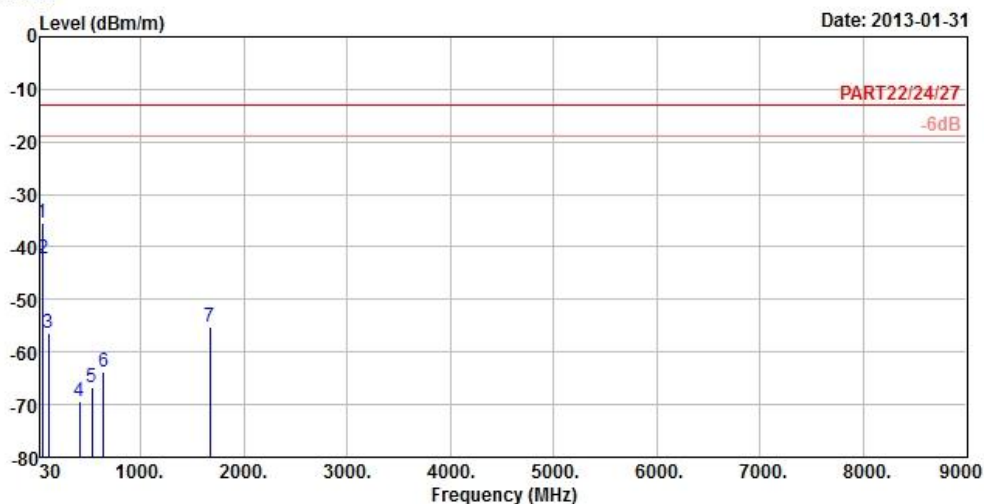

Site : 966 Chamber 5
 Condition : PART22/24/27 3m VERTICAL
 Brand/Model: 121225C13
 Remark : LTE_Band 5_10M_QPSK(1,24)
 Tested by : Kay Wu
 Temperature : 25°C
 Humidity : 65%
 Plane : X
 Sample : 2nd

	Freq	Level	Read Level	Limit Line	Over Limit	Factor	Remark
	MHz	dBm/m	dBm	dBm/m	dB	dB/m	
1 pp	44.85	-35.29	-34.10	-13.00	-22.29	-1.19	Peak
2	58.35	-42.07	-36.27	-13.00	-29.07	-5.80	Peak
3	109.92	-56.47	-45.86	-13.00	-43.47	-10.61	Peak
4	409.90	-69.41	-64.04	-13.00	-56.41	-5.37	Peak
5	528.20	-66.59	-64.27	-13.00	-53.59	-2.32	Peak
6	643.70	-63.64	-64.08	-13.00	-50.64	0.44	Peak
7	1672.80	-55.19	-42.37	-13.00	-42.19	-12.82	Peak



A D T

5 PHOTOGRAPHS OF THE TEST CONFIGURATION

Please refer to the attached file (Test Setup Photo).



6 INFORMATION ON THE TESTING LABORATORIES

We, Bureau Veritas Consumer Products Services (H.K.) Ltd., Taoyuan Branch, were founded in 1988 to provide our best service in EMC, Radio, Telecom and Safety consultation. Our laboratories are accredited and approved according to ISO/IEC 17025.

If you have any comments, please feel free to contact us at the following:

Linko EMC/RF Lab:

Tel: 886-2-26052180

Fax: 886-2-26051924

Hsin Chu EMC/RF Lab:

Tel: 886-3-5935343

Fax: 886-3-5935342

Hwa Ya EMC/RF/Safety/Telecom Lab:

Tel: 886-3-3183232

Fax: 886-3-3270892

Email: service.adt@tw.bureauveritas.com

Web Site: www.bureauveritas-adt.com

The address and road map of all our labs can be found in our web site also.



A D T

7 APPENDIX A – MODIFICATIONS RECORDERS FOR ENGINEERING CHANGES TO THE EUT BY THE LAB

No any modifications were made to the EUT by the lab during the test.

---END---