



FCC TEST REPORT (15.247:WLAN)

REPORT NO.: RF120717C01-4
MODEL NO.: PM23100
FCC ID: NM8PM23100
RECEIVED: Jul. 17, 2012
TESTED: Jul. 30 ~ Aug. 03, 2012
ISSUED: Aug. 13, 2012

APPLICANT: HTC Corporation

ADDRESS: 23, Xinghua Rd., Taoyuan 330, Taiwan, R.O.C.

ISSUED BY: Bureau Veritas Consumer Products Services
(H.K.) Ltd., Taoyuan Branch

LAB ADDRESS: No. 47, 14th Ling, Chia Pau Vil., Lin Kou Dist.,
New Taipei City, Taiwan (R.O.C)

TEST LOCATION: No. 19, Hwa Ya 2nd Rd, Wen Hwa Tsuen, Kwei
Shan Hsiang, Taoyuan Hsien 333, Taiwan, R.O.C.

This report should not be used by the client to claim product certification, approval, or endorsement by TAF or any government agencies.



This report is for your exclusive use. Any copying or replication of this report to or for any other person or entity, or use of our name or trademark, is permitted only with our prior written permission. This report sets forth our findings solely with respect to the test samples identified herein. The results set forth in this report are not indicative or representative of the quality or characteristics of the lot from which a test sample was taken or any similar or identical product unless specifically and expressly noted. Our report includes all of the tests requested by you and the results thereof based upon the information that you provided to us. You have 60 days from date of issuance of this report to notify us of any material error or omission caused by our negligence, provided, however, that such notice shall be in writing and shall specifically address the issue you wish to raise. A failure to raise such issue within the prescribed time shall constitute your unqualified acceptance of the completeness of this report, the tests conducted and the correctness of the report contents. Unless specific mention, the uncertainty of measurement has been explicitly taken into account to declare the compliance or non-compliance to the specification.



TABLE OF CONTENTS

RELEASE CONTROL RECORD.....	5
1. CERTIFICATION	6
2. SUMMARY OF TEST RESULTS	7
2.1 MEASUREMENT UNCERTAINTY.....	7
3. GENERAL INFORMATION.....	8
3.1 GENERAL DESCRIPTION OF EUT	8
3.2 DESCRIPTION OF TEST MODES	9
3.2.1 TEST MODE APPLICABILITY AND TESTED CHANNEL DETAIL	10
3.3 DESCRIPTION OF SUPPORT UNITS	14
3.3.1 CONFIGURATION OF SYSTEM UNDER TEST	14
3.4 GENERAL DESCRIPTION OF APPLIED STANDARDS	14
4. TEST TYPES AND RESULTS (FOR 2.4GHz BAND).....	15
4.1 RADIATED EMISSION AND BANDEDGE MEASUREMENT.....	15
4.1.1 LIMITS OF RADIATED EMISSION AND BANDEDGE MEASUREMENT	15
4.1.2 TEST INSTRUMENTS.....	16
4.1.3 TEST PROCEDURES	17
4.1.4 DEVIATION FROM TEST STANDARD	17
4.1.5 TEST SETUP.....	18
4.1.6 EUT OPERATING CONDITIONS	18
4.1.7 TEST RESULTS	19
4.2 CONDUCTED EMISSION MEASUREMENT	32
4.2.1 LIMITS OF CONDUCTED EMISSION MEASUREMENT.....	32
4.2.2 TEST INSTRUMENTS.....	32
4.2.3 TEST PROCEDURES	33
4.2.4 DEVIATION FROM TEST STANDARD	33
4.2.5 TEST SETUP.....	34
4.2.6 EUT OPERATING CONDITIONS	34
4.2.7 TEST RESULTS	35
4.3 6dB BANDWIDTH MEASUREMENT.....	39
4.3.1 LIMITS OF 6dB BANDWIDTH MEASUREMENT	39
4.3.2 TEST SETUP.....	39
4.3.3 TEST INSTRUMENTS.....	39
4.3.4 TEST PROCEDURE.....	39
4.3.5 DEVIATION FROM TEST STANDARD	39
4.3.6 EUT OPERATING CONDITIONS	39
4.3.7 TEST RESULTS	40
4.4 CONDUCTED OUTPUT POWER	41
4.4.1 LIMITS OF CONDUCTED OUTPUT POWER MEASUREMENT	41
4.4.2 TEST SETUP.....	41
4.4.3 TEST INSTRUMENTS.....	41
4.4.4 TEST PROCEDURES	41
4.4.5 DEVIATION FROM TEST STANDARD	41
4.4.6 EUT OPERATING CONDITIONS	41
4.4.7 TEST RESULTS	42
4.5 POWER SPECTRAL DENSITY MEASUREMENT.....	43
4.5.1 LIMITS OF POWER SPECTRAL DENSITY MEASUREMENT	43
4.5.2 TEST SETUP.....	43
4.5.3 TEST INSTRUMENTS.....	43



4.5.4	TEST PROCEDURE.....	43
4.5.5	DEVIATION FROM TEST STANDARD	43
4.5.6	EUT OPERATING CONDITION	43
4.5.7	TEST RESULTS	44
4.6	CONDUCTED OUT OF BAND EMISSION MEASUREMENT.....	45
4.6.1	LIMITS OF CONDUCTED OUT OF BAND EMISSION MEASUREMENT	45
4.6.2	TEST SETUP.....	45
4.6.3	TEST INSTRUMENTS.....	45
4.6.4	TEST PROCEDURE.....	45
4.6.5	DEVIATION FROM TEST STANDARD	46
4.6.6	EUT OPERATING CONDITION	46
4.6.7	TEST RESULTS	46
5.	TEST TYPES AND RESULTS (FOR 5.0GHz BAND).....	51
5.1	RADIATED EMISSION AND BANDEDGE MEASUREMENT.....	51
5.1.1	LIMITS OF RADIATED EMISSION AND BANDEDGE MEASUREMENT	51
5.1.2	TEST INSTRUMENTS.....	52
5.1.3	TEST PROCEDURES	52
5.1.4	DEVIATION FROM TEST STANDARD	52
5.1.5	TEST SETUP.....	52
5.1.6	EUT OPERATING CONDITIONS	52
5.1.7	TEST RESULTS	53
5.2	CONDUCTED EMISSION MEASUREMENT	62
5.2.1	LIMITS OF CONDUCTED EMISSION MEASUREMENT.....	62
5.2.2	TEST INSTRUMENTS.....	62
5.2.3	TEST PROCEDURES	62
5.2.4	DEVIATION FROM TEST STANDARD	62
5.2.5	TEST SETUP.....	62
5.2.6	EUT OPERATING CONDITIONS	62
5.2.7	TEST RESULTS	63
5.3	6dB BANDWIDTH MEASUREMENT.....	67
5.3.1	LIMITS OF 6dB BANDWIDTH MEASUREMENT	67
5.3.2	TEST SETUP.....	67
5.3.3	TEST INSTRUMENTS.....	67
5.3.4	TEST PROCEDURE.....	67
5.3.5	DEVIATION FROM TEST STANDARD	67
5.3.6	EUT OPERATING CONDITIONS	67
5.3.7	TEST RESULTS	68
5.4	MAXIMUM OUTPUT POWER.....	69
5.4.1	LIMITS OF MAXIMUM OUTPUT POWER MEASUREMENT	69
5.4.2	TEST SETUP.....	69
5.4.3	INSTRUMENTS.....	69
5.4.4	TEST PROCEDURES	69
5.4.5	DEVIATION FROM TEST STANDARD	69
5.4.6	EUT OPERATING CONDITIONS	69
5.4.7	TEST RESULTS	70
5.5	POWER SPECTRAL DENSITY MEASUREMENT.....	71
5.5.1	LIMITS OF POWER SPECTRAL DENSITY MEASUREMENT	71
5.5.2	TEST SETUP.....	71
5.5.3	TEST INSTRUMENTS.....	71
5.5.4	TEST PROCEDURE.....	71
5.5.5	DEVIATION FROM TEST STANDARD	71



A D T

5.5.6	EUT OPERATING CONDITION	71
5.5.7	TEST RESULTS	72
5.6	CONDUCTED OUT OF BAND EMISSION MEASUREMENT	73
5.6.1	LIMITS OF OUT OF BAND EMISSION MEASUREMENT	73
5.6.2	TEST SETUP	73
5.6.3	TEST INSTRUMENTS.....	73
5.6.4	TEST PROCEDURE.....	73
5.6.5	DEVIATION FROM TEST STANDARD	73
5.6.6	EUT OPERATING CONDITION	73
5.6.7	TEST RESULTS	73
6.	PHOTOGRAPHS OF THE TEST CONFIGURATION.....	77
7.	INFORMATION ON THE TESTING LABORATORIES	78
8.	APPENDIX A - MODIFICATIONS RECORDERS FOR ENGINEERING CHANGES TO THE EUT BY THE LAB.....	79



A D T

RELEASE CONTROL RECORD

ISSUE NO.	REASON FOR CHANGE	DATE ISSUED
RF120717C01-4	Original release	Aug. 13, 2012



1. CERTIFICATION

PRODUCT: Windows Phone
MODEL NO.: PM23100
BRAND: HTC
APPLICANT: HTC Corporation
TESTED: Jul. 30 ~ Aug. 03, 2012
TEST SAMPLE: Production Unit
STANDARDS: **FCC Part 15, Subpart C (Section 15.247)**
ANSI C63.10-2009

The above equipment (model: PM23100) has been tested by **Bureau Veritas Consumer Products Services (H.K.) Ltd., Taoyuan Branch**, and found compliance with the requirement of the above standards. The test record, data evaluation & Equipment Under Test (EUT) configurations represented herein are true and accurate accounts of the measurements of the sample's EMC characteristics under the conditions specified in this report.

PREPARED BY :  , **DATE** : Aug. 13, 2012
Pettie Chen / Senior Specialist

APPROVED BY :  , **DATE** : Aug. 13, 2012
Gary Chang / Technical Manager

2. SUMMARY OF TEST RESULTS

The EUT has been tested according to the following specifications:

APPLIED STANDARD: FCC PART 15, SUBPART C (SECTION 15.247)			
STANDARD SECTION	TEST TYPE	RESULT	REMARK
15.207	AC Power Conducted Emission	PASS	Meet the requirement of limit. Minimum passing margin is -7.25dB at 0.54453MHz.
15.247(d) 15.209	Radiated Emissions	PASS	Meet the requirement of limit. Minimum passing margin is -1.4dB at 5725.00MHz.
15.247(d)	Band Edge Measurement	PASS	Meet the requirement of limit.
15.247(a)(2)	6dB bandwidth	PASS	Meet the requirement of limit.
15.247(b)	Conducted power	PASS	Meet the requirement of limit.
15.247(e)	Power Spectral Density	PASS	Meet the requirement of limit.
15.203	Antenna Requirement	PASS	No antenna connector is used.

2.1 MEASUREMENT UNCERTAINTY

Where relevant, the following measurement uncertainty levels have been estimated for tests performed on the EUT as specified in CISPR 16-4-2:

MEASUREMENT	FREQUENCY	UNCERTAINTY
Conducted emissions	9kHz~30MHz	2.44 dB
Radiated emissions	30MHz ~ 200MHz	2.93 dB
	200MHz ~1000MHz	2.95 dB
	1GHz ~ 18GHz	2.26 dB
	18GHz ~ 40GHz	1.94 dB

This uncertainty represents an expanded uncertainty expressed at approximately the 95% confidence level using a coverage factor of $k = 2$.



3. GENERAL INFORMATION

3.1 GENERAL DESCRIPTION OF EUT

EUT	Windows Phone
MODEL NO.	PM23100
POWER SUPPLY	5.0Vdc (adapter or host equipment) 3.75Vdc (Li-ion battery)
MODULATION TYPE	CCK, DQPSK, DBPSK for DSSS 64QAM, 16QAM, QPSK, BPSK for OFDM
MODULATION TECHNOLOGY	DSSS, OFDM
TRANSFER RATE	802.11b:11.0/ 5.5/ 2.0/ 1.0Mbps 802.11g: 54.0/ 48.0/ 36.0/ 24.0/ 18.0/ 12.0/ 9.0/ 6.0Mbps 802.11a: 54.0/ 48.0/ 36.0/ 24.0/ 18.0/ 12.0/ 9.0/ 6.0Mbps 802.11n: up to 135.0Mbps
OPERATING FREQUENCY	2.4GHz: 2412 ~ 2462MHz 5.0GHz: 5745 ~ 5825MHz
NUMBER OF CHANNEL	2.4GHz: 11 for 802.11b, 802.11g, 802.11n (20MHz) 7 for 802.11n (40MHz) 5.0GHz: 4 for 802.11a, 802.11n (20MHz) 2 for 802.11n (40MHz)
OUTPUT POWER	132.74mW for 2412 ~ 2462MHz 103.75mW for 5745 ~ 5825MHz
ANTENNA TYPE	2.4GHz: PIFA antenna with -2.93dBi gain 5.0GHz: PIFA antenna with -2.2dBi gain
ANTENNA CONNECTOR	NA
DATA CABLE	Refer to Note as below
I/O PORTS	Refer to user's manual
ACCESSORY DEVICES	Refer to Note as below

NOTE:

1. The EUT's accessories list refers to Ext Pho.pdf.
* Item 2, 3, 5, 6, 7, 8 were the worst for the final test.
2. The EUT provides one completed transmitter and one receiver.

MODULATION MODE	TX FUNCTION
802.11b	1TX
802.11g	1TX
802.11a	1TX
802.11n (20MHz)	1TX
802.11n (40MHz)	1TX

3. The above EUT information is declared by the manufacturer and for more detailed features description, please refer to the manufacturer's specifications or User's Manual.

3.2 DESCRIPTION OF TEST MODES

FOR 2.4GHz:

11 channels are provided for 802.11b, 802.11g and 802.11n (20MHz):

CHANNEL	FREQUENCY	CHANNEL	FREQUENCY
1	2412MHz	7	2442MHz
2	2417MHz	8	2447MHz
3	2422MHz	9	2452MHz
4	2427MHz	10	2457MHz
5	2432MHz	11	2462MHz
6	2437MHz		

7 channels are provided for 802.11n (40MHz):

CHANNEL	FREQUENCY	CHANNEL	FREQUENCY
3	2422MHz	7	2442MHz
4	2427MHz	8	2447MHz
5	2432MHz	9	2452MHz
6	2437MHz		

FOR 5.0GHz (5745 ~ 5825MHz):

4 channels are provided for 802.11a, 802.11n (20MHz):

CHANNEL	FREQUENCY	CHANNEL	FREQUENCY
149	5745MHz	157	5785MHz
153	5765MHz	161	5805MHz

2 channels are provided for 802.11n (40MHz):

CHANNEL	FREQUENCY	CHANNEL	FREQUENCY
151	5755MHz	159	5795MHz

3.2.1 TEST MODE APPLICABILITY AND TESTED CHANNEL DETAIL

FOR 2.4GHz:

EUT CONFIGURE MODE	APPLICABLE TO				DESCRIPTION
	RE≥1G	RE<1G	PLC	APCM	
-	√	√	√	√	-

Where **RE≥1G**: Radiated Emission above 1GHz **RE<1G**: Radiated Emission below 1GHz
PLC: Power Line Conducted Emission **APCM**: Antenna Port Conducted Measurement

NOTE: The EUT had been pre-tested on the positioned of each 3 axis. The worst case was found when positioned on Y-plane.

RADIATED EMISSION TEST (ABOVE 1GHz):

- Pre-Scan has been conducted to determine the worst-case mode from all possible combinations between available modulations, data rates and antenna ports (if EUT with antenna diversity architecture).
- Following channel(s) was (were) selected for the final test as listed below.

MODE	AVAILABLE CHANNEL	TESTED CHANNEL	MODULATION TECHNOLOGY	MODULATION TYPE	DATA RATE (Mbps)
802.11b	1 to 11	1, 6, 11	DSSS	DBPSK	1.0
802.11g	1 to 11	1, 6, 11	OFDM	BPSK	6.0
802.11n (20MHz)	1 to 11	1, 6, 11	OFDM	BPSK	6.5
802.11n (40MHz)	3 to 9	3, 6, 9	OFDM	BPSK	13.5

RADIATED EMISSION TEST (BELOW 1GHz):

- Pre-Scan has been conducted to determine the worst-case mode from all possible combinations between available modulations, data rates and antenna ports (if EUT with antenna diversity architecture).
- Following channel(s) was (were) selected for the final test as listed below.

MODE	AVAILABLE CHANNEL	TESTED CHANNEL	MODULATION TECHNOLOGY	MODULATION TYPE	DATA RATE (Mbps)
802.11g	1 to 11	11	OFDM	BPSK	6.0

POWER LINE CONDUCTED EMISSION TEST:

- Pre-Scan has been conducted to determine the worst-case mode from all possible combinations between available modulations, data rates and antenna ports (if EUT with antenna diversity architecture).
- Following channel(s) was (were) selected for the final test as listed below.

MODE	AVAILABLE CHANNEL	TESTED CHANNEL	MODULATION TECHNOLOGY	MODULATION TYPE	DATA RATE (Mbps)
802.11g	1 to 11	11	OFDM	BPSK	6.0

*Test condition: WIFI+Bluetooth+NFC



BANDEDGE MEASUREMENT:

- Pre-Scan has been conducted to determine the worst-case mode from all possible combinations between available modulations, data rates and antenna ports (if EUT with antenna diversity architecture).
- Following channel(s) was (were) selected for the final test as listed below.

MODE	AVAILABLE CHANNEL	TESTED CHANNEL	MODULATION TECHNOLOGY	MODULATION TYPE	DATA RATE (Mbps)
802.11b	1 to 11	1, 11	DSSS	DBPSK	1.0
802.11g	1 to 11	1, 11	OFDM	BPSK	6.0
802.11n (20MHz)	1 to 11	1, 11	OFDM	BPSK	6.5
802.11n (40MHz)	3 to 9	3, 9	OFDM	BPSK	13.5

ANTENNA PORT CONDUCTED MEASUREMENT:

- This item includes all test value of each mode, but only includes spectrum plot of worst value of each mode.
- Pre-Scan has been conducted to determine the worst-case mode from all possible combinations between available modulations, data rates and antenna ports (if EUT with antenna diversity architecture).
- Following channel(s) was (were) selected for the final test as listed below.

MODE	AVAILABLE CHANNEL	TESTED CHANNEL	MODULATION TECHNOLOGY	MODULATION TYPE	DATA RATE (Mbps)
802.11b	1 to 11	1, 6, 11	DSSS	DBPSK	1.0
802.11g	1 to 11	1, 6, 11	OFDM	BPSK	6.0
802.11n (20MHz)	1 to 11	1, 6, 11	OFDM	BPSK	6.5
802.11n (40MHz)	3 to 9	3, 6, 9	OFDM	BPSK	13.5

TEST CONDITION:

APPLICABLE TO	ENVIRONMENTAL CONDITIONS	INPUT POWER	TESTED BY
RE≥1G	25deg. C, 65%RH	120Vac, 60Hz	Alan Wu
RE<1G	25deg. C, 65%RH	120Vac, 60Hz	Alan Wu
PLC	25deg. C, 65%RH	120Vac, 60Hz	David Huang
APCM	25deg. C, 65%RH	120Vac, 60Hz	Howard Kao



A D T

FOR 5.0GHz (5745 ~ 5825MHz):

EUT CONFIGURE MODE	APPLICABLE TO				DESCRIPTION
	RE≥1G	RE<1G	PLC	APCM	
-	√	√	√	√	-

Where **RE≥1G**: Radiated Emission above 1GHz **RE<1G**: Radiated Emission below 1GHz
PLC: Power Line Conducted Emission **APCM**: Antenna Port Conducted Measurement

NOTE: The EUT had been pre-tested on the positioned of each 3 axis. The worst case was found when positioned on Y-plane.

RADIATED EMISSION TEST (ABOVE 1GHz):

- Pre-Scan has been conducted to determine the worst-case mode from all possible combinations between available modulations, data rates and antenna ports (if EUT with antenna diversity architecture).
- Following channel(s) was (were) selected for the final test as listed below.

MODE	AVAILABLE CHANNEL	TESTED CHANNEL	MODULATION TECHNOLOGY	MODULATION TYPE	DATA RATE (Mbps)
802.11a	149 to 161	149, 157, 161	OFDM	BPSK	6.0
802.11n (20MHz)	149 to 161	149, 157, 161	OFDM	BPSK	6.5
802.11n (40MHz)	151 to 159	151, 159	OFDM	BPSK	13.5

RADIATED EMISSION TEST (BELOW 1GHz):

- Pre-Scan has been conducted to determine the worst-case mode from all possible combinations between available modulations, data rates and antenna ports (if EUT with antenna diversity architecture).
- Following channel(s) was (were) selected for the final test as listed below.

MODE	AVAILABLE CHANNEL	TESTED CHANNEL	MODULATION TECHNOLOGY	MODULATION TYPE	DATA RATE (Mbps)
802.11n (20MHz)	149 to 161	149	OFDM	BPSK	6.5

POWER LINE CONDUCTED EMISSION TEST:

- Pre-Scan has been conducted to determine the worst-case mode from all possible combinations between available modulations, data rates and antenna ports (if EUT with antenna diversity architecture).
- Following channel(s) was (were) selected for the final test as listed below.

MODE	AVAILABLE CHANNEL	TESTED CHANNEL	MODULATION TECHNOLOGY	MODULATION TYPE	DATA RATE (Mbps)
802.11n (20MHz)	149 to 161	149	OFDM	BPSK	6.5

*Test condition: WIFI+Bluetooth+NFC



BANDEDGE MEASUREMENT:

- Pre-Scan has been conducted to determine the worst-case mode from all possible combinations between available modulations, data rates and antenna ports (if EUT with antenna diversity architecture).
- Following channel(s) was (were) selected for the final test as listed below.

MODE	AVAILABLE CHANNEL	TESTED CHANNEL	MODULATION TECHNOLOGY	MODULATION TYPE	DATA RATE (Mbps)
802.11a	149 to 161	149, 161	OFDM	BPSK	6.0
802.11n (20MHz)	149 to 161	149, 161	OFDM	BPSK	6.5
802.11n (40MHz)	151 to 159	151, 159	OFDM	BPSK	13.5

ANTENNA PORT CONDUCTED MEASUREMENT:

- Pre-Scan has been conducted to determine the worst-case mode from all possible combinations between available modulations, data rates and antenna ports (if EUT with antenna diversity architecture).
- Following channel(s) was (were) selected for the final test as listed below.

MODE	AVAILABLE CHANNEL	TESTED CHANNEL	MODULATION TECHNOLOGY	MODULATION TYPE	DATA RATE (Mbps)
802.11a	149 to 161	149, 157, 161	OFDM	BPSK	6.0
802.11n (20MHz)	149 to 161	149, 157, 161	OFDM	BPSK	6.5
802.11n (40MHz)	151 to 159	151, 159	OFDM	BPSK	13.5

TEST CONDITION:

APPLICABLE TO	ENVIRONMENTAL CONDITIONS	INPUT POWER	TESTED BY
RE≥1G	25deg. C, 65%RH	120Vac, 60Hz	Antony Lee
RE<1G	25deg. C, 65%RH	120Vac, 60Hz	Alan Wu
PLC	25deg. C, 65%RH	120Vac, 60Hz	David Huang
APCM	25deg. C, 65%RH	120Vac, 60Hz	Howard Kao

3.3 DESCRIPTION OF SUPPORT UNITS

The EUT has been tested as an independent unit together with other necessary accessories or support units. The following support units or accessories were used to form a representative test configuration during the tests.

NO.	PRODUCT	BRAND	MODEL NO.	SERIAL NO.	FCC ID
1	Earphone	HTC	HS G400	NA	NA

NO.	SIGNAL CABLE DESCRIPTION OF THE ABOVE SUPPORT UNITS
1	1.0m non-shielded cable

NOTE:

1. All power cords of the above support units are non shielded (1.8m).
2. Item 1 was provided by client.

3.3.1 CONFIGURATION OF SYSTEM UNDER TEST

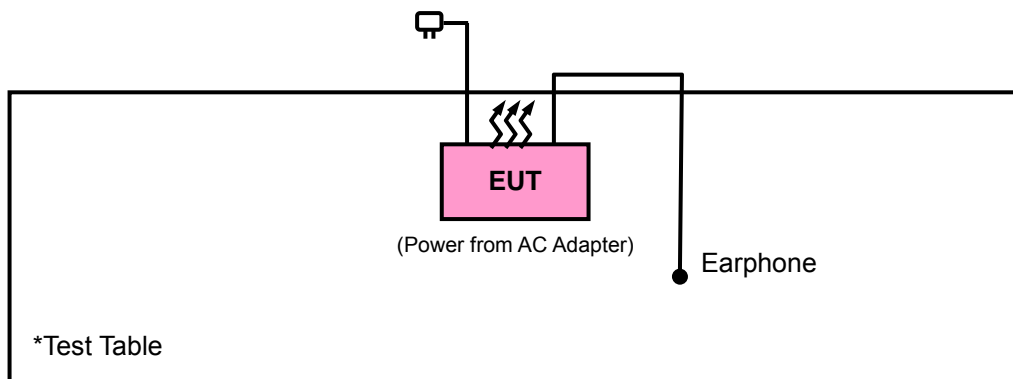

3.4 GENERAL DESCRIPTION OF APPLIED STANDARDS

The EUT is a RF Product. According to the specifications of the manufacturer, it must comply with the requirements of the following standards:

FCC Part 15, Subpart C (15.247)

ANSI C63.10-2009

KDB 558074 D01 DTS Meas Guidance v01

All test items have been performed and recorded as per the above standards.

NOTE: The EUT is also considered as a kind of computer peripheral, because the connection to computer is necessary for typical use. It has been verified to comply with the requirements of FCC Part 15, Subpart B, Class B (DoC). The test report has been issued separately.

4. TEST TYPES AND RESULTS (FOR 2.4GHz BAND)

4.1 RADIATED EMISSION AND BANDEDGE MEASUREMENT

4.1.1 LIMITS OF RADIATED EMISSION AND BANDEDGE MEASUREMENT

Radiated emissions which fall in the restricted bands must comply with the radiated emission limits specified as below table. Other emissions shall be at least 20dB below the highest level of the desired power:

FREQUENCIES (MHz)	FIELD STRENGTH (microvolts/meter)	MEASUREMENT DISTANCE (meters)
0.009 ~ 0.490	2400/F(kHz)	300
0.490 ~ 1.705	24000/F(kHz)	30
1.705 ~ 30.0	30	30
30 ~ 88	100	3
88 ~ 216	150	3
216 ~ 960	200	3
Above 960	500	3

NOTE:

1. The lower limit shall apply at the transition frequencies.
2. Emission level (dBuV/m) = 20 log Emission level (uV/m).
3. For frequencies above 1000MHz, the field strength limits are based on average detector, however, the peak field strength of any emission shall not exceed the maximum permitted average limits, specified above by more than 20dB under any condition of modulation.



A D T

4.1.2 TEST INSTRUMENTS

DESCRIPTION & MANUFACTURER	MODEL NO.	SERIAL NO.	DATE OF CALIBRATION	DUE DATE OF CALIBRATION
Test Receiver ROHDE & SCHWARZ	ESI7	838496/016	Jan. 03, 2012	Jan. 02, 2013
Spectrum Analyzer ROHDE & SCHWARZ	FSU43	100115	Sep. 05, 2011	Sep. 04, 2012
BILOG Antenna SCHWARZBECK	VULB9168	9168-155	Apr. 06, 2012	Apr. 05, 2013
HORN Antenna SCHWARZBECK	BBHA 9120D	9120D-408	Jan. 05, 2012	Jan. 04, 2013
HORN Antenna SCHWARZBECK	BBHA 9170	148	Jul. 11, 2012	Jul. 10, 2013
Loop Antenna	HFH2-Z2	100070	Jan. 31, 2012	Jan. 30, 2014
Preamplifier Agilent	8449B	3008A01961	Oct. 29, 2011	Oct. 28, 2012
Preamplifier Agilent	8447D	2944A10738	Oct. 29, 2011	Oct. 28, 2012
RF signal cable HUBER+SUHNNER	SUCOFLEX 104	309220/4	Nov. 03, 2011	Nov. 02, 2012
RF signal cable HUBER+SUHNNER	SUCOFLEX 104	250724/4	Nov. 03, 2011	Nov. 02, 2012
RF signal cable HUBER+SUHNNER	SUCOFLEX 104	295012/4	Nov. 03, 2011	Nov. 02, 2012
Software ADT	ADT_Radiated_V7.6.15.9.2	NA	NA	NA
Antenna Tower inn-co GmbH	MA 4000	010303	NA	NA
Antenna Tower Controller inn-co GmbH	CO2000	019303	NA	NA
Turn Table ADT	TT100.	TT93021704	NA	NA
Turn Table Controller ADT	SC100.	SC93021704	NA	NA
26GHz ~ 40GHz Amplifier	EM26400	815221	Oct. 29, 2011	Oct. 28, 2012
JFW 20dB attenuation	50HF-020-SMA	NA	NA	NA
High Speed Peak Power Meter	ML2495A	0842014	Apr. 28, 2012	Apr. 27, 2013
Power Sensor	MA2411B	0738404	Apr. 28, 2012	Apr. 27, 2013

- NOTE:**
1. The calibration interval of the above test instruments is 12 months and the calibrations are traceable to NML/ROC and NIST/USA.
 2. The calibration interval of the loop antenna is 24 months and the calibrations are traceable to NML/ROC and NIST/USA.
 3. The test was performed in HwaYa Chamber 9.
 4. The horn antenna and HP preamplifier (model: 8449B) are used only for the measurement of emission frequency above 1GHz if tested.
 5. The FCC Site Registration No. is 460141.
 6. The IC Site Registration No. is IC 7450F-4.



4.1.3 TEST PROCEDURES

- a. The EUT was placed on the top of a rotating table 0.8 meters above the ground at a 3 meters semi-anechoic chamber. The table was rotated 360 degrees to determine the position of the highest radiation.
- b. The EUT was set 3 meters away from the interference-receiving antenna, which was mounted on the top of a variable-height antenna tower.
- c. Height of receiving antenna is varied from one meter to four meters above the ground to determine the maximum value of the field strength. Both horizontal and vertical polarizations of the antenna are set to make the measurement.
- d. For each suspected emission, the EUT was arranged to its worst case and then the antenna was tuned to heights from 1 meter to 4 meters and the rotatable table was turned from 0 degrees to 360 degrees to find the maximum reading.
- e. The test-receiver system was set to Peak Detect Function and Specified Bandwidth with Maximum Hold Mode.
- f. If the emission level of the EUT in peak mode was lower than the limit specified, then testing could be stopped and the peak values of the EUT would be reported. Otherwise the emissions would be re-tested one by one using peak, quasi-peak or average method as specified and then reported in a data sheet.

NOTE:

1. The resolution bandwidth and video bandwidth of test receiver/spectrum analyzer is 120kHz for Quasi-peak detection at frequency below 1GHz.
2. The resolution bandwidth of test receiver/spectrum analyzer is 1MHz and video bandwidth is 3MHz for Peak detection at frequency above 1GHz.
3. The resolution bandwidth of test receiver/spectrum analyzer is 1MHz and the video bandwidth is 10Hz for Average detection (AV) at frequency above 1GHz.
4. All modes of operation were investigated and the worst-case emissions are reported.

4.1.4 DEVIATION FROM TEST STANDARD

No deviation.

4.1.5 TEST SETUP

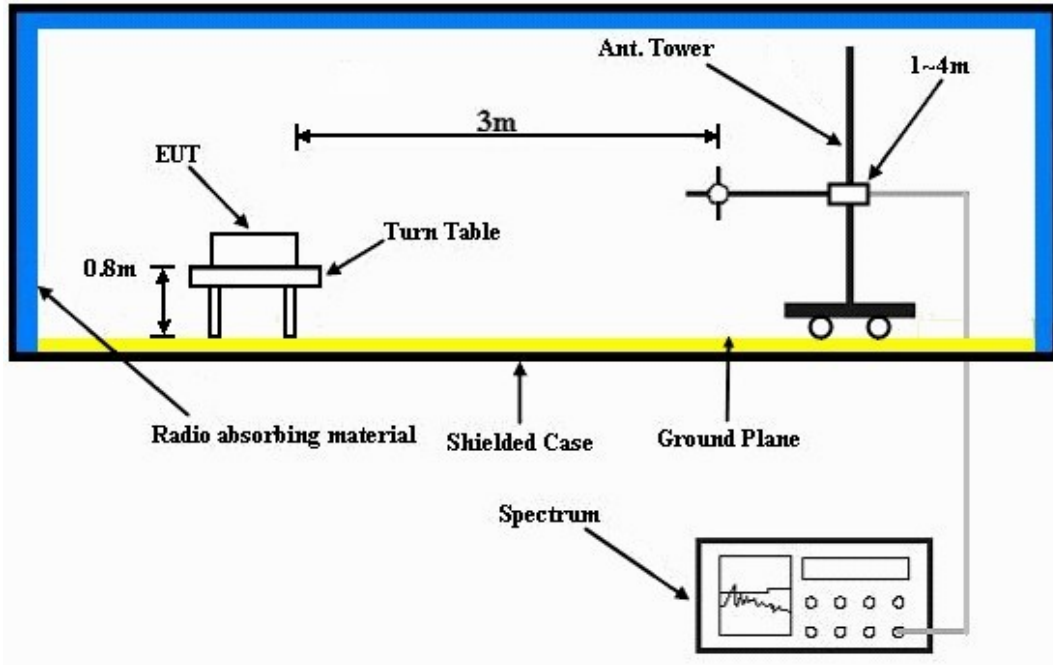

For the actual test configuration, please refer to the attached file (Test Setup Photo).

4.1.6 EUT OPERATING CONDITIONS

- a. Placed the EUT on a testing table.
- b. Use the software to control the EUT under transmission condition continuously at specific channel frequency.

4.1.7 TEST RESULTS

ABOVE 1GHz WORST-CASE DATA :

802.11b

EUT TEST CONDITION		MEASUREMENT DETAIL	
CHANNEL	Channel 1	FREQUENCY RANGE	1 ~ 25GHz
INPUT POWER (SYSTEM)	120Vac, 60 Hz	DETECTOR FUNCTION	Peak (PK) Average (AV)
ENVIRONMENTAL CONDITIONS	25deg. C, 65%RH	TESTED BY	Alan Wu

ANTENNA POLARITY & TEST DISTANCE: HORIZONTAL AT 3 M								
NO.	FREQ. (MHz)	EMISSION LEVEL (dBuV/m)	LIMIT (dBuV/m)	MARGIN (dB)	ANTENNA HEIGHT (m)	TABLE ANGLE (Degree)	RAW VALUE (dBuV)	CORRECTION FACTOR (dB/m)
1	2390.00	61.1 PK	74.0	-12.9	1.46 H	32	29.10	32.00
2	2390.00	48.0 AV	54.0	-6.0	1.46 H	32	16.00	32.00
3	*2412.00	102.3 PK			1.41 H	38	70.30	32.00
4	*2412.00	97.4 AV			1.41 H	38	65.40	32.00
5	4824.00	51.5 PK	74.0	-22.5	1.25 H	164	13.10	38.40
6	4824.00	43.6 AV	54.0	-10.4	1.25 H	164	5.20	38.40
ANTENNA POLARITY & TEST DISTANCE: VERTICAL AT 3 M								
NO.	FREQ. (MHz)	EMISSION LEVEL (dBuV/m)	LIMIT (dBuV/m)	MARGIN (dB)	ANTENNA HEIGHT (m)	TABLE ANGLE (Degree)	RAW VALUE (dBuV)	CORRECTION FACTOR (dB/m)
1	2390.00	60.2 PK	74.0	-13.8	1.00 V	92	28.20	32.00
2	2390.00	47.0 AV	54.0	-7.0	1.00 V	92	15.00	32.00
3	*2412.00	100.0 PK			1.00 V	91	68.00	32.00
4	*2412.00	95.2 AV			1.00 V	91	63.20	32.00
5	4824.00	52.6 PK	74.0	-21.4	1.00 V	46	14.20	38.40
6	4824.00	43.9 AV	54.0	-10.1	1.00 V	46	5.50	38.40

REMARKS:

1. Emission level (dBuV/m) = Raw Value (dBuV) + Correction Factor (dB/m).
2. Correction Factor (dB/m) = Antenna Factor (dB/m) + Cable Factor (dB).
3. The other emission levels were very low against the limit.
4. Margin value = Emission level – Limit value.
5. “ * “: Fundamental frequency.



A D T

EUT TEST CONDITION		MEASUREMENT DETAIL	
CHANNEL	Channel 6	FREQUENCY RANGE	1 ~ 25GHz
INPUT POWER (SYSTEM)	120Vac, 60 Hz	DETECTOR FUNCTION	Peak (PK) Average (AV)
ENVIRONMENTAL CONDITIONS	25deg. C, 65%RH	TESTED BY	Alan Wu

ANTENNA POLARITY & TEST DISTANCE: HORIZONTAL AT 3 M								
NO.	FREQ. (MHz)	EMISSION LEVEL (dBuV/m)	LIMIT (dBuV/m)	MARGIN (dB)	ANTENNA HEIGHT (m)	TABLE ANGLE (Degree)	RAW VALUE (dBuV)	CORRECTION FACTOR (dB/m)
1	2390.00	60.1 PK	74.0	-13.9	1.17 H	37	28.10	32.00
2	2390.00	47.0 AV	54.0	-7.0	1.17 H	37	15.00	32.00
3	*2437.00	103.0 PK			1.11 H	37	70.90	32.10
4	*2437.00	97.3 AV			1.11 H	37	65.20	32.10
5	4874.00	49.6 PK	74.0	-24.4	1.00 H	56	11.20	38.40
6	4874.00	41.1 AV	54.0	-12.9	1.00 H	56	2.70	38.40
ANTENNA POLARITY & TEST DISTANCE: VERTICAL AT 3 M								
NO.	FREQ. (MHz)	EMISSION LEVEL (dBuV/m)	LIMIT (dBuV/m)	MARGIN (dB)	ANTENNA HEIGHT (m)	TABLE ANGLE (Degree)	RAW VALUE (dBuV)	CORRECTION FACTOR (dB/m)
1	2390.00	59.2 PK	74.0	-14.8	1.00 V	105	27.20	32.00
2	2390.00	46.4 AV	54.0	-7.6	1.00 V	105	14.40	32.00
3	*2437.00	100.7 PK			1.00 V	102	68.60	32.10
4	*2437.00	96.0 AV			1.00 V	102	63.90	32.10
5	4874.00	50.6 PK	74.0	-23.4	1.27 V	165	12.20	38.40
6	4874.00	42.9 AV	54.0	-11.1	1.27 V	165	4.50	38.40

REMARKS:

1. Emission level (dBuV/m) = Raw Value (dBuV) + Correction Factor (dB/m).
2. Correction Factor (dB/m) = Antenna Factor (dB/m) + Cable Factor (dB).
3. The other emission levels were very low against the limit.
4. Margin value = Emission level – Limit value.
5. “ * “: Fundamental frequency.



A D T

EUT TEST CONDITION		MEASUREMENT DETAIL	
CHANNEL	Channel 11	FREQUENCY RANGE	1 ~ 25GHz
INPUT POWER (SYSTEM)	120Vac, 60 Hz	DETECTOR FUNCTION	Peak (PK) Average (AV)
ENVIRONMENTAL CONDITIONS	25deg. C, 65%RH	TESTED BY	Alan Wu

ANTENNA POLARITY & TEST DISTANCE: HORIZONTAL AT 3 M								
NO.	FREQ. (MHz)	EMISSION LEVEL (dBuV/m)	LIMIT (dBuV/m)	MARGIN (dB)	ANTENNA HEIGHT (m)	TABLE ANGLE (Degree)	RAW VALUE (dBuV)	CORRECTION FACTOR (dB/m)
1	*2462.00	101.2 PK			1.10 H	34	69.00	32.20
2	*2462.00	96.6 AV			1.10 H	34	64.40	32.20
3	2483.50	60.6 PK	74.0	-13.4	1.38 H	33	28.30	32.30
4	2483.50	49.5 AV	54.0	-4.5	1.38 H	33	17.20	32.30
5	4924.00	48.5 PK	74.0	-25.5	1.13 H	72	10.10	38.40
6	4924.00	40.2 AV	54.0	-13.8	1.13 H	72	1.80	38.40
ANTENNA POLARITY & TEST DISTANCE: VERTICAL AT 3 M								
NO.	FREQ. (MHz)	EMISSION LEVEL (dBuV/m)	LIMIT (dBuV/m)	MARGIN (dB)	ANTENNA HEIGHT (m)	TABLE ANGLE (Degree)	RAW VALUE (dBuV)	CORRECTION FACTOR (dB/m)
1	*2462.00	98.7 PK			1.00 V	104	66.50	32.20
2	*2462.00	94.0 AV			1.00 V	104	61.80	32.20
3	2483.50	59.6 PK	74.0	-14.4	1.00 V	101	27.30	32.30
4	2483.50	48.4 AV	54.0	-5.6	1.00 V	101	16.10	32.30
5	4924.00	49.3 PK	74.0	-24.7	1.08 V	171	10.90	38.40
6	4924.00	41.2 AV	54.0	-12.8	1.08 V	171	2.80	38.40

REMARKS:

1. Emission level (dBuV/m) = Raw Value (dBuV) + Correction Factor (dB/m).
2. Correction Factor (dB/m) = Antenna Factor (dB/m) + Cable Factor (dB).
3. The other emission levels were very low against the limit.
4. Margin value = Emission level – Limit value.
5. “ * “: Fundamental frequency.



A D T

802.11g

EUT TEST CONDITION		MEASUREMENT DETAIL	
CHANNEL	Channel 1	FREQUENCY RANGE	1 ~ 25GHz
INPUT POWER (SYSTEM)	120Vac, 60 Hz	DETECTOR FUNCTION	Peak (PK) Average (AV)
ENVIRONMENTAL CONDITIONS	25deg. C, 65%RH	TESTED BY	Alan Wu

ANTENNA POLARITY & TEST DISTANCE: HORIZONTAL AT 3 M								
NO.	FREQ. (MHz)	EMISSION LEVEL (dBuV/m)	LIMIT (dBuV/m)	MARGIN (dB)	ANTENNA HEIGHT (m)	TABLE ANGLE (Degree)	RAW VALUE (dBuV)	CORRECTION FACTOR (dB/m)
1	2390.00	64.2 PK	74.0	-9.8	1.43 H	45	32.20	32.00
2	2390.00	46.2 AV	54.0	-7.8	1.43 H	45	14.20	32.00
3	*2412.00	98.6 PK			1.41 H	36	66.60	32.00
4	*2412.00	87.0 AV			1.41 H	36	55.00	32.00
5	4824.00	46.2 PK	74.0	-27.8	1.00 H	19	7.80	38.40
6	4824.00	33.0 AV	54.0	-21.0	1.00 H	19	-5.40	38.40

ANTENNA POLARITY & TEST DISTANCE: VERTICAL AT 3 M								
NO.	FREQ. (MHz)	EMISSION LEVEL (dBuV/m)	LIMIT (dBuV/m)	MARGIN (dB)	ANTENNA HEIGHT (m)	TABLE ANGLE (Degree)	RAW VALUE (dBuV)	CORRECTION FACTOR (dB/m)
1	2390.00	63.6 PK	74.0	-10.4	1.00 V	97	31.60	32.00
2	2390.00	45.8 AV	54.0	-8.2	1.00 V	97	13.80	32.00
3	*2412.00	96.2 PK			1.00 V	91	64.20	32.00
4	*2412.00	84.7 AV			1.00 V	91	52.70	32.00
5	4824.00	47.8 PK	74.0	-26.2	1.08 V	129	9.40	38.40
6	4824.00	34.0 AV	54.0	-20.0	1.08 V	129	-4.40	38.40

REMARKS:

1. Emission level (dBuV/m) = Raw Value (dBuV) + Correction Factor (dB/m).
2. Correction Factor (dB/m) = Antenna Factor (dB/m) + Cable Factor (dB).
3. The other emission levels were very low against the limit.
4. Margin value = Emission level – Limit value.
5. “ * “: Fundamental frequency.



A D T

EUT TEST CONDITION		MEASUREMENT DETAIL	
CHANNEL	Channel 6	FREQUENCY RANGE	1 ~ 25GHz
INPUT POWER (SYSTEM)	120Vac, 60 Hz	DETECTOR FUNCTION	Peak (PK) Average (AV)
ENVIRONMENTAL CONDITIONS	25deg. C, 65%RH	TESTED BY	Alan Wu

ANTENNA POLARITY & TEST DISTANCE: HORIZONTAL AT 3 M								
NO.	FREQ. (MHz)	EMISSION LEVEL (dBuV/m)	LIMIT (dBuV/m)	MARGIN (dB)	ANTENNA HEIGHT (m)	TABLE ANGLE (Degree)	RAW VALUE (dBuV)	CORRECTION FACTOR (dB/m)
1	*2437.00	97.8 PK			1.43 H	37	65.70	32.10
2	*2437.00	86.3 AV			1.43 H	37	54.20	32.10
3	4874.00	45.8 PK	74.0	-28.2	1.00 H	17	7.40	38.40
4	4874.00	32.0 AV	54.0	-22.0	1.00 H	17	-6.40	38.40
5	7311.00	52.0 PK	74.0	-22.0	1.00 H	20	7.70	44.30
6	7311.00	38.4 AV	54.0	-15.6	1.00 H	20	-5.90	44.30
ANTENNA POLARITY & TEST DISTANCE: VERTICAL AT 3 M								
NO.	FREQ. (MHz)	EMISSION LEVEL (dBuV/m)	LIMIT (dBuV/m)	MARGIN (dB)	ANTENNA HEIGHT (m)	TABLE ANGLE (Degree)	RAW VALUE (dBuV)	CORRECTION FACTOR (dB/m)
1	*2437.00	95.5 PK			1.00 V	91	63.40	32.10
2	*2437.00	84.5 AV			1.00 V	91	52.40	32.10
3	4874.00	46.3 PK	74.0	-27.7	1.00 V	161	7.90	38.40
4	4874.00	33.0 AV	54.0	-21.0	1.00 V	161	-5.40	38.40
5	7311.00	53.0 PK	74.0	-21.0	1.00 V	116	8.70	44.30
6	7311.00	39.2 AV	54.0	-14.8	1.00 V	116	-5.10	44.30

REMARKS:

1. Emission level (dBuV/m) = Raw Value (dBuV) + Correction Factor (dB/m).
2. Correction Factor (dB/m) = Antenna Factor (dB/m) + Cable Factor (dB).
3. The other emission levels were very low against the limit.
4. Margin value = Emission level – Limit value.
5. “ * “: Fundamental frequency.



A D T

EUT TEST CONDITION		MEASUREMENT DETAIL	
CHANNEL	Channel 11	FREQUENCY RANGE	1 ~ 25GHz
INPUT POWER (SYSTEM)	120Vac, 60 Hz	DETECTOR FUNCTION	Peak (PK) Average (AV)
ENVIRONMENTAL CONDITIONS	25deg. C, 65%RH	TESTED BY	Alan Wu

ANTENNA POLARITY & TEST DISTANCE: HORIZONTAL AT 3 M								
NO.	FREQ. (MHz)	EMISSION LEVEL (dBuV/m)	LIMIT (dBuV/m)	MARGIN (dB)	ANTENNA HEIGHT (m)	TABLE ANGLE (Degree)	RAW VALUE (dBuV)	CORRECTION FACTOR (dB/m)
1	*2462.00	96.3 PK			1.10 H	38	64.10	32.20
2	*2462.00	85.4 AV			1.10 H	38	53.20	32.20
3	2483.50	59.1 PK	74.0	-14.9	1.41 H	36	26.80	32.30
4	2483.50	45.7 AV	54.0	-8.3	1.41 H	36	13.40	32.30
5	4924.00	44.3 PK	74.0	-29.7	1.00 H	10	5.90	38.40
6	4924.00	31.0 AV	54.0	-23.0	1.00 H	10	-7.40	38.40

ANTENNA POLARITY & TEST DISTANCE: VERTICAL AT 3 M								
NO.	FREQ. (MHz)	EMISSION LEVEL (dBuV/m)	LIMIT (dBuV/m)	MARGIN (dB)	ANTENNA HEIGHT (m)	TABLE ANGLE (Degree)	RAW VALUE (dBuV)	CORRECTION FACTOR (dB/m)
1	*2462.00	93.1 PK			1.00 V	128	60.90	32.20
2	*2462.00	81.8 AV			1.00 V	128	49.60	32.20
3	2483.50	58.0 PK	74.0	-16.0	1.00 V	128	25.70	32.30
4	2483.50	44.2 AV	54.0	-9.8	1.00 V	128	11.90	32.30
5	4924.00	45.7 PK	74.0	-28.3	1.00 V	118	7.30	38.40
6	4924.00	32.0 AV	54.0	-22.0	1.00 V	118	-6.40	38.40

REMARKS:

1. Emission level (dBuV/m) = Raw Value (dBuV) + Correction Factor (dB/m).
2. Correction Factor (dB/m) = Antenna Factor (dB/m) + Cable Factor (dB).
3. The other emission levels were very low against the limit.
4. Margin value = Emission level – Limit value.
5. “ * “: Fundamental frequency.



A D T

802.11n (20MHz)

EUT TEST CONDITION		MEASUREMENT DETAIL	
CHANNEL	Channel 1	FREQUENCY RANGE	1 ~ 25GHz
INPUT POWER (SYSTEM)	120Vac, 60 Hz	DETECTOR FUNCTION	Peak (PK) Average (AV)
ENVIRONMENTAL CONDITIONS	25deg. C, 65%RH	TESTED BY	Alan Wu

ANTENNA POLARITY & TEST DISTANCE: HORIZONTAL AT 3 M								
NO.	FREQ. (MHz)	EMISSION LEVEL (dBuV/m)	LIMIT (dBuV/m)	MARGIN (dB)	ANTENNA HEIGHT (m)	TABLE ANGLE (Degree)	RAW VALUE (dBuV)	CORRECTION FACTOR (dB/m)
1	2390.00	61.0 PK	74.0	-13.0	1.48 H	38	29.00	32.00
2	2390.00	46.1 AV	54.0	-7.9	1.48 H	38	14.10	32.00
3	*2412.00	97.7 PK			1.41 H	36	65.70	32.00
4	*2412.00	86.1 AV			1.41 H	36	54.10	32.00
5	4824.00	47.0 PK	74.0	-27.0	1.00 H	20	8.60	38.40
6	4824.00	33.5 AV	54.0	-20.5	1.00 H	20	-4.90	38.40
ANTENNA POLARITY & TEST DISTANCE: VERTICAL AT 3 M								
NO.	FREQ. (MHz)	EMISSION LEVEL (dBuV/m)	LIMIT (dBuV/m)	MARGIN (dB)	ANTENNA HEIGHT (m)	TABLE ANGLE (Degree)	RAW VALUE (dBuV)	CORRECTION FACTOR (dB/m)
1	2390.00	60.0 PK	74.0	-14.0	1.00 V	89	28.00	32.00
2	2390.00	45.7 AV	54.0	-8.3	1.00 V	89	13.70	32.00
3	*2412.00	96.2 PK			1.00 V	89	64.20	32.00
4	*2412.00	84.0 AV			1.00 V	89	52.00	32.00
5	4824.00	48.0 PK	74.0	-26.0	1.00 V	198	9.60	38.40
6	4824.00	34.8 AV	54.0	-19.2	1.00 V	198	-3.60	38.40

REMARKS:

1. Emission level (dBuV/m) = Raw Value (dBuV) + Correction Factor (dB/m).
2. Correction Factor (dB/m) = Antenna Factor (dB/m) + Cable Factor (dB).
3. The other emission levels were very low against the limit.
4. Margin value = Emission level – Limit value.
5. “ * “: Fundamental frequency.



A D T

EUT TEST CONDITION		MEASUREMENT DETAIL	
CHANNEL	Channel 6	FREQUENCY RANGE	1 ~ 25GHz
INPUT POWER (SYSTEM)	120Vac, 60 Hz	DETECTOR FUNCTION	Peak (PK) Average (AV)
ENVIRONMENTAL CONDITIONS	25deg. C, 65%RH	TESTED BY	Alan Wu

ANTENNA POLARITY & TEST DISTANCE: HORIZONTAL AT 3 M								
NO.	FREQ. (MHz)	EMISSION LEVEL (dBuV/m)	LIMIT (dBuV/m)	MARGIN (dB)	ANTENNA HEIGHT (m)	TABLE ANGLE (Degree)	RAW VALUE (dBuV)	CORRECTION FACTOR (dB/m)
1	*2437.00	97.5 PK			1.43 H	36	65.40	32.10
2	*2437.00	85.6 AV			1.43 H	36	53.50	32.10
3	4874.00	46.0 PK	74.0	-28.0	1.00 H	27	7.60	38.40
4	4874.00	32.8 AV	54.0	-21.2	1.00 H	27	-5.60	38.40
5	7311.00	51.0 PK	74.0	-23.0	1.00 H	29	6.70	44.30
6	7311.00	38.2 AV	54.0	-15.8	1.00 H	29	-6.10	44.30
ANTENNA POLARITY & TEST DISTANCE: VERTICAL AT 3 M								
NO.	FREQ. (MHz)	EMISSION LEVEL (dBuV/m)	LIMIT (dBuV/m)	MARGIN (dB)	ANTENNA HEIGHT (m)	TABLE ANGLE (Degree)	RAW VALUE (dBuV)	CORRECTION FACTOR (dB/m)
1	*2437.00	95.2 PK			1.00 V	91	63.10	32.10
2	*2437.00	83.8 AV			1.00 V	91	51.70	32.10
3	4874.00	47.0 PK	74.0	-27.0	1.00 V	131	8.60	38.40
4	4874.00	33.0 AV	54.0	-21.0	1.00 V	131	-5.40	38.40
5	7311.00	52.0 PK	74.0	-22.0	1.00 V	172	7.70	44.30
6	7311.00	39.0 AV	54.0	-15.0	1.00 V	172	-5.30	44.30

REMARKS:

1. Emission level (dBuV/m) = Raw Value (dBuV) + Correction Factor (dB/m).
2. Correction Factor (dB/m) = Antenna Factor (dB/m) + Cable Factor (dB).
3. The other emission levels were very low against the limit.
4. Margin value = Emission level – Limit value.
5. “ * “: Fundamental frequency.



A D T

EUT TEST CONDITION		MEASUREMENT DETAIL	
CHANNEL	Channel 11	FREQUENCY RANGE	1 ~ 25GHz
INPUT POWER (SYSTEM)	120Vac, 60 Hz	DETECTOR FUNCTION	Peak (PK) Average (AV)
ENVIRONMENTAL CONDITIONS	25deg. C, 65%RH	TESTED BY	Alan Wu

ANTENNA POLARITY & TEST DISTANCE: HORIZONTAL AT 3 M								
NO.	FREQ. (MHz)	EMISSION LEVEL (dBuV/m)	LIMIT (dBuV/m)	MARGIN (dB)	ANTENNA HEIGHT (m)	TABLE ANGLE (Degree)	RAW VALUE (dBuV)	CORRECTION FACTOR (dB/m)
1	*2462.00	96.1 PK			1.10 H	34	63.90	32.20
2	*2462.00	85.1 AV			1.10 H	34	52.90	32.20
3	2483.50	58.9 PK	74.0	-15.1	1.14 H	36	26.60	32.30
4	2483.50	45.2 AV	54.0	-8.8	1.14 H	36	12.90	32.30
5	4924.00	45.0 PK	74.0	-29.0	1.00 H	26	6.60	38.40
6	4924.00	32.0 AV	54.0	-22.0	1.00 H	26	-6.40	38.40

ANTENNA POLARITY & TEST DISTANCE: VERTICAL AT 3 M								
NO.	FREQ. (MHz)	EMISSION LEVEL (dBuV/m)	LIMIT (dBuV/m)	MARGIN (dB)	ANTENNA HEIGHT (m)	TABLE ANGLE (Degree)	RAW VALUE (dBuV)	CORRECTION FACTOR (dB/m)
1	*2462.00	93.1 PK			1.00 V	104	60.90	32.20
2	*2462.00	82.3 AV			1.00 V	104	50.10	32.20
3	2483.50	57.7 PK	74.0	-16.3	1.00 V	105	25.40	32.30
4	2483.50	44.7 AV	54.0	-9.3	1.00 V	105	12.40	32.30
5	4924.00	46.0 PK	74.0	-28.0	1.00 V	153	7.60	38.40
6	4924.00	33.0 AV	54.0	-21.0	1.00 V	153	-5.40	38.40

REMARKS:

1. Emission level (dBuV/m) = Raw Value (dBuV) + Correction Factor (dB/m).
2. Correction Factor (dB/m) = Antenna Factor (dB/m) + Cable Factor (dB).
3. The other emission levels were very low against the limit.
4. Margin value = Emission level – Limit value.
5. “ * “: Fundamental frequency.



A D T

802.11n (40MHz)

EUT TEST CONDITION		MEASUREMENT DETAIL	
CHANNEL	Channel 3	FREQUENCY RANGE	1 ~ 25GHz
INPUT POWER (SYSTEM)	120Vac, 60 Hz	DETECTOR FUNCTION	Peak (PK) Average (AV)
ENVIRONMENTAL CONDITIONS	25deg. C, 65%RH	TESTED BY	Alan Wu

ANTENNA POLARITY & TEST DISTANCE: HORIZONTAL AT 3 M								
NO.	FREQ. (MHz)	EMISSION LEVEL (dBuV/m)	LIMIT (dBuV/m)	MARGIN (dB)	ANTENNA HEIGHT (m)	TABLE ANGLE (Degree)	RAW VALUE (dBuV)	CORRECTION FACTOR (dB/m)
1	2390.00	66.8 PK	74.0	-7.2	1.42 H	45	34.80	32.00
2	2390.00	48.7 AV	54.0	-5.3	1.42 H	45	16.70	32.00
3	*2422.00	94.1 PK			1.41 H	35	62.00	32.10
4	*2422.00	81.8 AV			1.41 H	35	49.70	32.10
5	4844.00	46.2 PK	74.0	-27.8	1.00 H	19	7.80	38.40
6	4844.00	33.1 AV	54.0	-20.9	1.00 H	19	-5.30	38.40
ANTENNA POLARITY & TEST DISTANCE: VERTICAL AT 3 M								
NO.	FREQ. (MHz)	EMISSION LEVEL (dBuV/m)	LIMIT (dBuV/m)	MARGIN (dB)	ANTENNA HEIGHT (m)	TABLE ANGLE (Degree)	RAW VALUE (dBuV)	CORRECTION FACTOR (dB/m)
1	2390.00	65.4 PK	74.0	-8.6	1.00 V	84	33.40	32.00
2	2390.00	47.5 AV	54.0	-6.5	1.00 V	84	15.50	32.00
3	*2422.00	91.8 PK			1.00 V	89	59.70	32.10
4	*2422.00	79.7 AV			1.00 V	89	47.60	32.10
5	4844.00	47.8 PK	74.0	-26.2	1.00 V	149	9.40	38.40
6	4844.00	34.4 AV	54.0	-19.6	1.00 V	149	-4.00	38.40

REMARKS:

1. Emission level (dBuV/m) = Raw Value (dBuV) + Correction Factor (dB/m).
2. Correction Factor (dB/m) = Antenna Factor (dB/m) + Cable Factor (dB).
3. The other emission levels were very low against the limit.
4. Margin value = Emission level – Limit value.
5. “ * “: Fundamental frequency.



A D T

EUT TEST CONDITION		MEASUREMENT DETAIL	
CHANNEL	Channel 6	FREQUENCY RANGE	1 ~ 25GHz
INPUT POWER (SYSTEM)	120Vac, 60 Hz	DETECTOR FUNCTION	Peak (PK) Average (AV)
ENVIRONMENTAL CONDITIONS	25deg. C, 65%RH	TESTED BY	Alan Wu

ANTENNA POLARITY & TEST DISTANCE: HORIZONTAL AT 3 M								
NO.	FREQ. (MHz)	EMISSION LEVEL (dBuV/m)	LIMIT (dBuV/m)	MARGIN (dB)	ANTENNA HEIGHT (m)	TABLE ANGLE (Degree)	RAW VALUE (dBuV)	CORRECTION FACTOR (dB/m)
1	*2437.00	94.1 PK			1.39 H	38	62.00	32.10
2	*2437.00	81.6 AV			1.39 H	38	49.50	32.10
3	4874.00	46.5 PK	74.0	-27.5	1.00 H	15	8.10	38.40
4	4874.00	33.8 AV	54.0	-20.2	1.00 H	15	-4.60	38.40
5	7311.00	50.0 PK	74.0	-24.0	1.00 H	23	5.70	44.30
6	7311.00	38.0 AV	54.0	-16.0	1.00 H	23	-6.30	44.30
ANTENNA POLARITY & TEST DISTANCE: VERTICAL AT 3 M								
NO.	FREQ. (MHz)	EMISSION LEVEL (dBuV/m)	LIMIT (dBuV/m)	MARGIN (dB)	ANTENNA HEIGHT (m)	TABLE ANGLE (Degree)	RAW VALUE (dBuV)	CORRECTION FACTOR (dB/m)
1	*2437.00	91.9 PK			1.00 V	90	59.80	32.10
2	*2437.00	79.2 AV			1.00 V	90	47.10	32.10
3	4874.00	47.1 PK	74.0	-26.9	1.00 V	159	8.70	38.40
4	4874.00	34.1 AV	54.0	-19.9	1.00 V	159	-4.30	38.40
5	7311.00	51.0 PK	74.0	-23.0	1.00 V	195	6.70	44.30
6	7311.00	39.0 AV	54.0	-15.0	1.00 V	195	-5.30	44.30

REMARKS:

1. Emission level (dBuV/m) = Raw Value (dBuV) + Correction Factor (dB/m).
2. Correction Factor (dB/m) = Antenna Factor (dB/m) + Cable Factor (dB).
3. The other emission levels were very low against the limit.
4. Margin value = Emission level – Limit value.
5. “ * “: Fundamental frequency.



A D T

EUT TEST CONDITION		MEASUREMENT DETAIL	
CHANNEL	Channel 9	FREQUENCY RANGE	1 ~ 25GHz
INPUT POWER (SYSTEM)	120Vac, 60 Hz	DETECTOR FUNCTION	Peak (PK) Average (AV)
ENVIRONMENTAL CONDITIONS	25deg. C, 65%RH	TESTED BY	Alan Wu

ANTENNA POLARITY & TEST DISTANCE: HORIZONTAL AT 3 M								
NO.	FREQ. (MHz)	EMISSION LEVEL (dBuV/m)	LIMIT (dBuV/m)	MARGIN (dB)	ANTENNA HEIGHT (m)	TABLE ANGLE (Degree)	RAW VALUE (dBuV)	CORRECTION FACTOR (dB/m)
1	*2452.00	93.9 PK			1.12 H	35	61.70	32.20
2	*2452.00	81.0 AV			1.12 H	35	48.80	32.20
3	2483.50	61.8 PK	74.0	-12.2	1.10 H	34	29.50	32.30
4	2483.50	47.1 AV	54.0	-6.9	1.10 H	34	14.80	32.30
5	4904.00	45.8 PK	74.0	-28.2	1.00 H	14	7.30	38.50
6	4904.00	32.4 AV	54.0	-21.6	1.00 H	14	-6.10	38.50
ANTENNA POLARITY & TEST DISTANCE: VERTICAL AT 3 M								
NO.	FREQ. (MHz)	EMISSION LEVEL (dBuV/m)	LIMIT (dBuV/m)	MARGIN (dB)	ANTENNA HEIGHT (m)	TABLE ANGLE (Degree)	RAW VALUE (dBuV)	CORRECTION FACTOR (dB/m)
1	*2452.00	91.4 PK			1.00 V	115	59.20	32.20
2	*2452.00	78.8 AV			1.00 V	115	46.60	32.20
3	2483.50	60.9 PK	74.0	-13.1	1.00 V	116	28.60	32.30
4	2483.50	46.8 AV	54.0	-7.2	1.00 V	116	14.50	32.30
5	4904.00	46.3 PK	74.0	-27.7	1.00 V	164	7.80	38.50
6	4904.00	33.6 AV	54.0	-20.4	1.00 V	164	-4.90	38.50

REMARKS:

1. Emission level (dBuV/m) = Raw Value (dBuV) + Correction Factor (dB/m).
2. Correction Factor (dB/m) = Antenna Factor (dB/m) + Cable Factor (dB).
3. The other emission levels were very low against the limit.
4. Margin value = Emission level – Limit value.
5. “ * “: Fundamental frequency.

BELOW 1GHz WORST-CASE DATA : 802.11g

EUT TEST CONDITION		MEASUREMENT DETAIL	
CHANNEL	Channel 11	FREQUENCY RANGE	Below 1000MHz
INPUT POWER (SYSTEM)	120Vac, 60 Hz	DETECTOR FUNCTION	Quasi-Peak
ENVIRONMENTAL CONDITIONS	25deg. C, 65%RH	TESTED BY	Alan Wu

ANTENNA POLARITY & TEST DISTANCE: HORIZONTAL AT 3 M								
NO.	FREQ. (MHz)	EMISSION LEVEL (dBuV/m)	LIMIT (dBuV/m)	MARGIN (dB)	ANTENNA HEIGHT (m)	TABLE ANGLE (Degree)	RAW VALUE (dBuV)	CORRECTION FACTOR (dB/m)
1	68.71	21.4 QP	40.0	-18.6	1.75 H	282	8.90	12.50
2	181.25	27.1 QP	43.5	-16.4	1.24 H	256	14.20	12.90
3	225.88	31.1 QP	46.0	-14.9	1.49 H	186	18.50	12.60
4	251.11	28.1 QP	46.0	-17.9	1.24 H	66	14.40	13.70
5	480.07	22.2 QP	46.0	-23.8	1.00 H	199	1.60	20.60
6	691.58	25.0 QP	46.0	-21.0	2.00 H	6	0.70	24.30

ANTENNA POLARITY & TEST DISTANCE: VERTICAL AT 3 M								
NO.	FREQ. (MHz)	EMISSION LEVEL (dBuV/m)	LIMIT (dBuV/m)	MARGIN (dB)	ANTENNA HEIGHT (m)	TABLE ANGLE (Degree)	RAW VALUE (dBuV)	CORRECTION FACTOR (dB/m)
1	68.71	24.2 QP	40.0	-15.8	1.24 V	192	11.70	12.50
2	142.44	24.1 QP	43.5	-19.4	1.00 V	140	10.10	14.00
3	173.49	24.3 QP	43.5	-19.2	1.24 V	127	10.60	13.70
4	220.06	28.1 QP	46.0	-17.9	1.75 V	97	15.80	12.30
5	256.93	28.1 QP	46.0	-17.9	1.00 V	140	14.20	13.90
6	738.15	25.0 QP	46.0	-21.0	3.00 V	15	-0.40	25.40

REMARKS:

1. Emission level (dBuV/m) = Raw Value (dBuV) + Correction Factor (dB/m).
2. Correction Factor (dB/m) = Antenna Factor (dB/m) + Cable Factor (dB).
3. The other emission levels were very low against the limit.
4. Margin value = Emission level – Limit value.

4.2 CONDUCTED EMISSION MEASUREMENT

4.2.1 LIMITS OF CONDUCTED EMISSION MEASUREMENT

FREQUENCY OF EMISSION (MHz)	CONDUCTED LIMIT (dB μ V)	
	Quasi-peak	Average
0.15 ~ 0.5	66 to 56	56 to 46
0.5 ~ 5	56	46
5 ~ 30	60	50

- NOTE:**
1. The lower limit shall apply at the transition frequencies.
 2. The limit decreases in line with the logarithm of the frequency in the range of 0.15 to 0.50MHz.
 3. All emanations from a class A/B digital device or system, including any network of conductors and apparatus connected thereto, shall not exceed the level of field strengths specified above.

4.2.2 TEST INSTRUMENTS

DESCRIPTION & MANUFACTURER	MODEL NO.	SERIAL NO.	DATE OF CALIBRATION	DUE DATE OF CALIBRATION
Test Receiver ROHDE & SCHWARZ	ESCS30	100289	Nov. 19, 2011	Nov. 18, 2012
RF signal cable Woken	5D-FB	Cable-HYCO2-01	Dec. 29, 2011	Dec. 28, 2012
LISN ROHDE & SCHWARZ (EUT)	ESH2-Z5	100100	Dec. 30, 2011	Dec. 29, 2012
LISN ROHDE & SCHWARZ (Peripheral)	ESH3-Z5	100311	Jul. 06, 2012	Jul. 05, 2013
Software ADT	BV ADT_Cond_ V7.3.7.3	NA	NA	NA

- NOTE:**
1. The calibration interval of the above test instruments is 12 months and the calibrations are traceable to NML/ROC and NIST/USA.
 2. The test was performed in HwaYa Shielded Room 2.
 3. The VCCI Site Registration No. is C-2047.

4.2.3 TEST PROCEDURES

- a. The EUT was placed 0.4 meters from the conducting wall of the shielded room with EUT being connected to the power mains through a line impedance stabilization network (LISN). Other support units were connected to the power mains through another LISN. The two LISNs provide 50 ohm/ 50uH of coupling impedance for the measuring instrument.
- b. Both lines of the power mains connected to the EUT were checked for maximum conducted interference.
- c. The frequency range from 150kHz to 30MHz was searched. Emission levels under (Limit - 20dB) was not recorded.

NOTE: All modes of operation were investigated and the worst-case emissions are reported.

4.2.4 DEVIATION FROM TEST STANDARD

No deviation.

4.2.5 TEST SETUP

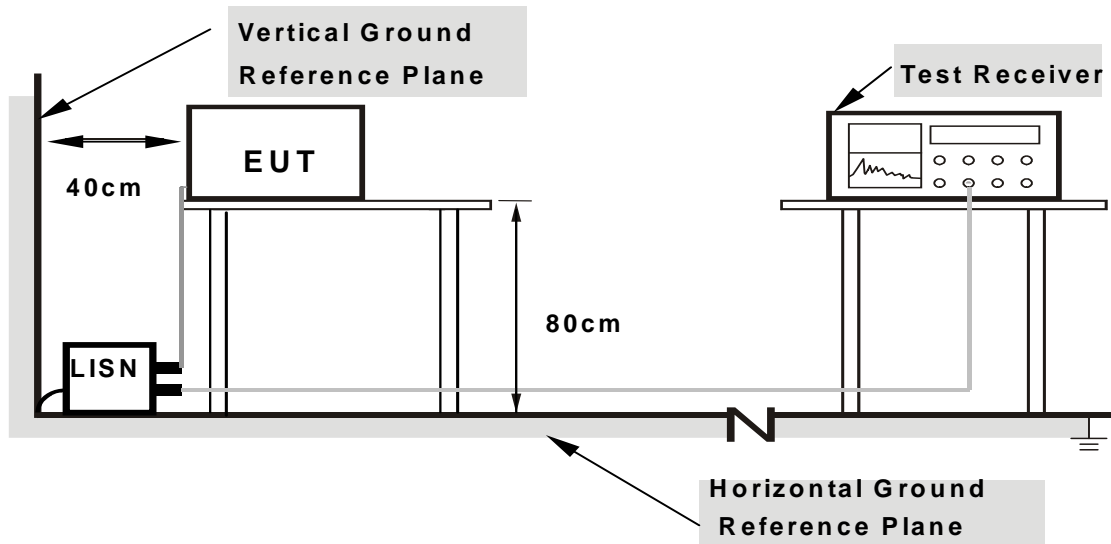

- Note:**
1. Support units were connected to second LISN.
 2. Both of LISNs (AMN) are 80 cm from EUT and at least 80 from other units and other metal planes

For the actual test configuration, please refer to the attached file (Test Setup Photo).

4.2.6 EUT OPERATING CONDITIONS

Same as 4.1.6.

4.2.7 TEST RESULTS

CONDUCTED WORST-CASE DATA : 802.11g

PHASE	Line 1	6dB BANDWIDTH	9kHz
-------	--------	---------------	------

No	Freq. [MHz]	Corr. Factor (dB)	Reading Value		Emission Level		Limit		Margin	
			[dB (uV)]		[dB (uV)]		[dB (uV)]		(dB)	
			Q.P.	AV.	Q.P.	AV.	Q.P.	AV.	Q.P.	AV.
1	0.25547	0.16	52.08	36.93	52.24	37.09	61.58	51.58	-9.34	-14.49
2	0.38828	0.17	50.32	31.30	50.49	31.47	58.10	48.10	-7.61	-16.63
3	0.52500	0.17	47.76	28.09	47.93	28.26	56.00	46.00	-8.07	-17.74
4	0.67344	0.18	45.76	22.75	45.94	22.93	56.00	46.00	-10.06	-23.07
5	2.45703	0.28	44.58	27.15	44.86	27.43	56.00	46.00	-11.14	-18.57
6	13.56250	0.50	66.42	59.81	66.92	60.31	60.00	50.00	6.92	10.31

REMARKS:

1. Q.P. and AV. are abbreviations of quasi-peak and average individually.
2. The emission levels of other frequencies were very low against the limit.
3. Margin value = Emission level - Limit value
4. Correction factor = Insertion loss + Cable loss
5. Emission Level = Correction Factor + Reading Value.

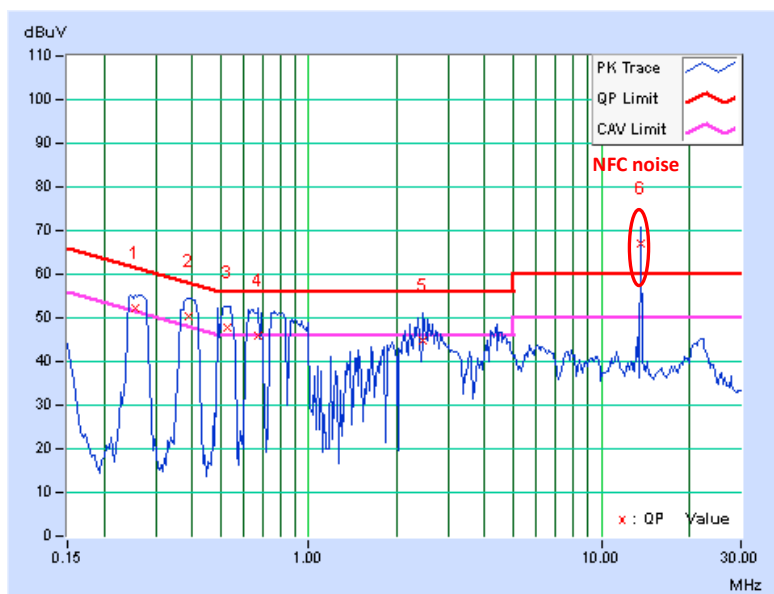

PHASE	Line 2	6dB BANDWIDTH	9kHz
-------	--------	---------------	------

No	Freq. [MHz]	Corr. Factor (dB)	Reading Value		Emission Level		Limit		Margin	
			[dB (uV)]		[dB (uV)]		[dB (uV)]		(dB)	
			Q.P.	AV.	Q.P.	AV.	Q.P.	AV.	Q.P.	AV.
1	0.27109	0.15	50.95	34.04	51.10	34.19	61.08	51.08	-9.99	-16.90
2	0.38438	0.16	49.86	30.78	50.02	30.94	58.18	48.18	-8.17	-17.25
3	0.52109	0.17	47.48	27.89	47.65	28.06	56.00	46.00	-8.35	-17.94
4	0.65391	0.17	45.82	23.34	45.99	23.51	56.00	46.00	-10.01	-22.49
5	2.51172	0.28	43.71	24.19	43.99	24.47	56.00	46.00	-12.01	-21.53
6	13.56250	0.57	66.87	60.13	67.44	60.70	60.00	50.00	7.44	10.70

REMARKS:

1. Q.P. and AV. are abbreviations of quasi-peak and average individually.
2. The emission levels of other frequencies were very low against the limit.
3. Margin value = Emission level - Limit value
4. Correction factor = Insertion loss + Cable loss
5. Emission Level = Correction Factor + Reading Value.

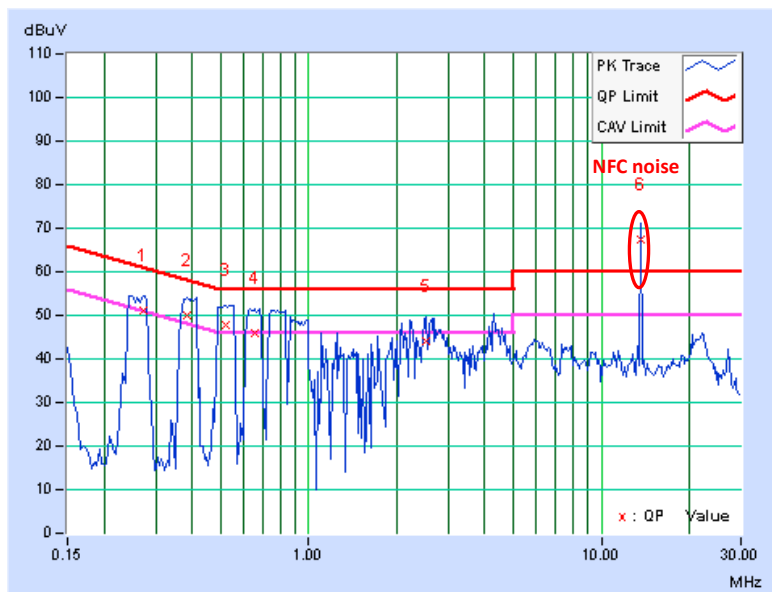

Test with suitable dummy load

PHASE	Line 1	6dB BANDWIDTH	9kHz
--------------	--------	----------------------	------

No	Freq. [MHz]	Corr. Factor (dB)	Reading Value		Emission Level		Limit		Margin	
			[dB (uV)]		[dB (uV)]		[dB (uV)]		(dB)	
			Q.P.	AV.	Q.P.	AV.	Q.P.	AV.	Q.P.	AV.
1	0.27109	0.16	54.94	37.20	55.10	37.36	61.08	51.08	-5.99	-13.73
2	0.37656	0.17	50.79	33.32	50.96	33.49	58.35	48.35	-7.40	-14.87
3	0.54453	0.17	48.58	28.94	48.75	29.11	56.00	46.00	-7.25	-16.89
4	0.62656	0.18	44.00	24.07	44.18	24.25	56.00	46.00	-11.82	-21.75
5	2.21875	0.27	43.83	23.91	44.10	24.18	56.00	46.00	-11.90	-21.82
6	22.85547	0.60	34.07	22.79	34.67	23.39	60.00	50.00	-25.33	-26.61

REMARKS:

1. Q.P. and AV. are abbreviations of quasi-peak and average individually.
2. The emission levels of other frequencies were very low against the limit.
3. Margin value = Emission level - Limit value
4. Correction factor = Insertion loss + Cable loss
5. Emission Level = Correction Factor + Reading Value.

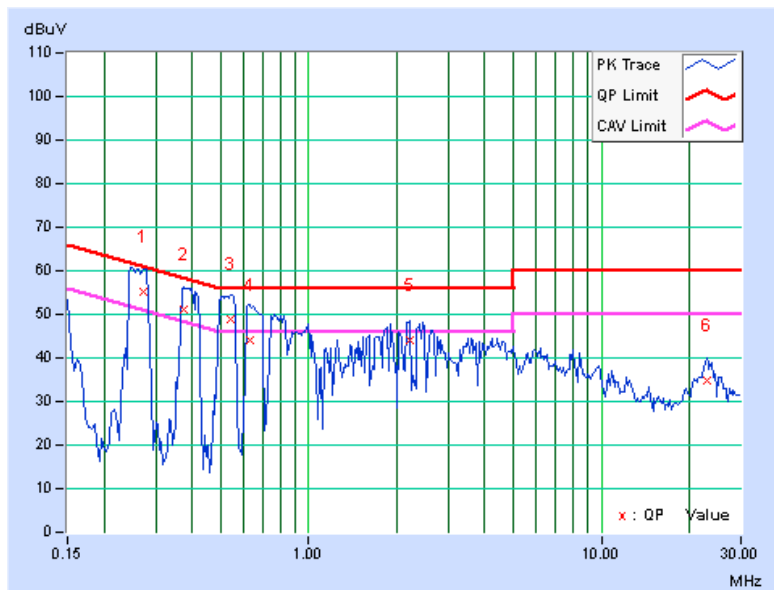

PHASE	Line 2	6dB BANDWIDTH	9kHz
-------	--------	---------------	------

No	Freq. [MHz]	Corr. Factor (dB)	Reading Value		Emission Level		Limit		Margin	
			[dB (uV)]		[dB (uV)]		[dB (uV)]		(dB)	
			Q.P.	AV.	Q.P.	AV.	Q.P.	AV.	Q.P.	AV.
1	0.25938	0.15	53.45	36.97	53.60	37.12	61.45	51.45	-7.86	-14.34
2	0.39609	0.16	48.19	30.28	48.35	30.44	57.93	47.93	-9.59	-17.50
3	0.55625	0.17	43.86	21.24	44.03	21.41	56.00	46.00	-11.97	-24.59
4	0.76328	0.18	41.20	22.84	41.38	23.02	56.00	46.00	-14.62	-22.98
5	2.36328	0.28	41.69	21.12	41.97	21.40	56.00	46.00	-14.03	-24.60
6	22.91797	0.67	33.69	22.08	34.36	22.75	60.00	50.00	-25.64	-27.25

REMARKS:

1. Q.P. and AV. are abbreviations of quasi-peak and average individually.
2. The emission levels of other frequencies were very low against the limit.
3. Margin value = Emission level - Limit value
4. Correction factor = Insertion loss + Cable loss
5. Emission Level = Correction Factor + Reading Value.

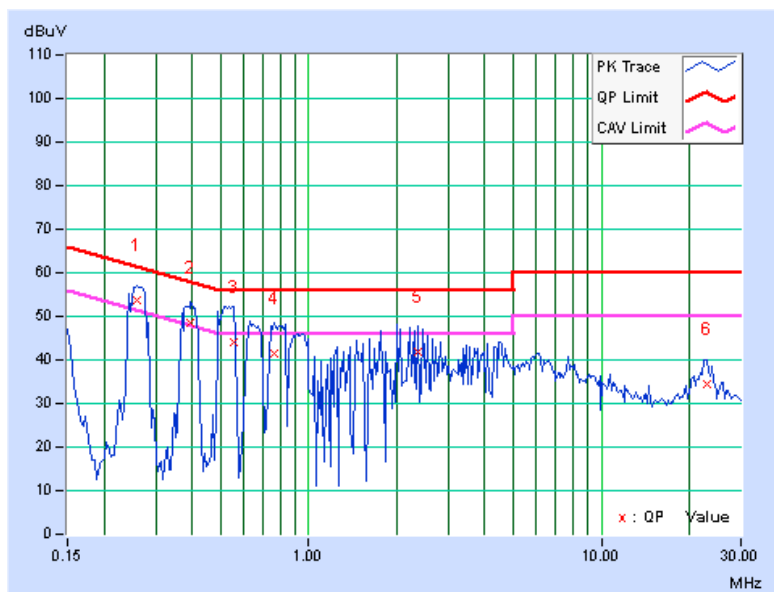

4.3 6dB BANDWIDTH MEASUREMENT

4.3.1 LIMITS OF 6dB BANDWIDTH MEASUREMENT

The minimum of 6dB Bandwidth Measurement is 0.5 MHz.

4.3.2 TEST SETUP

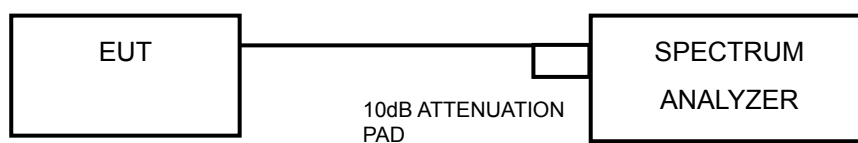

4.3.3 TEST INSTRUMENTS

Refer to section 4.1.2 to get information of above instrument.

4.3.4 TEST PROCEDURE

- Set resolution bandwidth (RBW) = approximately 1% of the emission bandwidth
- Set the video bandwidth (VBW) $\geq 3 \times$ RBW, Detector = Peak.
- Trace mode = max hold.
- Sweep = auto couple.
- Measure the maximum width of the emission that is constrained by the frequencies associated with the two amplitude points (upper and lower) that are attenuated by 6 dB relative to the maximum level measured in the fundamental emission

4.3.5 DEVIATION FROM TEST STANDARD

No deviation.

4.3.6 EUT OPERATING CONDITIONS

The software provided by client to enable the EUT under transmission condition continuously at lowest, middle and highest channel frequencies individually.



4.3.7 TEST RESULTS

802.11b

CHANNEL	FREQUENCY (MHz)	6dB BANDWIDTH (MHz)	MINIMUM LIMIT (MHz)	PASS / FAIL
1	2412	8.60	0.5	PASS
6	2437	9.05	0.5	PASS
11	2462	8.12	0.5	PASS

802.11g

CHANNEL	FREQUENCY (MHz)	6dB BANDWIDTH (MHz)	MINIMUM LIMIT (MHz)	PASS / FAIL
1	2412	16.56	0.5	PASS
6	2437	16.59	0.5	PASS
11	2462	16.57	0.5	PASS

802.11n (20MHz)

CHANNEL	FREQUENCY (MHz)	6dB BANDWIDTH (MHz)	MINIMUM LIMIT (MHz)	PASS / FAIL
1	2412	17.80	0.5	PASS
6	2437	17.81	0.5	PASS
11	2462	17.80	0.5	PASS

802.11n (40MHz)

CHANNEL	FREQUENCY (MHz)	6dB BANDWIDTH (MHz)	MINIMUM LIMIT (MHz)	PASS / FAIL
3	2422	36.25	0.5	PASS
6	2437	35.98	0.5	PASS
9	2452	36.26	0.5	PASS

4.4 CONDUCTED OUTPUT POWER

4.4.1 LIMITS OF CONDUCTED OUTPUT POWER MEASUREMENT

For systems using digital modulation in the 2400–2483.5 MHz bands: 1 Watt (30dBm)

4.4.2 TEST SETUP

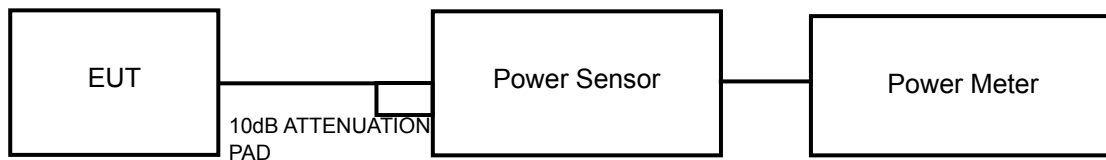

4.4.3 TEST INSTRUMENTS

Refer to section 4.1.2 to get information of above instrument.

4.4.4 TEST PROCEDURES

A peak power sensor was used on the output port of the EUT. A power meter was used to read the response of the peak power sensor. Record the peak power level.

4.4.5 DEVIATION FROM TEST STANDARD

No deviation.

4.4.6 EUT OPERATING CONDITIONS

Same as Item 4.3.6.



4.4.7 TEST RESULTS

802.11b

CHANNEL	FREQUENCY (MHz)	PEAK POWER (mW)	PEAK POWER (dBm)	LIMIT (dBm)	PASS/FAIL
1	2412	102.802	20.12	30	PASS
6	2437	112.980	20.53	30	PASS
11	2462	110.154	20.42	30	PASS

802.11g

CHANNEL	FREQUENCY (MHz)	PEAK POWER (mW)	PEAK POWER (dBm)	LIMIT (dBm)	PASS/FAIL
1	2412	122.744	20.89	30	PASS
6	2437	131.220	21.18	30	PASS
11	2462	132.739	21.23	30	PASS

802.11n (20MHz)

CHANNEL	FREQUENCY (MHz)	PEAK POWER (mW)	PEAK POWER (dBm)	LIMIT (dBm)	PASS/FAIL
1	2412	112.460	20.51	30	PASS
6	2437	123.880	20.93	30	PASS
11	2462	130.017	21.14	30	PASS

802.11n (40MHz)

CHANNEL	FREQUENCY (MHz)	PEAK POWER (mW)	PEAK POWER (dBm)	LIMIT (dBm)	PASS/FAIL
3	2422	120.226	20.80	30	PASS
6	2437	127.350	21.05	30	PASS
9	2452	128.825	21.10	30	PASS

4.5 POWER SPECTRAL DENSITY MEASUREMENT

4.5.1 LIMITS OF POWER SPECTRAL DENSITY MEASUREMENT

The Maximum of Power Spectral Density Measurement is 8dBm.

4.5.2 TEST SETUP

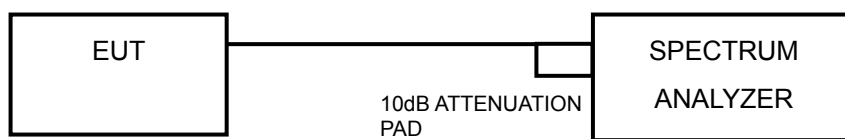

4.5.3 TEST INSTRUMENTS

Refer to section 4.1.2 to get information of above instrument.

4.5.4 TEST PROCEDURE

- a. Set the RBW = 100 kHz, VBW = 300 kHz, Detector = peak.
- b. Sweep time = auto couple, Trace mode = max hold, allow trace to fully stabilize.
- c. Use the peak marker function to determine the maximum power level in any 100 kHz band segment within the fundamental EBW.
- d. Scale the observed power level to an equivalent value in 3 kHz by adjusting (reducing) the measured power by a bandwidth correction factor (BWCF) where $BWCF = 10\log(3 \text{ kHz}/100\text{kHz})$

4.5.5 DEVIATION FROM TEST STANDARD

No deviation.

4.5.6 EUT OPERATING CONDITION

Same as Item 4.3.6



4.5.7 TEST RESULTS

802.11b

Channel	FREQ. (MHz)	PSD (dBm/100kHz)	PSD (dBm/3kHz)	Limit (dBm/3kHz)	PASS /FAIL
1	2412	9.08	-6.15	8	PASS
6	2437	9.49	-5.74	8	PASS
11	2462	9.37	-5.86	8	PASS

802.11g

Channel	FREQ. (MHz)	PSD (dBm/100kHz)	PSD (dBm/3kHz)	Limit (dBm/3kHz)	PASS /FAIL
1	2412	1.19	-14.04	8	PASS
6	2437	1.15	-14.08	8	PASS
11	2462	0.63	-14.60	8	PASS

802.11n (20MHz)

Channel	FREQ. (MHz)	PSD (dBm/100kHz)	PSD (dBm/3kHz)	Limit (dBm/3kHz)	PASS /FAIL
1	2412	0.16	-15.07	8	PASS
6	2437	0.14	-15.09	8	PASS
11	2462	-0.31	-15.54	8	PASS

802.11n (40MHz)

Channel	FREQ. (MHz)	PSD (dBm/100kHz)	PSD (dBm/3kHz)	Limit (dBm/3kHz)	PASS /FAIL
3	2422	-1.76	-16.99	8	PASS
6	2437	-2.02	-17.25	8	PASS
9	2452	-2.28	-17.51	8	PASS

4.6 CONDUCTED OUT OF BAND EMISSION MEASUREMENT

4.6.1 LIMITS OF CONDUCTED OUT OF BAND EMISSION MEASUREMENT

Below -20dB of the highest emission level of operating band (in 100kHz Resolution Bandwidth).

4.6.2 TEST SETUP

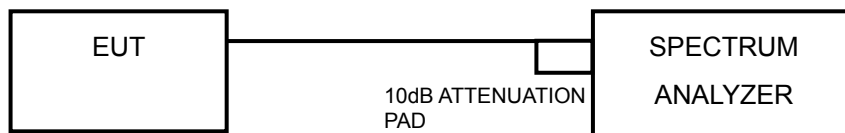

4.6.3 TEST INSTRUMENTS

Refer to section 4.1.2 to get information of above instrument.

4.6.4 TEST PROCEDURE

MEASUREMENT PROCEDURE REF

1. Set the RBW = 100 kHz.
2. Set the VBW \geq 300 kHz.
3. Detector = peak.
4. Sweep time = auto couple.
5. Trace mode = max hold.
6. Allow trace to fully stabilize.
7. Use the peak marker function to determine the maximum power level in any 100 kHz band segment within the fundamental EBW.

MEASUREMENT PROCEDURE OOB

1. Set RBW = 100 kHz.
2. Set VBW \geq 300 kHz.
3. Set span to encompass the spectrum to be examined.
4. Detector = peak.
5. Trace Mode = max hold.
6. Sweep = auto couple.

4.6.5 DEVIATION FROM TEST STANDARD

No deviation.

4.6.6 EUT OPERATING CONDITION

Same as Item 4.3.6

4.6.7 TEST RESULTS

The spectrum plots are attached on the following pages. D1 line indicates the highest level, and D2 line indicates the 20dB offset below D1. It shows compliance with the requirement.



A D T

802.11b

CH 1

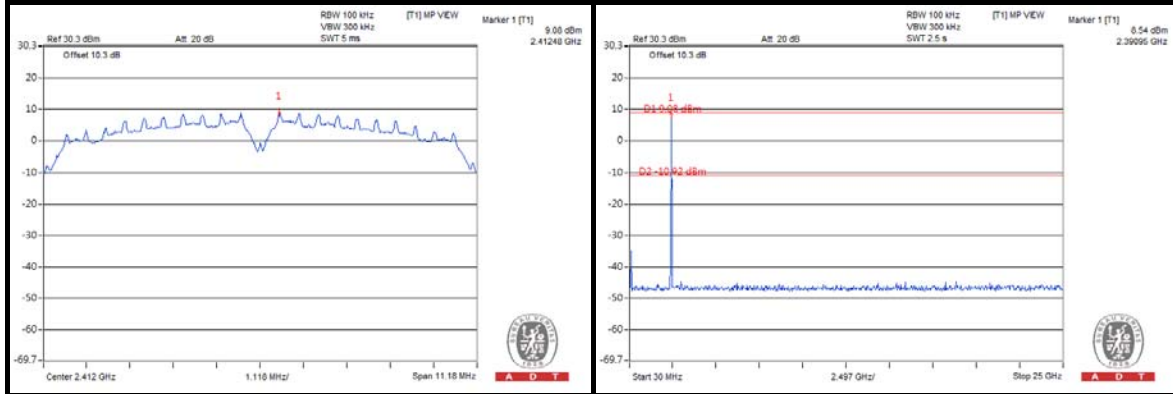

CH 6

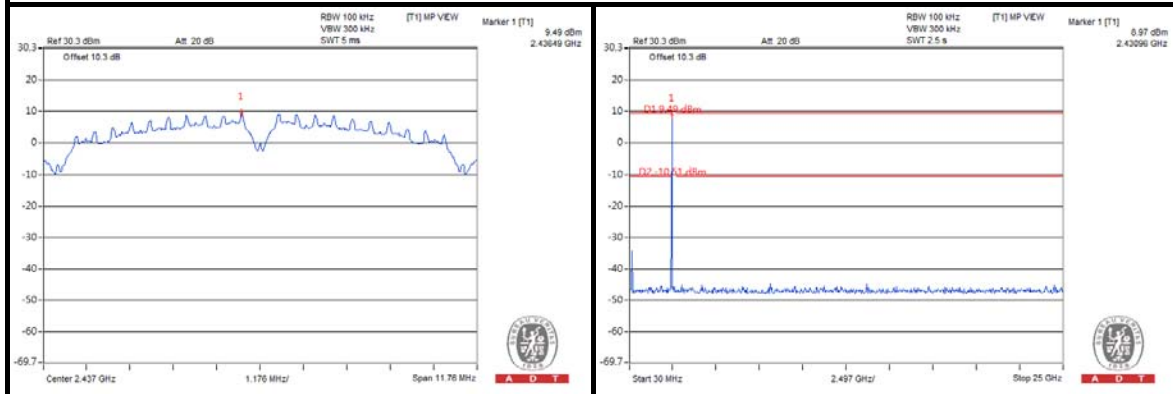

CH 11

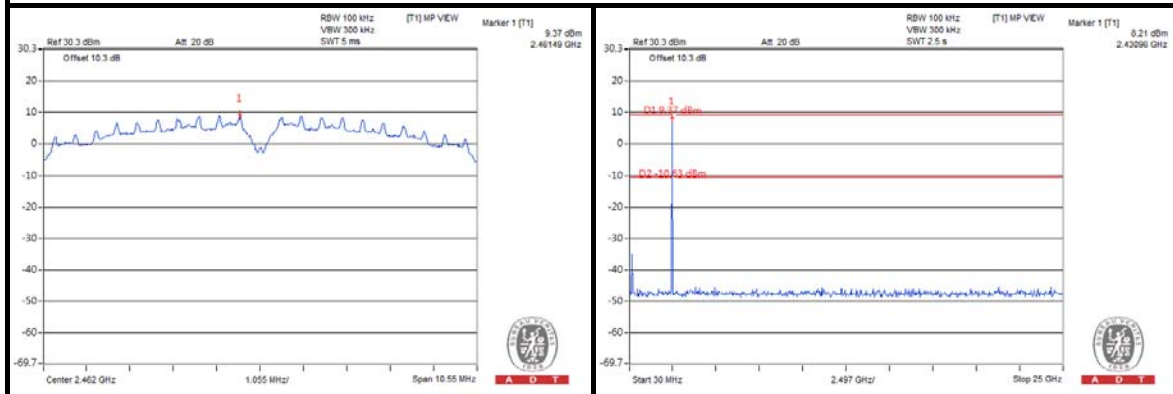



A D T

802.11g

CH 1

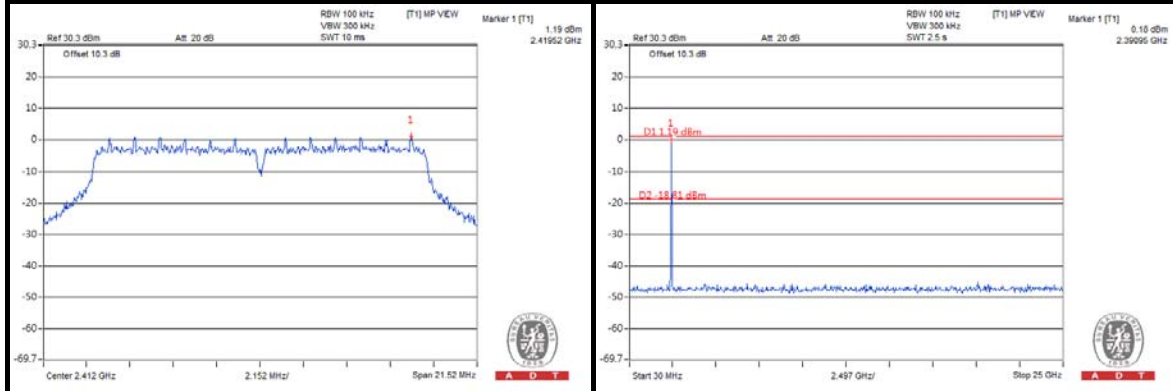

CH 6

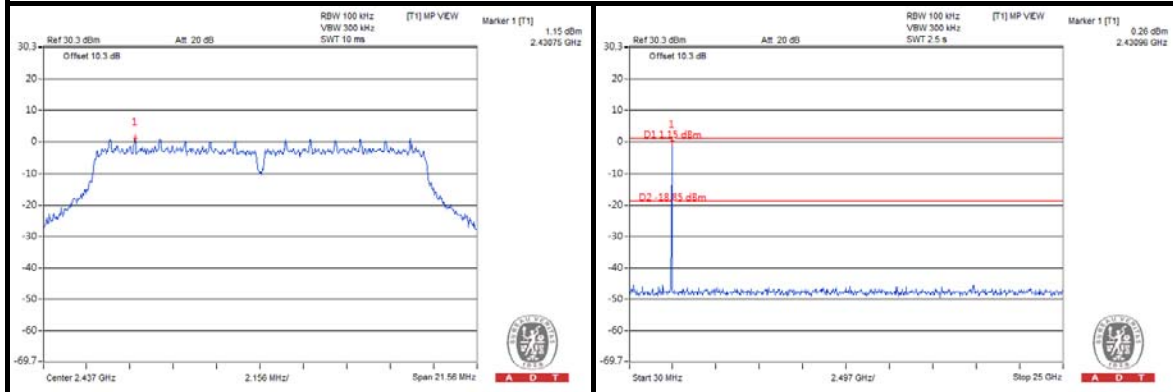

CH 11

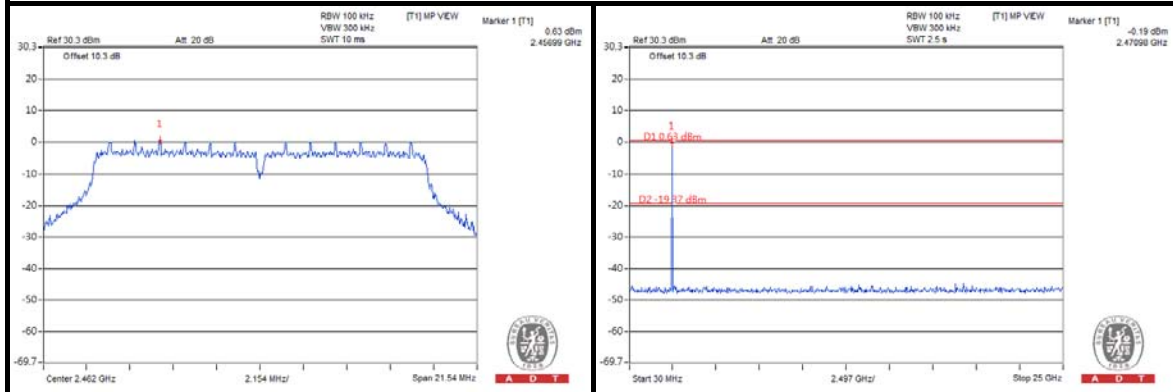

802.11n (20MHz)

CH 1

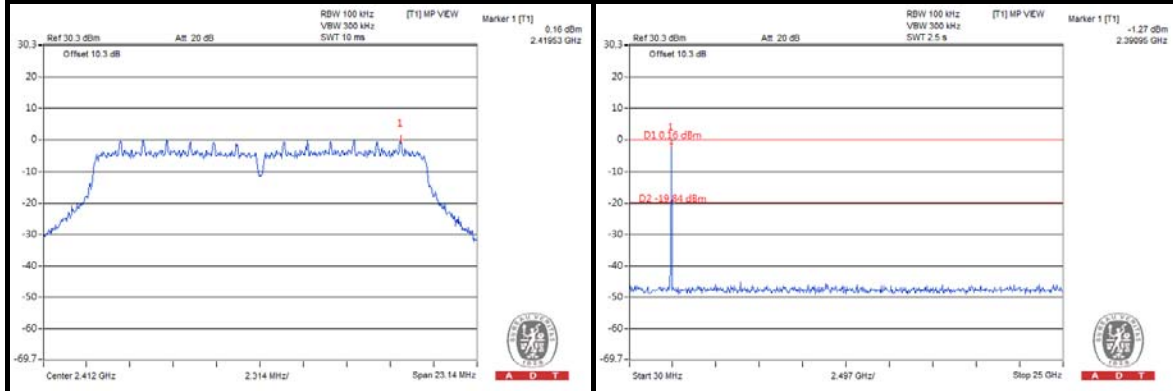

CH 6

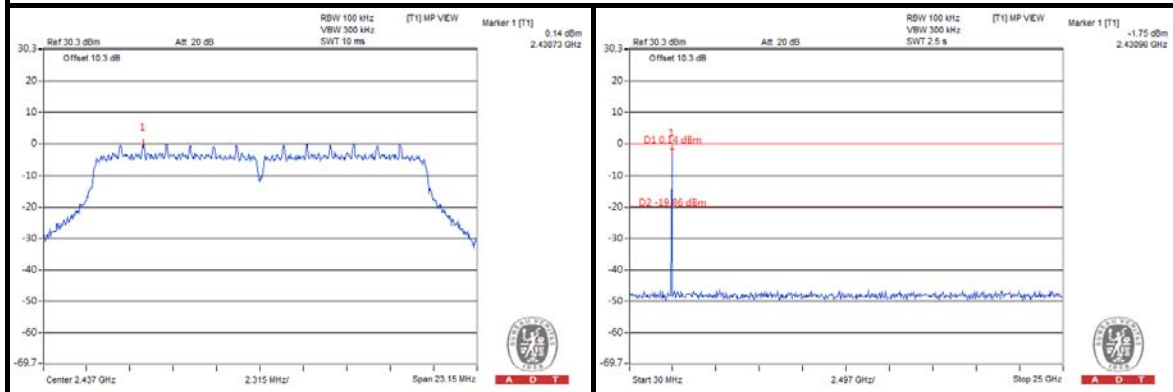

CH 11

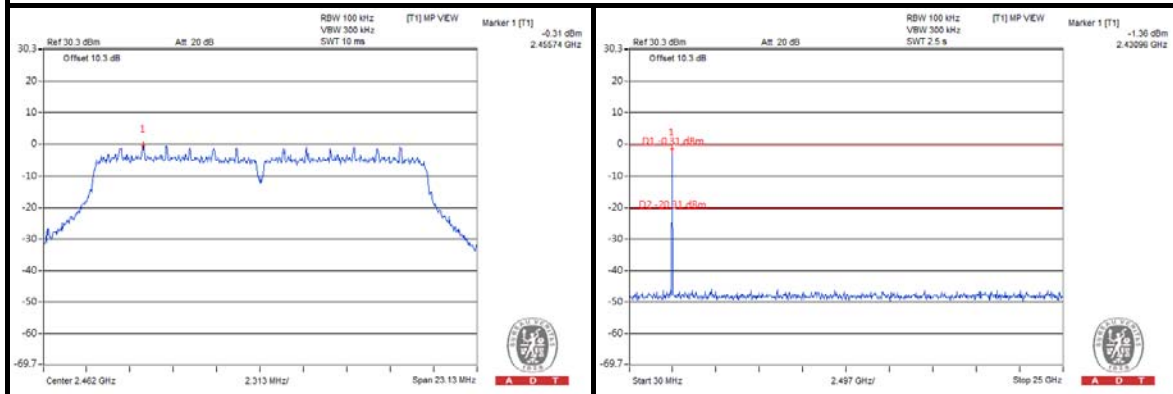

802.11n (40MHz)

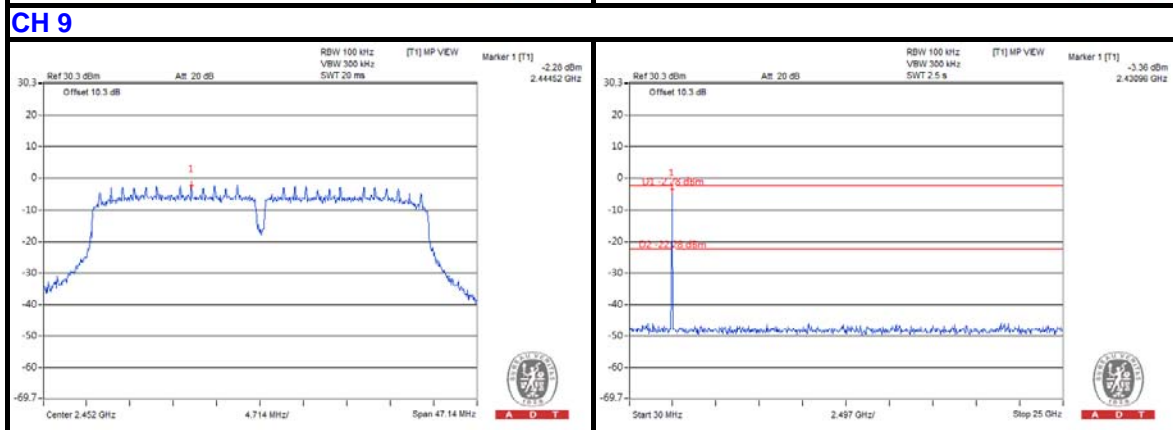
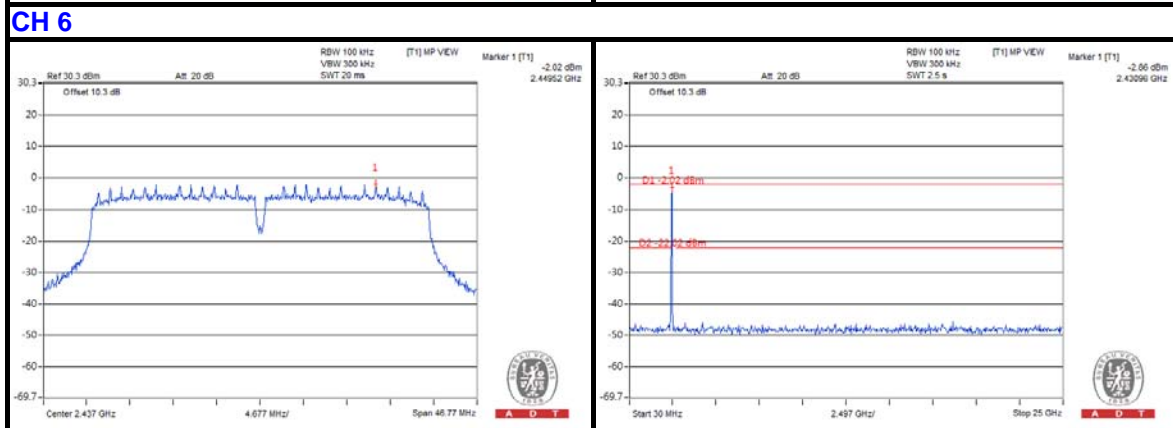
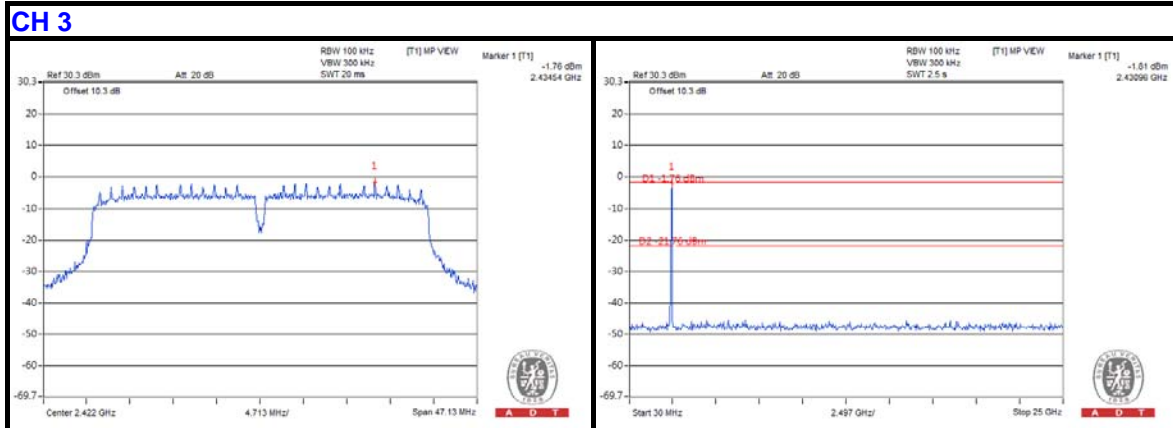

5. TEST TYPES AND RESULTS (FOR 5.0GHz BAND)

5.1 RADIATED EMISSION AND BANDEDGE MEASUREMENT

5.1.1 LIMITS OF RADIATED EMISSION AND BANDEDGE MEASUREMENT

Radiated emissions which fall in the restricted bands must comply with the radiated emission limits specified as below table. Other emissions shall be at least 20dB below the highest level of the desired power:

FREQUENCIES (MHz)	FIELD STRENGTH (microvolts/meter)	MEASUREMENT DISTANCE (meters)
0.009 ~ 0.490	2400/F(kHz)	300
0.490 ~ 1.705	24000/F(kHz)	30
1.705 ~ 30.0	30	30
30 ~ 88	100	3
88 ~ 216	150	3
216 ~ 960	200	3
Above 960	500	3

NOTE:

1. The lower limit shall apply at the transition frequencies.
2. Emission level (dBuV/m) = 20 log Emission level (uV/m).
3. For frequencies above 1000MHz, the field strength limits are based on average detector, however, the peak field strength of any emission shall not exceed the maximum permitted average limits, specified above by more than 20dB under any condition of modulation.

5.1.2 TEST INSTRUMENTS

Same as item 4.1.2.

5.1.3 TEST PROCEDURES

Same as item 4.1.3.

5.1.4 DEVIATION FROM TEST STANDARD

No deviation.

5.1.5 TEST SETUP

Same as item 4.1.5.

5.1.6 EUT OPERATING CONDITIONS

Same as 4.1.6.



5.1.7 TEST RESULTS

ABOVE 1GHz WORST-CASE DATA :

802.11a

EUT TEST CONDITION		MEASUREMENT DETAIL	
CHANNEL	Channel 149	FREQUENCY RANGE	1 ~ 40GHz
INPUT POWER (SYSTEM)	120Vac, 60 Hz	DETECTOR FUNCTION	Peak (PK) Average (AV)
ENVIRONMENTAL CONDITIONS	26deg. C, 69%RH	TESTED BY	Antony Lee

ANTENNA POLARITY & TEST DISTANCE: HORIZONTAL AT 3 M								
NO.	FREQ. (MHz)	EMISSION LEVEL (dBuV/m)	LIMIT (dBuV/m)	MARGIN (dB)	ANTENNA HEIGHT (m)	TABLE ANGLE (Degree)	RAW VALUE (dBuV)	CORRECTION FACTOR (dB/m)
1	#5725.00	72.3 PK	80.9	-8.6	1.23 H	45	32.80	39.50
2	#5725.00	52.1 AV	69.0	-16.9	1.23 H	45	12.60	39.50
3	*5745.00	100.9 PK			1.23 H	45	61.30	39.60
4	*5745.00	89.0 AV			1.23 H	45	49.40	39.60
5	11490.00	63.1 PK	74.0	-10.9	1.00 H	55	11.40	51.70
6	11490.00	48.6 AV	54.0	-5.4	1.00 H	55	-3.10	51.70

ANTENNA POLARITY & TEST DISTANCE: VERTICAL AT 3 M								
NO.	FREQ. (MHz)	EMISSION LEVEL (dBuV/m)	LIMIT (dBuV/m)	MARGIN (dB)	ANTENNA HEIGHT (m)	TABLE ANGLE (Degree)	RAW VALUE (dBuV)	CORRECTION FACTOR (dB/m)
1	#5725.00	62.7 PK	73.2	-10.5	1.00 V	36	23.20	39.50
2	#5725.00	45.5 AV	61.5	-16.0	1.00 V	36	6.00	39.50
3	*5745.00	93.2 PK			1.00 V	36	53.60	39.60
4	*5745.00	81.5 AV			1.00 V	36	41.90	39.60
5	11490.00	62.3 PK	74.0	-11.7	1.00 V	163	10.60	51.70
6	11490.00	48.6 AV	54.0	-5.4	1.00 V	163	-3.10	51.70

REMARKS:

1. Emission level (dBuV/m) = Raw Value (dBuV) + Correction Factor (dB/m).
2. Correction Factor (dB/m) = Antenna Factor (dB/m) + Cable Factor (dB).
3. The other emission levels were very low against the limit.
4. Margin value = Emission level – Limit value.
5. “ * “: Fundamental frequency.
6. The limit value is defined as per 15.247.
7. “#“: The radiated frequency is out the restricted band.



A D T

EUT TEST CONDITION		MEASUREMENT DETAIL	
CHANNEL	Channel 157	FREQUENCY RANGE	1 ~ 40GHz
INPUT POWER (SYSTEM)	120Vac, 60 Hz	DETECTOR FUNCTION	Peak (PK) Average (AV)
ENVIRONMENTAL CONDITIONS	26deg. C, 69%RH	TESTED BY	Antony Lee

ANTENNA POLARITY & TEST DISTANCE: HORIZONTAL AT 3 M								
NO.	FREQ. (MHz)	EMISSION LEVEL (dBuV/m)	LIMIT (dBuV/m)	MARGIN (dB)	ANTENNA HEIGHT (m)	TABLE ANGLE (Degree)	RAW VALUE (dBuV)	CORRECTION FACTOR (dB/m)
1	*5785.00	99.8 PK			1.47 H	46	60.10	39.70
2	*5785.00	88.8 AV			1.47 H	46	49.10	39.70
3	7713.00	54.8 PK	74.0	-19.2	1.00 H	332	9.60	45.20
4	7713.00	40.8 AV	54.0	-13.2	1.00 H	332	-4.40	45.20
5	11570.00	60.8 PK	74.0	-13.2	1.00 H	58	9.20	51.60
6	11570.00	47.6 AV	54.0	-6.4	1.00 H	58	-4.00	51.60
ANTENNA POLARITY & TEST DISTANCE: VERTICAL AT 3 M								
NO.	FREQ. (MHz)	EMISSION LEVEL (dBuV/m)	LIMIT (dBuV/m)	MARGIN (dB)	ANTENNA HEIGHT (m)	TABLE ANGLE (Degree)	RAW VALUE (dBuV)	CORRECTION FACTOR (dB/m)
1	*5785.00	92.6 PK			1.00 V	37	52.90	39.70
2	*5785.00	81.0 AV			1.00 V	37	41.30	39.70
3	7713.00	55.0 PK	74.0	-19.0	1.00 V	125	9.80	45.20
4	7713.00	40.8 AV	54.0	-13.2	1.00 V	125	-4.40	45.20
5	11570.00	61.9 PK	74.0	-12.1	1.00 V	33	10.30	51.60
6	11570.00	47.6 AV	54.0	-6.4	1.00 V	33	-4.00	51.60

REMARKS:

1. Emission level (dBuV/m) = Raw Value (dBuV) + Correction Factor (dB/m).
2. Correction Factor (dB/m) = Antenna Factor (dB/m) + Cable Factor (dB).
3. The other emission levels were very low against the limit.
4. Margin value = Emission level – Limit value.
5. “ * “: Fundamental frequency.
6. The limit value is defined as per 15.247.



A D T

EUT TEST CONDITION		MEASUREMENT DETAIL	
CHANNEL	Channel 161	FREQUENCY RANGE	1 ~ 40GHz
INPUT POWER (SYSTEM)	120Vac, 60 Hz	DETECTOR FUNCTION	Peak (PK) Average (AV)
ENVIRONMENTAL CONDITIONS	26deg. C, 69%RH	TESTED BY	Antony Lee

ANTENNA POLARITY & TEST DISTANCE: HORIZONTAL AT 3 M								
NO.	FREQ. (MHz)	EMISSION LEVEL (dBuV/m)	LIMIT (dBuV/m)	MARGIN (dB)	ANTENNA HEIGHT (m)	TABLE ANGLE (Degree)	RAW VALUE (dBuV)	CORRECTION FACTOR (dB/m)
1	*5805.00	100.1 PK			1.47 H	43	60.40	39.70
2	*5805.00	88.7 AV			1.47 H	43	49.00	39.70
3	#5825.00	58.9 PK	80.1	-21.2	1.47 H	43	19.20	39.70
4	#5825.00	40.8 AV	68.7	-27.9	1.47 H	43	1.10	39.70
5	11650.00	63.5 PK	74.0	-10.5	1.00 H	54	11.90	51.60
6	11650.00	48.8 AV	54.0	-5.2	1.00 H	54	-2.80	51.60
ANTENNA POLARITY & TEST DISTANCE: VERTICAL AT 3 M								
NO.	FREQ. (MHz)	EMISSION LEVEL (dBuV/m)	LIMIT (dBuV/m)	MARGIN (dB)	ANTENNA HEIGHT (m)	TABLE ANGLE (Degree)	RAW VALUE (dBuV)	CORRECTION FACTOR (dB/m)
1	*5805.00	91.7 PK			1.08 V	332	52.00	39.70
2	*5805.00	80.5 AV			1.08 V	332	40.80	39.70
3	#5825.00	52.1 PK	71.7	-19.6	1.02 V	332	12.40	39.70
4	#5825.00	36.9 AV	60.5	-23.6	1.02 V	332	-2.80	39.70
5	11650.00	62.5 PK	74.0	-11.5	1.00 V	173	10.90	51.60
6	11650.00	48.3 AV	54.0	-5.7	1.00 V	173	-3.30	51.60

REMARKS:

1. Emission level (dBuV/m) = Raw Value (dBuV) + Correction Factor (dB/m).
2. Correction Factor (dB/m) = Antenna Factor (dB/m) + Cable Factor (dB).
3. The other emission levels were very low against the limit.
4. Margin value = Emission level – Limit value.
5. “ * “: Fundamental frequency.
6. The limit value is defined as per 15.247.
7. “#”:The radiated frequency is out the restricted band.



802.11n (20MHz)

EUT TEST CONDITION		MEASUREMENT DETAIL	
CHANNEL	Channel 149	FREQUENCY RANGE	1 ~ 40GHz
INPUT POWER (SYSTEM)	120Vac, 60 Hz	DETECTOR FUNCTION	Peak (PK) Average (AV)
ENVIRONMENTAL CONDITIONS	26deg. C, 69%RH	TESTED BY	Antony Lee

ANTENNA POLARITY & TEST DISTANCE: HORIZONTAL AT 3 M

NO.	FREQ. (MHz)	EMISSION LEVEL (dBuV/m)	LIMIT (dBuV/m)	MARGIN (dB)	ANTENNA HEIGHT (m)	TABLE ANGLE (Degree)	RAW VALUE (dBuV)	CORRECTION FACTOR (dB/m)
1	#5725.00	74.7 PK	80.8	-6.1	1.05 H	31	35.20	39.50
2	#5725.00	56.6 AV	68.9	-12.3	1.05 H	31	17.10	39.50
3	*5745.00	100.8 PK			1.05 H	31	61.20	39.60
4	*5745.00	88.9 AV			1.05 H	31	49.30	39.60
5	11490.00	63.5 PK	74.0	-10.5	1.00 H	57	11.80	51.70
6	11490.00	48.5 AV	54.0	-5.5	1.00 H	57	-3.20	51.70

ANTENNA POLARITY & TEST DISTANCE: VERTICAL AT 3 M

NO.	FREQ. (MHz)	EMISSION LEVEL (dBuV/m)	LIMIT (dBuV/m)	MARGIN (dB)	ANTENNA HEIGHT (m)	TABLE ANGLE (Degree)	RAW VALUE (dBuV)	CORRECTION FACTOR (dB/m)
1	#5725.00	65.1 PK	72.7	-7.6	1.00 V	34	25.60	39.50
2	#5725.00	47.6 AV	61.2	-13.6	1.00 V	34	8.10	39.50
3	*5745.00	92.7 PK			1.00 V	34	53.10	39.60
4	*5745.00	81.2 AV			1.00 V	34	41.60	39.60
5	11490.00	63.3 PK	74.0	-10.7	1.00 V	213	11.60	51.70
6	11490.00	48.9 AV	54.0	-5.1	1.00 V	213	-2.80	51.70

REMARKS:

1. Emission level (dBuV/m) = Raw Value (dBuV) + Correction Factor (dB/m).
2. Correction Factor (dB/m) = Antenna Factor (dB/m) + Cable Factor (dB).
3. The other emission levels were very low against the limit.
4. Margin value = Emission level – Limit value.
5. “ * “: Fundamental frequency.
6. The limit value is defined as per 15.247.
7. “#”:The radiated frequency is out the restricted band.



A D T

EUT TEST CONDITION		MEASUREMENT DETAIL	
CHANNEL	Channel 157	FREQUENCY RANGE	1 ~ 40GHz
INPUT POWER (SYSTEM)	120Vac, 60 Hz	DETECTOR FUNCTION	Peak (PK) Average (AV)
ENVIRONMENTAL CONDITIONS	26deg. C, 69%RH	TESTED BY	Antony Lee

ANTENNA POLARITY & TEST DISTANCE: HORIZONTAL AT 3 M								
NO.	FREQ. (MHz)	EMISSION LEVEL (dBuV/m)	LIMIT (dBuV/m)	MARGIN (dB)	ANTENNA HEIGHT (m)	TABLE ANGLE (Degree)	RAW VALUE (dBuV)	CORRECTION FACTOR (dB/m)
1	*5785.00	100.4 PK			1.36 H	45	60.70	39.70
2	*5785.00	89.0 AV			1.36 H	45	49.30	39.70
3	7713.00	54.0 PK	74.0	-20.0	1.00 H	335	8.80	45.20
4	7713.00	41.3 AV	54.0	-12.7	1.00 H	335	-3.90	45.20
5	11570.00	61.2 PK	74.0	-12.8	1.00 H	55	9.60	51.60
6	11570.00	48.3 AV	54.0	-5.7	1.00 H	55	-3.30	51.60

ANTENNA POLARITY & TEST DISTANCE: VERTICAL AT 3 M								
NO.	FREQ. (MHz)	EMISSION LEVEL (dBuV/m)	LIMIT (dBuV/m)	MARGIN (dB)	ANTENNA HEIGHT (m)	TABLE ANGLE (Degree)	RAW VALUE (dBuV)	CORRECTION FACTOR (dB/m)
1	*5785.00	93.2 PK			1.37 V	327	53.50	39.70
2	*5785.00	81.5 AV			1.37 V	327	41.80	39.70
3	7713.00	55.2 PK	74.0	-18.8	1.13 V	33	10.00	45.20
4	7713.00	40.9 AV	54.0	-13.1	1.13 V	33	-4.30	45.20
5	11570.00	62.4 PK	74.0	-11.6	1.00 V	35	10.80	51.60
6	11570.00	47.9 AV	54.0	-6.1	1.00 V	35	-3.70	51.60

REMARKS:

1. Emission level (dBuV/m) = Raw Value (dBuV) + Correction Factor (dB/m).
2. Correction Factor (dB/m) = Antenna Factor (dB/m) + Cable Factor (dB).
3. The other emission levels were very low against the limit.
4. Margin value = Emission level – Limit value.
5. “ * “: Fundamental frequency.
6. The limit value is defined as per 15.247.



A D T

EUT TEST CONDITION		MEASUREMENT DETAIL	
CHANNEL	Channel 161	FREQUENCY RANGE	1 ~ 40GHz
INPUT POWER (SYSTEM)	120Vac, 60 Hz	DETECTOR FUNCTION	Peak (PK) Average (AV)
ENVIRONMENTAL CONDITIONS	26deg. C, 69%RH	TESTED BY	Antony Lee

ANTENNA POLARITY & TEST DISTANCE: HORIZONTAL AT 3 M								
NO.	FREQ. (MHz)	EMISSION LEVEL (dBuV/m)	LIMIT (dBuV/m)	MARGIN (dB)	ANTENNA HEIGHT (m)	TABLE ANGLE (Degree)	RAW VALUE (dBuV)	CORRECTION FACTOR (dB/m)
1	*5805.00	100.8 PK			1.46 H	37	61.10	39.70
2	*5805.00	89.0 AV			1.46 H	37	49.30	39.70
3	#5825.00	62.4 PK	80.8	-18.4	1.46 H	37	22.70	39.70
4	#5825.00	44.3 AV	69.0	-24.7	1.46 H	37	4.60	39.70
5	11650.00	63.8 PK	74.0	-10.2	1.00 H	56	12.20	51.60
6	11650.00	49.3 AV	54.0	-4.7	1.00 H	56	-2.30	51.60
ANTENNA POLARITY & TEST DISTANCE: VERTICAL AT 3 M								
NO.	FREQ. (MHz)	EMISSION LEVEL (dBuV/m)	LIMIT (dBuV/m)	MARGIN (dB)	ANTENNA HEIGHT (m)	TABLE ANGLE (Degree)	RAW VALUE (dBuV)	CORRECTION FACTOR (dB/m)
1	*5805.00	90.1 PK			1.00 V	40	50.40	39.70
2	*5805.00	79.9 AV			1.00 V	40	40.20	39.70
3	#5825.00	53.6 PK	70.1	-16.5	1.00 V	40	13.90	39.70
4	#5825.00	38.8 AV	59.9	-21.1	1.00 V	40	-0.90	39.70
5	11650.00	63.3 PK	74.0	-10.7	1.00 V	177	11.70	51.60
6	11650.00	48.5 AV	54.0	-5.5	1.00 V	177	-3.10	51.60

REMARKS:

1. Emission level (dBuV/m) = Raw Value (dBuV) + Correction Factor (dB/m).
2. Correction Factor (dB/m) = Antenna Factor (dB/m) + Cable Factor (dB).
3. The other emission levels were very low against the limit.
4. Margin value = Emission level – Limit value.
5. “ * “: Fundamental frequency.
6. The limit value is defined as per 15.247.
7. “#”:The radiated frequency is out the restricted band.



802.11n (40MHz)

EUT TEST CONDITION		MEASUREMENT DETAIL	
CHANNEL	Channel 151	FREQUENCY RANGE	1 ~ 40GHz
INPUT POWER (SYSTEM)	120Vac, 60 Hz	DETECTOR FUNCTION	Peak (PK) Average (AV)
ENVIRONMENTAL CONDITIONS	26deg. C, 69%RH	TESTED BY	Antony Lee

ANTENNA POLARITY & TEST DISTANCE: HORIZONTAL AT 3 M								
NO.	FREQ. (MHz)	EMISSION LEVEL (dBuV/m)	LIMIT (dBuV/m)	MARGIN (dB)	ANTENNA HEIGHT (m)	TABLE ANGLE (Degree)	RAW VALUE (dBuV)	CORRECTION FACTOR (dB/m)
1	#5725.00	75.9 PK	77.3	-1.4	1.47 H	43	36.40	39.50
2	#5725.00	59.0 AV	65.5	-6.5	1.47 H	43	19.50	39.50
3	*5755.00	97.3 PK			1.47 H	43	57.70	39.60
4	*5755.00	85.5 AV			1.47 H	43	45.90	39.60
5	11510.00	63.5 PK	74.0	-10.5	1.00 H	58	11.80	51.70
6	11510.00	49.3 AV	54.0	-4.7	1.00 H	58	-2.40	51.70
ANTENNA POLARITY & TEST DISTANCE: VERTICAL AT 3 M								
NO.	FREQ. (MHz)	EMISSION LEVEL (dBuV/m)	LIMIT (dBuV/m)	MARGIN (dB)	ANTENNA HEIGHT (m)	TABLE ANGLE (Degree)	RAW VALUE (dBuV)	CORRECTION FACTOR (dB/m)
1	#5725.00	67.6 PK	69.3	-1.7	1.00 V	36	28.10	39.50
2	#5725.00	50.3 AV	58.0	-7.7	1.00 V	36	10.80	39.50
3	*5755.00	89.3 PK			1.00 V	36	49.70	39.60
4	*5755.00	78.0 AV			1.00 V	36	38.40	39.60
5	11510.00	63.3 PK	74.0	-10.7	1.00 V	174	11.60	51.70
6	11510.00	49.5 AV	54.0	-4.5	1.00 V	174	-2.20	51.70

REMARKS:

1. Emission level (dBuV/m) = Raw Value (dBuV) + Correction Factor (dB/m).
2. Correction Factor (dB/m) = Antenna Factor (dB/m) + Cable Factor (dB).
3. The other emission levels were very low against the limit.
4. Margin value = Emission level – Limit value.
5. “ * “: Fundamental frequency.
6. The limit value is defined as per 15.247.
7. “#”: The radiated frequency is out the restricted band.



A D T

EUT TEST CONDITION		MEASUREMENT DETAIL	
CHANNEL	Channel 159	FREQUENCY RANGE	1 ~ 40GHz
INPUT POWER (SYSTEM)	120Vac, 60 Hz	DETECTOR FUNCTION	Peak (PK) Average (AV)
ENVIRONMENTAL CONDITIONS	26deg. C, 69%RH	TESTED BY	Antony Lee

ANTENNA POLARITY & TEST DISTANCE: HORIZONTAL AT 3 M								
NO.	FREQ. (MHz)	EMISSION LEVEL (dBuV/m)	LIMIT (dBuV/m)	MARGIN (dB)	ANTENNA HEIGHT (m)	TABLE ANGLE (Degree)	RAW VALUE (dBuV)	CORRECTION FACTOR (dB/m)
1	*5795.00	96.9 PK			1.45 H	45	57.20	39.70
2	*5795.00	85.6 AV			1.45 H	45	45.90	39.70
3	#5850.00	59.3 PK	76.9	-17.6	1.45 H	45	19.50	39.80
4	#5850.00	38.8 AV	65.6	-26.8	1.45 H	45	-1.00	39.80
5	11590.00	63.4 PK	74.0	-10.6	1.00 H	11	11.90	51.50
6	11590.00	49.3 AV	54.0	-4.7	1.00 H	11	-2.20	51.50
ANTENNA POLARITY & TEST DISTANCE: VERTICAL AT 3 M								
NO.	FREQ. (MHz)	EMISSION LEVEL (dBuV/m)	LIMIT (dBuV/m)	MARGIN (dB)	ANTENNA HEIGHT (m)	TABLE ANGLE (Degree)	RAW VALUE (dBuV)	CORRECTION FACTOR (dB/m)
1	*5795.00	89.1 PK			1.48 V	326	49.40	39.70
2	*5795.00	78.0 AV			1.48 V	326	38.30	39.70
3	#5850.00	49.3 PK	69.1	-19.8	1.48 V	326	9.50	39.80
4	#5850.00	36.4 AV	58.0	-21.6	1.48 V	326	-3.40	39.80
5	11590.00	62.5 PK	74.0	-11.5	1.00 V	175	11.00	51.50
6	11590.00	48.0 AV	54.0	-6.0	1.00 V	175	-3.50	51.50

REMARKS:

1. Emission level (dBuV/m) = Raw Value (dBuV) + Correction Factor (dB/m).
2. Correction Factor (dB/m) = Antenna Factor (dB/m) + Cable Factor (dB).
3. The other emission levels were very low against the limit.
4. Margin value = Emission level – Limit value.
5. “ * “: Fundamental frequency.
6. The limit value is defined as per 15.247.
7. “#”:The radiated frequency is out the restricted band.

BELOW 1GHz WORST-CASE DATA : 802.11a

EUT TEST CONDITION		MEASUREMENT DETAIL	
CHANNEL	Channel 149	FREQUENCY RANGE	Below 1000MHz
INPUT POWER (SYSTEM)	120Vac, 60 Hz	DETECTOR FUNCTION	Quasi-Peak
ENVIRONMENTAL CONDITIONS	25deg. C, 65%RH	TESTED BY	Alan Wu

ANTENNA POLARITY & TEST DISTANCE: HORIZONTAL AT 3 M								
NO.	FREQ. (MHz)	EMISSION LEVEL (dBuV/m)	LIMIT (dBuV/m)	MARGIN (dB)	ANTENNA HEIGHT (m)	TABLE ANGLE (Degree)	RAW VALUE (dBuV)	CORRECTION FACTOR (dB/m)
1	68.71	27.2 QP	40.0	-12.8	1.99 H	322	14.70	12.50
2	179.31	32.5 QP	43.5	-11.0	1.49 H	267	19.40	13.10
3	223.94	37.8 QP	46.0	-8.2	1.24 H	185	25.30	12.50
4	299.62	34.6 QP	46.0	-11.4	1.00 H	144	18.90	15.70
5	388.87	27.9 QP	46.0	-18.1	1.00 H	228	9.80	18.10
6	864.27	28.9 QP	46.0	-17.1	1.74 H	289	0.90	28.00
ANTENNA POLARITY & TEST DISTANCE: VERTICAL AT 3 M								
NO.	FREQ. (MHz)	EMISSION LEVEL (dBuV/m)	LIMIT (dBuV/m)	MARGIN (dB)	ANTENNA HEIGHT (m)	TABLE ANGLE (Degree)	RAW VALUE (dBuV)	CORRECTION FACTOR (dB/m)
1	64.83	31.3 QP	40.0	-8.7	1.00 V	187	18.30	13.00
2	101.69	29.4 QP	43.5	-14.1	1.24 V	160	19.50	9.90
3	142.44	29.3 QP	43.5	-14.2	1.75 V	151	15.30	14.00
4	218.12	35.7 QP	46.0	-10.3	1.00 V	111	23.50	12.20
5	254.99	33.4 QP	46.0	-12.6	1.00 V	84	19.60	13.80
6	435.44	26.1 QP	46.0	-19.9	1.50 V	225	6.70	19.40

REMARKS:

1. Emission level (dBuV/m) = Raw Value (dBuV) + Correction Factor (dB/m).
2. Correction Factor (dB/m) = Antenna Factor (dB/m) + Cable Factor (dB).
3. The other emission levels were very low against the limit.
4. Margin value = Emission level – Limit value.

5.2 CONDUCTED EMISSION MEASUREMENT

5.2.1 LIMITS OF CONDUCTED EMISSION MEASUREMENT

FREQUENCY OF EMISSION (MHz)	CONDUCTED LIMIT (dB μ V)	
	Quasi-peak	Average
0.15 ~ 0.5	66 to 56	56 to 46
0.5 ~ 5	56	46
5 ~ 30	60	50

- NOTE:** 1. The lower limit shall apply at the transition frequencies.
2. The limit decreases in line with the logarithm of the frequency in the range of 0.15 to 0.50MHz.
3. All emanations from a class A/B digital device or system, including any network of conductors and apparatus connected thereto, shall not exceed the level of field strengths specified above.

5.2.2 TEST INSTRUMENTS

Same as item 4.2.2.

5.2.3 TEST PROCEDURES

Same as item 4.2.3.

5.2.4 DEVIATION FROM TEST STANDARD

No deviation.

5.2.5 TEST SETUP

Same as item 4.2.5.

5.2.6 EUT OPERATING CONDITIONS

Same as 4.1.6

5.2.7 TEST RESULTS

CONDUCTED WORST-CASE DATA : 802.11a

PHASE	Line 1	6dB BANDWIDTH	9kHz
-------	--------	---------------	------

No	Freq. [MHz]	Corr. Factor (dB)	Reading Value		Emission Level		Limit		Margin	
			[dB (uV)]		[dB (uV)]		[dB (uV)]		(dB)	
			Q.P.	AV.	Q.P.	AV.	Q.P.	AV.	Q.P.	AV.
1	0.24766	0.15	51.65	35.33	51.80	35.48	61.84	51.84	-10.03	-16.35
2	0.40391	0.17	49.35	29.13	49.52	29.30	57.77	47.77	-8.25	-18.47
3	0.54063	0.17	47.07	26.85	47.24	27.02	56.00	46.00	-8.76	-18.98
4	0.65391	0.18	45.74	23.20	45.92	23.38	56.00	46.00	-10.08	-22.62
5	2.44922	0.28	44.46	26.70	44.74	26.98	56.00	46.00	-11.26	-19.02
6	13.56250	0.50	67.25	62.21	67.75	62.71	60.00	50.00	7.75	12.71

REMARKS:

1. Q.P. and AV. are abbreviations of quasi-peak and average individually.
2. The emission levels of other frequencies were very low against the limit.
3. Margin value = Emission level - Limit value
4. Correction factor = Insertion loss + Cable loss
5. Emission Level = Correction Factor + Reading Value.

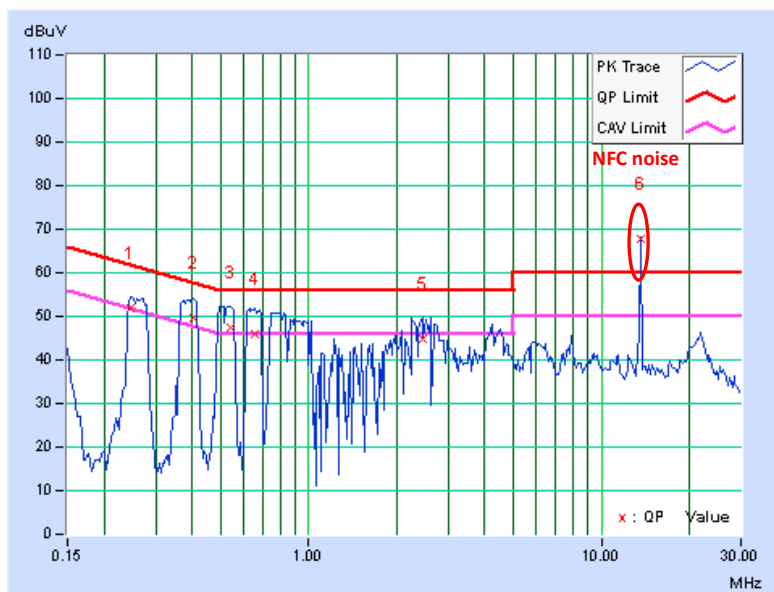

PHASE	Line 2	6dB BANDWIDTH	9kHz
-------	--------	---------------	------

No	Freq. [MHz]	Corr. Factor (dB)	Reading Value [dB (uV)]		Emission Level [dB (uV)]		Limit [dB (uV)]		Margin (dB)	
			Q.P.	AV.	Q.P.	AV.	Q.P.	AV.	Q.P.	AV.
			1	0.25547	0.15	51.49	36.19	51.64	36.34	61.58
2	0.39609	0.16	49.51	29.71	49.67	29.87	57.93	47.93	-8.27	-18.07
3	0.52500	0.17	47.32	27.58	47.49	27.75	56.00	46.00	-8.51	-18.25
4	0.63438	0.17	46.29	24.13	46.46	24.30	56.00	46.00	-9.54	-21.70
5	2.33203	0.27	44.14	27.29	44.41	27.56	56.00	46.00	-11.59	-18.44
6	13.56250	0.57	67.41	62.21	67.98	62.78	60.00	50.00	7.98	12.78

REMARKS:

1. Q.P. and AV. are abbreviations of quasi-peak and average individually.
2. The emission levels of other frequencies were very low against the limit.
3. Margin value = Emission level - Limit value
4. Correction factor = Insertion loss + Cable loss
5. Emission Level = Correction Factor + Reading Value.

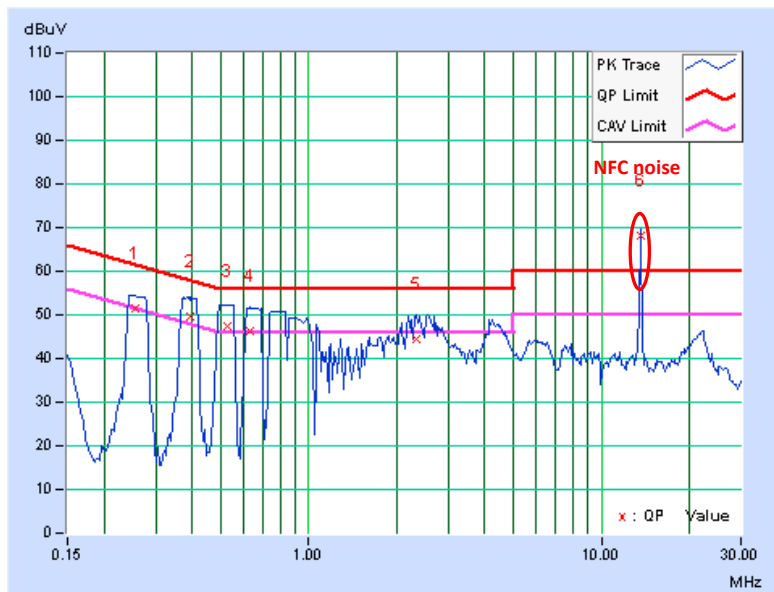

Test with suitable dummy load

PHASE	Line 1	6dB BANDWIDTH	9kHz
--------------	--------	----------------------	------

No	Freq. [MHz]	Corr. Factor (dB)	Reading Value		Emission Level		Limit		Margin	
			[dB (uV)]		[dB (uV)]		[dB (uV)]		(dB)	
			Q.P.	AV.	Q.P.	AV.	Q.P.	AV.	Q.P.	AV.
1	0.25156	0.16	52.77	36.83	52.93	36.99	61.71	51.71	-8.78	-14.72
2	0.37656	0.17	48.04	31.06	48.21	31.23	58.35	48.35	-10.15	-17.13
3	0.54453	0.17	46.22	27.32	46.39	27.49	56.00	46.00	-9.61	-18.51
4	0.77891	0.18	40.96	22.95	41.14	23.13	56.00	46.00	-14.86	-22.87
5	2.41016	0.28	41.30	20.09	41.58	20.37	56.00	46.00	-14.42	-25.63
6	22.22656	0.61	34.26	22.76	34.87	23.37	60.00	50.00	-25.13	-26.63

REMARKS:

1. Q.P. and AV. are abbreviations of quasi-peak and average individually.
2. The emission levels of other frequencies were very low against the limit.
3. Margin value = Emission level - Limit value
4. Correction factor = Insertion loss + Cable loss
5. Emission Level = Correction Factor + Reading Value.

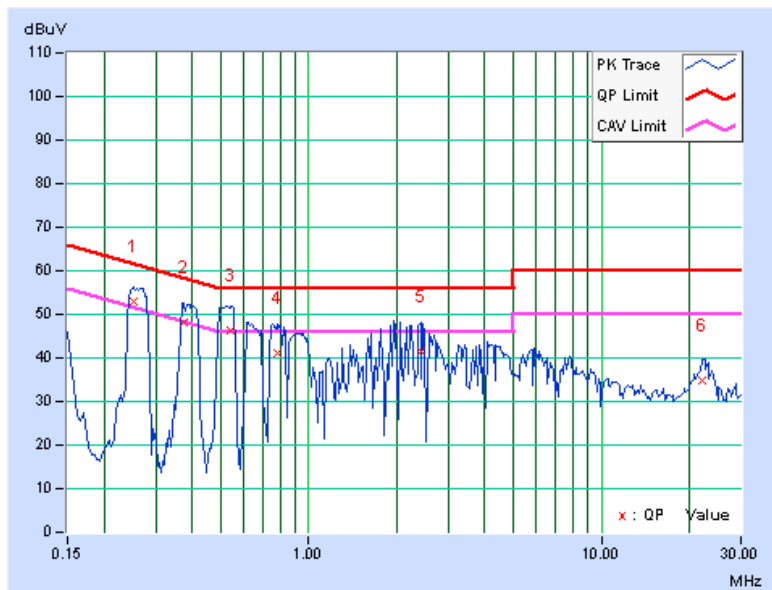

PHASE	Line 2	6dB BANDWIDTH	9kHz
-------	--------	---------------	------

No	Freq. [MHz]	Corr. Factor (dB)	Reading Value		Emission Level		Limit		Margin	
			[dB (uV)]		[dB (uV)]		[dB (uV)]		(dB)	
			Q.P.	AV.	Q.P.	AV.	Q.P.	AV.	Q.P.	AV.
1	0.25938	0.15	53.01	36.55	53.16	36.70	61.45	51.45	-8.30	-14.76
2	0.38438	0.16	48.12	30.84	48.28	31.00	58.18	48.18	-9.91	-17.19
3	0.53281	0.17	46.75	28.07	46.92	28.24	56.00	46.00	-9.08	-17.76
4	0.73984	0.18	42.12	22.68	42.30	22.86	56.00	46.00	-13.70	-23.14
5	2.21875	0.27	42.96	22.69	43.23	22.96	56.00	46.00	-12.77	-23.04
6	22.88672	0.67	33.87	22.53	34.54	23.20	60.00	50.00	-25.46	-26.80

REMARKS:

1. Q.P. and AV. are abbreviations of quasi-peak and average individually.
2. The emission levels of other frequencies were very low against the limit.
3. Margin value = Emission level - Limit value
4. Correction factor = Insertion loss + Cable loss
5. Emission Level = Correction Factor + Reading Value.

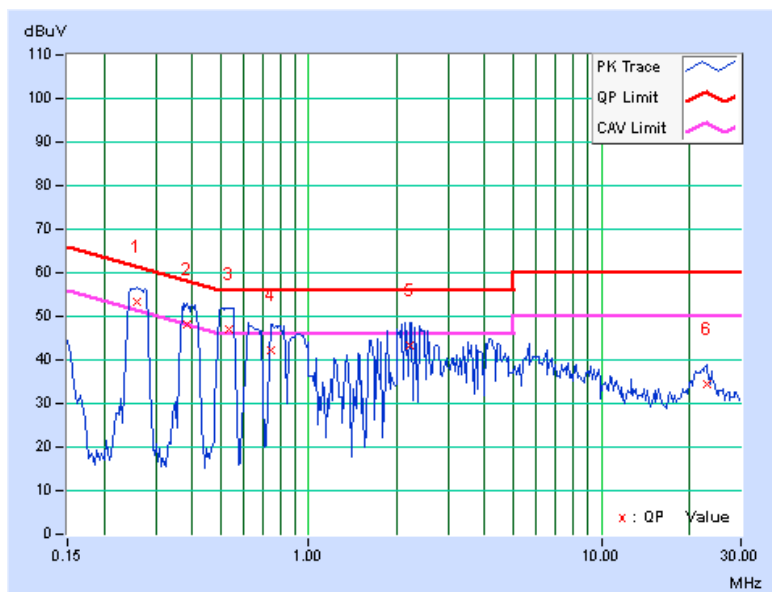

5.3 6dB BANDWIDTH MEASUREMENT

5.3.1 LIMITS OF 6dB BANDWIDTH MEASUREMENT

The minimum of 6dB Bandwidth Measurement is 0.5MHz.

5.3.2 TEST SETUP

Same as item 4.3.2.

5.3.3 TEST INSTRUMENTS

Refer to section 4.1.2 to get information of above instrument.

5.3.4 TEST PROCEDURE

Same as item 4.3.4.

5.3.5 DEVIATION FROM TEST STANDARD

No deviation.

5.3.6 EUT OPERATING CONDITIONS

Same as item 4.3.6.



A D T

5.3.7 TEST RESULTS

802.11a

CHANNEL	CHANNEL FREQUENCY (MHz)	6dB BANDWIDTH (MHz)	MINIMUM LIMIT (MHz)	PASS / FAIL
149	5745	16.53	0.5	PASS
157	5785	16.59	0.5	PASS
161	5805	16.57	0.5	PASS

802.11n (20MHz)

CHANNEL	CHANNEL FREQUENCY (MHz)	6dB BANDWIDTH (MHz)	MINIMUM LIMIT (MHz)	PASS / FAIL
149	5745	17.80	0.5	PASS
157	5785	17.81	0.5	PASS
161	5805	17.80	0.5	PASS

802.11n (40MHz)

CHANNEL	CHANNEL FREQUENCY (MHz)	6dB BANDWIDTH (MHz)	MINIMUM LIMIT (MHz)	PASS / FAIL
151	5755	36.06	0.5	PASS
159	5795	36.10	0.5	PASS

5.4 MAXIMUM OUTPUT POWER

5.4.1 LIMITS OF MAXIMUM OUTPUT POWER MEASUREMENT

For systems using digital modulation in the 5725–5850 MHz bands: 1 Watt (30dBm)

5.4.2 TEST SETUP

Same as Item 4.4.2.

5.4.3 INSTRUMENTS

Refer to section 4.1.2 to get information of above instrument.

5.4.4 TEST PROCEDURES

Same as Item 4.4.4.

5.4.5 DEVIATION FROM TEST STANDARD

No deviation.

5.4.6 EUT OPERATING CONDITIONS

Same as Item 4.3.6.



A D T

5.4.7 TEST RESULTS

802.11a

CHANNEL	FREQUENCY (MHz)	PEAK POWER (mW)	PEAK POWER (dBm)	LIMIT (dBm)	PASS/FAIL
149	5745	101.391	20.06	30	PASS
157	5785	100.000	20.00	30	PASS
161	5805	97.051	19.87	30	PASS

802.11n (20MHz)

CHANNEL	FREQUENCY (MHz)	PEAK POWER (mW)	PEAK POWER (dBm)	LIMIT (dBm)	PASS/FAIL
149	5745	103.753	20.16	30	PASS
157	5785	98.628	19.94	30	PASS
161	5805	98.628	19.94	30	PASS

802.11n (40MHz)

CHANNEL	FREQUENCY (MHz)	PEAK POWER (mW)	PEAK POWER (dBm)	LIMIT (dBm)	PASS/FAIL
151	5755	102.802	20.12	30	PASS
159	5795	100.000	20.00	30	PASS

5.5 POWER SPECTRAL DENSITY MEASUREMENT

5.5.1 LIMITS OF POWER SPECTRAL DENSITY MEASUREMENT

The Maximum of Power Spectral Density Measurement is 8dBm.

5.5.2 TEST SETUP

Same as item 4.5.2.

5.5.3 TEST INSTRUMENTS

Refer to section 4.1.2 to get information of above instrument.

5.5.4 TEST PROCEDURE.

Same as item 4.5.4.

5.5.5 DEVIATION FROM TEST STANDARD

No deviation.

5.5.6 EUT OPERATING CONDITION

Same as item 4.3.6.

5.5.7 TEST RESULTS

802.11a

Channel	FREQ. (MHz)	PSD (dBm/100kHz)	PSD (dBm/3kHz)	Limit (dBm/3kHz)	PASS /FAIL
149	5745	1.08	-14.15	8	PASS
157	5785	0.71	-14.52	8	PASS
161	5805	0.68	-14.55	8	PASS

802.11n (20MHz)

Channel	FREQ. (MHz)	PSD (dBm/100kHz)	PSD (dBm/3kHz)	Limit (dBm/3kHz)	PASS /FAIL
149	5745	1.31	-13.89	8	PASS
157	5785	1.02	-14.18	8	PASS
161	5805	1.07	-14.13	8	PASS

802.11n (40MHz)

Channel	FREQ. (MHz)	PSD (dBm/100kHz)	PSD (dBm/3kHz)	Limit (dBm/3kHz)	PASS /FAIL
151	5755	-2.36	-17.59	8	PASS
159	5795	-2.45	-17.68	8	PASS

5.6 CONDUCTED OUT OF BAND EMISSION MEASUREMENT

5.6.1 LIMITS OF OUT OF BAND EMISSION MEASUREMENT

Below -20dB of the highest emission level of operating band (in 100kHz Resolution Bandwidth).

5.6.2 TEST SETUP

Same as Item 4.6.2

5.6.3 TEST INSTRUMENTS

Refer to section 4.1.2 to get information of above instrument.

5.6.4 TEST PROCEDURE

Same as Item 4.6.4

5.6.5 DEVIATION FROM TEST STANDARD

No deviation.

5.6.6 EUT OPERATING CONDITION

Same as Item 4.3.6

5.6.7 TEST RESULTS

The spectrum plots are attached on the following pages. D1 line indicates the highest level, and D2 line indicates the 20dB offset below D1. It shows compliance with the requirement.



A D T

802.11a

CH 149

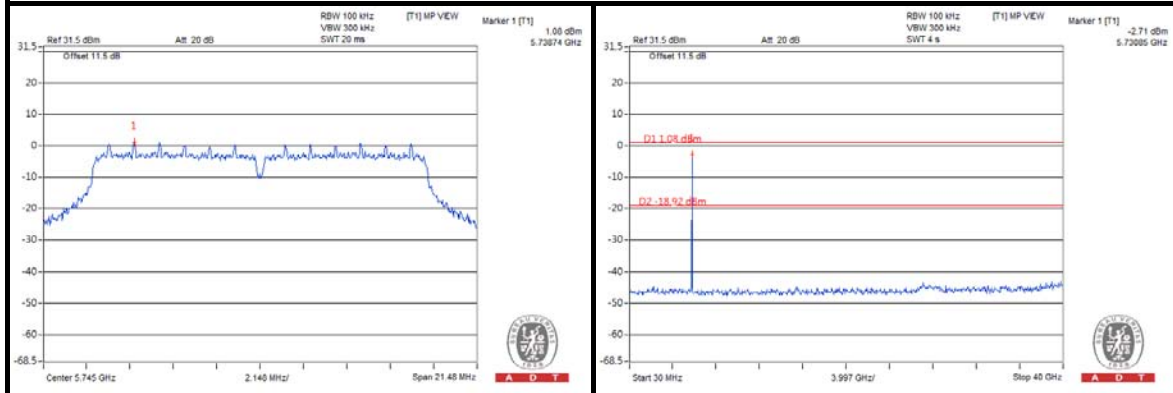

CH 157

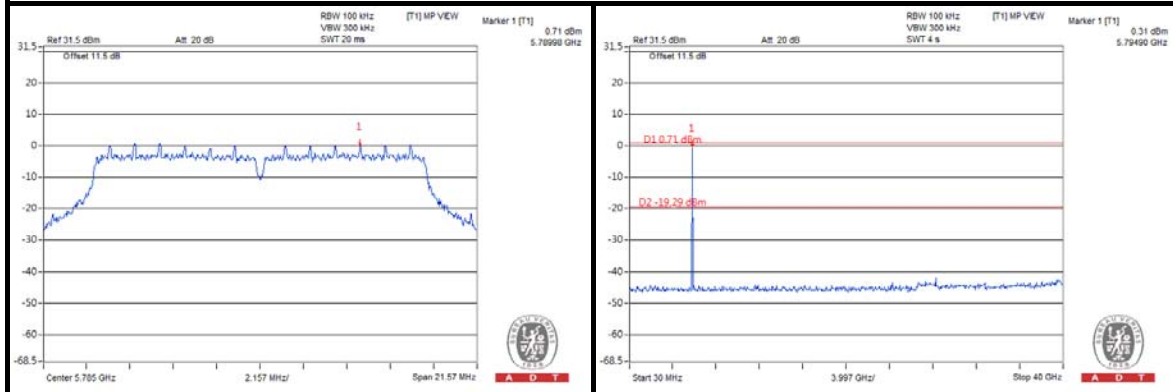

CH 161

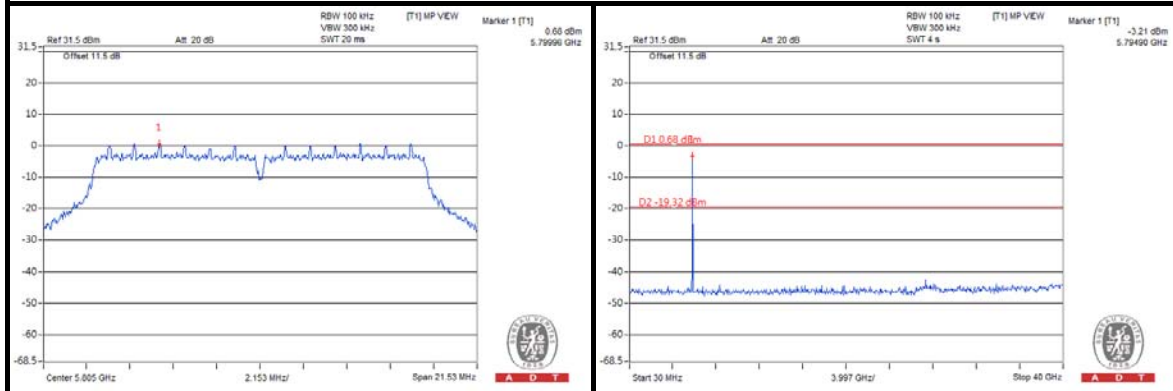



A D T

802.11n(20MHz)

CH 149

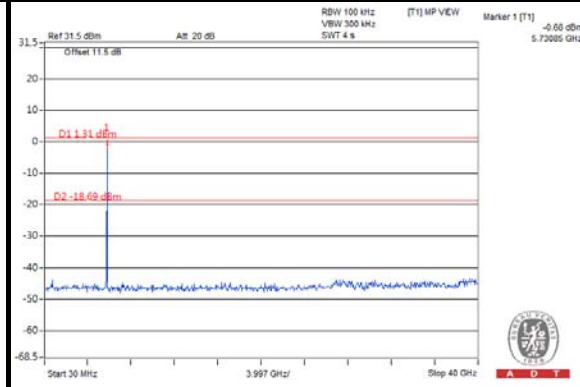
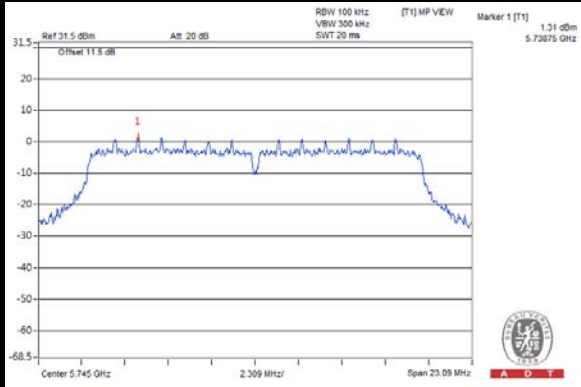

CH 157

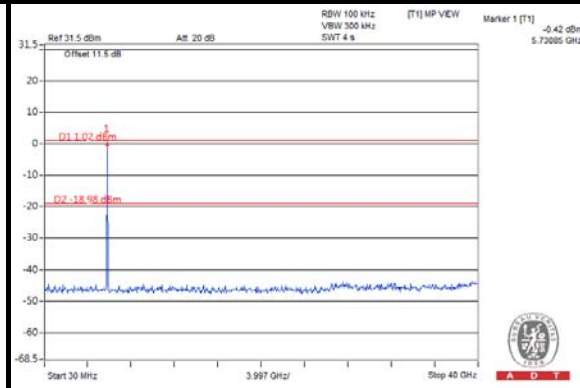
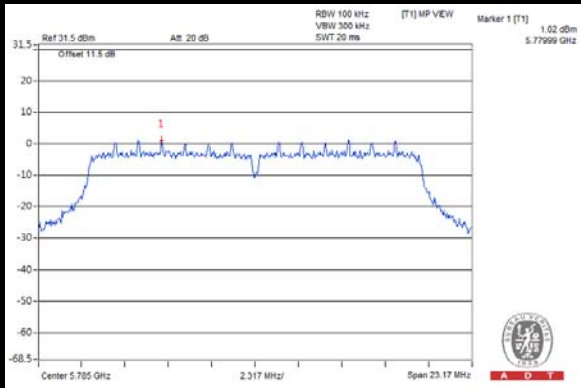

CH 161

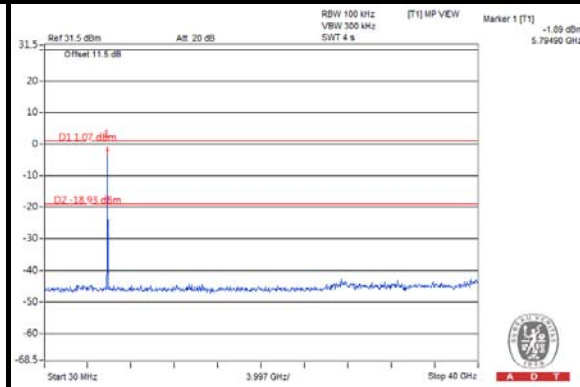
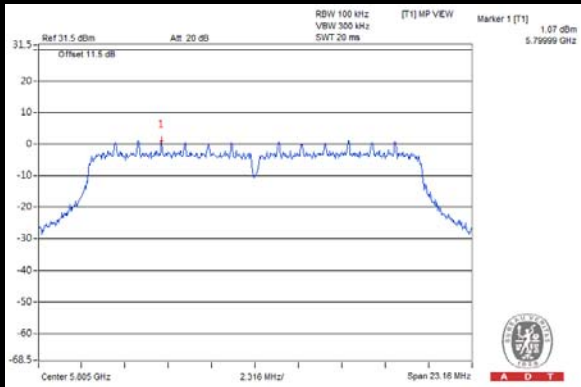



A D T

802.11n(40MHz)

CH 151

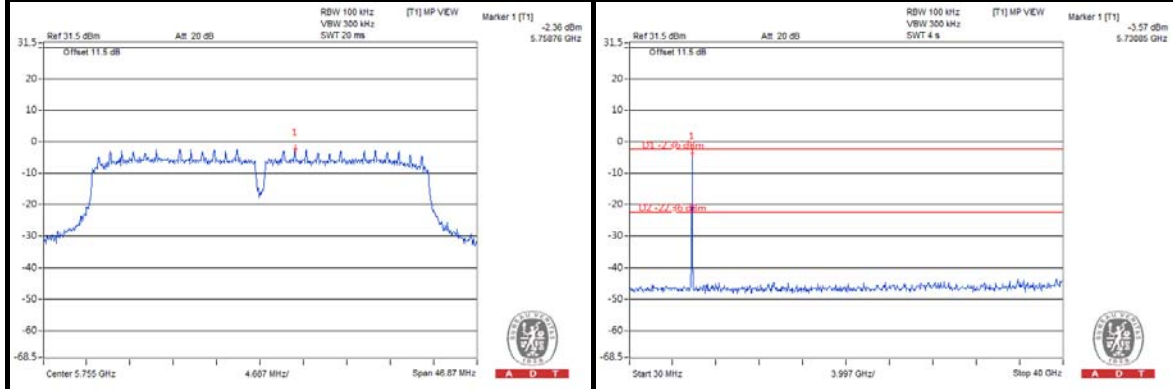

CH 159

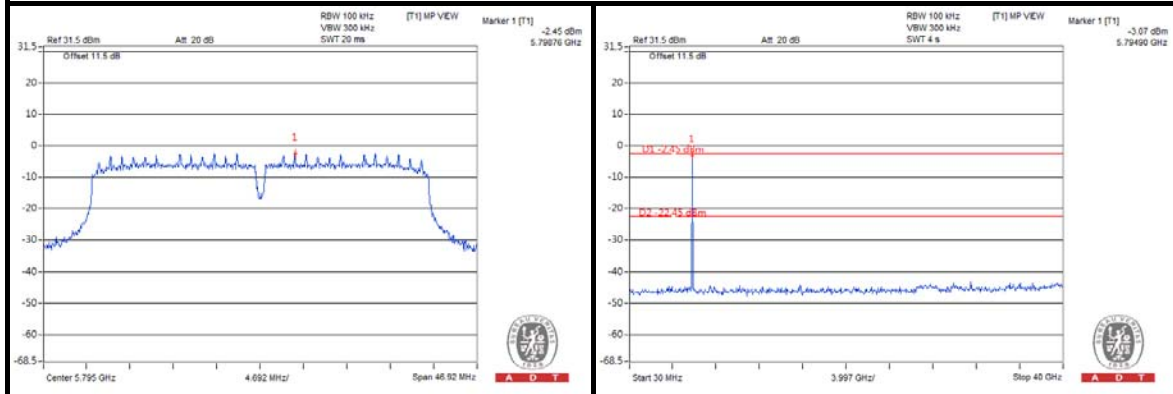

6. PHOTOGRAPHS OF THE TEST CONFIGURATION

Please refer to the attached file (Test Setup Photo).



7. INFORMATION ON THE TESTING LABORATORIES

We, Bureau Veritas Consumer Products Services (H.K.) Ltd., Taoyuan Branch, were founded in 1988 to provide our best service in EMC, Radio, Telecom and Safety consultation. Our laboratories are accredited and approved according to ISO/IEC 17025.

If you have any comments, please feel free to contact us at the following:

Linko EMC/RF Lab:

Tel: 886-2-26052180

Fax: 886-2-26051924

Hsin Chu EMC/RF Lab:

Tel: 886-3-5935343

Fax: 886-3-5935342

Hwa Ya EMC/RF/Safety Telecom Lab:

Tel: 886-3-3183232

Fax: 886-3-3270892

Email: service.adt@tw.bureauveritas.com

Web Site: www.adt.com.tw

The address and road map of all our labs can be found in our web site also.



A D T

8. APPENDIX A - MODIFICATIONS RECORDERS FOR ENGINEERING CHANGES TO THE EUT BY THE LAB

No any modifications are made to the EUT by the lab during the test.

---END---