



# FCC TEST REPORT (PART 24)

**REPORT NO.:** RF120717C01-1

**MODEL NO.:** PM23100

**FCC ID:** NM8PM23100

**RECEIVED:** Jul. 17, 2012

**TESTED:** Jul. 30 ~ Aug. 03, 2012

**ISSUED:** Aug. 13, 2012

**APPLICANT:** HTC Corporation

**ADDRESS:** 23, Xinghua Rd., Taoyuan 330, Taiwan, R.O.C.

**ISSUED BY:** Bureau Veritas Consumer Products Services  
(H.K.) Ltd., Taoyuan Branch

**LAB ADDRESS:** No. 47, 14th Ling, Chia Pau Vil., Lin Kou Dist., New  
Taipei City, Taiwan ( R.O.C. )

**TEST LOCATION:** No. 19, Hwa Ya 2nd Rd, Wen Hwa Tsuen, Kwei  
Shan Hsiang, Taoyuan Hsien 333, Taiwan, R.O.C.

This report should not be used by the client to claim product certification, approval, or endorsement by TAF or any government agencies.



This report is for your exclusive use. Any copying or replication of this report to or for any other person or entity, or use of our name or trademark, is permitted only with our prior written permission. This report sets forth our findings solely with respect to the test samples identified herein. The results set forth in this report are not indicative or representative of the quality or characteristics of the lot from which a test sample was taken or any similar or identical product unless specifically and expressly noted. Our report includes all of the tests requested by you and the results thereof based upon the information that you provided to us. You have 60 days from date of issuance of this report to notify us of any material error or omission caused by our negligence, provided, however, that such notice shall be in writing and shall specifically address the issue you wish to raise. A failure to raise such issue within the prescribed time shall constitute your unqualified acceptance of the completeness of this report, the tests conducted and the correctness of the report contents. Unless specific mention, the uncertainty of measurement has been explicitly taken into account to declare the compliance or non-compliance to the specification



## TABLE OF CONTENTS

RELEASE CONTROL RECORD.....	3
1 CERTIFICATION .....	4
2 SUMMARY OF TEST RESULTS .....	5
2.1 MEASUREMENT UNCERTAINTY .....	5
2.2 TEST SITE AND INSTRUMENTS .....	6
3 GENERAL INFORMATION.....	7
3.1 GENERAL DESCRIPTION OF EUT.....	7
3.2 CONFIGURATION OF SYSTEM UNDER TEST .....	8
3.3 DESCRIPTION OF SUPPORT UNITS .....	9
3.4 TEST ITEM AND TEST CONFIGURATION .....	10
3.5 EUT OPERATING CONDITIONS.....	11
3.6 GENERAL DESCRIPTION OF APPLIED STANDARDS .....	11
4 TEST TYPES AND RESULTS.....	12
4.1 OUTPUT POWER MEASUREMENT .....	12
4.1.1 LIMITS OF OUTPUT POWER MEASUREMENT .....	12
4.1.2 TEST PROCEDURES .....	12
4.1.3 TEST SETUP .....	13
4.1.4 TEST RESULTS .....	14
4.2 FREQUENCY STABILITY MEASUREMENT .....	17
4.2.1 LIMITS OF FREQUENCY STABILITY MEASUREMENT .....	17
4.2.2 TEST PROCEDURE .....	17
4.2.3 TEST SETUP .....	17
4.2.4 TEST RESULTS .....	18
4.3 OCCUPIED BANDWIDTH MEASUREMENT .....	19
4.3.1 TEST PROCEDURES .....	19
4.3.2 TEST SETUP .....	19
4.3.3 TEST RESULTS .....	20
4.4 BAND EDGE MEASUREMENT .....	21
4.4.1 LIMITS OF BAND EDGE MEASUREMENT .....	21
4.4.2 TEST SETUP .....	21
4.4.3 TEST PROCEDURES .....	21
4.4.4 TEST RESULTS .....	22
4.5 CONDUCTED SPURIOUS EMISSIONS.....	24
4.5.1 LIMITS OF CONDUCTED SPURIOUS EMISSIONS MEASUREMENT .....	24
4.5.2 TEST PROCEDURE .....	24
4.5.3 TEST SETUP .....	24
4.5.4 TEST RESULTS .....	25
4.6 RADIATED EMISSION MEASUREMENT .....	26
4.6.1 LIMITS OF RADIATED EMISSION MEASUREMENT .....	26
4.6.2 TEST PROCEDURES .....	26
4.6.3 DEVIATION FROM TEST STANDARD .....	26
4.6.4 TEST SETUP .....	27
4.6.5 TEST RESULTS .....	28
5 PHOTOGRAPHS OF THE TEST CONFIGURATION.....	38
6 INFORMATION ON THE TESTING LABORATORIES.....	39
7 APPENDIX A – MODIFICATIONS RECORDERS FOR ENGINEERING CHANGES TO THE EUT BY THE LAB.....	40



A D T

## RELEASE CONTROL RECORD

ISSUE NO.	REASON FOR CHANGE	DATE ISSUED
RF120717C01-1	Original release	Aug. 13, 2012



# 1 CERTIFICATION

**PRODUCT:** Windows Phone  
**MODEL:** PM23100  
**BRAND:** HTC  
**APPLICANT:** HTC Corporation  
**TESTED:** Jul. 30 ~ Aug. 03, 2012  
**TEST SAMPLE:** Production Unit  
**STANDARDS:** FCC Part 24, Subpart E

The above equipment (model: PM23100) has been tested by **Bureau Veritas Consumer Products Services (H.K.) Ltd., Taoyuan Branch**, and found compliance with the requirement of the above standards. The test record, data evaluation & Equipment Under Test (EUT) configurations represented herein are true and accurate accounts of the measurements of the sample's EMC characteristics under the conditions specified in this report.

**PREPARED BY** :  , **DATE** : Aug. 13, 2012  
Pettie Chen / Senior Specialist

**APPROVED BY** :  , **DATE** : Aug. 13, 2012  
Gary Chang / Technical Manager

## 2 SUMMARY OF TEST RESULTS

The EUT has been tested according to the following specifications:

APPLIED STANDARD: FCC Part 24 & Part 2			
STANDARD SECTION	TEST TYPE	RESULT	REMARK
2.1046 24.232	Equivalent isotropically radiated power	PASS	Meet the requirement of limit.
2.1055 24.235	Frequency Stability	PASS	Meet the requirement of limit.
2.1049 24.238(b)	Occupied Bandwidth	PASS	Meet the requirement of limit.
24.238(b)	Band Edge Measurements	PASS	Meet the requirement of limit.
2.1051 24.238	Conducted Spurious Emissions	PASS	Meet the requirement of limit.
2.1053 24.238	Radiated Spurious Emissions	PASS	Meet the requirement of limit. Minimum passing margin is -17.97dB at 5640.00MHz.

### 2.1 MEASUREMENT UNCERTAINTY

Where relevant, the following measurement uncertainty levels have been estimated for tests performed on the EUT as specified in CISPR 16-4-2:

MEASUREMENT	FREQUENCY	UNCERTAINTY
Conducted emissions	150kHz~30MHz	2.44 dB
Radiated emissions	30MHz ~ 200MHz	2.93 dB
	200MHz ~1000MHz	2.95 dB
	1GHz ~ 18GHz	2.26 dB
	18GHz ~ 40GHz	1.94 dB

This uncertainty represents an expanded uncertainty expressed at approximately the 95% confidence level using a coverage factor of k=2.

## 2.2 TEST SITE AND INSTRUMENTS

DESCRIPTION & MANUFACTURER	MODEL NO.	SERIAL NO.	DATE OF CALIBRATION	DUE DATE OF CALIBRATION
Test Receiver Agilent	N9038A	MY51210203	Dec. 22, 2011	Dec. 21, 2012
Spectrum Analyzer ROHDE & SCHWARZ	FSU43	101261	Dec. 21, 2011	Dec. 20, 2012
BILOG Antenna SCHWARZBECK	VULB9168	9168-472	Dec. 20, 2011	Dec. 19, 2012
HORN Antenna SCHWARZBECK	BBHA 9120 D	9120D-969	Dec. 20, 2011	Dec. 19, 2012
ORN Antenna SCHWARZBECK	BBHA 9170	9170-480	Dec. 20, 2011	Dec. 19, 2012
Preamplifier EMCI	EMC 012645	980115	Dec. 30, 2011	Dec. 29, 2012
Preamplifier EMCI	EMC 330H	980112	Dec. 30, 2011	Dec. 29, 2012
RF signal cable HUBER+SUHNNER	SUCOFLEX 104	309219/4	Oct. 21, 2011	Oct. 20, 2012
RF signal cable HUBER+SUHNNER	SUCOFLEX 104	250130/4	Jan. 02, 2012	Jan. 01, 2013
RF signal cable Worken	RG-213	NA	Jan. 02, 2012	Jan. 01, 2013
Software	E3 6.120103	NA	NA	NA
Antenna Tower MF	MFA-440H	NA	NA	NA
Turn Table MF	MFT-201SS	NA	NA	NA
Antenna Tower & Turn Table Controller MF	MF-7802	NA	NA	NA
Mini-Circuits Power Splitter	ZN2PD-9G	NA	Mar. 23, 2012	Mar. 22, 2013
JFW 20dB attenuation	50HF-020-SMA	NA	NA	NA
Communications Tester-Wireless	E5515C	MY50266653	Sep. 28, 2011	Sep. 27, 2012
Radio Communication Analyzer	MT8820C	6201127458	May 25, 2012	May 24, 2013

**NOTE:** 1. The calibration interval of the above test instruments is 12 months and the calibrations are traceable to NML/ROC and NIST/USA.

2. The test was performed in HwaYa Chamber 9.

3. The horn antenna and HP preamplifier (model: 8449B) are used only for the measurement of emission frequency above 1GHz if tested.

4. The FCC Site Registration No. is 460141.

5. The IC Site Registration No. is IC 7450F-4.

### 3 GENERAL INFORMATION

#### 3.1 GENERAL DESCRIPTION OF EUT

<b>EUT</b>	Windows Phone	
<b>MODEL NO.</b>	PM23100	
<b>POWER SUPPLY</b>	5.0Vdc (adapter or host equipment) 3.75Vdc (battery)	
<b>MODULATION TYPE</b>	<b>GSM/GPRS</b>	GMSK
	<b>EDGE</b>	8PSK
	<b>WCDMA</b>	BPSK
	<b>CDMA</b>	QPSK, OQPSK, HPSK
<b>FREQUENCY RANGE</b>	<b>GSM/GPRS/EDGE</b>	1850.2MHz ~ 1909.8MHz
	<b>WCDMA</b>	1852.4MHz ~ 1907.6MHz
	<b>CDMA</b>	1851.3MHz ~ 1908.8MHz
<b>MAX. EIRP POWER</b>	<b>GSM</b>	767.36mW
	<b>EDGE</b>	313.33mW
	<b>WCDMA</b>	190.99mW
	<b>CDMA</b>	181.97mW
<b>EMISSION DESIGNATOR</b>	<b>GSM</b>	247KGXW
	<b>EDGE</b>	244KG7W
	<b>WCDMA</b>	4M18F9W
	<b>CDMA</b>	1M28F9W
<b>MULTI-SLOTS CLASS</b>	12	
<b>WCDMA RELEASE VERSION</b>	6	
<b>ANTENNA TYPE</b>	<b>GSM</b>	Fixed Internal antenna with -0.88dBi gain
	<b>EDGE</b>	
	<b>WCDMA</b>	
	<b>CDMA</b>	
<b>I/O PORTS</b>	Refer to users' manual	
<b>DATA CABLE</b>	Refer to NOTE as below	
<b>ACCESSORY DEVICES</b>	Refer to NOTE as below	

**NOTE:**

- The EUT's accessories list refers to Ext Pho.pdf.  
\* Item 2, 3, 5, 6, 7, 8 were the worst for the final test.
- The above EUT information was declared by manufacturer and for more detailed features description, please refer to the manufacturer's specifications or User's Manual.

### 3.2 CONFIGURATION OF SYSTEM UNDER TEST

#### FOR RADIATION EMISSION TEST

##### Tset Mode A

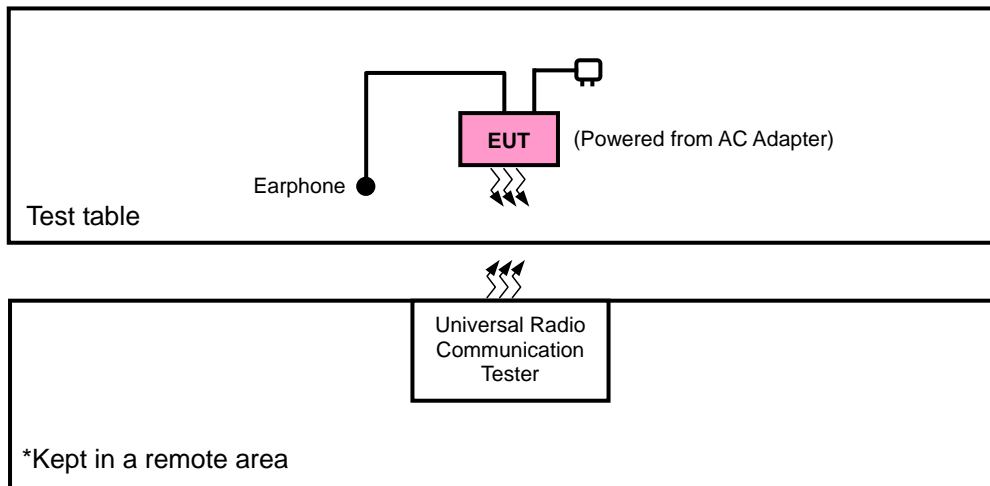

##### Tset Mode B

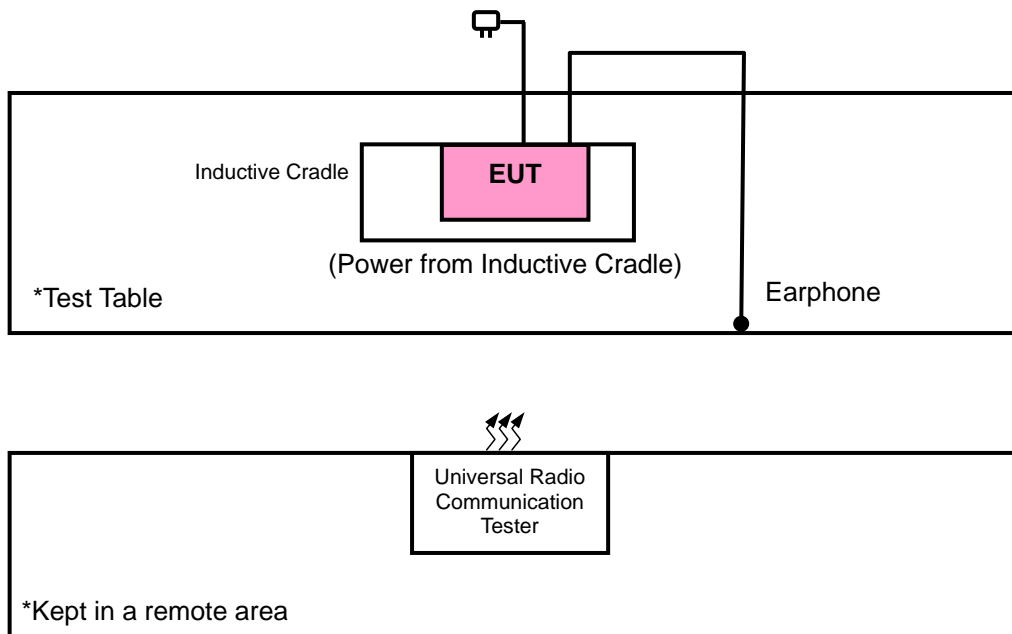



**FOR E.I.R.P. TEST**

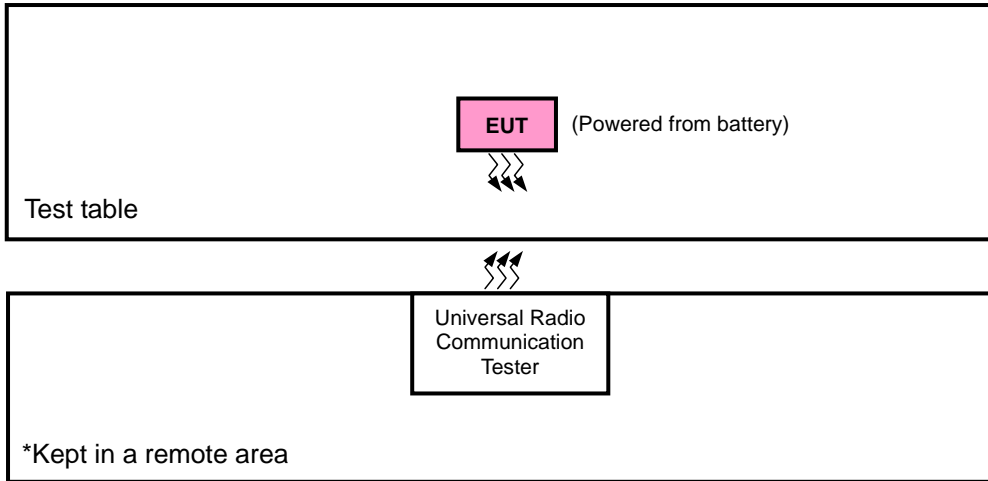

**3.3 DESCRIPTION OF SUPPORT UNITS**

The EUT has been tested as an independent unit together with other necessary accessories or support units. The following support units or accessories were used to form a representative test configuration during the tests.

NO.	PRODUCT	BRAND	MODEL NO.	SERIAL NO.	FCC ID
1	Earphone	HTC	HS G400	NA	NA
2	Inductive Cradle	Energizer	IC2B	NA	NA

NO.	SIGNAL CABLE DESCRIPTION OF THE ABOVE SUPPORT UNITS
1	1m non-shielded cable without core
2	NA

**NOTE:**

1. All power cords of the above support units are non shielded (1.8m).
2. Item 1, 2 were provided by client.

### 3.4 TEST ITEM AND TEST CONFIGURATION

Pre-Scan has been conducted to determine the worst-case mode from all possible combinations between available modulations, data rates, XYZ axis and antenna ports. The worst case was found when positioned on Y-plane for EIRP and X-axis for GSM/EDGE/WCDMA/CDMA for radiated emission. Following channel(s) was (were) selected for the final test as listed below:

EUT CONFIGURE MODE	DESCRIPTION
A	Normal link
B	Wireless charge

#### GSM MODE

EUT CONFIGURE MODE	TEST ITEM	AVAILABLE CHANNEL	TESTED CHANNEL	MODE
A	EIRP	512 to 810	512, 661, 810	GSM, EDGE
A	FREQUENCY STABILITY	512 to 810	661	GSM, EDGE
A	OCCUPIED BANDWIDTH	512 to 810	512, 661, 810	GSM, EDGE
A	BAND EDGE	512 to 810	512, 810	GSM, EDGE
A	CONDCUDED EMISSION	512 to 810	661	GSM
A	RADIATED EMISSION	512 to 810	661	GSM, EDGE
B	RADIATED EMISSION	512 to 810	661	GSM

#### WCDMA MODE

EUT CONFIGURE MODE	TEST ITEM	AVAILABLE CHANNEL	TESTED CHANNEL	MODE
A	EIRP	9262 to 9538	9262, 9400, 9538	WCDMA
A	FREQUENCY STABILITY	9262 to 9538	9400	WCDMA
A	OCCUPIED BANDWIDTH	9262 to 9538	9262, 9400, 9538	WCDMA
A	BAND EDGE	9262 to 9538	9262, 9538	WCDMA
A	CONDCUDED EMISSION	9262 to 9538	9400	WCDMA
A	RADIATED EMISSION	9262 to 9538	9400	WCDMA



A D T

## CDMA MODE

EUT CONFIGURE MODE	TEST ITEM	AVAILABLE CHANNEL	TESTED CHANNEL	MODE
A	EIRP	25 to 1175	25, 600, 1175	1xRTT
A	FREQUENCY STABILITY	25 to 1175	600	1xRTT
A	OCCUPIED BANDWIDTH	25 to 1175	25, 600, 1175	1xRTT
A	BAND EDGE	25 to 1175	25, 1175	1xRTT
A	CONDCUDED EMISSION	25 to 1175	600	1xRTT
A	RADIATED EMISSION	25 to 1175	600	1xRTT

### TEST CONDITION:

TEST ITEM	ENVIRONMENTAL CONDITIONS	INPUT POWER	TESTED BY
EIRP	26deg. C, 58%RH	3.75Vdc	Phoenix Chen
FREQUENCY STABILITY	26deg. C, 58%RH	3.75Vdc	Phoenix Chen
OCCUPIED BANDWIDTH	26deg. C, 58%RH	3.75Vdc	Phoenix Chen
BAND EDGE	26deg. C, 58%RH	3.75Vdc	Phoenix Chen
CONDCUDED EMISSION	26deg. C, 58%RH	3.75Vdc	Phoenix Chen
RADIATED EMISSION	25deg. C, 65%RH	120Vac, 60Hz	Kay Wu

### 3.5 EUT OPERATING CONDITIONS

The EUT makes a call to the communication simulator. The communication simulator station system controlled a EUT to export maximum output power under transmission mode and specific channel frequency

### 3.6 GENERAL DESCRIPTION OF APPLIED STANDARDS

The EUT is a RF product. According to the specifications of the manufacturer, it must comply with the requirements of the following standards:

**FCC 47 CFR Part 2**

**FCC 47 CFR Part 24**

**ANSI/TIA/EIA-603-C 2004**

**NOTE:** All test items have been performed and recorded as per the above standards.

## 4 TEST TYPES AND RESULTS

### 4.1 OUTPUT POWER MEASUREMENT

#### 4.1.1 LIMITS OF OUTPUT POWER MEASUREMENT

Mobile and portable stations are limited to 2 watts EIRP

#### 4.1.2 TEST PROCEDURES

##### **EIRP MEASUREMENT:**

- a. All measurements were done at low, middle and high operational frequency range. RBW and VBW is 1MHz for GSM, GPRS & EDGE, 5MHz for WCDMA and CDMA mode.
- b. Substitution method is used for E.I.R.P measurement. In the semi-anechoic chamber, EUT placed on the 0.8m height of Turn Table, rotated the table around 360 degrees to search the maximum radiation power and receiver antenna shall be rotated vertical and horizontal polarization and moved height from 1m to 4m to find the maximum polar radiated power. The “Read Value” is the spectrum reading the maximum power value.
- c. The substitution horn antenna is substituted for EUT at the same position and signals generator export the CW signal to the substitution antenna via a tx cable. Rotated the Turn Table and moved receiving antenna to find the maximum radiation power. Adjust output power level of S.G to get a Value of spectrum reading equal to “Read Value” of step b. Record the power level of S.G
- d.  $EIRP = \text{Output power level of S.G} - \text{TX cable loss} + \text{Antenna gain of substitution horn.}$

##### **CONDUCTED POWER MEASUREMENT:**

The EUT was set up for the maximum power with GSM, GPRS, EDGE, WCDMA & CDMA link data modulation and link up with simulator. Set the EUT to transmit under low, middle and high channel and record the power level shown on simulator.

### 4.1.3 TEST SETUP

#### EIRP MEASUREMENT:

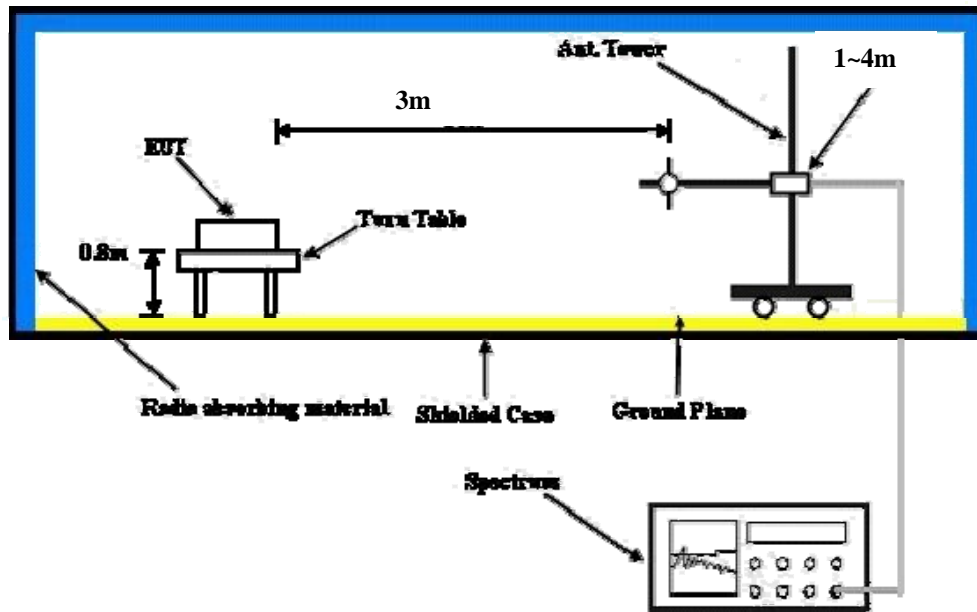

For the actual test configuration, please refer to the attached file (Test Setup Photo).

#### CONDUCTED POWER MEASUREMENT:

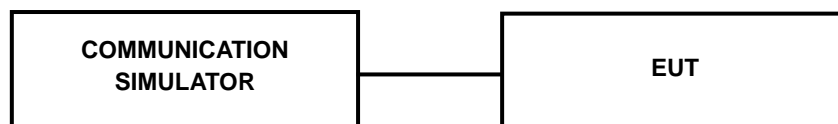

For the actual test configuration, please refer to the attached file (Test Setup Photo).



A D T

#### 4.1.4 TEST RESULTS

##### CONDUCTED OUTPUT POWER (dBm)

Band	GSM1900		
Channel	512	661	810
Frequency (MHz)	1850.2	1880.0	1909.8
GSM (1 Uplink)	31.03	30.66	30.52
GPRS 8 (GMSK, 1 slot)	30.79	30.68	30.54
GPRS 10 (GMSK, 2 slot)	29.12	29.05	28.86
GPRS 11 (GMSK, 3 Uplink)	27.61	27.55	27.26
GPRS 12 (GMSK, 4 Uplink)	26.36	26.10	25.62
EDGE 8 (8PSK, 1 Uplink)	26.89	26.73	26.50
EDGE 10 (8PSK, 2 Uplink)	26.71	26.51	26.27
EDGE 11 (8PSK, 3 Uplink)	26.53	26.28	25.99
EDGE 12 (8PSK, 4 Uplink)	26.27	25.97	25.67

Band	WCDMA II		
Channel	9262	9400	9538
Frequency (MHz)	1852.4	1880.0	1907.6
RMC 12.2K	24.30	24.03	24.46
HSDPA Subtest-1	23.25	23.39	23.55
HSDPA Subtest-2	23.26	23.44	23.47
HSDPA Subtest-3	22.65	22.84	22.92
HSDPA Subtest-4	22.66	22.81	22.99
HSUPA Subtest-1	22.71	22.72	22.71
HSUPA Subtest-2	20.26	20.29	20.34
HSUPA Subtest-3	21.94	22.28	21.89
HSUPA Subtest-4	22.54	22.83	22.84
HSUPA Subtest-5	23.17	23.29	23.41

Band	CDMA		
Channel	25	600	1175
Frequency (MHz)	1851.25	1880	1908.75
RC1+SO55	24.57	24.78	24.61
RC3+SO55	24.55	24.75	24.56
RC3+SO32(+ F-SCH)	24.49	24.72	24.51
RC3+SO32(+SCH)	24.49	24.70	24.48



## EIRP POWER (dBm)

### GSM

Plane	Channel	Frequency (MHz)	LVL (dBm)	Correction Factor(dB)	EIRP(dBm)	EIRP(mW)	Polarization (H/V)
Y	512	1850.2	-16.99	38.19	21.20	131.83	H
	661	1880.0	-17.12	38.70	21.58	143.88	H
	810	1909.8	-16.68	39.35	22.67	184.93	H
	512	1850.2	-10.39	38.48	28.09	644.17	V
	661	1880.0	-10.15	38.59	28.44	698.23	V
	810	1909.8	-10.02	38.87	28.85	767.36	V

### EDGE

Plane	Channel	Frequency (MHz)	LVL (dBm)	Correction Factor(dB)	EIRP(dBm)	EIRP(mW)	Polarization (H/V)
Y	512	1850.2	-20.55	38.19	17.64	58.08	H
	661	1880.0	-20.99	38.70	17.71	59.02	H
	810	1909.8	-20.48	39.35	18.87	77.09	H
	512	1850.2	-14.22	38.48	24.26	266.69	V
	661	1880.0	-14.27	38.59	24.32	270.40	V
	810	1909.8	-13.91	38.87	24.96	313.33	V

### WCDMA

Plane	Channel	Frequency (MHz)	LVL (dBm)	Correction Factor(dB)	EIRP(dBm)	EIRP(mW)	Polarization (H/V)
Y	9262	1852.4	-20.07	38.19	18.12	64.86	H
	9400	1880.0	-19.56	38.70	19.14	82.04	H
	9538	1907.6	-20.37	39.35	18.98	79.07	H
	9262	1852.4	-16.38	38.48	22.10	162.18	V
	9400	1880.0	-15.78	38.59	22.81	190.99	V
	9538	1907.6	-16.76	38.87	22.11	162.55	V



A D T

### CDMA

Plane	Channel	Frequency (MHz)	LVL (dBm)	Correction Factor(dB)	EIRP(dBm)	EIRP(mW)	Polarization (H/V)
Y	25	1851.3	-20.74	38.19	17.45	55.59	H
	600	1880.0	-21.14	38.70	17.56	57.02	H
	1175	1908.8	-22.31	39.35	17.04	50.58	H
	25	1851.3	-15.99	38.48	22.49	177.42	V
	600	1880.0	-15.99	38.59	22.60	181.97	V
	1175	1908.8	-16.39	38.87	22.48	177.01	V



## 4.2 FREQUENCY STABILITY MEASUREMENT

### 4.2.1 LIMITS OF FREQUENCY STABILITY MEASUREMENT

The frequency stability shall be sufficient to ensure that the fundamental emission stays within the authorized frequency block.

### 4.2.2 TEST PROCEDURE

- a. Device is placed at the oven room. The oven room could control the temperatures and humidity. Power warm up is at least 15 min and power applied should perform before recording frequency error.
- b. EUT is connected the external power supply to control the DC input power. The test voltage range is from minimum to maximum working voltage. Each step shall be record the frequency error rate.
- c. The temperature range step is 10 degrees in this test items. All temperature levels shall be hold the  $\pm 0.5^{\circ}\text{C}$  during the measurement testing. The each temperature step shall be at least 0.5 hours, consider the EUT could be test under the stability condition.

**NOTE:** The frequency error was recorded frequency error from the communication simulator.

### 4.2.3 TEST SETUP

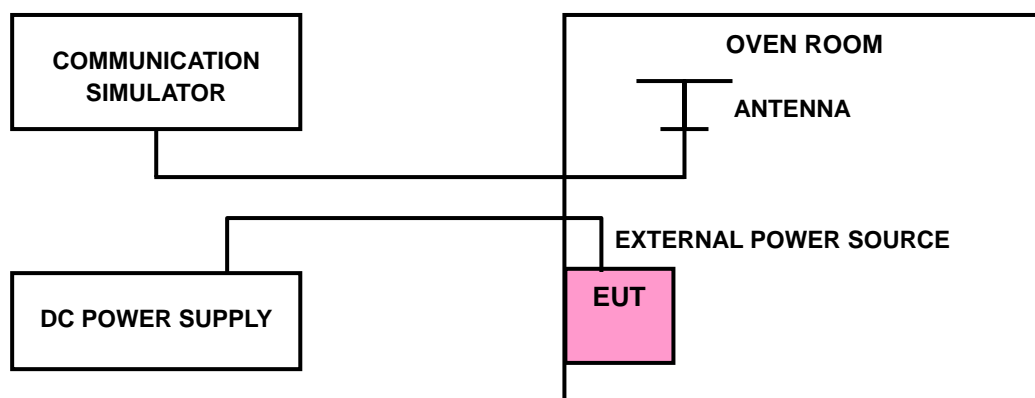

#### 4.2.4 TEST RESULTS

##### FREQUENCY ERROR VS. VOLTAGE

VOLTAGE (Volts)	FREQUENCY ERROR (ppm)				LIMIT (ppm)
	GPRS	EDGE	WCDMA	CDMA	
3.75	-0.0186	0.0130	-0.0057	0.0038	2.5
3.6	-0.0186	0.0140	-0.0056	0.0034	2.5
4.3	-0.0169	0.0158	-0.0052	0.0059	2.5

**NOTE:** The applicant defined the normal working voltage of the battery is from 3.6Vdc to 4.3Vdc.

##### FREQUENCY ERROR vs. TEMPERATURE.

TEMP. (°C)	FREQUENCY ERROR (ppm)				LIMIT (ppm)
	GPRS	EDGE	WCDMA	CDMA	
-10	-0.0192	0.0139	-0.0051	0.0041	2.5
0	-0.0201	0.0109	-0.0052	0.0038	2.5
10	-0.0189	0.0119	-0.0060	0.0035	2.5
20	-0.0178	0.0136	-0.0059	0.0039	2.5
30	-0.0180	0.0150	-0.0055	0.0036	2.5
40	-0.0188	0.0125	-0.0062	0.0039	2.5
50	-0.0180	0.0114	-0.0050	0.0039	2.5
55	-0.0180	0.0106	-0.0050	0.0042	2.5

### 4.3 OCCUPIED BANDWIDTH MEASUREMENT

#### 4.3.1 TEST PROCEDURES

The EUT makes a call to the communication simulator. All measurements were done at low, middle and high operational frequency range. The communication simulator station system controlled a EUT to export maximum output power under transmission mode and specific channel frequency. Use OBW measurement function of Spectrum analyzer to measure 99 % occupied bandwidth.

#### 4.3.2 TEST SETUP

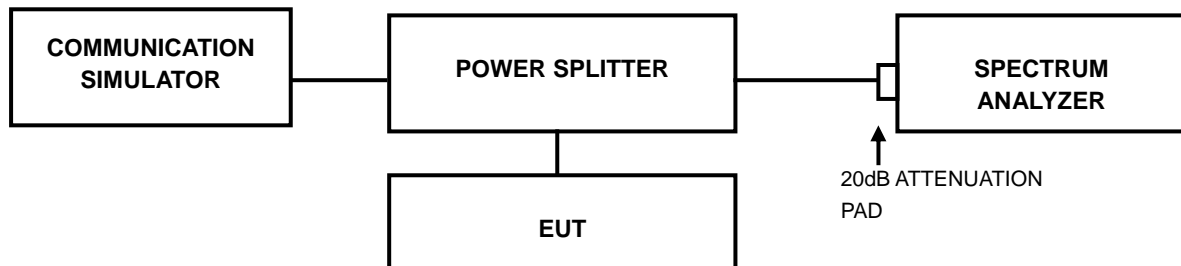



A D T

### 4.3.3 TEST RESULTS

CHANNEL	FREQUENCY (MHz)	99% OCCUPIED BANDWIDTH (kHz)		CHANNEL	FREQUENCY (MHz)	99% OCCUPIED BANDWIDTH (MHz)
		GSM	EDGE			WCDMA
512	1850.2	243.55	242.16	9262	1852.4	4.1765
661	1880.0	246.83	244.08	9400	1880.0	4.1778
810	1909.8	244.12	243.00	9538	1907.6	4.1712

CHANNEL	FREQUENCY (MHz)	99% OCCUPIED BANDWIDTH (MHz)
		CDMA
1013	824.70	1.2769
384	836.52	1.2749
777	848.31	1.2762

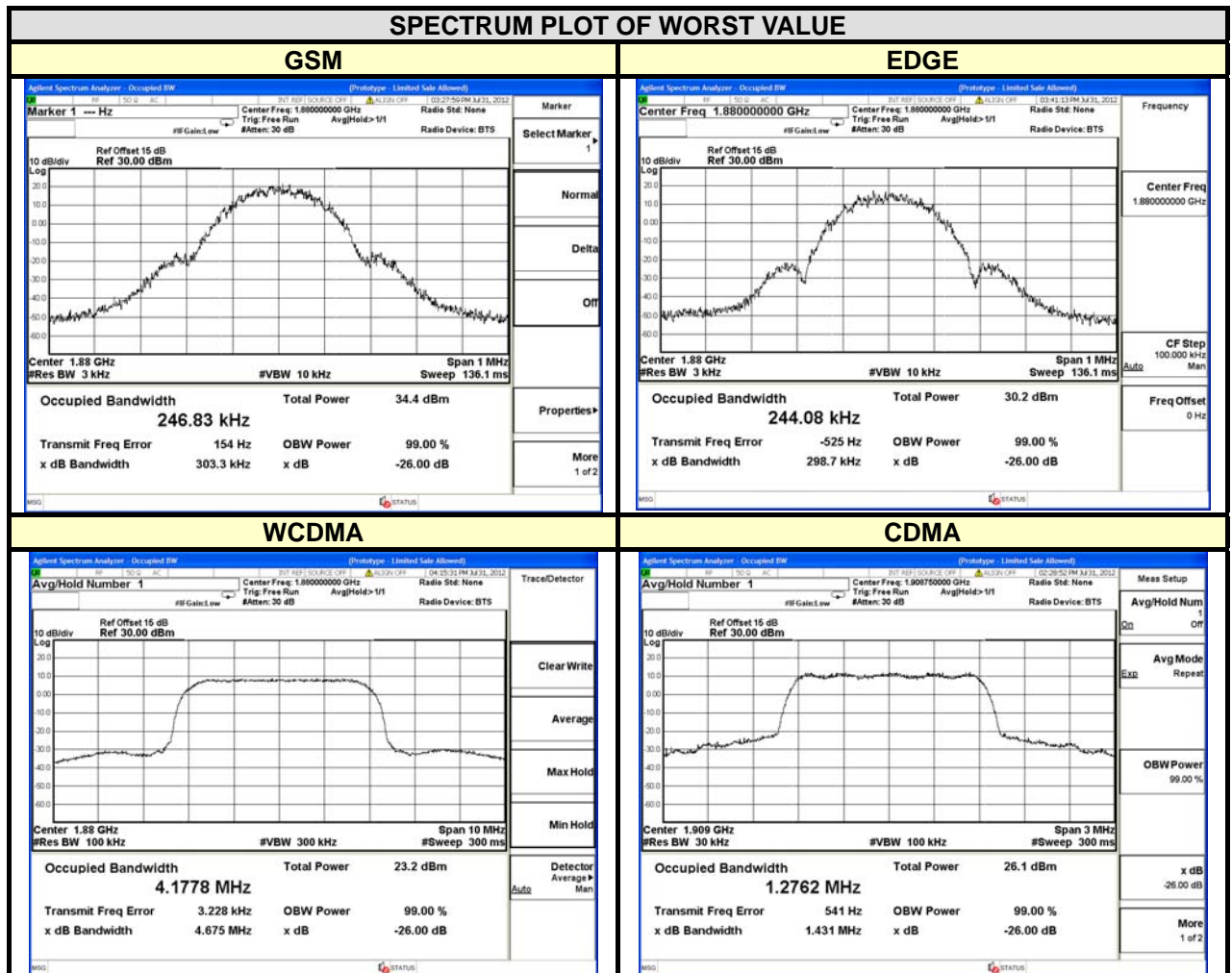

## 4.4 BAND EDGE MEASUREMENT

### 4.4.1 LIMITS OF BAND EDGE MEASUREMENT

Power of any emission outside of the authorized operating frequency ranges must be attenuated below the transmitting power (P) by a factor of at least  $43 + 10 \log(P)$  dB. In the 1 MHz bands immediately outside and adjacent to the frequency block a resolution bandwidth of at least one percent of the emission bandwidth of the fundamental emission of the transmitter may be employed.

### 4.4.2 TEST SETUP

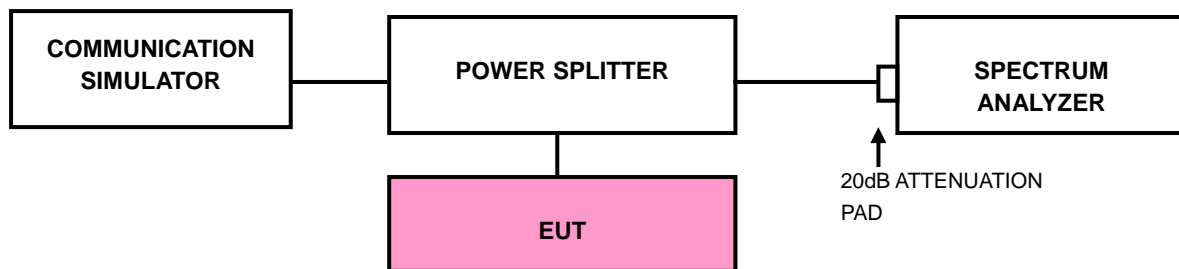

### 4.4.3 TEST PROCEDURES

- a. All measurements were done at low and high operational frequency range.
- b. The center frequency of spectrum is the band edge frequency and span is 1 MHz. RB of the spectrum is 3kHz and VB of the spectrum is 10kHz (GSM/GPRS/ EDGE).
- c. The center frequency of spectrum is the band edge frequency and span is 5MHz. RB of the spectrum is 100kHz and VB of the spectrum is 300kHz (WCDMA).
- d. The center frequency of spectrum is the band edge frequency and span is 2MHz. RB of the spectrum is 13kHz and VB of the spectrum is 51kHz (CDMA).
- e. Record the max trace plot into the test report.



A D T

### 4.4.4 TEST RESULTS

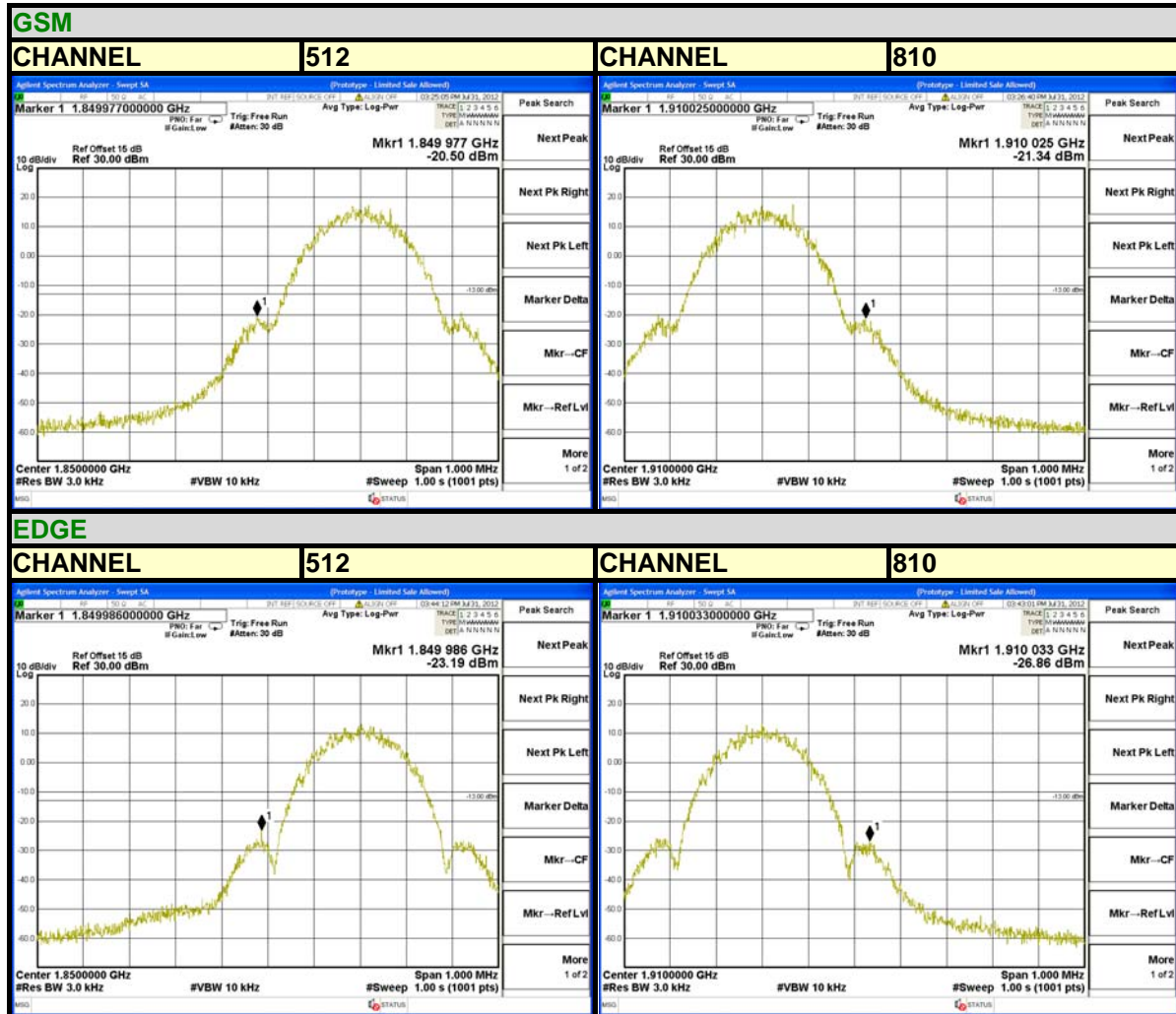



A D T

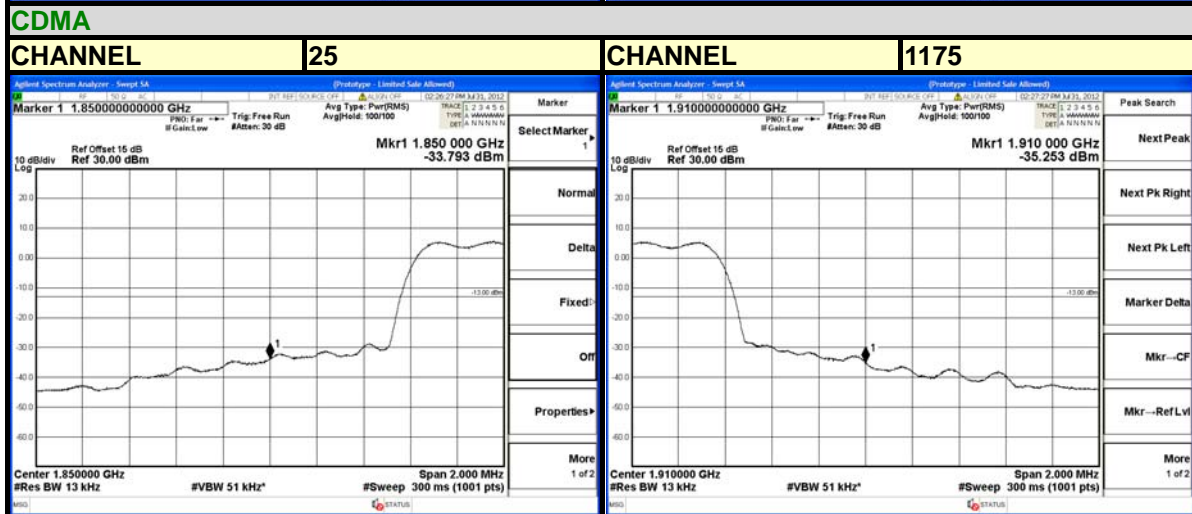
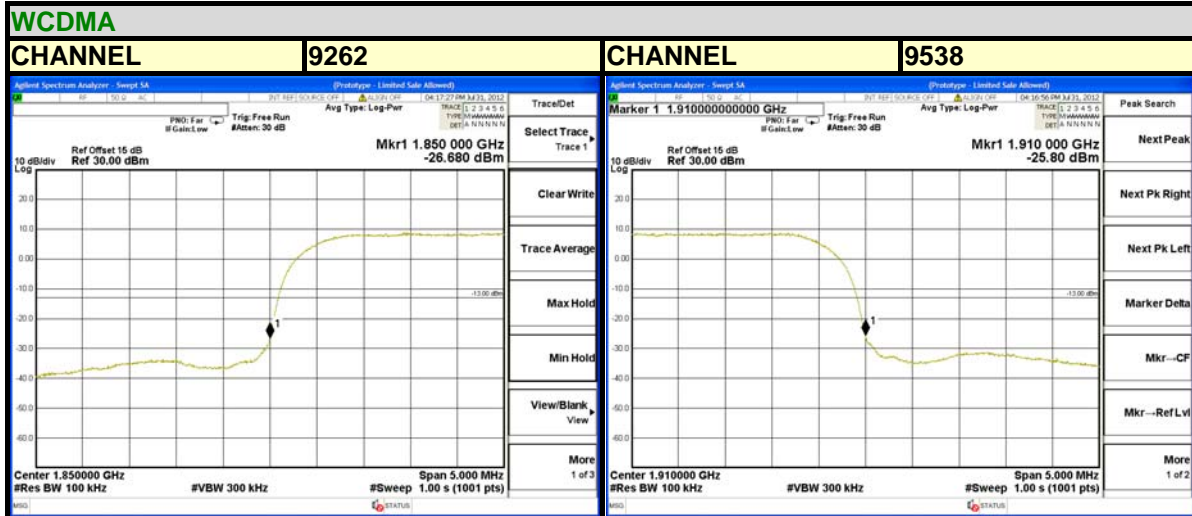

## 4.5 CONDUCTED SPURIOUS EMISSIONS

### 4.5.1 LIMITS OF CONDUCTED SPURIOUS EMISSIONS MEASUREMENT

The power of any emission outside of the authorized operating frequency ranges must be attenuated below the transmitting power (P) by a factor of at least  $43 + 10 \log(P)$  dB. The emission limit equal to  $-13\text{dBm}$ .

### 4.5.2 TEST PROCEDURE

- a. The EUT makes a phone call to the communication simulator. All measurements were done at low, middle and high operational frequency range.
- b. Measuring frequency range is from 30 MHz to 19.1GHz. 10dB attenuation pad is connected with spectrum. RBW=1MHz and VBW=3MHz is used for conducted emission measurement.

### 4.5.3 TEST SETUP

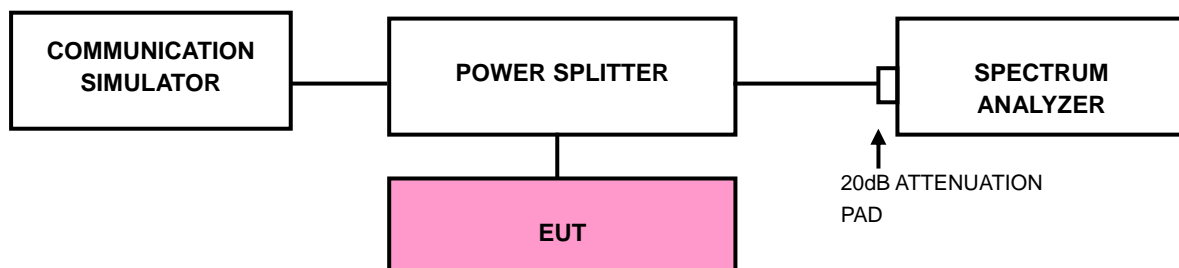





A D T

### 4.5.4 TEST RESULTS

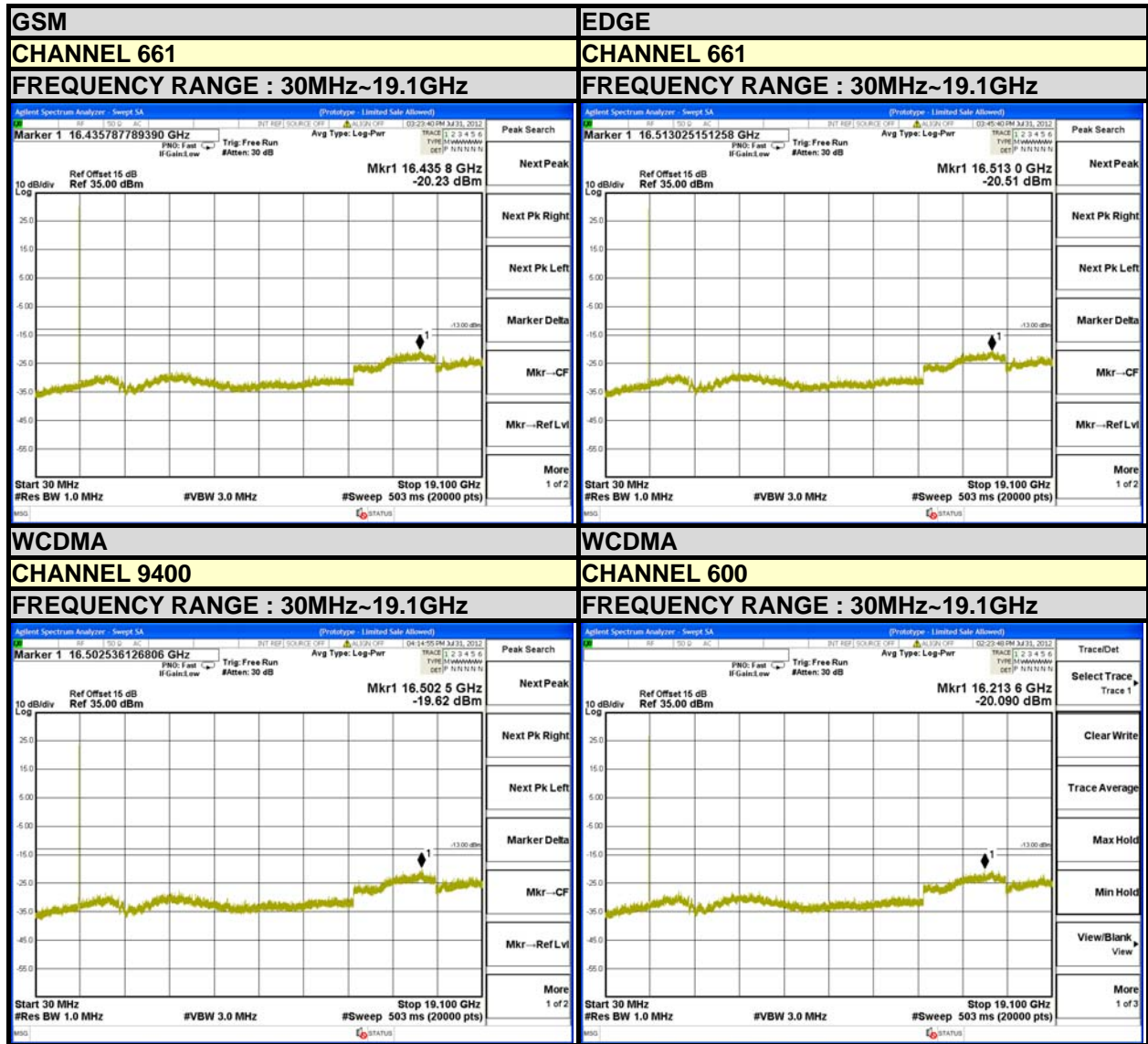

## 4.6 RADIATED EMISSION MEASUREMENT

### 4.6.1 LIMITS OF RADIATED EMISSION MEASUREMENT

The power of any emission outside of the authorized operating frequency ranges must be attenuated below the transmitting power (P) by a factor of at least  $43 + 10 \log(P)$  dB. The emission limit equal to  $-13\text{dBm}$ .

### 4.6.2 TEST PROCEDURES

- a. Substitution method is used for E.I.R.P measurement. In the semi-anechoic chamber, EUT placed on the 0.8m height of Turn Table, rotated the table around 360 degrees to search the maximum radiation power and receiver antenna shall be rotated vertical and horizontal polarization and moved height from 1m to 4m to find the maximum polar radiated power. The “Read Value” is the spectrum reading the maximum power value.
- b. The substitution horn antenna is substituted for EUT at the same position and signals generator export the CW signal to the substitution antenna via a TX cable. Rotated the Turn Table and moved receiving antenna to find the maximum radiation power. Adjust output power level of S.G to get a Value of spectrum reading equal to “Read Value” of step a. Record the power level of S.G
- c.  $\text{EIRP} = \text{Output power level of S.G} - \text{TX cable loss} + \text{Antenna gain of substitution horn}$ .
- d. E.R.P power can be calculated form E.I.R.P power by subtracting the gain of dipole,  
 $\text{E.R.P power} = \text{E.I.P.R power} - 2.15\text{dBi}$ .

**NOTE:** The resolution bandwidth and video bandwidth of test receiver/spectrum analyzer is 1MHz/3MHz.

### 4.6.3 DEVIATION FROM TEST STANDARD

No deviation

#### 4.6.4 TEST SETUP

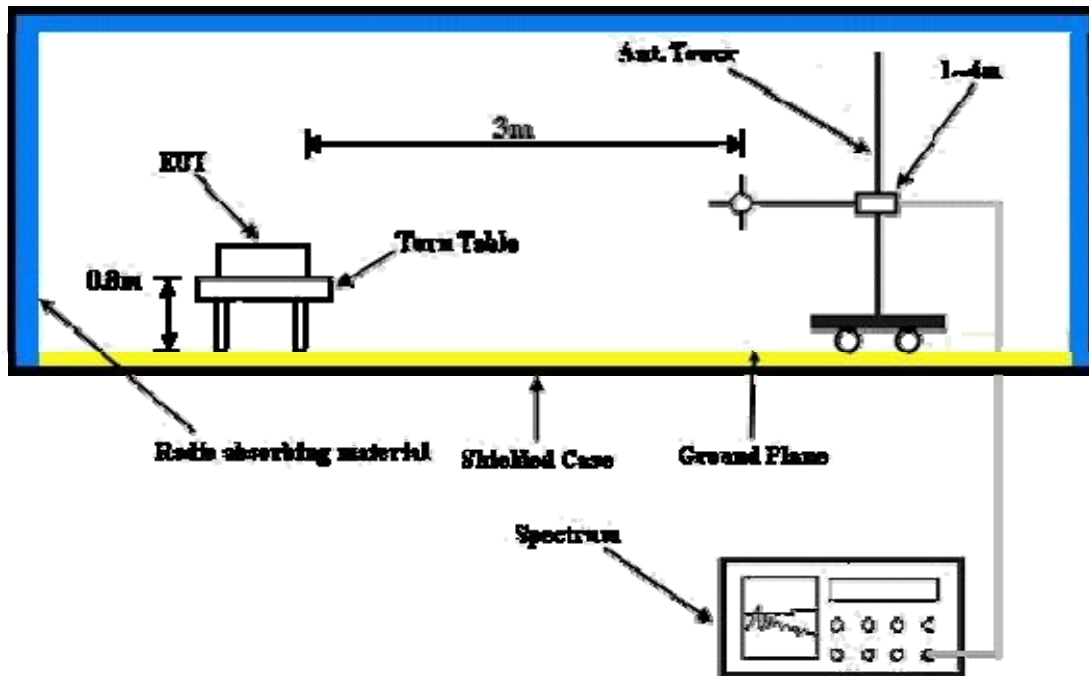

For the actual test configuration, please refer to the attached file (Test Setup Photo).



A D T

### 4.6.5 TEST RESULTS

Test Mode A

GSM:



Bureau Veritas Consumer Products Services Ltd., Taoyuan Branch

A D T

Data: 15

Date: 2012-07-30

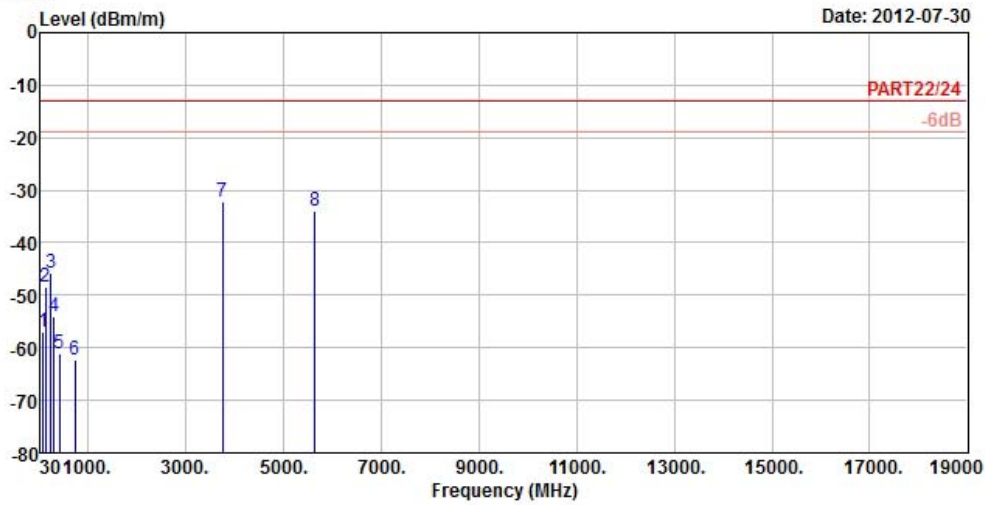

Site : 966 Chamber 5  
 Condition : PART22/24 3m EIRP\_RSE\_1G~19G\_3 HORIZONTAL  
 Brand/Model: PM23100  
 Remark : PCS1900 Link  
 Tested by : Kay Wu  
 Temperature : 25°C  
 Humidity : 65%  
 Plane : X

	Freq	Level	Read	Limit	Over		
	MHz	dBm/m	Level	Line	Limit	Factor	Remark
			dBm	dBm/m	dB	dB/m	
1	84.54	-57.02	-46.63	-13.00	-44.02	-10.39	Peak
2	124.50	-48.49	-38.68	-13.00	-35.49	-9.81	Peak
3	246.27	-45.76	-39.91	-13.00	-32.76	-5.85	Peak
4	300.00	-53.88	-47.50	-13.00	-40.88	-6.38	Peak
5	414.10	-61.04	-55.77	-13.00	-48.04	-5.27	Peak
6	729.80	-62.42	-64.07	-13.00	-49.42	1.65	Peak
7 pp	3760.00	-32.19	-25.46	-13.00	-19.19	-6.73	Peak
8	5640.00	-33.81	-34.02	-13.00	-20.81	0.21	Peak



A D T



Bureau Veritas Consumer Products Services Ltd., Taoyuan Branch

A D T

Data: 16

Date: 2012-07-30

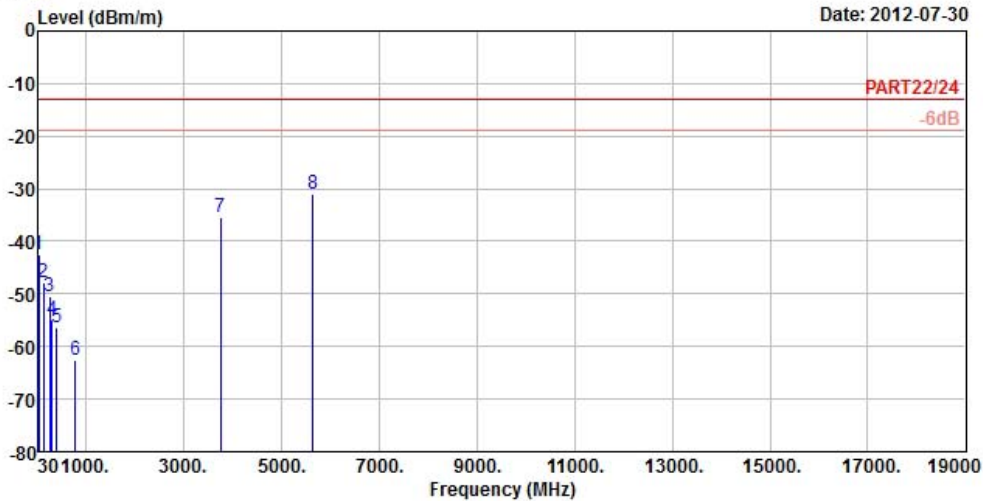

Site : 966 Chamber 5  
 Condition : PART22/24 3m EIRP\_RSE\_1G~19G\_3 VERTICAL  
 Brand/Model: PM23100  
 Remark : PCS1900 Link  
 Tested by : Kay Wu  
 Temperature : 25°C  
 Humidity : 65%  
 Plane : X

	Freq	Level	Read Level	Limit Line	Over Limit	Factor	Remark
	MHz	dBm/m	dBm	dBm/m	dB	dB/m	
1	30.27	-42.37	-43.44	-13.00	-29.37	1.07	Peak
2	124.50	-47.80	-37.99	-13.00	-34.80	-9.81	Peak
3	251.94	-50.60	-44.89	-13.00	-37.60	-5.71	Peak
4	301.40	-54.97	-48.60	-13.00	-41.97	-6.37	Peak
5	407.80	-56.27	-50.83	-13.00	-43.27	-5.44	Peak
6	775.30	-62.45	-64.41	-13.00	-49.45	1.96	Peak
7	3760.00	-35.30	-28.57	-13.00	-22.30	-6.73	Peak
8 pp	5640.00	-30.97	-31.18	-13.00	-17.97	0.21	Peak



A D T

EDGE:



Bureau Veritas Consumer Products Services Ltd., Taoyuan Branch

A D T

Data: 15

Date: 2012-07-31

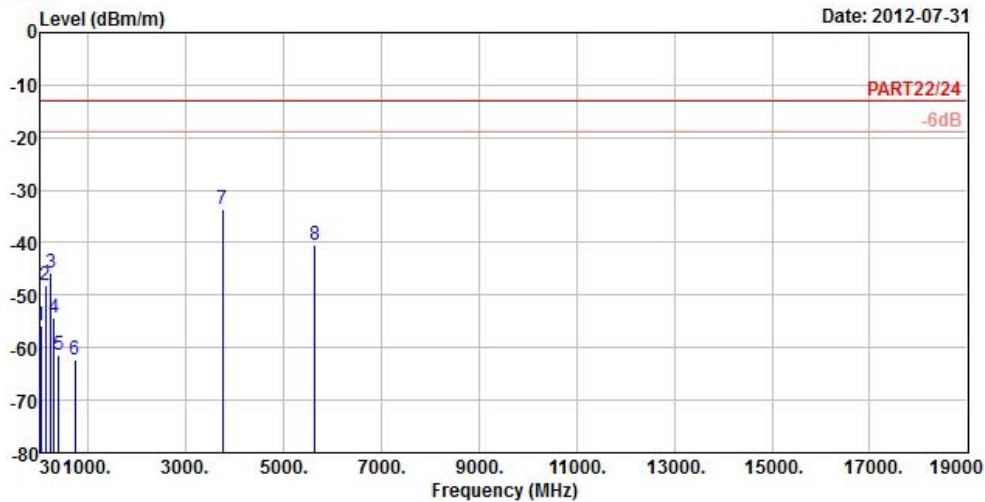

Site : 966 Chamber 5  
 Condition : PART22/24 3m EIRP\_RSE\_1G~19G\_3 HORIZONTAL  
 Brand/Model: PM23100  
 Remark : EDGE1900 Link  
 Tested by : Kay Wu  
 Temperature : 25°C  
 Humidity : 65%  
 Plane : X

	Freq	Level	Read Level	Limit Line	Over Limit	Factor	Remark
	MHz	dBm/m	dBm	dBm/m	dB	dB/m	
1	30.54	-55.73	-56.07	-13.00	-42.73	0.34	Peak
2	123.96	-48.20	-38.39	-13.00	-35.20	-9.81	Peak
3	245.73	-45.73	-39.83	-13.00	-32.73	-5.90	Peak
4	304.90	-54.44	-48.10	-13.00	-41.44	-6.34	Peak
5	393.10	-61.30	-55.61	-13.00	-48.30	-5.69	Peak
6	737.50	-62.17	-63.87	-13.00	-49.17	1.70	Peak
7 pp	3760.00	-33.72	-26.99	-13.00	-20.72	-6.73	Peak
8	5640.00	-40.30	-40.51	-13.00	-27.30	0.21	Peak



A D T



Bureau Veritas Consumer Products Services Ltd., Taoyuan Branch

A D T

Data: 16

Date: 2012-07-31

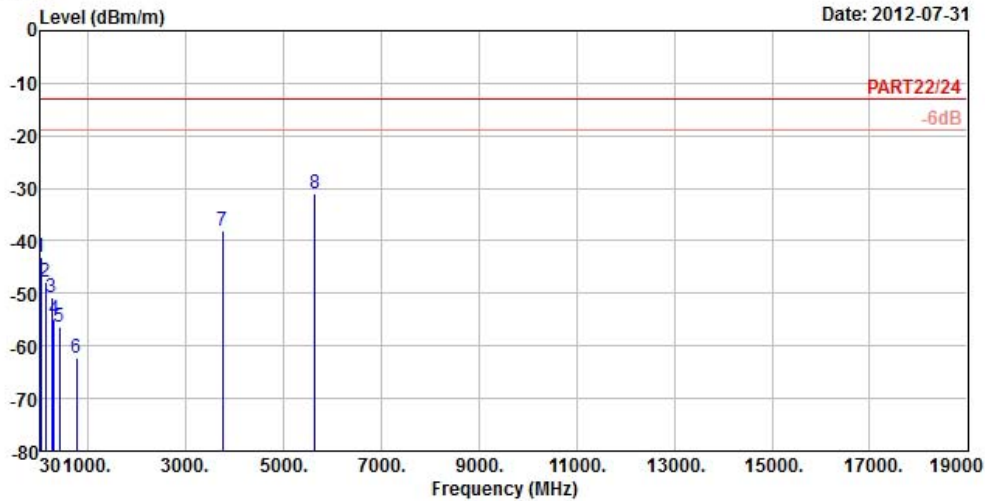

Site : 966 Chamber 5  
 Condition : PART22/24 3m EIRP\_RSE\_1G~19G\_3 VERTICAL  
 Brand/Model: PM23100  
 Remark : EDGE1900 Link  
 Tested by : Kay Wu  
 Temperature : 25°C  
 Humidity : 65%  
 Plane : X

	Freq	Level	Read Level	Limit Line	Over Limit	Factor	Remark
	MHz	dBm/m	dBm	dBm/m	dB	dB/m	
1	30.27	-42.98	-44.05	-13.00	-29.98	1.07	Peak
2	123.69	-47.95	-38.14	-13.00	-34.95	-9.81	Peak
3	251.94	-50.69	-44.98	-13.00	-37.69	-5.71	Peak
4	300.00	-54.87	-48.49	-13.00	-41.87	-6.38	Peak
5	408.50	-56.37	-50.95	-13.00	-43.37	-5.42	Peak
6	762.70	-62.43	-64.30	-13.00	-49.43	1.87	Peak
7	3760.00	-38.02	-31.29	-13.00	-25.02	-6.73	Peak
8 pp	5640.00	-31.04	-31.25	-13.00	-18.04	0.21	Peak



A D T

WCDMA:



Bureau Veritas Consumer Products Services Ltd., Taoyuan Branch

A D T

Data: 15

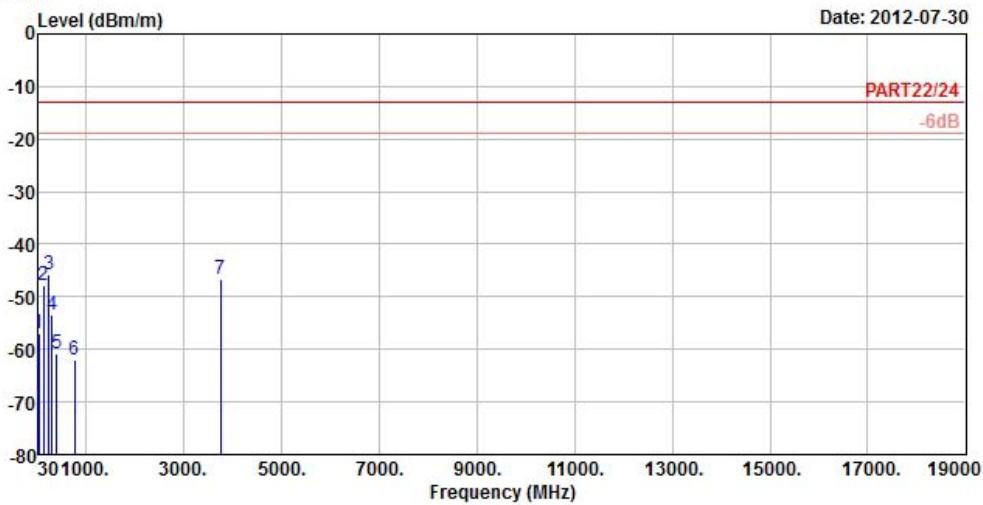

Site : 966 Chamber 5  
 Condition : PART22/24 3m EIRP\_RSE\_1G~19G\_3 HORIZONTAL  
 Brand/Model: PM23100  
 Remark : Band II Link  
 Tested by : Kay Wu  
 Temperature : 25°C  
 Humidity : 65%  
 Plane : X

	Freq	Level	Read Level	Limit Line	Over Limit	Factor	Remark
	MHz	dBm/m	dBm	dBm/m	dB	dB/m	
1	31.62	-56.84	-56.45	-13.00	-43.84	-0.39	Peak
2	123.96	-47.86	-38.05	-13.00	-34.86	-9.81	Peak
3 pp	246.54	-45.65	-39.80	-13.00	-32.65	-5.85	Peak
4	300.00	-53.47	-47.09	-13.00	-40.47	-6.38	Peak
5	398.00	-60.68	-55.03	-13.00	-47.68	-5.65	Peak
6	759.90	-62.12	-63.97	-13.00	-49.12	1.85	Peak
7	3760.00	-46.63	-39.90	-13.00	-33.63	-6.73	Peak





A D T



Bureau Veritas Consumer Products Services Ltd., Taoyuan Branch

A D T

Data: 16

Date: 2012-07-31

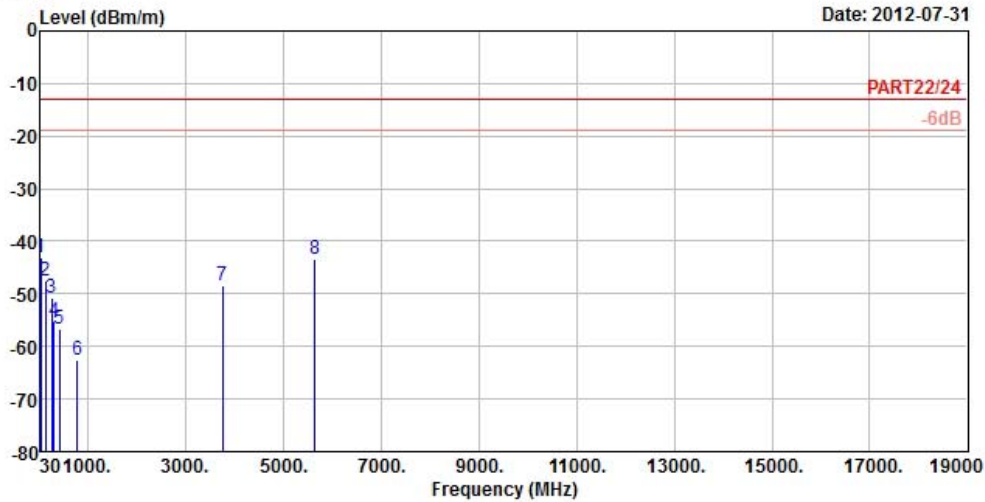

Site : 966 Chamber 5  
 Condition : PART22/24 3m EIRP\_RSE\_1G~19G\_3 VERTICAL  
 Brand/Model: PM23100  
 Remark : Band II Link  
 Tested by : Kay Wu  
 Temperature : 25°C  
 Humidity : 65%  
 Plane : X

	Freq	Level	Read Level	Limit Line	Over Limit	Factor	Remark
	MHz	dBm/m	dBm	dBm/m	dB	dB/m	
1	pp	30.54	-43.12	-43.46	-13.00	-30.12	0.34 Peak
2		124.23	-47.59	-37.78	-13.00	-34.59	-9.81 Peak
3		253.02	-50.79	-45.07	-13.00	-37.79	-5.72 Peak
4		300.00	-55.17	-48.79	-13.00	-42.17	-6.38 Peak
5		408.50	-56.56	-51.14	-13.00	-43.56	-5.42 Peak
6		784.40	-62.45	-64.47	-13.00	-49.45	2.02 Peak
7		3760.00	-48.42	-41.69	-13.00	-35.42	-6.73 Peak
8		5640.00	-43.52	-43.73	-13.00	-30.52	0.21 Peak



A D T

CDMA:



Bureau Veritas Consumer Products Services Ltd., Taoyuan Branch

A D T

Data: 15

Date: 2012-07-31

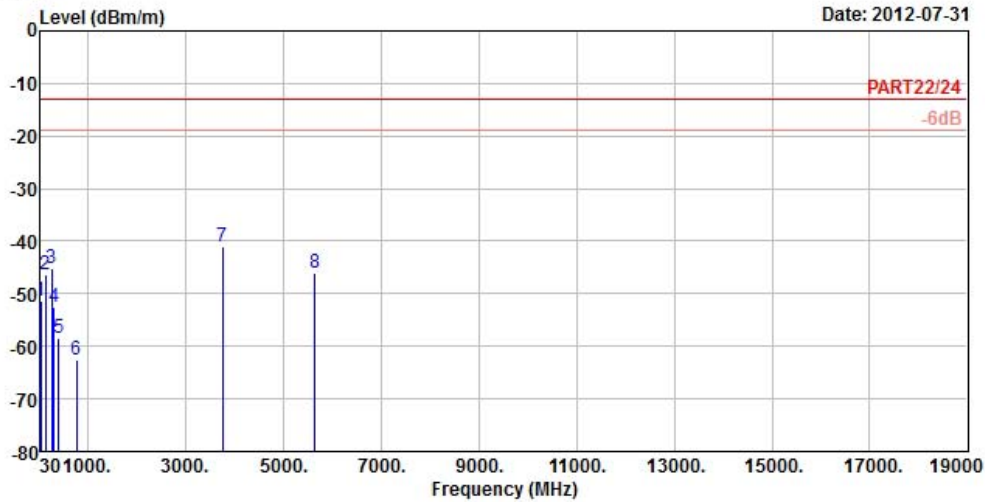

Site : 966 Chamber 5  
 Condition : PART22/24 3m EIRP\_RSE\_1G~19G\_3 HORIZONTAL  
 Brand/Model: PM23100  
 Remark : 1XRTT1900 Link  
 Tested by : Kay Wu  
 Temperature : 25°C  
 Humidity : 65%  
 Plane : X

	Freq	Level	Read Level	Limit Line	Over Limit	Factor	Remark
	MHz	dBm/m	dBm	dBm/m	dB	dB/m	
1	30.00	-51.30	-52.37	-13.00	-38.30	1.07	Peak
2	124.50	-46.28	-36.47	-13.00	-33.28	-9.81	Peak
3	257.07	-45.21	-39.43	-13.00	-32.21	-5.78	Peak
4	304.90	-52.47	-46.13	-13.00	-39.47	-6.34	Peak
5	400.10	-58.43	-52.81	-13.00	-45.43	-5.62	Peak
6	769.70	-62.71	-64.64	-13.00	-49.71	1.93	Peak
7 pp	3760.00	-41.15	-34.42	-13.00	-28.15	-6.73	Peak
8	5640.00	-45.91	-46.12	-13.00	-32.91	0.21	Peak



A D T



Bureau Veritas Consumer Products Services Ltd., Taoyuan Branch

A D T

Data: 16

Date: 2012-07-31

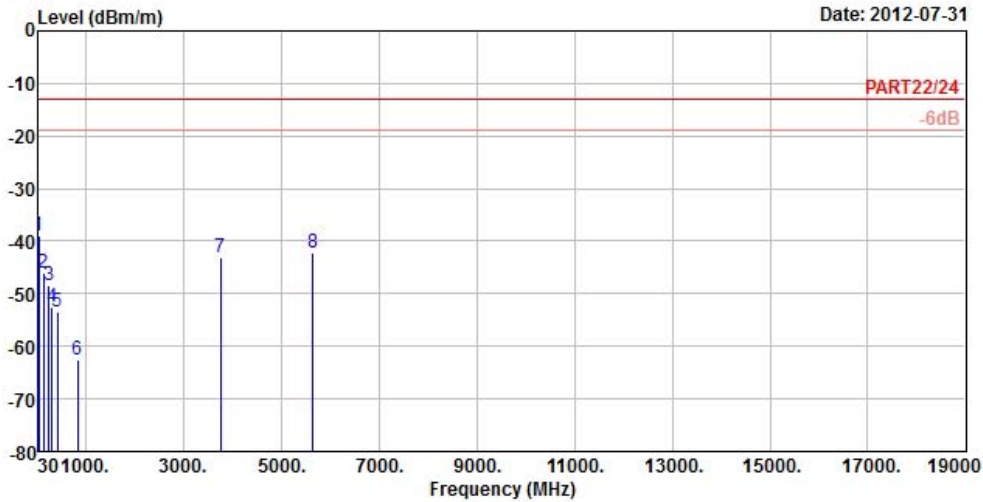

Site : 966 Chamber 5  
 Condition : PART22/24 3m EIRP\_RSE\_1G~19G\_3 VERTICAL  
 Brand/Model: PM23100  
 Remark : 1XRTT1900 Link  
 Tested by : Kay Wu  
 Temperature : 25°C  
 Humidity : 65%  
 Plane : X

	Read	Limit	Over			
Freq	Level	Level	Line	Limit	Factor	Remark
MHz	dBm/m	dBm	dBm/m	dB	dB/m	
1 pp	30.27 -38.89	-39.96	-13.00	-25.89	1.07	Peak
2	124.50 -46.04	-36.23	-13.00	-33.04	-9.81	Peak
3	246.81 -48.54	-42.73	-13.00	-35.54	-5.81	Peak
4	300.70 -52.42	-46.05	-13.00	-39.42	-6.37	Peak
5	409.20 -53.33	-47.94	-13.00	-40.33	-5.39	Peak
6	823.60 -62.50	-64.76	-13.00	-49.50	2.26	Peak
7	3760.00 -43.09	-36.36	-13.00	-30.09	-6.73	Peak
8	5640.00 -42.30	-42.51	-13.00	-29.30	0.21	Peak



A D T

# Test Mode B

## GSM:



Bureau Veritas Consumer Products Services Ltd., Taoyuan Branch

A D T

Data: 15

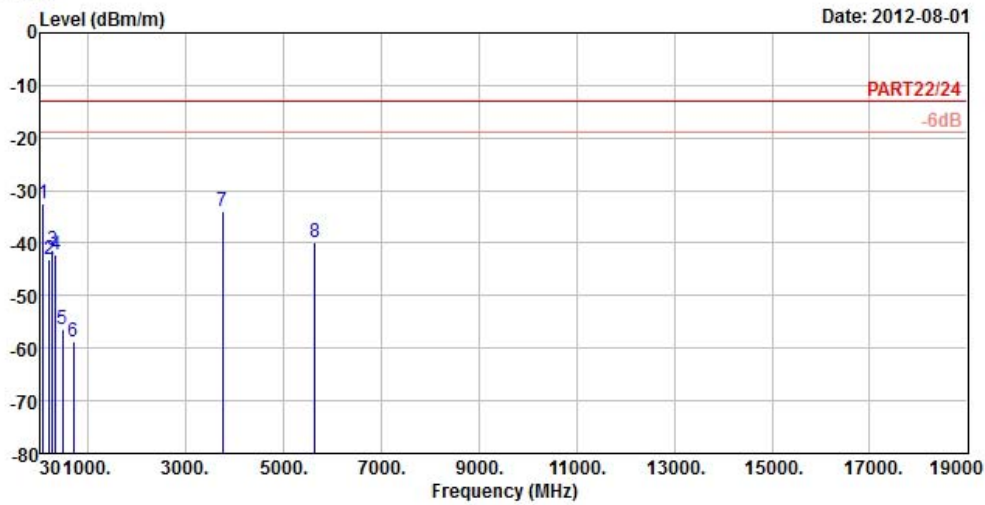

Site : 966 Chamber 5  
Condition : PART22/24 3m EIRP\_RSE\_1G~19G\_3 HORIZONTAL  
Brand/Model: PM23100  
Remark : PCS1900 Link  
Tested by : Kay Wu  
Temperature : 25°C  
Humidity : 65%  
Plane : X

	Read	Limit	Over			
Freq	Level	Level	Line	Limit	Factor	Remark
MHz	dBm/m	dBm	dBm/m	dB	dB/m	
1 pp	82.92	-32.46	-22.10	-13.00	-19.46	-10.36 Peak
2	211.17	-43.09	-35.66	-13.00	-30.09	-7.43 Peak
3	272.46	-41.22	-35.22	-13.00	-28.22	-6.00 Peak
4	334.30	-42.32	-36.20	-13.00	-29.32	-6.12 Peak
5	474.30	-56.31	-52.56	-13.00	-43.31	-3.75 Peak
6	698.30	-58.69	-60.11	-13.00	-45.69	1.42 Peak
7	3760.00	-33.89	-27.16	-13.00	-20.89	-6.73 Peak
8	5640.00	-39.71	-39.92	-13.00	-26.71	0.21 Peak



A D T



Bureau Veritas Consumer Products Services Ltd., Taoyuan Branch

A D T

Data: 16

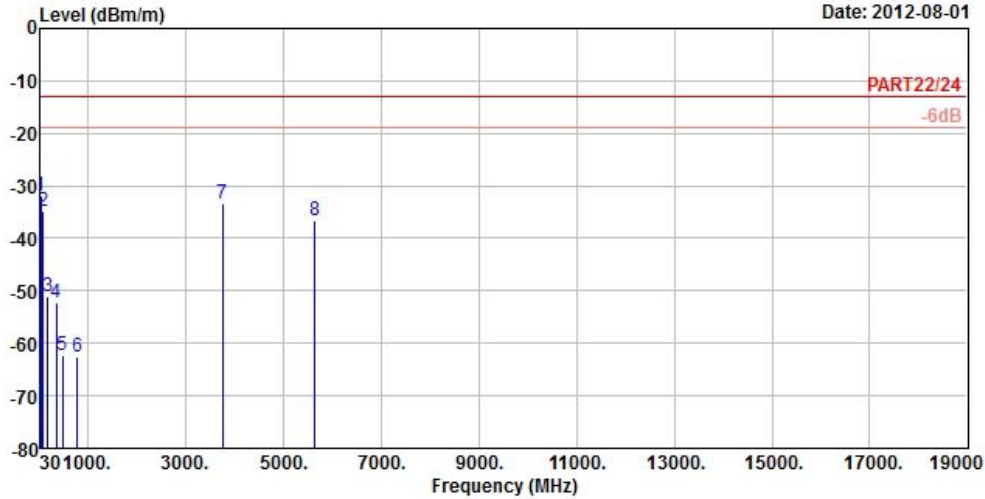

Site : 966 Chamber 5  
 Condition : PART22/24 3m EIRP\_RSE\_1G~19G\_3 VERTICAL  
 Brand/Model: PM23100  
 Remark : PCS1900 Link  
 Tested by : Kay Wu  
 Temperature : 25°C  
 Humidity : 65%  
 Plane : X

	Freq	Level	Read Level	Limit Line	Over Limit	Factor	Remark
	MHz	dBm/m	dBm	dBm/m	dB	dB/m	
1	39.72	-31.92	-30.39	-13.00	-18.92	-1.53	Peak
2	82.92	-34.72	-24.36	-13.00	-21.72	-10.36	Peak
3	177.42	-51.09	-44.86	-13.00	-38.09	-6.23	Peak
4	345.50	-52.17	-46.13	-13.00	-39.17	-6.04	Peak
5	486.20	-62.36	-58.90	-13.00	-49.36	-3.46	Peak
6	779.50	-62.49	-64.48	-13.00	-49.49	1.99	Peak
7	3760.00	-33.22	-26.49	-13.00	-20.22	-6.73	Peak
8	5640.00	-36.75	-36.96	-13.00	-23.75	0.21	Peak



## 5 PHOTOGRAPHS OF THE TEST CONFIGURATION

Please refer to the attached file (Test Setup Photo).



## 6 INFORMATION ON THE TESTING LABORATORIES

We, Bureau Veritas Consumer Products Services (H.K.) Ltd., Taoyuan Branch, were founded in 1988 to provide our best service in EMC, Radio, Telecom and Safety consultation. Our laboratories are accredited and approved according to ISO/IEC 17025.

If you have any comments, please feel free to contact us at the following:

**Linko EMC/RF Lab:**

Tel: 886-2-26052180

Fax: 886-2-26051924

**Hsin Chu EMC/RF Lab:**

Tel: 886-3-5935343

Fax: 886-3-5935342

**Hwa Ya EMC/RF/Safety/Telecom Lab:**

Tel: 886-3-3183232

Fax: 886-3-3270892

**Email:** [service.adt@tw.bureauveritas.com](mailto:service.adt@tw.bureauveritas.com)

**Web Site:** [www.adt.com.tw](http://www.adt.com.tw)

The address and road map of all our labs can be found in our web site also.



## **7 APPENDIX A – MODIFICATIONS RECORDERS FOR ENGINEERING CHANGES TO THE EUT BY THE LAB**

No any modifications were made to the EUT by the lab during the test.

**---END---**