



# FCC SAR Test Report

**APPLICANT** : HTC Corporation  
**EQUIPMENT** : Smartphone  
**MODEL NAME** : PL80120  
**FCC ID** : NM8PL80120  
**STANDARD** : FCC 47 CFR Part 2 (2.1093)  
ANSI/IEEE C95.1-1992  
IEEE 1528-2003  
FCC OET Bulletin 65 Supplement C (Edition 01-01)

The product was completely tested on Dec. 11, 2012. We, SPORTON INTERNATIONAL INC., would like to declare that the tested sample has been evaluated in accordance with the procedures and shown the compliance with the applicable technical standards.

The test results in this report apply exclusively to the tested model / sample. Without written approval of SPORTON INTERNATIONAL INC., the test report shall not be reproduced except in full.

Reviewed by:

Jones Tsai / Manager



**SPORTON INTERNATIONAL INC.**

No. 52, Hwa Ya 1<sup>st</sup> Rd., Hwa Ya Technology Park, Kwei-Shan Hsiang, Tao Yuan Hsien, Taiwan, R.O.C.



Table of Contents

1. Statement of Compliance ..... 4
2. Administration Data ..... 5
2.1 Testing Laboratory ..... 5
2.2 Applicant ..... 5
2.3 Manufacturer ..... 5
2.4 Application Details ..... 5
3. General Information ..... 6
3.1 Description of Equipment Under Test (EUT) ..... 6
3.2 Applied Standard ..... 8
3.3 Device Category and SAR Limits ..... 8
3.4 Test Conditions ..... 8
4. Specific Absorption Rate (SAR) ..... 9
4.1 Introduction ..... 9
4.2 SAR Definition ..... 9
5. SAR Measurement System ..... 10
5.1 E-Field Probe ..... 11
5.2 Data Acquisition Electronics (DAE) ..... 12
5.3 Robot ..... 12
5.4 Measurement Server ..... 12
5.5 Phantom ..... 13
5.6 Device Holder ..... 14
5.7 Data Storage and Evaluation ..... 15
5.8 Test Equipment List ..... 17
6. Tissue Simulating Liquids ..... 18
7. SAR Measurement Evaluation ..... 20
7.1 Purpose of System Performance check ..... 20
7.2 System Setup ..... 20
7.3 Validation Results ..... 21
8. EUT Testing Position ..... 22
8.1 Define two imaginary lines on the handset ..... 22
8.2 Cheek Position ..... 23
8.3 Tilted Position ..... 23
8.4 Body Worn Position ..... 24
9. Measurement Procedures ..... 25
9.1 Spatial Peak SAR Evaluation ..... 25
9.2 Area & Zoom Scan Procedures ..... 25
9.3 Volume Scan Procedures ..... 26
9.4 SAR Averaged Methods ..... 26
9.5 Power Drift Monitoring ..... 26
10. SAR Test Configurations ..... 27
10.1 Exposure Positions Consideration ..... 27
10.2 Conducted RF Output Power (Unit: dBm) ..... 29
11. SAR Test Results ..... 36
11.1 Test Records for Head SAR Test ..... 36
11.2 Test Records for Hotspot SAR Test ..... 41
11.3 Test Records for Body-worn SAR Test ..... 46
11.4 Simultaneous Multi-band Transmission Analysis ..... 49
11.5 Simultaneous analysis - SPLSR calculation ..... 55
12. Uncertainty Assessment ..... 60
13. References ..... 63
Appendix A. Plots of System Performance Check
Appendix B. Plots of SAR Measurement
Appendix C. DASY Calibration Certificate
Appendix D. Test Setup Photos
Appendix E. LTE Spectrum Plots for Different RB Allocations





### 1. Statement of Compliance

The maximum results of Specific Absorption Rate (SAR) found during testing for HTC Corporation Smartphone, PL80120, are as follows.

#### <Highest standalone SAR Summary>

Band	Position	SAR <sub>1g</sub> (W/kg)
CDMA2000 BC0	Head	0.312
CDMA2000 BC15	Head	0.307
CDMA2000 BC1	Head	0.554
LTE Band 12	Head	0.243
LTE Band 4	Head	0.739
LTE Band 2	Head	0.808
WLAN 2.4G	Head	0.532
WLAN 5G	Head	0.047
CDMA2000 BC0	Hotspot (1 cm Gap)	0.558
CDMA2000 BC15	Hotspot (1 cm Gap)	0.704
CDMA2000 BC1	Hotspot (1 cm Gap)	0.993
LTE Band 12	Hotspot (1 cm Gap)	0.208
LTE Band 4	Hotspot (1 cm Gap)	0.492
LTE Band 2	Hotspot (1 cm Gap)	0.598
WLAN 2.4G	Hotspot (1 cm Gap)	0.335
WLAN 5G	Hotspot (1 cm Gap)	0.091
CDMA2000 BC0	Body-worn (1 cm Gap)	0.389
CDMA2000 BC15	Body-worn (1 cm Gap)	0.712
CDMA2000 BC1	Body-worn (1 cm Gap)	0.957
LTE Band 12	Body-worn (1 cm Gap)	0.208
LTE Band 4	Body-worn (1 cm Gap)	0.636
LTE Band 2	Body-worn (1 cm Gap)	0.766
WLAN 2.4G	Body-worn (1 cm Gap)	0.335
WLAN 5G	Body-worn (1 cm Gap)	0.111

This device is in compliance with Specific Absorption Rate (SAR) for general population/uncontrolled exposure limits (1.6 W/kg) specified in FCC 47 CFR part 2 (2.1093) and ANSI/IEEE C95.1-1992, and had been tested in accordance with the measurement methods and procedures specified in IEEE 1528-2003 and FCC OET Bulletin 65 Supplement C (Edition 01-01).



## 2. Administration Data

### 2.1 Testing Laboratory

Test Site	SPORTON INTERNATIONAL INC.
Test Site Location	No. 52, Hwa Ya 1 <sup>st</sup> Rd., Hwa Ya Technology Park, Kwei-Shan Hsiang, Tao Yuan Hsien, Taiwan, R.O.C. TEL: +886-3-327-3456 FAX: +886-3-328-4978

### 2.2 Applicant

Company Name	HTC Corporation
Address	No. 23, Xinghua Rd., Taoyuan City, Taoyuan County 330, Taiwan

### 2.3 Manufacturer

Company Name	HTC Corporation
Address	No. 23, Xinghua Rd., Taoyuan City, Taoyuan County 330, Taiwan

### 2.4 Application Details

Date of Start during the Test	Aug. 28, 2012
Date of End during the Test	Dec. 11, 2012

### 3. General Information

#### 3.1 Description of Equipment Under Test (EUT)

Product Feature & Specification	
EUT	Smartphone
Model Name	PL80120
FCC ID	NM8PL80120
Sample 1	EUT with LCM 1, Main Camera 1,
Sample 2	EUT with LCM 2, Main Camera 2,
Sample IMEI Code	Sample 1 IMEI: 99000067008047 (CDMA conducted power & SAR measurements) 99000067008048 (LTE conducted power & SAR measurements) 99000067009398 (WIFI conducted power & SAR measurements) Sample 2 IMEI: 99000067008707 (CDMA/LTE/WIFI conducted power & SAR measurements)
Tx Frequency	CDMA2000 BC0: 824.70 MHz ~ 848.31 MHz CDMA2000 BC1: 1851.25 MHz ~ 1908.75 MHz CDMA2000 BC15: 1711.25 MHz ~ 1753.75 MHz LTE Band 2: 1850.7 MHz ~ 1909.3 MHz LTE Band 4: 1710.7 MHz ~ 1754.3 MHz LTE Band 12: 699.7 MHz ~ 715.3 MHz WLAN2.4G: 2412 MHz ~ 2462 MHz WLAN5G: 5180 MHz ~ 5240 MHz; 5260 MHz ~ 5320 MHz; 5500 MHz ~ 5700 MHz; 5745 MHz ~ 5825 MHz Bluetooth: 2402 MHz ~ 2480 MHz NFC: 13.56 MHz
Maximum Average Output Power to Antenna	CDMA2000 BC0: 24.66 dBm CDMA2000 BC1: 24.82 dBm CDMA2000 BC15: 24.88 dBm LTE Band 2: 23.40 dBm LTE Band 4: 23.41 dBm LTE Band 12: 23.60 dBm 802.11b: 18.52 dBm 802.11g: 13.20 dBm 802.11n-HT20 (2.4GHz): 12.28 dBm 802.11n-HT40 (2.4GHz): 13.52 dBm 802.11a: 12.62 dBm 802.11n-HT20 (5GHz): 12.58 dBm 802.11n-HT40 (5GHz): 12.80 dBm Bluetooth: 6.11 dBm
Antenna Type	WWAN: PIFA Antenna LTE: PIFA Antenna WLAN: PIFA Antenna Bluetooth: PIFA Antenna NFC: Loop Antenna
Uplink Modulations	CDMA2000: QPSK LTE: QPSK / 16QAM 802.11b: DSSS (BPSK / QPSK / CCK) 802.11a/g/n: OFDM (BPSK / QPSK / 16QAM / 64QAM) Bluetooth: GFSK Bluetooth EDR: $\pi/4$ -DQPSK / 8-DPSK Bluetooth 4.0 LE: GFSK NFC: ASK
Dual Transfer Mode (DTM) Category	Class B – EUT cannot support Packet Switched and Circuit Switched Network simultaneously but can automatically switch between Packet and Circuit Switched Network.
EUT Stage	Production Unit
Remark:	<ol style="list-style-type: none"> <li>The above EUT's information was declared by manufacturer. Please refer to the specifications or user's manual for more detailed description.</li> <li>5600 MHz ~ 5650 MHz is notched.</li> <li>All samples under test were electrically identical with one another per the applicant.</li> <li>Sample 2 is integrating 2<sup>nd</sup> source LCM/Camera with 2<sup>nd</sup> source Battery during the SAR testing, and these 2<sup>nd</sup> source parts are identical to main source in electrical characteristics and mechanical construction/dimension.</li> </ol>



The table below summarized necessary items addressed in KDB 941225 D05 v01.

FCC ID	NM8PL80120							
EUT	Smartphone							
Operating Frequency Range of each LTE transmission band	Band 2: Tx: 1850.7 MHz ~ 1909.3 MHz Band 4: Tx: 1710.7 MHz ~ 1754.3 MHz Band 12: Tx: 699.7 MHz ~ 715.3 MHz							
Channel Bandwidth	Band 2: 1.4MHz, 3MHz, 5MHz, 10MHz, Band 4: 1.4MHz, 3MHz, 5MHz, 10MHz, Band 12: 1.4MHz, 3MHz, 5MHz, 10MHz,							
Transmission (H, M, L) channel numbers and frequencies in each LTE band								
Band 2								
	Bandwidth 1.4 MHz		Bandwidth 3 MHz		Bandwidth 5 MHz		Bandwidth 10 MHz	
	Ch. #	Freq. (MHz)	Ch. #	Freq. (MHz)	Ch. #	Freq. (MHz)	Ch. #	Freq. (MHz)
L	18607	1850.7	18615	1851.5	18625	1852.5	18650	1855
M	18900	1880	18900	1880	18900	1880	18900	1880
H	19193	1909.3	19185	1908.5	19175	1907.5	19150	1905
Band 4								
	Bandwidth 1.4 MHz		Bandwidth 3 MHz		Bandwidth 5 MHz		Bandwidth 10 MHz	
	Ch. #	Freq. (MHz)	Ch. #	Freq. (MHz)	Ch. #	Freq. (MHz)	Ch. #	Freq. (MHz)
L	19957	1710.7	19965	1711.5	19975	1712.5	20000	1715
M	20175	1732.5	20175	1732.5	20175	1732.5	20175	1732.5
H	20393	1754.3	20385	1753.5	20375	1752.5	20350	1750
Band 12								
	Bandwidth 1.4 MHz		Bandwidth 3 MHz		Bandwidth 5 MHz		Bandwidth 10 MHz	
	Ch. #	Freq. (MHz)	Ch. #	Freq. (MHz)	Ch. #	Freq. (MHz)	Ch. #	Freq. (MHz)
L	23017	699.7	23025	700.5	23035	701.5	23060	704
M	23095	707.5	23095	707.5	23095	707.5	23095	707.5
H	23173	715.5	23165	714.5	23155	713.5	23130	711
UE category, uplink modulations used	Category 3, QPSK, and 16QAM							
LTE transmitter and antenna implementation (standalone or sharing hardware components / antennas )	LTE owns standalone transmitter and antenna.							
LTE Voice / Data requirements	Data only							
LTE MPR permanently built-in by design	Yes							
LTE A-MPR	Disabled during SAR testing. With CMW500, set NS value to NS_01 to disable A-MPR.							
LTE maximum averaged conducted output power	LTE Band 2 : 23.40 dBm LTE Band 4 : 23.41 dBm LTE Band 12 : 23.60 dBm							
Other U.S. wireless operating modes / bands	CDMA2000	CDMA2000 BC0: 824.70 MHz ~ 848.31 MHz CDMA2000 BC1: 1851.25 MHz ~ 1908.75 MHz CDMA2000 BC15 : 1711.25 MHz ~ 1753.75 MHz						
	WLAN	2.4G: 2412~2462 MHz 5G: 5180 ~ 5240 MHz; 5260 ~ 5320 MHz; 5500 ~ 5700 MHz; 5745 ~ 5825 MHz						
	Bluetooth	2402~2480 MHz						
	NFC	13.56 MHz						
Simultaneous transmission configurations	In Section 11.4							
Power reduction applied to satisfy SAR compliance	No.							



### 3.2 Applied Standard

The Specific Absorption Rate (SAR) testing specification, method, and procedure for this device is in accordance with the following standards:

- FCC 47 CFR Part 2 (2.1093)
- ANSI/IEEE C95.1-1992
- IEEE 1528-2003
- FCC OET Bulletin 65 Supplement C (Edition 01-01)
- FCC KDB 447498 D01 v04
- FCC KDB 648474 D01 v01r05
- FCC KDB 941225 D01 v02
- FCC KDB 941225 D05 v01
- FCC KDB 941225 D06 v01
- FCC KDB 248227 D01 v01r02

### 3.3 Device Category and SAR Limits

This device belongs to portable device category because its radiating structure is allowed to be used within 20 centimeters of the body of the user. Limit for General Population/Uncontrolled exposure should be applied for this device, it is 1.6 W/kg as averaged over any 1 gram of tissue.

### 3.4 Test Conditions

#### 3.4.1 Ambient Condition

Ambient Temperature	20 to 24 °C
Humidity	< 60 %

#### 3.4.2 Test Configuration

The device was controlled by using a base station emulator. Communication between the device and the emulator was established by air link. The distance between the EUT and the antenna of the emulator is larger than 50 cm and the output power radiated from the emulator antenna is at least 30 dB smaller than the output power of EUT. The EUT was set from the emulator to radiate maximum output power during all tests.

For WLAN SAR testing, WLAN engineering testing software installed on the EUT can provide continuous transmitting RF signal.

The maximum rated power of WWAN and WLAN is listed in "Tune-Up Procedure" exhibit, and the maximum rated power of WLAN is listed in "Operational Description" exhibit; the scaling factor is calculated according to the difference between measured output power and maximum tolerance power on this device.



## **4. Specific Absorption Rate (SAR)**

### **4.1 Introduction**

SAR is related to the rate at which energy is absorbed per unit mass in an object exposed to a radio field. The SAR distribution in a biological body is complicated and is usually carried out by experimental techniques or numerical modeling. The standard recommends limits for two tiers of groups, occupational/controlled and general population/uncontrolled, based on a person's awareness and ability to exercise control over his or her exposure. In general, occupational/controlled exposure limits are higher than the limits for general population/uncontrolled.

### **4.2 SAR Definition**

The SAR definition is the time derivative (rate) of the incremental energy (dW) absorbed by (dissipated in) an incremental mass (dm) contained in a volume element (dv) of a given density ( $\rho$ ). The equation description is as below:

$$\text{SAR} = \frac{d}{dt} \left( \frac{dW}{dm} \right) = \frac{d}{dt} \left( \frac{dW}{\rho dv} \right)$$

SAR is expressed in units of Watts per kilogram (W/kg)

SAR measurement can be either related to the temperature elevation in tissue by

$$\text{SAR} = C \left( \frac{\delta T}{\delta t} \right)$$

Where: C is the specific heat capacity,  $\delta T$  is the temperature rise and  $\delta t$  is the exposure duration, or related to the electrical field in the tissue by

$$\text{SAR} = \frac{\sigma |E|^2}{\rho}$$

Where:  $\sigma$  is the conductivity of the tissue,  $\rho$  is the mass density of the tissue and E is the RMS electrical field strength.

However for evaluating SAR of low power transmitter, electrical field measurement is typically applied.

## 5. SAR Measurement System



**Fig 5.1 SPEAG DASY System Configurations**

The DASY system for performance compliance tests is illustrated above graphically. This system consists of the following items:

- A standard high precision 6-axis robot with controller, a teach pendant and software
- A data acquisition electronic (DAE) attached to the robot arm extension
- A dosimetric probe equipped with an optical surface detector system
- The electro-optical converter (EOC) performs the conversion between optical and electrical signals
- A measurement server performs the time critical tasks such as signal filtering, control of the robot operation and fast movement interrupts.
- A probe alignment unit which improves the accuracy of the probe positioning
- A computer operating Windows XP
- DASY software
- Remote control with teach pendant and additional circuitry for robot safety such as warning lamps, etc.
- The SAM twin phantom
- A device holder
- Tissue simulating liquid
- Dipole for evaluating the proper functioning of the system

Component details are described in in the following sub-sections.

### 5.1 E-Field Probe

The SAR measurement is conducted with the dosimetric probe (manufactured by SPEAG). The probe is specially designed and calibrated for use in liquid with high permittivity. The dosimetric probe has special calibration in liquid at different frequency. This probe has a built in optical surface detection system to prevent from collision with phantom.

#### 5.1.1 E-Field Probe Specification

##### <ET3DV6 / ET3DV6R Probe >

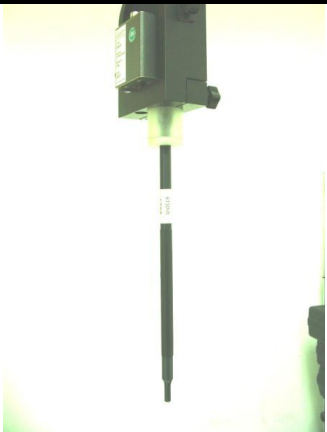
<b>Construction</b>	Symmetrical design with triangular core Built-in optical fiber for surface detection system. Built-in shielding against static charges. PEEK enclosure material (resistant to organic solvents, e.g., DGBE)	 <p><b>Fig 5.2 Photo of ET3DV6/ET3DV6</b></p>
<b>Frequency</b>	10 MHz to 3 GHz; Linearity: $\pm 0.2$ dB	
<b>Directivity</b>	$\pm 0.2$ dB in HSL (rotation around probe axis) $\pm 0.4$ dB in HSL (rotation normal to probe axis)	
<b>Dynamic Range</b>	5 $\mu$ W/g to 100 mW/g; Linearity: $\pm 0.2$ dB	
<b>Dimensions</b>	Overall length: 330 mm (Tip: 16 mm) Tip diameter: 6.8 mm (Body: 12 mm) Distance from probe tip to dipole centers: 2.7 mm	

##### <EX3DV4 / ES3DV4 Probe >

<b>Construction</b>	Symmetrical design with triangular core Built-in shielding against static charges PEEK enclosure material (resistant to organic solvents, e.g., DGBE)	 <p><b>Fig 5.3 Photo of EX3DV4/ES3DV4</b></p>
<b>Frequency</b>	10 MHz to 6 GHz; Linearity: $\pm 0.2$ dB	
<b>Directivity</b>	$\pm 0.3$ dB in HSL (rotation around probe axis) $\pm 0.5$ dB in tissue material (rotation normal to probe axis)	
<b>Dynamic Range</b>	10 $\mu$ W/g to 100 mW/g; Linearity: $\pm 0.2$ dB (noise: typically $< 1$ $\mu$ W/g)	
<b>Dimensions</b>	Overall length: 330 mm (Tip: 20 mm) Tip diameter: 2.5 mm (Body: 12 mm) Typical distance from probe tip to dipole centers: 1 mm	

#### 5.1.2 E-Field Probe Calibration

Each probe needs to be calibrated according to a dosimetric assessment procedure with accuracy better than  $\pm 10\%$ . The spherical isotropy shall be evaluated and within  $\pm 0.25$  dB. The sensitivity parameters (NormX, NormY, and NormZ), the diode compression parameter (DCP) and the conversion factor (ConvF) of the probe are tested. The calibration data can be referred to appendix C of this report.

### 5.2 Data Acquisition Electronics (DAE)

The data acquisition electronics (DAE) consists of a highly sensitive electrometer-grade preamplifier with auto-zeroing, a channel and gain-switching multiplexer, a fast 16 bit AD-converter and a command decoder and control logic unit. Transmission to the measurement server is accomplished through an optical downlink for data and status information as well as an optical uplink for commands and the clock. The input impedance of the DAE is 200 MOhm; the inputs are symmetrical and floating. Common mode rejection is above 80 dB.



Fig 5.4 Photo of DAE

### 5.3 Robot

The SPEAG DASY system uses the high precision robots (DASY4: RX90BL; DASY5: TX90XL) type from Stäubli SA (France). For the 6-axis controller system, the robot controller version (DASY4: CS7MB; DASY5: CS8c) from Stäubli is used. The Stäubli robot series have many features that are important for our application:

- High precision (repeatability  $\pm 0.035$  mm)
- High reliability (industrial design)
- Jerk-free straight movements
- Low ELF interference (the closed metallic construction shields against motor control fields)



Fig 5.5 Photo of DASY4



Fig 5.6 Photo of DASY5

### 5.4 Measurement Server

The measurement server is based on a PC/104 CPU board with CPU (DASY4: 166 MHz, Intel Pentium; DASY5: 400 MHz, Intel Celeron), chipdisk (DASY4: 32 MB; DASY5: 128 MB), RAM (DASY4: 64 MB, DASY5: 128 MB). The necessary circuits for communication with the DAE electronic box, as well as the 16 bit AD converter system for optical detection and digital I/O interface are contained on the DASY I/O board, which is directly connected to the PC/104 bus of the CPU board.

The measurement server performs all the real-time data evaluation for field measurements and surface detection, controls robot movements and handles safety operations.



Fig 5.7 Photo of Server for DASY4



Fig 5.8 Photo of Server for DASY5

**5.5 Phantom**

**<SAM Twin Phantom>**

<b>Shell Thickness</b>	2 ± 0.2 mm; Center ear point: 6 ± 0.2 mm	 <p><b>Fig 5.9 Photo of SAM Phantom</b></p>
<b>Filling Volume</b>	Approx. 25 liters	
<b>Dimensions</b>	Length: 1000 mm; Width: 500 mm; Height: adjustable feet	
<b>Measurement Areas</b>	Left Hand, Right Hand, Flat Phantom	

The bottom plate contains three pair of bolts for locking the device holder. The device holder positions are adjusted to the standard measurement positions in the three sections. A white cover is provided to tap the phantom during off-periods to prevent water evaporation and changes in the liquid parameters. On the phantom top, three reference markers are provided to identify the phantom position with respect to the robot.

**<ELI4 Phantom>**

<b>Shell Thickness</b>	2 ± 0.2 mm (sagging: <1%)	 <p><b>Fig 5.10 Photo of ELI4 Phantom</b></p>
<b>Filling Volume</b>	Approx. 30 liters	
<b>Dimensions</b>	Major ellipse axis: 600 mm Minor axis: 400 mm	

The ELI4 phantom is intended for compliance testing of handheld and body-mounted wireless devices in the frequency range of 30 MHz to 6 GHz. ELI4 is fully compatible with standard and all known tissue simulating liquids.

## 5.6 Device Holder

### <Device Holder for SAM Twin Phantom>

The SAR in the phantom is approximately inversely proportional to the square of the distance between the source and the liquid surface. For a source at 5 mm distance, a positioning uncertainty of  $\pm 0.5$  mm would produce a SAR uncertainty of  $\pm 20$  %. Accurate device positioning is therefore crucial for accurate and repeatable measurements. The positions in which the devices must be measured are defined by the standards.

The DASY device holder is designed to cope with different positions given in the standard. It has two scales for the device rotation (with respect to the body axis) and the device inclination (with respect to the line between the ear reference points). The rotation center for both scales is the ear reference point (ERP). Thus the device needs no repositioning when changing the angles.

The DASY device holder is constructed of low-loss POM material having the following dielectric parameters: relative permittivity  $\epsilon = 3$  and loss tangent  $\delta = 0.02$ . The amount of dielectric material has been reduced in the closest vicinity of the device, since measurements have suggested that the influence of the clamp on the test results could thus be lowered.



Fig 5.11 Device Holder

### <Laptop Extension Kit>

The extension is lightweight and made of POM, acrylic glass and foam. It fits easily on the upper part of the mounting device in place of the phone positioned. The extension is fully compatible with the SAM Twin and ELI phantoms.

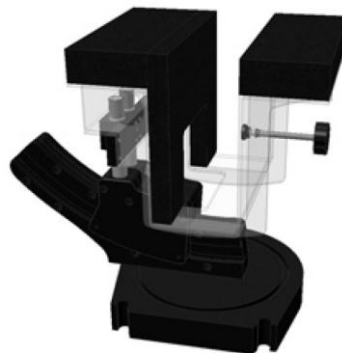

Fig 5.12 Laptop Extension Kit



## 5.7 Data Storage and Evaluation

### 5.7.1 Data Storage

The DASY software stores the assessed data from the data acquisition electronics as raw data (in microvolt readings from the probe sensors), together with all the necessary software parameters for the data evaluation (probe calibration data, liquid parameters and device frequency and modulation data) in measurement files. The post-processing software evaluates the desired unit and format for output each time the data is visualized or exported. This allows verification of the complete software setup even after the measurement and allows correction of erroneous parameter settings. For example, if a measurement has been performed with an incorrect crest factor parameter in the device setup, the parameter can be corrected afterwards and the data can be reevaluated.

The measured data can be visualized or exported in different units or formats, depending on the selected probe type (e.g., [V/m], [A/m], [mW/g]). Some of these units are not available in certain situations or give meaningless results, e.g., a SAR-output in a non-lose media, will always be zero. Raw data can also be exported to perform the evaluation with other software packages.

### 5.7.2 Data Evaluation

The DASY post-processing software (SEMCAD) automatically executes the following procedures to calculate the field units from the microvolt readings at the probe connector. The parameters used in the evaluation are stored in the configuration modules of the software :

<b>Probe parameters :</b>	- Sensitivity	Norm <sub>i</sub> , a <sub>i0</sub> , a <sub>i1</sub> , a <sub>i2</sub>
	- Conversion factor	ConvF <sub>i</sub>
	- Diode compression point	dcp <sub>i</sub>
<b>Device parameters :</b>	- Frequency	f
	- Crest factor	cf
<b>Media parameters :</b>	- Conductivity	σ
	- Density	ρ

These parameters must be set correctly in the software. They can be found in the component documents or they can be imported into the software from the configuration files issued for the DASY components. In the direct measuring mode of the multi-meter option, the parameters of the actual system setup are used. In the scan visualization and export modes, the parameters stored in the corresponding document files are used.

The first step of the evaluation is a linearization of the filtered input signal to account for the compression characteristics of the detector diode. The compensation depends on the input signal, the diode type and the DC-transmission factor from the diode to the evaluation electronics. If the exciting field is pulsed, the crest factor of the signal must be known to correctly compensate for peak power.

The formula for each channel can be given as :

$$V_i = U_i + U_i^2 \cdot \frac{cf}{dcp_i}$$

with  $V_i$  = compensated signal of channel i, (i = x, y, z)  
 $U_i$  = input signal of channel i, (i = x, y, z)  
 cf = crest factor of exciting field (DASY parameter)  
 dcp<sub>i</sub> = diode compression point (DASY parameter)

From the compensated input signals, the primary field data for each channel can be evaluated :

$$\text{E-field Probes : } E_i = \sqrt{\frac{V_i}{\text{Norm}_i \cdot \text{ConvF}}}$$

$$\text{H-field Probes : } H_i = \sqrt{V_i \cdot \frac{a_{i0} + a_{i1}f + a_{i2}f^2}{f}}$$

with  $V_i$  = compensated signal of channel i, (i = x, y, z)  
 $\text{Norm}_i$  = sensor sensitivity of channel i, (i = x, y, z),  $\mu\text{V}/(\text{V/m})^2$  for E-field Probes  
 ConvF = sensitivity enhancement in solution  
 $a_{ij}$  = sensor sensitivity factors for H-field probes  
 f = carrier frequency [GHz]  
 $E_i$  = electric field strength of channel i in V/m  
 $H_i$  = magnetic field strength of channel i in A/m

The RSS value of the field components gives the total field strength (Hermitian magnitude) :

$$E_{\text{tot}} = \sqrt{E_x^2 + E_y^2 + E_z^2}$$

The primary field data are used to calculate the derived field units.

$$\text{SAR} = E_{\text{tot}}^2 \cdot \frac{\sigma}{\rho \cdot 1000}$$

with SAR = local specific absorption rate in mW/g  
 $E_{\text{tot}}$  = total field strength in V/m  
 $\sigma$  = conductivity in [mho/m] or [Siemens/m]  
 $\rho$  = equivalent tissue density in  $\text{g}/\text{cm}^3$

Note that the density is set to 1, to account for actual head tissue density rather than the density of the tissue simulating liquid.





**5.8 Test Equipment List**

Manufacturer	Name of Equipment	Type/Model	Serial Number	Calibration	
				Last Cal.	Due Date
SPEAG	750MHz System Validation Kit	D750V3	1012	Jun. 11, 2010	Jun. 10, 2013
SPEAG	835MHz System Validation Kit	D835V2	499	Mar. 22, 2010	Mar. 21, 2013
SPEAG	1750MHz System Validation Kit	D1750V2	1023	Jun. 20, 2012	Jun. 19, 2013
SPEAG	1900MHz System Validation Kit	D1900V2	5d041	Mar. 23, 2010	Mar. 22, 2013
SPEAG	2450MHz System Validation Kit	D2450V2	736	Jul. 25, 2011	Jul. 24, 2013
SPEAG	5GHz System Validation Kit	D5GHzV2	1006	Jan. 18, 2012	Jan. 17, 2013
SPEAG	Data Acquisition Electronics	DAE3	577	Jun. 06, 2012	Jun. 05, 2013
SPEAG	Data Acquisition Electronics	DAE4	778	Aug. 27, 2012	Aug. 26, 2013
SPEAG	Data Acquisition Electronics	DAE4	1279	May 03, 2012	May 02, 2013
SPEAG	Data Acquisition Electronics	DAE4	1338	Jun. 12, 2012	Jun. 11, 2013
SPEAG	Data Acquisition Electronics	DAE3	495	Apr. 23, 2012	Apr. 22, 2013
SPEAG	Dosimetric E-Field Probe	ET3DV6	1787	May 29, 2012	May 28, 2013
SPEAG	Dosimetric E-Field Probe	ET3DV6R	1788	Jan. 26, 2012	Jan. 25, 2013
SPEAG	Dosimetric E-Field Probe	EX3DV4	3792	Jun. 21, 2012	Jun. 20, 2013
SPEAG	Dosimetric E-Field Probe	ES3DV3	3296	Apr. 10, 2012	Apr. 09, 2013
SPEAG	Dosimetric E-Field Probe	EX3DV4	3820	Dec. 16, 2011	Dec. 15, 2012
SPEAG	Device Holder	N/A	N/A	NCR	NCR
SPEAG	SAM Phantom	QD 000 P40 C	TP-1303	NCR	NCR
SPEAG	SAM Phantom	QD 000 P40 C	TP-1383	NCR	NCR
SPEAG	SAM Phantom	QD 000 P40 C	TP-1446	NCR	NCR
SPEAG	SAM Phantom	QD 000 P40 C	TP-1478	NCR	NCR
SPEAG	SAM Phantom	QD 000 P41 C	TP-1150	NCR	NCR
SPEAG	SAM Phantom	QD 000 P40 CD	TP-1644	NCR	NCR
SPEAG	SAM Phantom	SM 000 T01 DA	TP-1542	NCR	NCR
SPEAG	ELI4 Phantom	QD 0VA 001 BB	1026	NCR	NCR
SPEAG	ELI4 Phantom	QD 0VA 001 BA	1029	NCR	NCR
SPEAG	ELI4 Phantom	QD 0VA 002 AA	TP-1127	NCR	NCR
SPEAG	ELI4 Phantom	QD 0VA 002 AA	TP-1131	NCR	NCR
Agilent	Network Analyzer	E5071C	MY46101588	May 11, 2012	May 10, 2013
Agilent	ESG Vector Series Signal Generator	E4438C	MY49070755	Oct. 17, 2011	Oct. 16, 2012
Anritsu	Power Meter	ML2495A	1132003	Aug. 14, 2012	Aug. 13, 2013
Anritsu	Radio Communication Analyzer	MT8820C	6201074414	Dec. 21, 2011	Dec. 20, 2012
Agilent	Wireless Communication Test Set	E5515C	MY48360820	Jan. 05, 2012	Jan. 04, 2014
Agilent	Wireless Communication Test Set	E5515C	GB46311322	Mar. 23, 2011	Mar. 22, 2013
Agilent	Wireless Communication Test Set	E5515C	MY50264370	Apr. 19, 2011	Apr. 18, 2013
Agilent	Wireless Communication Test Set	E5515C	MY50266977	Nov. 13, 2011	Nov. 12, 2013
R&S	Universal Digital Radiocommunication Tester	CMU200	106656	Jun. 28, 2012	Jun. 27, 2013
R&S	Spectrum Analyzer	FSP	101131	Jul. 23, 2012	Jul. 22, 2013

**Table 5.1 Test Equipment List**

**Note:**

1. The calibration certificate of DASY can be referred to appendix C of this report.
2. Referring to KDB 450824 D02, the dipole calibration interval can be extended to 3 years with justification. The dipoles are also not physically damaged, or repaired during the interval.
3. The justification data of dipole D750V3, SN: 1012, D835V2, SN: 499, D1900V2, SN: 5d041, and D2450V2, SN: 736 can be found in appendix C. The return loss is < -20dB, within 20% of prior calibration, the impedance is within 5 ohm of prior calibration.

## 6. Tissue Simulating Liquids

For the measurement of the field distribution inside the SAM phantom with DASY, the phantom must be filled with around 25 liters of homogeneous body tissue simulating liquid. For head SAR testing, the liquid height from the ear reference point (ERP) of the phantom to the liquid top surface is larger than 15 cm, which is shown in Fig. 6.1. For body SAR testing, the liquid height from the center of the flat phantom to the liquid top surface is larger than 15 cm, which is shown in Fig. 6.2.

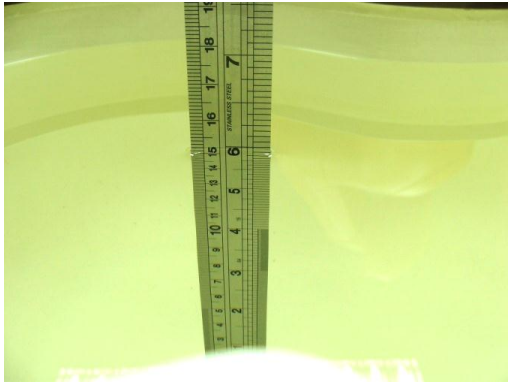

Fig 6.1 Photo of Liquid Height for Head SAR



Fig 6.2 Photo of Liquid Height for Body SAR

The following table gives the recipes for tissue simulating liquid.

Frequency (MHz)	Water (%)	Sugar (%)	Cellulose (%)	Salt (%)	Preventol (%)	DGBE (%)	Conductivity ( $\sigma$ )	Permittivity ( $\epsilon_r$ )
<b>For Head</b>								
750	41.1	57.0	0.2	1.4	0.2	0	0.89	41.9
835	40.3	57.9	0.2	1.4	0.2	0	0.90	41.5
1800, 1900, 2000	55.2	0	0	0.3	0	44.5	1.40	40.0
2450	55.0	0	0	0	0	45.0	1.80	39.2
<b>For Body</b>								
750	51.7	47.2	0	0.9	0.1	0	0.96	55.5
835	50.8	48.2	0	0.9	0.1	0	0.97	55.2
1800, 1900, 2000	70.2	0	0	0.4	0	29.4	1.52	53.3
2450	68.6	0	0	0	0	31.4	1.95	52.7

Table 6.1 Recipes of Tissue Simulating Liquid

### Simulating Liquid for 5G, Manufactured by SPEAG

Ingredients	(% by weight)
Water	64~78%
Mineral oil	11~18%
Emulsifiers	9~15%
Additives and Salt	2~3%



The dielectric parameters of the liquids were verified prior to the SAR evaluation using an Agilent 85070D Dielectric Probe Kit and an Agilent Network Analyzer.

The following table shows the measuring results for simulating liquid.

Freq. (MHz)	Liquid Type	Temp. (°C)	Conductivity (σ)	Permittivity (ε <sub>r</sub> )	Conductivity Target (σ)	Permittivity Target (ε <sub>r</sub> )	Delta (σ) (%)	Delta (ε <sub>r</sub> ) (%)	Limit (%)	Date
750	Head	21.5	0.896	41	0.89	41.9	0.67	-2.15	±5	Aug. 31, 2012
750	Head	21.6	0.893	41	0.89	41.9	0.34	-2.15	±5	Sep. 19, 2012
750	Body	21.5	0.963	54.2	0.96	55.5	0.31	-2.34	±5	Aug. 31, 2012
750	Body	21.6	0.961	54.1	0.96	55.5	0.10	-2.52	±5	Sep. 15, 2012
750	Body	21.6	0.962	53.9	0.96	55.5	0.21	-2.88	±5	Sep. 19, 2012
835	Head	21.6	0.904	41.129	0.9	41.5	0.44	-0.89	±5	Aug. 28, 2012
835	Head	21.5	0.916	41.7	0.9	41.5	1.78	0.48	±5	Sep. 18, 2012
835	Head	21.5	0.899	40.548	0.9	41.5	-0.11	-2.29	±5	Dec. 11, 2012
835	Body	21.5	0.961	54.572	0.97	55.2	-0.93	-1.14	±5	Aug. 29, 2012
835	Body	21.6	0.963	54.5	0.97	55.2	-0.72	-1.27	±5	Sep. 15, 2012
835	Body	21.6	0.962	54.6	0.97	55.2	-0.82	-1.09	±5	Sep. 19, 2012
835	Body	21.4	0.963	54.5	0.97	55.2	-0.72	-1.27	±5	Dec. 11, 2012
1750	Head	21.5	1.391	39.757	1.4	40	-0.64	-0.61	±5	Aug. 29, 2012
1750	Head	21.2	1.4	41.4	1.4	40	0.00	3.50	±5	Aug. 31, 2012
1750	Head	21.5	1.39	40.1	1.4	40	-0.71	0.25	±5	Sep. 18, 2012
1750	Head	21.6	1.38	41	1.4	40	-1.43	2.50	±5	Sep. 22, 2012
1750	Head	21.6	1.381	40.07	1.4	40	-1.36	0.18	±5	Dec. 11, 2012
1750	Body	21.6	1.522	53.843	1.52	53.3	0.13	1.02	±5	Aug. 30, 2012
1750	Body	21.5	1.55	51.7	1.52	53.3	1.97	-3.00	±5	Sep. 15, 2012
1750	Body	21.6	1.53	51.7	1.52	53.3	0.66	-3.00	±5	Sep. 18, 2012
1750	Body	21.6	1.52	52.2	1.52	53.3	0.00	-2.06	±5	Sep. 22, 2012
1750	Body	21.5	1.489	53.474	1.52	53.3	-2.04	0.33	±5	Dec. 11, 2012
1900	Head	21.5	1.427	39.815	1.4	40	1.93	-0.46	±5	Aug. 29, 2012
1900	Head	21.5	1.45	38.2	1.40	40.0	3.57	-4.50	±5	Aug. 30, 2012
1900	Head	21.6	1.45	39.5	1.40	40.0	3.57	-1.25	±5	Sep. 18, 2012
1900	Head	21.5	1.44	38.1	1.40	40.0	2.86	-4.75	±5	Sep. 21, 2012
1900	Head	21.6	1.429	38.693	1.4	40	2.07	-3.27	±5	Dec. 11, 2012
1900	Body	21.8	1.531	52.652	1.52	53.3	0.72	-1.22	±5	Aug. 28, 2012
1900	Body	21.2	1.52	53.2	1.52	53.3	0.00	-0.19	±5	Sep. 15, 2012
1900	Body	21.6	1.50	53.1	1.52	53.3	-1.32	-0.38	±5	Sep. 18, 2012
1900	Body	21.5	1.55	51	1.52	53.3	1.97	-4.32	±5	Sep. 22, 2012
1900	Body	21.5	1.539	54.55	1.52	53.3	1.25	2.35	±5	Dec. 11, 2012
2450	Head	21.3	1.85	39.3	1.80	39.2	2.78	0.26	±5	Sep. 16, 2012
2450	Head	21.2	1.82	39.1	1.80	39.2	1.11	-0.26	±5	Sep. 25, 2012
2450	Body	21.3	1.93	53.6	1.95	52.7	-1.03	1.71	±5	Sep. 16, 2012
2450	Body	21.2	2.01	53.8	1.95	52.7	3.08	2.09	±5	Sep. 25, 2012
5200	Head	21.6	4.8	35.5	4.66	36.0	3.00	-1.39	±5	Sep. 17, 2012
5200	Head	21.3	4.75	35.4	4.66	36.0	1.93	-1.67	±5	Sep. 26, 2012
5200	Body	21.4	5.14	47.5	5.30	49.0	-3.02	-3.06	±5	Sep. 16, 2012
5200	Body	21.5	5.12	47.2	5.30	49.0	-3.40	-3.67	±5	Sep. 26, 2012
5500	Head	21.6	5.12	35	4.96	35.6	3.23	-1.69	±5	Sep. 17, 2012
5500	Head	21.3	5.10	34	4.96	35.6	2.82	-4.49	±5	Sep. 26, 2012
5500	Body	21.4	5.52	47	5.65	48.6	-2.30	-3.29	±5	Sep. 16, 2012
5500	Body	21.5	5.51	47.5	5.65	48.6	-2.48	-2.26	±5	Sep. 26, 2012
5800	Head	21.6	5.41	34.4	5.27	35.3	2.66	-2.55	±5	Sep. 17, 2012
5800	Head	21.3	5.40	34.1	5.27	35.3	2.47	-3.40	±5	Sep. 26, 2012
5800	Body	21.4	5.97	46.3	6.00	48.2	-0.50	-3.94	±5	Sep. 16, 2012
5800	Body	21.5	5.99	46.5	6.00	48.2	-0.17	-3.53	±5	Sep. 26, 2012

Table 6.2 Measuring Results for Simulating Liquid

## 7. SAR Measurement Evaluation

Each DASY system is equipped with one or more system validation kits. These units, together with the predefined measurement procedures within the DASY software, enable the user to conduct the system performance check and system validation. System validation kit includes a dipole, tripod holder to fix it underneath the flat phantom and a corresponding distance holder.

### 7.1 Purpose of System Performance check

The system performance check verifies that the system operates within its specifications. System and operator errors can be detected and corrected. It is recommended that the system performance check be performed prior to any usage of the system in order to guarantee reproducible results. The system performance check uses normal SAR measurements in a simplified setup with a well characterized source. This setup was selected to give a high sensitivity to all parameters that might fail or vary over time. The system check does not intend to replace the calibration of the components, but indicates situations where the system uncertainty is exceeded due to drift or failure.

### 7.2 System Setup

In the simplified setup for system evaluation, the EUT is replaced by a calibrated dipole and the power source is replaced by a continuous wave that comes from a signal generator. The calibrated dipole must be placed beneath the flat phantom section of the SAM twin phantom with the correct distance holder. The distance holder should touch the phantom surface with a light pressure at the reference marking and be oriented parallel to the long side of the phantom. The equipment setup is shown below:

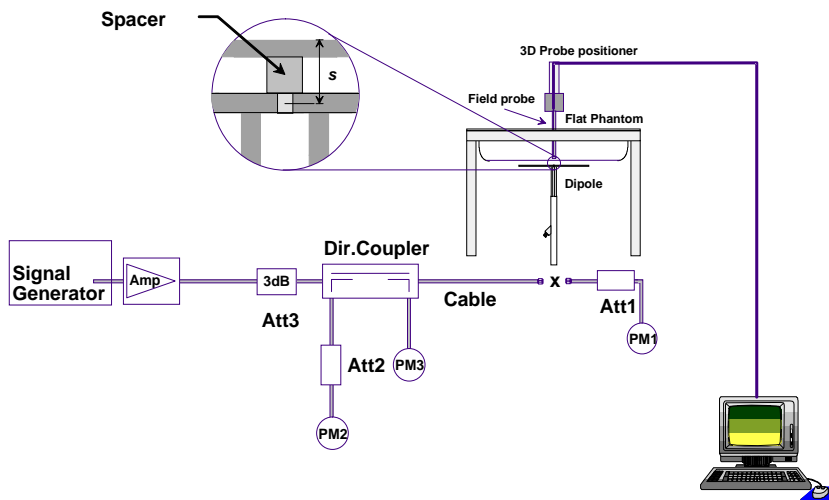

Fig 7.1 System Setup for System Evaluation



Fig 7.2 Photo of Dipole Setup

1. Signal Generator
2. Amplifier
3. Directional Coupler
4. Power Meter
5. Calibrated Dipole

The output power on dipole port must be calibrated to 24 dBm (250 mW) before dipole is connected.



**7.3 Validation Results**

Comparing to the original SAR value provided by SPEAG, the validation data should be within its specification of 10 %. Table 7.1 shows the target SAR and measured SAR after normalized to 1W input power. The table below indicates the system performance check can meet the variation criterion and the plots can be referred to Appendix A of this report.

Measurement Date	Frequency (MHz)	Liquid Type	Targeted SAR <sub>1g</sub> (W/kg)	Measured SAR <sub>1g</sub> (W/kg)	Normalized SAR <sub>1g</sub> (W/kg)	Deviation (%)
Aug. 31, 2012	750	Head	8.28	2.03	8.12	-1.93
Sep. 19, 2012	750	Head	8.28	2	8.00	-3.38
Aug. 31, 2012	750	Body	8.86	2.17	8.68	-2.03
Sep. 15, 2012	750	Body	8.86	2.18	8.72	-1.58
Sep. 19, 2012	750	Body	8.86	2.24	8.96	1.13
Aug. 28, 2012	835	Head	9.71	2.48	9.92	2.16
Sep. 18, 2012	835	Head	9.71	2.36	9.44	-2.78
Dec. 11, 2012	835	Head	9.71	2.32	9.28	-4.43
Aug. 29, 2012	835	Body	9.82	2.52	10.08	2.65
Sep. 15, 2012	835	Body	9.82	2.32	9.28	-5.50
Sep. 19, 2012	835	Body	9.82	2.52	10.08	2.65
Dec. 11, 2012	835	Body	9.82	2.43	9.72	-1.02
Aug. 29, 2012	1750	Head	35.8	8.33	33.32	-6.93
Aug. 31, 2012	1750	Head	35.8	9.05	36.20	1.12
Sep. 18, 2012	1750	Head	35.8	8.63	34.52	-3.58
Sep. 22, 2012	1750	Head	35.8	8.86	35.44	-1.01
Dec. 11, 2012	1750	Head	35.8	9.38	37.52	4.80
Aug. 30, 2012	1750	Body	37	8.66	34.64	-6.38
Sep. 15, 2012	1750	Body	37	8.97	35.88	-3.03
Sep. 18, 2012	1750	Body	37	8.58	34.32	-7.24
Sep. 22, 2012	1750	Body	37	8.52	34.08	-7.89
Dec. 11, 2012	1750	Body	37	8.780	35.12	-5.08
Aug. 29, 2012	1900	Head	39.8	9.3	37.20	-6.53
Aug. 30, 2012	1900	Head	39.8	9.59	38.36	-3.62
Sep. 18, 2012	1900	Head	39.8	9.79	39.16	-1.61
Sep. 21, 2012	1900	Head	39.8	9.26	37.04	-6.93
Dec. 11, 2012	1900	Head	39.8	9.67	38.68	-2.81
Aug. 28, 2012	1900	Body	40	9.46	37.84	-5.40
Sep. 15, 2012	1900	Body	40	9.95	39.80	-0.50
Sep. 18, 2012	1900	Body	40	9.33	37.32	-6.70
Sep. 22, 2012	1900	Body	40	9.64	38.56	-3.60
Dec. 11, 2012	1900	Body	40	9.6	38.40	-4.00
Sep. 16, 2012	2450	Head	54.8	13.7	54.80	0.00
Sep. 25, 2012	2450	Head	54.8	13.8	55.20	0.73
Sep. 16, 2012	2450	Body	52.3	12.3	49.20	-5.93
Sep. 25, 2012	2450	Body	52.3	14.1	56.40	7.84
Sep. 17, 2012	5200	Head	79.2	21	84.00	6.06
Sep. 26, 2012	5200	Head	79.2	19.4	77.60	-2.02
Sep. 16, 2012	5200	Body	72.6	19.4	77.60	6.89
Sep. 26, 2012	5200	Body	72.6	19.1	76.40	5.23
Sep. 17, 2012	5500	Head	85.2	21.7	86.80	1.88
Sep. 26, 2012	5500	Head	85.2	20.1	80.40	-5.63
Sep. 16, 2012	5500	Body	78.8	20.8	83.20	5.58
Sep. 26, 2012	5500	Body	78.8	20.8	83.20	5.58
Sep. 17, 2012	5800	Head	79	19.4	77.60	-1.77
Sep. 26, 2012	5800	Head	79	20.4	81.60	3.29
Sep. 16, 2012	5800	Body	73.1	18.5	74.00	1.23
Sep. 26, 2012	5800	Body	73.1	18.9	75.60	3.42

**Table 7.1 Target and Measurement SAR after Normalized**

## 8. EUT Testing Position

### 8.1 Define two imaginary lines on the handset

- The vertical centerline passes through two points on the front side of the handset - the midpoint of the width  $w_t$  of the handset at the level of the acoustic output, and the midpoint of the width  $w_b$  of the bottom of the handset.
- The horizontal line is perpendicular to the vertical centerline and passes through the center of the acoustic output. The horizontal line is also tangential to the face of the handset at point A.
- The two lines intersect at point A. Note that for many handsets, point A coincides with the center of the acoustic output; however, the acoustic output may be located elsewhere on the horizontal line. Also note that the vertical centerline is not necessarily parallel to the front face of the handset, especially for clamshell handsets, handsets with flip covers, and other irregularly shaped handsets.

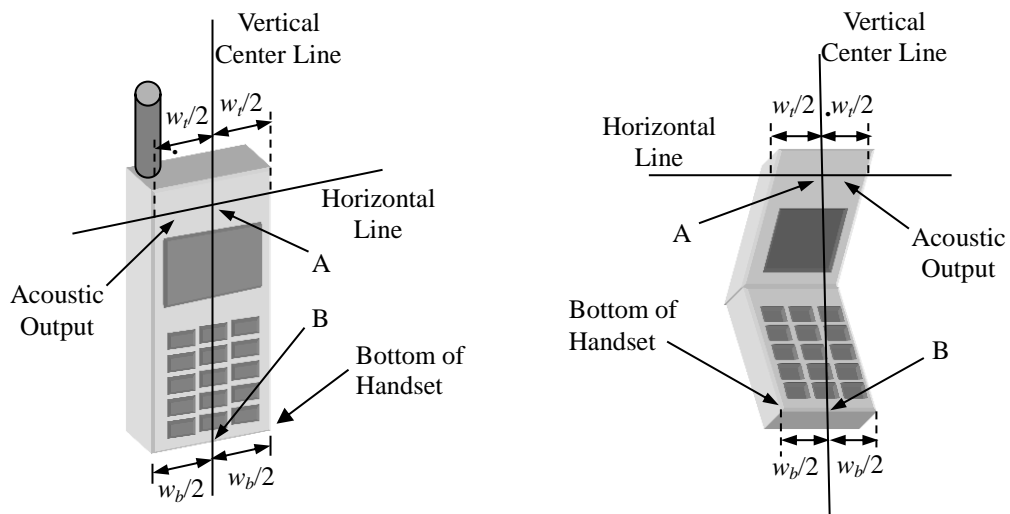

Fig 8.1 Illustration for Handset Vertical and Horizontal Reference Lines

**8.2 Cheek Position**

- (a) To position the device with the vertical center line of the body of the device and the horizontal line crossing the center piece in a plane parallel to the sagittal plane of the phantom. While maintaining the device in this plane, align the vertical center line with the reference plane containing the three ear and mouth reference point (M: Mouth, RE: Right Ear, and LE: Left Ear) and align the center of the ear piece with the line RE-LE.
- (b) To move the device towards the phantom with the ear piece aligned with the line LE-RE until the phone touched the ear. While maintaining the device in the reference plane and maintaining the phone contact with the ear, move the bottom of the phone until any point on the front side is in contact with the cheek of the phantom or until contact with the ear is lost (see Fig. 8.2).

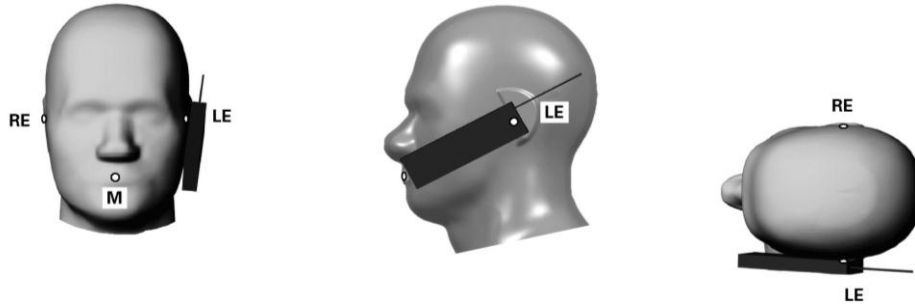

Fig 8.2 Illustration for Cheek Position

**8.3 Tilted Position**

- (a) To position the device in the “cheek” position described above.
- (b) While maintaining the device the reference plane described above and pivoting against the ear, moves it outward away from the mouth by an angle of 15 degrees or until contact with the ear is lost (see Fig. 8.3).

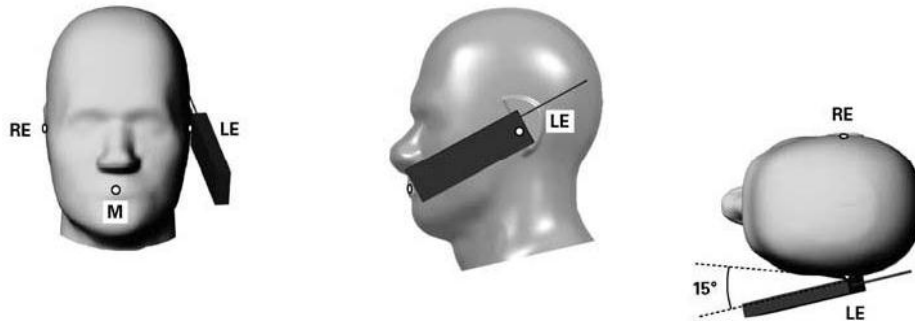
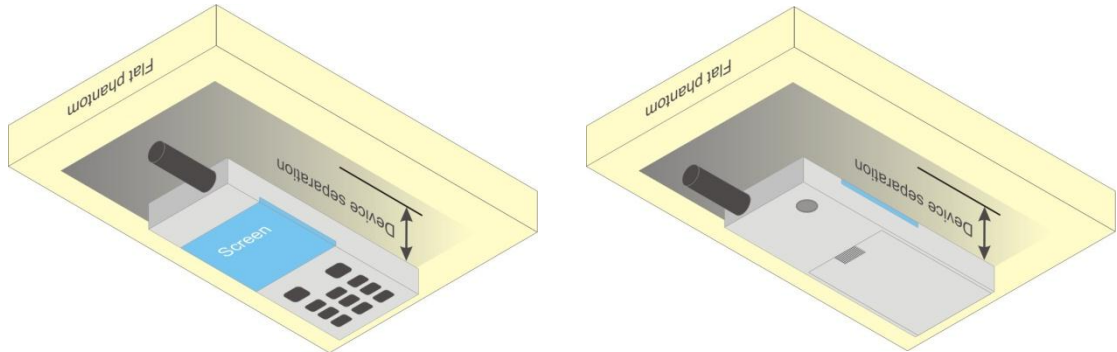

Fig 8.3 Illustration for Tilted Position

### 8.4 Body Worn Position

- (a) To position the device parallel to the phantom surface with either keypad up or down.
- (b) To adjust the device parallel to the flat phantom.
- (c) To adjust the distance between the device surface and the flat phantom to 1 cm.



**Fig 8.4 Illustration for Body Worn Position**

#### <EUT Setup Photos>

Please refer to Appendix D for the test setup photos.





## 9. Measurement Procedures

The measurement procedures are as follows:

- (a) Use base station simulator (if applicable) or engineering software to transmit RF power continuously (continuous Tx) in the highest power channel.
- (b) Keep EUT to radiate maximum output power or 100% duty factor (if applicable)
- (c) Measure output power through RF cable and power meter.
- (d) Place the EUT in the positions as Appendix D demonstrates.
- (e) Set scan area, grid size and other setting on the DASY software.
- (f) Measure SAR results for the highest power channel on each testing position.
- (g) Find out the largest SAR result on these testing positions of each band
- (h) Measure SAR results for other channels in worst SAR testing position if the SAR of highest power channel is larger than 0.8 W/kg

According to the test standard, the recommended procedure for assessing the peak spatial-average SAR value consists of the following steps:

- (a) Power reference measurement
- (b) Area scan
- (c) Zoom scan
- (d) Power drift measurement

### 9.1 Spatial Peak SAR Evaluation

The procedure for spatial peak SAR evaluation has been implemented according to the test standard. It can be conducted for 1g and 10g, as well as for user-specific masses. The DASY software includes all numerical procedures necessary to evaluate the spatial peak SAR value.

The base for the evaluation is a "cube" measurement. The measured volume must include the 1g and 10g cubes with the highest averaged SAR values. For that purpose, the center of the measured volume is aligned to the interpolated peak SAR value of a previously performed area scan.

The entire evaluation of the spatial peak values is performed within the post-processing engine (SEMCAD). The system always gives the maximum values for the 1g and 10g cubes. The algorithm to find the cube with highest averaged SAR is divided into the following stages:

- (a) Extraction of the measured data (grid and values) from the Zoom Scan
- (b) Calculation of the SAR value at every measurement point based on all stored data (A/D values and measurement parameters)
- (c) Generation of a high-resolution mesh within the measured volume
- (d) Interpolation of all measured values from the measurement grid to the high-resolution grid
- (e) Extrapolation of the entire 3-D field distribution to the phantom surface over the distance from sensor to surface
- (f) Calculation of the averaged SAR within masses of 1g and 10g

### 9.2 Area & Zoom Scan Procedures

First Area Scan is used to locate the approximate location(s) of the local peak SAR value(s). The measurement grid within an Area Scan is defined by the grid extent, grid step size and grid offset. Next, in order to determine the EM field distribution in a three-dimensional spatial extension, Zoom Scan is required. The Zoom Scan measures 5x5x7 points with step size 8, 8 and 5 mm for 300 MHz to 3 GHz, and 8x8x8 points with step size 4, 4 and 2.5 mm for 3 GHz to 6 GHz. The Zoom Scan is performed around the highest E-field value to determine the averaged SAR-distribution over 10 g.



### **9.3 Volume Scan Procedures**

The volume scan is used to assess overlapping SAR distributions for antennas transmitting in different frequency bands. It is equivalent to an oversized zoom scan used in standalone measurements. The measurement volume will be used to enclose all the simultaneous transmitting antennas. For antennas transmitting simultaneously in different frequency bands, the volume scan is measured separately in each frequency band. In order to sum correctly to compute the 1g aggregate SAR, the EUT remains in the same test position for all measurements and all volume scans use the same spatial resolution and grid spacing (step-size is 4, 4 and 2.5 mm). When all volume scans are completed, the software, SEMCAD postprocessor can combine and subsequently superpose these measurement data to calculate the multiband SAR.

### **9.4 SAR Averaged Methods**

In DASy, the interpolation and extrapolation are both based on the modified Quadratic Shepard's method. The interpolation scheme combines a least-square fitted function method and a weighted average method which are the two basic types of computational interpolation and approximation.

Extrapolation routines are used to obtain SAR values between the lowest measurement points and the inner phantom surface. The extrapolation distance is determined by the surface detection distance and the probe sensor offset. The uncertainty increases with the extrapolation distance. To keep the uncertainty within 1% for the 1 g and 10 g cubes, the extrapolation distance should not be larger than 5 mm.

### **9.5 Power Drift Monitoring**

All SAR testing is under the EUT installed full charged battery and transmit maximum output power. In DASy measurement software, the power reference measurement and power drift measurement procedures are used for monitoring the power drift of EUT during SAR test. Both these procedures measure the field at a specified reference position before and after the SAR testing. The software will calculate the field difference in dB. If the power drifts more than 5%, the SAR will be retested.

## 10. SAR Test Configurations

### 10.1 Exposure Positions Consideration

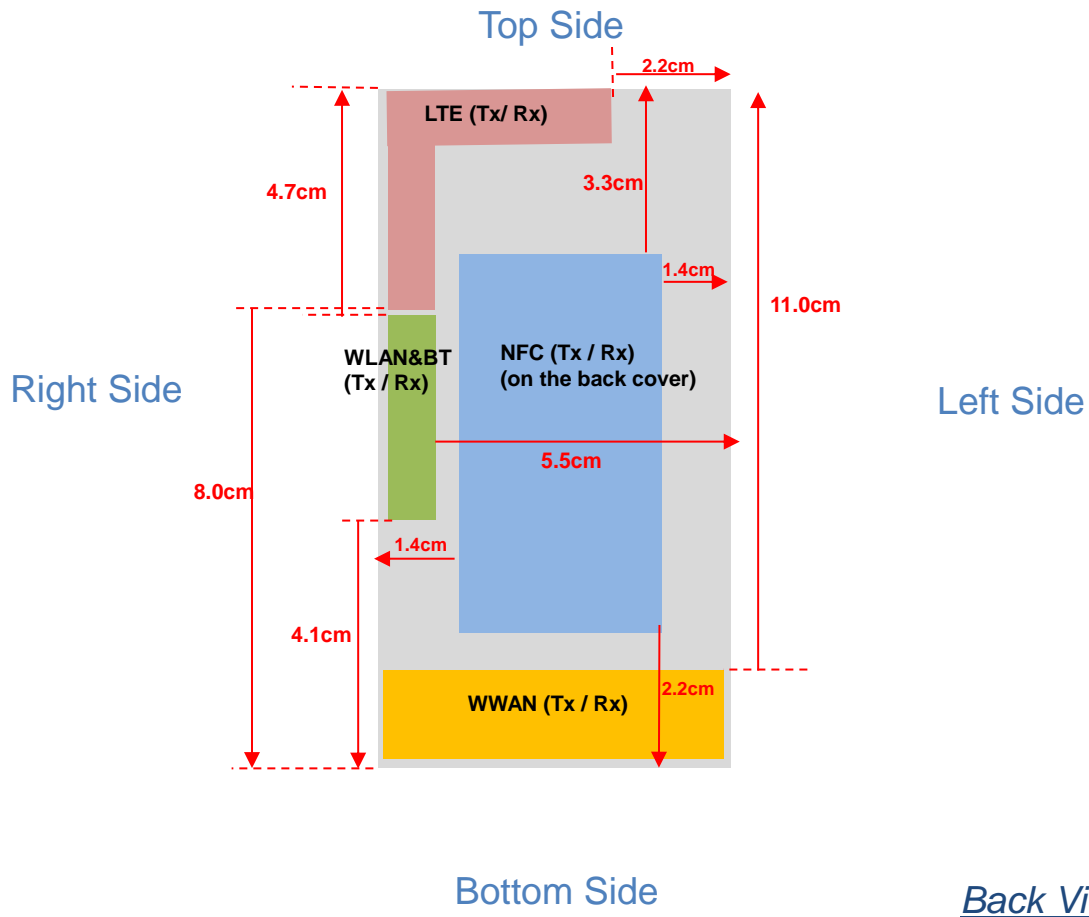

Antennas	Wireless Interface
WWAN (Tx / Rx)	CDMA2000 BC0 CDMA2000 BC1 CDMA2000 BC15
LTE (Tx / Rx)	LTE Band 2 LTE Band 4 LTE Band 12
WLAN/BT (Tx / Rx)	WLAN 2.4GHz WLAN 5GHz Bluetooth
NFC (Tx / Rx) (on the back cover)	NFC 13.56 MHz



The distance from antenna to edge cover				
Antennas	Top Side	Bottom Side	Right Side	Left Side
WWAN	110 mm			
LTE		80 mm		
WLAN/BT	47 mm	41 mm		55 mm

**Remark:** The numbers above justify the SAR exclusion per KDB 941225 D06.

Sides for SAR tests; Hotspot mode						
Test distance: 10 mm						
Antennas	Back	Front	Top Side	Bottom Side	Right Side	Left Side
WWAN	YES	YES	NO	YES	YES	YES
LTE	YES	YES	YES	NO	YES	YES
WLAN/BT	YES	YES	NO	NO	YES	NO

**Note:**

1. Head/Body-worn/Hotspot mode SAR assessments are required.
2. Referring to KDB 941225 D06, when the overall device length and width are  $\geq 9\text{ cm} \times 5\text{ cm}$ , the test distance is 10 mm. SAR must be measured for all sides and surfaces with a transmitting antenna located within 25 mm from that surface or edge.
3. For Main antenna, SAR measurements at Top side are not required since the distance between the transmitting antenna and surface of device is  $> 25\text{ mm}$ .
4. For LTE antenna, SAR measurements at Bottom side are not required since the distance between the transmitting antenna and surface of device is  $> 25\text{ mm}$ .
5. For WLAN/BT antenna, SAR measurements Top/Bottom/Left sides are not required since the distance between the transmitting antenna and surface of device is  $> 25\text{ mm}$ .
6. Per KDB 648474 D01, Bluetooth output power  $\leq P_{\text{Ref}}$  and each other antennas SAR is less than 1.2 W/kg, therefore stand-alone SAR is not required.



10.2 Conducted RF Output Power (Unit: dBm)

<CDMA2000>

Band	CDMA2000 BC0			CDMA2000 BC1			CDMA2000 BC15		
	1013	384	777	25	600	1175	25	425	875
Channel	824.70	836.52	848.31	1851.25	1880.00	1908.75	1711.25	1731.25	1753.75
Frequency (MHz)	824.70	836.52	848.31	1851.25	1880.00	1908.75	1711.25	1731.25	1753.75
1xRTT RC1+SO55	24.65	24.60	24.61	24.63	24.72	24.42	24.79	24.74	24.69
1xRTT RC3+SO55	24.49	24.51	24.47	24.69	24.70	24.30	24.80	24.70	24.66
1xRTT RC3+SO32 (FCH)	24.47	24.57	24.51	24.63	24.67	24.05	24.84	24.63	24.55
1xRTT RC3+SO32 (FCH+SCH)	24.55	24.58	24.49	24.67	24.66	24.06	24.82	24.62	24.68
1xEVDO RTAP 153.6	24.58	24.66	24.62	24.74	24.82	24.54	24.88	24.63	24.61
1xEVDO RETAP 4096	24.53	24.56	24.47	24.72	24.76	24.51	24.86	24.61	24.59

Note:

1. According to KDB 941225 D01, Head SAR for RC1+SO55 is not required because the maximum average output power of RC1 is less than 0.25 dB higher than RC3+SO55.
2. Referring to KDB 941225 D01, the CDMA Handset Body-worn SAR tests based on RC3+SO32. RC1, RTAP (REV 0), and RETAP (Rev A) power are all less than 0.25 dB higher than RC3, thus SAR tests in these mode are not necessary.
3. Referring to KDB 941225 D01, in Hotspot mode EUT is treated as data device and SAR is tested with RTAP 153.6kbps (Ev-Do). If RC3+SO32 power is less than 0.25 dB higher than Ev-Do, SAR tests with RC3+SO32 setting are not necessary.



<LTE Band 2 Conducted Power >

BW [MHz]	Mod / RB (Size - Offset)	Average Power. (dBm)			3GPP MPR	MPR Result (dB)		
		Low Ch	Mid Ch	High Ch		Low Ch	Mid Ch	High Ch
	Channel	18650	18900	19150		18650	18900	19150
	Frequency (MHz)	1855	1880	1905		1855	1880	1905
10	QPSK 1-0	23.05	23.40	23.09	0	0.08	0.00	0.04
10	QPSK 1-49	23.13	23.11	23.13		0.00	0.29	0.00
10	QPSK 25-13	22.01	22.06	22.22	≤ 1	1.12	1.34	0.91
10	QPSK 50-0	21.88	22.01	22.05		1.25	1.39	1.08
10	16QAM 1-0	22.15	22.44	22.09	≤ 1	0.98	0.96	1.04
10	16QAM 1-49	22.09	22.30	22.23		1.04	1.10	0.90
10	16QAM 25-13	21.04	21.12	21.17	≤ 2	2.09	2.28	1.96
10	16QAM 50-0	20.91	21.15	20.98		2.22	2.25	2.15
	Channel	18625	18900	19175		18625	18900	19175
	Frequency (MHz)	1852.5	1880	1907.5		1852.5	1880	1907.5
5	QPSK 1-0	22.61	23.00	23.00	0	0.00	0.00	0.00
5	QPSK 1-24	22.59	22.94	22.88		0.02	0.06	0.12
5	QPSK 12-6	21.80	21.96	22.07	≤ 1	0.81	1.04	0.93
5	QPSK 25-0	21.71	21.82	21.86		0.90	1.18	1.14
5	16QAM 1-0	22.00	21.91	22.22	≤ 1	0.61	1.09	0.78
5	16QAM 1-24	21.70	21.79	21.93		0.91	1.21	1.07
5	16QAM 12-6	21.13	21.04	21.25	≤ 2	1.48	1.96	1.75
5	16QAM 25-0	20.84	20.84	20.95		1.77	2.16	2.05
	Channel	18615	18900	19185		18615	18900	19185
	Frequency (MHz)	1851.5	1880	1908.5		1851.5	1880	1908.5
3	QPSK 1-0	22.87	23.02	23.02	0	0.05	0.00	0.00
3	QPSK 1-14	22.92	22.85	22.84		0.00	0.17	0.18
3	QPSK 8-4	21.98	21.99	22.15	≤ 1	0.94	1.03	0.87
3	QPSK 15-0	21.95	21.91	21.91		0.97	1.11	1.11
3	16QAM 1-0	22.05	22.02	22.19	≤ 1	0.87	1.00	0.83
3	16QAM 1-14	22.02	21.87	22.01		0.90	1.15	1.01
3	16QAM 8-4	21.00	21.07	21.11	≤ 2	1.92	1.95	1.91
3	16QAM 15-0	21.07	21.07	21.10		1.85	1.95	1.92
	Channel	18607	18900	19193		18607	18900	19193
	Frequency (MHz)	1850.7	1880	1909.3		1850.7	1880	1909.3
1.4	QPSK 1-0	23.04	23.08	23.04	0	0.00	0.00	0.00
1.4	QPSK 1-5	22.96	23.00	22.83		0.08	0.08	0.21
1.4	QPSK 3-2	22.94	23.05	22.95	≤ 1	0.10	0.03	0.09
1.4	QPSK 6-0	22.10	21.95	22.02		0.94	1.13	1.02
1.4	16QAM 1-0	22.31	22.18	21.99	≤ 1	0.73	0.90	1.05
1.4	16QAM 1-5	22.19	22.07	22.12		0.85	1.01	0.92
1.4	16QAM 3-2	22.10	21.97	22.30	≤ 2	0.94	1.11	0.74
1.4	16QAM 6-0	21.48	21.12	21.20		1.56	1.96	1.84

**Note:** Per KDB 941225, if the output power variation across the band < 0.5 dB, test middle channel SAR first and determine further test reduction based on the SAR results.



<LTE Band 4 Conducted Power >

BW [MHz]	Mod / RB (Size - Offset)	Average Power. (dBm)			3GPP MPR	MPR Result (dB)		
		Low Ch	Mid Ch	High Ch		Low Ch	Mid Ch	High Ch
	Channel	20000	20175	20350		20000	20175	20350
	Frequency (MHz)	1715	1732.5	1750		1715	1732.5	1750
10	QPSK 1-0	23.28	23.41	23.32	0	0.00	0.00	0.00
10	QPSK 1-49	23.24	23.38	23.30	0	0.04	0.03	0.02
10	QPSK 25-13	22.35	22.27	22.21	≤ 1	0.93	1.14	1.11
10	QPSK 50-0	22.14	21.95	22.13	≤ 1	1.14	1.46	1.19
10	16QAM 1-0	22.30	22.40	22.34	≤ 1	0.98	1.01	0.98
10	16QAM 1-49	21.95	22.02	22.10	≤ 1	1.33	1.39	1.22
10	16QAM 25-13	21.28	21.43	21.10	≤ 2	2.00	1.98	2.22
10	16QAM 50-0	21.09	21.11	21.13	≤ 2	2.19	2.30	2.19
	Channel	19975	20175	20375		19975	20175	20375
	Frequency (MHz)	1712.5	1732.5	1752.5		1712.5	1732.5	1752.5
5	QPSK 1-0	23.18	23.36	23.35	0	0.10	0.02	0.00
5	QPSK 1-24	23.28	23.38	23.30	0	0.00	0.00	0.05
5	QPSK 12-6	22.41	22.39	22.09	≤ 1	0.87	0.99	1.26
5	QPSK 25-0	22.33	22.23	21.95	≤ 1	0.95	1.15	1.40
5	16QAM 1-0	22.34	22.33	22.30	≤ 1	0.94	1.05	1.05
5	16QAM 1-24	22.30	22.04	22.32	≤ 1	0.98	1.34	1.03
5	16QAM 12-6	21.47	21.45	21.17	≤ 2	1.81	1.93	2.18
5	16QAM 25-0	21.15	21.23	21.07	≤ 2	2.13	2.15	2.28
	Channel	19965	20175	20385		19965	20175	20385
	Frequency (MHz)	1711.5	1732.5	1753.5		1711.5	1732.5	1753.5
3	QPSK 1-0	23.31	23.33	23.14	0	0.05	0.06	0.18
3	QPSK 1-14	23.36	23.39	23.32	0	0.00	0.00	0.00
3	QPSK 8-4	22.44	22.45	22.19	≤ 1	0.92	0.94	1.13
3	QPSK 15-0	22.43	22.34	22.19	≤ 1	0.93	1.05	1.13
3	16QAM 1-0	22.39	22.25	22.01	≤ 1	0.97	1.14	1.31
3	16QAM 1-14	22.17	22.37	21.99	≤ 1	1.19	1.02	1.33
3	16QAM 8-4	21.43	21.45	21.24	≤ 2	1.93	1.94	2.08
3	16QAM 15-0	21.41	21.48	21.18	≤ 2	1.95	1.91	2.14
	Channel	19957	20175	20393		19957	20175	20393
	Frequency (MHz)	1710.7	1732.5	1754.3		1710.7	1732.5	1754.3
1.4	QPSK 1-0	23.38	23.38	23.27	0	0.00	0.00	0.05
1.4	QPSK 1-5	23.37	23.36	23.32	0	0.01	0.02	0.00
1.4	QPSK 3-2	23.36	23.31	23.31	≤ 1	0.02	0.07	0.01
1.4	QPSK 6-0	22.47	22.38	22.30	≤ 1	0.91	1.00	1.02
1.4	16QAM 1-0	22.23	22.35	22.30	≤ 1	1.15	1.03	1.02
1.4	16QAM 1-5	22.39	22.30	22.26	≤ 1	0.99	1.08	1.06
1.4	16QAM 3-2	22.38	22.28	22.25	≤ 1	1.00	1.10	1.07
1.4	16QAM 6-0	21.31	21.44	21.24	≤ 2	2.07	1.94	2.08

Note: Per KDB 941225, if the output power variation across the band < 0.5 dB, test middle channel SAR first and determine further test reduction based on the SAR results.



<LTE Band 12 Conducted Power >

BW [MHz]	Mod / RB (Size - Offset)	Average Power. (dBm)			3GPP MPR	MPR Result (dB)		
		Low Ch	Mid Ch	High Ch		Low Ch	Mid Ch	High Ch
	Channel	23060	23095	23130		23060	23095	23130
	Frequency (MHz)	704	707.5	711		704	707.5	711
10	QPSK 1-0	23.40	23.60	23.39	0	0.02	0.00	0.00
10	QPSK 1-49	23.42	23.45	23.35	0	0.00	0.15	0.04
10	QPSK 25-13	22.68	22.64	22.43	≤ 1	0.74	0.96	0.96
10	QPSK 50-0	22.52	22.49	22.47	≤ 1	0.90	1.11	0.92
10	16QAM 1-0	22.59	22.89	22.42	≤ 1	0.83	0.71	0.97
10	16QAM 1-49	22.84	22.63	22.72	≤ 1	0.58	0.97	0.67
10	16QAM 25-13	21.59	21.72	21.46	≤ 2	1.83	1.88	1.93
10	16QAM 50-0	21.39	21.47	21.55	≤ 2	2.03	2.13	1.84
	Channel	23035	23095	23155		23035	23095	23155
	Frequency (MHz)	701.5	707.5	713.5		701.5	707.5	713.5
5	QPSK 1-0	23.49	23.46	23.52	0	0.01	0.07	0.00
5	QPSK 1-24	23.50	23.53	23.50	0	0.00	0.00	0.02
5	QPSK 12-6	22.67	22.95	22.68	≤ 1	0.83	0.58	0.84
5	QPSK 25-0	22.50	22.71	22.58	≤ 1	1.00	0.82	0.94
5	16QAM 1-0	22.86	22.84	22.62	≤ 1	0.64	0.69	0.90
5	16QAM 1-24	22.69	22.79	22.82	≤ 1	0.81	0.74	0.70
5	16QAM 12-6	21.70	21.88	21.60	≤ 2	1.80	1.65	1.92
5	16QAM 25-0	21.48	21.73	21.50	≤ 2	2.02	1.80	2.02
	Channel	23025	23095	23165		23025	23095	23165
	Frequency (MHz)	700.5	707.5	714.5		700.5	707.5	714.5
3	QPSK 1-0	23.50	23.51	23.42	0	0.00	0.00	0.02
3	QPSK 1-14	23.44	23.50	23.44	0	0.06	0.01	0.00
3	QPSK 8-4	22.51	22.82	22.81	≤ 1	0.99	0.69	0.63
3	QPSK 15-0	22.55	22.65	22.58	≤ 1	0.95	0.86	0.86
3	16QAM 1-0	22.74	22.87	22.78	≤ 1	0.76	0.64	0.66
3	16QAM 1-14	22.70	22.88	22.70	≤ 1	0.80	0.63	0.74
3	16QAM 8-4	21.45	21.85	21.57	≤ 2	2.05	1.66	1.87
3	16QAM 15-0	21.55	21.78	21.48	≤ 2	1.95	1.73	1.96
	Channel	23017	23095	23173		23017	23095	23173
	Frequency (MHz)	699.7	707.5	715.3		699.7	707.5	715.3
1.4	QPSK 1-0	23.52	23.54	23.50	0	0.00	0.00	0.00
1.4	QPSK 1-5	23.50	23.49	23.47	0	0.02	0.05	0.03
1.4	QPSK 3-2	23.43	23.51	23.32	≤ 1	0.09	0.03	0.18
1.4	QPSK 6-0	22.78	22.75	22.65	≤ 1	0.74	0.79	0.85
1.4	16QAM 1-0	22.88	22.80	22.62	≤ 1	0.64	0.74	0.88
1.4	16QAM 1-5	22.50	22.84	22.79	≤ 1	1.02	0.70	0.71
1.4	16QAM 3-2	22.77	22.83	22.73	≤ 1	0.75	0.71	0.77
1.4	16QAM 6-0	21.75	21.97	21.75	≤ 2	1.77	1.57	1.75

Note: Per KDB 941225, if the output power variation across the band < 0.5 dB, test middle channel SAR first and determine further test reduction based on the SAR results.





<WLAN 2.4GHz Conducted Power>

WLAN 2.4G 802.11b Average Power (dBm)						
Power vs. Channel			Power vs. Data Rate			
Channel	Frequency (MHz)	Data Rate (bps)	Channel	Data Rate (bps)		
		1M		2M	5.5M	11M
CH 01	2412	17.94	CH 06	18.49	18.47	18.51
CH 06	2437	18.52				
CH 11	2462	17.76				

WLAN 2.4G 802.11g Average Power (dBm)										
Power vs. Channel			Power vs. Data Rate							
Channel	Frequency (MHz)	Data Rate (bps)	Channel	Data Rate (bps)						
		6M		9M	12M	18M	24M	36M	48M	54M
CH 01	2412	13.20	CH 11	13.03	13.04	13.01	13.04	13.03	13.03	13.03
CH 06	2437	12.72								
CH 11	2462	13.05								

WLAN 2.4G 802.11n (BW 20MHz) Average Power (dBm)										
Power vs. Channel			Power vs. Data Rate							
Channel	Frequency (MHz)	MCS Index	Channel	MCS Index						
		MCS0		MCS1	MCS2	MCS3	MCS4	MCS5	MCS6	MCS7
CH 01	2412	12.28	CH 11	12.02	12.02	12.01	12.03	11.99	12.01	12.02
CH 06	2437	11.76								
CH 11	2462	12.04								

WLAN 2.4G 802.11n (BW 40MHz) Average Power (dBm)										
Power vs. Channel			Power vs. Data Rate							
Channel	Frequency (MHz)	MCS Index	Channel	MCS Index						
		MCS0		MCS1	MCS2	MCS3	MCS4	MCS5	MCS6	MCS7
CH 03	2422	11.65	CH 09	12.60	12.84	12.95	13.19	13.27	13.34	13.52
CH 06	2437	12.16								
CH 09	2452	12.42								

Note:

1. Per KDB 248227, choose the highest output power channel to test SAR and determine further SAR exclusion
2. Per KDB 248227, 11g, 11n-HT20 and 11n-HT40 output power is less than 0.25 dB higher than 11b mode, thus the SAR can be excluded.
3. For each frequency band, testing at higher data rates and higher order modulations is not required when the maximum average output power for each of these configurations is less than 0.25 dB higher than those measured at the lowest data rate.



<Bluetooth Conducted Power>

Channel	Frequency (MHz)	Average power (dBm)		
		Mode		
		GFSK	$\pi/4$ -DQPSK	8-DPSK
CH 0	2402	6.11	2.75	2.76
CH 39	2441	6.09	2.53	2.55
CH 78	2480	6.07	2.42	2.44

Channel	Frequency (MHz)	Average power (dBm)
		Mode
		BT 4.0 LE, GFSK
CH 0	2402	1.69
CH 19	2440	1.67
CH 39	2480	1.88

<WLAN 5GHz Conducted Power>

WLAN 5G 802.11a Average Power (dBm)										
Power vs. Channel			Power vs. Data Rate							
Channel	Frequency (MHz)	Data Rate (bps)	Channel	Data Rate (bps)						
		6M		9M	12M	18M	24M	36M	48M	54M
CH 36	5180	11.88	CH 44	12.49	12.50	12.49	12.43	12.49	12.47	12.50
CH 40	5200	12.06								
CH 44	5220	12.51								
CH 48	5240	12.38								
CH 52	5260	12.60	CH 52	12.55	12.59	12.58	12.58	12.57	12.55	12.58
CH 56	5280	12.10								
CH 60	5300	12.56								
CH 64	5320	12.48								
CH 100	5500	11.79								
CH 104	5520	11.84	CH 140	12.59	12.61	12.60	12.60	12.61	12.59	12.60
CH 108	5540	11.82								
CH 112	5560	11.70								
CH 116	5580	12.54								
CH 132	5660	11.73								
CH 136	5680	11.77								
CH 140	5700	12.62								
CH 149	5745	12.38								
CH 153	5765	12.41	CH 157	12.42	12.37	12.41	12.43	12.41	12.39	12.43
CH 157	5785	12.44								
CH 161	5805	12.43								
CH 165	5825	11.69								



WLAN 5G 802.11n (BW 20M) Average Power (dBm)										
Power vs. Channel			Power vs. Data Rate							
Channel	Frequency (MHz)	MCS Index	Channel	MCS Index						
		MCS0		MCS1	MCS2	MCS3	MCS4	MCS5	MCS6	MCS7
CH 36	5180	12.04	CH 36	12.02	12.01	12.03	12.02	12.02	11.98	12.00
CH 40	5200	12.02								
CH 44	5220	11.85								
CH 48	5240	11.74								
CH 52	5260	11.95	CH 60	12.04	11.95	12.01	12.02	12.04	12.02	12.04
CH 56	5280	12.03								
CH 60	5300	12.06								
CH 64	5320	11.77								
CH 100	5500	12.00	CH 100	11.92	11.89	11.90	11.93	11.98	11.98	11.99
CH 104	5520	11.94								
CH 108	5540	11.92								
CH 112	5560	11.71								
CH 116	5580	11.85								
CH 132	5660	11.86								
CH 136	5680	11.98								
CH 140	5700	11.80								
CH 149	5745	12.53	CH 165	12.56	12.56	12.56	12.55	12.57	12.56	12.57
CH 153	5765	12.54								
CH 157	5785	12.49								
CH 161	5805	12.56								
CH 165	5825	12.58								

WLAN 5G 802.11n (BW 40M) Average Power (dBm)										
Power vs. Channel			Power vs. Data Rate							
Channel	Frequency (MHz)	MCS Index	Channel	MCS Index						
		MCS0		MCS1	MCS2	MCS3	MCS4	MCS5	MCS6	MCS7
CH 38	5190	12.80	CH 38	12.65	12.75	12.72	12.66	12.67	12.78	12.79
CH 46	5230	12.46								
CH 54	5270	12.69	CH 62	12.43	12.64	12.72	12.54	12.58	12.71	12.69
CH 62	5310	12.73								
CH 102	5510	12.75	CH 102	12.53	12.64	12.74	12.67	12.74	12.71	12.74
CH 110	5550	12.37								
CH 134	5670	12.46								
CH 151	5755	12.26	CH 159	12.18	12.20	12.22	12.23	12.22	12.20	12.22
CH 159	5795	12.24								

**Note:**

1. Per KDB 248227, choose the highest output power channel to test SAR and determine further SAR exclusion
2. Per KDB 248227, 11n-HT20 and 11n-HT40 output power is less than 0.25 dB higher than 11a mode, thus the SAR can be excluded.
3. For each frequency band, testing at higher data rates and higher order modulations is not required when the maximum average output power for each of these configurations is less than 0.25 dB higher than those measured at the lowest data rate.



## 11. SAR Test Results

### 11.1 Test Records for Head SAR Test

<CDMA SAR>

Plot No.	Band	Mode	Test Position	Ch.	Freq. (MHz)	Average Power (dBm)	Power Drift (dB)	SAR <sub>1g</sub> (W/kg)	SAR <sub>10g</sub> (W/kg)	Sample
1	CDMA2000 BC0	RC3+SO55	Right Cheek	384	836.52	24.51	-0.19	0.312	0.243	1
2	CDMA2000 BC0	RC3+SO55	Right Tilted	384	836.52	24.51	-0.05	0.210	0.165	1
3	CDMA2000 BC0	RC3+SO55	Left Cheek	384	836.52	24.51	0.1	0.282	0.216	1
4	CDMA2000 BC0	RC3+SO55	Left Tilted	384	836.52	24.51	-0.01	0.206	0.163	1
279	CDMA2000 BC0	RC3+SO55	Right Cheek	384	836.52	24.51	-0.014	0.309	0.243	2
304	CDMA2000 BC0	RETAP4096	Right Cheek	384	836.52	24.56	-0.15	0.283	0.22	1
41	CDMA2000 BC15	RC3+SO55	Right Cheek	25	1711.25	24.80	-0.02	0.307	0.202	1
42	CDMA2000 BC15	RC3+SO55	Right Tilted	25	1711.25	24.80	0.05	0.169	0.110	1
43	CDMA2000 BC15	RC3+SO55	Left Cheek	25	1711.25	24.80	0.15	0.306	0.200	1
44	CDMA2000 BC15	RC3+SO55	Left Tilted	25	1711.25	24.80	0.01	0.184	0.122	1
278	CDMA2000 BC15	RC3+SO55	Right Cheek	25	1711.25	24.80	0.142	0.245	0.164	2
303	CDMA2000 BC15	RETAP4096	Right Cheek	25	1711.25	24.86	0.1	0.282	0.189	1
65	CDMA2000 BC1	RC3+SO55	Right Cheek	600	1880	24.70	-0.15	0.422	0.317	1
66	CDMA2000 BC1	RC3+SO55	Right Tilted	600	1880	24.70	-0.01	0.223	0.135	1
67	CDMA2000 BC1	RC3+SO55	Left Cheek	600	1880	24.70	-0.11	0.554	0.342	1
68	CDMA2000 BC1	RC3+SO55	Left Tilted	600	1880	24.70	0.01	0.247	0.155	1
277	CDMA2000 BC1	RC3+SO55	Left Cheek	600	1880	24.70	0.064	0.513	0.321	2
302	CDMA2000 BC1	RETAP4096	Left Cheek	600	1880	24.76	-0.09	0.544	0.341	1

**Note:**

- Per KDB 648474 and KDB 447498, if the highest output channel SAR for each exposure position  $\leq 0.8$  W/kg other channels SAR tests are not necessary.
- Sample 2 is additional verify on the worst case of sample 1. From the verification of 2<sup>nd</sup> source, LCM/camera does not impact the SAR.



<LTE SAR>

Plot No.	Band	Mode (RB Size-Offset)	BW (MHz)	Test Position	Ch.	Freq. (MHz)	Average Power (dBm)	Power Drift (dB)	SAR <sub>1g</sub> (W/kg)	SAR <sub>10g</sub> (W/kg)	Sample
136	LTE Band 12	QPSK(25-13)	10M	Right Cheek	23095	707.5	22.64	0.084	0.151	0.095	1
137	LTE Band 12	QPSK(1-0)	10M	Right Cheek	23095	707.5	23.60	-0.059	0.151	0.094	1
138	LTE Band 12	QPSK(1-49)	10M	Right Cheek	23095	707.5	23.45	0.004	0.144	0.089	1
139	LTE Band 12	16QAM(25-13)	10M	Right Cheek	23095	707.5	21.72	0.035	0.129	0.080	1
140	LTE Band 12	16QAM(1-0)	10M	Right Cheek	23095	707.5	22.89	-0.039	0.147	0.092	1
141	LTE Band 12	16QAM(1-49)	10M	Right Cheek	23095	707.5	22.63	0.037	0.140	0.086	1
142	LTE Band 12	QPSK(25-13)	10M	Right Tilted	23095	707.5	22.64	-0.029	0.145	0.085	1
143	LTE Band 12	QPSK(1-0)	10M	Right Tilted	23095	707.5	23.60	-0.072	0.144	0.085	1
144	LTE Band 12	QPSK(1-49)	10M	Right Tilted	23095	707.5	23.45	0.117	0.138	0.080	1
145	LTE Band 12	16QAM(25-13)	10M	Right Tilted	23095	707.5	21.72	0.043	0.123	0.072	1
146	LTE Band 12	16QAM(1-0)	10M	Right Tilted	23095	707.5	22.89	0.043	0.136	0.079	1
147	LTE Band 12	16QAM(1-49)	10M	Right Tilted	23095	707.5	22.63	0.087	0.135	0.077	1
148	LTE Band 12	QPSK(25-13)	10M	Left Cheek	23095	707.5	22.64	-0.081	0.242	0.129	1
149	LTE Band 12	QPSK(1-0)	10M	Left Cheek	23095	707.5	23.60	-0.013	0.240	0.128	1
150	LTE Band 12	QPSK(1-49)	10M	Left Cheek	23095	707.5	23.45	-0.031	0.232	0.122	1
151	LTE Band 12	16QAM(25-13)	10M	Left Cheek	23095	707.5	21.72	-0.024	0.206	0.107	1
152	LTE Band 12	16QAM(1-0)	10M	Left Cheek	23095	707.5	22.89	-0.068	0.233	0.123	1
153	LTE Band 12	16QAM(1-49)	10M	Left Cheek	23095	707.5	22.63	0.08	0.225	0.119	1
154	LTE Band 12	QPSK(25-13)	10M	Left Tilted	23095	707.5	22.64	0.019	0.243	0.126	1
155	LTE Band 12	QPSK(1-0)	10M	Left Tilted	23095	707.5	23.60	-0.08	0.240	0.125	1
156	LTE Band 12	QPSK(1-49)	10M	Left Tilted	23095	707.5	23.45	0.017	0.235	0.122	1
157	LTE Band 12	16QAM(25-13)	10M	Left Tilted	23095	707.5	21.72	0.028	0.206	0.107	1
158	LTE Band 12	16QAM(1-0)	10M	Left Tilted	23095	707.5	22.89	-0.084	0.233	0.120	1
159	LTE Band 12	16QAM(1-49)	10M	Left Tilted	23095	707.5	22.63	0.07	0.227	0.118	1
280	LTE Band 12	QPSK(25-13)	10M	Left Tilted	23095	707.5	22.64	-0.15	0.159	0.086	2



Plot No.	Band	Mode (RB Size-Offset)	BW (MHz)	Test Position	Ch.	Freq. (MHz)	Average Power (dBm)	Power Drift (dB)	SAR <sub>1g</sub> (W/kg)	SAR <sub>10g</sub> (W/kg)	Sample
190	LTE Band 4	QPSK(25-13)	10M	Right Cheek	20175	1732.5	22.27	0.001	0.408	0.269	1
191	LTE Band 4	QPSK(1-0)	10M	Right Cheek	20175	1732.5	23.41	0.039	0.433	0.286	1
192	LTE Band 4	QPSK(1-49)	10M	Right Cheek	20175	1732.5	23.38	0.036	0.428	0.282	1
193	LTE Band 4	16QAM(25-13)	10M	Right Cheek	20175	1732.5	21.43	-0.154	0.317	0.208	1
194	LTE Band 4	16QAM(1-0)	10M	Right Cheek	20175	1732.5	22.40	0.008	0.419	0.276	1
195	LTE Band 4	16QAM(1-49)	10M	Right Cheek	20175	1732.5	22.02	-0.088	0.410	0.270	1
196	LTE Band 4	QPSK(25-13)	10M	Right Tilted	20175	1732.5	22.27	0.138	0.585	0.364	1
197	LTE Band 4	QPSK(1-0)	10M	Right Tilted	20175	1732.5	23.41	-0.126	0.739	0.419	1
198	LTE Band 4	QPSK(1-49)	10M	Right Tilted	20175	1732.5	23.38	0.158	0.715	0.412	1
199	LTE Band 4	16QAM(25-13)	10M	Right Tilted	20175	1732.5	21.43	-0.141	0.489	0.304	1
200	LTE Band 4	16QAM(1-0)	10M	Right Tilted	20175	1732.5	22.40	0.083	0.616	0.382	1
201	LTE Band 4	16QAM(1-49)	10M	Right Tilted	20175	1732.5	22.02	0.151	0.605	0.375	1
202	LTE Band 4	QPSK(25-13)	10M	Left Cheek	20175	1732.5	22.27	0.063	0.571	0.304	1
203	LTE Band 4	QPSK(1-0)	10M	Left Cheek	20175	1732.5	23.41	0.045	0.614	0.327	1
204	LTE Band 4	QPSK(1-49)	10M	Left Cheek	20175	1732.5	23.38	-0.095	0.604	0.321	1
205	LTE Band 4	16QAM(25-13)	10M	Left Cheek	20175	1732.5	21.43	-0.079	0.437	0.232	1
206	LTE Band 4	16QAM(1-0)	10M	Left Cheek	20175	1732.5	22.40	0.062	0.598	0.317	1
207	LTE Band 4	16QAM(1-49)	10M	Left Cheek	20175	1732.5	22.02	0.112	0.593	0.313	1
208	LTE Band 4	QPSK(25-13)	10M	Left Tilted	20175	1732.5	22.27	0.123	0.625	0.339	1
209	LTE Band 4	QPSK(1-0)	10M	Left Tilted	20175	1732.5	23.41	0.185	0.667	0.364	1
210	LTE Band 4	QPSK(1-49)	10M	Left Tilted	20175	1732.5	23.38	-0.014	0.665	0.361	1
211	LTE Band 4	16QAM(25-13)	10M	Left Tilted	20175	1732.5	21.43	0.018	0.505	0.273	1
212	LTE Band 4	16QAM(1-0)	10M	Left Tilted	20175	1732.5	22.40	0.061	0.658	0.357	1
213	LTE Band 4	16QAM(1-49)	10M	Left Tilted	20175	1732.5	22.02	0.108	0.665	0.357	1
276	LTE Band 4	QPSK(1-0)	10M	Right Tilted	20175	1732.5	23.41	0.192	0.658	0.408	2



Plot No.	Band	Mode (RB Size-Offset)	BW (MHz)	Test Position	Ch.	Freq. (MHz)	Average Power (dBm)	Power Drift (dB)	SAR <sub>1g</sub> (W/kg)	SAR <sub>10g</sub> (W/kg)	Sample
112	LTE Band 2	QPSK(25-13)	10M	Right Cheek	18900	1880	22.06	0.154	0.388	0.217	1
113	LTE Band 2	QPSK(1-0)	10M	Right Cheek	18900	1880	23.40	0.092	0.489	0.278	1
114	LTE Band 2	QPSK(1-49)	10M	Right Cheek	18900	1880	23.11	0.067	0.400	0.227	1
115	LTE Band 2	16QAM(25-13)	10M	Right Cheek	18900	1880	21.12	-0.014	0.324	0.183	1
116	LTE Band 2	16QAM(1-0)	10M	Right Cheek	18900	1880	22.44	-0.08	0.476	0.270	1
117	LTE Band 2	16QAM(1-49)	10M	Right Cheek	18900	1880	22.30	0.04	0.401	0.225	1
118	LTE Band 2	QPSK(25-13)	10M	Right Tilted	18900	1880	22.06	0.103	0.548	0.312	1
119	LTE Band 2	QPSK(1-0)	10M	Right Tilted	18900	1880	23.40	0.039	0.643	0.370	1
120	LTE Band 2	QPSK(1-49)	10M	Right Tilted	18900	1880	23.11	0.018	0.552	0.313	1
121	LTE Band 2	16QAM(25-13)	10M	Right Tilted	18900	1880	21.12	0.081	0.452	0.254	1
122	LTE Band 2	16QAM(1-0)	10M	Right Tilted	18900	1880	22.44	-0.107	0.654	0.372	1
123	LTE Band 2	16QAM(1-49)	10M	Right Tilted	18900	1880	22.30	0	0.545	0.305	1
124	LTE Band 2	QPSK(25-13)	10M	Left Cheek	18900	1880	22.06	-0.116	0.651	0.329	1
125	LTE Band 2	QPSK(1-0)	10M	Left Cheek	18900	1880	23.40	0.033	0.756	0.393	1
126	LTE Band 2	QPSK(1-49)	10M	Left Cheek	18900	1880	23.11	-0.003	0.649	0.330	1
127	LTE Band 2	16QAM(25-13)	10M	Left Cheek	18900	1880	21.12	-0.148	0.499	0.256	1
128	LTE Band 2	16QAM(1-0)	10M	Left Cheek	18900	1880	22.44	0.042	0.725	0.375	1
129	LTE Band 2	16QAM(1-49)	10M	Left Cheek	18900	1880	22.30	-0.041	0.616	0.312	1
130	LTE Band 2	QPSK(25-13)	10M	Left Tilted	18900	1880	22.06	-0.083	0.658	0.343	1
131	LTE Band 2	QPSK(1-0)	10M	Left Tilted	18900	1880	23.40	-0.032	0.805	0.417	1
132	LTE Band 2	QPSK(1-49)	10M	Left Tilted	18900	1880	23.11	0.003	0.663	0.344	1
133	LTE Band 2	16QAM(25-13)	10M	Left Tilted	18900	1880	21.12	0.082	0.540	0.279	1
<b>134</b>	<b>LTE Band 2</b>	<b>16QAM(1-0)</b>	<b>10M</b>	<b>Left Tilted</b>	<b>18900</b>	<b>1880</b>	<b>22.44</b>	<b>-0.189</b>	<b>0.808</b>	<b>0.414</b>	<b>1</b>
135	LTE Band 2	16QAM(1-49)	10M	Left Tilted	18900	1880	22.30	0.098	0.669	0.344	1
275	LTE Band 2	16QAM(1-0)	10M	Left Tilted	18900	1880	22.44	-0.102	0.505	0.253	2

**Note:**

1. Considering the users may install 3<sup>rd</sup> party software to enable VOIP, LTE Head SAR is also evaluated. Because FCC has not published uniform procedures for VOIP in LTE, therefore all channels and modes and modulations required under the other KDB pub 941225 D05 FCC LTE procedures were used for the held-near-head testing.
2. Per KDB 941225 D05, for LTE, if the smaller bandwidth output power is within +/- ½dB of the largest bandwidth, and the maximum SAR of the largest bandwidth is ≤ 1.45 W/kg, SAR for smaller bandwidth can be excluded.
3. Per KDB 941225 D05, if the measured 50%-RB QPSK 1g-SAR for the middle or highest output power channel is ≤ 0.8W/kg, remaining 2 channels SAR tests can be excluded. Otherwise, 50% RB allocation of the remaining 2 channels SAR tests are necessary.
4. Per KDB 941225 D05, for LTE, if 50%-RB QPSK SAR ≤ 1.45 W/kg, 100%-RB QPSK SAR can be excluded; if 50%-RB 16QAM SAR ≤ 1.45 W/kg, 100%-RB 16QAM SAR can be excluded.
5. If SAR of 1 RB allocation is ≤ 1.45W/kg, SAR of 1 RB allocation of remaining channels can be excluded.
6. Sample 2 is additional verify on the worst case of sample 1. From the verification of 2nd source, LCM/camera does not impact the SAR.



<WLAN SAR>

Plot No.	Band	Mode	Test Position	Ch.	Freq. (MHz)	Average Power (dBm)	Power Drift (dB)	SAR <sub>1g</sub> (W/kg)	SAR <sub>10g</sub> (W/kg)	Sample
227	WLAN2.4G	802.11b	Right Cheek	6	2437	18.52	-0.034	0.532	0.288	1
228	WLAN2.4G	802.11b	Right Tilted	6	2437	18.52	-0.103	0.171	0.083	1
229	WLAN2.4G	802.11b	Left Cheek	6	2437	18.52	0.112	0.447	0.215	1
230	WLAN2.4G	802.11b	Left Tilted	6	2437	18.52	-0.005	0.151	0.075	1
287	WLAN2.4G	802.11b	Right Cheek	6	2437	18.52	0.137	0.529	0.244	2
259	WLAN5G	802.11a	Right Cheek	44	5220	12.51	0.103	0.042	0.012	1
260	WLAN5G	802.11a	Right Tilted	44	5220	12.51	0.082	0.029	0.0055	1
261	WLAN5G	802.11a	Left Cheek	44	5220	12.51	0.023	0.047	0.012	1
262	WLAN5G	802.11a	Left Tilted	44	5220	12.51	0.108	0.025	0.00686	1
289	WLAN5G	802.11a	Left Cheek	44	5220	12.51	0.01	0.038	0.014	2
263	WLAN5G	802.11a	Right Cheek	52	5260	12.60	0.011	0.040	0.00647	1
264	WLAN5G	802.11a	Right Tilted	52	5260	12.60	0.104	0.024	0.00393	1
265	WLAN5G	802.11a	Left Cheek	52	5260	12.60	0	0.023	0.00369	1
266	WLAN5G	802.11a	Left Tilted	52	5260	12.60	0.01	0.031	0.00825	1
290	WLAN5G	802.11a	Right Cheek	52	5260	12.60	-0.011	0.030	0.010	2
267	WLAN5G	802.11a	Right Cheek	140	5700	12.62	0.002	0.033	0.00751	1
268	WLAN5G	802.11a	Right Tilted	140	5700	12.62	0.12	0.021	0.00313	1
269	WLAN5G	802.11a	Left Cheek	140	5700	12.62	0	0.031	0.00872	1
270	WLAN5G	802.11a	Left Tilted	140	5700	12.62	0.001	0.020	0.0055	1
291	WLAN5G	802.11a	Right Cheek	140	5700	12.62	-0.011	0.021	0.0077	2
271	WLAN5G	802.11a	Right Cheek	157	5785	12.44	0.14	0.021	0.00297	1
272	WLAN5G	802.11a	Right Tilted	157	5785	12.44	0.013	2.92E-05	2.92E-06	1
273	WLAN5G	802.11a	Left Cheek	157	5785	12.44	0.12	0.033	0.00984	1
274	WLAN5G	802.11a	Left Tilted	157	5785	12.44	0.103	0.019	0.00536	1
292	WLAN5G	802.11a	Left Cheek	157	5785	12.44	-0.0125	0.030	0.0098	2

Note:

1. Per KDB 648474 and KDB 248227, if the highest output channel SAR for each exposure position ≤ 0.8 W/kg other channels SAR tests are not necessary.
2. Sample 2 is additional verify on the worst case of sample 1. From the verification of 2nd source, LCM/camera does not impact the SAR.





**11.2 Test Records for Hotspot SAR Test**

**<CDMA SAR>**

Plot No.	Band	Mode	Test Position	Gap (cm)	Ch.	Freq. (MHz)	Average Power (dBm)	Power Drift (dB)	SAR <sub>1g</sub> (W/kg)	SAR <sub>10g</sub> (W/kg)	Sample
58	CDMA2000 BC0	RTAP153.6	Front	1	384	836.52	24.66	-0.07	0.371	0.287	1
<b>59</b>	<b>CDMA2000 BC0</b>	<b>RTAP153.6</b>	<b>Back</b>	<b>1</b>	<b>384</b>	<b>836.52</b>	<b>24.66</b>	<b>-0.03</b>	<b>0.558</b>	<b>0.422</b>	<b>1</b>
60	CDMA2000 BC0	RTAP153.6	Left Side	1	384	836.52	24.66	0.04	0.342	0.237	1
61	CDMA2000 BC0	RTAP153.6	Right Side	1	384	836.52	24.66	0.18	0.433	0.300	1
62	CDMA2000 BC0	RTAP153.6	Bottom Side	1	384	836.52	24.66	-0.13	0.098	0.054	1
286	CDMA2000 BC0	RTAP153.6	Back	1	384	836.52	24.66	-0.03	0.534	0.389	2
69	CDMA2000 BC15	RTAP153.6	Front	1	25	1711.25	24.88	-0.17	0.413	0.259	1
<b>70</b>	<b>CDMA2000 BC15</b>	<b>RTAP153.6</b>	<b>Back</b>	<b>1</b>	<b>25</b>	<b>1711.25</b>	<b>24.88</b>	<b>-0.14</b>	<b>0.704</b>	<b>0.413</b>	<b>1</b>
71	CDMA2000 BC15	RTAP153.6	Left Side	1	25	1711.25	24.88	-0.13	0.156	0.087	1
72	CDMA2000 BC15	RTAP153.6	Right Side	1	25	1711.25	24.88	0.13	0.059	0.032	1
73	CDMA2000 BC15	RTAP153.6	Bottom Side	1	25	1711.25	24.88	-0.06	0.288	0.158	1
47	CDMA2000 BC1	RTAP153.6	Front	1	600	1880	24.82	0.02	0.681	0.421	1
48	CDMA2000 BC1	RTAP153.6	Back	1	600	1880	24.82	-0.11	0.983	0.570	1
49	CDMA2000 BC1	RTAP153.6	Back	1	25	1851.25	24.74	-0.03	0.918	0.532	1
<b>50</b>	<b>CDMA2000 BC1</b>	<b>RTAP153.6</b>	<b>Back</b>	<b>1</b>	<b>1175</b>	<b>1908.75</b>	<b>24.54</b>	<b>-0.01</b>	<b>0.993</b>	<b>0.566</b>	<b>1</b>
51	CDMA2000 BC1	RTAP153.6	Left Side	1	600	1880	24.82	-0.02	0.320	0.184	1
52	CDMA2000 BC1	RTAP153.6	Right Side	1	600	1880	24.82	-0.17	0.165	0.098	1
53	CDMA2000 BC1	RTAP153.6	Bottom Side	1	600	1880	24.82	-0.05	0.483	0.277	1
281	CDMA2000 BC1	RTAP153.6	Back	1	1175	1908.75	24.54	-0.081	0.765	0.451	2

**Note:**

1. Per KDB 941225 D06, for EUT dimension ≥ 9cm\*5cm, the test distance is 1cm. SAR must be measured for all surfaces and sides with a transmitting antenna located within 2.5cm from that surface or edge.
2. As in (1), SAR for Front / Back / Bottom Side / Left Side / Right Side is necessary.
3. Per KDB 648474 and KDB 447498 if the highest output channel SAR for each exposure position ≤ 0.8 W/kg other channels SAR tests are not necessary.
4. Sample 2 body SAR verification was performed on the worst case of sample 1 body SAR among hotspot and body-worn.



<LTE SAR>

Plot No.	Band	Mode (RB Size-Offset)	BW (MHz)	Test Position	Gap (cm)	Ch.	Freq. (MHz)	Average Power (dBm)	Power Drift (dB)	SAR <sub>1g</sub> (W/kg)	SAR <sub>10g</sub> (W/kg)	Sample
160	LTE Band 12	QPSK(25-13)	10M	Front	1	23095	707.5	22.64	-0.046	0.094	0.067	1
161	LTE Band 12	QPSK(1-0)	10M	Front	1	23095	707.5	23.60	-0.012	0.105	0.079	1
162	LTE Band 12	QPSK(1-49)	10M	Front	1	23095	707.5	23.45	0.037	0.103	0.079	1
163	LTE Band 12	16QAM(25-13)	10M	Front	1	23095	707.5	21.72	0.082	0.092	0.07	1
164	LTE Band 12	16QAM(1-0)	10M	Front	1	23095	707.5	22.89	0.011	0.102	0.078	1
165	LTE Band 12	16QAM(1-49)	10M	Front	1	23095	707.5	22.63	0.085	0.102	0.079	1
166	LTE Band 12	QPSK(25-13)	10M	Back	1	23095	707.5	22.64	-0.149	0.208	0.158	1
167	LTE Band 12	QPSK(1-0)	10M	Back	1	23095	707.5	23.60	0.05	0.205	0.156	1
168	LTE Band 12	QPSK(1-49)	10M	Back	1	23095	707.5	23.45	0.006	0.197	0.15	1
169	LTE Band 12	16QAM(25-13)	10M	Back	1	23095	707.5	21.72	0.057	0.174	0.133	1
170	LTE Band 12	16QAM(1-0)	10M	Back	1	23095	707.5	22.89	-0.053	0.201	0.154	1
171	LTE Band 12	16QAM(1-49)	10M	Back	1	23095	707.5	22.63	0.087	0.179	0.137	1
172	LTE Band 12	QPSK(25-13)	10M	Left Side	1	23095	707.5	22.64	0.022	0.058	0.041	1
173	LTE Band 12	QPSK(1-0)	10M	Left Side	1	23095	707.5	23.60	-0.067	0.058	0.040	1
174	LTE Band 12	QPSK(1-49)	10M	Left Side	1	23095	707.5	23.45	0.036	0.055	0.039	1
175	LTE Band 12	16QAM(25-13)	10M	Left Side	1	23095	707.5	21.72	0.132	0.05	0.036	1
176	LTE Band 12	16QAM(1-0)	10M	Left Side	1	23095	707.5	22.89	0.004	0.058	0.041	1
177	LTE Band 12	16QAM(1-49)	10M	Left Side	1	23095	707.5	22.63	0.023	0.054	0.039	1
178	LTE Band 12	QPSK(25-13)	10M	Right Side	1	23095	707.5	22.64	-0.091	0.122	0.087	1
179	LTE Band 12	QPSK(1-0)	10M	Right Side	1	23095	707.5	23.60	0.003	0.119	0.086	1
180	LTE Band 12	QPSK(1-49)	10M	Right Side	1	23095	707.5	23.45	0.067	0.119	0.085	1
181	LTE Band 12	16QAM(25-13)	10M	Right Side	1	23095	707.5	21.72	0.047	0.104	0.075	1
182	LTE Band 12	16QAM(1-0)	10M	Right Side	1	23095	707.5	22.89	-0.018	0.117	0.084	1
183	LTE Band 12	16QAM(1-49)	10M	Right Side	1	23095	707.5	22.63	-0.018	0.117	0.083	1
184	LTE Band 12	QPSK(25-13)	10M	Top Side	1	23095	707.5	22.64	-0.13	0.077	0.041	1
185	LTE Band 12	QPSK(1-0)	10M	Top Side	1	23095	707.5	23.60	0.086	0.075	0.040	1
186	LTE Band 12	QPSK(1-49)	10M	Top Side	1	23095	707.5	23.45	0.007	0.074	0.039	1
187	LTE Band 12	16QAM(25-13)	10M	Top Side	1	23095	707.5	21.72	0.091	0.062	0.033	1
188	LTE Band 12	16QAM(1-0)	10M	Top Side	1	23095	707.5	22.89	0.048	0.074	0.040	1
189	LTE Band 12	16QAM(1-49)	10M	Top Side	1	23095	707.5	22.63	0.187	0.072	0.039	1
285	LTE Band 12	QPSK(25-13)	10M	Back	1	23095	707.5	22.64	-0.169	0.184	0.138	2



Plot No.	Band	Mode (RB Size-Offset)	BW (MHz)	Test Position	Gap (cm)	Ch.	Freq. (MHz)	Average Power (dBm)	Power Drift (dB)	SAR <sub>1g</sub> (W/kg)	SAR <sub>10g</sub> (W/kg)	Sample
76	LTE Band 4	QPSK(25-13)	10M	Front	1	20175	1732.5	22.27	0.12	0.202	0.115	1
77	LTE Band 4	QPSK(1-0)	10M	Front	1	20175	1732.5	23.41	-0.01	0.204	0.114	1
78	LTE Band 4	QPSK(1-49)	10M	Front	1	20175	1732.5	23.38	0.15	0.200	0.118	1
79	LTE Band 4	16QAM(25-13)	10M	Front	1	20175	1732.5	21.43	0.01	0.149	0.084	1
80	LTE Band 4	16QAM(1-0)	10M	Front	1	20175	1732.5	22.40	0.12	0.198	0.110	1
81	LTE Band 4	16QAM(1-49)	10M	Front	1	20175	1732.5	22.02	-0.01	0.199	0.112	1
82	LTE Band 4	QPSK(25-13)	10M	Back	1	20175	1732.5	22.27	0.12	0.466	0.270	1
<b>83</b>	<b>LTE Band 4</b>	<b>QPSK(1-0)</b>	<b>10M</b>	<b>Back</b>	<b>1</b>	<b>20175</b>	<b>1732.5</b>	<b>23.41</b>	<b>-0.09</b>	<b>0.492</b>	<b>0.286</b>	<b>1</b>
84	LTE Band 4	QPSK(1-49)	10M	Back	1	20175	1732.5	23.38	-0.1	0.483	0.279	1
85	LTE Band 4	16QAM(25-13)	10M	Back	1	20175	1732.5	21.43	-0.12	0.360	0.206	1
86	LTE Band 4	16QAM(1-0)	10M	Back	1	20175	1732.5	22.40	-0.05	0.462	0.268	1
87	LTE Band 4	16QAM(1-49)	10M	Back	1	20175	1732.5	22.02	0.16	0.469	0.273	1
88	LTE Band 4	QPSK(25-13)	10M	Left Side	1	20175	1732.5	22.27	0.18	0.035	0.011	1
89	LTE Band 4	QPSK(1-0)	10M	Left Side	1	20175	1732.5	23.41	0.05	0.044	0.015	1
90	LTE Band 4	QPSK(1-49)	10M	Left Side	1	20175	1732.5	23.38	-0.19	0.043	0.016	1
91	LTE Band 4	16QAM(25-13)	10M	Left Side	1	20175	1732.5	21.43	0.15	0.012	0.00266	1
92	LTE Band 4	16QAM(1-0)	10M	Left Side	1	20175	1732.5	22.40	0.01	0.050	0.027	1
93	LTE Band 4	16QAM(1-49)	10M	Left Side	1	20175	1732.5	22.02	-0.19	0.047	0.024	1
94	LTE Band 4	QPSK(25-13)	10M	Right Side	1	20175	1732.5	22.27	-0.13	0.061	0.027	1
95	LTE Band 4	QPSK(1-0)	10M	Right Side	1	20175	1732.5	23.41	0.01	0.064	0.030	1
96	LTE Band 4	QPSK(1-49)	10M	Right Side	1	20175	1732.5	23.38	0.17	0.060	0.028	1
97	LTE Band 4	16QAM(25-13)	10M	Right Side	1	20175	1732.5	21.43	0.18	0.049	0.020	1
98	LTE Band 4	16QAM(1-0)	10M	Right Side	1	20175	1732.5	22.40	-0.04	0.069	0.033	1
99	LTE Band 4	16QAM(1-49)	10M	Right Side	1	20175	1732.5	22.02	0.16	0.068	0.032	1
100	LTE Band 4	QPSK(25-13)	10M	Top Side	1	20175	1732.5	22.27	0.11	0.331	0.179	1
101	LTE Band 4	QPSK(1-0)	10M	Top Side	1	20175	1732.5	23.41	0.14	0.352	0.191	1
102	LTE Band 4	QPSK(1-49)	10M	Top Side	1	20175	1732.5	23.38	0.1	0.353	0.191	1
103	LTE Band 4	16QAM(25-13)	10M	Top Side	1	20175	1732.5	21.43	-0.12	0.241	0.125	1
104	LTE Band 4	16QAM(1-0)	10M	Top Side	1	20175	1732.5	22.40	0.17	0.317	0.167	1
105	LTE Band 4	16QAM(1-49)	10M	Top Side	1	20175	1732.5	22.02	0.18	0.331	0.172	1



Plot No.	Band	Mode (RB Size-Offset)	BW (MHz)	Test Position	Gap (cm)	Ch.	Freq. (MHz)	Average Power (dBm)	Power Drift (dB)	SAR <sub>1g</sub> (W/kg)	SAR <sub>10g</sub> (W/kg)	Sample
5	LTE Band 2	QPSK(25-13)	10M	Front	1	18900	1880	22.06	0.14	0.148	0.079	1
6	LTE Band 2	QPSK(1-0)	10M	Front	1	18900	1880	23.40	0.17	0.187	0.101	1
7	LTE Band 2	QPSK(1-49)	10M	Front	1	18900	1880	23.11	0.11	0.156	0.088	1
8	LTE Band 2	16QAM(25-13)	10M	Front	1	18900	1880	21.12	0.12	0.145	0.083	1
9	LTE Band 2	16QAM(1-0)	10M	Front	1	18900	1880	22.44	0.04	0.241	0.129	1
10	LTE Band 2	16QAM(1-49)	10M	Front	1	18900	1880	22.30	-0.14	0.164	0.095	1
11	LTE Band 2	QPSK(25-13)	10M	Back	1	18900	1880	22.06	0.11	0.501	0.279	1
12	LTE Band 2	QPSK(1-0)	10M	Back	1	18900	1880	23.40	-0.06	0.593	0.328	1
13	LTE Band 2	QPSK(1-49)	10M	Back	1	18900	1880	23.11	0.1	0.487	0.269	1
14	LTE Band 2	16QAM(25-13)	10M	Back	1	18900	1880	21.12	0.05	0.409	0.226	1
15	LTE Band 2	16QAM(1-0)	10M	Back	1	18900	1880	22.44	-0.04	0.598	0.331	1
16	LTE Band 2	16QAM(1-49)	10M	Back	1	18900	1880	22.30	-0.14	0.490	0.272	1
17	LTE Band 2	QPSK(25-13)	10M	Left Side	1	18900	1880	22.06	0.14	0.053	0.022	1
18	LTE Band 2	QPSK(1-0)	10M	Left Side	1	18900	1880	23.40	0.08	0.073	0.041	1
19	LTE Band 2	QPSK(1-49)	10M	Left Side	1	18900	1880	23.11	0.04	0.063	0.036	1
20	LTE Band 2	16QAM(25-13)	10M	Left Side	1	18900	1880	21.12	-0.06	0.049	0.028	1
21	LTE Band 2	16QAM(1-0)	10M	Left Side	1	18900	1880	22.44	0.17	0.071	0.041	1
22	LTE Band 2	16QAM(1-49)	10M	Left Side	1	18900	1880	22.30	0.17	0.060	0.033	1
23	LTE Band 2	QPSK(25-13)	10M	Right Side	1	18900	1880	22.06	0.14	0.054	0.028	1
24	LTE Band 2	QPSK(1-0)	10M	Right Side	1	18900	1880	23.40	0.13	0.067	0.036	1
25	LTE Band 2	QPSK(1-49)	10M	Right Side	1	18900	1880	23.11	0.14	0.056	0.028	1
26	LTE Band 2	16QAM(25-13)	10M	Right Side	1	18900	1880	21.12	0.1	0.049	0.026	1
27	LTE Band 2	16QAM(1-0)	10M	Right Side	1	18900	1880	22.44	0.1	0.072	0.040	1
28	LTE Band 2	16QAM(1-49)	10M	Right Side	1	18900	1880	22.30	-0.15	0.058	0.029	1
29	LTE Band 2	QPSK(25-13)	10M	Top Side	1	18900	1880	22.06	0.15	0.425	0.216	1
30	LTE Band 2	QPSK(1-0)	10M	Top Side	1	18900	1880	23.40	0.11	0.508	0.259	1
31	LTE Band 2	QPSK(1-49)	10M	Top Side	1	18900	1880	23.11	0.17	0.429	0.217	1
32	LTE Band 2	16QAM(25-13)	10M	Top Side	1	18900	1880	21.12	0.09	0.341	0.173	1
33	LTE Band 2	16QAM(1-0)	10M	Top Side	1	18900	1880	22.44	-0.13	0.486	0.247	1
34	LTE Band 2	16QAM(1-49)	10M	Top Side	1	18900	1880	22.30	0.12	0.432	0.217	1

**Note:**

- Per KDB 941225 D06, for EUT dimension ≥ 9cm\*5cm, the test distance is 1cm. SAR must be measured for all surfaces and sides with a transmitting antenna located within 2.5cm from that surface or edge.
- As in (1), SAR for Front / Back / Top Side / Left Side / Right Side is necessary.
- Per KDB 941225 D05, for LTE, if the smaller bandwidth output power is within +/- ½ dB of the largest bandwidth, and the maximum SAR of the largest bandwidth is < 1.45 W/kg, SAR for smaller bandwidth can be excluded.
- Per KDB 941225 D05, if the measured 50%-RB 1g-SAR for the middle or highest output power channel is ≤ 0.8W/kg, remaining 2 channels SAR tests can be excluded. Otherwise, 50% RB allocation of the remaining 2 channels SAR tests are necessary.
- Per KDB 941225 D05, for LTE, if 50%-RB QPSK/16QAM SAR < 1.45 W/kg, 100%-RB SAR can be excluded.
- If SAR of 1 RB allocation is ≤ 1.45W/kg, SAR of 1 RB allocation of remaining channels can be excluded.
- Sample 2 body SAR verification was performed on the worst case of sample 1 body SAR among hotspot and body-worn.



<WLAN SAR>

Plot No.	Band	Mode	Test Position	Gap (cm)	Ch.	Freq. (MHz)	Average Power (dBm)	Power Drift (dB)	SAR <sub>1g</sub> (W/kg)	SAR <sub>10g</sub> (W/kg)	Sample
220	WLAN2.4G	802.11b	Front	1	6	2437	18.52	-0.066	0.143	0.073	1
<b>221</b>	<b>WLAN2.4G</b>	<b>802.11b</b>	<b>Back</b>	<b>1</b>	<b>6</b>	<b>2437</b>	<b>18.52</b>	<b>0.139</b>	<b>0.335</b>	<b>0.164</b>	<b>1</b>
223	WLAN2.4G	802.11b	Right Side	1	6	2437	18.52	-0.083	0.234	0.118	1
288	WLAN2.4G	802.11b	Back	1	6	2437	18.52	-0.072	0.251	0.118	2
252	WLAN5G	802.11a	Front	1	157	5785	12.44	0.106	0.00852	0.000966	1
253	WLAN5G	802.11a	Back	1	157	5785	12.44	0.177	0.090	0.020	1
255	WLAN5G	802.11a	Right Side	1	157	5785	12.44	0.127	0.054	0.014	1

Note:

1. Per KDB 941225 D06, for EUT dimension  $\geq 9\text{cm} \times 5\text{cm}$ , the test distance is 1cm. SAR must be measured for all surfaces and sides with a transmitting antenna located within 2.5cm from that surface or edge.
2. As in (1), SAR for Front / Back / Right Side is necessary.
3. Per KDB 648474 and KDB 248227, if the highest output channel SAR for each exposure position  $\leq 0.8 \text{ W/kg}$  other channels SAR tests are not necessary.
4. Sample 2 body SAR verification was performed on the worst case of sample 1 body SAR among hotspot and body-worn.

**11.3 Test Records for Body-worn SAR Test**

**<CDMA SAR>**

Plot No.	Band	Mode	Test Position	Gap (cm)	Ch.	Freq. (MHz)	Average Power (dBm)	Power Drift (dB)	SAR <sub>1g</sub> (W/kg)	SAR <sub>10g</sub> (W/kg)	Sample	Headset
63	CDMA2000 BC0	RC3+SO32	Front	1	384	836.52	24.57	0.112	0.228	0.175	1	v
64	<b>CDMA2000 BC0</b>	<b>RC3+SO32</b>	<b>Back</b>	<b>1</b>	<b>384</b>	<b>836.52</b>	<b>24.57</b>	<b>0.177</b>	<b>0.389</b>	<b>0.240</b>	<b>1</b>	<b>v</b>
301	CDMA2000 BC0	RETAP4096	Back	1	384	836.52	24.56	-0.07	0.54	0.409	1	v
74	CDMA2000 BC15	RC3+SO32	Front	1	25	1711.25	24.84	-0.192	0.432	0.266	1	v
75	<b>CDMA2000 BC15</b>	<b>RC3+SO32</b>	<b>Back</b>	<b>1</b>	<b>25</b>	<b>1711.25</b>	<b>24.84</b>	<b>-0.008</b>	<b>0.712</b>	<b>0.428</b>	<b>1</b>	<b>v</b>
282	CDMA2000 BC15	RC3+SO32	Back	1	25	1711.25	24.84	0.024	0.602	0.367	2	v
300	CDMA2000 BC15	RETAP4096	Back	1	25	1711.25	24.86	0.07	0.653	0.396	1	v
54	CDMA2000 BC1	RC3+SO32	Front	1	600	1880	24.67	-0.027	0.624	0.382	1	v
55	<b>CDMA2000 BC1</b>	<b>RC3+SO32</b>	<b>Back</b>	<b>1</b>	<b>600</b>	<b>1880</b>	<b>24.67</b>	<b>-0.129</b>	<b>0.957</b>	<b>0.534</b>	<b>1</b>	<b>v</b>
56	CDMA2000 BC1	RC3+SO32	Back	1	25	1851.25	24.63	0.002	0.811	0.473	1	v
57	CDMA2000 BC1	RC3+SO32	Back	1	1175	1908.75	24.05	0.145	0.916	0.523	1	v
297	CDMA2000 BC1	RETAP4096	Back	1	600	1908.75	24.76	-0.01	0.886	0.505	1	v
298	CDMA2000 BC1	RETAP4096	Back	1	25	1908.75	24.72	-0.07	0.839	0.499	1	v
299	CDMA2000 BC1	RETAP4096	Back	1	1175	1908.75	24.51	-0.02	0.954	0.558	1	v

**Note:**

- Per KDB 648474 and KDB 447498, if the highest output channel SAR for each exposure position ≤ 0.8 W/kg other channels SAR tests are not necessary.
- "V" in the Headset column means the Headset is plugged during SAR testing.
- Sample 2 body SAR verification was performed on the worst case of sample 1 body SAR among hotspot and body-worn.

**<LTE SAR>**

Plot No.	Band	Mode (RB Size-Offset)	BW (MHz)	Test Position	Gap (cm)	Ch.	Freq. (MHz)	Average Power (dBm)	Power Drift (dB)	SAR <sub>1g</sub> (W/kg)	SAR <sub>10g</sub> (W/kg)	Sample	Headset
160	LTE Band 12	QPSK(25-13)	10M	Front	1	23095	707.5	22.64	-0.046	0.094	0.067	1	-
161	LTE Band 12	QPSK(1-0)	10M	Front	1	23095	707.5	23.60	-0.012	0.105	0.079	1	-
162	LTE Band 12	QPSK(1-49)	10M	Front	1	23095	707.5	23.45	0.037	0.103	0.079	1	-
163	LTE Band 12	16QAM(25-13)	10M	Front	1	23095	707.5	21.72	0.082	0.092	0.070	1	-
164	LTE Band 12	16QAM(1-0)	10M	Front	1	23095	707.5	22.89	0.011	0.102	0.078	1	-
165	LTE Band 12	16QAM(1-49)	10M	Front	1	23095	707.5	22.63	0.085	0.102	0.079	1	-
166	<b>LTE Band 12</b>	<b>QPSK(25-13)</b>	<b>10M</b>	<b>Back</b>	<b>1</b>	<b>23095</b>	<b>707.5</b>	<b>22.64</b>	<b>-0.149</b>	<b>0.208</b>	<b>0.158</b>	<b>1</b>	<b>-</b>
167	LTE Band 12	QPSK(1-0)	10M	Back	1	23095	707.5	23.60	0.05	0.205	0.156	1	-
168	LTE Band 12	QPSK(1-49)	10M	Back	1	23095	707.5	23.45	0.006	0.197	0.150	1	-
169	LTE Band 12	16QAM(25-13)	10M	Back	1	23095	707.5	21.72	0.057	0.174	0.133	1	-
170	LTE Band 12	16QAM(1-0)	10M	Back	1	23095	707.5	22.89	-0.053	0.201	0.154	1	-
171	LTE Band 12	16QAM(1-49)	10M	Back	1	23095	707.5	22.63	0.087	0.179	0.137	1	-
214	LTE Band 12	QPSK(25-13)	10M	Back	1	23095	707.5	22.64	-0.089	0.180	0.106	1	v
215	LTE Band 12	QPSK(1-0)	10M	Back	1	23095	707.5	23.60	0.016	0.179	0.106	1	v
216	LTE Band 12	QPSK(1-49)	10M	Back	1	23095	707.5	23.45	-0.014	0.155	0.095	1	v
217	LTE Band 12	16QAM(25-13)	10M	Back	1	23095	707.5	21.72	0.122	0.144	0.108	1	v
218	LTE Band 12	16QAM(1-0)	10M	Back	1	23095	707.5	22.89	-0.018	0.168	0.127	1	v
219	LTE Band 12	16QAM(1-49)	10M	Back	1	23095	707.5	22.63	0.003	0.151	0.114	1	v
285	LTE Band 12	QPSK(25-13)	10M	Back	1	23095	707.5	22.64	-0.169	0.184	0.138	2	-



Plot No.	Band	Mode (RB Size-Offset)	BW (MHz)	Test Position	Gap (cm)	Ch.	Freq. (MHz)	Average Power (dBm)	Power Drift (dB)	SAR <sub>1g</sub> (W/kg)	SAR <sub>10g</sub> (W/kg)	Sample	Headset
76	LTE Band 4	QPSK(25-13)	10M	Front	1	20175	1732.5	22.27	0.12	0.202	0.115	1	-
77	LTE Band 4	QPSK(1-0)	10M	Front	1	20175	1732.5	23.41	-0.01	0.204	0.114	1	-
78	LTE Band 4	QPSK(1-49)	10M	Front	1	20175	1732.5	23.38	0.15	0.200	0.118	1	-
79	LTE Band 4	16QAM(25-13)	10M	Front	1	20175	1732.5	21.43	0.01	0.149	0.084	1	-
80	LTE Band 4	16QAM(1-0)	10M	Front	1	20175	1732.5	22.40	0.12	0.198	0.110	1	-
81	LTE Band 4	16QAM(1-49)	10M	Front	1	20175	1732.5	22.02	-0.01	0.199	0.112	1	-
82	LTE Band 4	QPSK(25-13)	10M	Back	1	20175	1732.5	22.27	0.12	0.466	0.270	1	-
83	LTE Band 4	QPSK(1-0)	10M	Back	1	20175	1732.5	23.41	-0.09	0.492	0.286	1	-
84	LTE Band 4	QPSK(1-49)	10M	Back	1	20175	1732.5	23.38	-0.1	0.483	0.279	1	-
85	LTE Band 4	16QAM(25-13)	10M	Back	1	20175	1732.5	21.43	-0.12	0.360	0.206	1	-
86	LTE Band 4	16QAM(1-0)	10M	Back	1	20175	1732.5	22.40	-0.05	0.462	0.268	1	-
87	LTE Band 4	16QAM(1-49)	10M	Back	1	20175	1732.5	22.02	0.16	0.469	0.273	1	-
106	LTE Band 4	QPSK(25-13)	10M	Back	1	20175	1732.5	22.27	0.077	0.537	0.317	1	v
107	LTE Band 4	QPSK(1-0)	10M	Back	1	20175	1732.5	23.41	-0.02	0.576	0.341	1	v
<b>108</b>	<b>LTE Band 4</b>	<b>QPSK(1-49)</b>	<b>10M</b>	<b>Back</b>	<b>1</b>	<b>20175</b>	<b>1732.5</b>	<b>23.38</b>	<b>0.171</b>	<b>0.636</b>	<b>0.378</b>	<b>1</b>	<b>v</b>
109	LTE Band 4	16QAM(25-13)	10M	Back	1	20175	1732.5	21.43	-0.048	0.471	0.281	1	v
110	LTE Band 4	16QAM(1-0)	10M	Back	1	20175	1732.5	22.40	0.012	0.609	0.362	1	v
111	LTE Band 4	16QAM(1-49)	10M	Back	1	20175	1732.5	22.02	0.148	0.621	0.368	1	v
284	LTE Band 4	QPSK(1-49)	10M	Back	1	20175	1732.5	23.38	0.104	0.572	0.337	2	v
5	LTE Band 2	QPSK(25-13)	10M	Front	1	18900	1880	22.06	0.14	0.148	0.079	1	-
6	LTE Band 2	QPSK(1-0)	10M	Front	1	18900	1880	23.40	0.17	0.187	0.101	1	-
7	LTE Band 2	QPSK(1-49)	10M	Front	1	18900	1880	23.11	0.11	0.156	0.088	1	-
8	LTE Band 2	16QAM(25-13)	10M	Front	1	18900	1880	21.12	0.12	0.145	0.083	1	-
9	LTE Band 2	16QAM(1-0)	10M	Front	1	18900	1880	22.44	0.04	0.241	0.129	1	-
10	LTE Band 2	16QAM(1-49)	10M	Front	1	18900	1880	22.30	-0.14	0.164	0.095	1	-
11	LTE Band 2	QPSK(25-13)	10M	Back	1	18900	1880	22.06	0.11	0.501	0.279	1	-
12	LTE Band 2	QPSK(1-0)	10M	Back	1	18900	1880	23.40	-0.06	0.593	0.328	1	-
13	LTE Band 2	QPSK(1-49)	10M	Back	1	18900	1880	23.11	0.1	0.487	0.269	1	-
14	LTE Band 2	16QAM(25-13)	10M	Back	1	18900	1880	21.12	0.05	0.409	0.226	1	-
15	LTE Band 2	16QAM(1-0)	10M	Back	1	18900	1880	22.44	-0.04	0.598	0.331	1	-
16	LTE Band 2	16QAM(1-49)	10M	Back	1	18900	1880	22.30	-0.14	0.490	0.272	1	-
35	LTE Band 2	QPSK(25-13)	10M	Back	1	18900	1880	22.06	0.156	0.678	0.376	1	v
36	LTE Band 2	QPSK(1-0)	10M	Back	1	18900	1880	23.40	-0.127	0.760	0.420	1	v
37	LTE Band 2	QPSK(1-49)	10M	Back	1	18900	1880	23.11	0.056	0.724	0.397	1	v
38	LTE Band 2	16QAM(25-13)	10M	Back	1	18900	1880	21.12	0.151	0.587	0.318	1	v
<b>39</b>	<b>LTE Band 2</b>	<b>16QAM(1-0)</b>	<b>10M</b>	<b>Back</b>	<b>1</b>	<b>18900</b>	<b>1880</b>	<b>22.44</b>	<b>-0.132</b>	<b>0.766</b>	<b>0.423</b>	<b>1</b>	<b>v</b>
40	LTE Band 2	16QAM(1-49)	10M	Back	1	18900	1880	22.30	0.094	0.726	0.39	1	v
283	LTE Band 2	16QAM(1-0)	10M	Back	1	18900	1880	22.44	0.042	0.514	0.277	2	v



**Note:**

1. Per KDB 941225 D05, for LTE, if the smaller bandwidth output power is within +/- ½ dB of the largest bandwidth, and the maximum SAR of the largest bandwidth is ≤ 1.45 W/kg, SAR for smaller bandwidth can be excluded.
2. Per KDB 941225 D05, if the measured 50%-RB 1g-SAR for the middle or highest output power channel is ≤ 0.8 W/kg, remaining 2 channels SAR tests can be excluded. Otherwise, 50% RB allocation of the remaining 2 channels SAR tests are necessary.
3. Per KDB 941225 D05, for LTE, if 50%-RB QPSK SAR ≤ 1.45 W/kg, 100%-RB QPSK SAR can be excluded; if 50%-RB 16QAM SAR ≤ 1.45 W/kg, 100%-RB 16QAM SAR can be excluded.
4. If SAR of 1 RB allocation is ≤ 1.45 W/kg, SAR of 1 RB allocation of remaining channels can be excluded.
5. "V" in the Headset column means the Headset is plugged during SAR testing.
6. Sample 2 body SAR verification was performed on the worst case of sample 1 body SAR among hotspot and body-worn.

**<WLAN SAR>**

Plot No.	Band	Mode	Test Position	Gap (cm)	Ch.	Freq. (MHz)	Average Power (dBm)	Power Drift (dB)	SAR <sub>1g</sub> (W/kg)	SAR <sub>10g</sub> (W/kg)	Sample	Headset
220	WLAN2.4G	802.11b	Front	1	6	2437	18.52	-0.066	0.143	0.073	1	-
<b>221</b>	<b>WLAN2.4G</b>	<b>802.11b</b>	<b>Back</b>	<b>1</b>	<b>6</b>	<b>2437</b>	<b>18.52</b>	<b>0.139</b>	<b>0.335</b>	<b>0.164</b>	<b>1</b>	-
226	WLAN2.4G	802.11b	Back	1	6	2437	18.52	0.069	0.260	0.127	1	v
288	WLAN2.4G	802.11b	Back	1	6	2437	18.52	-0.072	0.251	0.118	2	-
231	WLAN5G	802.11a	Front	1	44	5220	12.51	0.15	0.015	0.00416	1	-
232	WLAN5G	802.11a	Back	1	44	5220	12.51	0.146	0.102	0.029	1	-
237	WLAN5G	802.11a	Back	1	44	5220	12.51	0.149	0.110	0.031	1	v
293	WLAN5G	802.11a	Back	1	44	5220	12.51	-0.154	0.040	0.014	2	v
238	WLAN5G	802.11a	Front	1	52	5260	12.60	0.122	0.015	0.00348	1	-
239	WLAN5G	802.11a	Back	1	52	5260	12.60	0.189	0.106	0.030	1	-
<b>244</b>	<b>WLAN5G</b>	<b>802.11a</b>	<b>Back</b>	<b>1</b>	<b>52</b>	<b>5260</b>	<b>12.60</b>	<b>0.12</b>	<b>0.111</b>	<b>0.031</b>	<b>1</b>	<b>v</b>
294	WLAN5G	802.11a	Back	1	52	5260	12.60	0.122	0.051	0.016	2	v
245	WLAN5G	802.11a	Front	1	140	5700	12.62	0.123	0.00557	0.00067	1	-
246	WLAN5G	802.11a	Back	1	140	5700	12.62	0.169	0.064	0.016	1	-
251	WLAN5G	802.11a	Back	1	140	5700	12.62	0.111	0.063	0.017	1	v
295	WLAN5G	802.11a	Back	1	140	5700	12.62	-0.141	0.044	0.015	2	-
252	WLAN5G	802.11a	Front	1	157	5785	12.44	0.106	0.00852	0.000966	1	-
253	WLAN5G	802.11a	Back	1	157	5785	12.44	0.177	0.090	0.020	1	-
258	WLAN5G	802.11a	Back	1	157	5785	12.44	0.164	0.091	0.020	1	v
296	WLAN5G	802.11a	Back	1	157	5785	12.44	-0.187	0.049	0.017	2	v

**Note:**

1. Per KDB 648474 and KDB 248227, if the highest output channel SAR for each exposure position ≤ 0.8 W/kg other channels SAR tests are not necessary.
2. "V" in the Headset column means the Headset is plugged during SAR testing.
3. Sample 2 body SAR verification was performed on the worst case of sample 1 body SAR among hotspot and body-worn.



**11.4 Simultaneous Multi-band Transmission Analysis**

	Position	Applicable Combination
<b>Simultaneous Transmission</b>	<b>Head</b>	1x CDMA (voice) + LTE (data) + WLAN (router)
		1x CDMA (voice) + WLAN
		1x CDMA (voice) + LTE (data) + BT
		1x CDMA (voice) + BT
	<b>Hotspot</b>	1x EVDO (data) + WLAN (router)
		LTE (data) + WLAN (router)
	<b>Body-worn</b>	1x CDMA (voice) + LTE (data) + WLAN (router)
		1x CDMA (voice) + WLAN
		1x CDMA (voice) + LTE (data) + BT
		1x CDMA (voice) + BT

**Note:**

1. WLAN and BT share the same antenna, and cannot transmit simultaneously.
2. EUT will choose either WLAN2.4G or WLAN5G according to the network signal condition; therefore, they will not transmit simultaneously.
3. The maximum SAR summation is calculated based on the same configuration and test position.
4. When stand-alone 1-g SAR is not required for a transmitter or antenna, its SAR is considered zero in the 1-g SAR summing process to determine simultaneous transmission SAR evaluation requirements
5. If 1g-SAR scalar summation < 1.6W/kg, simultaneous SAR measurement is not necessary.
6. If 1g-SAR summation ≥ 1.6W/kg, SPLSR calculation is necessary.
7. In simultaneous transmission analysis, the measured SAR is scaled up to account for tune-up tolerance and to show compliance.
8. WLAN 5G supports Hotspot mode in 5745 MHz ~ 5825 MHz only.



<Head SAR>

Position	WWAN		Scaled WWAN				LTE		Scaled LTE				WLAN2.4G		Scaled WLAN2.4G				WWAN + Scaled WLAN	Scaled WWAN + Scaled WLAN	Case No		
	WWAN Band	Plot No	Max. SAR (W/kg)	Average Power (dBm)	Tune-up Limit (dBm)	Scaling Factor	Scaled WWAN (W/kg)	LTE Band	Plot No	Max. SAR (W/kg)	Average Power (dBm)	Tune-up Limit (dBm)	Scaling Factor	Scaled WWAN (W/kg)	Plot No	Max. SAR (W/kg)	Average Power (dBm)	Tune-up Limit (dBm)	Scaling Factor	Scaled WLAN (W/kg)			
Right Cheek	CDMA BC0	1	0.312	24.51	25	1.119	0.349	LTE Band 2	113	0.489	23.40	24	1.148	0.561	227	0.532	18.52	18.6	1.019	0.542	1.33	1.45	
	CDMA BC1	65	0.422	24.70	25	1.072	0.452	LTE Band 2	113	0.489	23.40	24	1.148	0.561	227	0.532	18.52	18.6	1.019	0.542	1.44	1.56	
	CDMA BC15	41	0.307	24.80	25	1.047	0.321	LTE Band 2	113	0.489	23.40	24	1.148	0.561	227	0.532	18.52	18.6	1.019	0.542	1.33	1.42	
	CDMA BC0	1	0.312	24.51	25	1.119	0.349	LTE Band 4	192	0.428	23.38	24	1.153	0.494	227	0.532	18.52	18.6	1.019	0.542	1.27	1.39	
	CDMA BC1	65	0.422	24.70	25	1.072	0.452	LTE Band 4	192	0.428	23.38	24	1.153	0.494	227	0.532	18.52	18.6	1.019	0.542	1.38	1.49	
	CDMA BC15	41	0.307	24.80	25	1.047	0.321	LTE Band 4	192	0.428	23.38	24	1.153	0.494	227	0.532	18.52	18.6	1.019	0.542	1.27	1.36	
	CDMA BC0	1	0.312	24.51	25	1.119	0.349	LTE Band 12	137	0.151	23.60	24	1.096	0.166	227	0.532	18.52	18.6	1.019	0.542	1.00	1.06	
	CDMA BC1	65	0.422	24.70	25	1.072	0.452	LTE Band 12	137	0.151	23.60	24	1.096	0.166	227	0.532	18.52	18.6	1.019	0.542	1.11	1.16	
CDMA BC15	41	0.307	24.80	25	1.047	0.321	LTE Band 12	137	0.151	23.60	24	1.096	0.166	227	0.532	18.52	18.6	1.019	0.542	0.99	1.03		
Right Tilted	CDMA BC0	2	0.21	24.51	25	1.119	0.235	LTE Band 2	122	0.654	22.44	23	1.138	0.744	228	0.171	18.52	18.6	1.019	0.174	1.04	1.15	
	CDMA BC1	66	0.223	24.7	25	1.072	0.239	LTE Band 2	122	0.654	22.44	23	1.138	0.744	228	0.171	18.52	18.6	1.019	0.174	1.05	1.16	
	CDMA BC15	42	0.169	24.8	25	1.047	0.177	LTE Band 2	122	0.654	22.44	23	1.138	0.744	228	0.171	18.52	18.6	1.019	0.174	0.99	1.10	
	CDMA BC0	2	0.21	24.51	25	1.119	0.235	LTE Band 4	197	0.739	23.41	24	1.146	0.847	228	0.171	18.52	18.6	1.019	0.174	1.12	1.26	
	CDMA BC1	66	0.223	24.7	25	1.072	0.239	LTE Band 4	197	0.739	23.41	24	1.146	0.847	228	0.171	18.52	18.6	1.019	0.174	1.13	1.26	
	CDMA BC15	42	0.169	24.8	25	1.047	0.177	LTE Band 4	197	0.739	23.41	24	1.146	0.847	228	0.171	18.52	18.6	1.019	0.174	1.08	1.20	
	CDMA BC0	2	0.21	24.51	25	1.119	0.235	LTE Band 12	143	0.144	23.60	24	1.096	0.158	228	0.171	18.52	18.6	1.019	0.174	0.53	0.57	
	CDMA BC1	66	0.223	24.7	25	1.072	0.239	LTE Band 12	143	0.144	23.60	24	1.096	0.158	228	0.171	18.52	18.6	1.019	0.174	0.54	0.57	
CDMA BC15	42	0.169	24.8	25	1.047	0.177	LTE Band 12	143	0.144	23.60	24	1.096	0.158	228	0.171	18.52	18.6	1.019	0.174	0.48	0.51		
Left Cheek	CDMA BC0	3	0.282	24.51	25	1.119	0.316	LTE Band 2	125	0.756	23.40	24	1.148	0.868	229	0.447	18.52	18.6	1.019	0.455	1.49	1.64	S01
	CDMA BC1	67	0.595	24.7	25	1.072	0.638	LTE Band 2	125	0.756	23.40	24	1.148	0.868	229	0.447	18.52	18.6	1.019	0.455	1.80	1.96	S02
	CDMA BC15	43	0.306	24.8	25	1.047	0.320	LTE Band 2	125	0.756	23.40	24	1.148	0.868	229	0.447	18.52	18.6	1.019	0.455	1.51	1.64	S03
	CDMA BC0	3	0.282	24.51	25	1.119	0.316	LTE Band 4	204	0.604	23.38	24	1.153	0.697	229	0.447	18.52	18.6	1.019	0.455	1.33	1.47	
	CDMA BC1	67	0.595	24.7	25	1.072	0.638	LTE Band 4	204	0.604	23.38	24	1.153	0.697	229	0.447	18.52	18.6	1.019	0.455	1.65	1.79	S04
	CDMA BC15	43	0.306	24.8	25	1.047	0.320	LTE Band 4	204	0.604	23.38	24	1.153	0.697	229	0.447	18.52	18.6	1.019	0.455	1.36	1.47	
	CDMA BC0	3	0.282	24.51	25	1.119	0.316	LTE Band 12	149	0.24	23.60	24	1.096	0.263	229	0.447	18.52	18.6	1.019	0.455	0.97	1.03	
	CDMA BC1	67	0.595	24.7	25	1.072	0.638	LTE Band 12	149	0.24	23.60	24	1.096	0.263	229	0.447	18.52	18.6	1.019	0.455	1.28	1.36	
CDMA BC15	43	0.306	24.8	25	1.047	0.320	LTE Band 12	149	0.24	23.60	24	1.096	0.263	229	0.447	18.52	18.6	1.019	0.455	0.99	1.04		
Left Tilted	CDMA BC0	4	0.206	24.51	25	1.119	0.231	LTE Band 2	134	0.808	22.44	23	1.138	0.919	230	0.151	18.52	18.6	1.019	0.154	1.17	1.30	
	CDMA BC1	68	0.247	24.7	25	1.072	0.265	LTE Band 2	134	0.808	22.44	23	1.138	0.919	230	0.151	18.52	18.6	1.019	0.154	1.21	1.34	
	CDMA BC15	44	0.184	24.8	25	1.047	0.193	LTE Band 2	134	0.808	22.44	23	1.138	0.919	230	0.151	18.52	18.6	1.019	0.154	1.14	1.27	
	CDMA BC0	4	0.206	24.51	25	1.119	0.231	LTE Band 4	213	0.665	22.02	23	1.253	0.833	230	0.151	18.52	18.6	1.019	0.154	1.02	1.22	
	CDMA BC1	68	0.247	24.7	25	1.072	0.265	LTE Band 4	213	0.665	22.02	23	1.253	0.833	230	0.151	18.52	18.6	1.019	0.154	1.06	1.25	
	CDMA BC15	44	0.184	24.8	25	1.047	0.193	LTE Band 4	213	0.665	22.02	23	1.253	0.833	230	0.151	18.52	18.6	1.019	0.154	1.00	1.18	
	CDMA BC0	4	0.206	24.51	25	1.119	0.231	LTE Band 12	155	0.24	23.60	24	1.096	0.263	230	0.151	18.52	18.6	1.019	0.154	0.60	0.65	
	CDMA BC1	68	0.247	24.7	25	1.072	0.265	LTE Band 12	155	0.24	23.60	24	1.096	0.263	230	0.151	18.52	18.6	1.019	0.154	0.64	0.68	
CDMA BC15	44	0.184	24.8	25	1.047	0.193	LTE Band 12	155	0.24	23.60	24	1.096	0.263	230	0.151	18.52	18.6	1.019	0.154	0.58	0.61		



Position	WWAN		Scaled WWAN				LTE		Scaled LTE				WLAN5G		Scaled WLAN5G				WLAN + Scaled WLAN	Scaled WWAN + Scaled WLAN	Case No		
	WWAN Band	Plot No	Max. SAR (W/kg)	Average Power (dBm)	Tune-up Limit (dBm)	Scaling Factor	Scaled WWAN (W/kg)	LTE Band	Plot No	Max. SAR (W/kg)	Average Power (dBm)	Tune-up Limit (dBm)	Scaling Factor	Scaled WWAN (W/kg)	Plot No	Max. SAR (W/kg)	Average Power (dBm)	Tune-up Limit (dBm)				Scaling Factor	Scaled WLAN (W/kg)
Right Cheek	CDMA BC0	1	0.312	24.51	25	1.119	0.349	LTE Band 2	113	0.489	23.40	23	0.912	0.446	259	0.042	12.51	12.7	1.045	0.044	0.84	0.84	
	CDMA BC1	65	0.422	24.70	25	1.072	0.452	LTE Band 2	113	0.489	23.40	23	0.912	0.446	259	0.042	12.51	12.7	1.045	0.044	0.95	0.94	
	CDMA BC15	41	0.307	24.80	25	1.047	0.321	LTE Band 2	113	0.489	23.40	23	0.912	0.446	259	0.042	12.51	12.7	1.045	0.044	0.84	0.81	
	CDMA BC0	1	0.312	24.51	25	1.119	0.349	LTE Band 4	192	0.428	23.38	24	1.099	0.470	259	0.042	12.51	12.7	1.045	0.044	0.78	0.86	
	CDMA BC1	65	0.422	24.70	25	1.072	0.452	LTE Band 4	192	0.428	23.38	24	1.099	0.470	259	0.042	12.51	12.7	1.045	0.044	0.89	0.97	
	CDMA BC15	41	0.307	24.80	25	1.047	0.321	LTE Band 4	192	0.428	23.38	24	1.099	0.470	259	0.042	12.51	12.7	1.045	0.044	0.78	0.84	
	CDMA BC0	1	0.312	24.51	25	1.119	0.349	LTE Band 12	137	0.151	23.60	24	1.148	0.173	259	0.042	12.51	12.7	1.045	0.044	0.51	0.57	
	CDMA BC1	65	0.422	24.70	25	1.072	0.452	LTE Band 12	137	0.151	23.60	24	1.148	0.173	259	0.042	12.51	12.7	1.045	0.044	0.62	0.67	
CDMA BC15	41	0.307	24.80	25	1.047	0.321	LTE Band 12	137	0.151	23.60	24	1.148	0.173	259	0.042	12.51	12.7	1.045	0.044	0.50	0.54		
Right Tilted	CDMA BC0	2	0.21	24.51	25	1.119	0.235	LTE Band 2	122	0.654	22.44	23	1.138	0.744	260	0.029	12.51	12.7	1.045	0.030	0.89	1.01	
	CDMA BC1	66	0.223	24.7	25	1.072	0.239	LTE Band 2	122	0.654	22.44	23	1.138	0.744	260	0.029	12.51	12.7	1.045	0.030	0.91	1.01	
	CDMA BC15	42	0.169	24.8	25	1.047	0.177	LTE Band 2	122	0.654	22.44	23	1.138	0.744	260	0.029	12.51	12.7	1.045	0.030	0.85	0.95	
	CDMA BC0	2	0.21	24.51	25	1.119	0.235	LTE Band 4	197	0.739	23.41	24	1.146	0.847	260	0.029	12.51	12.7	1.045	0.030	0.98	1.11	
	CDMA BC1	66	0.223	24.7	25	1.072	0.239	LTE Band 4	197	0.739	23.41	24	1.146	0.847	260	0.029	12.51	12.7	1.045	0.030	0.99	1.12	
	CDMA BC15	42	0.169	24.8	25	1.047	0.177	LTE Band 4	197	0.739	23.41	24	1.146	0.847	260	0.029	12.51	12.7	1.045	0.030	0.94	1.05	
	CDMA BC0	2	0.21	24.51	25	1.119	0.235	LTE Band 12	143	0.144	23.60	24	1.148	0.165	260	0.029	12.51	12.7	1.045	0.030	0.38	0.43	
	CDMA BC1	66	0.223	24.7	25	1.072	0.239	LTE Band 12	143	0.144	23.60	24	1.148	0.165	260	0.029	12.51	12.7	1.045	0.030	0.40	0.43	
CDMA BC15	42	0.169	24.8	25	1.047	0.177	LTE Band 12	143	0.144	23.60	24	1.148	0.165	260	0.029	12.51	12.7	1.045	0.030	0.34	0.37		
Left Cheek	CDMA BC0	3	0.282	24.51	25	1.119	0.316	LTE Band 2	125	0.756	23.40	24	1.148	0.868	261	0.047	12.51	12.7	1.045	0.049	1.09	1.23	
	CDMA BC1	67	0.595	24.7	25	1.072	0.638	LTE Band 2	125	0.756	23.40	24	1.148	0.868	261	0.047	12.51	12.7	1.045	0.049	1.40	1.56	
	CDMA BC15	43	0.306	24.8	25	1.047	0.320	LTE Band 2	125	0.756	23.40	24	1.148	0.868	261	0.047	12.51	12.7	1.045	0.049	1.11	1.24	
	CDMA BC0	3	0.282	24.51	25	1.119	0.316	LTE Band 4	204	0.604	23.38	24	1.099	0.664	261	0.047	12.51	12.7	1.045	0.049	0.93	1.03	
	CDMA BC1	67	0.595	24.7	25	1.072	0.638	LTE Band 4	204	0.604	23.38	24	1.099	0.664	261	0.047	12.51	12.7	1.045	0.049	1.25	1.35	
	CDMA BC15	43	0.306	24.8	25	1.047	0.320	LTE Band 4	204	0.604	23.38	24	1.099	0.664	261	0.047	12.51	12.7	1.045	0.049	0.96	1.03	
	CDMA BC0	3	0.282	24.51	25	1.119	0.316	LTE Band 12	149	0.24	23.60	24	1.148	0.276	261	0.047	12.51	12.7	1.045	0.049	0.57	0.64	
	CDMA BC1	67	0.595	24.7	25	1.072	0.638	LTE Band 12	149	0.24	23.60	24	1.148	0.276	261	0.047	12.51	12.7	1.045	0.049	0.88	0.96	
CDMA BC15	43	0.306	24.8	25	1.047	0.320	LTE Band 12	149	0.24	23.60	24	1.148	0.276	261	0.047	12.51	12.7	1.045	0.049	0.59	0.65		
Left Tilted	CDMA BC0	4	0.206	24.51	25	1.119	0.231	LTE Band 2	134	0.808	22.44	23	1.138	0.919	266	0.031	12.60	12.7	1.023	0.032	1.05	1.18	
	CDMA BC1	68	0.247	24.7	25	1.072	0.265	LTE Band 2	134	0.808	22.44	23	1.138	0.919	266	0.031	12.60	12.7	1.023	0.032	1.09	1.22	
	CDMA BC15	44	0.184	24.8	25	1.047	0.193	LTE Band 2	134	0.808	22.44	23	1.138	0.919	266	0.031	12.60	12.7	1.023	0.032	1.02	1.14	
	CDMA BC0	4	0.206	24.51	25	1.119	0.231	LTE Band 4	213	0.665	22.02	23	1.109	0.738	266	0.031	12.60	12.7	1.023	0.032	0.90	1.00	
	CDMA BC1	68	0.247	24.7	25	1.072	0.265	LTE Band 4	213	0.665	22.02	23	1.109	0.738	266	0.031	12.60	12.7	1.023	0.032	0.94	1.04	
	CDMA BC15	44	0.184	24.8	25	1.047	0.193	LTE Band 4	213	0.665	22.02	23	1.109	0.738	266	0.031	12.60	12.7	1.023	0.032	0.88	0.96	
	CDMA BC0	4	0.206	24.51	25	1.119	0.231	LTE Band 12	155	0.24	23.60	24	1.148	0.276	266	0.031	12.60	12.7	1.023	0.032	0.48	0.54	
	CDMA BC1	68	0.247	24.7	25	1.072	0.265	LTE Band 12	155	0.24	23.60	24	1.148	0.276	266	0.031	12.60	12.7	1.023	0.032	0.52	0.57	
CDMA BC15	44	0.184	24.8	25	1.047	0.193	LTE Band 12	155	0.24	23.60	24	1.148	0.276	266	0.031	12.60	12.7	1.023	0.032	0.46	0.50		



<Hotspot SAR>

Position	WWAN			Scaled WWAN				WLAN2.4G		Scaled WLAN2.4G				WWAN + WLAN	Scaled WWAN + Scaled WLAN	Case No
	WWAN Band	Plot No	Max. SAR (W/kg)	Average Power (dBm)	Tune-up Limit (dBm)	Scaling Factor	Scaled WWAN (W/kg)	Plot No	Max. SAR (W/kg)	Average Power (dBm)	Tune-up Limit (dBm)	Scaling Factor	Scaled WLAN (W/kg)			
Front	CDMA BC0	58	0.371	24.66	25	1.081	0.401	220	0.143	18.52	18.6	1.019	0.146	0.51	0.55	
	CDMA BC1	47	0.681	24.82	25	1.042	0.710	220	0.143	18.52	18.6	1.019	0.146	0.82	0.86	
	CDMA BC15	69	0.413	24.88	25	1.028	0.425	220	0.143	18.52	18.6	1.019	0.146	0.56	0.57	
	LTE Band 2	9	0.241	23.55	24	1.109	0.267	220	0.143	18.52	18.6	1.019	0.146	0.38	0.41	
	LTE Band 4	81	0.199	23.55	24	1.109	0.221	220	0.143	18.52	18.6	1.019	0.146	0.34	0.37	
	LTE Band 12	161	0.105	23.40	24	1.148	0.121	220	0.143	18.52	18.6	1.019	0.146	0.25	0.27	
Back	CDMA BC0	59	0.558	24.66	25	1.081	0.603	221	0.335	18.52	18.6	1.019	0.341	0.89	0.94	
	CDMA BC1	50	0.993	24.54	25	1.112	1.104	221	0.335	18.52	18.6	1.019	0.341	1.33	1.45	
	CDMA BC15	70	0.704	24.88	25	1.028	0.724	221	0.335	18.52	18.6	1.019	0.341	1.04	1.07	
	LTE Band 2	15	0.598	23.55	24	1.109	0.663	221	0.335	18.52	18.6	1.019	0.341	0.93	1.00	
	LTE Band 4	84	0.483	23.59	24	1.099	0.531	221	0.335	18.52	18.6	1.019	0.341	0.82	0.87	
	LTE Band 12	167	0.205	23.40	24	1.148	0.235	221	0.335	18.52	18.6	1.019	0.341	0.54	0.58	
Left Side	CDMA BC0	60	0.342	24.66	25	1.081	0.370	-	-	-	-	-	-	0.34	0.37	
	CDMA BC1	51	0.32	24.82	25	1.042	0.334	-	-	-	-	-	-	0.32	0.33	
	CDMA BC15	71	0.156	24.88	25	1.028	0.160	-	-	-	-	-	-	0.16	0.16	
	LTE Band 2	18	0.073	23.54	24	1.112	0.081	-	-	-	-	-	-	0.07	0.08	
	LTE Band 4	92	0.05	23.85	24	1.035	0.052	-	-	-	-	-	-	0.05	0.05	
	LTE Band 12	173	0.058	23.40	24	1.148	0.067	-	-	-	-	-	-	0.06	0.07	
Right Side	CDMA BC0	61	0.433	24.66	25	1.081	0.468	223	0.234	18.52	18.6	1.019	0.238	0.67	0.71	
	CDMA BC1	52	0.165	24.82	25	1.042	0.172	223	0.234	18.52	18.6	1.019	0.238	0.40	0.41	
	CDMA BC15	72	0.059	24.88	25	1.028	0.061	223	0.234	18.52	18.6	1.019	0.238	0.29	0.30	
	LTE Band 2	27	0.072	23.55	24	1.109	0.080	223	0.234	18.52	18.6	1.019	0.238	0.31	0.32	
	LTE Band 4	99	0.068	23.55	24	1.109	0.075	223	0.234	18.52	18.6	1.019	0.238	0.30	0.31	
	LTE Band 12	183	0.117	23.29	24	1.178	0.138	223	0.234	18.52	18.6	1.019	0.238	0.35	0.38	
Top Side	LTE Band 2	30	0.508	23.54	24	1.112	0.565	-	-	-	-	-	-	0.51	0.57	
	LTE Band 4	102	0.353	23.59	24	1.099	0.388	-	-	-	-	-	-	0.35	0.39	
	LTE Band 12	184	0.077	23.50	24	1.122	0.086	-	-	-	-	-	-	0.08	0.09	
Bottom Side	CDMA BC0	62	0.098	24.66	25	1.081	0.106	-	-	-	-	-	-	0.10	0.11	
	CDMA BC1	53	0.483	24.82	25	1.042	0.503	-	-	-	-	-	-	0.48	0.50	
	CDMA BC15	73	0.288	24.88	25	1.028	0.296	-	-	-	-	-	-	0.29	0.30	



Position	WWAN			Scaled WWAN				WLAN5G		Scaled WLAN5G				WWAN + WLAN	Scaled WWAN + Scaled WLAN	Case No
	WWAN Band	Plot No	Max. SAR (W/kg)	Average Power (dBm)	Tune-up Limit (dBm)	Scaling Factor	Scaled WWAN (W/kg)	Plot No	Max. SAR (W/kg)	Average Power (dBm)	Tune-up Limit (dBm)	Scaling Factor	Scaled WLAN (W/kg)			
Front	CDMA BC0	58	0.371	24.66	25	1.081	0.401	252	0.00852	12.51	12.7	1.045	0.009	0.38	0.41	
	CDMA BC1	47	0.681	24.82	25	1.042	0.710	252	0.00852	12.51	12.7	1.045	0.009	0.69	0.72	
	CDMA BC15	69	0.413	24.88	25	1.028	0.425	252	0.00852	12.51	12.7	1.045	0.009	0.42	0.43	
	LTE Band 2	9	0.241	23.55	24	1.109	0.267	252	0.00852	12.51	12.7	1.045	0.009	0.25	0.28	
	LTE Band 4	81	0.199	23.55	24	1.109	0.221	252	0.00852	12.51	12.7	1.045	0.009	0.21	0.23	
	LTE Band 12	161	0.105	23.40	24	1.148	0.121	252	0.00852	12.51	12.7	1.045	0.009	0.11	0.13	
Back	CDMA BC0	59	0.558	24.66	25	1.081	0.603	253	0.09	12.60	12.7	1.023	0.092	0.65	0.70	
	CDMA BC1	50	0.993	24.54	25	1.112	1.104	253	0.09	12.60	12.7	1.023	0.092	1.08	1.20	
	CDMA BC15	70	0.704	24.88	25	1.028	0.724	253	0.09	12.60	12.7	1.023	0.092	0.79	0.82	
	LTE Band 2	15	0.598	23.55	24	1.109	0.663	253	0.09	12.60	12.7	1.023	0.092	0.69	0.76	
	LTE Band 4	84	0.483	23.59	24	1.099	0.531	253	0.09	12.60	12.7	1.023	0.092	0.57	0.62	
	LTE Band 12	167	0.205	23.40	24	1.148	0.235	253	0.09	12.60	12.7	1.023	0.092	0.30	0.33	
Left Side	CDMA BC0	60	0.342	24.66	25	1.081	0.370	-	-	-	-	-	-	0.34	0.37	
	CDMA BC1	51	0.32	24.82	25	1.042	0.334	-	-	-	-	-	-	0.32	0.33	
	CDMA BC15	71	0.156	24.88	25	1.028	0.160	-	-	-	-	-	-	0.16	0.16	
	LTE Band 2	18	0.073	23.54	24	1.112	0.081	-	-	-	-	-	-	0.07	0.08	
	LTE Band 4	92	0.05	23.85	24	1.035	0.052	-	-	-	-	-	-	0.05	0.05	
	LTE Band 12	173	0.058	23.40	24	1.148	0.067	-	-	-	-	-	-	0.06	0.07	
Right Side	CDMA BC0	61	0.433	24.66	25	1.081	0.468	255	0.054	12.51	12.7	1.045	0.056	0.49	0.52	
	CDMA BC1	52	0.165	24.82	25	1.042	0.172	255	0.054	12.51	12.7	1.045	0.056	0.22	0.23	
	CDMA BC15	72	0.059	24.88	25	1.028	0.061	255	0.054	12.51	12.7	1.045	0.056	0.11	0.12	
	LTE Band 2	27	0.072	23.55	24	1.109	0.080	255	0.054	12.51	12.7	1.045	0.056	0.13	0.14	
	LTE Band 4	99	0.068	23.55	24	1.109	0.075	255	0.054	12.51	12.7	1.045	0.056	0.12	0.13	
	LTE Band 12	183	0.117	23.29	24	1.178	0.138	255	0.054	12.51	12.7	1.045	0.056	0.17	0.19	
Top Side	LTE Band 2	30	0.508	23.54	24	1.112	0.565	-	-	-	-	-	-	0.51	0.57	
	LTE Band 4	102	0.353	23.59	24	1.099	0.388	-	-	-	-	-	-	0.35	0.39	
	LTE Band 12	184	0.077	23.50	24	1.122	0.086	-	-	-	-	-	-	0.08	0.09	
Bottom Side	CDMA BC0	62	0.098	24.66	25	1.081	0.106	-	-	-	-	-	-	0.10	0.11	
	CDMA BC1	53	0.483	24.82	25	1.042	0.503	-	-	-	-	-	-	0.48	0.50	
	CDMA BC15	73	0.288	24.88	25	1.028	0.296	-	-	-	-	-	-	0.29	0.30	



<Body-worn SAR>

Position	WWAN		Scaled WWAN				LTE			Scaled LTE				WLAN2.4G		Scaled WLAN2.4G				WWAN + WLAN	Scaled WWAN + Scaled WLAN	Case No		
	WWAN Band	Plot No	Max. SAR (W/kg)	Average Power (dBm)	Tune-up Limit (dBm)	Scaling Factor	Scaled WWAN (W/kg)	LTE Band	Plot No	Max. SAR (W/kg)	Average Power (dBm)	Tune-up Limit (dBm)	Scaling Factor	Scaled WWAN (W/kg)	Plot No	Max. SAR (W/kg)	Average Power (dBm)	Tune-up Limit (dBm)	Scaling Factor				Scaled WLAN (W/kg)	
Front (w/ Headset)	CDMA BC0	63	0.228	24.06	25	1.242	0.283	-	-	-	-	-	-	-	-	-	-	-	-	-	-	0.23	0.28	
	CDMA BC1	54	0.624	24.22	25	1.197	0.747	-	-	-	-	-	-	-	-	-	-	-	-	-	-	0.62	0.75	
	CDMA BC15	74	0.432	24.84	25	1.038	0.448	-	-	-	-	-	-	-	-	-	-	-	-	-	-	0.43	0.45	
	CDMA BC0	63	0.228	24.06	25	1.242	0.283	-	-	-	-	-	-	-	-	-	-	-	-	-	-	0.23	0.28	
	CDMA BC1	54	0.624	24.22	25	1.197	0.747	-	-	-	-	-	-	-	-	-	-	-	-	-	-	0.62	0.75	
	CDMA BC15	74	0.432	24.84	25	1.038	0.448	-	-	-	-	-	-	-	-	-	-	-	-	-	-	0.43	0.45	
	CDMA BC0	63	0.228	24.06	25	1.242	0.283	-	-	-	-	-	-	-	-	-	-	-	-	-	-	0.23	0.28	
	CDMA BC1	54	0.624	24.22	25	1.197	0.747	-	-	-	-	-	-	-	-	-	-	-	-	-	-	0.62	0.75	
Back (w/ Headset)	CDMA BC0	64	0.389	24.06	25	1.242	0.483	LTE Band 2	37	0.724	23.11	24	1.227	0.889	226	0.26	18.52	18.6	1.019	0.265	1.37	1.64	S05	
	CDMA BC1	55	0.957	24.67	25	1.079	1.033	LTE Band 2	37	0.724	23.11	24	1.227	0.889	226	0.26	18.52	18.6	1.019	0.265	1.94	2.19	S06	
	CDMA BC15	75	0.712	24.84	25	1.038	0.739	LTE Band 2	37	0.724	23.11	24	1.227	0.889	226	0.26	18.52	18.6	1.019	0.265	1.70	1.89	S07	
	CDMA BC0	64	0.389	24.06	25	1.242	0.483	LTE Band 4	108	0.636	23.38	24	1.153	0.734	226	0.26	18.52	18.6	1.019	0.265	1.29	1.48		
	CDMA BC1	55	0.957	24.67	25	1.079	1.033	LTE Band 4	108	0.636	23.38	24	1.153	0.734	226	0.26	18.52	18.6	1.019	0.265	1.85	2.03	S08	
	CDMA BC15	75	0.712	24.84	25	1.038	0.739	LTE Band 4	108	0.636	23.38	24	1.153	0.734	226	0.26	18.52	18.6	1.019	0.265	1.61	1.74	S09	
	CDMA BC0	64	0.389	24.06	25	1.242	0.483	LTE Band 12	215	0.179	23.6	24	1.096	0.196	226	0.26	18.52	18.6	1.019	0.265	0.83	0.94		
	CDMA BC1	55	0.957	24.67	25	1.079	1.033	LTE Band 12	215	0.179	23.6	24	1.096	0.196	226	0.26	18.52	18.6	1.019	0.265	1.40	1.49		
CDMA BC15	75	0.712	24.84	25	1.038	0.739	LTE Band 12	215	0.179	23.6	24	1.096	0.196	226	0.26	18.52	18.6	1.019	0.265	1.15	1.20			

Position	WWAN		Scaled WWAN				LTE			Scaled LTE				WLAN5G		Scaled WLAN5G				WWAN + WLAN	Scaled WWAN + Scaled WLAN	Case No		
	WWAN Band	Plot No	Max. SAR (W/kg)	Average Power (dBm)	Tune-up Limit (dBm)	Scaling Factor	Scaled WWAN (W/kg)	LTE Band	Plot No	Max. SAR (W/kg)	Average Power (dBm)	Tune-up Limit (dBm)	Scaling Factor	Scaled WWAN (W/kg)	Plot No	Max. SAR (W/kg)	Average Power (dBm)	Tune-up Limit (dBm)	Scaling Factor				Scaled WLAN (W/kg)	
Front (w/ Headset)	CDMA BC0	63	0.228	24.06	25	1.242	0.283	-	-	-	-	-	-	-	-	-	-	-	-	-	-	0.23	0.28	
	CDMA BC1	54	0.624	24.22	25	1.197	0.747	-	-	-	-	-	-	-	-	-	-	-	-	-	-	0.62	0.75	
	CDMA BC15	74	0.432	24.84	25	1.038	0.448	-	-	-	-	-	-	-	-	-	-	-	-	-	-	0.43	0.45	
	CDMA BC0	63	0.228	24.06	25	1.242	0.283	-	-	-	-	-	-	-	-	-	-	-	-	-	-	0.23	0.28	
	CDMA BC1	54	0.624	24.22	25	1.197	0.747	-	-	-	-	-	-	-	-	-	-	-	-	-	-	0.62	0.75	
	CDMA BC15	74	0.432	24.84	25	1.038	0.448	-	-	-	-	-	-	-	-	-	-	-	-	-	-	0.43	0.45	
	CDMA BC0	63	0.228	24.06	25	1.242	0.283	-	-	-	-	-	-	-	-	-	-	-	-	-	-	0.23	0.28	
	CDMA BC1	54	0.624	24.22	25	1.197	0.747	-	-	-	-	-	-	-	-	-	-	-	-	-	-	0.62	0.75	
Back (w/ Headset)	CDMA BC0	64	0.389	24.06	25	1.242	0.483	LTE Band 2	37	0.724	23.11	24	1.227	0.889	244	0.111	12.60	12.7	1.023	0.114	1.22	1.49		
	CDMA BC1	55	0.957	24.67	25	1.079	1.033	LTE Band 2	37	0.724	23.11	24	1.227	0.889	244	0.111	12.60	12.7	1.023	0.114	1.79	2.04	S10	
	CDMA BC15	75	0.712	24.84	25	1.038	0.739	LTE Band 2	37	0.724	23.11	24	1.227	0.889	244	0.111	12.60	12.7	1.023	0.114	1.55	1.74	S11	
	CDMA BC0	64	0.389	24.06	25	1.242	0.483	LTE Band 4	108	0.636	23.38	24	1.153	0.734	244	0.111	12.60	12.7	1.023	0.114	1.14	1.33		
	CDMA BC1	55	0.957	24.67	25	1.079	1.033	LTE Band 4	108	0.636	23.38	24	1.153	0.734	244	0.111	12.60	12.7	1.023	0.114	1.70	1.88	S12	
	CDMA BC15	75	0.712	24.84	25	1.038	0.739	LTE Band 4	108	0.636	23.38	24	1.153	0.734	244	0.111	12.60	12.7	1.023	0.114	1.46	1.59		
	CDMA BC0	64	0.389	24.06	25	1.242	0.483	LTE Band 12	215	0.179	23.6	24	1.096	0.196	244	0.111	12.60	12.7	1.023	0.114	0.68	0.79		
	CDMA BC1	55	0.957	24.67	25	1.079	1.033	LTE Band 12	215	0.179	23.6	24	1.096	0.196	244	0.111	12.60	12.7	1.023	0.114	1.25	1.34		
CDMA BC15	75	0.712	24.84	25	1.038	0.739	LTE Band 12	215	0.179	23.6	24	1.096	0.196	244	0.111	12.60	12.7	1.023	0.114	1.00	1.05			

11.5 Simultaneous analysis - SPLSR calculation

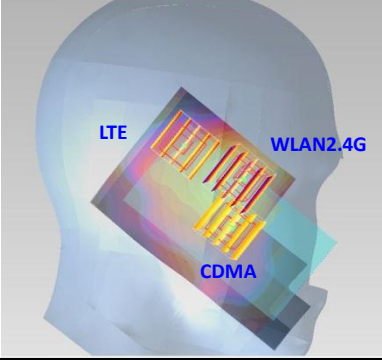
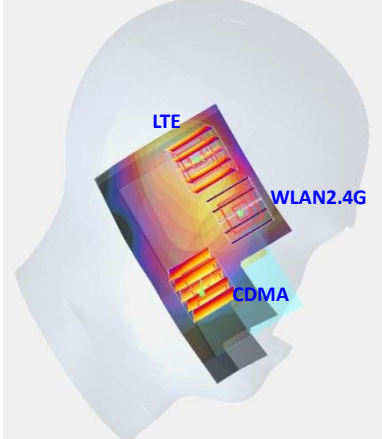
Case No	Position	CDMA BC0			LTE Band 2			WLAN 2.4G			Sum SAR (W/kg)	Pair SAR (W/kg)		Distance (cm)	SPLSR	Pair SAR (W/kg)		Distance (cm)	SPLSR	Pair SAR (W/kg)		Distance (cm)	SPLSR	Volume Scan
		#3	#125	#229	CDMA + LTE	CDMA + LTE	CDMA + LTE	CDMA + Wifi	CDMA + Wifi	CDMA + Wifi		LTE + Wifi	LTE + Wifi			LTE + Wifi								
S01	Left Cheek	0.316 W/kg			0.868 W/kg			0.455 W/kg			1.64	1.18	6.4	0.19	0.77	3.3	0.23	1.32	4.6	0.29	Not required			
	peak ordinate (m)	0.0666	0.278	-0.17	0.0257	0.327	-0.17	0.0687	0.311	-0.17														
																								
Case No	Position	CDMA BC1			LTE Band 2			WLAN 2.4G			Sum SAR (W/kg)	Pair SAR (W/kg)		Distance (cm)	SPLSR	Pair SAR (W/kg)		Distance (cm)	SPLSR	Pair SAR (W/kg)		Distance (cm)	SPLSR	Volume Scan
		#67	#125	#229	CDMA + LTE	CDMA + LTE	CDMA + LTE	CDMA + Wifi	CDMA + Wifi	CDMA + Wifi		LTE + Wifi	LTE + Wifi			LTE + Wifi								
S02	Left Cheek	0.638 W/kg			0.868 W/kg			0.455 W/kg			1.96	1.51	8.8	0.17	1.09	5.9	0.18	1.32	4.6	0.29	Not required			
	peak ordinate (m)	0.0714	0.252	-0.167	0.0257	0.327	-0.17	0.0687	0.311	-0.17														
																								

Case No	Position	CDMA BC15			LTE Band 2			WLAN 2.4G			Sum SAR (W/kg)	Pair SAR (W/kg)	Distance (cm)	SPLSR	Pair SAR (W/kg)	Distance (cm)	SPLSR	Pair SAR (W/kg)	Distance (cm)	SPLSR	Volume Scan
		#43			#125			#229													
S03	Left Cheek	0.32 W/kg			0.868 W/kg			0.455 W/kg			1.64	1.19	8.8	0.14	0.78	5.9	0.13	1.32	4.6	0.29	Not required
	peak ordinate (m)	0.0716	0.252	-0.168	0.0257	0.327	-0.17	0.0687	0.311	-0.17											

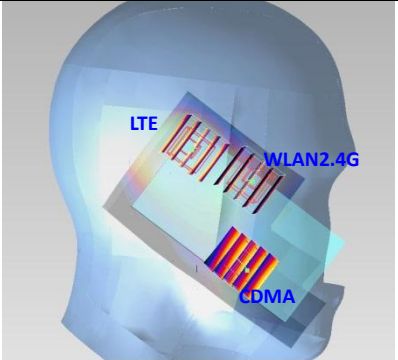

Case No	Position	CDMA BC1			LTE Band 4			WLAN 2.4G			Sum SAR (W/kg)	Pair SAR (W/kg)	Distance (cm)	SPLSR	Pair SAR (W/kg)	Distance (cm)	SPLSR	Pair SAR (W/kg)	Distance (cm)	SPLSR	Volume Scan
		#67			#204			#229													
S04	Left Cheek	0.638 W/kg			0.697 W/kg			0.455 W/kg			1.79	1.34	8.7	0.15	1.09	5.9	0.18	1.15	4.6	0.25	Not required
	peak ordinate (m)	0.0754	0.25	-0.167	0.0248	0.325	-0.17	0.0687	0.311	-0.17											

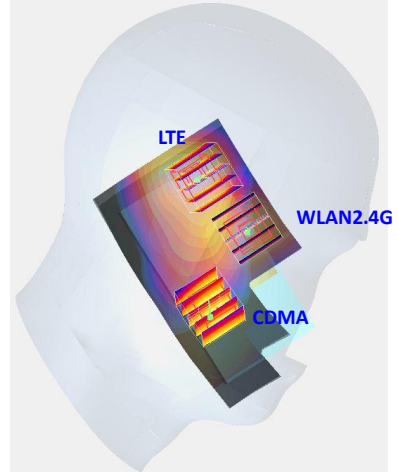





Case No	Position	CDMA BC0 Cube0			LTE Band 2			WLAN 2.4G			Sum	Pair SAR (W/kg)	Distance (cm)	SPLSR	Pair SAR (W/kg)	Distance (cm)	SPLSR	Pair SAR (W/kg)	Distance (cm)	SPLSR	Volume Scan
		#64			#37			#226			SAR (W/kg)	CDMA + LTE	CDMA + LTE	CDMA + LTE	CDMA + Wifi	CDMA + Wifi	CDMA + Wifi	LTE + Wifi	LTE + Wifi	LTE + Wifi	
S05	Back w/ Headset	0.483 W/kg			0.889 W/kg			0.265 W/kg			1.64	1.37	11.8	0.12	0.75	6.9	0.11	1.15	6.3	0.18	Not required
	peak ordinate (m)	-0.018	-0.053	-0.202	-0.028	0.065	-0.202	-0.052	0.00701	-0.202											
	Position	CDMA BC0 Cube1			LTE Band 2			WLAN 2.4G			Sum	Pair SAR (W/kg)	Distance (cm)	SPLSR	Pair SAR (W/kg)	Distance (cm)	SPLSR	Pair SAR (W/kg)	Distance (cm)	SPLSR	Volume Scan
	Back w/ Headset	0.472 W/kg			0.889 W/kg			0.265 W/kg			1.63	1.36	8.7	0.16	0.74	4.9	0.15	1.15	6.3	0.18	Not required
peak ordinate (m)	-0.012	-0.021	-0.203	-0.028	0.065	-0.202	-0.052	0.00701	-0.202												

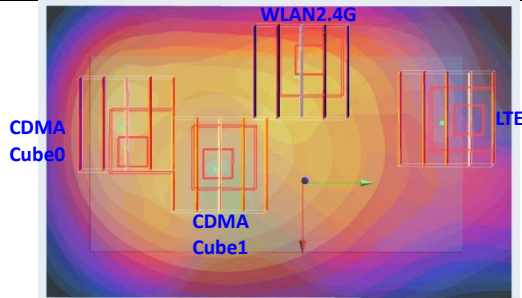

Case No	Position	CDMA BC1			LTE Band 2			WLAN 2.4G			Sum	Pair SAR (W/kg)	Distance (cm)	SPLSR	Pair SAR (W/kg)	Distance (cm)	SPLSR	Pair SAR (W/kg)	Distance (cm)	SPLSR	Volume Scan
		#55			#37			#226			SAR (W/kg)	CDMA + LTE	CDMA + LTE	CDMA + LTE	CDMA + Wifi	CDMA + Wifi	CDMA + Wifi	LTE + Wifi	LTE + Wifi	LTE + Wifi	
S06	Back w/ Headset	1.033 W/kg			0.889 W/kg			0.265 W/kg			2.19	1.92	10.4	0.19	1.30	6.7	0.19	1.15	6.3	0.18	Not required
	peak ordinate (m)	-0.000028	-0.035	-0.202	-0.028	0.065	-0.202	-0.052	0.00701	-0.202											

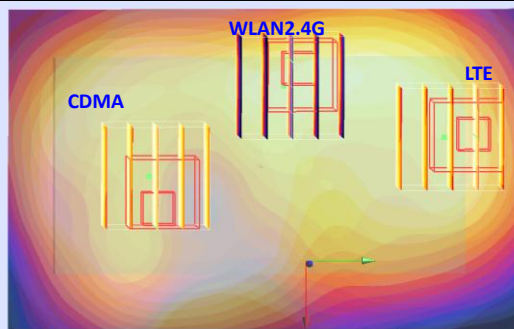

Case No	Position	CDMA BC15			LTE Band 2			WLAN 2.4G			Sum	Pair SAR (W/kg)	Distance (cm)	SPLSR	Pair SAR (W/kg)	Distance (cm)	SPLSR	Pair SAR (W/kg)	Distance (cm)	SPLSR	Volume Scan
		#75			#37			#226			SAR (W/kg)	CDMA + LTE	CDMA + LTE	CDMA + LTE	CDMA + Wifi	CDMA + Wifi	CDMA + Wifi	LTE + Wifi	LTE + Wifi	LTE + Wifi	
S07	Back w/ Headset	0.739 W/kg			0.889 W/kg			0.265 W/kg			1.89	1.63	10.6	0.15	1.00	6.5	0.15	1.15	6.3	0.18	Not required
	peak ordinate (m)	-0.00603	-0.039	-0.202	-0.028	0.065	-0.202	-0.052	0.00701	-0.202											

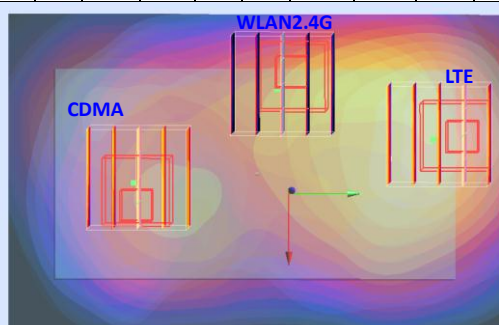

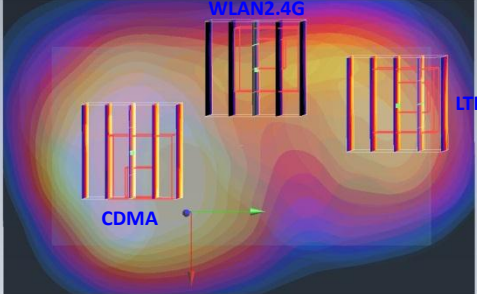
Case No	Position	CDMA BC1			LTE Band 4			WLAN 2.4G			Sum	Pair SAR (W/kg)	Distance (cm)	SPLSR	Pair SAR (W/kg)	Distance (cm)	SPLSR	Pair SAR (W/kg)	Distance (cm)	SPLSR	Volume Scan
		#55			#108			#226													
S08	Back w/ Headset	1.033 W/kg			0.734 W/kg			0.265 W/kg			2.03	1.77	10.3	0.17	1.30	6.7	0.19	1.00	5.9	0.17	Not required
	peak ordinate (m)	-0.000028	-0.035	-0.202	-0.032	0.063	-0.202	-0.052	0.00701	-0.202											
																					
Case No	Position	CDMA BC15			LTE Band 4			WLAN 2.4G			Sum	Pair SAR (W/kg)	Distance (cm)	SPLSR	Pair SAR (W/kg)	Distance (cm)	SPLSR	Pair SAR (W/kg)	Distance (cm)	SPLSR	Volume Scan
		#75			#108			#226													

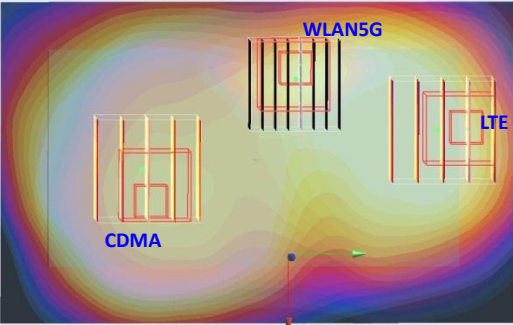
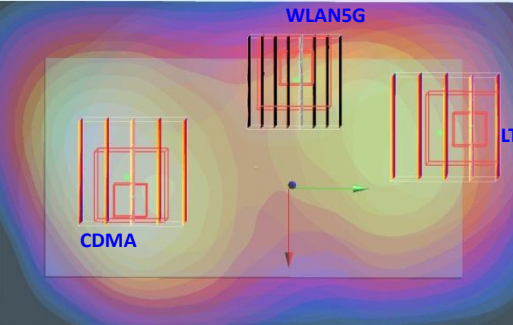
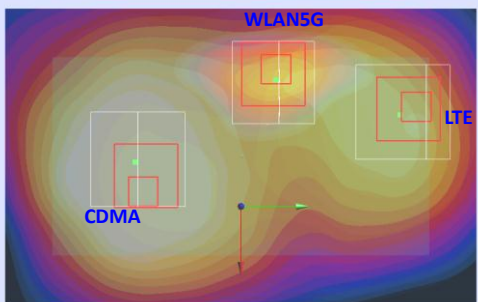
Case No	Position	CDMA BC1			LTE Band 2			WLAN 5G			Sum	Pair SAR (W/kg)	Distance (cm)	SPLSR	Pair SAR (W/kg)	Distance (cm)	SPLSR	Pair SAR (W/kg)	Distance (cm)	SPLSR	Volume Scan
		#55			#37			#244													
S10	Back w/ Headset	1.033 W/kg			0.889 W/kg			0.114 W/kg			2.04	1.92	10.4	0.19	1.15	6.8	0.17	1.00	5.6	0.18	Not required
	peak ordinate (m)	-0.000028	-0.035	-0.202	-0.028	0.065	-0.202	-0.048	0.013	-0.204											
																					
Case No	Position	CDMA BC15			LTE Band 2			WLAN 5G			Sum	Pair SAR (W/kg)	Distance (cm)	SPLSR	Pair SAR (W/kg)	Distance (cm)	SPLSR	Pair SAR (W/kg)	Distance (cm)	SPLSR	Volume Scan
		#75			#37			#244													
S11	Back w/ Headset	0.739 W/kg			0.889 W/kg			0.114 W/kg			1.74	1.63	10.6	0.15	0.85	6.7	0.13	1.00	5.6	0.18	Not required
	peak ordinate (m)	-0.00603	-0.039	-0.202	-0.028	0.065	-0.202	-0.048	0.013	-0.204											
																					
Case No	Position	CDMA BC1			LTE Band 2			WLAN 2.4G			Sum	Pair SAR (W/kg)	Distance (cm)	SPLSR	Pair SAR (W/kg)	Distance (cm)	SPLSR	Pair SAR (W/kg)	Distance (cm)	SPLSR	Volume Scan
		#55			#108			#244													
S12	Back w/ Headset	1.033 W/kg			0.734 W/kg			0.114 W/kg			1.88	1.77	10.3	0.17	1.15	6.8	0.17	0.85	5.3	0.16	Not required
	peak ordinate (m)	-0.000028	-0.035	-0.202	-0.032	0.063	-0.202	-0.048	0.013	-0.204											
																					

Test Engineer : San Lin, Ken Li, Angelo Chang, Bevis Chang, Ted Sun, Jack Wu, and Vic Yang

## **12. Uncertainty Assessment**

The component of uncertainty may generally be categorized according to the methods used to evaluate them. The evaluation of uncertainty by the statistical analysis of a series of observations is termed a Type A evaluation of uncertainty. The evaluation of uncertainty by means other than the statistical analysis of a series of observations is termed a Type B evaluation of uncertainty. Each component of uncertainty, however evaluated, is represented by an estimated standard deviation, termed standard uncertainty, which is determined by the positive square root of the estimated variance.

A Type A evaluation of standard uncertainty may be based on any valid statistical method for treating data. This includes calculating the standard deviation of the mean of a series of independent observations; using the method of least squares to fit a curve to the data in order to estimate the parameter of the curve and their standard deviations; or carrying out an analysis of variance in order to identify and quantify random effects in certain kinds of measurement.

A type B evaluation of standard uncertainty is typically based on scientific judgment using all of the relevant information available. These may include previous measurement data, experience, and knowledge of the behavior and properties of relevant materials and instruments, manufacture's specification, data provided in calibration reports and uncertainties assigned to reference data taken from handbooks. Broadly speaking, the uncertainty is either obtained from an outdoor source or obtained from an assumed distribution, such as the normal distribution, rectangular or triangular distributions indicated in Table 12.1

<b>Uncertainty Distributions</b>	<b>Normal</b>	<b>Rectangular</b>	<b>Triangular</b>	<b>U-Shape</b>
Multi-plying Factor <sup>(a)</sup>	1/k <sup>(b)</sup>	1/√3	1/√6	1/√2

(a) standard uncertainty is determined as the product of the multiplying factor and the estimated range of variations in the measured quantity

(b)  $\kappa$  is the coverage factor

**Table 12.1 Standard Uncertainty for Assumed Distribution**

The combined standard uncertainty of the measurement result represents the estimated standard deviation of the result. It is obtained by combining the individual standard uncertainties of both Type A and Type B evaluation using the usual "root-sum-squares" (RSS) methods of combining standard deviations by taking the positive square root of the estimated variances.

Expanded uncertainty is a measure of uncertainty that defines an interval about the measurement result within which the measured value is confidently believed to lie. It is obtained by multiplying the combined standard uncertainty by a coverage factor. Typically, the coverage factor ranges from 2 to 3. Using a coverage factor allows the true value of a measured quantity to be specified with a defined probability within the specified uncertainty range. For purpose of this document, a coverage factor two is used, which corresponds to confidence interval of about 95 %. The DASY uncertainty Budget is shown in the following tables.



Error Description	Uncertainty Value (±%)	Probability Distribution	Divisor	Ci (1g)	Ci (10g)	Standard Uncertainty (1g)	Standard Uncertainty (10g)
<b>Measurement System</b>							
Probe Calibration	6.0	Normal	1	1	1	± 6.0 %	± 6.0 %
Axial Isotropy	4.7	Rectangular	√3	0.7	0.7	± 1.9 %	± 1.9 %
Hemispherical Isotropy	9.6	Rectangular	√3	0.7	0.7	± 3.9 %	± 3.9 %
Boundary Effects	1.0	Rectangular	√3	1	1	± 0.6 %	± 0.6 %
Linearity	4.7	Rectangular	√3	1	1	± 2.7 %	± 2.7 %
System Detection Limits	1.0	Rectangular	√3	1	1	± 0.6 %	± 0.6 %
Readout Electronics	0.3	Normal	1	1	1	± 0.3 %	± 0.3 %
Response Time	0.8	Rectangular	√3	1	1	± 0.5 %	± 0.5 %
Integration Time	2.6	Rectangular	√3	1	1	± 1.5 %	± 1.5 %
RF Ambient Noise	3.0	Rectangular	√3	1	1	± 1.7 %	± 1.7 %
RF Ambient Reflections	3.0	Rectangular	√3	1	1	± 1.7 %	± 1.7 %
Probe Positioner	0.4	Rectangular	√3	1	1	± 0.2 %	± 0.2 %
Probe Positioning	2.9	Rectangular	√3	1	1	± 1.7 %	± 1.7 %
Max. SAR Eval.	1.0	Rectangular	√3	1	1	± 0.6 %	± 0.6 %
<b>Test Sample Related</b>							
Device Positioning	2.9	Normal	1	1	1	± 2.9 %	± 2.9 %
Device Holder	3.6	Normal	1	1	1	± 3.6 %	± 3.6 %
Power Drift	5.0	Rectangular	√3	1	1	± 2.9 %	± 2.9 %
<b>Phantom and Setup</b>							
Phantom Uncertainty	4.0	Rectangular	√3	1	1	± 2.3 %	± 2.3 %
Liquid Conductivity (Target)	5.0	Rectangular	√3	0.64	0.43	± 1.8 %	± 1.2 %
Liquid Conductivity (Meas.)	2.5	Normal	1	0.64	0.43	± 1.6 %	± 1.1 %
Liquid Permittivity (Target)	5.0	Rectangular	√3	0.6	0.49	± 1.7 %	± 1.4 %
Liquid Permittivity (Meas.)	2.5	Normal	1	0.6	0.49	± 1.5 %	± 1.2 %
<b>Combined Standard Uncertainty</b>						± 11.0 %	± 10.8 %
<b>Coverage Factor for 95 %</b>						K=2	
<b>Expanded Uncertainty</b>						± 22.0 %	± 21.5 %

Table 12.2 Uncertainty Budget of DASY for frequency range 300 MHz to 3 GHz



Error Description	Uncertainty Value (±%)	Probability Distribution	Divisor	Ci (1g)	Ci (10g)	Standard Uncertainty (1g)	Standard Uncertainty (10g)
<b>Measurement System</b>							
Probe Calibration	6.55	Normal	1	1	1	± 6.55 %	± 6.55 %
Axial Isotropy	4.7	Rectangular	√3	0.7	0.7	± 1.9 %	± 1.9 %
Hemispherical Isotropy	9.6	Rectangular	√3	0.7	0.7	± 3.9 %	± 3.9 %
Boundary Effects	2.0	Rectangular	√3	1	1	± 1.2 %	± 1.2 %
Linearity	4.7	Rectangular	√3	1	1	± 2.7 %	± 2.7 %
System Detection Limits	1.0	Rectangular	√3	1	1	± 0.6 %	± 0.6 %
Readout Electronics	0.3	Normal	1	1	1	± 0.3 %	± 0.3 %
Response Time	0.8	Rectangular	√3	1	1	± 0.5 %	± 0.5 %
Integration Time	2.6	Rectangular	√3	1	1	± 1.5 %	± 1.5 %
RF Ambient Noise	3.0	Rectangular	√3	1	1	± 1.7 %	± 1.7 %
RF Ambient Reflections	3.0	Rectangular	√3	1	1	± 1.7 %	± 1.7 %
Probe Positioner	0.8	Rectangular	√3	1	1	± 0.5 %	± 0.5 %
Probe Positioning	9.9	Rectangular	√3	1	1	± 5.7 %	± 5.7 %
Max. SAR Eval.	4.0	Rectangular	√3	1	1	± 2.3 %	± 2.3 %
<b>Test Sample Related</b>							
Device Positioning	2.9	Normal	1	1	1	± 2.9 %	± 2.9 %
Device Holder	3.6	Normal	1	1	1	± 3.6 %	± 3.6 %
Power Drift	5.0	Rectangular	√3	1	1	± 2.9 %	± 2.9 %
<b>Phantom and Setup</b>							
Phantom Uncertainty	4.0	Rectangular	√3	1	1	± 2.3 %	± 2.3 %
Liquid Conductivity (Target)	5.0	Rectangular	√3	0.64	0.43	± 1.8 %	± 1.2 %
Liquid Conductivity (Meas.)	2.5	Normal	1	0.64	0.43	± 1.6 %	± 1.1 %
Liquid Permittivity (Target)	5.0	Rectangular	√3	0.6	0.49	± 1.7 %	± 1.4 %
Liquid Permittivity (Meas.)	2.5	Normal	1	0.6	0.49	± 1.5 %	± 1.2 %
<b>Combined Standard Uncertainty</b>						± 12.8 %	± 12.6 %
<b>Coverage Factor for 95 %</b>						K=2	
<b>Expanded Uncertainty</b>						± 25.6 %	± 25.2 %

Table 12.3 Uncertainty Budget of DASY for frequency range 3 GHz to 6 GHz



### **13. References**

- [1] FCC 47 CFR Part 2 “Frequency Allocations and Radio Treaty Matters; General Rules and Regulations”
- [2] ANSI/IEEE Std. C95.1-1992, “IEEE Standard for Safety Levels with Respect to Human Exposure to Radio Frequency Electromagnetic Fields, 3 kHz to 300 GHz”, September 1992
- [3] IEEE Std. 1528-2003, “Recommended Practice for Determining the Peak Spatial-Average Specific Absorption Rate (SAR) in the Human Head from Wireless Communications Devices: Measurement Techniques”, December 2003
- [4] FCC OET Bulletin 65 (Edition 97-01) Supplement C (Edition 01-01), “Evaluating Compliance with FCC Guidelines for Human Exposure to Radiofrequency Electromagnetic Fields”, June 2001
- [5] SPEAG DASY System Handbook
- [6] FCC KDB 248227 D01 v01r02, “SAR Measurement Procedures for 802.11 a/b/g Transmitters”, May 2007
- [7] FCC KDB 447498 D01 v04, “Mobile and Portable Device RF Exposure Procedures and Equipment Authorization Policies”, November 2009
- [8] FCC KDB 648474 D01 v01r05, “SAR Evaluation Considerations for Handsets with Multiple Transmitters and Antennas”, September 2008
- [9] FCC KDB 941225 D01 v02, “SAR Measurement Procedures for 3G Devices – CDMA 2000 / Ev-Do / WCDMA / HSDPA / HSPA”, October 2007
- [10] FCC KDB 941225 D02 v02 "3GPP R6 HSPA and R7 HSPA+ SAR Guidance", December 2009.
- [11] FCC KDB 941225 D03 v01, “Recommended SAR Test Reduction Procedures for GSM / GPRS / EDGE”, December 2008
- [12] FCC KDB 941225 D04 v01, “Evaluating SAR for GSM/(E)GPRS Dual Transfer Mode”, January 27 2010
- [13] FCC KDB 941225 D05 v01, “SAR Test Considerations for LTE Handsets and Data Modems”, December 15 2010
- [14] FCC KDB 941225 D06 v01, "SAR Evaluation Procedures for Portable Devices with Wireless Router Capabilities", April 2011
- [15] FCC KDB 388624 D02, "Permit But Ask List", December 2011.



## ***Appendix A. Plots of System Performance Check***

The plots are shown as follows.





## ***Appendix B. Plots of SAR Measurement***

The plots are shown as follows.



## **Appendix C. DASYS Calibration Certificate**

The DASYS calibration certificates are shown as follows.