



FCC SAR Test Report

APPLICANT : HTC Corporation
EQUIPMENT : Smartphone
MODEL NAME : PL80100
FCC ID : NM8PL80100
STANDARD : FCC 47 CFR Part 2 (2.1093)
ANSI/IEEE C95.1-1992
IEEE 1528-2003
FCC OET Bulletin 65 Supplement C (Edition 01-01)

The product was completely tested on Oct. 14, 2012. We, SPORTON INTERNATIONAL INC., would like to declare that the tested sample has been evaluated in accordance with the procedures and shown the compliance with the applicable technical standards.

The test results in this report apply exclusively to the tested model / sample. Without written approval of SPORTON INTERNATIONAL INC., the test report shall not be reproduced except in full.

Reviewed by:

Jones Tsai / Manager



SPORTON INTERNATIONAL INC.

No. 52, Hwa Ya 1st Rd., Hwa Ya Technology Park, Kwei-Shan Hsiang, Tao Yuan Hsien, Taiwan, R.O.C.



Table of Contents

1. Statement of Compliance	4
2. Administration Data	5
2.1 Testing Laboratory	5
2.2 Applicant	5
2.3 Manufacturer	5
2.4 Application Details	5
3. General Information	6
3.1 Description of Equipment Under Test (EUT)	6
3.2 Applied Standard	7
3.3 Device Category and SAR Limits	7
3.4 Test Conditions	7
4. Specific Absorption Rate (SAR)	8
4.1 Introduction	8
4.2 SAR Definition	8
5. SAR Measurement System	9
5.1 E-Field Probe	10
5.2 Data Acquisition Electronics (DAE)	11
5.3 Robot	11
5.4 Measurement Server	11
5.5 Phantom	12
5.6 Device Holder	13
5.7 Data Storage and Evaluation	14
5.8 Test Equipment List	16
6. Tissue Simulating Liquids	17
7. SAR Measurement Evaluation	19
7.1 Purpose of System Performance check	19
7.2 System Setup	19
7.3 SAR System Verification Results	20
8. EUT Testing Position	21
8.1 Define two imaginary lines on the handset	21
8.2 Cheek Position	22
8.3 Tilted Position	22
8.4 Body Worn Position	23
9. Measurement Procedures	24
9.1 Spatial Peak SAR Evaluation	24
9.2 Area & Zoom Scan Procedures	24
9.3 Volume Scan Procedures	25
9.4 SAR Averaged Methods	25
9.5 Power Drift Monitoring	25
10. SAR Test Configurations	26
10.1 Exposure Positions Consideration	26
10.2 Conducted RF Output Power (Unit: dBm)	28
11. SAR Test Results	37
11.1 Test Records for Head SAR Test	37
11.2 Test Records for Hotspot SAR Test	38
11.3 Test Records for Body-worn SAR Test	40
11.4 Simultaneous Multi-band Transmission Analysis	41
12. Uncertainty Assessment	44
13. References	47

Appendix A. Plots of System Performance Check

Appendix B. Plots of SAR Measurement

Appendix C. DASYS Calibration Certificate

Appendix D. Test Setup Photos



1. Statement of Compliance

The maximum results of Specific Absorption Rate (SAR) found during testing for **HTC Corporation Smartphone, PL80100** are as follows.

<Standalone SAR Summary>

Band	Position	SAR _{1g} (W/kg)
GSM850	Head	0.267
GSM1900	Head	0.212
WCDMA Band V	Head	0.34
WCDMA Band II	Head	0.613
WLAN 2.4G	Head	0.322
WLAN 5G	Head	0.065
GSM850	Hotspot (1 cm Gap)	0.759
GSM1900	Hotspot (1 cm Gap)	0.347
WCDMA Band V	Hotspot (1 cm Gap)	0.925
WCDMA Band II	Hotspot (1 cm Gap)	0.735
WLAN 2.4G	Hotspot (1 cm Gap)	0.287
GSM850	Body-worn (1 cm Gap)	0.759
GSM1900	Body-worn (1 cm Gap)	0.351
WCDMA Band V	Body-worn (1 cm Gap)	0.925
WCDMA Band II	Body-worn (1 cm Gap)	0.769
WLAN 2.4G	Body-worn (1 cm Gap)	0.287
WLAN 5G	Body-worn (1 cm Gap)	0.068

<Simultaneous SAR Summary>

Band	Position	SAR _{1g} (W/kg)
WCDMA Band V	Hotspot (1 cm Gap)	1.21
WLAN 2.4G		
WCDMA Band V	Body-worn (1 cm Gap)	0.99
WLAN 5G		

This device is in compliance with Specific Absorption Rate (SAR) for general population/uncontrolled exposure limits (1.6 W/kg) specified in FCC 47 CFR part 2 (2.1093) and ANSI/IEEE C95.1-1992, and had been tested in accordance with the measurement methods and procedures specified in IEEE 1528-2003 and FCC OET Bulletin 65 Supplement C (Edition 01-01).



2. Administration Data

2.1 Testing Laboratory

Test Site	SPORTON INTERNATIONAL INC.
Test Site Location	No. 52, Hwa Ya 1 st Rd., Hwa Ya Technology Park, Kwei-Shan Hsiang, Tao Yuan Hsien, Taiwan, R.O.C. TEL: +886-3-327-3456 FAX: +886-3-328-4978

2.2 Applicant

Company Name	HTC Corporation
Address	No. 23, Xinghua Rd., Taoyuan City, Taoyuan County 330, Taiwan

2.3 Manufacturer

Company Name	HTC Corporation
Address	No. 23, Xinghua Rd., Taoyuan City, Taoyuan County 330, Taiwan

2.4 Application Details

Date of Start during the Test	Oct. 08, 2012
Date of End during the Test	Oct. 14, 2012



3. General Information

3.1 Description of Equipment Under Test (EUT)

Product Feature & Specification	
EUT	Smartphone
Model Name	PL80100
FCC ID	NM8PL80100
IMEI Code	352803050011205
Tx Frequency	GSM850: 824.2 MHz ~ 848.8 MHz GSM1900: 1850.2 MHz ~ 1909.8 MHz WCDMA Band V: 826.4 MHz ~ 846.6 MHz WCDMA Band II: 1852.4 MHz ~ 1907.6 MHz WLAN2.4G: 2412 MHz ~ 2462 MHz WLAN5G: 5180 MHz ~ 5240 MHz; 5260 MHz ~ 5320 MHz; 5500 MHz ~ 5700 MHz Bluetooth: 2402 MHz ~ 2480 MHz NFC : 13.56 MHz
Maximum Average Output Power to Antenna	GSM850: 33.37 dBm GSM1900: 29.67 dBm WCDMA Band V: 23.56 dBm WCDMA Band II: 23.34 dBm 802.11b: 18.13 dBm 802.11g: 12.28 dBm 802.11n-HT20 (2.4GHz) : 12.26 dBm 802.11n-HT40 (2.4GHz) : 12.09 dBm 802.11a : 12.44 dBm 802.11n-HT20 (5GHz) : 12.46 dBm 802.11n-HT40 (5GHz) : 12.05 dBm Bluetooth: 7.03 dBm
Antenna Type	WWAN: Fixed Internal Antenna WLAN: PIFA Antenna Bluetooth: PIFA Antenna NFC: Loop Antenna
Uplink Modulations	GSM: GMSK GPRS: GMSK EDGE: GMSK / 8PSK WCDMA (Rel 99): QPSK HSDPA (Rel 8): QPSK HSUPA (Rel 6): QPSK 802.11b: DSSS (BPSK / QPSK / CCK) 802.11a/g/n: OFDM (BPSK / QPSK / 16QAM / 64QAM) Bluetooth : GFSK Bluetooth EDR : $\pi/4$ -DQPSK, 8-DPSK Bluetooth 4.0 LE: GFSK NFC : ASK
Dual Transfer Mode (DTM) Category	Class A – EUT can support Packet Switched and Circuit Switched Network simultaneously.
EUT Stage	Identical Prototype
Remark:	<ol style="list-style-type: none"> The above EUT's information was declared by manufacturer. Please refer to the specifications or user's manual for more detailed description. 5600 MHz ~ 5650 MHz is notched.



Per KDB 941225 D04 requirement, the required test configuration for this device is as below:

1. This EUT is class A device
2. This EUT supports (E)GPRS multi-slot class 12 (max. uplink : 4, max. downlink : 4, total timeslots : 5)
3. This EUT supports DTM multi-slot class 11 (max. uplink : 3 for 1 CS & 2 PS, max. downlink : 4, total timeslots : 5)
4. The measured maximum conducted power can be referred to section 10.2 of this report
5. For DTM multi-slot class 11 link mode, the device was linked with system emulator (Agilent E5515C) and transmit maximum power on maximum number of Tx slots (one CS timeslot and two PS timeslots per frame).

3.2 Applied Standard

The Specific Absorption Rate (SAR) testing specification, method, and procedure for this device is in accordance with the following standards:

- FCC 47 CFR Part 2 (2.1093)
- ANSI/IEEE C95.1-1992
- IEEE 1528-2003
- FCC OET Bulletin 65 Supplement C (Edition 01-01)
- FCC KDB 447498 D01 v04
- FCC KDB 648474 D01 v01r05
- FCC KDB 941225 D01 v02
- FCC KDB 941225 D03 v01
- FCC KDB 941225 D04 v01
- FCC KDB 941225 D06 v01
- FCC KDB 248227 D01 v01r02

3.3 Device Category and SAR Limits

This device belongs to portable device category because its radiating structure is allowed to be used within 20 centimeters of the body of the user. Limit for General Population/Uncontrolled exposure should be applied for this device, it is 1.6 W/kg as averaged over any 1 gram of tissue.

3.4 Test Conditions

3.4.1 Ambient Condition

Ambient Temperature	20 to 24 °C
Humidity	< 60 %

3.4.2 Test Configuration

The device was controlled by using a base station emulator. Communication between the device and the emulator was established by air link. The distance between the EUT and the antenna of the emulator is larger than 50 cm and the output power radiated from the emulator antenna is at least 30 dB smaller than the output power of EUT. The EUT was set from the emulator to radiate maximum output power during all tests.

For WLAN SAR testing, WLAN engineering testing software installed on the EUT can provide continuous transmitting RF signal.

4. Specific Absorption Rate (SAR)

4.1 Introduction

SAR is related to the rate at which energy is absorbed per unit mass in an object exposed to a radio field. The SAR distribution in a biological body is complicated and is usually carried out by experimental techniques or numerical modeling. The standard recommends limits for two tiers of groups, occupational/controlled and general population/uncontrolled, based on a person's awareness and ability to exercise control over his or her exposure. In general, occupational/controlled exposure limits are higher than the limits for general population/uncontrolled.

4.2 SAR Definition

The SAR definition is the time derivative (rate) of the incremental energy (dW) absorbed by (dissipated in) an incremental mass (dm) contained in a volume element (dv) of a given density (ρ). The equation description is as below:

$$\text{SAR} = \frac{d}{dt} \left(\frac{dW}{dm} \right) = \frac{d}{dt} \left(\frac{dW}{\rho dv} \right)$$

SAR is expressed in units of Watts per kilogram (W/kg)

SAR measurement can be either related to the temperature elevation in tissue by

$$\text{SAR} = C \left(\frac{\delta T}{\delta t} \right)$$

Where: C is the specific heat capacity, δT is the temperature rise and δt is the exposure duration, or related to the electrical field in the tissue by

$$\text{SAR} = \frac{\sigma |E|^2}{\rho}$$

Where: σ is the conductivity of the tissue, ρ is the mass density of the tissue and E is the RMS electrical field strength.

However for evaluating SAR of low power transmitter, electrical field measurement is typically applied.

5. SAR Measurement System



Fig 5.1 SPEAG DASY System Configurations

The DASY system for performance compliance tests is illustrated above graphically. This system consists of the following items:

- A standard high precision 6-axis robot with controller, a teach pendant and software
- A data acquisition electronic (DAE) attached to the robot arm extension
- A dosimetric probe equipped with an optical surface detector system
- The electro-optical converter (EOC) performs the conversion between optical and electrical signals
- A measurement server performs the time critical tasks such as signal filtering, control of the robot operation and fast movement interrupts.
- A probe alignment unit which improves the accuracy of the probe positioning
- A computer operating Windows XP
- DASY software
- Remote control with teach pendant and additional circuitry for robot safety such as warning lamps, etc.
- The SAM twin phantom
- A device holder
- Tissue simulating liquid
- Dipole for evaluating the proper functioning of the system

Component details are described in in the following sub-sections.

5.1 E-Field Probe

The SAR measurement is conducted with the dosimetric probe (manufactured by SPEAG). The probe is specially designed and calibrated for use in liquid with high permittivity. The dosimetric probe has special calibration in liquid at different frequency. This probe has a built in optical surface detection system to prevent from collision with phantom.

5.1.1 E-Field Probe Specification

<ET3DV6 / ET3DV6R Probe >

Construction	Symmetrical design with triangular core Built-in optical fiber for surface detection system. Built-in shielding against static charges. PEEK enclosure material (resistant to organic solvents, e.g., DGBE)	 <p>Fig 5.2 Photo of ET3DV6/ET3DV6</p>
Frequency	10 MHz to 3 GHz; Linearity: ± 0.2 dB	
Directivity	± 0.2 dB in HSL (rotation around probe axis) ± 0.4 dB in HSL (rotation normal to probe axis)	
Dynamic Range	5 μ W/g to 100 mW/g; Linearity: ± 0.2 dB	
Dimensions	Overall length: 330 mm (Tip: 16 mm) Tip diameter: 6.8 mm (Body: 12 mm) Distance from probe tip to dipole centers: 2.7 mm	

<EX3DV4 / ES3DV4 Probe >

Construction	Symmetrical design with triangular core Built-in shielding against static charges PEEK enclosure material (resistant to organic solvents, e.g., DGBE)	 <p>Fig 5.3 Photo of EX3DV4/ES3DV4</p>
Frequency	10 MHz to 6 GHz; Linearity: ± 0.2 dB	
Directivity	± 0.3 dB in HSL (rotation around probe axis) ± 0.5 dB in tissue material (rotation normal to probe axis)	
Dynamic Range	10 μ W/g to 100 mW/g; Linearity: ± 0.2 dB (noise: typically < 1 μ W/g)	
Dimensions	Overall length: 330 mm (Tip: 20 mm) Tip diameter: 2.5 mm (Body: 12 mm) Typical distance from probe tip to dipole centers: 1 mm	

5.1.2 E-Field Probe Calibration

Each probe needs to be calibrated according to a dosimetric assessment procedure with accuracy better than $\pm 10\%$. The spherical isotropy shall be evaluated and within ± 0.25 dB. The sensitivity parameters (NormX, NormY, and NormZ), the diode compression parameter (DCP) and the conversion factor (ConvF) of the probe are tested. The calibration data can be referred to appendix C of this report.

5.2 Data Acquisition Electronics (DAE)

The data acquisition electronics (DAE) consists of a highly sensitive electrometer-grade preamplifier with auto-zeroing, a channel and gain-switching multiplexer, a fast 16 bit AD-converter and a command decoder and control logic unit. Transmission to the measurement server is accomplished through an optical downlink for data and status information as well as an optical uplink for commands and the clock. The input impedance of the DAE is 200 MOhm; the inputs are symmetrical and floating. Common mode rejection is above 80 dB.



Fig 5.4 Photo of DAE

5.3 Robot

The SPEAG DASY system uses the high precision robots (DASY4: RX90BL; DASY5: TX90XL) type from Stäubli SA (France). For the 6-axis controller system, the robot controller version (DASY4: CS7MB; DASY5: CS8c) from Stäubli is used. The Stäubli robot series have many features that are important for our application:

- High precision (repeatability ± 0.035 mm)
- High reliability (industrial design)
- Jerk-free straight movements
- Low ELF interference (the closed metallic construction shields against motor control fields)

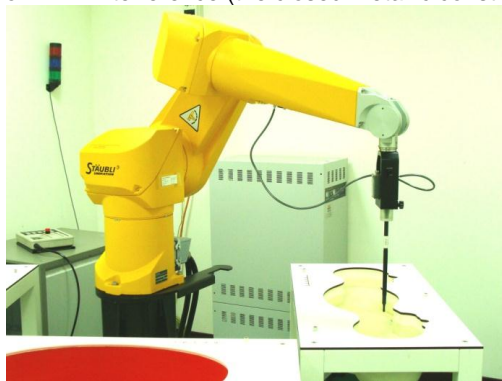

Fig 5.5 Photo of DASY4



Fig 5.6 Photo of DASY5

5.4 Measurement Server

The measurement server is based on a PC/104 CPU board with CPU (DASY4: 166 MHz, Intel Pentium; DASY5: 400 MHz, Intel Celeron), chipdisk (DASY4: 32 MB; DASY5: 128 MB), RAM (DASY4: 64 MB, DASY5: 128 MB). The necessary circuits for communication with the DAE electronic box, as well as the 16 bit AD converter system for optical detection and digital I/O interface are contained on the DASY I/O board, which is directly connected to the PC/104 bus of the CPU board.

The measurement server performs all the real-time data evaluation for field measurements and surface detection, controls robot movements and handles safety operations.



Fig 5.7 Photo of Server for DASY4

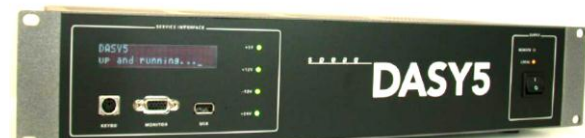



Fig 5.8 Photo of Server for DASY5

5.5 Phantom

<SAM Twin Phantom>

Shell Thickness	2 ± 0.2 mm; Center ear point: 6 ± 0.2 mm	 <p>Fig 5.9 Photo of SAM Phantom</p>
Filling Volume	Approx. 25 liters	
Dimensions	Length: 1000 mm; Width: 500 mm; Height: adjustable feet	
Measurement Areas	Left Hand, Right Hand, Flat Phantom	

The bottom plate contains three pair of bolts for locking the device holder. The device holder positions are adjusted to the standard measurement positions in the three sections. A white cover is provided to tap the phantom during off-periods to prevent water evaporation and changes in the liquid parameters. On the phantom top, three reference markers are provided to identify the phantom position with respect to the robot.

<ELI4 Phantom>

Shell Thickness	2 ± 0.2 mm (sagging: <1%)	 <p>Fig 5.10 Photo of ELI4 Phantom</p>
Filling Volume	Approx. 30 liters	
Dimensions	Major ellipse axis: 600 mm Minor axis: 400 mm	

The ELI4 phantom is intended for compliance testing of handheld and body-mounted wireless devices in the frequency range of 30 MHz to 6 GHz. ELI4 is fully compatible with standard and all known tissue simulating liquids.

5.6 Device Holder

<Device Holder for SAM Twin Phantom>

The SAR in the phantom is approximately inversely proportional to the square of the distance between the source and the liquid surface. For a source at 5 mm distance, a positioning uncertainty of ± 0.5 mm would produce a SAR uncertainty of ± 20 %. Accurate device positioning is therefore crucial for accurate and repeatable measurements. The positions in which the devices must be measured are defined by the standards.

The DASY device holder is designed to cope with different positions given in the standard. It has two scales for the device rotation (with respect to the body axis) and the device inclination (with respect to the line between the ear reference points). The rotation center for both scales is the ear reference point (ERP). Thus the device needs no repositioning when changing the angles.

The DASY device holder is constructed of low-loss POM material having the following dielectric parameters: relative permittivity $\epsilon = 3$ and loss tangent $\delta = 0.02$. The amount of dielectric material has been reduced in the closest vicinity of the device, since measurements have suggested that the influence of the clamp on the test results could thus be lowered.



Fig 5.11 Device Holder

<Laptop Extension Kit>

The extension is lightweight and made of POM, acrylic glass and foam. It fits easily on the upper part of the mounting device in place of the phone positioned. The extension is fully compatible with the SAM Twin and ELI phantoms.

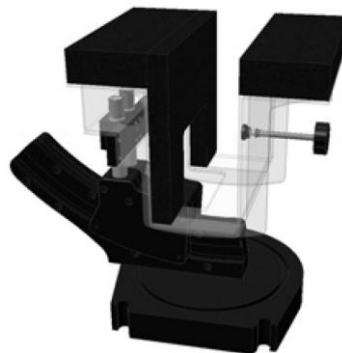

Fig 5.12 Laptop Extension Kit



5.7 Data Storage and Evaluation

5.7.1 Data Storage

The DASY software stores the assessed data from the data acquisition electronics as raw data (in microvolt readings from the probe sensors), together with all the necessary software parameters for the data evaluation (probe calibration data, liquid parameters and device frequency and modulation data) in measurement files. The post-processing software evaluates the desired unit and format for output each time the data is visualized or exported. This allows verification of the complete software setup even after the measurement and allows correction of erroneous parameter settings. For example, if a measurement has been performed with an incorrect crest factor parameter in the device setup, the parameter can be corrected afterwards and the data can be reevaluated.

The measured data can be visualized or exported in different units or formats, depending on the selected probe type (e.g., [V/m], [A/m], [mW/g]). Some of these units are not available in certain situations or give meaningless results, e.g., a SAR-output in a non-lose media, will always be zero. Raw data can also be exported to perform the evaluation with other software packages.

5.7.2 Data Evaluation

The DASY post-processing software (SEMCAD) automatically executes the following procedures to calculate the field units from the microvolt readings at the probe connector. The parameters used in the evaluation are stored in the configuration modules of the software :

Probe parameters :	- Sensitivity	Norm _i , a _{i0} , a _{i1} , a _{i2}
	- Conversion factor	ConvF _i
	- Diode compression point	dcp _i
Device parameters :	- Frequency	f
	- Crest factor	cf
Media parameters :	- Conductivity	σ
	- Density	ρ

These parameters must be set correctly in the software. They can be found in the component documents or they can be imported into the software from the configuration files issued for the DASY components. In the direct measuring mode of the multi-meter option, the parameters of the actual system setup are used. In the scan visualization and export modes, the parameters stored in the corresponding document files are used.

The first step of the evaluation is a linearization of the filtered input signal to account for the compression characteristics of the detector diode. The compensation depends on the input signal, the diode type and the DC-transmission factor from the diode to the evaluation electronics. If the exciting field is pulsed, the crest factor of the signal must be known to correctly compensate for peak power.

The formula for each channel can be given as :

$$V_i = U_i + U_i^2 \cdot \frac{cf}{dcp_i}$$

with V_i = compensated signal of channel i, (i = x, y, z)
 U_i = input signal of channel i, (i = x, y, z)
 cf = crest factor of exciting field (DASY parameter)
 dcp_i = diode compression point (DASY parameter)

From the compensated input signals, the primary field data for each channel can be evaluated :

$$\text{E-field Probes : } E_i = \sqrt{\frac{V_i}{\text{Norm}_i \cdot \text{ConvF}}}$$

$$\text{H-field Probes : } H_i = \sqrt{V_i \cdot \frac{a_{i0} + a_{i1}f + a_{i2}f^2}{f}}$$

with V_i = compensated signal of channel i, (i = x, y, z)
 Norm_i = sensor sensitivity of channel i, (i = x, y, z), $\mu\text{V}/(\text{V/m})^2$ for E-field Probes
 ConvF = sensitivity enhancement in solution
 a_{ij} = sensor sensitivity factors for H-field probes
 f = carrier frequency [GHz]
 E_i = electric field strength of channel i in V/m
 H_i = magnetic field strength of channel i in A/m

The RSS value of the field components gives the total field strength (Hermitian magnitude) :

$$E_{\text{tot}} = \sqrt{E_x^2 + E_y^2 + E_z^2}$$

The primary field data are used to calculate the derived field units.

$$\text{SAR} = E_{\text{tot}}^2 \cdot \frac{\sigma}{\rho \cdot 1000}$$

with SAR = local specific absorption rate in mW/g
 E_{tot} = total field strength in V/m
 σ = conductivity in [mho/m] or [Siemens/m]
 ρ = equivalent tissue density in g/cm^3

Note that the density is set to 1, to account for actual head tissue density rather than the density of the tissue simulating liquid.



5.8 Test Equipment List

Manufacturer	Name of Equipment	Type/Model	Serial Number	Calibration	
				Last Cal.	Due Date
SPEAG	835MHz System Validation Kit	D835V2	499	Mar. 22, 2010	Mar. 21, 2013
SPEAG	1900MHz System Validation Kit	D1900V2	5d041	Mar. 23, 2010	Mar. 22, 2013
SPEAG	2450MHz System Validation Kit	D2450V2	736	Jul. 25, 2011	Jul. 24, 2013
SPEAG	5GHz System Validation Kit	D5GHzV2	1006	Jan. 18, 2012	Jan. 17, 2013
SPEAG	Data Acquisition Electronics	DAE4	778	Aug. 27, 2012	Aug. 26, 2013
SPEAG	Data Acquisition Electronics	DAE4	1338	Jun. 12, 2012	Jun. 11, 2013
SPEAG	Data Acquisition Electronics	DAE3	495	Apr. 23, 2012	Apr. 22, 2013
SPEAG	Dosimetric E-Field Probe	EX3DV4	3801	Jun. 22, 2012	Jun. 21, 2013
SPEAG	Dosimetric E-Field Probe	ES3DV3	3305	Sep. 12, 2012	Sep. 11, 2013
SPEAG	Dosimetric E-Field Probe	EX3DV4	3792	Jun. 21, 2012	Jun. 20, 2013
SPEAG	Dosimetric E-Field Probe	EX3DV4	3578	Jun. 21, 2012	Jun. 20, 2013
SPEAG	Device Holder	N/A	N/A	NCR	NCR
SPEAG	SAM Phantom	QD 000 P40 C	TP-1303	NCR	NCR
SPEAG	SAM Phantom	QD 000 P40 C	TP-1383	NCR	NCR
SPEAG	SAM Phantom	QD 000 P40 C	TP-1446	NCR	NCR
SPEAG	SAM Phantom	QD 000 P40 C	TP-1478	NCR	NCR
SPEAG	SAM Phantom	QD 000 P41 C	TP-1150	NCR	NCR
SPEAG	SAM Phantom	QD 000 P40 CD	TP-1644	NCR	NCR
SPEAG	SAM Phantom	SM 000 T01 DA	TP-1542	NCR	NCR
Agilent	Network Analyzer	E5071C	MY46101588	May 11, 2012	May 10, 2013
Agilent	ESG Vector Series Signal Generator	E4438C	MY49070755	Oct. 17, 2011	Oct. 16, 2012
Anritsu	Power Meter	ML2495A	1132003	Aug. 14, 2012	Aug. 13, 2013
Agilent	Wireless Communication Test Set	E5515C	MY48360820	Jan. 05, 2012	Jan. 04, 2014
R&S	Universal Digital Radio communication Tester	CMU200	106656	Jun. 28, 2012	Jun. 27, 2013
Agilent	Dual Directional Coupler	778D	50422	NCR	NCR
Woken	Attenuator	WK0602-XX	N/A	NCR	NCR
AR	Power Amplifier	5S1G4M2	0328767	NCR	NCR
R&S	Spectrum Analyzer	FSP	101131	Jul. 23, 2012	Jul. 22, 2013

Table 5.1 Test Equipment List

Note:

1. The calibration certificate of DASY can be referred to appendix C of this report.
2. Referring to KDB 450824 D02, the dipole calibration interval can be extended to 3 years with justification. The dipoles are also not physically damaged, or repaired during the interval.
3. The justification data of dipole D835V2, SN: 499, D1900V2, SN: 5d041, and D2450V2, SN: 736 can be found in appendix C. The return loss is < -20dB, within 20% of prior calibration, the impedance is within 5 ohm of prior calibration.

6. Tissue Simulating Liquids

For the measurement of the field distribution inside the SAM phantom with DASy, the phantom must be filled with around 25 liters of homogeneous body tissue simulating liquid. For head SAR testing, the liquid height from the ear reference point (ERP) of the phantom to the liquid top surface is larger than 15 cm, which is shown in Fig. 6.1. For body SAR testing, the liquid height from the center of the flat phantom to the liquid top surface is larger than 15 cm, which is shown in Fig. 6.2.

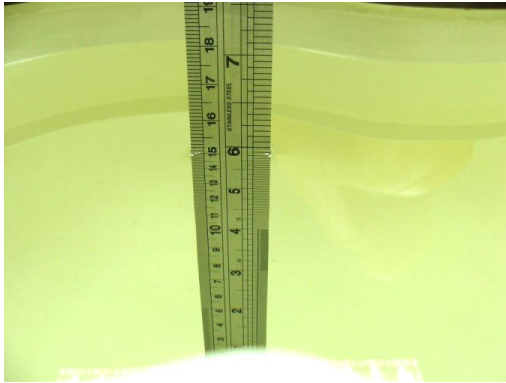

Fig 6.1 Photo of Liquid Height for Head SAR



Fig 6.2 Photo of Liquid Height for Body SAR

The following table gives the recipes for tissue simulating liquid.

Frequency (MHz)	Water (%)	Sugar (%)	Cellulose (%)	Salt (%)	Preventol (%)	DGBE (%)	Conductivity (σ)	Permittivity (ϵ_r)
For Head								
835	40.3	57.9	0.2	1.4	0.2	0	0.90	41.5
1800, 1900, 2000	55.2	0	0	0.3	0	44.5	1.40	40.0
2450	55.0	0	0	0	0	45.0	1.80	39.2
For Body								
835	50.8	48.2	0	0.9	0.1	0	0.97	55.2
1800, 1900, 2000	70.2	0	0	0.4	0	29.4	1.52	53.3
2450	68.6	0	0	0	0	31.4	1.95	52.7

Table 6.1 Recipes of Tissue Simulating Liquid

Simulating Liquid for 5G, Manufactured by SPEAG

Ingredients	(% by weight)
Water	64~78%
Mineral oil	11~18%
Emulsifiers	9~15%
Additives and Salt	2~3%



The dielectric parameters of the liquids were verified prior to the SAR evaluation using an Agilent 85070D Dielectric Probe Kit and an Agilent Network Analyzer.

The following table shows the measuring results for simulating liquid.

Freq. (MHz)	Liquid Type	Temp. (°C)	Conductivity (σ)	Permittivity (ϵ_r)	Conductivity Target (σ)	Permittivity Target (ϵ_r)	Delta (σ) (%)	Delta (ϵ_r) (%)	Limit (%)	Date
835	Head	21.5	0.929	43.117	0.90	41.5	3.22	3.90	±5	Oct. 13, 2012
835	Body	21.2	0.981	55.337	0.97	55.2	1.13	0.25	±5	Oct. 12, 2012
835	Body	21.3	0.983	55.352	0.97	55.2	1.34	0.28	±5	Oct. 12, 2012
1900	Head	21.4	1.432	39.04	1.40	40.0	2.29	-2.40	±5	Oct. 13, 2012
1900	Body	21.8	1.532	52.328	1.52	53.3	0.79	-1.82	±5	Oct. 12, 2012
2450	Head	21.5	1.811	37.419	1.8	39.2	0.61	-4.54	±5	Oct. 14, 2012
2450	Body	21.2	1.966	52.714	1.95	52.7	0.82	0.03	±5	Oct. 14, 2012
5200	Head	21.5	4.795	35.457	4.66	36	2.90	-1.51	±5	Oct. 08, 2012
5200	Body	21.9	5.279	48.534	5.30	49.0	-0.40	-0.95	±5	Oct. 09, 2012
5500	Head	21.5	5.111	34.97	4.96	35.6	3.04	-1.77	±5	Oct. 08, 2012
5500	Body	21.9	5.717	47.955	5.65	48.6	1.19	-1.33	±5	Oct. 09, 2012

Table 6.2 Measuring Results for Simulating Liquid

7. SAR Measurement Evaluation

Each DASY system is equipped with one or more system validation kits. These units, together with the predefined measurement procedures within the DASY software, enable the user to conduct the system performance check and system validation. System validation kit includes a dipole, tripod holder to fix it underneath the flat phantom and a corresponding distance holder.

7.1 Purpose of System Performance check

The system performance check verifies that the system operates within its specifications. System and operator errors can be detected and corrected. It is recommended that the system performance check be performed prior to any usage of the system in order to guarantee reproducible results. The system performance check uses normal SAR measurements in a simplified setup with a well characterized source. This setup was selected to give a high sensitivity to all parameters that might fail or vary over time. The system check does not intend to replace the calibration of the components, but indicates situations where the system uncertainty is exceeded due to drift or failure.

7.2 System Setup

In the simplified setup for system evaluation, the EUT is replaced by a calibrated dipole and the power source is replaced by a continuous wave that comes from a signal generator. The calibrated dipole must be placed beneath the flat phantom section of the SAM twin phantom with the correct distance holder. The distance holder should touch the phantom surface with a light pressure at the reference marking and be oriented parallel to the long side of the phantom. The equipment setup is shown below:

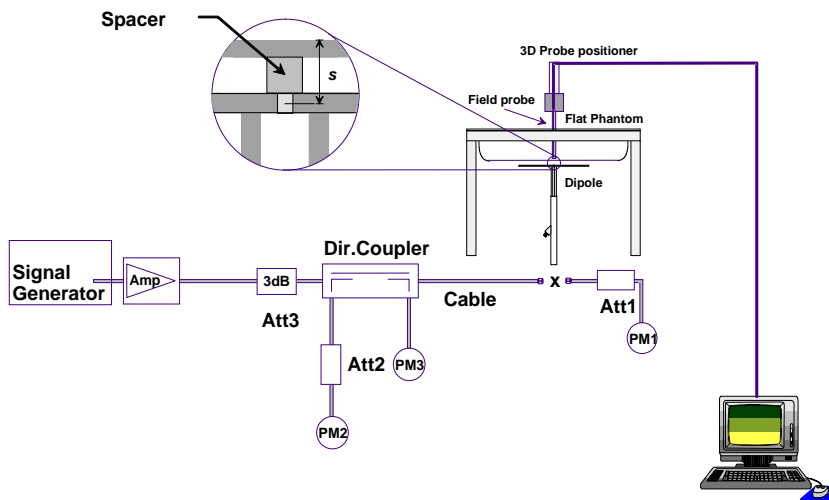

Fig 7.1 System Setup for System Evaluation



Fig 7.2 Photo of Dipole Setup

1. Signal Generator
2. Amplifier
3. Directional Coupler
4. Power Meter
5. Calibrated Dipole

The output power on dipole port must be calibrated to 24 dBm (250 mW) before dipole is connected.



7.3 SAR System Verification Results

Comparing to the original SAR value provided by SPEAG, the verification data should be within its specification of 10 %. Table 7.1 shows the target SAR and measured SAR after normalized to 1W input power. The table below indicates the system performance check can meet the verification criterion and the plots can be referred to Appendix A of this report.

Measurement Date	Frequency (MHz)	Liquid Type	Targeted SAR _{1g} (W/kg)	Measured SAR _{1g} (W/kg)	Normalized SAR _{1g} (W/kg)	Deviation (%)
Oct. 13, 2012	835	Head	9.71	2.54	10.16	4.63
Oct. 12, 2012	835	Body	9.82	2.3	9.20	-6.31
Oct. 12, 2012	835	Body	9.82	2.34	9.36	-4.68
Oct. 13, 2012	1900	Head	39.8	9.21	36.84	-7.44
Oct. 12, 2012	1900	Body	40	9.43	37.72	-5.70
Oct. 14, 2012	2450	Head	54.8	13.3	53.20	-2.92
Oct. 14, 2012	2450	Body	52.3	13.6	54.40	4.02
Oct. 08, 2012	5200	Head	79.2	19.1	76.40	-3.54
Oct. 09, 2012	5200	Body	72.6	16.7	66.80	-7.99
Oct. 08, 2012	5500	Head	85.2	20.3	81.20	-4.69
Oct. 09, 2012	5500	Body	78.8	18.6	74.40	-5.58

Table 7.1 Target and Measurement SAR after Normalized

8. EUT Testing Position

8.1 Define two imaginary lines on the handset

- The vertical centerline passes through two points on the front side of the handset - the midpoint of the width w_t of the handset at the level of the acoustic output, and the midpoint of the width w_b of the bottom of the handset.
- The horizontal line is perpendicular to the vertical centerline and passes through the center of the acoustic output. The horizontal line is also tangential to the face of the handset at point A.
- The two lines intersect at point A. Note that for many handsets, point A coincides with the center of the acoustic output; however, the acoustic output may be located elsewhere on the horizontal line. Also note that the vertical centerline is not necessarily parallel to the front face of the handset, especially for clamshell handsets, handsets with flip covers, and other irregularly shaped handsets.

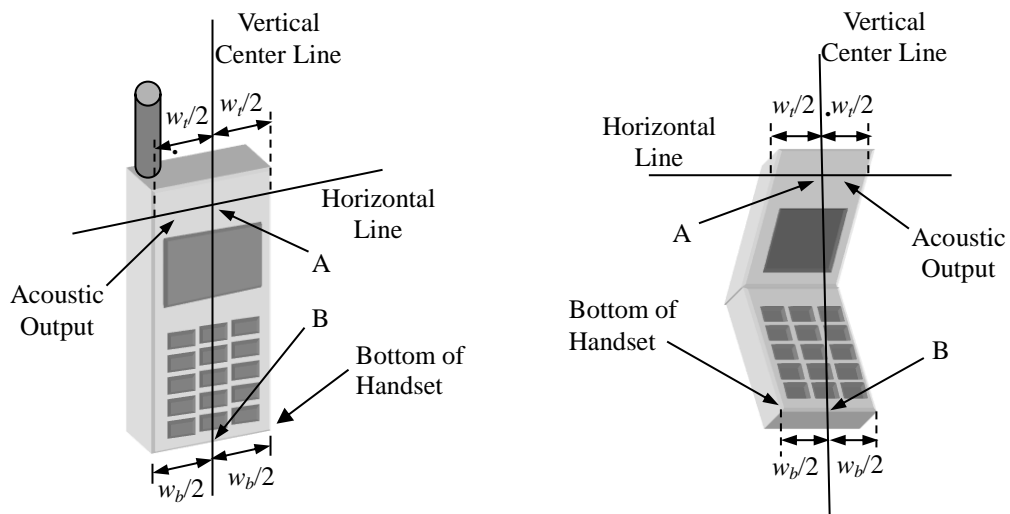

Fig 8.1 Illustration for Handset Vertical and Horizontal Reference Lines

8.2 Cheek Position

- (a) To position the device with the vertical center line of the body of the device and the horizontal line crossing the center piece in a plane parallel to the sagittal plane of the phantom. While maintaining the device in this plane, align the vertical center line with the reference plane containing the three ear and mouth reference point (M: Mouth, RE: Right Ear, and LE: Left Ear) and align the center of the ear piece with the line RE-LE.
- (b) To move the device towards the phantom with the ear piece aligned with the line LE-RE until the phone touched the ear. While maintaining the device in the reference plane and maintaining the phone contact with the ear, move the bottom of the phone until any point on the front side is in contact with the cheek of the phantom or until contact with the ear is lost (see Fig. 8.2).

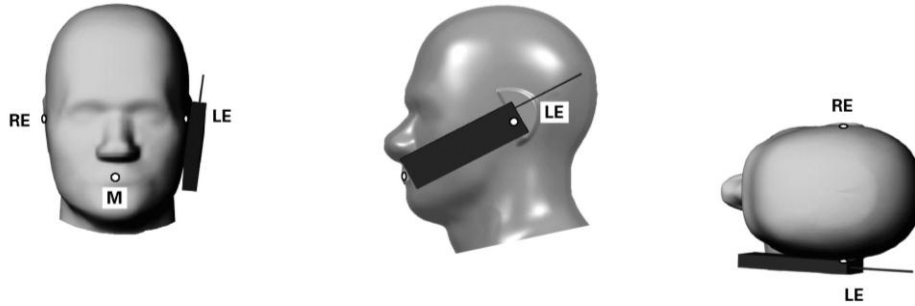

Fig 8.2 Illustration for Cheek Position

8.3 Tilted Position

- (a) To position the device in the “cheek” position described above.
- (b) While maintaining the device the reference plane described above and pivoting against the ear, moves it outward away from the mouth by an angle of 15 degrees or until contact with the ear is lost (see Fig. 8.3).

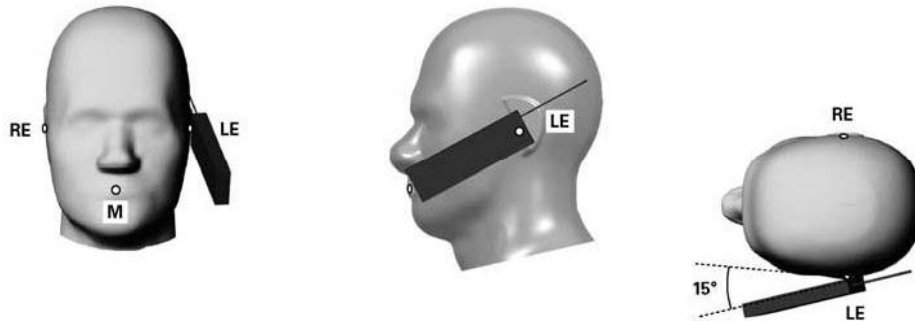

Fig 8.3 Illustration for Tilted Position

8.4 Body Worn Position

- (a) To position the device parallel to the phantom surface with either keypad up or down.
- (b) To adjust the device parallel to the flat phantom.
- (c) To adjust the distance between the device surface and the flat phantom to 1 cm.

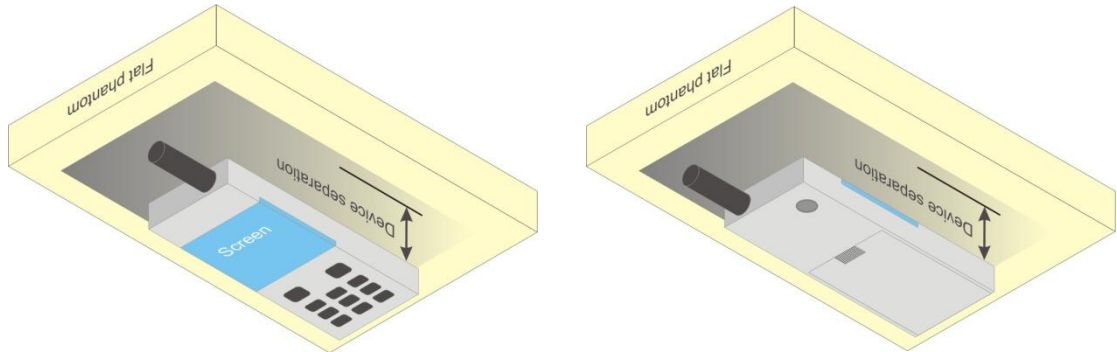

Fig 8.4 Illustration for Body Worn Position

<EUT Setup Photos>

Please refer to Appendix D for the test setup photos.

9. Measurement Procedures

The measurement procedures are as follows:

<Conducted power measurement>

- (a) For WWAN power measurement, use base station simulator to configure EUT WWAN transmission in conducted connection with RF cable, at maximum power in each supported wireless interface and frequency band.
- (b) Read the WWAN RF power level from the base station simulator.
- (c) For WLAN/BT power measurement, use engineering software to configure EUT WLAN/BT continuously transmission, at maximum RF power in each supported wireless interface and frequency band
- (d) Connect EUT RF port through RF cable to the power meter, and measure WLAN/BT output power

<SAR measurement>

- (a) Use base station simulator to configure EUT WWAN transmission in radiated connection, and engineering software to configure EUT WLAN/BT continuously transmission, at maximum RF power, in the highest power channel.
- (b) Place the EUT in the positions as Appendix E demonstrates.
- (c) Set scan area, grid size and other setting on the DASY software.
- (d) Measure SAR results for the highest power channel on each testing position.
- (e) Find out the largest SAR result on these testing positions of each band
- (f) Measure SAR results for other channels in worst SAR testing position if the SAR of highest power channel is larger than 0.8 W/kg

According to the test standard, the recommended procedure for assessing the peak spatial-average SAR value consists of the following steps:

- (a) Power reference measurement
- (b) Area scan
- (c) Zoom scan
- (d) Power drift measurement

9.1 Spatial Peak SAR Evaluation

The procedure for spatial peak SAR evaluation has been implemented according to the test standard. It can be conducted for 1g and 10g, as well as for user-specific masses. The DASY software includes all numerical procedures necessary to evaluate the spatial peak SAR value.

The base for the evaluation is a "cube" measurement. The measured volume must include the 1g and 10g cubes with the highest averaged SAR values. For that purpose, the center of the measured volume is aligned to the interpolated peak SAR value of a previously performed area scan.

The entire evaluation of the spatial peak values is performed within the post-processing engine (SEMCAD). The system always gives the maximum values for the 1g and 10g cubes. The algorithm to find the cube with highest averaged SAR is divided into the following stages:

- (a) Extraction of the measured data (grid and values) from the Zoom Scan
- (b) Calculation of the SAR value at every measurement point based on all stored data (A/D values and measurement parameters)
- (c) Generation of a high-resolution mesh within the measured volume
- (d) Interpolation of all measured values from the measurement grid to the high-resolution grid
- (e) Extrapolation of the entire 3-D field distribution to the phantom surface over the distance from sensor to surface
- (f) Calculation of the averaged SAR within masses of 1g and 10g

9.2 Area & Zoom Scan Procedures

First Area Scan is used to locate the approximate location(s) of the local peak SAR value(s). The measurement grid within an Area Scan is defined by the grid extent, grid step size and grid offset. Next, in order to determine the EM field distribution in a three-dimensional spatial extension, Zoom Scan is required. The Zoom Scan measures 5x5x7 points with step size 8, 8 and 5 mm for 300 MHz to 3 GHz, and 8x8x8 points with step size 4, 4 and 2.5 mm for 3 GHz to 6 GHz. The Zoom Scan is performed around the highest E-field value to determine the averaged SAR-distribution over 10 g.



9.3 Volume Scan Procedures

The volume scan is used to assess overlapping SAR distributions for antennas transmitting in different frequency bands. It is equivalent to an oversized zoom scan used in standalone measurements. The measurement volume will be used to enclose all the simultaneous transmitting antennas. For antennas transmitting simultaneously in different frequency bands, the volume scan is measured separately in each frequency band. In order to sum correctly to compute the 1g aggregate SAR, the EUT remains in the same test position for all measurements and all volume scans use the same spatial resolution and grid spacing (step-size is 4, 4 and 2.5 mm). When all volume scans are completed, the software, SEMCAD postprocessor can combine and subsequently superpose these measurement data to calculate the multiband SAR.

9.4 SAR Averaged Methods

In DASy, the interpolation and extrapolation are both based on the modified Quadratic Shepard's method. The interpolation scheme combines a least-square fitted function method and a weighted average method which are the two basic types of computational interpolation and approximation.

Extrapolation routines are used to obtain SAR values between the lowest measurement points and the inner phantom surface. The extrapolation distance is determined by the surface detection distance and the probe sensor offset. The uncertainty increases with the extrapolation distance. To keep the uncertainty within 1% for the 1 g and 10 g cubes, the extrapolation distance should not be larger than 5 mm.

9.5 Power Drift Monitoring

All SAR testing is under the EUT installed full charged battery and transmit maximum output power. In DASy measurement software, the power reference measurement and power drift measurement procedures are used for monitoring the power drift of EUT during SAR test. Both these procedures measure the field at a specified reference position before and after the SAR testing. The software will calculate the field difference in dB. If the power drifts more than 5%, the SAR will be retested.

10. SAR Test Configurations

10.1 Exposure Positions Consideration

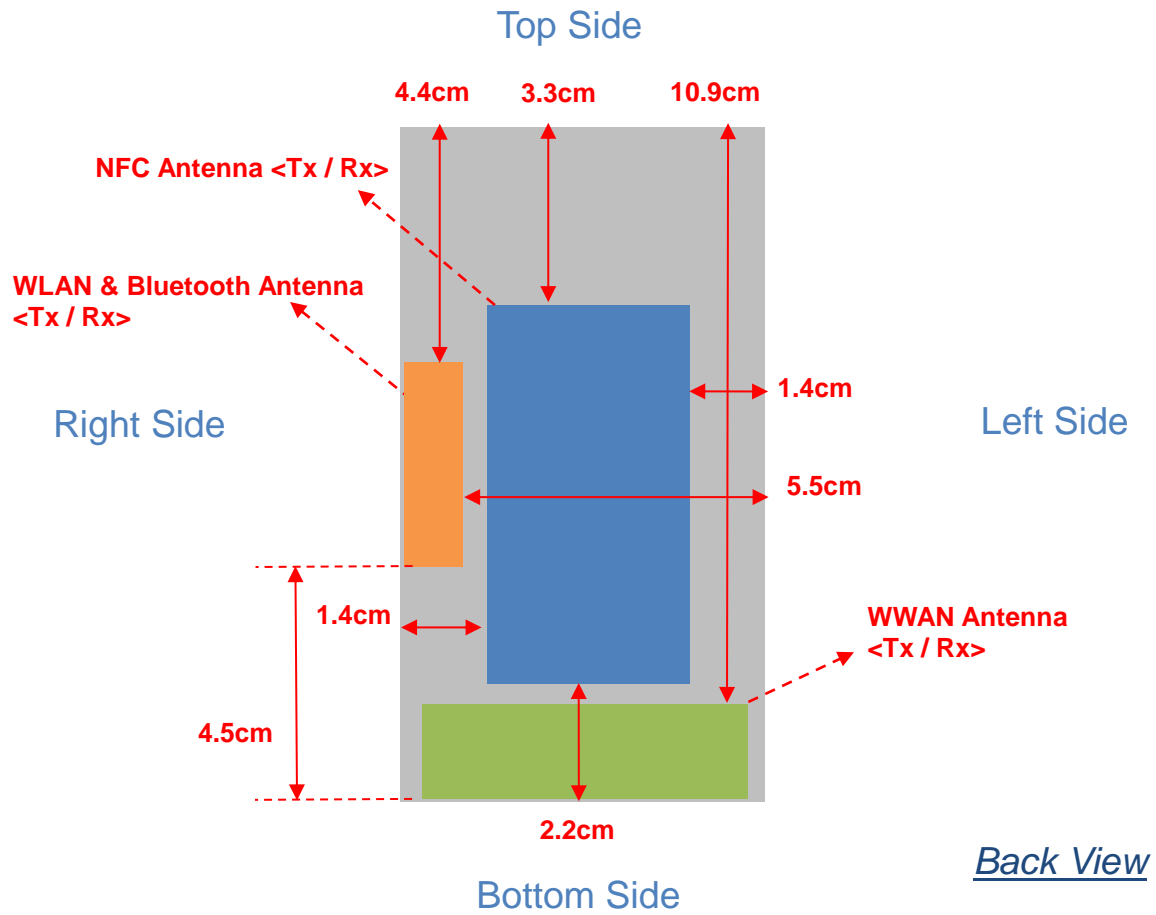

Antennas	Wireless Interface
WWAN Antenna (Tx / Rx)	GSM850 GSM1900 WCDMA Band V WCDMA Band II
BT&WLAN Antenna (Tx / Rx)	WLAN 2.4GHz WLAN 5GHz Bluetooth
NFC Antenna (Tx / Rx)	NFC



Sides for SAR tests; Hotspot mode						
Test distance: 10 mm						
Antennas	Back	Front	Top Side	Bottom Side	Right Side	Left Side
WWAN	YES	YES	NO	YES	YES	YES
BT&WLAN	YES	YES	NO	NO	YES	NO

Note:

1. Head/Body-worn/Hotspot mode SAR assessments are required.
2. Referring to KDB 941225 D06, when the overall device length and width are $\geq 9\text{cm} \times 5\text{cm}$, the test distance is 10 mm. SAR must be measured for all sides and surfaces with a transmitting antenna located within 25mm from that surface or edge.
3. For WWAN antenna, SAR measurements at Top side are not required since the distance between the transmitting antenna and surface of device is $> 25\text{mm}$.
4. For BT&WLAN antenna, SAR measurements Top/Bottom/Left sides are not required since the distance between the transmitting antenna and surface of device is $> 25\text{mm}$.
5. Per KDB 648474 D01, Bluetooth output power $7.03\text{dBm} \leq P_{\text{Ref}}$, while $P_{\text{Ref}} = 10.8\text{dBm}$ and each other antennas SAR is less than 1.2 W/kg, therefore stand-alone SAR is not required.



10.2 Conducted RF Output Power (Unit: dBm)

<GSM Conducted Power>

Band: GSM850		Burst Average Power (dBm)			Frame-Average Power (dBm)		
Channel		128	189	251	128	189	251
Frequency (MHz)		824.2	836.4	848.8	824.2	836.4	848.8
GSM (GMSK, 1 Tx slot)		33.34	33.35	33.37	24.34	24.35	24.37
GPRS (GMSK, 1 Tx slot) – CS1		33.31	33.33	33.35	24.31	24.33	24.35
GPRS (GMSK, 2 Tx slots) – CS1		31.28	31.33	31.38	25.28	25.33	25.38
GPRS (GMSK, 3 Tx slots) – CS1		29.88	29.91	29.93	25.62	25.65	25.67
GPRS (GMSK, 4 Tx slots) – CS1		28.60	28.63	28.69	25.60	25.63	25.69
EDGE (GMSK, 1 Tx slot) – MCS1		33.32	33.31	33.34	24.32	24.31	24.34
EDGE (GMSK, 2 Tx slots) – MCS1		31.27	31.32	31.36	25.27	25.32	25.36
EDGE (GMSK, 3 Tx slots) – MCS1		29.86	29.90	29.93	25.60	25.64	25.67
EDGE (GMSK, 4 Tx slots) – MCS1		28.58	28.61	28.65	25.58	25.61	25.65
EDGE (8PSK, 1 Tx slot) – MCS5		27.60	27.80	27.84	18.60	18.80	18.84
EDGE (8PSK, 2 Tx slots) – MCS5		26.60	26.65	26.68	20.60	20.65	20.68
EDGE (8PSK, 3 Tx slots) – MCS5		26.28	26.40	26.69	22.02	22.14	22.43
EDGE (8PSK, 4 Tx slots) – MCS5		25.26	25.30	25.36	22.26	22.30	22.36
DTM 5	GSM (GMSK, 1 Tx slot)	30.90	30.91	30.92	24.85	24.86	24.87
	GPRS (GMSK, 1 Tx slot) – CS1	30.85	30.86	30.87			
DTM 9	GSM (GMSK, 1 Tx slot)	30.75	30.82	30.85	24.70	24.77	24.80
	GPRS (GMSK, 1 Tx slot) – CS1	30.70	30.77	30.80			
DTM 11	GSM (GMSK, 1 Tx slot)	29.47	29.48	29.55	25.19	25.20	25.27
	GPRS (GMSK, 2 Tx slots) – CS1	29.44	29.45	29.52			
DTM 5	GSM (GMSK, 1 Tx slot)	30.92	31.08	31.19	23.35	23.47	23.59
	EDGE (8PSK, 1 Tx slot) – MCS5	26.94	26.95	27.09			
DTM 9	GSM (GMSK, 1 Tx slot)	30.86	30.87	30.89	23.23	23.24	23.30
	EDGE (8PSK, 1 Tx slot) – MCS5	26.68	26.68	26.85			
DTM 11	GSM (GMSK, 1 Tx slot)	29.55	29.56	29.59	23.45	23.48	23.52
	EDGE (8PSK, 2 Tx slots) – MCS5	26.37	26.42	26.48			

Remark: The frame-averaged power is linearly scaled the maximum burst averaged power over 8 time slots.
The calculated method are shown as below:
Frame-averaged power = Maximum burst averaged power (1 Tx Slot) - 9 dB
Frame-averaged power = Maximum burst averaged power (2 Tx Slots) - 6 dB
Frame-averaged power = Maximum burst averaged power (3 Tx Slots) - 4.26 dB
Frame-averaged power = Maximum burst averaged power (4 Tx Slots) - 3 dB

Note:

1. For Head SAR testing, GSM and DTM should be evaluated, therefore the EUT was set in DTM Multi-slot class 11 for GSM850 due to its highest frame-average power.
2. For Body-worn SAR testing, GSM, GPRS, EDGE and DTM should be evaluated, therefore the EUT was set in GPRS 4 Tx slots for GSM850 due to its highest frame-average power.
3. For Body SAR testing, GSM and DTM should be evaluated, therefore the EUT was set in DTM Multi-slot class 11 for GSM850 due to its highest frame-average power.
4. Per KDB 648474, the maximum output power channel is used for SAR testing and for further SAR test reduction.



Band: GSM1900		Burst Average Power (dBm)			Frame-Average Power (dBm)		
Channel		512	661	810	512	661	810
Frequency (MHz)		1850.2	1880.0	1909.8	1850.2	1880.0	1909.8
GSM (GMSK, 1 Tx slot)		29.44	29.36	29.67	20.44	20.36	20.67
GPRS (GMSK, 1 Tx slot) – CS1		29.40	29.32	29.65	20.40	20.32	20.65
GPRS (GMSK, 2 Tx slots) – CS1		27.41	27.33	27.58	21.41	21.33	21.58
GPRS (GMSK, 3 Tx slots) – CS1		26.46	26.50	26.64	22.20	22.24	22.38
GPRS (GMSK, 4 Tx slots) – CS1		25.58	25.45	25.59	22.58	22.45	22.59
EDGE (GMSK, 1 Tx slot) – MCS1		29.17	29.13	29.23	20.17	20.13	20.23
EDGE (GMSK, 2 Tx slots) – MCS1		27.30	27.21	27.40	21.30	21.21	21.40
EDGE (GMSK, 3 Tx slots) – MCS1		26.44	26.49	26.62	22.18	22.23	22.36
EDGE (GMSK, 4 Tx slots) – MCS1		25.56	25.44	25.57	22.56	22.44	22.57
EDGE (8PSK, 1 Tx slot) – MCS5		25.33	25.23	25.36	16.33	16.23	16.36
EDGE (8PSK, 2 Tx slots) – MCS5		24.27	24.24	24.38	18.27	18.24	18.38
EDGE (8PSK, 3 Tx slots) – MCS5		23.12	23.06	23.15	18.86	18.80	18.89
EDGE (8PSK, 4 Tx slots) – MCS5		22.00	21.93	22.08	19.00	18.93	19.08
DTM 5	GSM (GMSK, 1 Tx slot)	26.99	26.98	27.02	20.90	20.86	20.91
	GPRS (GMSK, 1 Tx slot) – CS1	26.84	26.77	26.84			
DTM 9	GSM (GMSK, 1 Tx slot)	26.94	26.93	26.96	20.84	20.81	20.86
	GPRS (GMSK, 1 Tx slot) – CS1	26.78	26.72	26.79			
DTM 11	GSM (GMSK, 1 Tx slot)	26.04	25.99	26.17	21.67	21.60	21.82
	GPRS (GMSK, 2 Tx slots) – CS1	25.88	25.80	26.04			
DTM 5	GSM (GMSK, 1 Tx slot)	26.96	26.93	27.04	19.82	19.77	19.88
	EDGE (8PSK, 1 Tx slot) – MCS5	24.34	24.23	24.35			
DTM 9	GSM (GMSK, 1 Tx slot)	26.90	26.87	26.96	19.71	19.67	19.77
	EDGE (8PSK, 1 Tx slot) – MCS5	24.13	24.08	24.19			
DTM 11	GSM (GMSK, 1 Tx slot)	26.01	25.98	26.10	19.95	19.92	20.02
	EDGE (8PSK, 2 Tx slots) – MCS5	22.92	22.89	22.97			

Remark: The frame-averaged power is linearly scaled the maximum burst averaged power over 8 time slots.
The calculated method are shown as below:
Frame-averaged power = Maximum burst averaged power (1 Tx Slot) - 9 dB
Frame-averaged power = Maximum burst averaged power (2 Tx Slots) - 6 dB
Frame-averaged power = Maximum burst averaged power (3 Tx Slots) - 4.26 dB
Frame-averaged power = Maximum burst averaged power (4 Tx Slots) - 3 dB

Note:

1. For Head SAR testing, GSM and DTM should be evaluated, therefore the EUT was set in DTM Multi-slot class 11 for GSM1900 due to its highest frame-average power.
2. For Body-worn SAR testing, GSM, GPRS, EDGE and DTM should be evaluated, therefore the EUT was set in GPRS 4 Tx slots for GSM1900 due to its highest frame-average power.
3. For Body SAR testing, GSM and DTM should be evaluated, therefore the EUT was set in DTM Multi-slot class 11 for GSM1900 due to its highest frame-average power.
4. Per KDB 648474, the maximum output power channel is used for SAR testing and for further SAR test reduction.

<WCDMA Conducted Power>

The following tests were conducted according to the test requirements outlines in 3GPP TS 34.121 specification. A summary of these settings are illustrated below:

HSDPA Setup Configuration:

- a. The EUT was connected to Base Station referred to the drawing of Setup Configuration.
- b. The RF path losses were compensated into the measurements.
- c. A call was established between EUT and Base Station with following setting:
 - i. Set Gain Factors (β_c and β_d) and parameters were set according to each
 - ii. Specific sub-test in the following table, C10.1.4, quoted from the TS 34.121
 - iii. Set RMC 12.2Kbps + HSDPA mode.
 - iv. Set Cell Power = -86 dBm
 - v. Set HS-DSCH Configuration Type to FRC (H-set 1, QPSK)
 - vi. Select HSDPA Uplink Parameters
 - vii. Set Delta ACK, Delta NACK and Delta CQI = 8
 - viii. Set Ack-Nack Repetition Factor to 3
 - ix. Set CQI Feedback Cycle (k) to 4 ms
 - x. Set CQI Repetition Factor to 2
 - xi. Power Ctrl Mode = All Up bits
- d. The transmitted maximum output power was recorded.

Table C.10.1.4: β values for transmitter characteristics tests with HS-DPCCH

Sub-test	β_c	β_d	β_d (SF)	β_c/β_d	β_{HS} (Note 1, Note 2)	CM (dB) (Note 3)	MPR (dB) (Note 3)
1	2/15	15/15	64	2/15	4/15	0.0	0.0
2	12/15 (Note 4)	15/15 (Note 4)	64	12/15 (Note 4)	24/15	1.0	0.0
3	15/15	8/15	64	15/8	30/15	1.5	0.5
4	15/15	4/15	64	15/4	30/15	1.5	0.5

Note 1: $\Delta_{ACK}, \Delta_{NACK}$ and $\Delta_{CQI} = 30/15$ with $\beta_{HS} = 30/15 * \beta_c$.

Note 2: For the HS-DPCCH power mask requirement test in clause 5.2C, 5.7A, and the Error Vector Magnitude (EVM) with HS-DPCCH test in clause 5.13.1A, and HSDPA EVM with phase discontinuity in clause 5.13.1AA, Δ_{ACK} and $\Delta_{NACK} = 30/15$ with $\beta_{HS} = 30/15 * \beta_c$, and $\Delta_{CQI} = 24/15$ with $\beta_{HS} = 24/15 * \beta_c$.

Note 3: CM = 1 for $\beta_c/\beta_d = 12/15, \beta_{HS}/\beta_c = 24/15$. For all other combinations of DPDCH, DPCCH and HS-DPCCH the MPR is based on the relative CM difference. This is applicable for only UEs that support HSDPA in release 6 and later releases.

Note 4: For subtest 2 the β_c/β_d ratio of 12/15 for the TFC during the measurement period (TF1, TF0) is achieved by setting the signalled gain factors for the reference TFC (TF1, TF1) to $\beta_c = 11/15$ and $\beta_d = 15/15$.

Setup Configuration

HSUPA Setup Configuration:

- a. The EUT was connected to Base Station referred to the drawing of Setup Configuration.
- b. The RF path losses were compensated into the measurements.
- c. A call was established between EUT and Base Station with following setting * :
 - i. Call Configs = 5.2B, 5.9B, 5.10B, and 5.13.2B with QPSK
 - ii. Set the Gain Factors (β_c and β_d) and parameters (AG Index) were set according to each specific sub-test in the following table, C11.1.3, quoted from the TS 34.121
 - iii. Set Cell Power = -86 dBm
 - iv. Set Channel Type = 12.2k + HSPA
 - v. Set UE Target Power
 - vi. Power Ctrl Mode= Alternating bits
 - vii. Set and observe the E-TFCl
 - viii. Confirm that E-TFCl is equal to the target E-TFCl of 75 for sub-test 1, and other subtest's E-TFCl
- d. The transmitted maximum output power was recorded.

Table C.11.1.3: β values for transmitter characteristics tests with HS-DPCCH and E-DCH

Sub-test	β_c	β_d	β_d (SF)	β_c/β_d	β_{HS} (Note 1)	β_{ec}	β_{ed} (Note 5) (Note 6)	β_{ed} (SF)	β_{ed} (Codes)	CM (dB) (Note 2)	MPR (dB) (Note 2)	AG Index (Note 6)	E-TFCl
1	11/15 (Note 3)	15/15 (Note 3)	64	11/15 (Note 3)	22/15	209/225	1309/225	4	1	1.0	0.0	20	75
2	6/15	15/15	64	6/15	12/15	12/15	94/75	4	1	3.0	2.0	12	67
3	15/15	9/15	64	15/9	30/15	30/15	$\beta_{ed1}: 47/15$ $\beta_{ed2}: 47/15$	4	2	2.0	1.0	15	92
4	2/15	15/15	64	2/15	4/15	2/15	56/75	4	1	3.0	2.0	17	71
5	15/15 (Note 4)	15/15 (Note 4)	64	15/15 (Note 4)	30/15	24/15	134/15	4	1	1.0	0.0	21	81

Note 1: $\Delta_{ACK}, \Delta_{NACK}$ and $\Delta_{CQI} = 30/15$ with $\beta_{hs} = 30/15 * \beta_c$.

Note 2: CM = 1 for $\beta_c/\beta_d = 12/15, \beta_{hs}/\beta_c = 24/15$. For all other combinations of DPDCH, DPCCH, HS-DPCCH, E-DPDCH and E-DPCCH the MPR is based on the relative CM difference.

Note 3: For subtest 1 the β_c/β_d ratio of 11/15 for the TFC during the measurement period (TF1, TF0) is achieved by setting the signalled gain factors for the reference TFC (TF1, TF1) to $\beta_c = 10/15$ and $\beta_d = 15/15$.

Note 4: For subtest 5 the β_c/β_d ratio of 15/15 for the TFC during the measurement period (TF1, TF0) is achieved by setting the signalled gain factors for the reference TFC (TF1, TF1) to $\beta_c = 14/15$ and $\beta_d = 15/15$.

Note 5: In case of testing by UE using E-DPDCH Physical Layer category 1, Sub-test 3 is omitted according to TS25.306 Table 5.1g.

Note 6: β_{ed} can not be set directly, it is set by Absolute Grant Value.

Setup Configuration

DC-HSDPA 3GPP release 8 Setup Configuration:

- a. The EUT was connected to Base Station referred to the drawing of Setup Configuration.
- b. The RF path losses were compensated into the measurements.
- c. A call was established between EUT and Base Station with following setting:
 - i. Set RMC 12.2Kbps + HSDPA mode.
 - ii. Set Cell Power = -25 dBm
 - iii. Set HS-DSCH Configuration Type to FRC (H-set 12, QPSK)
 - iv. Select HSDPA Uplink Parameters
 - v. Set Gain Factors (β_c and β_d) and parameters were set according to each Specific sub-test in the following table, C10.1.4, quoted from the TS 34.121
 - a). Subtest 1: $\beta_c/\beta_d=2/15$
 - b). Subtest 2: $\beta_c/\beta_d=12/15$
 - c). Subtest 3: $\beta_c/\beta_d=15/8$
 - d). Subtest 4: $\beta_c/\beta_d=15/4$
 - vi. Set Delta ACK, Delta NACK and Delta CQI = 8
 - vii. Set Ack-Nack Repetition Factor to 3
 - viii. Set CQI Feedback Cycle (k) to 4 ms
 - ix. Set CQI Repetition Factor to 2
 - x. Power Ctrl Mode = All Up bits
- d. The transmitted maximum output power was recorded.

The following tests were conducted according to the test requirements outlines in 3GPP TS 34.121 specification. A summary of these settings are illustrated below:

C.8.1.12 Fixed Reference Channel Definition H-Set 12

Table C.8.1.12: Fixed Reference Channel H-Set 12

Parameter	Unit	Value
Nominal Avg. Inf. Bit Rate	kbps	60
Inter-TTI Distance	TTI's	1
Number of HARQ Processes	Processes	6
Information Bit Payload (N_{INF})	Bits	120
Number Code Blocks	Blocks	1
Binary Channel Bits Per TTI	Bits	960
Total Available SML's in UE	SML's	19200
Number of SML's per HARQ Proc.	SML's	3200
Coding Rate		0.15
Number of Physical Channel Codes	Codes	1
Modulation		QPSK
Note 1: The RMC is intended to be used for DC-HSDPA mode and both cells shall transmit with identical parameters as listed in the table.		
Note 2: Maximum number of transmission is limited to 1, i.e., retransmission is not allowed. The redundancy and constellation version 0 shall be used.		

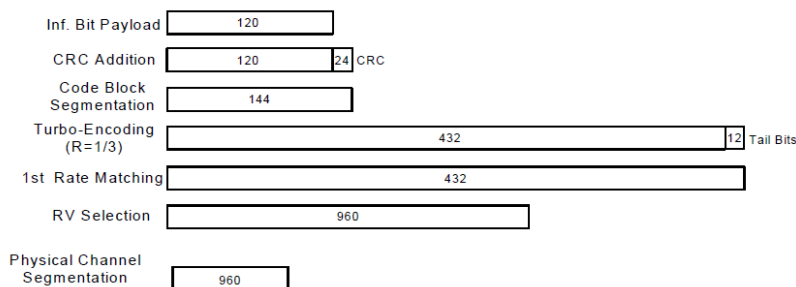

Figure C.8.19: Coding rate for Fixed reference Channel H-Set 12 (QPSK)

Setup Configuration



WCDMA Average power (dBm)							
Band		WCDMA Band V			WCDMA Band II		
Channel		4132	4182	4233	9262	9400	9538
Frequency (MHz)		826.4	836.4	846.6	1852.4	1880.0	1907.6
3GPP Rel 99	AMR 12.2K	23.34	23.48	23.52	23.28	23.32	23.31
3GPP Rel 99	RMC 12.2K	23.35	23.51	23.56	23.30	23.34	23.32
3GPP Rel 6	HSDPA Subtest-1	22.56	22.63	22.68	22.22	22.39	22.38
3GPP Rel 6	HSDPA Subtest-2	22.48	22.50	22.59	22.20	22.42	22.31
3GPP Rel 6	HSDPA Subtest-3	22.03	22.04	22.13	21.78	21.92	21.90
3GPP Rel 6	HSDPA Subtest-4	21.98	22.05	22.09	21.76	21.89	21.87
3GPP Rel 8	DC-HSDPA Subtest-1	22.33	22.38	22.42	22.18	22.36	22.38
3GPP Rel 8	DC-HSDPA Subtest-2	22.46	22.47	22.56	22.23	22.38	22.33
3GPP Rel 8	DC-HSDPA Subtest-3	22.00	22.01	22.11	21.78	21.88	21.88
3GPP Rel 8	DC-HSDPA Subtest-4	21.95	22.01	22.08	21.75	21.86	21.85
3GPP Rel 6	HSUPA Subtest-1	22.48	22.50	22.58	22.07	22.32	22.30
3GPP Rel 6	HSUPA Subtest-2	20.95	21.05	21.22	21.00	21.18	21.16
3GPP Rel 6	HSUPA Subtest-3	20.86	21.02	21.15	21.33	21.53	21.48
3GPP Rel 6	HSUPA Subtest-4	21.10	21.40	21.28	20.96	21.05	21.00
3GPP Rel 6	HSUPA Subtest-5	22.41	22.50	22.59	22.05	22.37	22.34

MPR (dB)								
3GPP MPR	Subtest		WCDMA Band V			WCDMA Band II		
0	3GPP Rel 6	HSDPA Subtest-1	0.00	0.00	0.00	0.00	0.00	0.00
0	3GPP Rel 6	HSDPA Subtest-2	0.08	0.13	0.09	0.02	-0.03	0.07
≤ 0.5	3GPP Rel 6	HSDPA Subtest-3	0.53	0.59	0.55	0.44	0.47	0.48
≤ 0.5	3GPP Rel 6	HSDPA Subtest-4	0.58	0.58	0.59	0.46	0.50	0.51
0	3GPP Rel 8	DC-HSDPA Subtest-1	0.00	0.00	0.00	0.00	0.00	0.00
0	3GPP Rel 8	DC-HSDPA Subtest-2	-0.13	-0.09	-0.14	-0.05	-0.02	0.05
≤ 0.5	3GPP Rel 8	DC-HSDPA Subtest-3	0.33	0.37	0.31	0.40	0.48	0.50
≤ 0.5	3GPP Rel 8	DC-HSDPA Subtest-4	0.38	0.37	0.34	0.43	0.50	0.53
0	3GPP Rel 6	HSUPA Subtest-1	-0.07	0.00	0.01	-0.02	0.05	0.04
≤ 2	3GPP Rel 6	HSUPA Subtest-2	1.46	1.45	1.37	1.05	1.19	1.18
≤ 1	3GPP Rel 6	HSUPA Subtest-3	1.55	1.48	1.44	0.72	0.84	0.86
≤ 2	3GPP Rel 6	HSUPA Subtest-4	1.31	1.10	1.31	1.09	1.32	1.34
0	3GPP Rel 6	HSUPA Subtest-5	0.00	0.00	0.00	0.00	0.00	0.00

Note:

- Applying the subtest setup in 3GPP TS 34.121-1 specification.
- For Head SAR, per KDB 941225 D01, RMC 12.2kbps setting is used to evaluate SAR. If AMR 12.2kbps power is < 0.25dB higher than RMC 12.2kbps, SAR tests with AMR 12.2kbps can be excluded.
- For Body-worn and hotspot SAR, per KDB 941225 D01, RMC 12.2kbps setting is used to evaluate SAR. If HSDPA/HSUPA output power is < 0.25dB higher than RMC, or SAR with RMC 12.2kbps setting is ≤ 1.2W/kg, HSDPA/HSUPA SAR evaluation can be excluded. DC-HSDPA 4 subtests SAR test exclusion follows HSPA procedure in KDB 941225 D01
- By design, AMR, HSDPA/HSUPA RF power will not be larger than RMC 12.2kbps, detailed information is included in Tune-up Procure exhibit.
- It is expected by the manufacturer that MPR for some HSDPA/HSUPA, subtests may differ from the specification of 3GPP, according to the chipset implementation in this model. The implementation and expected deviation are detailed in tune-up procedure exhibit.



<WLAN 2.4GHz Conducted Power>

WLAN 2.4G 802.11b Average Power (dBm)						
Power vs. Channel			Power vs. Data Rate			
Channel	Frequency (MHz)	Data Rate (bps)	Channel	Data Rate (bps)		
		1M		2M	5.5M	11M
CH 01	2412	17.98	CH 11	18.12	18.12	18.11
CH 06	2437	18.02				
CH 11	2462	18.13				

WLAN 2.4G 802.11g Average Power (dBm)										
Power vs. Channel			Power vs. Data Rate							
Channel	Frequency (MHz)	Data Rate (bps)	Channel	Data Rate (bps)						
		6M		9M	12M	18M	24M	36M	48M	54M
CH 01	2412	12.19	CH 6	12.23	12.23	12.27	12.27	12.26	12.27	12.26
CH 06	2437	12.28								
CH 11	2462	12.04								

WLAN 2.4G 802.11n (BW 20MHz) Average Power (dBm)										
Power vs. Channel			Power vs. Data Rate							
Channel	Frequency (MHz)	MCS Index	Channel	MCS Index						
		MCS0		MCS1	MCS2	MCS3	MCS4	MCS5	MCS6	MCS7
CH 01	2412	12.23	CH 6	12.20	12.21	12.25	12.24	12.24	12.24	12.24
CH 06	2437	12.26								
CH 11	2462	12.16								

WLAN 2.4G 802.11n (BW 40MHz) Average Power (dBm)										
Power vs. Channel			Power vs. Data Rate							
Channel	Frequency (MHz)	Data Rate (bps)	Channel	MCS Index						
		MCS0		MCS1	MCS2	MCS3	MCS4	MCS5	MCS6	MCS7
CH 03	2422	12.23	CH 6	12.20	12.21	12.25	12.24	12.24	12.24	12.24
CH 06	2437	12.26								
CH 09	2452	12.16								

Note:

1. Per KDB 248227, choose the highest output power channel to test SAR and determine further SAR exclusion
2. Per KDB 248227, 11g, 11n-HT20 and 11n-HT40 output power is less than 0.25dB higher than 11b mode, thus the SAR can be excluded.
3. For each frequency band, testing at higher data rates and higher order modulations is not required when the maximum average output power for each of these configurations is less than 0.25dB higher than those measured at the lowest data rate. 2.4GHz WLAN SAR was tested on 802.11b 1Mbps



<Bluetooth Conducted Power>

Channel	Frequency (MHz)	Average power (dBm)		
		Mode		
		GFSK	$\pi/4$ -DQPSK	8-DPSK
CH 0	2402	6.28	2.13	2.11
CH 39	2441	7.03	3.06	3.05
CH 78	2480	5.44	1.70	1.70

Channel	Frequency (MHz)	Average power (dBm)
		Mode
		BT v4.0 LE, GFSK
CH 0	2402	1.16
CH 19	2440	2.77
CH 39	2480	1.80

<WLAN 5GHz Conducted Power>

WLAN 5G 802.11a Average Power (dBm)										
Power vs. Channel			Power vs. Data Rate							
Channel	Frequency (MHz)	Data Rate (bps)	Channel	Data Rate (bps)						
		6M		9M	12M	18M	24M	36M	48M	54M
CH 36	5180	12.44	CH 36	12.42	12.43	12.43	12.11	12.42	12.42	12.43
CH 40	5200	12.33								
CH 44	5220	12.26								
CH 48	5240	12.21								
CH 52	5260	12.18	CH 52	12.17	12.17	12.16	12.14	12.15	12.16	12.10
CH 56	5280	12.15								
CH 60	5300	12.17								
CH 64	5320	12.12								
CH 100	5500	12.29								
CH 104	5520	12.28	CH 100	12.28	12.28	12.25	12.25	12.24	12.25	12.26
CH 108	5540	12.27								
CH 112	5560	12.18								
CH 116	5580	12.16								
CH 132	5660	12.12								
CH 136	5680	12.22								
CH 140	5700	12.21								



WLAN 5G 802.11n (BW 20M) Average Power (dBm)										
Power vs. Channel			Power vs. Data Rate							
Channel	Frequency (MHz)	MCS Index	Channel	MCS Index						
		MCS0		MCS1	MCS2	MCS3	MCS4	MCS5	MCS6	MCS7
CH 36	5180	12.46	CH 36	12.43	12.44	12.44	12.42	12.45	12.44	12.42
CH 40	5200	12.43								
CH 44	5220	12.27								
CH 48	5240	12.19								
CH 52	5260	12.25	CH 60	12.25	12.24	12.24	12.26	12.30	12.28	12.30
CH 56	5280	12.27								
CH 60	5300	12.31								
CH 64	5320	12.20								
CH 100	5500	12.30	CH 100	12.29	12.26	12.27	12.26	12.29	12.29	12.27
CH 104	5520	12.28								
CH 108	5540	12.28								
CH 112	5560	12.20								
CH 116	5580	12.23								
CH 132	5660	12.16								
CH 136	5680	12.28								
CH 140	5700	12.19								

WLAN 5G 802.11n (BW 40M) Average Power (dBm)										
Power vs. Channel			Power vs. Data Rate							
Channel	Frequency (MHz)	MCS Index	Channel	MCS Index						
		MCS0		MCS1	MCS2	MCS3	MCS4	MCS5	MCS6	MCS7
CH 38	5190	10.18	CH 46	11.80	11.79	11.77	11.85	11.85	11.76	11.85
CH 46	5230	11.87								
CH 54	5270	11.66	CH 62	11.73	11.73	11.74	11.74	11.72	11.74	11.73
CH 62	5310	11.75								
CH 102	5510	12.05	CH 102	12.03	12.03	12.04	12.03	12.02	12.02	12.04
CH 110	5550	11.97								
CH 134	5670	11.95								

Note:

1. Per KDB 248227, choose the highest output power channel to test SAR and determine further SAR exclusion
2. Per KDB 248227, 11n-HT20 and 11n-HT40 output power is less than 0.25dB higher than 11a mode, thus the SAR can be excluded.
3. For each frequency band, testing at higher data rates and higher order modulations is not required when the maximum average output power for each of these configurations is less than 0.25dB higher than those measured at the lowest data rate. 5GHz WLAN SAR was tested on 802.11a 6Mbps



11. SAR Test Results

11.1 Test Records for Head SAR Test

<GSM SAR>

Plot No.	Band	Mode	Test Position	Ch.	Freq. (MHz)	Burst Average Power (dBm)	Power Drift (dB)	SAR _{1g} (W/kg)	SAR _{10g} (W/kg)
60	GSM850	DTM Multi-slot class 11	Right Cheek	251	848.8	29.55	0.03	0.26	0.199
63	GSM850	DTM Multi-slot class 11	Right Tilted	251	848.8	29.55	0.08	0.179	0.131
61	GSM850	DTM Multi-slot class 11	Left Cheek	251	848.8	29.55	0.18	0.267	0.201
62	GSM850	DTM Multi-slot class 11	Left Tilted	251	848.8	29.55	-0.06	0.177	0.136
48	GSM1900	DTM Multi-slot class 11	Right Cheek	810	1909.8	26.17	-0.137	0.212	0.133
49	GSM1900	DTM Multi-slot class 11	Right Tilted	810	1909.8	26.17	-0.04	0.102	0.059
50	GSM1900	DTM Multi-slot class 11	Left Cheek	810	1909.8	26.17	-0.154	0.199	0.124
51	GSM1900	DTM Multi-slot class 11	Left Tilted	810	1909.8	26.17	0.05	0.103	0.062

Note: Per KDB 648474 D01v01, if the highest output channel SAR for each exposure position ≤ 0.8 W/kg other channels SAR tests are not necessary.

<WCDMA SAR>

Plot No.	Band	Mode	Test Position	Ch.	Freq. (MHz)	Average Power (dBm)	Power Drift (dB)	SAR _{1g} (W/kg)	SAR _{10g} (W/kg)
56	WCDMA V	RMC12.2K	Right Cheek	4233	846.6	23.56	0.08	0.34	0.259
57	WCDMA V	RMC12.2K	Right Tilted	4233	846.6	23.56	0.01	0.22	0.17
58	WCDMA V	RMC12.2K	Left Cheek	4233	846.6	23.56	0.05	0.324	0.247
59	WCDMA V	RMC12.2K	Left Tilted	4233	846.6	23.56	-0.01	0.208	0.161
52	WCDMA II	RMC12.2K	Right Cheek	9400	1880	23.34	-0.06	0.591	0.377
53	WCDMA II	RMC12.2K	Right Tilted	9400	1880	23.34	0.03	0.315	0.186
54	WCDMA II	RMC12.2K	Left Cheek	9400	1880	23.34	-0.11	0.613	0.38
55	WCDMA II	RMC12.2K	Left Tilted	9400	1880	23.34	0	0.355	0.22

Note: Per KDB 648474 D01v01, if the highest output channel SAR for each exposure position ≤ 0.8 W/kg other channels SAR tests are not necessary.

<WLAN SAR>

Plot No.	Band	Mode	Test Position	Ch.	Freq. (MHz)	Average Power (dBm)	Power Drift (dB)	SAR _{1g} (W/kg)	SAR _{10g} (W/kg)
64	WLAN2.4G	802.11b	Right Cheek	11	2462	18.13	0.01	0.322	0.154
65	WLAN2.4G	802.11b	Right Tilted	11	2462	18.13	0.17	0.062	0.029
66	WLAN2.4G	802.11b	Left Cheek	11	2462	18.13	-0.137	0.248	0.119
67	WLAN2.4G	802.11b	Left Tilted	11	2462	18.13	0.13	0.052	0.026
1	WLAN5G	802.11a	Right Cheek	36	5180	12.44	0.001	0.048	0.014
2	WLAN5G	802.11a	Right Tilted	36	5180	12.44	-0.196	0.000884	0.000156
3	WLAN5G	802.11a	Left Cheek	36	5180	12.44	0.189	0.035	0.011
4	WLAN5G	802.11a	Left Tilted	36	5180	12.44	0.007	0.01	0.00138
5	WLAN5G	802.11a	Right Cheek	56	5280	12.15	0.145	0.065	0.019
6	WLAN5G	802.11a	Right Tilted	56	5280	12.15	0.003	0.00588	0.0017
7	WLAN5G	802.11a	Left Cheek	56	5280	12.15	0.009	0.056	0.02
8	WLAN5G	802.11a	Left Tilted	56	5280	12.15	0.01	0.014	0.00191
9	WLAN5G	802.11a	Right Cheek	100	5500	12.29	-0.079	0.043	0.014
10	WLAN5G	802.11a	Right Tilted	100	5500	12.29	-0.111	0.00445	0.000701
11	WLAN5G	802.11a	Left Cheek	100	5500	12.29	-0.007	0.029	0.01
12	WLAN5G	802.11a	Left Tilted	100	5500	12.29	0.07	0.015	0.00275

Note: Per 648474 D01v01, if the highest output channel SAR for each exposure position ≤ 0.8 W/kg other channels SAR tests are not necessary.

11.2 Test Records for Hotspot SAR Test

<GSM SAR>

Plot No.	Band	Mode	Test Position	Gap (cm)	Ch.	Freq. (MHz)	Burst Average Power (dBm)	Power Drift (dB)	SAR _{1g} (W/kg)	SAR _{10g} (W/kg)
34	GSM850	GPRS (4 Tx slots)	Front	1	251	848.8	28.69	-0.05	0.298	0.244
35	GSM850	GPRS (4 Tx slots)	Back	1	251	848.8	28.69	-0.08	0.759	0.603
37	GSM850	GPRS (4 Tx slots)	Left Side	1	251	848.8	28.69	0.01	0.26	0.192
38	GSM850	GPRS (4 Tx slots)	Right Side	1	251	848.8	28.69	-0.03	0.263	0.194
39	GSM850	GPRS (4 Tx slots)	Bottom Side	1	251	848.8	28.69	-0.11	0.066	0.042
22	GSM1900	GPRS (4 Tx slots)	Front	1	810	1909.8	25.59	-0.12	0.304	0.179
23	GSM1900	GPRS (4 Tx slots)	Back	1	810	1909.8	25.59	0.1	0.347	0.214
24	GSM1900	GPRS (4 Tx slots)	Right Side	1	810	1909.8	25.59	-0.024	0.062	0.037
25	GSM1900	GPRS (4 Tx slots)	Left Side	1	810	1909.8	25.59	-0.04	0.117	0.066
26	GSM1900	GPRS (4 Tx slots)	Bottom Side	1	810	1909.8	25.59	-0.07	0.222	0.124

Note:

- Per KDB 941225 D06, for EUT dimension $\geq 9\text{cm} \times 5\text{cm}$, the test distance is 1cm. SAR must be measured for all surfaces and sides with a transmitting antenna located within 2.5cm from that surface or edge.
- As in (1), SAR for Front / Back / Bottom Side / Left Side / Right Side is necessary.
- Per 648474 D01v01 if the highest output channel SAR for each exposure position ≤ 0.8 W/kg other channels SAR tests are not necessary.

<WCDMA SAR>

Plot No.	Band	Mode	Test Position	Gap (cm)	Ch.	Freq. (MHz)	Average Power (dBm)	Power Drift (dB)	SAR _{1g} (W/kg)	SAR _{10g} (W/kg)
40	WCDMA V	RMC12.2K	Front	1	4233	846.6	23.56	-0.1	0.443	0.36
41	WCDMA V	RMC12.2K	Back	1	4233	846.6	23.56	-0.1	0.925	0.742
42	WCDMA V	RMC12.2K	Back	1	4132	826.4	23.35	0.03	0.696	0.552
43	WCDMA V	RMC12.2K	Back	1	4182	836.4	23.51	0	0.897	0.719
44	WCDMA V	RMC12.2K	Left Side	1	4233	846.6	23.56	-0.04	0.322	0.236
45	WCDMA V	RMC12.2K	Right Side	1	4233	846.6	23.56	-0.02	0.314	0.231
46	WCDMA V	RMC12.2K	Bottom Side	1	4233	846.6	23.56	0.05	0.068	0.044
28	WCDMA II	RMC12.2K	Front	1	9400	1880	23.34	-0.03	0.627	0.397
29	WCDMA II	RMC12.2K	Back	1	9400	1880	23.34	0.096	0.735	0.444
31	WCDMA II	RMC12.2K	Right Side	1	9400	1880	23.34	-0.08	0.173	0.104
32	WCDMA II	RMC12.2K	Left Side	1	9400	1880	23.34	-0.04	0.29	0.168
33	WCDMA II	RMC12.2K	Bottom Side	1	9400	1880	23.34	-0.03	0.513	0.291

Note:

1. Per KDB 941225 D06, for EUT dimension $\geq 9\text{cm} \times 5\text{cm}$, the test distance is 1cm. SAR must be measured for all surfaces and sides with a transmitting antenna located within 2.5cm from that surface or edge.
2. As in (1), SAR for Front / Back / Bottom Side / Left Side / Right Side is necessary.
3. Per 648474 D01v01, if the highest output channel SAR for each exposure position ≤ 0.8 W/kg other channels SAR tests are not necessary.

<WLAN SAR>

Plot No.	Band	Mode	Test Position	Gap (cm)	Ch.	Freq. (MHz)	Average Power (dBm)	Power Drift (dB)	SAR _{1g} (W/kg)	SAR _{10g} (W/kg)
68	WLAN2.4G	802.11b	Front	1	11	2462	18.13	0.14	0.088	0.044
69	WLAN2.4G	802.11b	Back	1	11	2462	18.13	0.08	0.287	0.133
71	WLAN2.4G	802.11b	Right Side	1	11	2462	18.13	-0.139	0.193	0.09

Note:

1. Per KDB 941225 D06, for EUT dimension $\geq 9\text{cm} \times 5\text{cm}$, the test distance is 1cm. SAR must be measured for all surfaces and sides with a transmitting antenna located within 2.5cm from that surface or edge.
2. As in (1), SAR for Front / Back / Right Side is necessary.
3. Per KDB 648474 D01v01, if the highest output channel SAR for each exposure position ≤ 0.8 W/kg other channels SAR tests are not necessary.

11.3 Test Records for Body-worn SAR Test

<GSM SAR>

Plot No.	Band	Mode	Test Position	Gap (cm)	Headset	Ch.	Freq. (MHz)	Burst Average Power (dBm)	Power Drift (dB)	SAR _{1g} (W/kg)	SAR _{10g} (W/kg)
34	GSM850	GPRS (4 Tx slots)	Front	1	-	251	848.8	28.69	-0.05	0.298	0.244
35	GSM850	GPRS (4 Tx slots)	Back	1	-	251	848.8	28.69	-0.08	0.759	0.603
36	GSM850	DTM Multi-slot class 11	Back	1	v	251	848.8	29.55	-0.132	0.415	0.28
22	GSM1900	GPRS (4 Tx slots)	Front	1	-	810	1909.8	25.59	-0.12	0.304	0.179
23	GSM1900	GPRS (4 Tx slots)	Back	1	-	810	1909.8	25.59	0.1	0.347	0.214
27	GSM1900	DTM Multi-slot class 11	Back	1	v	810	1909.8	26.17	-0.05	0.351	0.216

Note:

- Per KDB 648474 D01v01, if the highest output channel SAR for each exposure position ≤ 0.8 W/kg other channels SAR tests are not necessary.
- “V” in the Headset column means the Headset is plugged during SAR testing.

<WCDMA SAR>

Plot No.	Band	Mode	Test Position	Gap (cm)	Headset	Ch.	Freq. (MHz)	Average Power (dBm)	Power Drift (dB)	SAR _{1g} (W/kg)	SAR _{10g} (W/kg)
40	WCDMA V	RMC12.2K	Front	1	-	4233	846.6	23.56	-0.1	0.443	0.36
41	WCDMA V	RMC12.2K	Back	1	-	4233	846.6	23.56	-0.1	0.925	0.742
42	WCDMA V	RMC12.2K	Back	1	-	4132	826.4	23.35	0.03	0.696	0.552
43	WCDMA V	RMC12.2K	Back	1	-	4182	836.4	23.51	0	0.897	0.719
47	WCDMA V	RMC12.2K	Back	1	v	4233	846.6	23.56	-0.12	0.602	0.474
28	WCDMA II	RMC12.2K	Front	1	-	9400	1880	23.34	-0.03	0.627	0.397
29	WCDMA II	RMC12.2K	Back	1	-	9400	1880	23.34	0.096	0.735	0.444
30	WCDMA II	RMC12.2K	Back	1	v	9400	1880	23.34	-0.12	0.769	0.469

Note:

- Per KDB 648474 D01v01, if the highest output channel SAR for each exposure position ≤ 0.8 W/kg other channels SAR tests are not necessary.
- “V” in the Headset column means the Headset is plugged during SAR testing.

<WLAN SAR>

Plot No.	Band	Mode	Test Position	Gap (cm)	Headset	Ch.	Freq. (MHz)	Average Power (dBm)	Power Drift (dB)	SAR _{1g} (W/kg)	SAR _{10g} (W/kg)
68	WLAN2.4G	802.11b	Front	1	-	11	2462	18.13	0.14	0.088	0.044
69	WLAN2.4G	802.11b	Back	1	-	11	2462	18.13	0.08	0.287	0.133
75	WLAN2.4G	802.11b	Back	1	v	11	2462	18.13	0.123	0.267	0.123
13	WLAN5G	802.11a	Front	1	-	36	5180	12.44	-0.08	0.016	0.0059
14	WLAN5G	802.11a	Back	1	-	36	5180	12.44	0.058	0.047	0.015
15	WLAN5G	802.11a	Back	1	v	36	5180	12.44	0.043	0.046	0.016
16	WLAN5G	802.11a	Front	1	-	52	5280	12.18	0.05	0.015	0.00452
17	WLAN5G	802.11a	Back	1	-	52	5280	12.18	-0.05	0.066	0.022
18	WLAN5G	802.11a	Back	1	v	52	5280	12.18	0.057	0.068	0.023
19	WLAN5G	802.11a	Front	1	-	100	5500	12.29	-0.055	0.00986	0.00378
20	WLAN5G	802.11a	Back	1	-	100	5500	12.29	-0.025	0.039	0.014
21	WLAN5G	802.11a	Back	1	v	100	5500	12.29	0.18	0.042	0.014

Note:

- Per KDB 648474 D01v01 and KDB 248227, if the highest output channel SAR for each exposure position ≤ 0.8 W/kg other channels SAR tests are not necessary.
- “V” in the Headset column means the Headset is plugged during SAR testing.

11.4 Simultaneous Multi-band Transmission Analysis

	Position	Applicable Combination
Simultaneous Transmission	Head	GSM (voice) + WLAN
		GSM (voice) + BT
		WCDMA (voice) + WLAN
		WCDMA (voice) + BT
	Hotspot	GSM (data) + WLAN
		WCDMA (data) + WLAN
	Body-worn	GSM (voice) + WLAN
		GSM (voice) + BT
		WCDMA (voice) + WLAN
		WCDMA (voice) + BT

Note:

1. WLAN and BT share the same antenna, and cannot transmit simultaneously.
2. GSM and WCDMA share the same antenna, and cannot transmit simultaneously.
3. EUT will choose either WLAN2.4G or WLAN5G according to the network signal condition; therefore, they will not transmit simultaneously.
4. If 1g-SAR scalar summation < 1.6W/kg, simultaneous SAR measurement is not necessary.
5. Only 2.4GHz WLAN supports mobile hotspot mode; 5GHz WLAN is disabled in hotspot mode
6. In simultaneous transmission analysis, the measured SAR is scaled up to account for tune-up tolerance and to show compliance.

<Head SAR>

Position	WWAN			Scaled WWAN				WLAN		Scaled WLAN2.4G				WWAN + WLAN	Scaled WWAN + Scaled WLAN
	WWAN Band	Plot No	Max. WWAN SAR (W/kg)	Average Power (dBm)	Tune-up Limit (dBm)	Scaling Factor	Scaled WWAN (W/kg)	Plot No	Max. WLAN SAR (W/kg)	Average Power (dBm)	Tune-up Limit (dBm)	Scaling Factor	Scaled WLAN (W/kg)		
Right Cheek	GSM850	60	0.26	29.55	30	1.109	0.288	64	0.322	18.13	18.5	1.090	0.351	0.58	0.64
	GSM1900	48	0.212	26.17	26.5	1.079	0.229	64	0.322	18.13	18.5	1.090	0.351	0.53	0.58
	WCDMA V	56	0.34	23.56	24	1.107	0.376	64	0.322	18.13	18.5	1.090	0.351	0.66	0.73
	WCDMA II	52	0.591	23.34	23.5	1.038	0.613	64	0.322	18.13	18.5	1.090	0.351	0.91	0.96
Right Tilted	GSM850	63	0.179	29.55	30	1.109	0.199	65	0.062	18.13	18.5	1.090	0.068	0.24	0.27
	GSM1900	49	0.102	26.17	26.5	1.079	0.110	65	0.062	18.13	18.5	1.090	0.068	0.16	0.18
	WCDMA V	57	0.22	23.56	24	1.107	0.243	65	0.062	18.13	18.5	1.090	0.068	0.28	0.31
Left Cheek	WCDMA II	53	0.315	23.34	23.5	1.038	0.327	65	0.062	18.13	18.5	1.090	0.068	0.38	0.40
	GSM850	61	0.267	29.55	30	1.109	0.296	66	0.248	18.13	18.5	1.090	0.270	0.52	0.57
	GSM1900	50	0.199	26.17	26.5	1.079	0.215	66	0.248	18.13	18.5	1.090	0.270	0.45	0.49
Left Tilted	WCDMA V	58	0.324	23.56	24	1.107	0.359	66	0.248	18.13	18.5	1.090	0.270	0.57	0.63
	WCDMA II	54	0.613	23.34	23.5	1.038	0.636	66	0.248	18.13	18.5	1.090	0.270	0.86	0.91
	GSM850	62	0.177	29.55	30	1.109	0.196	67	0.052	18.13	18.5	1.090	0.057	0.23	0.25
Left Tilted	GSM1900	51	0.103	26.17	26.5	1.079	0.111	67	0.052	18.13	18.5	1.090	0.057	0.16	0.17
	WCDMA V	59	0.208	23.56	24	1.107	0.230	67	0.052	18.13	18.5	1.090	0.057	0.26	0.29
	WCDMA II	55	0.355	23.34	23.5	1.038	0.368	67	0.052	18.13	18.5	1.090	0.057	0.41	0.43



Position	WWAN			Scaled WWAN				WLAN		Scaled WLAN5G				WWAN + WLAN	Scaled WWAN + Scaled WLAN
	WWAN Band	Plot No	Max. WWAN SAR (W/kg)	Average Power (dBm)	Tune-up Limit (dBm)	Scaling Factor	Scaled WWAN (W/kg)	Plot No	Max. WLAN SAR (W/kg)	Average Power (dBm)	Tune-up Limit (dBm)	Scaling Factor	Scaled WLAN (W/kg)		
Right Cheek	GSM850	60	0.26	29.55	30	1.109	0.288	5	0.065	12.15	12.5	1.084	0.070	0.33	0.36
	GSM1900	48	0.212	26.17	26.5	1.079	0.229	5	0.065	12.15	12.5	1.084	0.070	0.28	0.30
	WCDMA V	56	0.34	23.56	24	1.107	0.376	5	0.065	12.15	12.5	1.084	0.070	0.41	0.45
Right Tilted	WCDMA II	52	0.591	23.34	23.5	1.038	0.613	5	0.065	12.15	12.5	1.084	0.070	0.66	0.68
	GSM850	63	0.179	29.55	30	1.109	0.199	6	0.00588	12.15	12.5	1.084	0.006	0.18	0.21
	GSM1900	49	0.102	26.17	26.5	1.079	0.110	6	0.00588	12.15	12.5	1.084	0.006	0.11	0.12
Left Cheek	WCDMA V	57	0.22	23.56	24	1.107	0.243	6	0.00588	12.15	12.5	1.084	0.006	0.23	0.25
	WCDMA II	53	0.315	23.34	23.5	1.038	0.327	6	0.00588	12.15	12.5	1.084	0.006	0.32	0.33
	GSM850	61	0.267	29.55	30	1.109	0.296	7	0.056	12.15	12.5	1.084	0.070	0.32	0.36
Left Tilted	GSM1900	50	0.199	26.17	26.5	1.079	0.215	7	0.056	12.15	12.5	1.084	0.070	0.26	0.28
	WCDMA V	58	0.324	23.56	24	1.107	0.359	7	0.056	12.15	12.5	1.084	0.070	0.38	0.42
	WCDMA II	54	0.613	23.34	23.5	1.038	0.636	7	0.056	12.15	12.5	1.084	0.070	0.67	0.70
Left Tilted	GSM850	62	0.177	29.55	30	1.109	0.196	12	0.015	12.29	12.5	1.048	0.016	0.19	0.21
	GSM1900	51	0.103	26.17	26.5	1.079	0.111	12	0.015	12.29	12.5	1.048	0.016	0.12	0.13
	WCDMA V	59	0.208	23.56	24	1.107	0.230	12	0.015	12.29	12.5	1.048	0.016	0.22	0.25
	WCDMA II	55	0.355	23.34	23.5	1.038	0.368	12	0.015	12.29	12.5	1.048	0.016	0.37	0.38

<Hotspot SAR>

Position	WWAN			Scaled WWAN				WLAN		Scaled WLAN2.4G				WWAN + WLAN	Scaled WWAN + Scaled WLAN
	WWAN Band	Plot No	Max. WWAN SAR (W/kg)	Average Power (dBm)	Tune-up Limit (dBm)	Scaling Factor	Scaled WWAN (W/kg)	Plot No	Max. WLAN SAR (W/kg)	Average Power (dBm)	Tune-up Limit (dBm)	Scaling Factor	Scaled WLAN (W/kg)		
Front	GSM850	34	0.298	28.69	29	1.074	0.320	68	0.088	18.13	18.5	1.090	0.096	0.39	0.42
	GSM1900	22	0.304	25.59	26	1.099	0.334	68	0.088	18.13	18.5	1.090	0.096	0.39	0.43
	WCDMA V	40	0.443	23.56	24	1.107	0.490	68	0.088	18.13	18.5	1.090	0.096	0.53	0.59
	WCDMA II	28	0.627	23.34	23.5	1.038	0.651	68	0.088	18.13	18.5	1.090	0.096	0.72	0.75
Back	GSM850	35	0.759	28.69	29	1.074	0.815	69	0.287	18.13	18.5	1.090	0.313	1.05	1.13
	GSM1900	23	0.347	25.59	26	1.099	0.381	69	0.287	18.13	18.5	1.090	0.313	0.63	0.69
	WCDMA V	41	0.925	23.56	24	1.107	1.024	69	0.287	18.13	18.5	1.090	0.313	1.21	1.34
Left Side	WCDMA II	29	0.735	23.34	23.5	1.038	0.763	69	0.287	18.13	18.5	1.090	0.313	1.02	1.08
	GSM850	37	0.26	28.69	29	1.074	0.279	-	-	-	-	-	-	0.26	0.28
	GSM1900	25	0.117	25.59	26	1.099	0.129	-	-	-	-	-	-	0.12	0.13
	WCDMA V	44	0.322	23.56	24	1.107	0.356	-	-	-	-	-	-	0.32	0.36
Right Side	WCDMA II	32	0.29	23.34	23.5	1.038	0.301	-	-	-	-	-	-	0.29	0.30
	GSM850	38	0.263	28.69	29	1.074	0.282	71	0.193	18.13	18.5	1.090	0.210	0.46	0.49
	GSM1900	24	0.062	25.59	26	1.099	0.068	71	0.193	18.13	18.5	1.090	0.210	0.26	0.28
	WCDMA V	45	0.314	23.56	24	1.107	0.347	71	0.193	18.13	18.5	1.090	0.210	0.51	0.56
Bottom Side	WCDMA II	31	0.173	23.34	23.5	1.038	0.179	71	0.193	18.13	18.5	1.090	0.210	0.37	0.97
	GSM850	39	0.066	28.69	29	1.074	0.071	-	-	-	-	-	-	0.07	0.07
	GSM1900	26	0.222	25.59	26.00	1.099	0.244	-	-	-	-	-	-	0.22	0.24
	WCDMA V	46	0.068	23.56	24	1.107	0.075	-	-	-	-	-	-	0.07	0.08
	WCDMA II	33	0.513	23.34	23.5	1.038	0.532	-	-	-	-	-	-	0.51	0.53

<Body-worn SAR>

Position	WWAN			Scaled WWAN				WLAN		Scaled WLAN2.4G				WWAN + WLAN	Scaled WWAN + Scaled WLAN
	WWAN Band	Plot No	Max. WWAN SAR (W/kg)	Average Power (dBm)	Tune-up Limit (dBm)	Scaling Factor	Scaled WWAN (W/kg)	Plot No	Max. WLAN SAR (W/kg)	Average Power (dBm)	Tune-up Limit (dBm)	Scaling Factor	Scaled WLAN (W/kg)		
Front	GSM850	34	0.298	28.69	29	1.074	0.320	68	0.088	18.13	18.5	1.090	0.096	0.39	0.42
	GSM1900	22	0.304	25.59	26	1.099	0.334	68	0.088	18.13	18.5	1.090	0.096	0.39	0.43
	WCDMA V	40	0.443	23.56	24	1.107	0.490	68	0.088	18.13	18.5	1.090	0.096	0.53	0.59
	WCDMA II	28	0.627	23.34	23.5	1.038	0.651	68	0.088	18.13	18.5	1.090	0.096	0.72	0.75
Back	GSM850	35	0.759	28.69	29	1.074	0.815	69	0.287	18.13	18.5	1.090	0.313	1.05	1.13
	GSM1900	23	0.347	25.59	26	1.099	0.381	69	0.287	18.13	18.5	1.090	0.313	0.63	0.69
	WCDMA V	41	0.925	23.56	24	1.107	1.024	69	0.287	18.13	18.5	1.090	0.313	1.21	1.34
Back (w/ Headset)	WCDMA II	29	0.735	23.34	23.5	1.038	0.763	69	0.287	18.13	18.5	1.090	0.313	1.02	1.08
	GSM850	36	0.415	29.55	30	1.109	0.460	75	0.267	18.13	18.5	1.090	0.291	0.68	0.75
	GSM1900	27	0.351	26.17	26.5	1.079	0.379	75	0.267	18.13	18.5	1.090	0.291	0.62	0.67
	WCDMA V	47	0.602	23.56	24	1.107	0.666	75	0.267	18.13	18.5	1.090	0.291	0.87	0.96
	WCDMA II	30	0.769	23.34	23.5	1.038	0.798	75	0.267	18.13	18.5	1.090	0.291	1.04	1.09

Position	WWAN			Scaled WWAN				WLAN		Scaled WLAN5G				WWAN + WLAN	Scaled WWAN + Scaled WLAN
	WWAN Band	Plot No	Max. WWAN SAR (W/kg)	Average Power (dBm)	Tune-up Limit (dBm)	Scaling Factor	Scaled WWAN (W/kg)	Plot No	Max. WLAN SAR (W/kg)	Average Power (dBm)	Tune-up Limit (dBm)	Scaling Factor	Scaled WLAN (W/kg)		
Front	GSM850	34	0.298	28.69	29	1.074	0.320	13	0.016	12.44	13	1.138	0.018	0.31	0.34
	GSM1900	22	0.304	25.59	26	1.099	0.334	13	0.016	12.44	13	1.138	0.018	0.32	0.35
	WCDMA V	40	0.443	23.56	24	1.107	0.490	13	0.016	12.44	13	1.138	0.018	0.46	0.51
	WCDMA II	28	0.627	23.34	23.5	1.038	0.651	13	0.016	12.44	13	1.138	0.018	0.64	0.67
Back	GSM850	35	0.759	28.69	29	1.074	0.815	17	0.066	12.15	13	1.206	0.080	0.83	0.90
	GSM1900	23	0.347	25.59	26	1.099	0.381	17	0.066	12.15	13	1.206	0.080	0.41	0.46
	WCDMA V	41	0.925	23.56	24	1.107	1.024	17	0.066	12.15	13	1.206	0.080	0.99	1.10
Back (w/ Headset)	WCDMA II	29	0.735	23.34	23.5	1.038	0.763	17	0.066	12.15	13	1.206	0.080	0.80	0.84
	GSM850	36	0.415	29.55	30	1.109	0.460	18	0.068	12.15	13	1.206	0.082	0.48	0.54
	GSM1900	27	0.351	26.17	26.5	1.079	0.379	18	0.068	12.15	13	1.206	0.082	0.42	0.46
	WCDMA V	47	0.602	23.56	24	1.107	0.666	18	0.068	12.15	13	1.206	0.082	0.67	0.75
	WCDMA II	30	0.769	23.34	23.5	1.038	0.798	18	0.068	12.15	13	1.206	0.082	0.84	0.88

Test Engineer : Angelo Chang, Bevis Chang, Ken Li, Aaron Chen, Cona Huang, and Jack Wu

12. Uncertainty Assessment

The component of uncertainty may generally be categorized according to the methods used to evaluate them. The evaluation of uncertainty by the statistical analysis of a series of observations is termed a Type A evaluation of uncertainty. The evaluation of uncertainty by means other than the statistical analysis of a series of observations is termed a Type B evaluation of uncertainty. Each component of uncertainty, however evaluated, is represented by an estimated standard deviation, termed standard uncertainty, which is determined by the positive square root of the estimated variance.

A Type A evaluation of standard uncertainty may be based on any valid statistical method for treating data. This includes calculating the standard deviation of the mean of a series of independent observations; using the method of least squares to fit a curve to the data in order to estimate the parameter of the curve and their standard deviations; or carrying out an analysis of variance in order to identify and quantify random effects in certain kinds of measurement.

A type B evaluation of standard uncertainty is typically based on scientific judgment using all of the relevant information available. These may include previous measurement data, experience, and knowledge of the behavior and properties of relevant materials and instruments, manufacture's specification, data provided in calibration reports and uncertainties assigned to reference data taken from handbooks. Broadly speaking, the uncertainty is either obtained from an outdoor source or obtained from an assumed distribution, such as the normal distribution, rectangular or triangular distributions indicated in Table 12.1

Uncertainty Distributions	Normal	Rectangular	Triangular	U-Shape
Multi-plying Factor ^(a)	1/k ^(b)	1/√3	1/√6	1/√2

(a) standard uncertainty is determined as the product of the multiplying factor and the estimated range of variations in the measured quantity

(b) κ is the coverage factor

Table 12.1 Standard Uncertainty for Assumed Distribution

The combined standard uncertainty of the measurement result represents the estimated standard deviation of the result. It is obtained by combining the individual standard uncertainties of both Type A and Type B evaluation using the usual "root-sum-squares" (RSS) methods of combining standard deviations by taking the positive square root of the estimated variances.

Expanded uncertainty is a measure of uncertainty that defines an interval about the measurement result within which the measured value is confidently believed to lie. It is obtained by multiplying the combined standard uncertainty by a coverage factor. Typically, the coverage factor ranges from 2 to 3. Using a coverage factor allows the true value of a measured quantity to be specified with a defined probability within the specified uncertainty range. For purpose of this document, a coverage factor two is used, which corresponds to confidence interval of about 95 %. The DASY uncertainty Budget is shown in the following tables.



Error Description	Uncertainty Value (±%)	Probability Distribution	Divisor	Ci (1g)	Ci (10g)	Standard Uncertainty (1g)	Standard Uncertainty (10g)
Measurement System							
Probe Calibration	6.0	Normal	1	1	1	± 6.0 %	± 6.0 %
Axial Isotropy	4.7	Rectangular	√3	0.7	0.7	± 1.9 %	± 1.9 %
Hemispherical Isotropy	9.6	Rectangular	√3	0.7	0.7	± 3.9 %	± 3.9 %
Boundary Effects	1.0	Rectangular	√3	1	1	± 0.6 %	± 0.6 %
Linearity	4.7	Rectangular	√3	1	1	± 2.7 %	± 2.7 %
System Detection Limits	1.0	Rectangular	√3	1	1	± 0.6 %	± 0.6 %
Readout Electronics	0.3	Normal	1	1	1	± 0.3 %	± 0.3 %
Response Time	0.8	Rectangular	√3	1	1	± 0.5 %	± 0.5 %
Integration Time	2.6	Rectangular	√3	1	1	± 1.5 %	± 1.5 %
RF Ambient Noise	3.0	Rectangular	√3	1	1	± 1.7 %	± 1.7 %
RF Ambient Reflections	3.0	Rectangular	√3	1	1	± 1.7 %	± 1.7 %
Probe Positioner	0.4	Rectangular	√3	1	1	± 0.2 %	± 0.2 %
Probe Positioning	2.9	Rectangular	√3	1	1	± 1.7 %	± 1.7 %
Max. SAR Eval.	1.0	Rectangular	√3	1	1	± 0.6 %	± 0.6 %
Test Sample Related							
Device Positioning	2.9	Normal	1	1	1	± 2.9 %	± 2.9 %
Device Holder	3.6	Normal	1	1	1	± 3.6 %	± 3.6 %
Power Drift	5.0	Rectangular	√3	1	1	± 2.9 %	± 2.9 %
Phantom and Setup							
Phantom Uncertainty	4.0	Rectangular	√3	1	1	± 2.3 %	± 2.3 %
Liquid Conductivity (Target)	5.0	Rectangular	√3	0.64	0.43	± 1.8 %	± 1.2 %
Liquid Conductivity (Meas.)	2.5	Normal	1	0.64	0.43	± 1.6 %	± 1.1 %
Liquid Permittivity (Target)	5.0	Rectangular	√3	0.6	0.49	± 1.7 %	± 1.4 %
Liquid Permittivity (Meas.)	2.5	Normal	1	0.6	0.49	± 1.5 %	± 1.2 %
Combined Standard Uncertainty						± 11.0 %	± 10.8 %
Coverage Factor for 95 %						K=2	
Expanded Uncertainty						± 22.0 %	± 21.5 %

Table 12.2 Uncertainty Budget of DASY for frequency range 300 MHz to 3 GHz



Error Description	Uncertainty Value (±%)	Probability Distribution	Divisor	Ci (1g)	Ci (10g)	Standard Uncertainty (1g)	Standard Uncertainty (10g)
Measurement System							
Probe Calibration	6.55	Normal	1	1	1	± 6.55 %	± 6.55 %
Axial Isotropy	4.7	Rectangular	√3	0.7	0.7	± 1.9 %	± 1.9 %
Hemispherical Isotropy	9.6	Rectangular	√3	0.7	0.7	± 3.9 %	± 3.9 %
Boundary Effects	2.0	Rectangular	√3	1	1	± 1.2 %	± 1.2 %
Linearity	4.7	Rectangular	√3	1	1	± 2.7 %	± 2.7 %
System Detection Limits	1.0	Rectangular	√3	1	1	± 0.6 %	± 0.6 %
Readout Electronics	0.3	Normal	1	1	1	± 0.3 %	± 0.3 %
Response Time	0.8	Rectangular	√3	1	1	± 0.5 %	± 0.5 %
Integration Time	2.6	Rectangular	√3	1	1	± 1.5 %	± 1.5 %
RF Ambient Noise	3.0	Rectangular	√3	1	1	± 1.7 %	± 1.7 %
RF Ambient Reflections	3.0	Rectangular	√3	1	1	± 1.7 %	± 1.7 %
Probe Positioner	0.8	Rectangular	√3	1	1	± 0.5 %	± 0.5 %
Probe Positioning	9.9	Rectangular	√3	1	1	± 5.7 %	± 5.7 %
Max. SAR Eval.	4.0	Rectangular	√3	1	1	± 2.3 %	± 2.3 %
Test Sample Related							
Device Positioning	2.9	Normal	1	1	1	± 2.9 %	± 2.9 %
Device Holder	3.6	Normal	1	1	1	± 3.6 %	± 3.6 %
Power Drift	5.0	Rectangular	√3	1	1	± 2.9 %	± 2.9 %
Phantom and Setup							
Phantom Uncertainty	4.0	Rectangular	√3	1	1	± 2.3 %	± 2.3 %
Liquid Conductivity (Target)	5.0	Rectangular	√3	0.64	0.43	± 1.8 %	± 1.2 %
Liquid Conductivity (Meas.)	2.5	Normal	1	0.64	0.43	± 1.6 %	± 1.1 %
Liquid Permittivity (Target)	5.0	Rectangular	√3	0.6	0.49	± 1.7 %	± 1.4 %
Liquid Permittivity (Meas.)	2.5	Normal	1	0.6	0.49	± 1.5 %	± 1.2 %
Combined Standard Uncertainty						± 12.8 %	± 12.6 %
Coverage Factor for 95 %						K=2	
Expanded Uncertainty						± 25.6 %	± 25.2 %

Table 12.3 Uncertainty Budget of DASY for frequency range 3 GHz to 6 GHz



13. References

- [1] FCC 47 CFR Part 2 "Frequency Allocations and Radio Treaty Matters; General Rules and Regulations"
- [2] ANSI/IEEE Std. C95.1-1992, "IEEE Standard for Safety Levels with Respect to Human Exposure to Radio Frequency Electromagnetic Fields, 3 kHz to 300 GHz", September 1992
- [3] IEEE Std. 1528-2003, "Recommended Practice for Determining the Peak Spatial-Average Specific Absorption Rate (SAR) in the Human Head from Wireless Communications Devices: Measurement Techniques", December 2003
- [4] FCC OET Bulletin 65 (Edition 97-01) Supplement C (Edition 01-01), "Evaluating Compliance with FCC Guidelines for Human Exposure to Radiofrequency Electromagnetic Fields", June 2001
- [5] SPEAG DASY System Handbook
- [6] FCC KDB 248227 D01 v01r02, "SAR Measurement Procedures for 802.11 a/b/g Transmitters", May 2007
- [7] FCC KDB 447498 D01 v04, "Mobile and Portable Device RF Exposure Procedures and Equipment Authorization Policies", November 2009
- [8] FCC KDB 648474 D01 v01r05, "SAR Evaluation Considerations for Handsets with Multiple Transmitters and Antennas", September 2008
- [9] FCC KDB 941225 D01 v02, "SAR Measurement Procedures for 3G Devices – CDMA 2000 / Ev-Do / WCDMA / HSDPA / HSPA", October 2007
- [10] FCC KDB 941225 D02 v02 "3GPP R6 HSPA and R7 HSPA+ SAR Guidance", December 2009.
- [11] FCC KDB 941225 D03 v01, "Recommended SAR Test Reduction Procedures for GSM / GPRS / EDGE", December 2008
- [12] FCC KDB 941225 D04 v01, "Evaluating SAR for GSM/(E)GPRS Dual Transfer Mode", January 27 2010
- [13] FCC KDB 941225 D05 v01, "SAR Test Considerations for LTE Handsets and Data Modems", December 15 2010
- [14] FCC KDB 941225 D06 v01, "SAR Evaluation Procedures for Portable Devices with Wireless Router Capabilities", April 2011
- [15] FCC KDB 388624 D02, "Permit But Ask List", December 2011.



Appendix A. Plots of System Performance Check

The plots are shown as follows.



Appendix B. Plots of SAR Measurement

The plots are shown as follows.



Appendix C. DAS Y Calibration Certificate

The DAS Y calibration certificates are shown as follows.