

FCC RF Test Report

APPLICANT : HTC Corporation
EQUIPMENT : Smartphone
MODEL NAME : PL80100
FCC ID : NM8PL80100
STANDARD : FCC Part 15 Subpart C §15.247
CLASSIFICATION : (DTS) Digital Transmission System

The product was received on Sep. 24, 2012 and completely tested on Oct. 30, 2012. We, SPORTON INTERNATIONAL INC., would like to declare that the tested sample has been evaluated in accordance with the procedures and shown the compliance with the applicable technical standards.

The test results in this report apply exclusively to the tested model / sample. Without written approval of SPORTON INTERNATIONAL INC., the test report shall not be reproduced except in full.

Reviewed by:



Jones Tsai / Manager



SPORTON INTERNATIONAL INC.

No. 52, Hwa Ya 1st Rd., Hwa Ya Technology Park, Kwei-Shan Hsiang, Tao Yuan Hsien, Taiwan, R.O.C.

SPORTON INTERNATIONAL INC.

TEL : 886-3-327-3456

FAX : 886-3-328-4978

FCC ID : NM8PL80100

Page Number : 1 of 49

Report Issued Date : Nov. 14, 2012

Report Version : Rev. 01



TABLE OF CONTENTS

REVISION HISTORY..... 3

SUMMARY OF TEST RESULT 4

1 GENERAL DESCRIPTION..... 5

 1.1 Applicant 5

 1.2 Manufacturer..... 5

 1.3 Feature of Equipment Under Test 5

 1.4 Testing Site 6

 1.5 Applied Standards 6

 1.6 Ancillary Equipment List 6

2 TEST CONFIGURATION OF EQUIPMENT UNDER TEST..... 7

 2.1 RF Output Power 7

 2.2 Test Mode..... 8

 2.3 Connection Diagram of Test System..... 9

 2.4 RF Utility 9

3 TEST RESULT 10

 3.1 6dB Bandwidth Measurement 10

 3.2 Peak Output Power Measurement 13

 3.3 Power Spectral Density Measurement 16

 3.4 Conducted Band Edges and Spurious Emission Measurement 19

 3.5 Radiated Band Edges and Spurious Emission Measurement 27

 3.6 AC Conducted Emission Measurement..... 43

 3.7 Antenna Requirements 47

4 LIST OF MEASURING EQUIPMENT..... 48

5 UNCERTAINTY OF EVALUATION..... 49

APPENDIX A. SETUP PHOTOGRAPHS



SUMMARY OF TEST RESULT

Report Section	FCC Rule	IC Rule	Description	Limit	Result	Remark
3.1	15.247(a)(2)	A8.2(a)	6dB Bandwidth	$\geq 0.5\text{MHz}$	Pass	-
3.2	15.247(b)(1)	A8.1(b)	Peak Output Power	$\leq 30\text{dBm}$	Pass	-
3.5	15.247(e)	A8.2(b)	Power Spectral Density	$\leq 8\text{dBm}$	Pass	-
3.4	15.247(d)	A8.5	Conducted Band Edges and Spurious Emission	$\leq 20\text{dBc}$	Pass	-
3.5	15.247(d)	A8.5	Radiated Band Edges and Spurious Emission	15.209(a) & 15.247(d)	Pass	Under limit 7.35 dB at 40.800 MHz
3.6	15.207	Gen 7.2.2	AC Conducted Emission	15.207(a)	Pass	Under limit 4.60 dB at 13.558 MHz
3.7	15.203 & 15.247(b)	A8.4	Antenna Requirement	N/A	Pass	-

1 General Description

1.1 Applicant

HTC Corporation

No. 23, Xinghua Rd., Taoyuan City, Taoyuan County 330, Taiwan.

1.2 Manufacturer

HTC Corporation

No. 23, Xinghua Rd., Taoyuan City, Taoyuan County 330, Taiwan.

1.3 Feature of Equipment Under Test

Product Feature	
Equipment	Smartphone
Model Name	PL80100
Sample 1	EUT with LCD Panel 1, Main Camera 1, and Front Camera 1
Sample 2	EUT with LCD Panel 2, Main Camera 2, and Front Camera 2
FCC ID	NM8PL80100
EUT supports Radios application	GSM/EGPRS/WCDMA/HSPA/ WLAN 11abgn / Bluetooth / NFC
EUT Stage	Identical Prototype

Remark: The above EUT's information was declared by manufacturer. Please refer to the specifications or user's manual for more detailed description.

Product Specification subjective to this standard	
Tx/Rx Frequency Range	2402 MHz ~ 2480 MHz
Number of Channels	40
Carrier Frequency of Each Channel	40 Channel(37 hopping + 3 advertising channel)
Maximum Output Power to Antenna	Bluetooth 4.0 - LE : 3.83 dBm (0.0024 W)
Antenna Type	PIFA Antenna type with gain -0.20 dBi
Type of Modulation	Bluetooth 4.0 - LE : GFSK

1.4 Testing Site

Test Site	SPORTON INTERNATIONAL INC.			
Test Site Location	No. 52, Hwa Ya 1 st Rd., Hwa Ya Technology Park, Kwei-Shan Hsiang, Tao Yuan Hsien, Taiwan, R.O.C. TEL: +886-3-3273456 / FAX: +886-3-3284978			
Test Site No.	Sporton Site No.			FCC/IC Registration No.
	TH02-HY	CO05-HY	03CH06-HY	722060/4086B-1

1.5 Applied Standards

According to the specifications of the manufacturer, the EUT must comply with the requirements of the following standards:

- ♦ FCC Part 15 Subpart C §15.247
- ♦ FCC KDB Publication No. 558074 D01 DTS Meas. Guidance v02
- ♦ ANSI C63.4-2003 and ANSI C63.10-2009
- ♦ IC RSS-210 Issue 8
- ♦ IC RSS-Gen Issue 3

Remark:

1. All test items were verified and recorded according to the standards and without any deviation during the test.
2. This EUT has also been tested and complied with the requirements of FCC Part 15, Subpart B, recorded in a separate test report.

1.6 Ancillary Equipment List

Item	Equipment	Trade Name	Model Name	FCC ID	Data Cable	Power Cord
1.	System Simulator	R&S	CMU 200	N/A	N/A	Unshielded, 1.8 m
2.	WLAN AP	D-Link	DIR-628	KA2DIR628A2	N/A	Unshielded, 1.8 m
3.	Bluetooth Earphone	Sony Ericsson	MW600	PY7DDA-2029	N/A	N/A
4.	Notebook	DELL	Latitude E6320	FCC DoC	N/A	AC I/P: Unshielded, 1.2 m DC O/P: Shielded, 1.8 m



2 Test Configuration of Equipment Under Test

2.1 RF Output Power

The RF output power was recorded in the following table:

Channel	Frequency	Bluetooth 4.0 – LE RF Output Power	
		Data Rate / Modulation	
		GFSK	
		1Mbps	
Ch00	2402MHz	2.26 dBm	
Ch19	2440MHz	3.83 dBm	
Ch39	2480MHz	2.80 dBm	

2.2 Test Mode

The EUT has been associated with peripherals pursuant to ANSI C63.4-2003 and configuration operated in a manner tended to maximize its emission characteristics in a typical application. Frequency range investigated: conduction (150 kHz to 30 MHz), radiation (9 kHz to the 10th harmonic of the highest fundamental frequency or to 40 GHz, whichever is lower).

Pre-scanned tests, X, Y, Z in three orthogonal panels, were conducted to determine the final configuration from all possible combinations.

The following tables are showing the test modes as the worst cases (X plane) and recorded in this report.

The following tables are showing the test modes as the worst cases and recorded in this report.

Test Cases	
Test Item	Data Rate / Modulation
	Bluetooth 4.0 – LE / GFSK
Conducted TCs	Mode 1: Bluetooth Tx CH00_2402 MHz_1Mbps Mode 2: Bluetooth Tx CH19_2440 MHz_1Mbps Mode 3: Bluetooth Tx CH39_2480 MHz_1Mbps
Radiated TCs	Mode 1: Bluetooth Tx CH00_2402 MHz_1Mbps for Sample 1 Mode 2: Bluetooth Tx CH19_2440 MHz_1Mbps for Sample 1 Mode 3: Bluetooth Tx CH39_2480 MHz_1Mbps for Sample 1 Mode 4: Bluetooth Tx CH39_2480 MHz_1Mbps for Sample 2
AC Conducted Emission	Mode 1 :GSM850 Idle + Bluetooth Link + WLAN (2.4G) Link + Earphone + Battery 1 + USB Cable 1 (Charging from Adapter 1) + NFC On for Sample 1 Mode 2 :GSM850 Idle + Bluetooth Link + WLAN (2.4G) Link + Earphone + Battery 1 + USB Cable 1 (Charging from Adapter 1) + NFC On for Sample 2
Remark:	
1. For Radiated TCs, the test was performed with Earphone, Battery 2, USB Cable 2, Adapter 2, and Sample 1.	
2. For conducted emission, the worst case is mode 1; only the test data of this mode was reported.	

2.3 Connection Diagram of Test System

<Bluetooth 4.0 – LE Tx Mode>

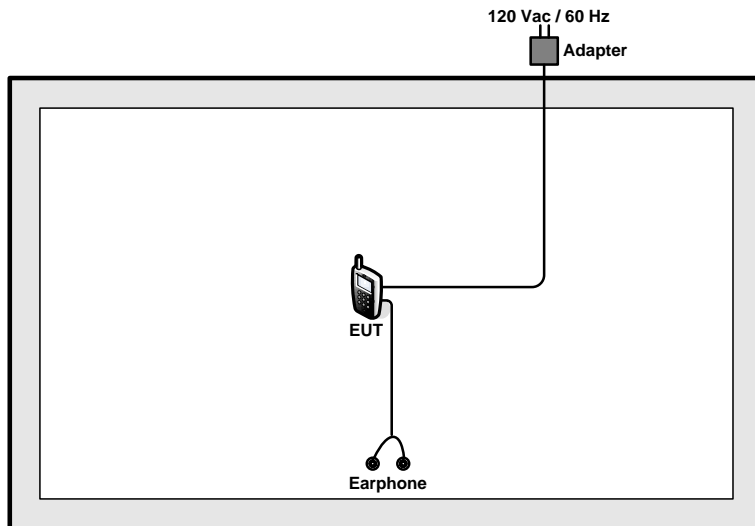

<AC Conducted Emission Mode>

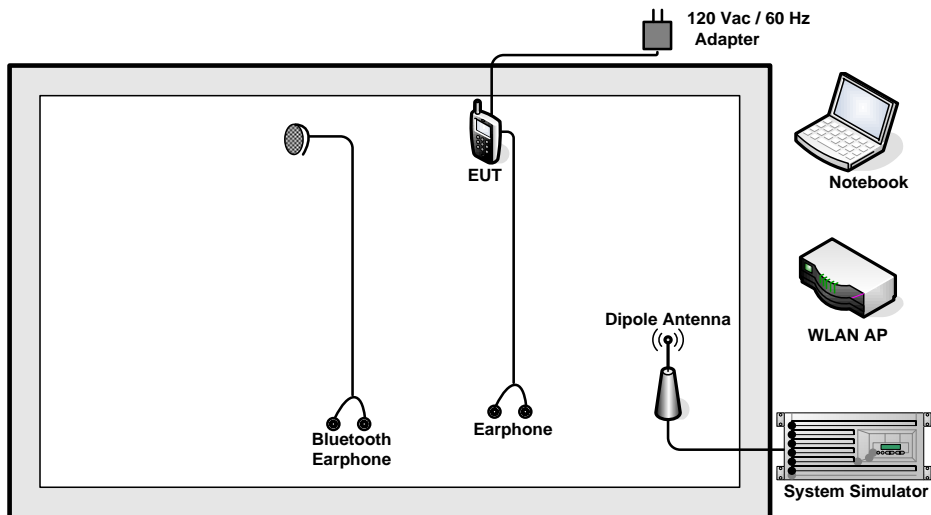

2.4 RF Utility

For Bluetooth function, programmed RF utility, “Remote 432X controller (P2.01).exe” installed in the notebook make the EUT provides functions like channel selection and power level for continuous transmitting and receiving signals.

3 Test Result

3.1 6dB Bandwidth Measurement

3.1.1 Limit of 6dB Bandwidth

The minimum 6 dB bandwidth shall be at least 500 KHz.

3.1.2 Measuring Instruments

See list of measuring instruments of this test report.

3.1.3 Test Procedures

1. The testing follows FCC KDB Publication No. 558074 D01 DTS Meas. Guidance v02.
2. The RF output of EUT was connected to the spectrum analyzer by RF cable and attenuator. The path loss was compensated to the results for each measurement.
3. Set to the maximum power setting and enable the EUT transmit continuously.
4. Make the measurement with the spectrum analyzer's resolution bandwidth (RBW) = 10 kHz. Set the Video bandwidth (VBW) = 30 kHz. In order to make an accurate measurement. The 6 dB bandwidth must be greater than 500 KHz.
5. Measure and record the results in the test report.

3.1.4 Test Setup

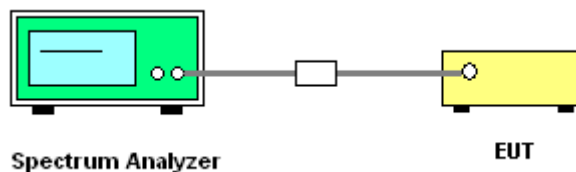



3.1.5 Test Result of 6dB Bandwidth

Test Mode :	Bluetooth 4.0 - LE	Temperature :	24~26°C
Test Engineer :	Bill Kuo	Relative Humidity :	50~53%

Channel	Frequency (MHz)	6dB Bandwidth (MHz)
00	2402	0.69
19	2440	0.70
39	2480	0.70

6 dB Bandwidth Plot on Channel 00

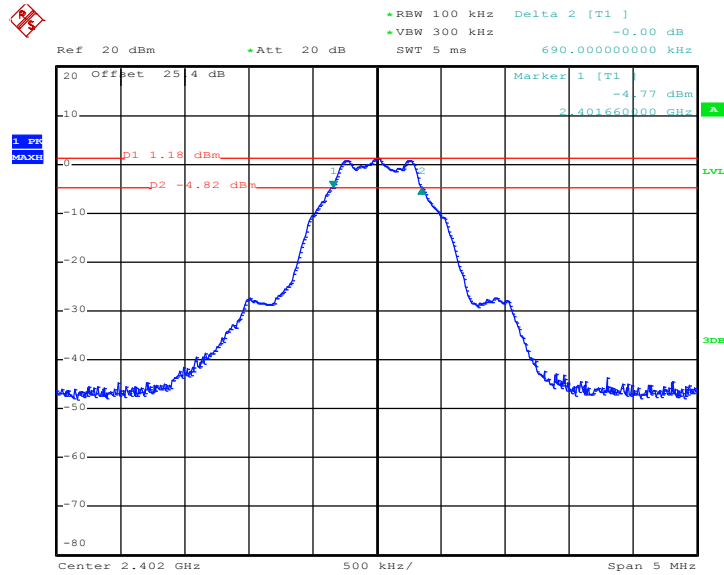

Date: 7.OCT.2012 12:35:06



6 dB Bandwidth Plot on Channel 19

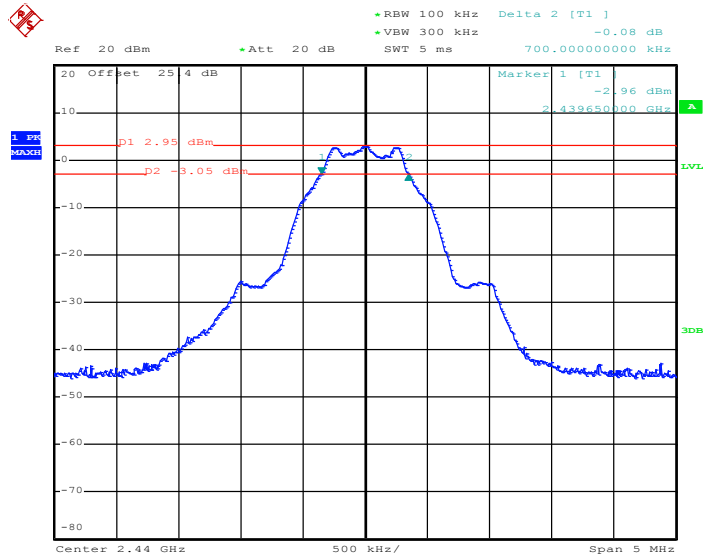

Date: 7.OCT.2012 13:04:23

6 dB Bandwidth Plot on Channel 39

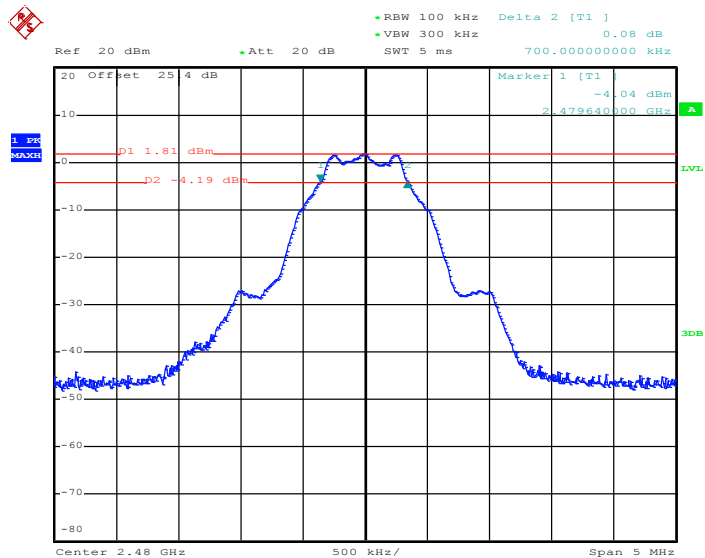

Date: 7.OCT.2012 13:07:01

3.2 Peak Output Power Measurement

3.2.1 Limit of Peak Output Power

For systems using digital modulation in the 2400-2483.5MHz, the limit for peak output power is 30dBm. If transmitting antenna of directional gain greater than 6dBi are used the peak output power from the intentional radiator shall be reduced below the above stated value by the amount in dB that the directional gain of the antenna exceeds 6 dBi. In case of point-to-point operation, the limit has to be reduced by 1dB for every 3dB that the directional gain of the antenna exceeds 6dBi.

3.2.2 Measuring Instruments

See list of measuring instruments of this test report.

3.2.3 Test Procedures

1. The testing follows the Measurement Procedure of FCC KDB No. 558074 DTS D01 Meas. Guidance v02.
2. The RF output of EUT was connected to the spectrum analyzer by RF cable and attenuator. The path loss was compensated to the results for each measurement.
3. Set to the maximum power setting and enable the EUT transmit continuously.
4. Measure the conducted output power and record the results in the test report.

3.2.4 Test Setup

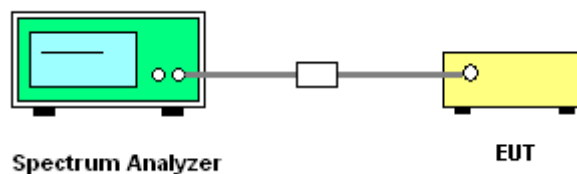

3.2.5 Test Result of Peak Output Power

Test Mode :	Bluetooth 4.0 - LE	Temperature :	24~26°C
Test Engineer :	Bill Kuo	Relative Humidity :	50~53%

Channel	Frequency (MHz)	RF Power (dBm)		
		GFSK	Max. Limits (dBm)	Pass/Fail
		1 Mbps		
00	2402	2.26	30.00	Pass
19	2440	3.83	30.00	Pass
39	2480	2.80	30.00	Pass

Peak Output Power Plot on Channel 00

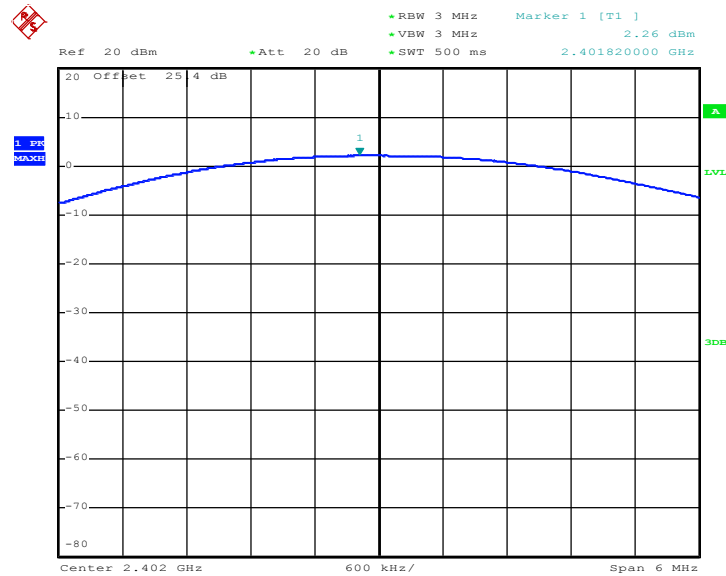

Date: 30.SEP.2012 13:12:49



Peak Output Power Plot on Channel 19

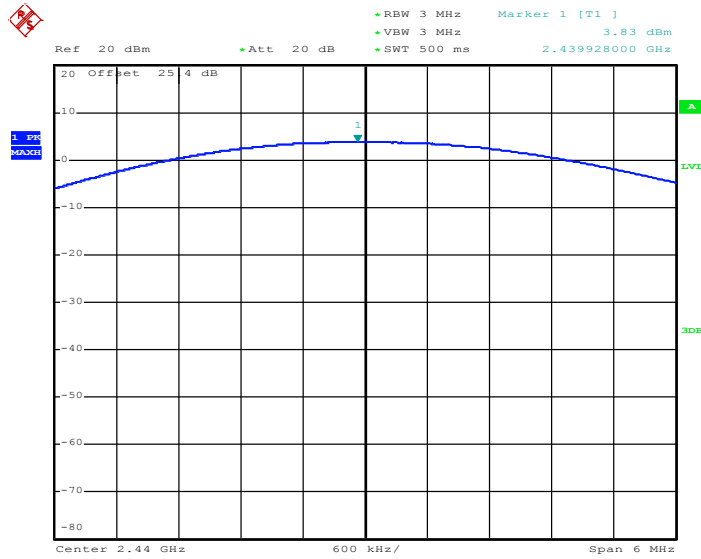

Date: 30.SEP.2012 13:13:15

Peak Output Power Plot on Channel 39

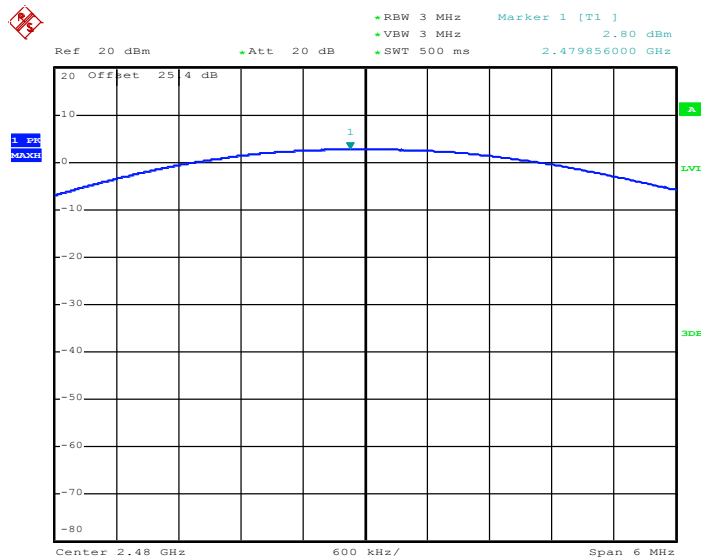

Date: 30.SEP.2012 13:14:06

3.3 Power Spectral Density Measurement

3.3.1 Limit of Power Spectral Density

The peak power spectral density shall not be greater than 8dBm in any 3KHz band at any time interval of continuous transmission.

3.3.2 Measuring Instruments

See list of measuring instruments of this test report.

3.3.3 Test Procedures

1. The testing follows Measurement Procedure 9.1 Option 1 of FCC KDB Publication No. 558074 D01 DTS Meas. Guidance v02
2. The RF output of EUT was connected to the spectrum analyzer by RF cable and attenuator. The path loss was compensated to the results for each measurement.
3. Set to the maximum power setting and enable the EUT transmit continuously.
4. Make the measurement with the spectrum analyzer's resolution bandwidth (RBW) = 100 kHz. Video bandwidth VBW = 300 kHz. Set the span to 1.5 times DTS Channel Bandwidth.
5. Detector = peak, Sweep time = auto couple, Trace mode = max hold, Allow trace to fully stabilize. Use the peak marker function to determine the maximum power level.
6. If result of step 4. is fail to comply with PSD limit (dBm/3kHz)., repeat the measurement with the spectrum analyzer's resolution bandwidth (RBW) = 3 kHz. Video bandwidth VBW = 10 kHz In order to make an accurate measurement, set the span to 1.5 times DTS Channel Bandwidth. (6dB BW). Compare the result with the PSD limit line.
7. Measure and record the results in the test report.

3.3.4 Test Setup

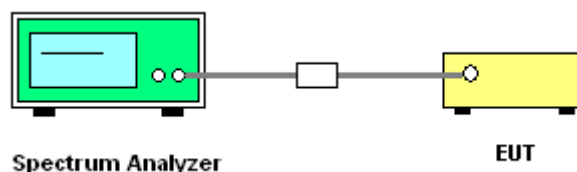

3.3.5 Test Result of Power Spectral Density

Test Mode :	Bluetooth 4.0 - LE	Temperature :	24~26°C
Test Engineer :	Bill Kuo	Relative Humidity :	50~53%

Channel	Frequency (MHz)	Power Density		Max. Limits (dBm/3KHz)	Pass/Fail
		PSD/100KHz (dBm)	PSD/3KHz (dBm)		
00	2402	1.19	-	8	Pass
19	2440	2.91	-	8	Pass
39	2480	1.82	-	8	Pass

Note:

1. Measured power density (dBm) has offset with cable loss.
2. The Measured power density (dBm)/ 100KHz is reference level and used as 20dBc down for Conducted Band Edges and Conducted Spurious Emission limit line.
3. Make the measurement with the spectrum analyzer's resolution bandwidth (RBW) = 100 kHz. Video bandwidth VBW =300 kHz In order to make an accurate measurement, set the span to 1.5 times DTS Channel Bandwidth. (6dB BW)
4. When above step result is Pass limit, 8dBm/3KHz, and then the PSD is not required to re-test by RBW=3KHz. Otherwise, the PSD shall be re-measured by RBW=3KHz, and compare to the limit line.

3.3.6 Test Result of Power Spectral Density Plots (100kHz)

PSD 100kHz Plot on Channel 00

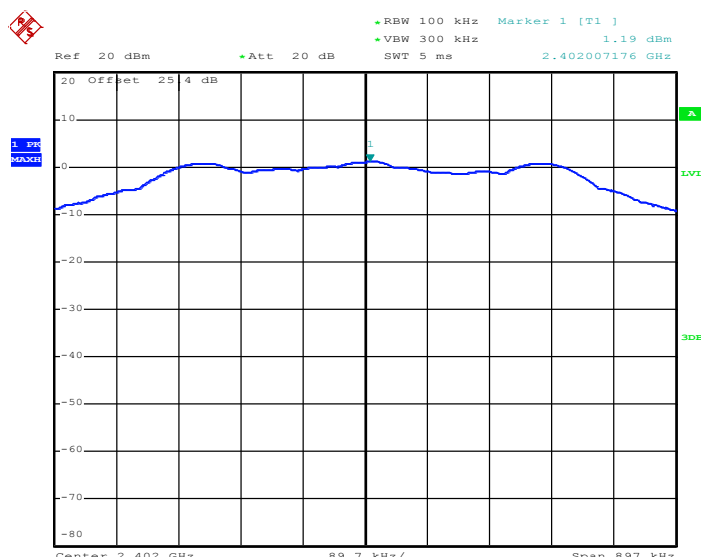

Date: 7.OCT.2012 12:36:28



PSD 100kHz Plot on Channel 19

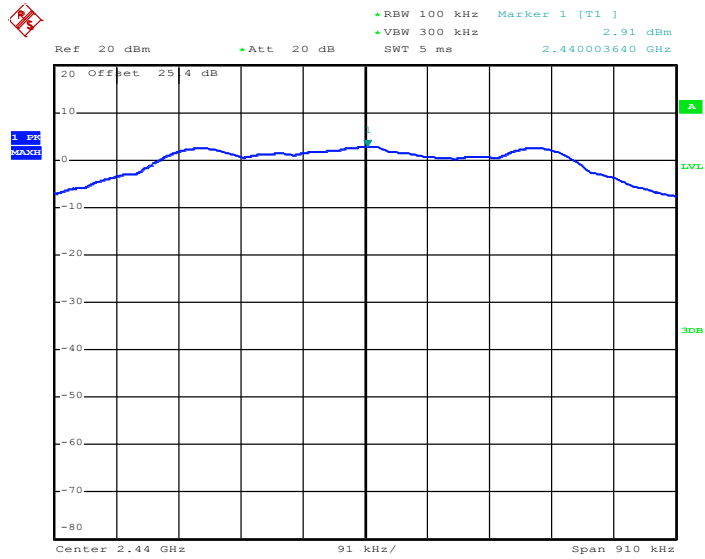

Date: 7.OCT.2012 13:04:43

PSD 100kHz Plot on Channel 39

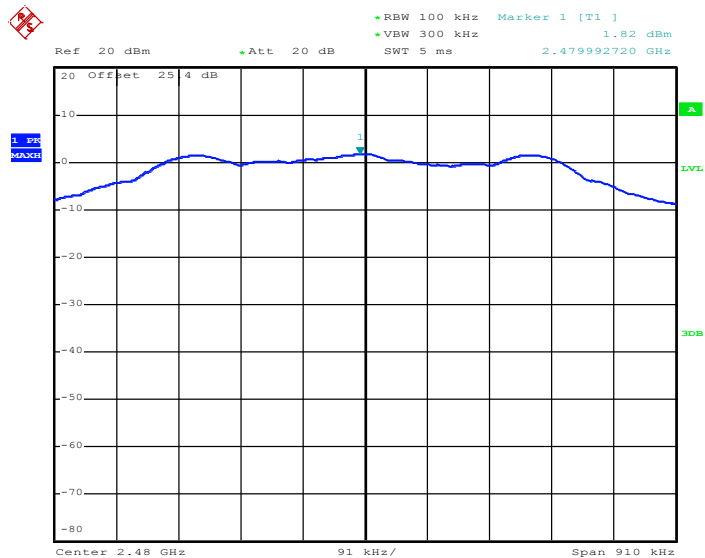

Date: 7.OCT.2012 13:07:19

3.4 Conducted Band Edges and Spurious Emission Measurement

3.4.1 Limit of Conducted Band Edges and Spurious Emission

All harmonics/spurious must be at least 20 dB down from the highest emission level within the authorized band.

3.4.2 Measuring Instruments

See list of measuring instruments of this test report.

3.4.3 Test Procedure

1. The testing follows the guidelines in ANSI C63.4-2003 and the Measurement Procedure of FCC KDB Publication No. 558074 D01 DTS Meas. Guidance v02.
2. The RF output of EUT was connected to the spectrum analyzer by RF cable and attenuator. The path loss was compensated to the results for each measurement.
3. Set to the maximum power setting and enable the EUT transmit continuously.
4. Set RBW = 100 KHz, Video bandwidth (VBW) \geq RBW. Out of the authorized frequency band emissions must be at least 20 dB lower than the highest emission level within the authorized band as measured with a 100 KHz RBW. If the transmitter complies with the conducted power limits based on the use of RMS averaging over a time interval, the attenuation required under this paragraph shall be 30 dB instead of 20 dB per 15.247(d).
5. Measure and record the results in the test report.

3.4.4 Test Setup

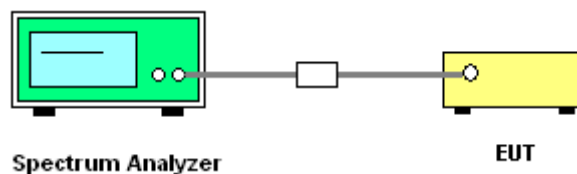



3.4.5 Test Result of Conducted Band Edges

Test Mode :	Bluetooth 4.0 - LE	Temperature :	24~26°C
Test Channel :	00 and 39	Relative Humidity :	50~53%
		Test Engineer :	Bill Kuo

Low Band Edge Plot on Channel 00

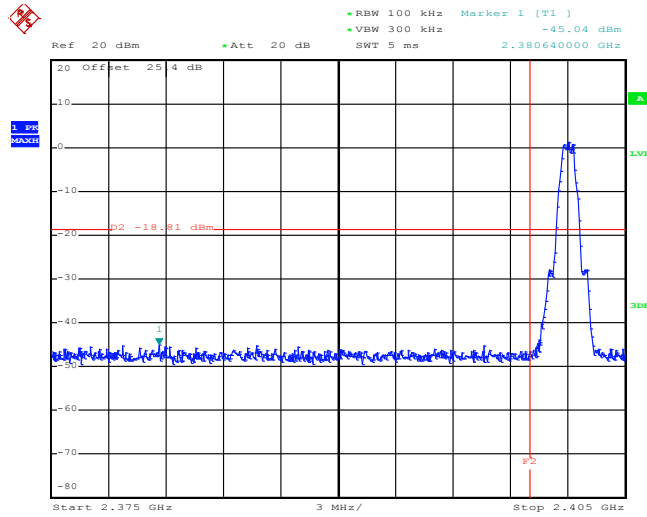

Date: 7.OCT.2012 12:36:42

High Band Edge Plot on Channel 39

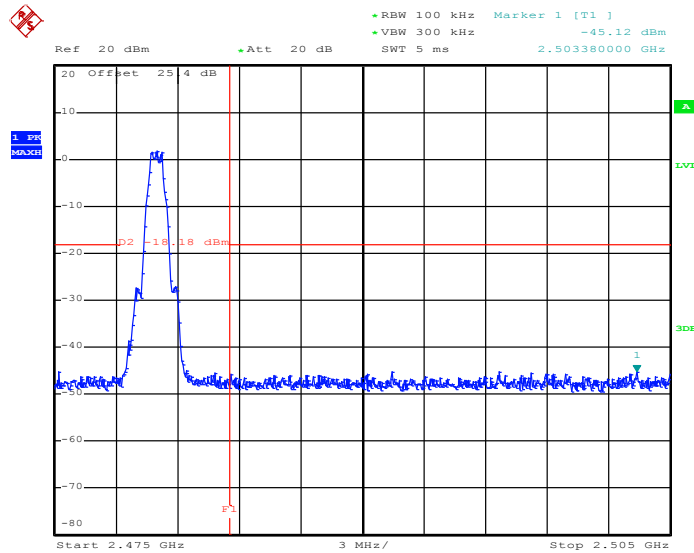

Date: 7.OCT.2012 13:07:34



3.4.6 Test Result of Conducted Spurious Emission

Test Mode :	Bluetooth 4.0 - LE	Temperature :	24~26°C
Test Channel :	00	Relative Humidity :	50~53%
		Test Engineer :	Bill Kuo

Conducted Spurious Emission Plot on Bluetooth LE 1Mbps
GFSK Channel 00

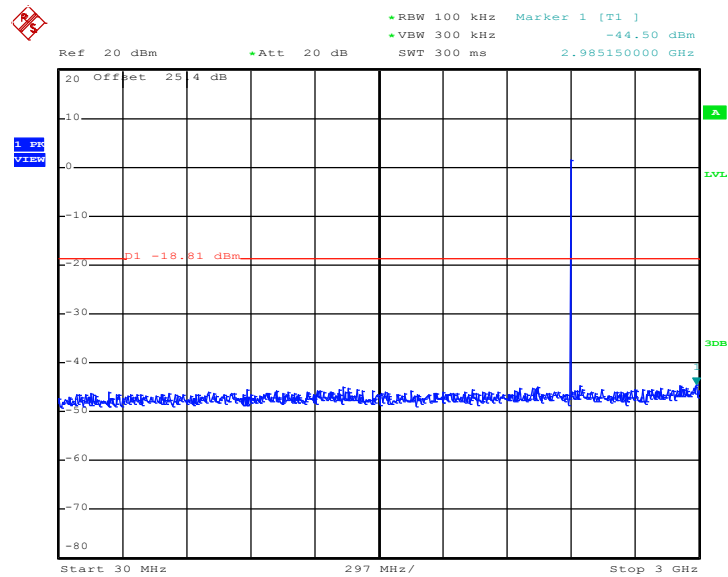

Date: 7.OCT.2012 12:37:30



Conducted Spurious Emission Plot on Bluetooth LE 1Mbps
GFSK Channel 00

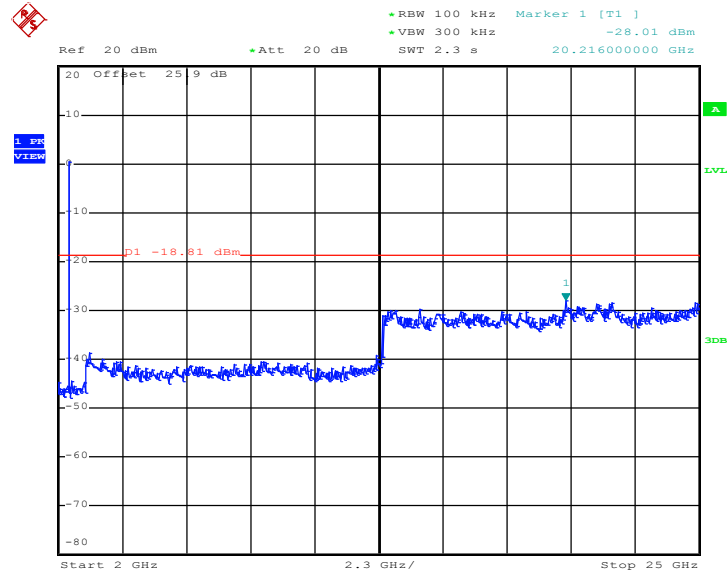

Date: 7.OCT.2012 12:37:47



Test Mode :	Bluetooth 4.0 - LE	Temperature :	24~26°C
Test Channel :	19	Relative Humidity :	50~53%
		Test Engineer :	Bill Kuo

Conducted Spurious Emission Plot on Bluetooth LE 1Mbps
GFSK Channel 19

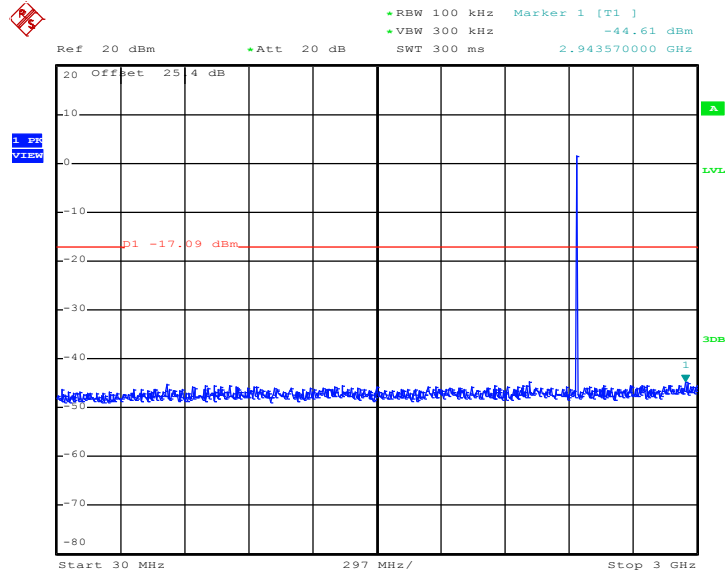

Date: 7.OCT.2012 13:05:06



Conducted Spurious Emission Plot on Bluetooth LE 1Mbps GFSK Channel 19

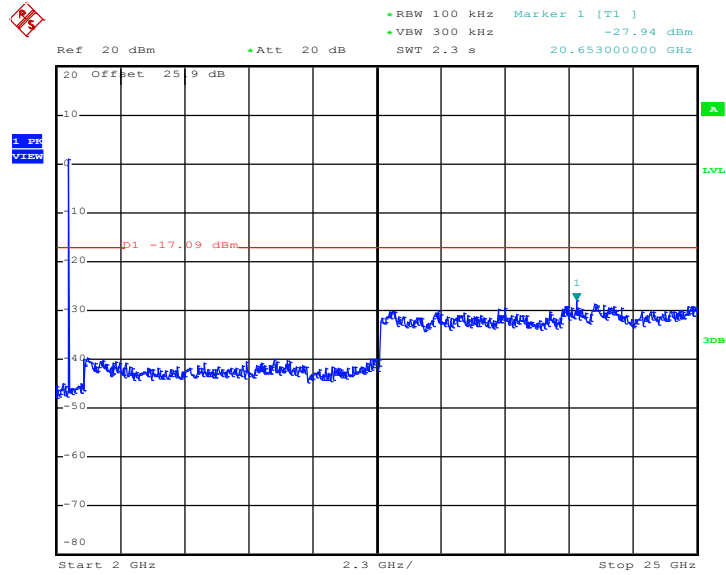

Date: 7.OCT.2012 13:05:23



Test Mode :	Bluetooth 4.0 - LE	Temperature :	24~26°C
Test Channel :	39	Relative Humidity :	50~53%
		Test Engineer :	Bill Kuo

Conducted Spurious Emission Plot on Bluetooth LE 1Mbps
GFSK Channel 39

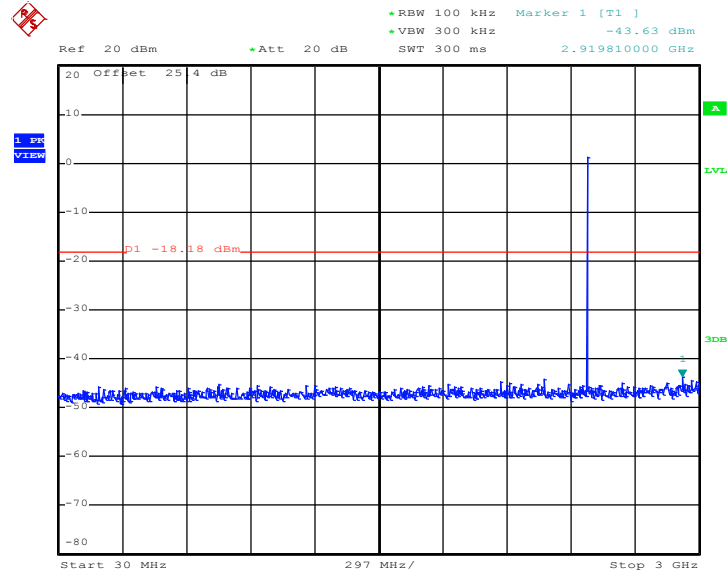

Date: 7.OCT.2012 13:07:55



Conducted Spurious Emission Plot on Bluetooth LE 1Mbps
GFSK Channel 39

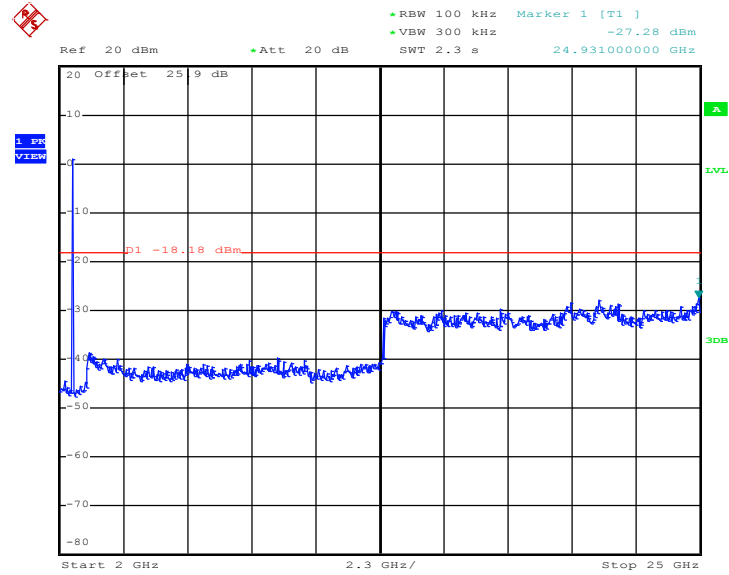

Date: 7.OCT.2012 13:08:13

3.5 Radiated Band Edges and Spurious Emission Measurement

3.5.1 Limit of Radiated Band Edges and Spurious Emission

In any 100 kHz bandwidth outside the intentional radiator frequency band, all harmonics/spurious must be at least 20 dB below the highest emission level within the authorized band. In addition, radiated emissions which fall in the restricted bands must also comply with the FCC section 15.209 limits as below.

Frequency (MHz)	Field Strength (microvolts/meter)	Measurement Distance (meters)
0.009 – 0.490	2400/F(kHz)	300
0.490 – 1.705	24000/F(kHz)	30
1.705 – 30.0	30	30
30 – 88	100	3
88 – 216	150	3
216 - 960	200	3
Above 960	500	3

3.5.2 Measuring Instruments

See list of measuring instruments of this test report.

3.5.3 Test Procedures

1. The testing follows the guidelines in ANSI C63.10-2009 and ANSI C63.4-2003 test site requirement.
2. The EUT was arranged to its worst case and then tune the antenna tower (from 1 m to 4 m) and turntable (from 0 degree to 360 degrees) to find the maximum reading. A pre-amp and a high pass filter are used for the test in order to get better signal level.
3. The EUT was placed on a turntable with 0.8 meter above ground.
4. The EUT was set 3 meters from the interference receiving antenna, which was mounted on the top of a variable height antenna tower.
5. Corrected Reading: Antenna Factor + Cable Loss + Read Level - Preamp Factor = Level
6. For measurement below 1GHz, If the emission level of the EUT measured by the peak detector is 3 dB lower than the applicable limit, the peak emission level will be reported. Otherwise, the emission measurement will be repeated using the quasi-peak detector and reported.
7. Use the following spectrum analyzer settings:
 - (1) Span shall wide enough to fully capture the emission being measured;



- (2) Set RBW=100 KHz for $f < 1$ GHz; $VBW \geq RBW$; Sweep = auto; Detector function = peak; Trace = max hold;
- (3) Set RBW = 1 MHz, VBW= 3MHz for $f \geq 1$ GHz for peak measurement.

For average measurement:

- $VBW = 10$ Hz, when duty cycle is no less than 98 percent.
- $VBW \geq 1/T$, when duty cycle is less than 98 percent where T is the minimum transmission duration over which the transmitter is on and is transmitting at its maximum power control level for the tested mode of operation.

Band	Duty Cycle(%)	T(us)	1/T(KHz)	VBW Setting
Bluetooth 4.0 - LE	67.52	424.00	2.358	3KHz

Note: For average measurement with duty cycle < 98%, use reduced VBW measurement method 4.2.3.2.3 in ANSI C63.10.

Marker-Delta method :

- (1) Set RBW = 1 MHz, VBW = 3 MHz, peak detector.
Repeat the measurement with an average detector, use RBW = 1MHz
 $VBW = 10$ Hz, when duty cycle is no less than 98 percent.
 $VBW \geq 1/T$, when duty cycle is less than 98 percent
- (2) Set span = 10MHz, that encompasses both the peak of the fundamental emission and the band-edge emission under investigation. Set RBW = 100KHz, 1% of the total span. Set VBW = 100KHz \geq RBW.
- (3) Subtract the delta measured in step (2) from the field strengths measured in step (1).
The resultant field strengths (peak/average) are then used to determine band-edge compliance as required by Section 15.205.

3.5.4 Test Setup

For radiated emissions below 30MHz

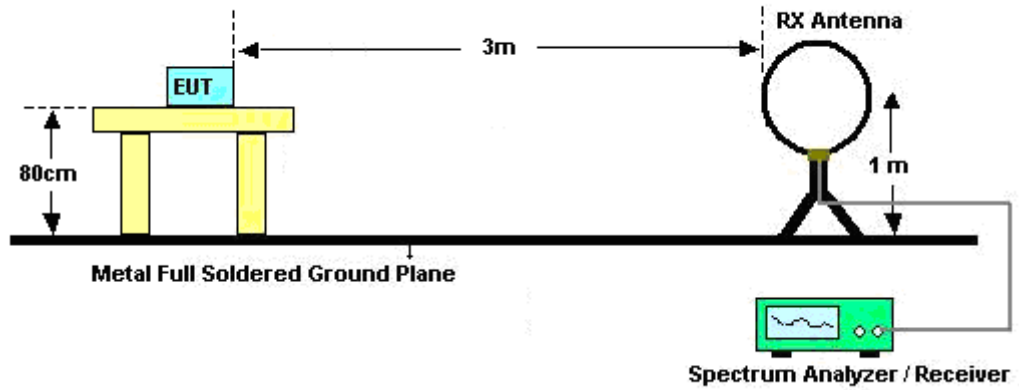

For radiated emissions from 30MHz to 1GHz

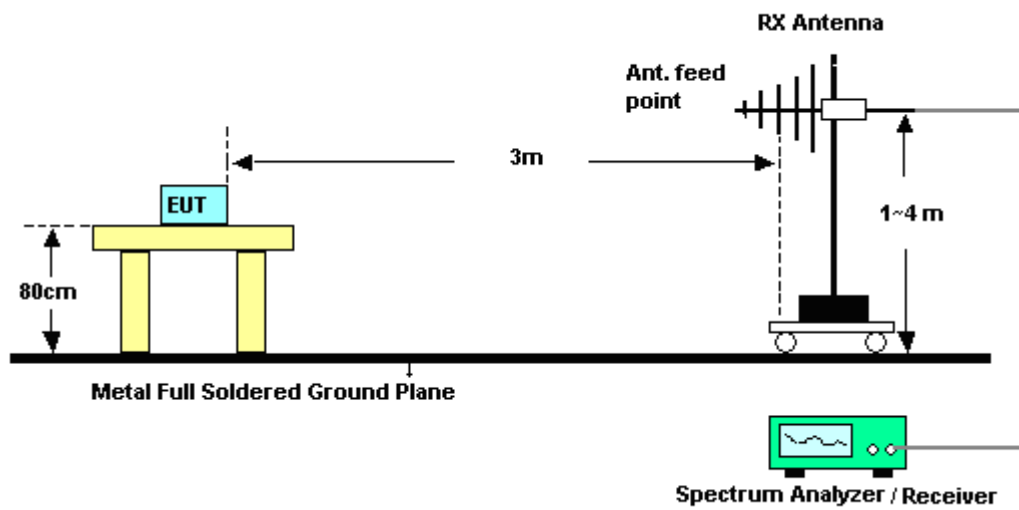

For radiated emissions above 1GHz

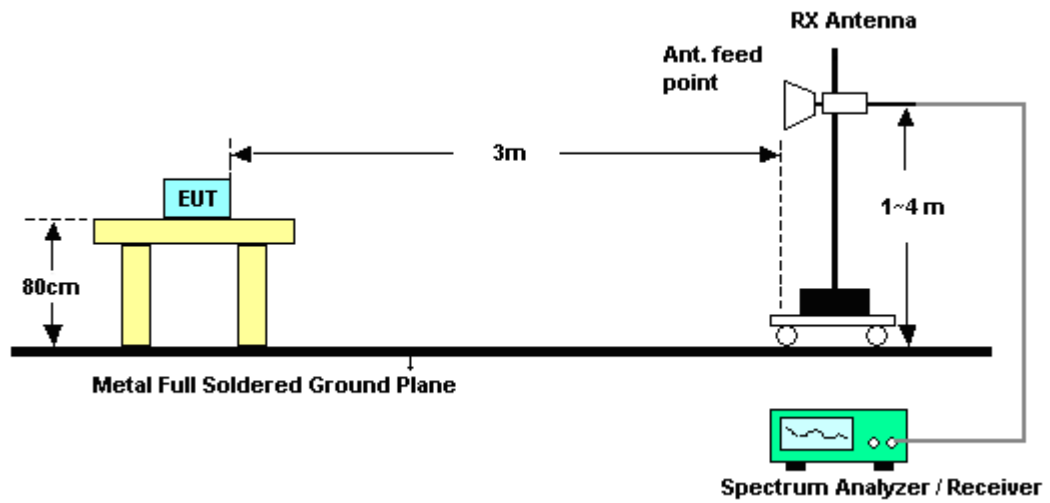

3.5.5 Test Results of Radiated Emissions (9 kHz ~ 30 MHz)

The low frequency, which started from 9 KHz to 30MHz, was pre-scanned and the result which was 20dB lower than the limit line per 15.31(o) was not reported.

3.5.6 Test Result of Radiated Band Edges

<Sample 1>

Test Mode :	Mode 1	Temperature :	30~31°C
Test Channel :	00	Relative Humidity :	42~43%
		Test Engineer :	Kai Wang, Timberland Lin, and Ivan Chiang

ANTENNA POLARITY : HORIZONTAL										
Frequency (MHz)	Level (dBuV/m)	Over Limit (dB)	Limit Line (dBuV/m)	Read Level (dBuV)	Antenna Factor (dB)	Cable Loss (dB)	Preamp Factor (dB)	Ant Pos (cm)	Table Pos (deg)	Remark
2347.98	50.44	-23.56	74	46.34	32.28	6.38	34.56	170	39	Peak
2390	35.02	-18.98	54	30.77	32.36	6.45	34.56	170	39	Average

ANTENNA POLARITY : VERTICAL										
Frequency (MHz)	Level (dBuV/m)	Over Limit (dB)	Limit Line (dBuV/m)	Read Level (dBuV)	Antenna Factor (dB)	Cable Loss (dB)	Preamp Factor (dB)	Ant Pos (cm)	Table Pos (deg)	Remark
2389.74	51.27	-22.73	74	47.02	32.36	6.45	34.56	101	239	Peak
2387.85	34.81	-19.19	54	30.56	32.36	6.45	34.56	101	239	Average

Test Mode :	Mode 3	Temperature :	30~31°C
Test Channel :	39	Relative Humidity :	42~43%
		Test Engineer :	Kai Wang, Timberland Lin, and Ivan Chiang

ANTENNA POLARITY : HORIZONTAL										
Frequency (MHz)	Level (dBuV/m)	Over Limit (dB)	Limit Line (dBuV/m)	Read Level (dBuV)	Antenna Factor (dB)	Cable Loss (dB)	Preamp Factor (dB)	Ant Pos (cm)	Table Pos (deg)	Remark
2483.92	51.2	-22.8	74	46.68	32.48	6.59	34.55	100	26	Peak
2483.5	36.95	-17.05	54	32.43	32.48	6.59	34.55	100	26	Average

ANTENNA POLARITY : VERTICAL										
Frequency (MHz)	Level (dBuV/m)	Over Limit (dB)	Limit Line (dBuV/m)	Read Level (dBuV)	Antenna Factor (dB)	Cable Loss (dB)	Preamp Factor (dB)	Ant Pos (cm)	Table Pos (deg)	Remark
2483.68	51.44	-22.56	74	46.92	32.48	6.59	34.55	179	244	Peak
2483.92	36	-18	54	31.48	32.48	6.59	34.55	179	244	Average

<Sample 2>

Test Mode :	Mode 4	Temperature :	30~31°C
Test Channel :	39	Relative Humidity :	42~43%
		Test Engineer :	Kai Wang, Timberland Lin, and Ivan Chiang

ANTENNA POLARITY : HORIZONTAL										
Frequency (MHz)	Level (dB μ V/m)	Over Limit (dB)	Limit Line (dB μ V/m)	Read Level (dB μ V)	Antenna Factor (dB)	Cable Loss (dB)	Preamp Factor (dB)	Ant Pos (cm)	Table Pos (deg)	Remark
2483.54	57.24	-16.76	74	52.72	32.48	6.59	34.55	101	280	Peak
2483.5	53.54	*-0.46	54	49.02	32.48	6.59	34.55	101	280	Average
2483.5	43.09	-30.91	74	-	-	-	-	-	-	Peak
2483.5	41.86	-12.14	54	-	-	-	-	-	-	Average

Summary results of marker-delta method:

Test mode	Maximum field strength of the fundamental emission (dB μ V/m)	Delta Result (dB)	Measurement Result (dB μ V/m)	Limit (dB μ V/m)	Margin (dB)	Result
Peak	95.33	52.24	43.09	74	-30.91	Pass
Average	94.1	52.24	41.86	54	-12.14	Pass

Note :

1. Measurement result = Maximum field strength – Delta result
2. *Delta-Marker Method is used for the 2483.5MHz average measurement as described in the test procedure of this report and the test result is under 12.14dB.

ANTENNA POLARITY : VERTICAL										
Frequency (MHz)	Level (dB μ V/m)	Over Limit (dB)	Limit Line (dB μ V/m)	Read Level (dB μ V)	Antenna Factor (dB)	Cable Loss (dB)	Preamp Factor (dB)	Ant Pos (cm)	Table Pos (deg)	Remark
2483.5	51.12	-22.88	74	46.6	32.48	6.59	34.55	190	242	Peak
2483.5	46.3	-7.7	54	41.78	32.48	6.59	34.55	190	242	Average
2483.5	40.39	-33.61	74	-	-	-	-	-	-	Peak
2483.5	39.62	-14.38	54	-	-	-	-	-	-	Average

Summary results of marker-delta method:

Test mode	Maximum field strength of the fundamental emission (dB μ V/m)	Delta Result (dB)	Measurement Result (dB μ V/m)	Limit (dB μ V/m)	Margin (dB)	Result
Peak	88.1	47.71	40.39	74	-33.61	Pass
Average	87.33	47.71	39.62	54	-14.38	Pass

Note : Measurement result = Maximum field strength – Delta result



Test Mode :	Mode 4	Temperature :	30~31°C
Test Channel :	39	Relative Humidity :	42~43%
Test Engineer :	Kai Wang, Timberland Lin, and Ivan Chiang	Polarization :	Horizontal

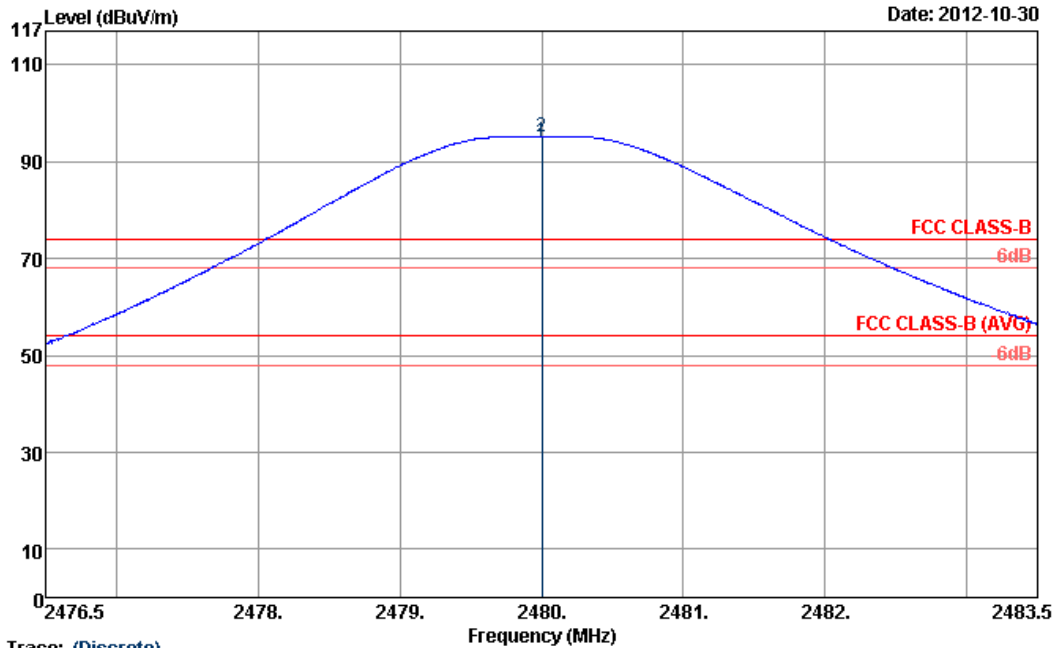

Trace: (Discrete)

Site : 03CH06-HY
 Condition : FCC CLASS-B 3m HF-ANT_120801 HORIZONTAL
 : RBW:1000.000KHz VBW:3000.000KHz SWT:Auto

	Freq	Level	Over Limit	Limit Line	ReadAntenna Level	Antenna Factor	Cable Loss	Preamp Factor	A/Pos	T/Pos	Remark
	MHz	dBuV/m	dB	dBuV/m	dBuV	dB/m	dB	dB	cm	deg	
1 *	2480.00	94.10	40.10	54.00	89.58	32.48	6.59	34.55	101	280	Average
2 *	2480.00	95.33	21.33	74.00	90.81	32.48	6.59	34.55	101	280	Peak

* Maximum field strength of the fundamental emission



Test Mode :	Mode 4	Temperature :	30~31°C
Test Channel :	39	Relative Humidity :	42~43%
Test Engineer :	Kai Wang, Timberland Lin, and Ivan Chiang	Polarization :	Horizontal

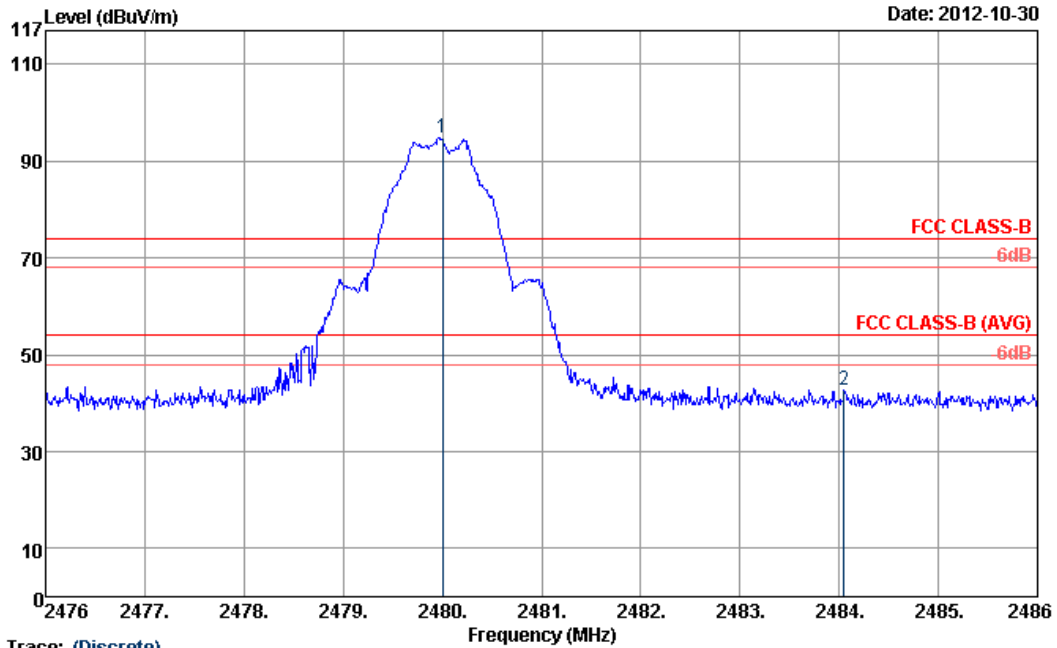

Trace: (Discrete)
 Site : 03CH06-HY
 Condition : FCC CLASS-B 3m HF-ANT_120801 HORIZONTAL
 : RBW:100.000KHz VBW:100.000KHz SWT:Auto

	Freq	Level	Over Limit	Limit Line	ReadAntenna Level	Antenna Factor	Cable Loss	Preamp Factor	A/Pos	T/Pos	Remark
	MHz	dBuV/m	dB	dBuV/m	dBuV	dB/m	dB	dB	cm	deg	
1 *	2480.00	94.83	20.83	74.00	90.31	32.48	6.59	34.55	101	280	Peak
2	2484.05	42.59	-31.41	74.00	38.07	32.48	6.59	34.55	101	280	Peak

* Marker-Delta Method (RBW/VBW=100KHz): 52.24 dB , single carrier Mode



Test Mode :	Mode 4	Temperature :	30~31°C
Test Channel :	39	Relative Humidity :	42~43%
Test Engineer :	Kai Wang, Timberland Lin, and Ivan Chiang	Polarization :	Vertical

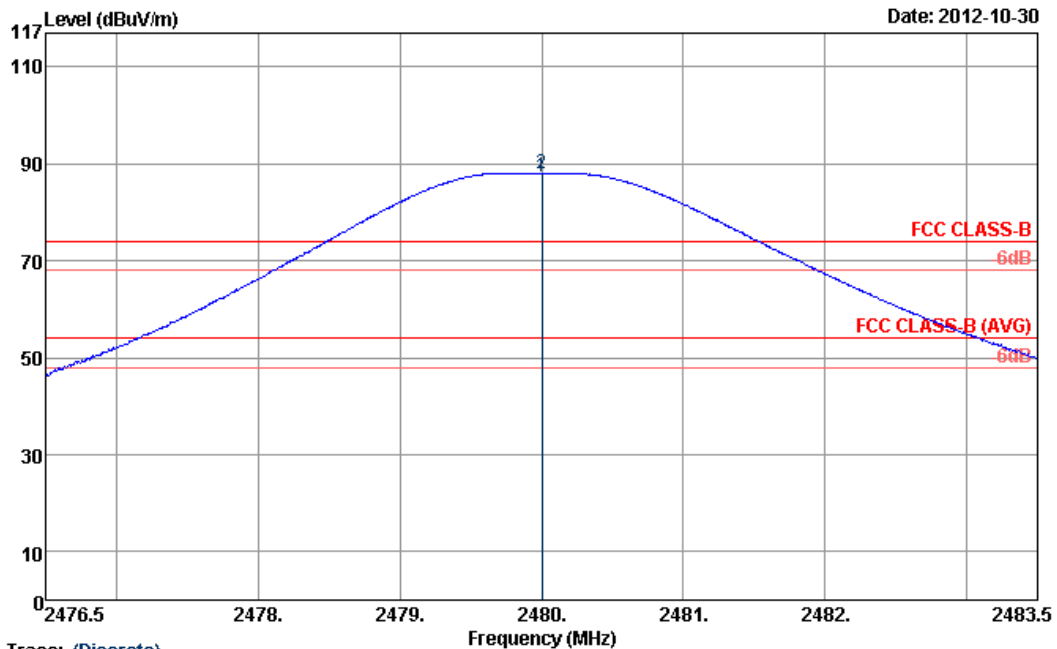

Trace: (Discrete)
 Site : 03CH06-HY
 Condition : FCC CLASS-B 3m HF-ANT_120801 VERTICAL
 : RBW:1000.000KHz VBW:3000.000KHz SWT:Auto

	Freq	Level	Over Limit	Limit Line	ReadAntenna Level	Antenna Factor	Cable Loss	Preamplifier	A/Pos	T/Pos	Remark
	MHz	dBuV/m	dB	dBuV/m	dBuV	dB/m	dB	dB	cm	deg	
1 *	2480.00	87.33	33.33	54.00	82.81	32.48	6.59	34.55	190	242	Average
2 *	2480.00	88.10	34.10	54.00	83.58	32.48	6.59	34.55	190	242	Peak

* Maximum field strength of the fundamental emission



Test Mode :	Mode 4	Temperature :	30~31°C
Test Channel :	39	Relative Humidity :	42~43%
Test Engineer :	Kai Wang, Timberland Lin, and Ivan Chiang	Polarization :	Vertical

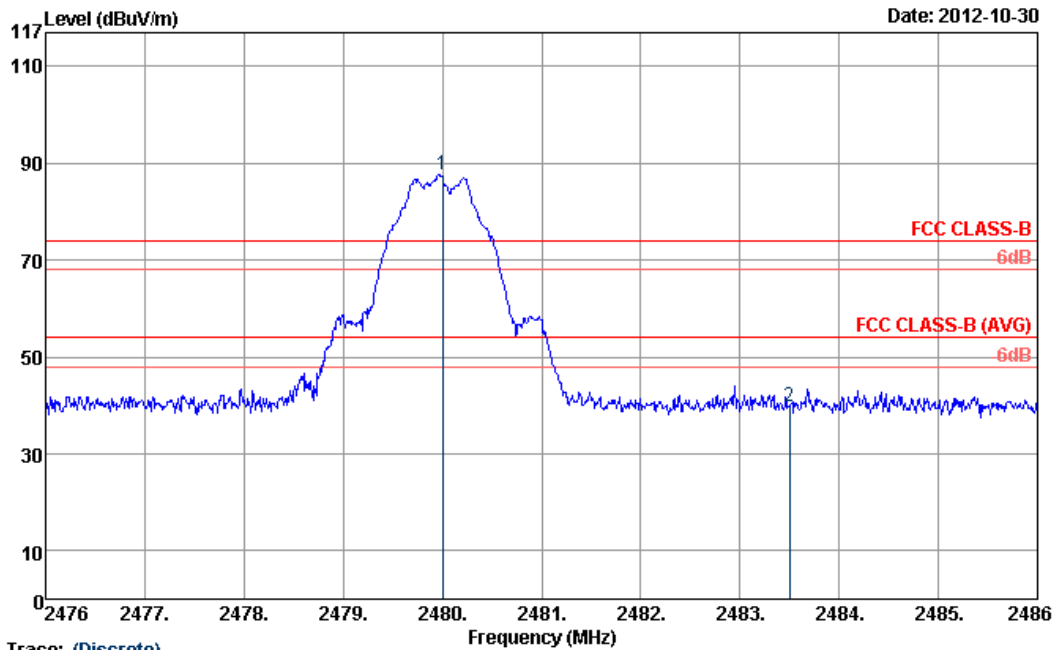

Trace: (Discrete)
 Site : 03CH06-HY
 Condition : FCC CLASS-B 3m HF-ANT_120801 VERTICAL
 : RBW:100.000KHz VBW:100.000KHz SWT:Auto

	Freq	Level	Over Limit	Limit Line	ReadAntenna Level	Antenna Factor	Cable Loss	Preamp Factor	A/Pos	T/Pos	Remark
	MHz	dBuV/m	dB	dBuV/m	dBuV	dB/m	dB	dB	cm	deg	
1 *	2480.00	87.56	33.56	54.00	83.04	32.48	6.59	34.55	190	242	Peak
2	2483.50	39.85	-14.15	54.00	35.33	32.48	6.59	34.55	190	242	Peak

* Marker-Delta Method (RBW/VBW=100KHz): 47.71 dB , single carrier Mode

3.5.7 Test Result of Radiated Emission (30 MHz ~ 10th Harmonic)

<Sample 1>

Test Mode :	Mode 1	Temperature :	30~31°C
Test Channel :	00	Relative Humidity :	42~43%
Test Engineer :	Kai Wang, Timberland Lin, and Ivan Chiang	Polarization :	Horizontal
Remark :	1. 2402 MHz is fundamental signal which can be ignored. 2. Test result of emissions which are 20 dB lower than the limit is not reported per15.31.		

Frequency (MHz)	Level (dBuV/m)	Over Limit (dB)	Limit Line (dBuV/m)	Read Level (dBuV)	Antenna Factor (dB)	Cable Loss (dB)	Preamp Factor (dB)	Ant Pos (cm)	Table Pos (deg)	Remark
2402	96.24	-	-	91.99	32.36	6.45	34.56	170	39	Average
2402	97.18	-	-	92.93	32.36	6.45	34.56	170	39	Peak

Test Mode :	Mode 1	Temperature :	30~31°C
Test Channel :	00	Relative Humidity :	42~43%
Test Engineer :	Kai Wang, Timberland Lin, and Ivan Chiang	Polarization :	Vertical
Remark :	1. 2402 MHz is fundamental signal which can be ignored. 2. Test result of emissions which are 20 dB lower than the limit is not reported per15.31.		

Frequency (MHz)	Level (dBuV/m)	Over Limit (dB)	Limit Line (dBuV/m)	Read Level (dBuV)	Antenna Factor (dB)	Cable Loss (dB)	Preamp Factor (dB)	Ant Pos (cm)	Table Pos (deg)	Remark
2402	87.46	-	-	83.21	32.36	6.45	34.56	101	239	Average
2402	88.48	-	-	84.23	32.36	6.45	34.56	101	239	Peak



Test Mode :	Mode 2	Temperature :	30~31°C
Test Channel :	19	Relative Humidity :	42~43%
Test Engineer :	Kai Wang, Timberland Lin, and Ivan Chiang	Polarization :	Horizontal
Remark :	1. 2440 MHz is fundamental signal which can be ignored. 2. Test result of emissions which are 20 dB lower than the limit is not reported per15.31.		

Frequency (MHz)	Level (dBuV/m)	Over Limit (dB)	Limit Line (dBuV/m)	Read Level (dBuV)	Antenna Factor (dB)	Cable Loss (dB)	Preamp Factor (dB)	Ant Pos (cm)	Table Pos (deg)	Remark
2440	98.1	-	-	93.71	32.43	6.52	34.56	102	17	Average
2440	98.73	-	-	94.34	32.43	6.52	34.56	102	17	Peak

Test Mode :	Mode 2	Temperature :	30~31°C
Test Channel :	19	Relative Humidity :	42~43%
Test Engineer :	Kai Wang, Timberland Lin, and Ivan Chiang	Polarization :	Vertical
Remark :	1. 2440 MHz is fundamental signal which can be ignored. 2. Test result of emissions which are 20 dB lower than the limit is not reported per15.31.		

Frequency (MHz)	Level (dBuV/m)	Over Limit (dB)	Limit Line (dBuV/m)	Read Level (dBuV)	Antenna Factor (dB)	Cable Loss (dB)	Preamp Factor (dB)	Ant Pos (cm)	Table Pos (deg)	Remark
2440	89.47	-	-	85.08	32.43	6.52	34.56	160	360	Average
2440	90.19	-	-	85.8	32.43	6.52	34.56	160	360	Peak



Test Mode :	Mode 3	Temperature :	30~31°C
Test Channel :	39	Relative Humidity :	42~43%
Test Engineer :	Kai Wang, Timberland Lin, and Ivan Chiang	Polarization :	Horizontal
Remark :	1. 2480 MHz is fundamental signal which can be ignored. 2. Test result of emissions which are 20 dB lower than the limit is not reported per15.31.		

Frequency (MHz)	Level (dBuV/m)	Over Limit (dB)	Limit Line (dBuV/m)	Read Level (dBuV)	Antenna Factor (dB)	Cable Loss (dB)	Preamp Factor (dB)	Ant Pos (cm)	Table Pos (deg)	Remark
46.2	18.53	-21.47	40	40.3	9.33	0.6	31.7	-	-	Peak
121.26	22.26	-21.24	43.5	40.77	11.88	1.32	31.71	100	57	Peak
223.86	23.36	-22.64	46	43.33	9.54	2.13	31.64	-	-	Peak
548.5	22.81	-23.19	46	32.65	19.06	2.98	31.88	-	-	Peak
737.5	22.98	-23.02	46	31.76	19.74	3.56	32.08	-	-	Peak
856.5	24.56	-21.44	46	32.14	20.4	3.89	31.87	-	-	Peak
2480	96.72	-	-	92.2	32.48	6.59	34.55	100	26	Average
2480	97.35	-	-	92.83	32.48	6.59	34.55	100	26	Peak



Test Mode :	Mode 3	Temperature :	30~31°C
Test Channel :	39	Relative Humidity :	42~43%
Test Engineer :	Kai Wang, Timberland Lin, and Ivan Chiang	Polarization :	Vertical
Remark :	1. 2480 MHz is fundamental signal which can be ignored. 2. Test result of emissions which are 20 dB lower than the limit is not reported per15.31.		

Frequency (MHz)	Level (dBuV/m)	Over Limit (dB)	Limit Line (dBuV/m)	Read Level (dBuV)	Antenna Factor (dB)	Cable Loss (dB)	Preamp Factor (dB)	Ant Pos (cm)	Table Pos (deg)	Remark
47.55	31.09	-8.91	40	53.07	9.1	0.62	31.7	100	87	Peak
114.24	22.39	-21.11	43.5	41.09	11.8	1.21	31.71	-	-	Peak
218.46	16.59	-29.41	46	37.14	9.06	2.06	31.67	-	-	Peak
578.6	22.07	-23.93	46	32.19	18.89	3.01	32.02	-	-	Peak
681.5	23.18	-22.82	46	32.62	19.06	3.5	32	-	-	Peak
863.5	23.79	-22.21	46	31.31	20.43	3.87	31.82	-	-	Peak
2480	89.53	-	-	85.01	32.48	6.59	34.55	179	244	Average
2480	90.04	-	-	85.52	32.48	6.59	34.55	179	244	Peak



<Sample 2>

Test Mode :	Mode 3	Temperature :	30~31°C
Test Channel :	39	Relative Humidity :	42~43%
Test Engineer :	Kai Wang, Timberland Lin, and Ivan Chiang	Polarization :	Horizontal
Remark :	1. 2480 MHz is fundamental signal which can be ignored. 2. Test result of emissions which are 20 dB lower than the limit is not reported per15.31.		

Frequency (MHz)	Level (dBuV/m)	Over Limit (dB)	Limit Line (dBuV/m)	Read Level (dBuV)	Antenna Factor (dB)	Cable Loss (dB)	Preamp Factor (dB)	Ant Pos (cm)	Table Pos (deg)	Remark
39.45	26.01	-13.99	40	44.5	12.7	0.51	31.7	100	249	Peak
129.9	25.23	-18.27	43.5	43.74	11.8	1.39	31.7	-	-	Peak
215.76	28.49	-15.01	43.5	49.12	9.02	2.01	31.66	-	-	Peak
415.5	18.46	-27.54	46	31.46	16.4	2.42	31.82	-	-	Peak
706	21.81	-24.19	46	31.22	19.06	3.55	32.02	-	-	Peak
938.4	24.38	-21.62	46	31.02	20.78	3.81	31.23	-	-	Peak
2480	94.46	-	-	89.94	32.48	6.59	34.55	101	280	Average
2480	95.06	-	-	90.54	32.48	6.59	34.55	101	280	Peak



Test Mode :	Mode 3	Temperature :	30~31°C
Test Channel :	39	Relative Humidity :	42~43%
Test Engineer :	Kai Wang, Timberland Lin, and Ivan Chiang	Polarization :	Vertical
Remark :	1. 2480 MHz is fundamental signal which can be ignored. 2. Test result of emissions which are 20 dB lower than the limit is not reported per15.31.		

Frequency (MHz)	Level (dBuV/m)	Over Limit (dB)	Limit Line (dBuV/m)	Read Level (dBuV)	Antenna Factor (dB)	Cable Loss (dB)	Preamp Factor (dB)	Ant Pos (cm)	Table Pos (deg)	Remark
40.8	32.65	-7.35	40	51.71	12.12	0.52	31.7	100	134	Peak
105.33	24.58	-18.92	43.5	43.55	11.64	1.08	31.69	-	-	Peak
262.2	31.69	-14.31	46	47.68	13.54	2.18	31.71	-	-	Peak
466.6	19.17	-26.83	46	31.19	17.16	2.64	31.82	-	-	Peak
730.5	22.33	-23.67	46	31.24	19.6	3.56	32.07	-	-	Peak
923	23.84	-22.16	46	30.73	20.7	3.79	31.38	-	-	Peak
2480	86.87	-	-	82.35	32.48	6.59	34.55	190	242	Average
2480	87.82	-	-	83.3	32.48	6.59	34.55	190	242	Peak

3.6 AC Conducted Emission Measurement

3.6.1 Limit of AC Conducted Emission

For equipment that is designed to be connected to the public utility (AC) power line, the radio frequency voltage that is conducted back onto the AC power line on any frequency or frequencies within the band 150 kHz to 30 MHz shall not exceed the limits in the following table.

Frequency of emission (MHz)	Conducted limit (dBuV)	
	Quasi-peak	Average
0.15-0.5	66 to 56*	56 to 46*
0.5-5	56	46
5-30	60	50

*Decreases with the logarithm of the frequency.

3.6.2 Measuring Instruments

See list of measuring instruments of this test report.

3.6.3 Test Procedures

1. The testing follows the guidelines in ANSI C63.10-2009 and ANSI C63.4-2003 test site requirement.
2. The EUT was placed 0.4 meter from the conducting wall of the shielding room was kept at least 80 centimeters from any other grounded conducting surface.
3. Connect EUT to the power mains through a line impedance stabilization network (LISN).
4. All the support units are connecting to the other LISN.
5. The LISN provides 50 ohm coupling impedance for the measuring instrument.
6. The FCC states that a 50 ohm, 50 microhenry LISN should be used.
7. Both sides of AC line were checked for maximum conducted interference.
8. The frequency range from 150 kHz to 30 MHz was searched.
9. Set the test-receiver system to Peak Detect Function and specified bandwidth with Maximum Hold Mode.

3.6.4 Test Setup



3.6.5 Test Result of AC Conducted Emission

Test Mode :	Mode 1	Temperature :	20~22°C
Test Engineer :	Slash Huang	Relative Humidity :	48~50%
Test Voltage :	120Vac / 60Hz	Phase :	Line
Function Type :	GSM850 Idle + Bluetooth Link + WLAN (2.4G) Link + Earphone + Battery 1 + USB Cable 1 (Charging from Adapter 1) + NFC On for Sample 1		
Remark :	All emissions not reported here are more than 10 dB below the prescribed limit.		

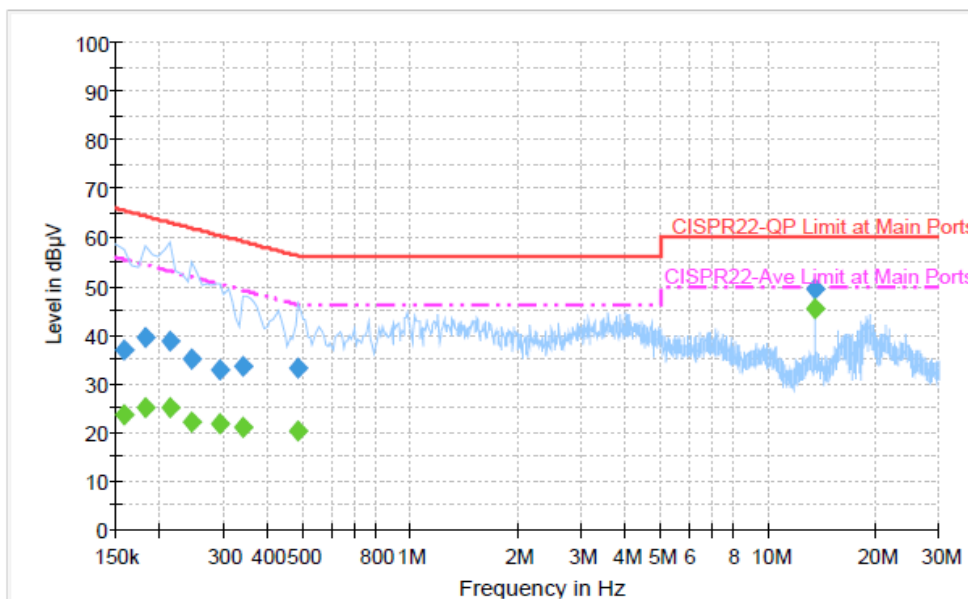

Final Result : Quasi-Peak

Frequency (MHz)	Quasi-Peak (dBµV)	Filter	Line	Corr. (dB)	Margin (dB)	Limit (dBµV)
0.158000	36.8	Off	L1	19.3	28.8	65.6
0.182000	39.4	Off	L1	19.4	25.0	64.4
0.214000	38.9	Off	L1	19.4	24.1	63.0
0.246000	35.0	Off	L1	19.4	26.9	61.9
0.294000	32.7	Off	L1	19.4	27.7	60.4
0.342000	33.5	Off	L1	19.4	25.7	59.2
0.486000	33.1	Off	L1	19.4	23.1	56.2
13.558000	49.3	Off	L1	19.8	10.7	60.0

Final Result : Average

Frequency (MHz)	Average (dBµV)	Filter	Line	Corr. (dB)	Margin (dB)	Limit (dBµV)
0.158000	23.8	Off	L1	19.3	31.8	55.6
0.182000	25.0	Off	L1	19.4	29.4	54.4
0.214000	25.1	Off	L1	19.4	27.9	53.0
0.246000	22.2	Off	L1	19.4	29.7	51.9
0.294000	21.9	Off	L1	19.4	28.5	50.4
0.342000	21.0	Off	L1	19.4	28.2	49.2
0.486000	20.3	Off	L1	19.4	25.9	46.2
13.558000	45.4	Off	L1	19.8	4.6	50.0

Test Mode :	Mode 1	Temperature :	20~22°C
Test Engineer :	Slash Huang	Relative Humidity :	48~50%
Test Voltage :	120Vac / 60Hz	Phase :	Neutral
Function Type :	GSM850 Idle + Bluetooth Link + WLAN (2.4G) Link + Earphone + Battery 1 + USB Cable 1 (Charging from Adapter 1) + NFC On for Sample 1		
Remark :	All emissions not reported here are more than 10 dB below the prescribed limit.		

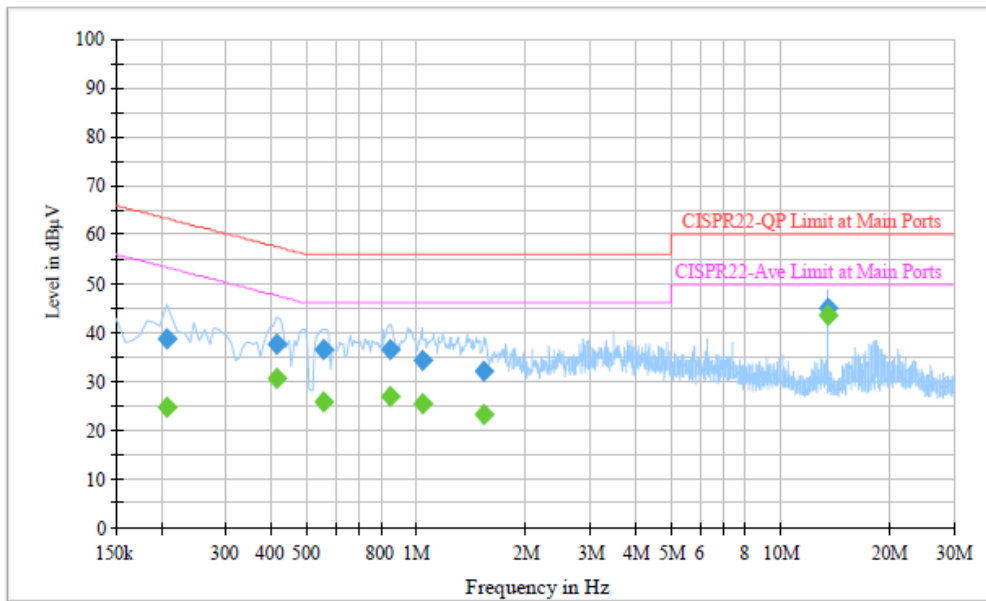

Final Result : Quasi-Peak

Frequency (MHz)	Quasi-Peak (dBµV)	Filter	Line	Corr. (dB)	Margin (dB)	Limit (dBµV)
0.206000	38.7	Off	N	19.4	24.7	63.4
0.414000	37.6	Off	N	19.4	20.0	57.6
0.558000	36.6	Off	N	19.4	19.4	56.0
0.846000	36.7	Off	N	19.6	19.3	56.0
1.038000	34.3	Off	N	19.5	21.7	56.0
1.534000	32.2	Off	N	19.4	23.8	56.0
13.558000	45.0	Off	N	19.9	15.0	60.0

Final Result : Average

Frequency (MHz)	Average (dBµV)	Filter	Line	Corr. (dB)	Margin (dB)	Limit (dBµV)
0.206000	24.6	Off	N	19.4	28.8	53.4
0.414000	30.8	Off	N	19.4	16.8	47.6
0.558000	25.9	Off	N	19.4	20.1	46.0
0.846000	27.0	Off	N	19.6	19.0	46.0
1.038000	25.6	Off	N	19.5	20.4	46.0
1.534000	23.1	Off	N	19.4	22.9	46.0
13.558000	43.5	Off	N	19.9	6.5	50.0



3.7 Antenna Requirements

3.7.1 Standard Applicable

If directional gain of transmitting antennas is greater than 6dBi, the power shall be reduced by the same level in dB comparing to gain minus 6dBi. The use of a permanently attached antenna or of an antenna that uses a unique coupling to the intentional radiator shall be considered sufficient to comply with the FCC rule.

3.7.2 Antenna Connected Construction

Non-standard connector used.

3.7.3 Antenna Gain

The antenna peak gain of EUT is less than 6 dBi. Therefore, it is not necessary to reduce maximum peak output power limit.



4 List of Measuring Equipment

Instrument	Manufacturer	Model No.	Serial No.	Characteristics	Calibration Date	Test Date	Due Date	Remark
Spectrum Analyzer	R&S	FSP40	100055	9kHz~40GHz	Jun. 06, 2012	Sep. 30, 2012 ~ Oct. 07, 2012	Jun. 05, 2013	Conducted (TH02-HY)
EMI Test Receiver	R&S	ESCI 7	100724	9kHz~7GHz	Sep. 03, 2012	Oct. 02, 2012 ~ Oct. 26, 2012	Sep. 02, 2013	Conduction (CO05-HY)
Two-LISN	R&S	ENV216	11-100081	9KHz ~ 30MHz	Dec. 09, 2011	Oct. 02, 2012 ~ Oct. 26, 2012	Dec. 08, 2012	Conduction (CO05-HY)
Two-LISN	R&S	ENV216	11-100080	9KHz ~ 30MHz	Dec. 06, 2011	Oct. 02, 2012 ~ Oct. 26, 2012	Dec. 05, 2012	Conduction (CO05-HY)
AC Power Source	APC	APC-1000W	N/A	N/A	N/A	Oct. 02, 2012 ~ Oct. 26, 2012	N/A	Conduction (CO05-HY)
System Simulator	R&S	CMU200	117995	N/A	Jul. 28, 2011	Oct. 02, 2012 ~ Oct. 26, 2012	Jul. 27, 2013	Conduction (CO05-HY)
Spectrum Analyzer	Agilent	E4408B	MY44211030	9KHz ~ 26.5GHz	Nov. 23, 2011	Oct. 07, 2012 ~ Oct. 30, 2012	Nov. 22, 2012	Radiation (03CH06-HY)
EMI Test Receiver	R&S	ESVS10	834468/003	20MHz ~ 1000MHz	May 04, 2012	Oct. 07, 2012 ~ Oct. 30, 2012	May. 03, 2013	Radiation (03CH06-HY)
Bilog Antenna	SCHAFFNER	CBL6112B	2885	30MHz ~ 2GHz	Oct. 06, 2012	Oct. 07, 2012 ~ Oct. 30, 2012	Oct. 05, 2013	Radiation (03CH06-HY)
Double Ridge Horn Antenna	EMCO	3117	00066583	1GHz ~ 18GHz	Aug. 01, 2012	Oct. 07, 2012 ~ Oct. 30, 2012	Jul. 31, 2013	Radiation (03CH06-HY)
SHF-EHF Horn Antenna	SCHWARZBECK	BBHA 9170	BBHA9170251	15GHz ~ 40GHz	Sep. 28, 2012	Oct. 07, 2012 ~ Oct. 30, 2012	Sep. 27, 2013	Radiation (03CH06-HY)
Preamplifier	Agilent	8449B	3008A01917	1GHz ~ 26.5GHz	Apr. 13, 2012	Oct. 07, 2012 ~ Oct. 30, 2012	Apr. 12, 2013	Radiation (03CH06-HY)
Amplifier	Agilent	310N	186713	9KHz ~ 1GHz	Apr. 11, 2012	Oct. 07, 2012 ~ Oct. 30, 2012	Apr. 10, 2013	Radiation (03CH06-HY)
Pre Amplifier	EMCI	EMC051845	SN980048	1GHz ~ 18GHz	Jul. 21, 2012	Oct. 07, 2012 ~ Oct. 30, 2012	Jul. 20, 2013	Radiation (03CH06-HY)
Pre Amplifier	MITEQ	AMF-7D-00101800-30-10P	159087	1GHz~18GHz	Feb. 27, 2012	Oct. 07, 2012 ~ Oct. 30, 2012	Feb. 26, 2013	Radiation (03CH06-HY)
Loop Antenna	R&S	HFH2-Z2	860004/001	9KHz ~ 30MHz	Jul. 03, 2012	Oct. 07, 2012 ~ Oct. 30, 2012	Jul. 02, 2014	Radiation (03CH06-HY)



5 Uncertainty of Evaluation

Uncertainty of Conducted Emission Measurement (150 kHz ~ 30 MHz)

Measuring Uncertainty for a Level of Confidence of 95% ($U = 2Uc(y)$)	2.26
---	------

Uncertainty of Radiated Emission Measurement (30 MHz ~ 1000 MHz)

Measuring Uncertainty for a Level of Confidence of 95% ($U = 2Uc(y)$)	2.54
---	------

Uncertainty of Radiated Emission Measurement (1 GHz ~ 40 GHz)

Measuring Uncertainty for a Level of Confidence of 95% ($U = 2Uc(y)$)	4.72
---	------