



FCC TEST REPORT (BLUETOOTH)

REPORT NO.: RF120522C28-3

MODEL NO.: PL01210

FCC ID: NM8PL01210

RECEIVED: May 22, 2012

TESTED: Jun. 07 ~ Jul. 04, 2012

ISSUED: Jul. 10, 2012

APPLICANT: HTC Corporation

ADDRESS: No. 23, Xinghua Rd., Taoyuan City, Taiwan

ISSUED BY: Bureau Veritas Consumer Products Services (H.K.)
Ltd., Taoyuan Branch

LAB ADDRESS: No. 47, 14th Ling, Chia Pau Vil., Lin Kou Dist., New
Taipei City, Taiwan (R.O.C)

TEST LOCATION: No. 19, Hwa Ya 2nd Rd, Wen Hwa Tsuen, Kwei
Shan Hsiang, Taoyuan Hsien 333, Taiwan, R.O.C.

This report should not be used by the client to claim product certification, approval, or endorsement by TAF or any government agencies.



This report is for your exclusive use. Any copying or replication of this report to or for any other person or entity, or use of our name or trademark, is permitted only with our prior written permission. This report sets forth our findings solely with respect to the test samples identified herein. The results set forth in this report are not indicative or representative of the quality or characteristics of the lot from which a test sample was taken or any similar or identical product unless specifically and expressly noted. Our report includes all of the tests requested by you and the results thereof based upon the information that you provided to us. You have 60 days from date of issuance of this report to notify us of any material error or omission caused by our negligence, provided, however, that such notice shall be in writing and shall specifically address the issue you wish to raise. A failure to raise such issue within the prescribed time shall constitute your unqualified acceptance of the completeness of this report, the tests conducted and the correctness of the report contents. Unless specific mention, the uncertainty of measurement has been explicitly taken into account to declare the compliance or non-compliance to the specification

Table of Contents

RELEASE CONTROL RECORD	5
1. CERTIFICATION.....	6
2. SUMMARY OF TEST RESULTS.....	7
2.1 MEASUREMENT UNCERTAINTY	8
3. GENERAL INFORMATION	9
3.1 GENERAL DESCRIPTION OF EUT.....	9
3.2 DESCRIPTION OF TEST MODES.....	10
3.2.1 TEST MODE APPLICABILITY AND TESTED CHANNEL DETAIL.....	11
3.3 GENERAL DESCRIPTION OF APPLIED STANDARDS	14
3.4 DESCRIPTION OF SUPPORT UNITS	15
3.4.1 CONFIGURATION OF SYSTEM UNDER TEST	15
4. TEST TYPES AND RESULTS (FOR BLUETOOTH EDR)	16
4.1 RADIATED EMISSION AND BANDEDGE MEASUREMENT	16
4.1.1 LIMITS OF RADIATED EMISSION AND BANDEDGE MEASUREMENT	16
4.1.2 TEST INSTRUMENTS	17
4.1.3 TEST PROCEDURES	18
4.1.4 DEVIATION FROM TEST STANDARD	18
4.1.5 TEST SETUP.....	19
4.1.6 EUT OPERATING CONDITIONS.....	19
4.1.7 TEST RESULTS	20
4.2 CONDUCTED EMISSION MEASUREMENT	28
4.2.1 LIMITS OF CONDUCTED EMISSION MEASUREMENT	28
4.2.2 TEST INSTRUMENTS.....	28
4.2.3 TEST PROCEDURES	29
4.2.4 DEVIATION FROM TEST STANDARD	29
4.2.5 TEST SETUP.....	30
4.2.6 EUT OPERATING CONDITIONS.....	30
4.2.7 TEST RESULTS	31
4.3 NUMBER OF HOPPING FREQUENCY USED	33
4.3.1 LIMIT OF HOPPING FREQUENCY USED	33
4.3.2 TEST SETUP.....	33
4.3.3 TEST INSTRUMENTS.....	33
4.3.4 TEST PROCEDURES	33
4.3.5 DEVIATION FROM TEST STANDARD	33
4.3.6 TEST RESULTS	33
4.4 DWELL TIME ON EACH CHANNEL	35
4.4.1 LIMIT OF DWELL TIME USED	35
4.4.2 TEST SETUP.....	35
4.4.3 TEST INSTRUMENTS	35
4.4.4 TEST PROCEDURES	35
4.4.5 DEVIATION FROM TEST STANDARD	35
4.4.6 TEST RESULTS	36
4.5 CHANNEL BANDWIDTH	42
4.5.1 LIMITS OF CHANNEL BANDWIDTH	42
4.5.2 TEST SETUP.....	42
4.5.3 TEST INSTRUMENTS.....	42
4.5.4 TEST PROCEDURE.....	42
4.5.5 DEVIATION FROM TEST STANDARD	42



4.5.6	EUT OPERATING CONDITION	42
4.5.7	TEST RESULTS	43
4.6	HOPPING CHANNEL SEPARATION	46
4.6.1	LIMIT OF HOPPING CHANNEL SEPARATION	46
4.6.2	TEST SETUP	46
4.6.3	TEST INSTRUMENTS	46
4.6.4	TEST PROCEDURES	46
4.6.5	DEVIATION FROM TEST STANDARD	46
4.6.6	TEST RESULTS	47
4.7	MAXIMUM OUTPUT POWER	49
4.7.1	LIMITS OF MAXIMUM OUTPUT POWER MEASUREMENT	49
4.7.2	TEST SETUP	49
4.7.3	TEST INSTRUMENTS	49
4.7.4	TEST PROCEDURES	49
4.7.5	DEVIATION FROM TEST STANDARD	49
4.7.6	EUT OPERATING CONDITION	49
4.7.7	TEST RESULTS	50
4.8	CONDUCTED OUT OF BAND EMISSION MEASUREMENT	52
4.8.1	LIMITS OF CONDUCTED OUT OF BAND EMISSION MEASUREMENT	52
4.8.2	TEST INSTRUMENTS	52
4.8.3	TEST PROCEDURE	52
4.8.4	DEVIATION FROM TEST STANDARD	52
4.8.5	EUT OPERATING CONDITION	52
4.8.6	TEST RESULTS	52
5.	TEST TYPES AND RESULTS (FOR BLUETOOTH LE 4.0)	56
5.1	RADIATED EMISSION AND BANDEDGE MEASUREMENT	56
5.1.1	LIMITS OF RADIATED EMISSION AND BANDEDGE MEASUREMENT	56
5.1.2	TEST INSTRUMENTS	56
5.1.3	TEST PROCEDURES	56
5.1.4	DEVIATION FROM TEST STANDARD	56
5.1.5	TEST SETUP	56
5.1.6	EUT OPERATING CONDITIONS	56
5.1.7	TEST RESULTS	57
5.2	CONDUCTED EMISSION MEASUREMENT	65
5.2.1	LIMITS OF CONDUCTED EMISSION MEASUREMENT	65
5.2.2	TEST INSTRUMENTS	65
5.2.3	TEST PROCEDURES	65
5.2.4	DEVIATION FROM TEST STANDARD	65
5.2.5	TEST SETUP	65
5.2.6	EUT OPERATING CONDITIONS	65
5.2.7	TEST RESULTS	66
5.3	6dB BANDWIDTH MEASUREMENT	68
5.3.1	LIMITS OF 6dB BANDWIDTH MEASUREMENT	68
5.3.2	TEST SETUP	68
5.3.3	TEST INSTRUMENTS	68
5.3.4	TEST PROCEDURE	68
5.3.5	DEVIATION FROM TEST STANDARD	68
5.3.6	EUT OPERATING CONDITIONS	68
5.3.7	TEST RESULTS	69
5.4	CONDUCTED OUTPUT POWER	70
5.4.1	LIMITS OF CONDUCTED OUTPUT POWER MEASUREMENT	70
5.4.2	TEST SETUP	70
5.4.3	TEST INSTRUMENTS	70



5.4.4	TEST PROCEDURES	70
5.4.5	DEVIATION FROM TEST STANDARD	70
5.4.6	EUT OPERATING CONDITIONS.....	70
5.4.7	TEST RESULTS	70
5.5	POWER SPECTRAL DENSITY MEASUREMENT	71
5.5.1	LIMITS OF POWER SPECTRAL DENSITY MEASUREMENT.....	71
5.5.2	TEST SETUP.....	71
5.5.3	TEST INSTRUMENTS.....	71
5.5.4	TEST PROCEDURE.....	71
5.5.5	DEVIATION FROM TEST STANDARD	71
5.5.6	EUT OPERATING CONDITION	71
5.5.7	TEST RESULTS	71
5.6	CONDUCTED OUT OF BAND EMISSION MEASUREMENT	72
5.6.1	LIMITS OF OUT OF BAND EMISSION MEASUREMENT	72
5.6.2	TEST SETUP.....	72
5.6.3	TEST INSTRUMENTS.....	72
5.6.4	TEST PROCEDURE.....	72
5.6.5	DEVIATION FROM TEST STANDARD	73
5.6.6	EUT OPERATING CONDITION	73
5.6.7	TEST RESULTS	73
5.6.8	TEST RESULTS	74
6.	PHOTOGRAPHS OF THE TEST CONFIGURATION	75
7.	INFORMATION ON THE TESTING LABORATORIES	76
8.	APPENDIX A - MODIFICATIONS RECORDERS FOR ENGINEERING CHANGES TO THE EUT BY THE LAB	77



A D T

RELEASE CONTROL RECORD

ISSUE NO.	REASON FOR CHANGE	DATE ISSUED
RF120522C28-3	Original release	Jul. 10, 2012



1. CERTIFICATION

PRODUCT: Smartphone
MODEL: PL01210
BRAND: HTC
APPLICANT: HTC Corporation
TESTED: Jun. 07 ~ Jul. 04, 2012
TEST SAMPLE: Production Unit
STANDARDS: **FCC Part 15, Subpart C (Section 15.247)**
ANSI C63.10-2009

The above equipment (Model: PL01210) has been tested by **Bureau Veritas Consumer Products Services (H.K.) Ltd., Taoyuan Branch**, and found compliance with the requirement of the above standards. The test record, data evaluation & Equipment Under Test (EUT) configurations represented herein are true and accurate accounts of the measurements of the sample's EMC characteristics under the conditions specified in this report.

PREPARED BY : Ivonne Wu , **DATE** : Jul. 10, 2012
Ivonne Wu / Senior Specialist

APPROVED BY : Gary Chang , **DATE** : Jul. 10, 2012
Gary Chang / Technical Manager

2. SUMMARY OF TEST RESULTS

The EUT has been tested according to the following specifications:

APPLIED STANDARD: FCC Part 15, Subpart C (Bluetooth EDR)			
STANDARD SECTION	TEST TYPE AND LIMIT	RESULT	REMARK
15.207	AC Power Conducted Emission	PASS	Meet the requirement of limit. Minimum passing margin is -9.08dB at 1.56641MHz.
15.247(a)(1) (iii)	Number of Hopping Frequency Used	PASS	Meet the requirement of limit.
15.247(a)(1) (iii)	Dwell Time on Each Channel	PASS	Meet the requirement of limit.
15.247(a)(1)	1. Hopping Channel Separation 2. Spectrum Bandwidth of a Frequency Hopping Sequence Spread Spectrum System	PASS	Meet the requirement of limit.
15.247(b)	Maximum Peak Output Power	PASS	Meet the requirement of limit.
15.247(d)	Transmitter Radiated Emissions	PASS	Meet the requirement of limit. Minimum passing margin is -5.94dB at 35.40MHz.
15.247(d)	Band Edge Measurement	PASS	Meet the requirement of limit.
15.203	Antenna Requirement	PASS	No antenna connector is used.

NOTE: If The Frequency Hopping System operating in 2400-2483.5MHz band and the output power less than 125mW. The hopping channel carrier frequencies separated by a minimum of 25kHz or two-thirds of the 20dB bandwidth of hopping channel whichever is greater.

APPLIED STANDARD: FCC PART 15, SUBPART C (SECTION 15.247) (Bluetooth LE 4.0)			
STANDARD SECTION	TEST TYPE AND LIMIT	RESULT	REMARK
15.207	AC Power Conducted Emission	PASS	Meet the requirement of limit. Minimum passing margin is -7.00dB at 2.62891MHz.
15.247(d) 15.209	Radiated Emissions	PASS	Meet the requirement of limit. Minimum passing margin is -5.60dB at 36.21MHz.
15.247(d)	Band Edge Measurement	PASS	Meet the requirement of limit.
15.247(a)(2)	6dB bandwidth	PASS	Meet the requirement of limit.
15.247(b)	Conducted power	PASS	Meet the requirement of limit.
15.247(e)	Power Spectral Density	PASS	Meet the requirement of limit.
15.203	Antenna Requirement	PASS	No antenna connector is used.

2.1 MEASUREMENT UNCERTAINTY

Where relevant, the following measurement uncertainty levels have been estimated for tests performed on the EUT as specified in CISPR 16-4-2:

MEASUREMENT	FREQUENCY	UNCERTAINTY
Conducted emissions	9kHz~30MHz	2.44 dB
Radiated emissions	30MHz ~ 200MHz	2.93 dB
	200MHz ~1000MHz	2.95 dB
	1GHz ~ 18GHz	2.26 dB
	18GHz ~ 40GHz	1.94 dB

This uncertainty represents an expanded uncertainty expressed at approximately the 95% confidence level using a coverage factor of $k=2$.

3. GENERAL INFORMATION

3.1 GENERAL DESCRIPTION OF EUT

EUT	Smartphone	
MODEL NO.	PL01200	
POWER SUPPLY	5.0Vdc (adapter) 3.7Vdc (Li-ion battery)	
MODULATION TYPE	Bluetooth EDR	GFSK, $\pi/4$ -DQPSK, 8DPSK
	Bluetooth LE 4.0	GFSK
TRANSFER RATE	Bluetooth EDR	1/2/3Mbps
	Bluetooth LE 4.0	1Mbps
OPERATING FREQUENCY	2402 ~ 2480MHz	
NUMBER OF CHANNEL	Bluetooth EDR	79
	Bluetooth LE 4.0	40
CHANNEL SPACING	Bluetooth EDR	1MHz
	Bluetooth LE 4.0	2MHz
OUTPUT POWER	Bluetooth EDR	0.0017W
	Bluetooth LE 4.0	0.002W
ANTENNA TYPE	PIFA antenna with -0.5dBi gain	
ANTENNA CONNECTOR	NA	
DATA CABLE	NA	
I/O PORTS	Refer to user's manual	
ACCESSORY DEVICES	Refer to Note as below	

NOTE:

1. The EUT's accessories list refers to EUT photo.
2. The above EUT information is declared by the manufacturer and for more detailed features description, please refer to the manufacturer's specifications or User's Manual.

3.2 DESCRIPTION OF TEST MODES

For Bluetooth EDR:

79 channels are provided to this EUT:

CHANNEL	FREQ. (MHz)	CHANNEL	FREQ. (MHz)	CHANNEL	FREQ. (MHz)	CHANNEL	FREQ. (MHz)
0	2402	20	2422	40	2442	60	2462
1	2403	21	2423	41	2443	61	2463
2	2404	22	2424	42	2444	62	2464
3	2405	23	2425	43	2445	63	2465
4	2406	24	2426	44	2446	64	2466
5	2407	25	2427	45	2447	65	2467
6	2408	26	2428	46	2448	66	2468
7	2409	27	2429	47	2449	67	2469
8	2410	28	2430	48	2450	68	2470
9	2411	29	2431	49	2451	69	2471
10	2412	30	2432	50	2452	70	2472
11	2413	31	2433	51	2453	71	2473
12	2414	32	2434	52	2454	72	2474
13	2415	33	2435	53	2455	73	2475
14	2416	34	2436	54	2456	74	2476
15	2417	35	2437	55	2457	75	2477
16	2418	36	2438	56	2458	76	2478
17	2419	37	2439	57	2459	77	2479
18	2420	38	2440	58	2460	78	2480
19	2421	39	2441	59	2461		

For Bluetooth LE 4.0:

40 channels are provided to this EUT:

CHANNEL	FREQ. (MHz)	CHANNEL	FREQ. (MHz)	CHANNEL	FREQ. (MHz)	CHANNEL	FREQ. (MHz)
0	2402	10	2422	20	2442	30	2462
1	2404	11	2424	21	2444	31	2464
2	2406	12	2426	22	2446	32	2466
3	2408	13	2428	23	2448	33	2468
4	2410	14	2430	24	2450	34	2470
5	2412	15	2432	25	2452	35	2472
6	2414	16	2434	26	2454	36	2474
7	2416	17	2436	27	2456	37	2476
8	2418	18	2438	28	2458	38	2478
9	2420	19	2440	29	2460	39	2480

3.2.1 TEST MODE APPLICABILITY AND TESTED CHANNEL DETAIL

For Bluetooth EDR:

EUT CONFIGURE MODE	APPLICABLE TO				DESCRIPTION
	RE \geq 1G	RE $<$ 1G	PLC	APCM	
-	√	√	√	√	-

Where **RE \geq 1G**: Radiated Emission above 1GHz **RE $<$ 1G**: Radiated Emission below 1GHz
PLC: Power Line Conducted Emission **APCM**: Antenna Port Conducted Measurement

NOTE: 1. For Radiated emission test, pre-tested GFSK, $\pi/4$ -DQPSK, 8DPSK modulation type and found GFSK was the worse, therefore chosen for the final test and presented in the test report.
2. The EUT had been pre-tested on the positioned of each 3 axis. The worst case was found when positioned on **X-plane**.

RADIATED EMISSION TEST (ABOVE 1 GHz):

- Pre-Scan has been conducted to determine the worst-case mode from all possible combinations between available modulations, antenna ports (if EUT with antenna diversity architecture) and packet type.
- Following channel(s) was (were) selected for the final test as listed below.

EUT CONFIGURE MODE	AVAILABLE CHANNEL	TESTED CHANNEL	MODULATION TYPE	PACKET TYPE
-	0 to 78	0, 39, 78	GFSK	DH5

RADIATED EMISSION TEST (BELOW 1 GHz):

- Pre-Scan has been conducted to determine the worst-case mode from all possible combinations between available modulations, antenna ports (if EUT with antenna diversity architecture) and packet type.
- Following channel(s) was (were) selected for the final test as listed below.

EUT CONFIGURE MODE	AVAILABLE CHANNEL	TESTED CHANNEL	MODULATION TYPE	PACKET TYPE
-	0 to 78	78	GFSK	DH5

POWER LINE CONDUCTED EMISSION TEST:

- Pre-Scan has been conducted to determine the worst-case mode from all possible combinations between available modulations, antenna ports (if EUT with antenna diversity architecture), and packet types.
- Following channel(s) was (were) selected for the final test as listed below.

EUT CONFIGURE MODE	AVAILABLE CHANNEL	TESTED CHANNEL	MODULATION TYPE	PACKET TYPE
-	0 to 78	78	GFSK	DH5

ANTENNA PORT CONDUCTED MEASUREMENT:

- This item includes all test value of each mode, but only includes spectrum plot of worst value of each mode.
- Pre-Scan has been conducted to determine the worst-case mode from all possible combinations between available modulations, antenna ports (if EUT with antenna diversity architecture), and packet types.
- Following channel(s) was (were) selected for the final test as listed below.

EUT CONFIGURE MODE	AVAILABLE CHANNEL	TESTED CHANNEL	MODULATION TYPE	PACKET TYPE
-	0 to 78	0, 39, 78	GFSK	DH5
-	0 to 78	0, 39, 78	$\pi/4$ -DQPSK	DH5
-	0 to 78	0, 39, 78	8DPSK	DH5

TEST CONDITION:

APPLICABLE TO	ENVIRONMENTAL CONDITIONS	INPUT POWER	TESTED BY
RE \geq 1G	25deg. C, 65%RH	120Vac, 60Hz	Kay Wu
RE<1G	25deg. C, 65%RH	120Vac, 60Hz	Kay Wu
PLC	25deg. C, 65%RH	120Vac, 60Hz	David Huang
APCM	25deg. C, 65%RH	120Vac, 60Hz	Phoenix Chen

**FOR Bluetooth LE 4.0:**

EUT CONFIGURE MODE	APPLICABLE TO				DESCRIPTION
	RE \geq 1G	RE $<$ 1G	PLC	APCM	
-	√	√	√	√	-

Where **RE \geq 1G**: Radiated Emission above 1GHz **RE $<$ 1G**: Radiated Emission below 1GHz
PLC: Power Line Conducted Emission **APCM**: Antenna Port Conducted Measurement

NOTE: 1. The EUT had been pre-tested on the positioned of each 3 axis. The worst case was found when positioned on **Y-plane**.

RADIATED EMISSION TEST (ABOVE 1GHz):

- Pre-Scan has been conducted to determine the worst-case mode from all possible combinations between available modulations and antenna ports (if EUT with antenna diversity architecture).
- Following channel(s) was (were) selected for the final test as listed below.

EUT CONFIGURE MODE	AVAILABLE CHANNEL	TESTED CHANNEL	MODULATION TYPE	DATA RATE (Mbps)
-	0 to 39	0, 19, 39	GFSK	1.0

RADIATED EMISSION TEST (BELOW 1GHz):

- Pre-Scan has been conducted to determine the worst-case mode from all possible combinations between available modulations and antenna ports (if EUT with antenna diversity architecture).
- Following channel(s) was (were) selected for the final test as listed below.

EUT CONFIGURE MODE	AVAILABLE CHANNEL	TESTED CHANNEL	MODULATION TYPE	DATA RATE (Mbps)
-	0 to 39	39	GFSK	1.0

POWER LINE CONDUCTED EMISSION TEST:

- Pre-Scan has been conducted to determine the worst-case mode from all possible combinations between available modulations and antenna ports (if EUT with antenna diversity architecture).
- Following channel(s) was (were) selected for the final test as listed below.

EUT CONFIGURE MODE	AVAILABLE CHANNEL	TESTED CHANNEL	MODULATION TYPE	DATA RATE (Mbps)
-	0 to 39	39	GFSK	1.0

ANTENNA PORT CONDUCTED MEASUREMENT:

- Pre-Scan has been conducted to determine the worst-case mode from all possible combinations between available modulations, data rates and antenna ports (if EUT with antenna diversity architecture).
- Following channel(s) was (were) selected for the final test as listed below.

EUT CONFIGURE MODE	AVAILABLE CHANNEL	TESTED CHANNEL	MODULATION TYPE	DATA RATE (Mbps)
-	0 to 39	0, 19, 39	GFSK	1.0

TEST CONDITION:

APPLICABLE TO	ENVIRONMENTAL CONDITIONS	INPUT POWER	TESTED BY
RE \geq 1G	25deg. C, 65%RH	120Vac, 60Hz	Kay Wu
RE $<$ 1G	25deg. C, 65%RH	120Vac, 60Hz	Kay Wu
PLC	25deg. C, 65%RH	120Vac, 60Hz	David Huang
APCM	25deg. C, 65%RH	120Vac, 60Hz	Phoenix Chen

3.3 GENERAL DESCRIPTION OF APPLIED STANDARDS

The EUT is a RF Product. According to the specifications of the manufacturer, it must comply with the requirements of the following standards:

FCC Part 15, Subpart C (15.247)

ANSI C63.10-2009

558074 D01 DTS Meas Guidance v01

All test items have been performed and recorded as per the above standards.

3.4 DESCRIPTION OF SUPPORT UNITS

The EUT has been tested as an independent unit together with other necessary accessories or support units. The following support units or accessories were used to form a representative test configuration during the tests.

FOR EMISSION TEST

NO.	PRODUCT	BRAND	MODEL NO.	SERIAL NO.	FCC ID
1	EARPHONE	Cotron	HS S250	NA	NA

NO.	SIGNAL CABLE DESCRIPTION OF THE ABOVE SUPPORT UNITS
1	NA

NOTE:

1. All power cords of the above support units are non shielded (1.8m).
2. Item 1 was provided by client.

3.4.1 CONFIGURATION OF SYSTEM UNDER TEST

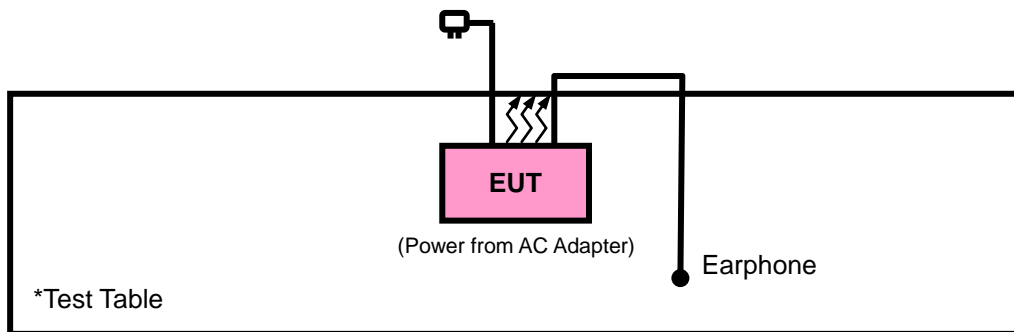

4. TEST TYPES AND RESULTS (FOR Bluetooth EDR)

4.1 RADIATED EMISSION AND BANDEGE MEASUREMENT

4.1.1 LIMITS OF RADIATED EMISSION AND BANDEGE MEASUREMENT

Radiated emissions which fall in the restricted bands must comply with the radiated emission limits specified as below table. Other emissions shall be at least 20dB below the highest level of the desired power:

FREQUENCIES (MHz)	FIELD STRENGTH (microvolts/meter)	MEASUREMENT DISTANCE (meters)
0.009 ~ 0.490	2400/F(kHz)	300
0.490 ~ 1.705	24000/F(kHz)	30
1.705 ~ 30.0	30	30
30 ~ 88	100	3
88 ~ 216	150	3
216 ~ 960	200	3
Above 960	500	3

NOTE:

1. The lower limit shall apply at the transition frequencies.
2. Emission level (dBuV/m) = 20 log Emission level (uV/m).
3. For frequencies above 1000MHz, the field strength limits are based on average detector, however, the peak field strength of any emission shall not exceed the maximum permitted average limits, specified above by more than 20dB under any condition of modulation.



4.1.2 TEST INSTRUMENTS

DESCRIPTION & MANUFACTURER	MODEL NO.	SERIAL NO.	DATE OF CALIBRATION	DUE DATE OF CALIBRATION
Test Receiver Agilent	N9038A	MY51210203	Dec. 22, 2011	Dec. 21, 2012
Spectrum Analyzer ROHDE & SCHWARZ	FSU43	101261	Dec. 21, 2011	Dec. 20, 2012
BILOG Antenna SCHWARZBECK	VULB9168	9168-472	Dec. 20, 2011	Dec. 19, 2012
HORN Antenna SCHWARZBECK	BBHA 9120 D	9120D-969	Dec. 20, 2011	Dec. 19, 2012
HORN Antenna SCHWARZBECK	BBHA 9170	9170-480	Dec. 20, 2011	Dec. 19, 2012
Loop Antenna	HFH2-Z2	100070	Jan. 31, 2012	Jan. 30, 2014
Preamplifier EMCI	EMC 012645	980115	Dec. 30, 2011	Dec. 29, 2012
RF signal cable HUBER+SUHNNER	SUCOFLEX 104	309219/4	Oct. 21, 2011	Oct. 20, 2012
RF signal cable HUBER+SUHNNER	SUCOFLEX 104	250130/4	Jan. 02, 2012	Jan. 01, 2013
RF signal cable Worken	RG-213	NA	Jan. 02, 2012	Jan. 01, 2013
Software	E3 6.120103	NA	NA	NA
Antenna Tower MF	MFA-440H	NA	NA	NA
Turn Table MF	MFT-201SS	NA	NA	NA
Antenna Tower & Turn Table Controller MF	MF-7802	NA	NA	NA
JFW 20dB attenuation	50HF-020-SMA	NA	NA	NA

- NOTE:** 1. The calibration interval of the above test instruments except loop antenna is 12 months and the calibrations are traceable to NML/ROC and NIST/USA.
2. The calibration interval of loop antenna is 24 months and the calibrations are traceable to NML/ROC and NIST/USA.
3. The test was performed in HwaYa Chamber 9.
4. The horn antenna and HP preamplifier (model: 8449B) are used only for the measurement of emission frequency above 1GHz if tested.
5. The FCC Site Registration No. is 460141.
6. The IC Site Registration No. is IC 7450F-4.

4.1.3 TEST PROCEDURES

- a. The EUT was placed on the top of a rotating table 0.8 meters above the ground at a 3 meter semi-anechoic chamber. The table was rotated 360 degrees to determine the position of the highest radiation.
- b. The EUT was set 3 meters away from the interference-receiving antenna, which was mounted on the top of a variable-height antenna tower.
- c. The antenna is a broadband antenna, and its height is varied from one meter to four meters above the ground to determine the maximum value of the field strength. Both horizontal and vertical polarizations of the antenna are set to make the measurement.
- d. For each suspected emission, the EUT was arranged to its worst case and then the antenna was tuned to heights from 1 meter to 4 meters and the rotatable table was turned from 0 degrees to 360 degrees to find the maximum reading.
- e. The test-receiver system was set to Peak Detect Function and Specified Bandwidth with Maximum Hold Mode.
- f. If the emission level of the EUT in peak mode was lower than the limit specified, then testing could be stopped and the peak values of the EUT would be reported. Otherwise the emissions would be re-tested one by one using peak, quasi-peak or average method as specified and then reported in a data sheet.

NOTE:

1. The resolution bandwidth and video bandwidth of test receiver/spectrum analyzer is 120kHz for Quasi-peak detection at frequency below 1GHz.
2. The resolution bandwidth of test receiver/spectrum analyzer is 1 MHz and video bandwidth is 3MHz for Peak detection at frequency above 1GHz.
3. All modes of operation were investigated and the worst-case emissions are reported.

4.1.4 DEVIATION FROM TEST STANDARD

No deviation.

4.1.5 TEST SETUP

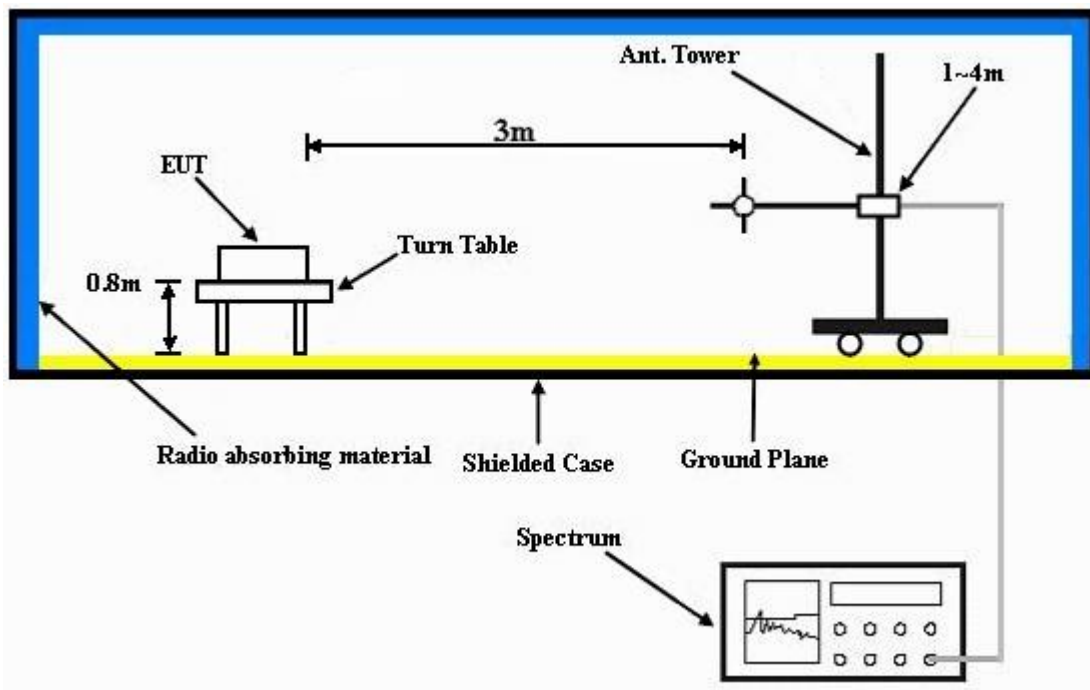

For the actual test configuration, please refer to the attached file (Test Setup Photo).

4.1.6 EUT OPERATING CONDITIONS

- a. Placed the EUT on a testing table.
- b. Use the software to control the EUT under transmission condition continuously at specific channel frequency.



A D T

4.1.7 TEST RESULTS

ABOVE 1GHz WORST-CASE DATA : GFSK



Bureau Veritas Consumer Products Services Ltd., Taoyuan Branch

A D T

Data: 19

Date: 2012-06-12

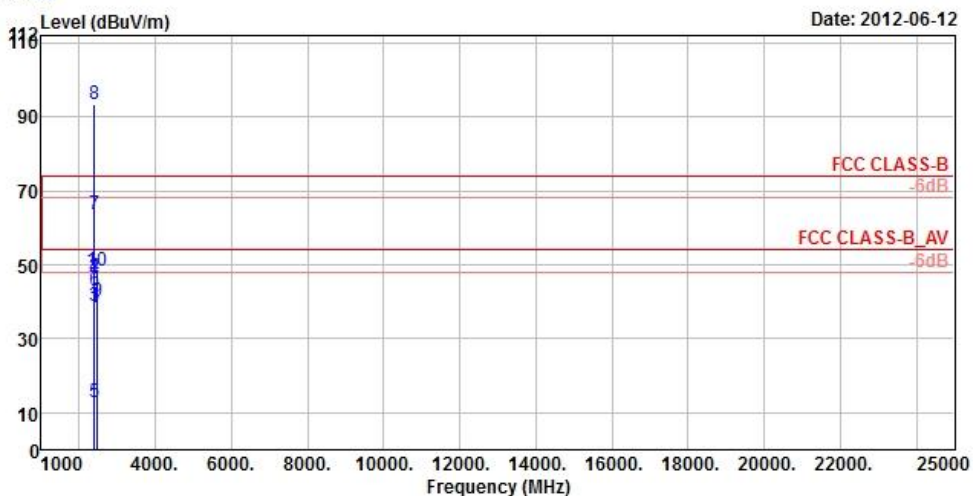

Site : 966 Chamber 5
 Condition : FCC CLASS-B 3m ANT_18G~40G_HF HORIZONTAL
 Brand/Model: PL01210
 Remark : BT TX GFSK CH00
 Tested by : Kay Wu
 Temperature : 25°C
 Humidity : 65%
 Plane : X
 Rate : DHS

	Freq	Level	Read Level	Limit Line	OverAntenna Limit	Antenna Factor	Cable Loss	Preamp Factor	A/Pos	T/Pos	Remark
	MHz	dBuV/m	dBuV	dBuV/m	dB	dB/m	dB	dB	cm	deg	
1	2390.00	38.60	43.99	54.00	-15.40	27.26	4.87	37.52	106	147	Average
2	2390.00	46.85	52.24	74.00	-27.15	27.26	4.87	37.52	106	147	Peak
3	2398.00	38.91	44.30	54.00	-15.09	27.26	4.87	37.52	106	147	Average
4	2398.00	46.76	52.15	74.00	-27.24	27.26	4.87	37.52	106	147	Peak
5	2400.00	12.79	18.18	54.00	-41.21	27.26	4.87	37.52	106	147	Average
6	2400.00	42.89	48.28	74.00	-31.11	27.26	4.87	37.52	106	147	Peak
7 av	2402.00	63.48	68.87			27.26	4.87	37.52	106	147	Average
8 pp	2402.00	93.58	98.97			27.26	4.87	37.52	106	147	Peak
9	2484.00	40.08	44.98	54.00	-13.92	27.50	4.92	37.32	106	147	Average
10	2484.00	48.56	53.46	74.00	-25.44	27.50	4.92	37.32	106	147	Peak



A D T



Bureau Veritas Consumer Products Services Ltd., Taoyuan Branch

A D T

Data: 20

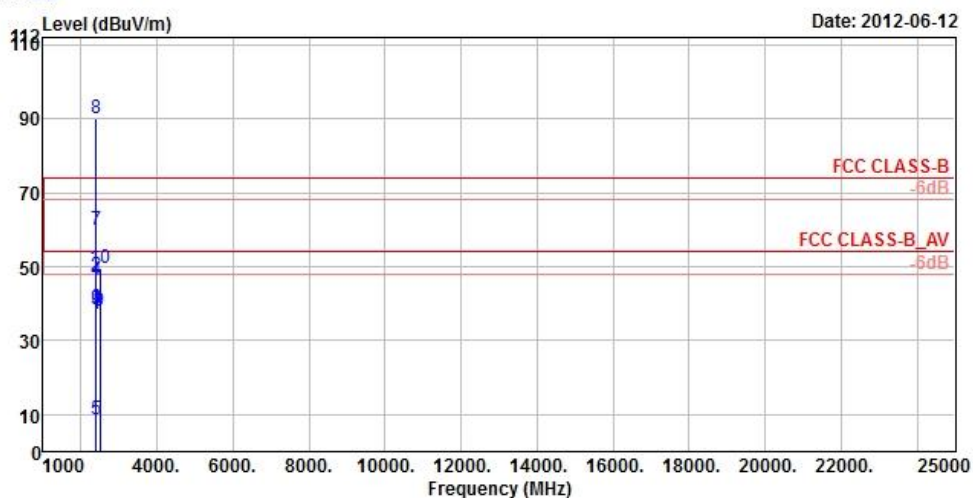

Site : 966 Chamber 5
 Condition : FCC CLASS-B 3m ANT_18G~40G_HF VERTICAL
 Brand/Model: PL01210
 Remark : BT TX GFSK CH00
 Tested by : Kay Wu
 Temperature : 25°C
 Humidity : 65%
 Plane : X
 Rate : DHS

	Freq	Level	Read Level	Limit Line	OverAntenna Limit	Antenna Factor	Cable Loss	Preamp Factor	A/Pos	T/Pos	Remark
	MHz	dBuV/m	dBuV	dBuV/m	dB	dB/m	dB	dB	cm	deg	
1	2390.00	37.37	42.76	54.00	-16.63	27.26	4.87	37.52	100	39	Average
2	2390.00	47.66	53.05	74.00	-26.34	27.26	4.87	37.52	100	39	Peak
3	2398.00	38.60	43.99	54.00	-15.40	27.26	4.87	37.52	100	39	Average
4	2398.00	46.09	51.48	74.00	-27.91	27.26	4.87	37.52	100	39	Peak
5	2400.00	8.70	14.09	54.00	-45.30	27.26	4.87	37.52	100	39	Average
6	2400.00	38.80	44.19	74.00	-35.20	27.26	4.87	37.52	100	39	Peak
7 av	2402.00	60.12	65.51			27.26	4.87	37.52	100	39	Average
8 pp	2402.00	90.22	95.61			27.26	4.87	37.52	100	39	Peak
9	2498.00	37.82	42.58	54.00	-16.18	27.55	4.94	37.25	100	39	Average
10	2498.00	49.50	54.26	74.00	-24.50	27.55	4.94	37.25	100	39	Peak



A D T



Bureau Veritas Consumer Products Services Ltd., Taoyuan Branch

A D T

Data: 19

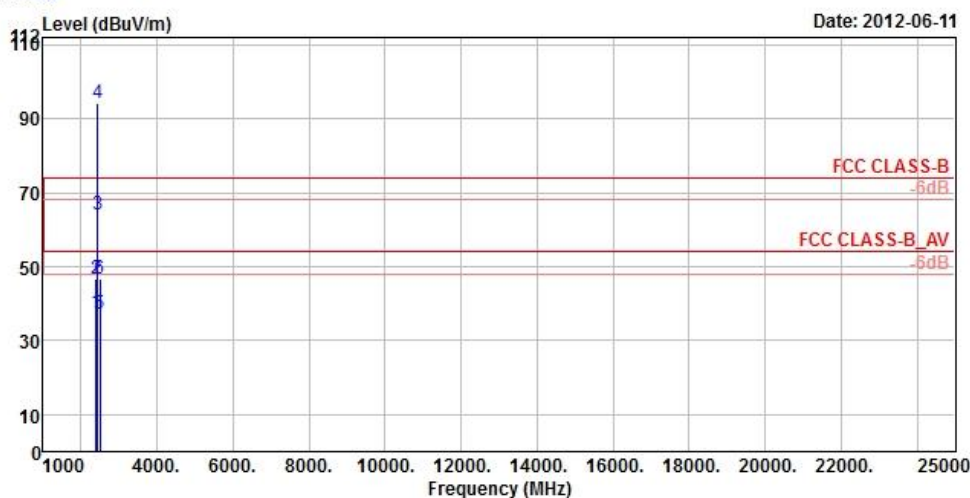

Site : 966 Chamber 5
 Condition : FCC CLASS-B 3m ANT_18G~40G_HF HORIZONTAL
 Brand/Model: PL01210
 Remark : BT TX GFSK CH39
 Tested by : Kay Wu
 Temperature : 25°C
 Humidity : 65%
 Plane : X
 Rate : DHS

	Freq	Level	Read Level	Limit Line	OverAntenna Limit	Antenna Factor	Cable Loss	Preamp Factor	A/Pos	T/Pos	Remark
	MHz	dBuV/m	dBuV	dBuV/m	dB	dB/m	dB	dB	cm	deg	
1	2390.00	37.45	42.84	54.00	-16.55	27.26	4.87	37.52	131	53	Average
2	2390.00	46.64	52.03	74.00	-27.36	27.26	4.87	37.52	131	53	Peak
3 av	2441.00	63.96	69.04			27.40	4.91	37.39	131	53	Average
4 pp	2441.00	94.06	99.14			27.40	4.91	37.39	131	53	Peak
5	2485.50	37.11	42.01	54.00	-16.89	27.50	4.92	37.32	131	53	Average
6	2485.50	46.53	51.43	74.00	-27.47	27.50	4.92	37.32	131	53	Peak



A D T



Bureau Veritas Consumer Products Services Ltd., Taoyuan Branch

A D T

Data: 20

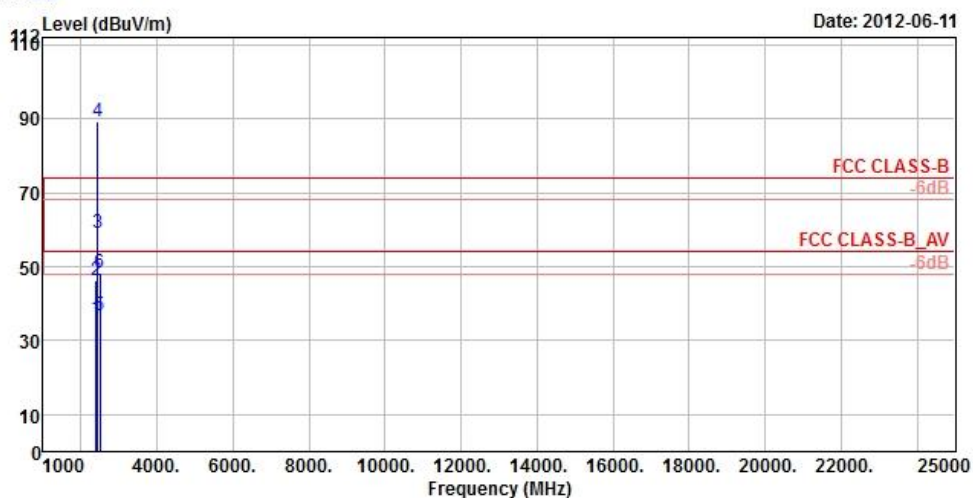

Site : 966 Chamber 5
 Condition : FCC CLASS-B 3m ANT_18G~40G_HF VERTICAL
 Brand/Model: PL01210
 Remark : BT TX GFSK CH39
 Tested by : Kay Wu
 Temperature : 25°C
 Humidity : 65%
 Plane : X
 Rate : DHS

	Freq	Level	Read Level	Limit Line	OverLimit	Antenna Factor	Cable Loss	Preamp Factor	A/Pos	T/Pos	Remark
	MHz	dBuV/m	dBuV	dBuV/m	dB	dB/m	dB	dB	cm	deg	
1	2390.00	36.16	41.55	54.00	-17.84	27.26	4.87	37.52	119	229	Average
2	2390.00	46.42	51.81	74.00	-27.58	27.26	4.87	37.52	119	229	Peak
3 av	2441.00	59.14	64.22			27.40	4.91	37.39	119	229	Average
4 pp	2441.00	89.24	94.32			27.40	4.91	37.39	119	229	Peak
5	2485.50	36.84	41.74	54.00	-17.16	27.50	4.92	37.32	119	229	Average
6	2485.50	48.50	53.40	74.00	-25.50	27.50	4.92	37.32	119	229	Peak



A D T



Bureau Veritas Consumer Products Services Ltd., Taoyuan Branch

A D T

Data: 19

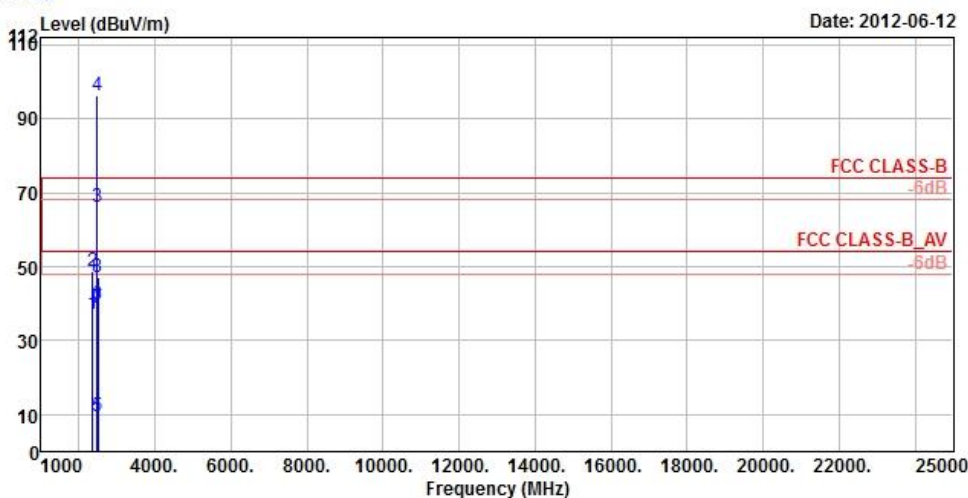

Site : 966 Chamber 5
 Condition : FCC CLASS-B 3m ANT_18G~40G_HF HORIZONTAL
 Brand/Model: PL01210
 Remark : BT TX GFSK CH78
 Tested by : Kay Wu
 Temperature : 25°C
 Humidity : 65%
 Plane : X
 Rate : DHS

	Freq	Level	Read Level	Limit Line	OverLimit	Antenna Factor	Cable Loss	Preamp Factor	A/Pos	T/Pos	Remark
	MHz	dBuV/m	dBuV	dBuV/m	dB	dB/m	dB	dB	cm	deg	
1	2344.00	37.29	42.85	54.00	-16.71	27.11	4.82	37.49	128	50	Average
2	2344.00	48.82	54.38	74.00	-25.18	27.11	4.82	37.49	128	50	Peak
3 av	2480.00	66.17	71.07			27.50	4.92	37.32	128	50	Average
4 pp	2480.00	96.27	101.17			27.50	4.92	37.32	128	50	Peak
5	2483.50	9.38	14.28	54.00	-44.62	27.50	4.92	37.32	128	50	Average
6	2483.50	39.48	44.38	74.00	-34.52	27.50	4.92	37.32	128	50	Peak
7	2485.50	38.99	43.89	54.00	-15.01	27.50	4.92	37.32	128	50	Average
8	2485.50	47.20	52.10	74.00	-26.80	27.50	4.92	37.32	128	50	Peak



A D T



Bureau Veritas Consumer Products Services Ltd., Taoyuan Branch

A D T

Data: 20

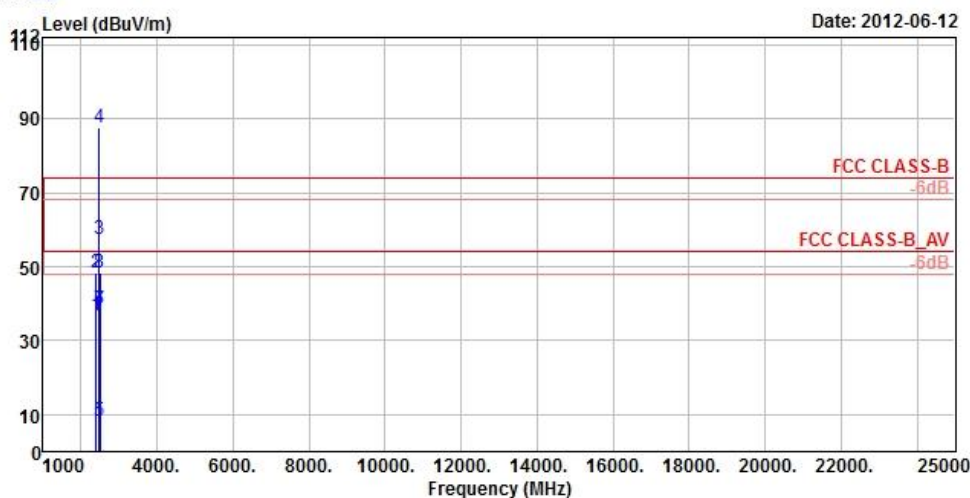

Site : 966 Chamber 5
 Condition : FCC CLASS-B 3m ANT_18G~40G_HF VERTICAL
 Brand/Model: PL01210
 Remark : BT TX GFSK CH78
 Tested by : Kay Wu
 Temperature : 25°C
 Humidity : 65%
 Plane : X
 Rate : DHS

	Freq	Level	Read Level	Limit Line	OverLimit	Antenna Factor	Cable Loss	Preamp Factor	A/Pos	T/Pos	Remark
	MHz	dBuV/m	dBuV	dBuV/m	dB	dB/m	dB	dB	cm	deg	
1	2386.00	36.76	42.15	54.00	-17.24	27.26	4.85	37.50	145	179	Average
2	2386.00	48.51	53.90	74.00	-25.49	27.26	4.85	37.50	145	179	Peak
3 av	2480.00	57.49	62.39			27.50	4.92	37.32	145	179	Average
4 pp	2480.00	87.59	92.49			27.50	4.92	37.32	145	179	Peak
5	2483.50	8.39	13.29	54.00	-45.61	27.50	4.92	37.32	145	179	Average
6	2483.50	38.49	43.39	74.00	-35.51	27.50	4.92	37.32	145	179	Peak
7	2485.50	38.29	43.19	54.00	-15.71	27.50	4.92	37.32	145	179	Average
8	2485.50	48.53	53.43	74.00	-25.47	27.50	4.92	37.32	145	179	Peak



A D T

BELOW 1GHz WORST-CASE DATA :



Bureau Veritas Consumer Products Services Ltd., Taoyuan Branch

A D T

Data: 5

Date: 2012-06-15

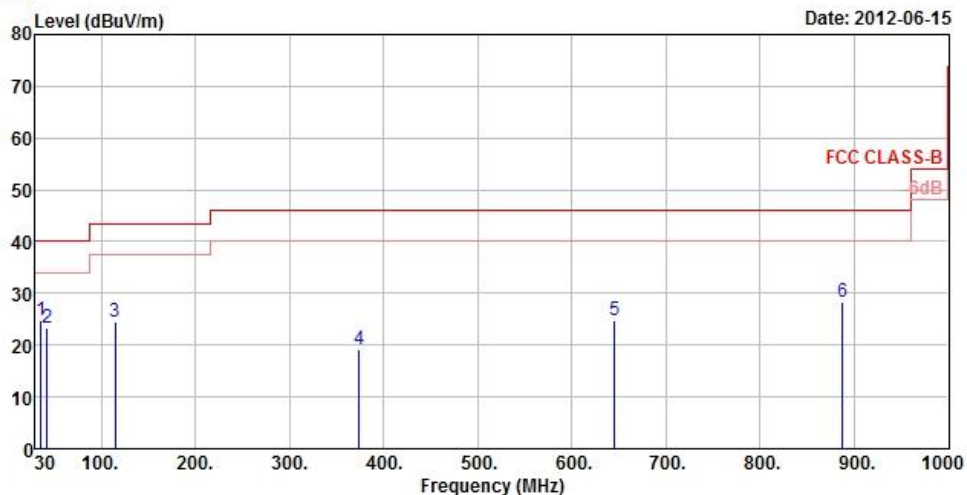

Site : 966 Chamber 5
 Condition : FCC CLASS-B 3m ANT_30M~1G_LF HORIZONTAL
 Brand/Model: PL01210
 Remark : BT TX LF
 Tested by : Kay Wu
 Temperature : 25°C
 Humidity : 65%
 Plane : X

	Freq	Level	Read Level	Limit Line	OverLimit	Antenna Factor	Cable Loss	Preamp Factor	A/Pos	T/Pos	Remark
	MHz	dBuV/m	dBuV	dBuV/m	dB	dB/m	dB	dB	cm	deg	
1 pp	36.21	24.77	42.27	40.00	-15.23	12.94	0.61	31.05	100	74	Peak
2	42.69	23.21	40.01	40.00	-16.79	13.58	0.70	31.08	133	72	Peak
3	114.78	24.62	44.88	43.50	-18.88	10.46	1.15	31.87	166	274	Peak
4	374.20	19.32	34.20	46.00	-26.68	14.73	2.32	31.93	174	221	Peak
5	645.10	24.90	33.58	46.00	-21.10	20.15	3.23	32.06	221	112	Peak
6	888.00	28.23	32.93	46.00	-17.77	23.36	3.93	31.99	100	133	Peak



A D T



Bureau Veritas Consumer Products Services Ltd., Taoyuan Branch

A D T

Data: 6

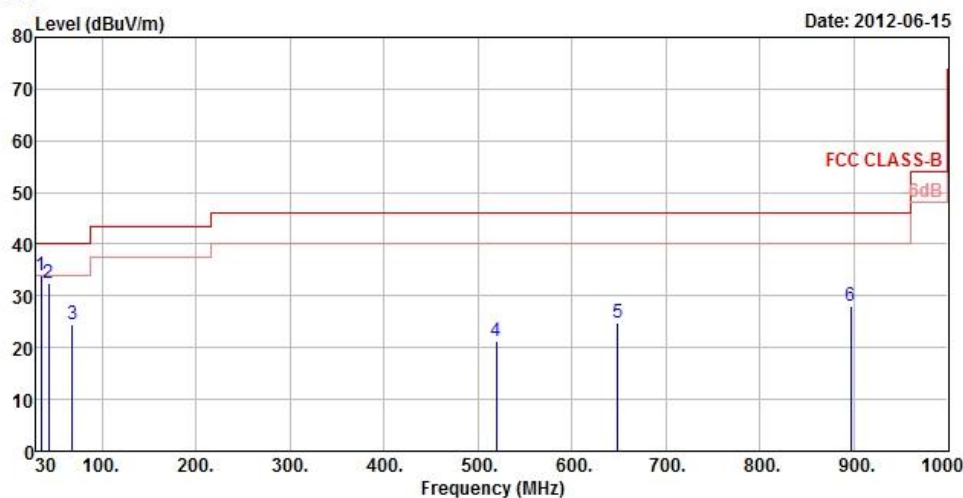

Site : 966 Chamber 5
 Condition : FCC CLASS-B 3m ANT_30M~1G_LF VERTICAL
 Brand/Model: PL01210
 Remark : BT TX LF
 Tested by : Kay Wu
 Temperature : 25°C
 Humidity : 65%
 Plane : X

	Read	Limit	OverAntenna	Cable	Preamp	A/Pos	T/Pos				
Freq	Level	Level	Limit	Loss	Loss	cm	deg	Remark			
MHz	dBuV/m	dBuV	dBuV/m	dB	dB/m	cm	deg				
1 pp	35.40	34.06	51.56	40.00	-5.94	12.94	0.61	31.05	100	360	QP
2	43.23	32.45	49.26	40.00	-7.55	13.59	0.71	31.11	100	315	QP
3 pk	68.61	24.60	44.59	40.00	-15.40	10.89	0.89	31.77	100	127	Peak
4	519.10	21.29	32.27	46.00	-24.71	17.75	2.84	31.57	196	74	Peak
5	648.60	24.81	33.40	46.00	-21.19	20.20	3.24	32.03	132	210	Peak
6	896.40	28.17	32.75	46.00	-17.83	23.46	3.96	32.00	102	227	Peak

4.2 CONDUCTED EMISSION MEASUREMENT

4.2.1 LIMITS OF CONDUCTED EMISSION MEASUREMENT

FREQUENCY OF EMISSION (MHz)	CONDUCTED LIMIT (dB μ V)	
	Quasi-peak	Average
0.15 ~ 0.5	66 to 56	56 to 46
0.5 ~ 5	56	46
5 ~ 30	60	50

- NOTE:**
1. The lower limit shall apply at the transition frequencies.
 2. The limit decreases in line with the logarithm of the frequency in the range of 0.15 to 0.50 MHz.
 3. All emanations from a class A/B digital device or system, including any network of conductors and apparatus connected thereto, shall not exceed the level of field strengths specified above.

4.2.2 TEST INSTRUMENTS

DESCRIPTION & MANUFACTURER	MODEL NO.	SERIAL NO.	DATE OF CALIBRATION	DUE DATE OF CALIBRATION
Test Receiver ROHDE & SCHWARZ	ESCS30	100289	Nov. 19, 2011	Nov. 18, 2012
RF signal cable Woken	5D-FB	Cable-HYCO2-01	Dec. 22, 2011	Dec. 21, 2012
LISN ROHDE & SCHWARZ (EUT)	ESH2-Z5	100100	Dec. 30, 2011	Dec. 29, 2012
LISN ROHDE & SCHWARZ (Peripheral)	ESH3-Z5	100312	Jul. 07, 2011	Jul. 06, 2012
Software ADT	BV ADT_Cond_ V7.3.7.3	NA	NA	NA

- NOTE:**
1. The calibration interval of the above test instruments is 12 months and the calibrations are traceable to NML/ROC and NIST/USA.
 2. The test was performed in HwaYa Shielded Room 2.
 3. The VCCI Site Registration No. is C-2047.

4.2.3 TEST PROCEDURES

- a. The EUT was placed 0.4 meters from the conducting wall of the shielded room with EUT being connected to the power mains through a line impedance stabilization network (LISN). Other support units were connected to the power mains through another LISN. The two LISNs provide 50 ohm/ 50uH of coupling impedance for the measuring instrument.
- b. Both lines of the power mains connected to the EUT were checked for maximum conducted interference.
- c. The frequency range from 150kHz to 30MHz was searched. Emission levels under (Limit - 20dB) was not recorded.

NOTE: All modes of operation were investigated and the worst-case emissions are reported.

4.2.4 DEVIATION FROM TEST STANDARD

No deviation.

4.2.5 TEST SETUP

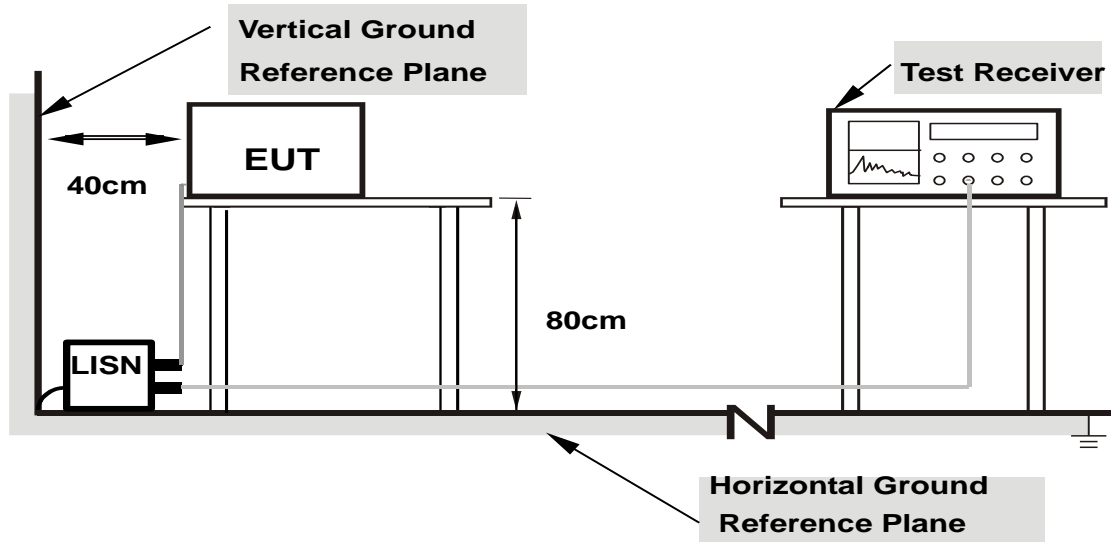

- Note:**
1. Support units were connected to second LISN.
 2. Both of LISNs (AMN) are 80 cm from EUT and at least 80 from other units and other metal planes

For the actual test configuration, please refer to the attached file (Test Setup Photo).

4.2.6 EUT OPERATING CONDITIONS

Same as 4.1.6.

4.2.7 TEST RESULTS

CONDUCTED WORST CASE DATA: 8DPSK

PHASE	Line 1	6dB BANDWIDTH	9kHz
-------	--------	---------------	------

No	Freq. [MHz]	Corr. Factor (dB)	Reading Value		Emission Level		Limit		Margin	
			[dB (uV)]		[dB (uV)]		[dB (uV)]		(dB)	
			Q.P.	AV.	Q.P.	AV.	Q.P.	AV.	Q.P.	AV.
1	0.17344	0.15	45.09	31.47	45.24	31.62	64.79	54.79	-19.55	-23.17
2	0.51328	0.17	43.12	34.52	43.29	34.69	56.00	46.00	-12.71	-11.31
3	0.96641	0.19	43.65	34.40	43.84	34.59	56.00	46.00	-12.16	-11.41
4	1.56641	0.23	45.36	36.69	45.59	36.92	56.00	46.00	-10.41	-9.08
5	2.69141	0.29	44.81	36.09	45.10	36.38	56.00	46.00	-10.90	-9.62
6	4.13281	0.34	43.92	36.04	44.26	36.38	56.00	46.00	-11.74	-9.62

REMARKS:

1. Q.P. and AV. are abbreviations of quasi-peak and average individually.
2. The emission levels of other frequencies were very low against the limit.
3. Margin value = Emission level - Limit value
4. Correction factor = Insertion loss + Cable loss
5. Emission Level = Correction Factor + Reading Value.

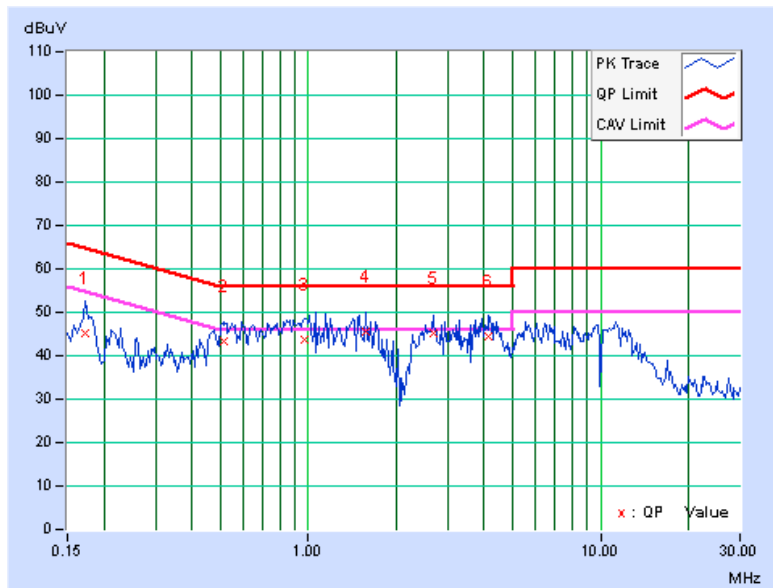

PHASE	Line 2	6dB BANDWIDTH	9kHz
-------	--------	---------------	------

No	Freq. [MHz]	Corr. Factor (dB)	Reading Value [dB (uV)]		Emission Level [dB (uV)]		Limit [dB (uV)]		Margin (dB)	
			Q.P.	AV.	Q.P.	AV.	Q.P.	AV.	Q.P.	AV.
			1	0.17734	0.14	44.20	31.15	44.34	31.29	64.61
2	0.52500	0.17	42.76	35.37	42.93	35.54	56.00	46.00	-13.07	-10.46
3	0.91172	0.19	41.96	34.16	42.15	34.35	56.00	46.00	-13.85	-11.65
4	1.48438	0.22	44.42	36.48	44.64	36.70	56.00	46.00	-11.36	-9.30
5	4.01563	0.35	43.31	35.58	43.66	35.93	56.00	46.00	-12.34	-10.07
6	11.47266	0.52	45.50	39.05	46.02	39.57	60.00	50.00	-13.98	-10.43

REMARKS:

1. Q.P. and AV. are abbreviations of quasi-peak and average individually.
2. The emission levels of other frequencies were very low against the limit.
3. Margin value = Emission level - Limit value
4. Correction factor = Insertion loss + Cable loss
5. Emission Level = Correction Factor + Reading Value.

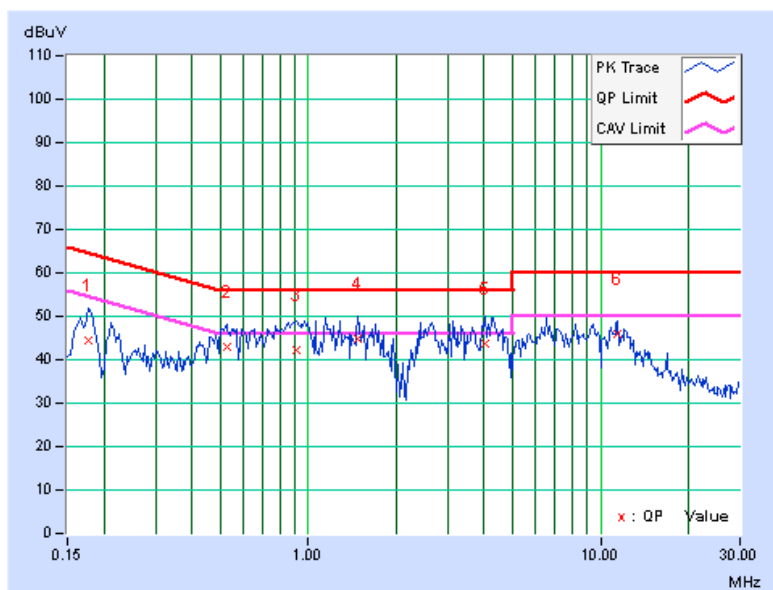

4.3 NUMBER OF HOPPING FREQUENCY USED

4.3.1 LIMIT OF HOPPING FREQUENCY USED

At least 15 channels frequencies, and should be equally spaced.

4.3.2 TEST SETUP

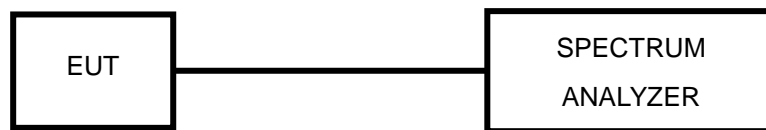

4.3.3 TEST INSTRUMENTS

Refer to section 4.1.2 to get information of above instrument.

4.3.4 TEST PROCEDURES

- a. Check the calibration of the measuring instrument (SA) using either an internal calibrator or a known signal from an external generator.
- b. Turn on the EUT and connect its antenna terminal to measurement via a low loss cable. Then set it to any one measured frequency within its operating range and make sure the instrument is operated in its linear range.
- c. Set the SA on MaxHold Mode, and then keep the EUT in hopping mode. Record all the signals from each channel until each one has been recorded.
- d. Set the SA on View mode and then plot the result on SA screen.
- e. Repeat above procedures until all frequencies measured were complete.

4.3.5 DEVIATION FROM TEST STANDARD

No deviation.

4.3.6 TEST RESULTS

There are 79 hopping frequencies in the hopping mode. Please refer to next two pages for the test result. On the plots, it shows that the hopping frequencies are equally spaced.



A D T

8DPSK

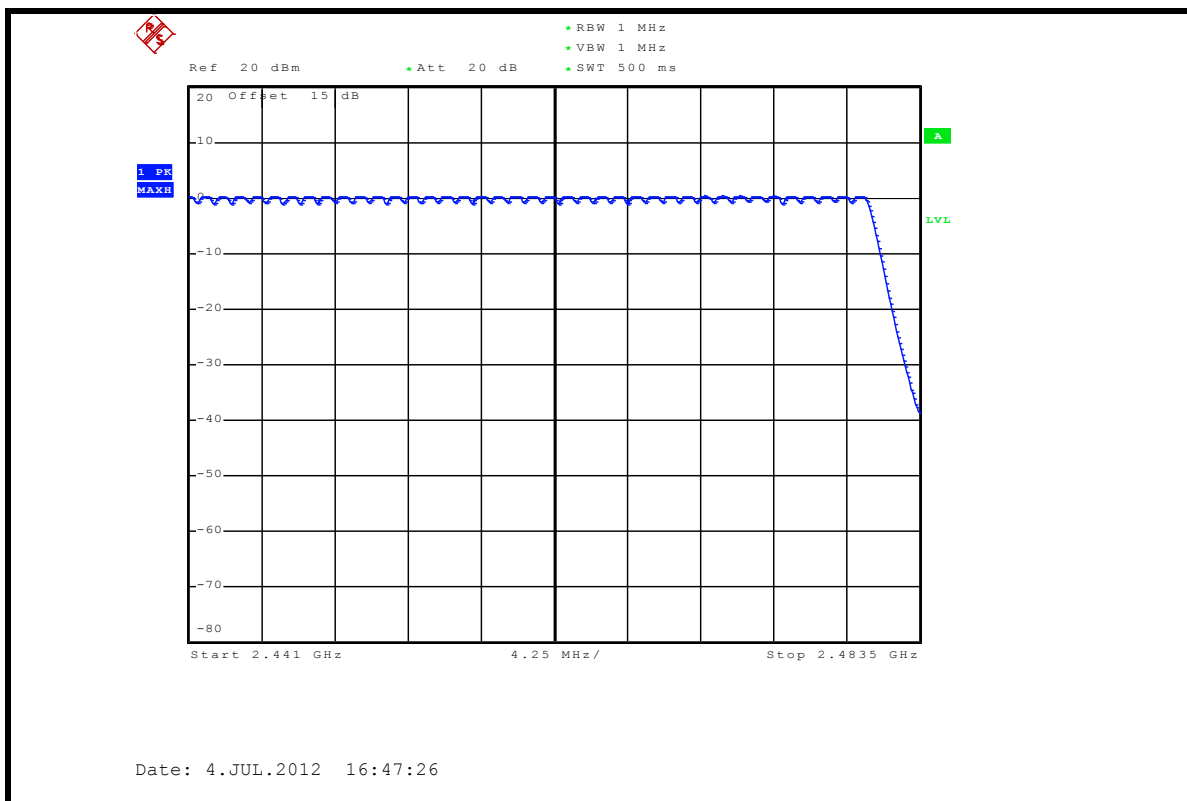
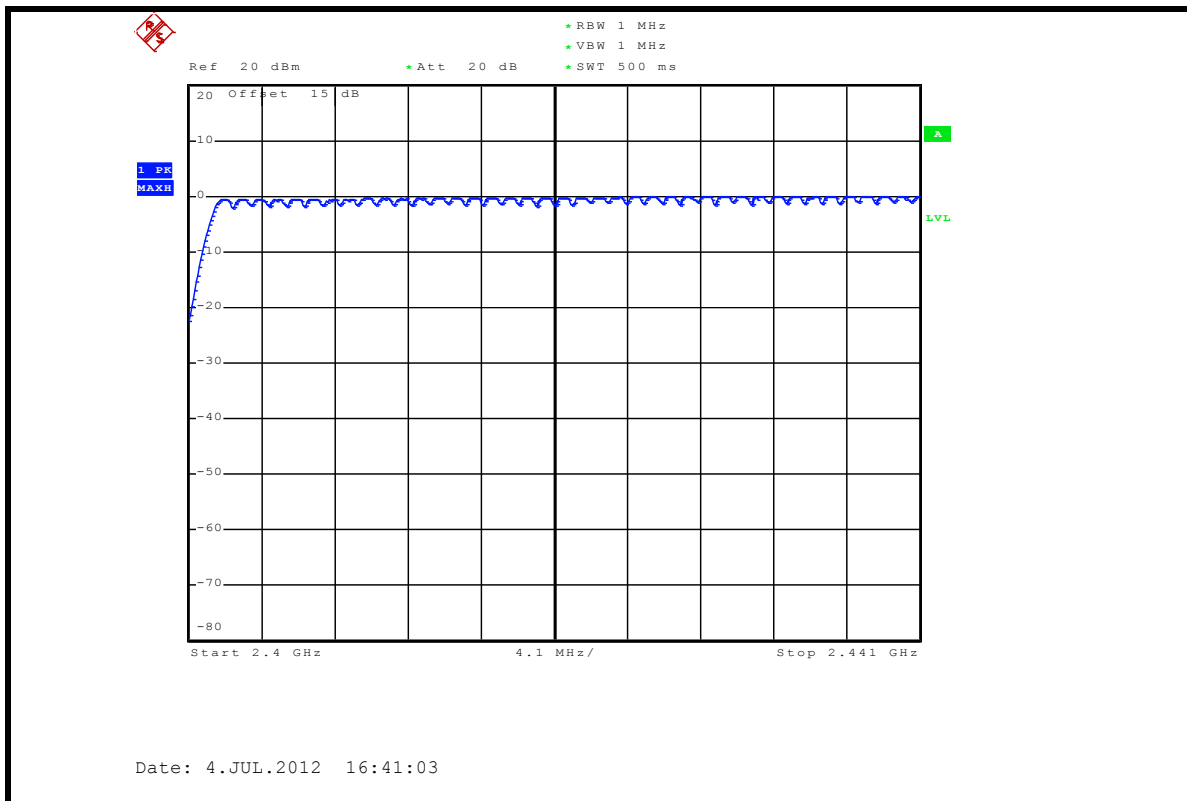

4.4 DWELL TIME ON EACH CHANNEL

4.4.1 LIMIT OF DWELL TIME USED

The average time of occupancy on any channel shall not be greater than 0.4 seconds within a period of 0.4 seconds multiplied by the number of hopping channels employed.

4.4.2 TEST SETUP

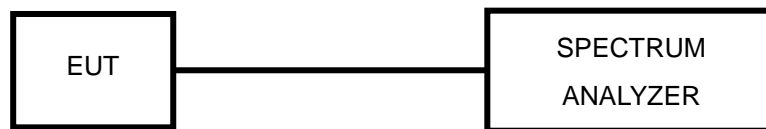

4.4.3 TEST INSTRUMENTS

Refer to section 4.1.2 to get information of above instrument.

4.4.4 TEST PROCEDURES

- a. Check the calibration of the measuring instrument (SA) using either an internal calibrator or a known signal from an external generator.
- b. Turn on the EUT and connect its antenna terminal to measurement via a low loss cable. Then set it to any one measured frequency within its operating range and make sure the instrument is operated in its linear range.
- c. Adjust the center frequency of SA on any frequency be measured and set SA to zero span mode. And then, set RBW and VBW of spectrum analyzer to proper value.
- d. Measure the time duration of one transmission on the measured frequency. And then plot the result with time difference of this time duration.
- e. Repeat above procedures until all different time-slot modes have been completed.

4.4.5 DEVIATION FROM TEST STANDARD

No deviation.



4.4.6 TEST RESULTS

GFSK

Mode	Average Hopping Channel	Package Transfer Time (usec)	Result (sec)	Limit (sec)
DH1	8.20	416.00	0.11	0.4
DH3	4.60	1692.00	0.25	0.4
DH5	2.80	2972.00	0.26	0.4

NOTE:

1. Dwell Time=79(channels) x 0.4(s) x average hopping channel x package transfer time
2. 79 channels come from the Hopping Channel number
3. Average Hopping Channel = hops/sweep time
4. t: Package Transfer Time(us)
5. Test plots of the transmitting time slot are shown on next page.



A D T

DH1

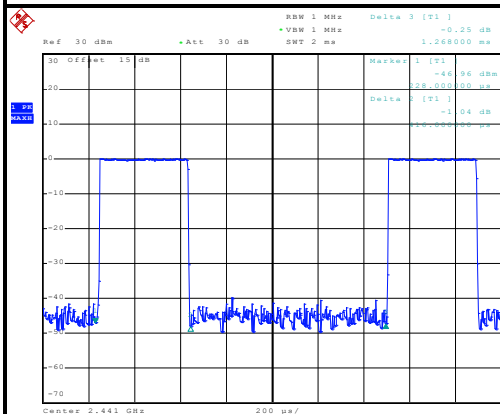

Date: 4.JUL.2012 16:24:53

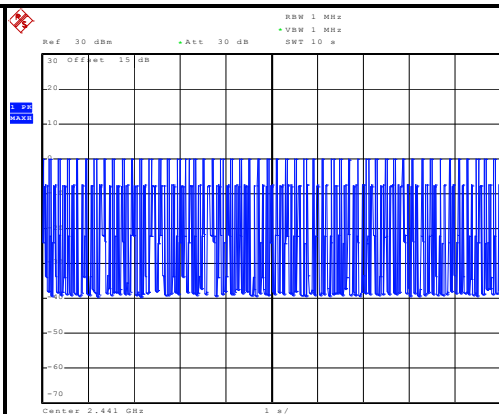

Date: 4.JUL.2012 16:31:37

DH3

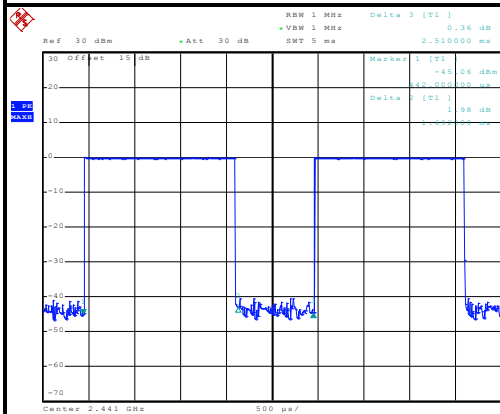

Date: 4.JUL.2012 16:27:26

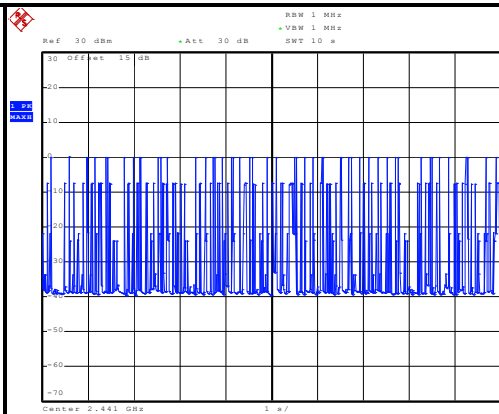

Date: 4.JUL.2012 16:31:59

DH5

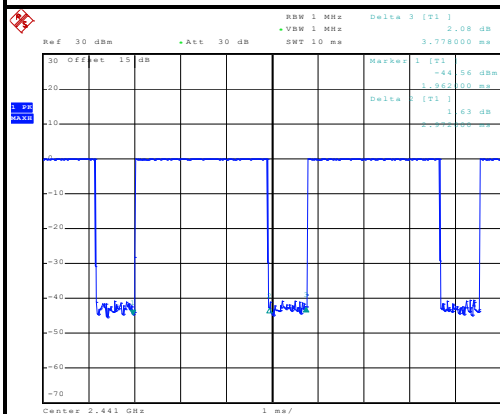

Date: 4.JUL.2012 16:29:35

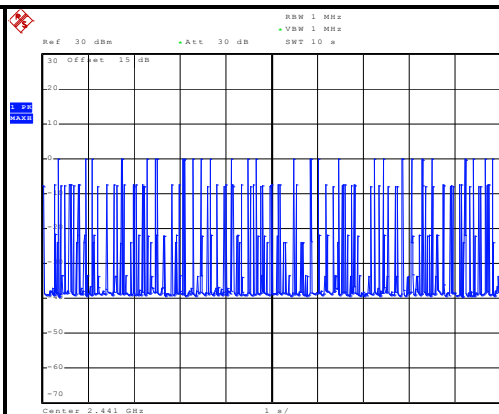

Date: 4.JUL.2012 16:32:20



A D T

$\pi/4$ -DQPSK

Mode	Average Hopping Channel	Package Transfer Time (usec)	Result (sec)	Limit (sec)
DH1	8.70	420.00	0.12	0.4
DH3	4.90	1682.00	0.26	0.4
DH5	3.50	2952.00	0.33	0.4

NOTE:

1. Dwell Time=79(channels) x 0.4(s) x average hopping channel x package transfer time
2. 79 channels come from the Hopping Channel number
3. Average Hopping Channel = hops/sweep time
4. t: Package Transfer Time(us)
5. Test plots of the transmitting time slot are shown on next page.



A D T

DH1

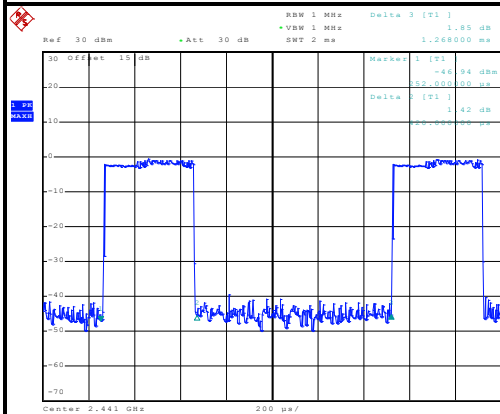

Date: 4.JUL.2012 16:25:29

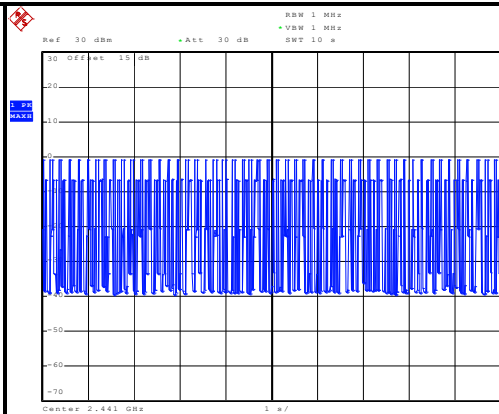

Date: 4.JUL.2012 16:32:42

DH3

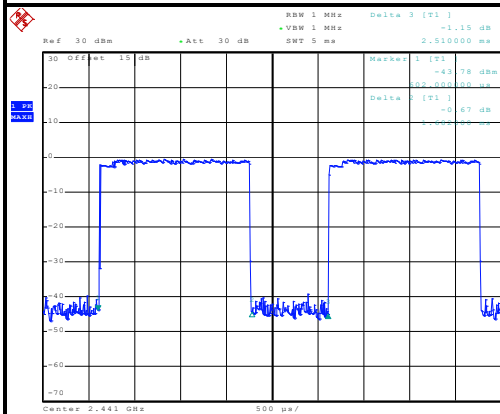

Date: 4.JUL.2012 16:28:05

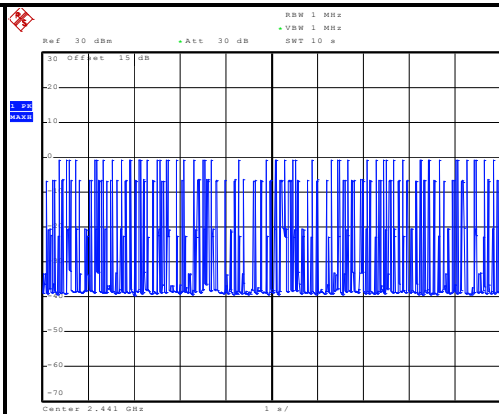

Date: 4.JUL.2012 16:33:24

DH5

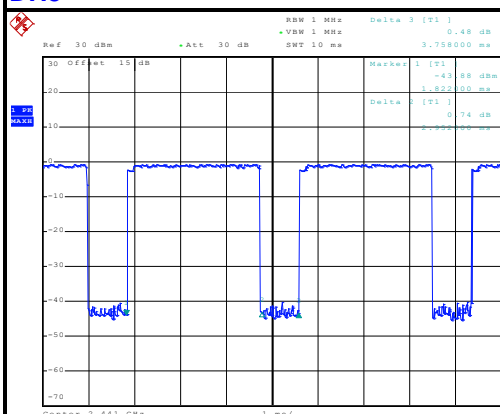

Date: 4.JUL.2012 16:30:07

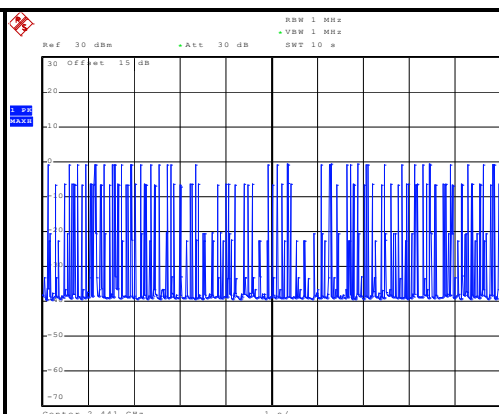

Date: 4.JUL.2012 16:34:04



8DPSK

Mode	Average Hopping Channel	Package Transfer Time (usec)	Result (sec)	Limit (sec)
DH1	8.00	412.00	0.10	0.4
DH3	4.10	1672.00	0.22	0.4
DH5	3.50	2992.00	0.33	0.4

NOTE:

1. Dwell Time=79(channels) x 0.4(s) x average hopping channel x package transfer time
2. 79 channels come from the Hopping Channel number
3. Average Hopping Channel = hops/sweep time
4. t: Package Transfer Time(us)
5. Test plots of the transmitting time slot are shown on next page.



A D T

DH1

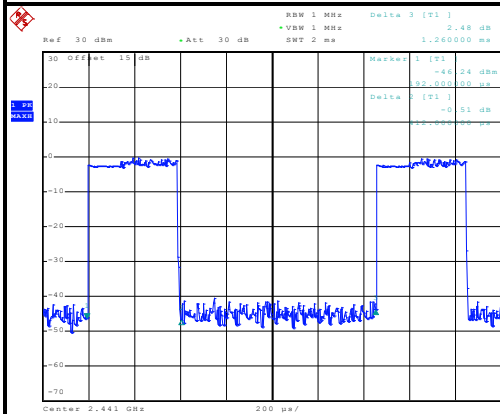

Date: 4.JUL.2012 16:26:34

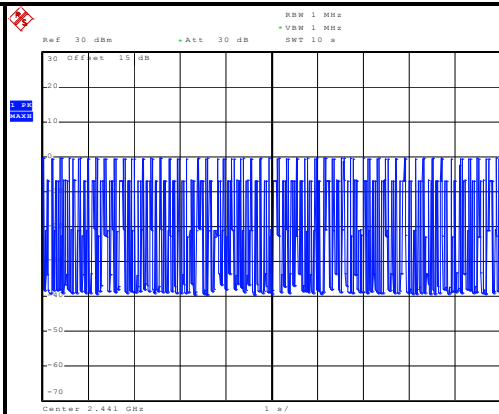

Date: 4.JUL.2012 16:34:28

DH3

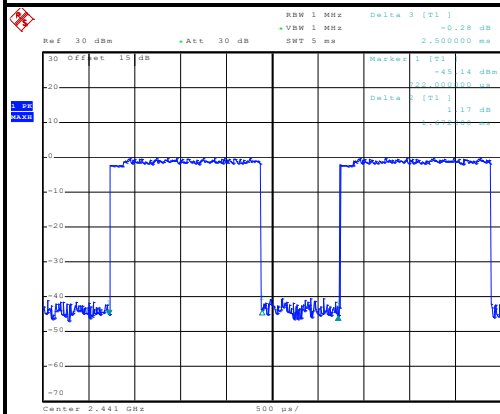

Date: 4.JUL.2012 16:28:39

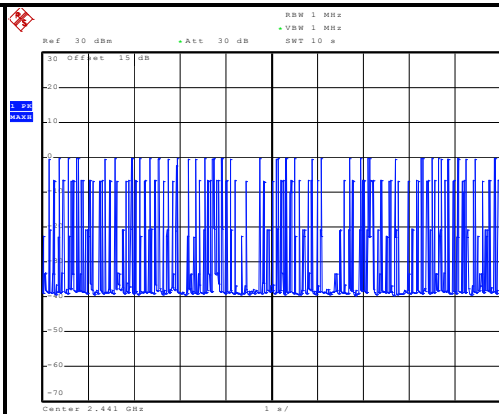

Date: 4.JUL.2012 16:34:49

DH5

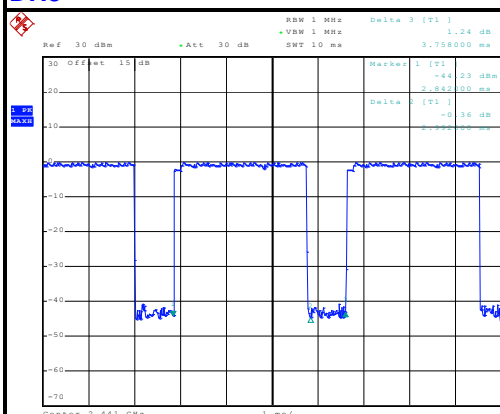

Date: 4.JUL.2012 16:30:46

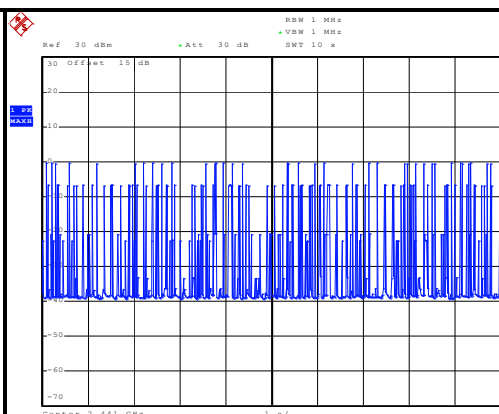

Date: 4.JUL.2012 16:35:09

4.5 CHANNEL BANDWIDTH

4.5.1 LIMITS OF CHANNEL BANDWIDTH

For frequency hopping system operating in the 2400-2483.5MHz, If the 20dB bandwidth of hopping channel is greater than 25kHz, two-thirds 20dB bandwidth of hopping channel shall be a minimum limit for the hopping channel separation.

4.5.2 TEST SETUP

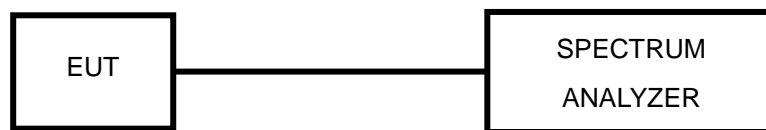

4.5.3 TEST INSTRUMENTS

Refer to section 4.1.2 to get information of above instrument.

4.5.4 TEST PROCEDURE

- a. Check the calibration of the measuring instrument using either an internal calibrator or a known signal from an external generator.
- b. Turn on the EUT and connect it to measurement instrument. Then set it to any one convenient frequency within its operating range. Set a reference level on the measuring instrument equal to the highest peak value.
- c. Measure the frequency difference of two frequencies that were attenuated 20dB from the reference level. Record the frequency difference as the emission bandwidth.
- d. Repeat above procedures until all frequencies measured were complete.

4.5.5 DEVIATION FROM TEST STANDARD

No deviation.

4.5.6 EUT OPERATING CONDITION

The software provided by client enabled the EUT to transmit and receive data at lowest, middle and highest channel frequencies individually.



A D T

4.5.7 TEST RESULTS

GFSK

CHANNEL	CHANNEL FREQUENCY (MHz)	20dB BANDWIDTH (MHz)
0	2402	0.904
39	2441	0.904
78	2480	0.904

CH 0

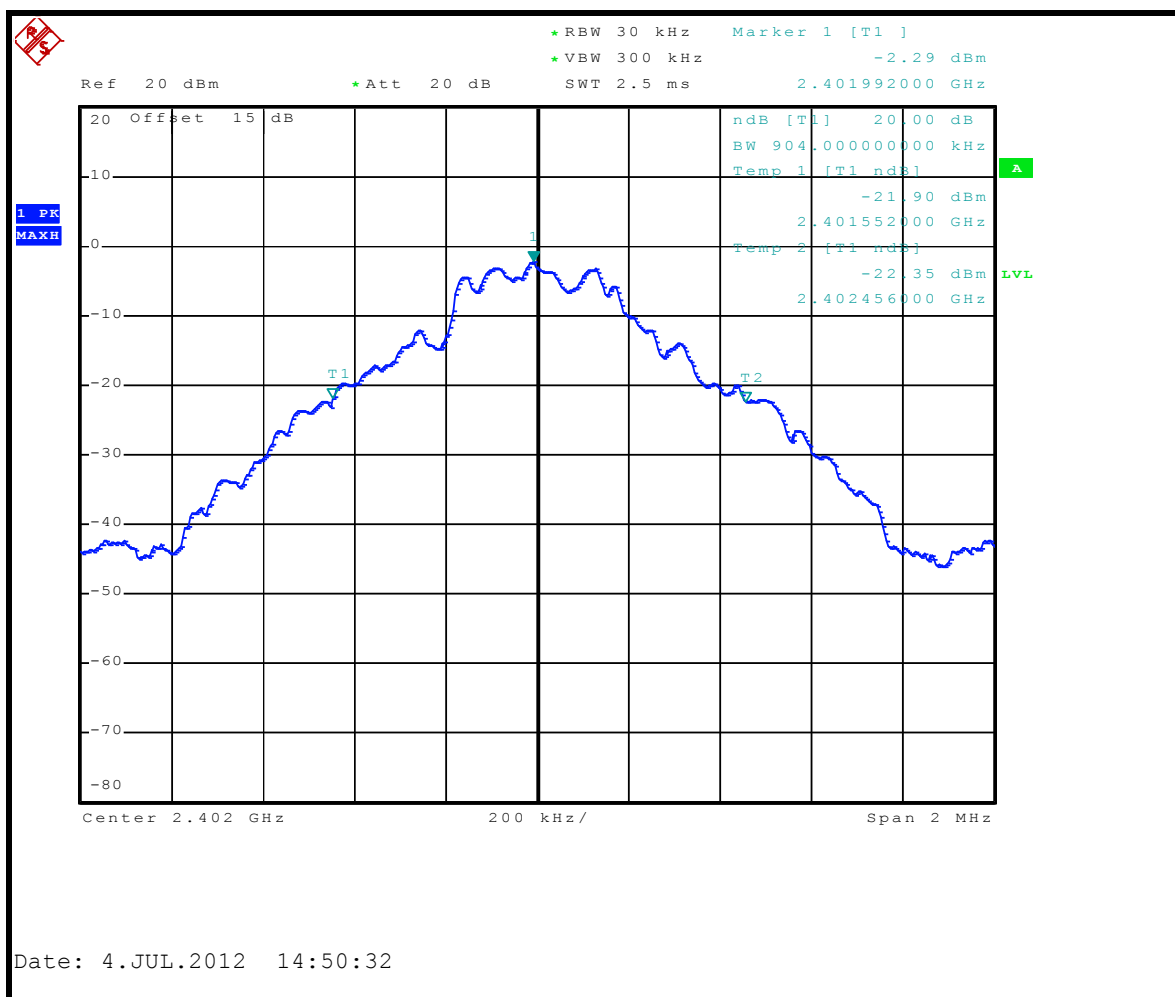



A D T

$\pi/4$ -DQPSK

CHANNEL	CHANNEL FREQUENCY (MHz)	20dB BANDWIDTH (MHz)
0	2402	1.348
39	2441	1.344
78	2480	1.348

CH 78

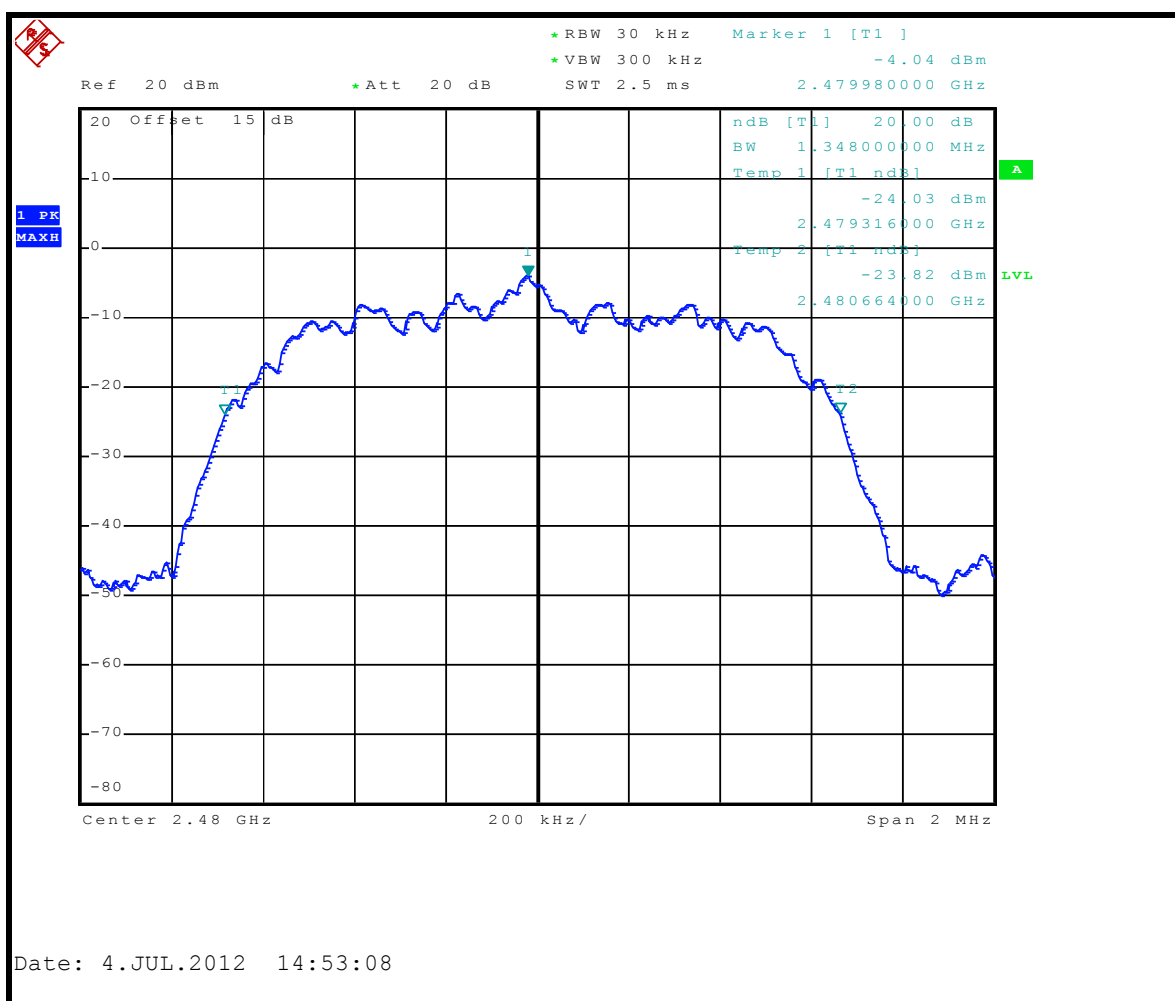



A D T

8DPSK

CHANNEL	CHANNEL FREQUENCY (MHz)	20dB BANDWIDTH (MHz)
0	2402	1.336
39	2441	1.336
78	2480	1.336

CH 0

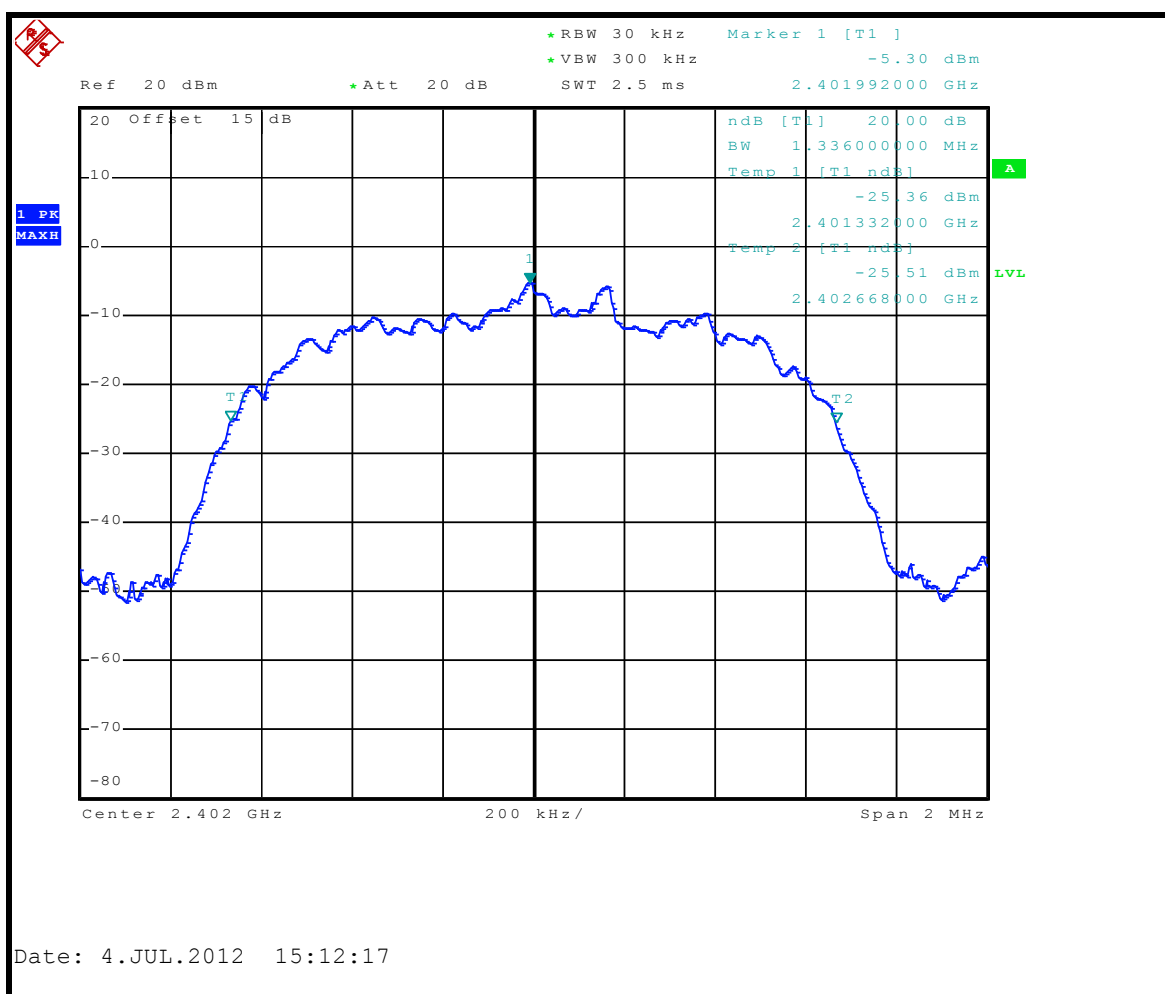

4.6 HOPPING CHANNEL SEPARATION

4.6.1 LIMIT OF HOPPING CHANNEL SEPARATION

At least 25kHz or two-third of 20dB hopping channel bandwidth (whichever is greater).

4.6.2 TEST SETUP

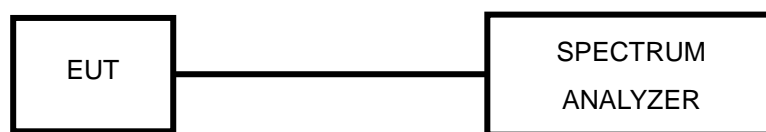

4.6.3 TEST INSTRUMENTS

Refer to section 4.1.2 to get information of above instrument.

4.6.4 TEST PROCEDURES

1. Check the calibration of the measuring instrument using either an internal calibrator or a known signal from an external generator.
2. Turn on the EUT and connect it to measurement instrument. Then set it to any one convenient frequency within its operating range.
3. By using the MaxHold function record the separation of two adjacent channels.
4. Measure the frequency difference of these two adjacent channels by SA MARK function. And then plot the result on SA screen.
5. Repeat above procedures until all frequencies measured were complete.

4.6.5 DEVIATION FROM TEST STANDARD

No deviation.

4.6.6 TEST RESULTS

GFSK

CHANNEL	FREQUENCY (MHz)	ADJACENT CHANNEL SEPARATION (MHz)	20dB BANDWIDTH (MHz)	MINIMUM LIMIT (MHz)	PASS / FAIL
0	2402	1.002	0.904	0.603	PASS
39	2441	1.002	0.904	0.603	PASS
78	2480	1.002	0.904	0.603	PASS

$\pi/4$ -DQPSK

CHANNEL	FREQUENCY (MHz)	ADJACENT CHANNEL SEPARATION (MHz)	20dB BANDWIDTH (MHz)	MINIMUM LIMIT (MHz)	PASS / FAIL
0	2402	1.002	1.348	0.899	PASS
39	2441	1.002	1.344	0.896	PASS
78	2480	1.002	1.348	0.899	PASS

8DPSK

CHANNEL	FREQUENCY (MHz)	ADJACENT CHANNEL SEPARATION (MHz)	20dB BANDWIDTH (MHz)	MINIMUM LIMIT (MHz)	PASS / FAIL
0	2402	1.002	1.336	0.891	PASS
39	2441	1.002	1.336	0.891	PASS
78	2480	1.002	1.336	0.891	PASS

NOTE: The minimum limit is two-third 20dB bandwidth.



A D T

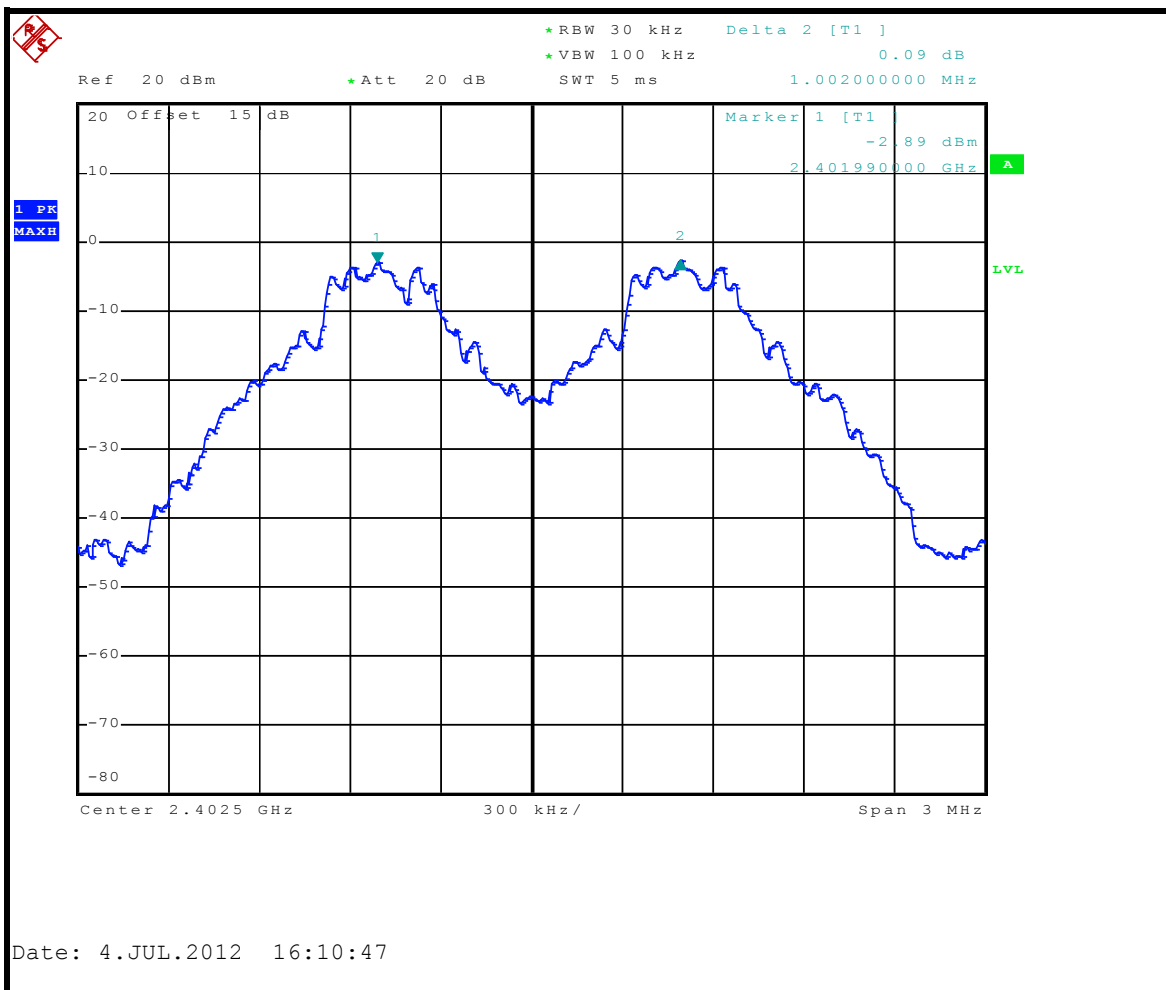

4.7 MAXIMUM OUTPUT POWER

4.7.1 LIMITS OF MAXIMUM OUTPUT POWER MEASUREMENT

The Maximum Output Power Measurement is 125mW.

4.7.2 TEST SETUP

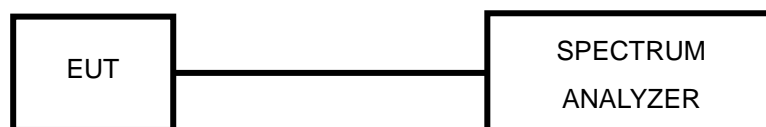

4.7.3 TEST INSTRUMENTS

Refer to section 4.1.2 to get information of above instrument.

4.7.4 TEST PROCEDURES

- a. Check the calibration of the measuring instrument using either an internal calibrator or a known signal from an external generator.
- b. Turn on the EUT and connect it to measurement instrument. Then set it to any one convenient frequency within its operating range. Set a reference level on the measuring instrument equal to the highest peak value.
- c. The center frequency of the spectrum analyzer is set to the fundamental frequency and using 3MHz RBW and 10 MHz VBW.
- d. Measure the captured power within the band and recording the plot.
- e. Repeat above procedures until all frequencies required were complete.

4.7.5 DEVIATION FROM TEST STANDARD

No deviation.

4.7.6 EUT OPERATING CONDITION

The software provided by client enabled the EUT to transmit and receive data at lowest, middle and highest channel frequencies individually.

4.7.7 TEST RESULTS

GFSK

CHANNEL	CHANNEL FREQUENCY (MHz)	OUTPUT POWER (W)	OUTPUT POWER (dBm)	POWER LIMIT (mW)	PASS/FAIL
0	2402	0.0013	1.16	125	PASS
39	2441	0.0016	2.11	125	PASS
78	2480	0.0017	2.26	125	PASS

$\pi/4$ -DQPSK

CHANNEL	CHANNEL FREQUENCY (MHz)	OUTPUT POWER (W)	OUTPUT POWER (dBm)	POWER LIMIT (mW)	PASS/FAIL
0	2402	0.0011	0.58	125	PASS
39	2441	0.0014	1.32	125	PASS
78	2480	0.0014	1.48	125	PASS

8DPSK

CHANNEL	CHANNEL FREQUENCY (MHz)	OUTPUT POWER (W)	OUTPUT POWER (dBm)	POWER LIMIT (mW)	PASS/FAIL
0	2402	0.0013	1.01	125	PASS
39	2441	0.0015	1.76	125	PASS
78	2480	0.0016	1.92	125	PASS



A D T

GFSK CH 78

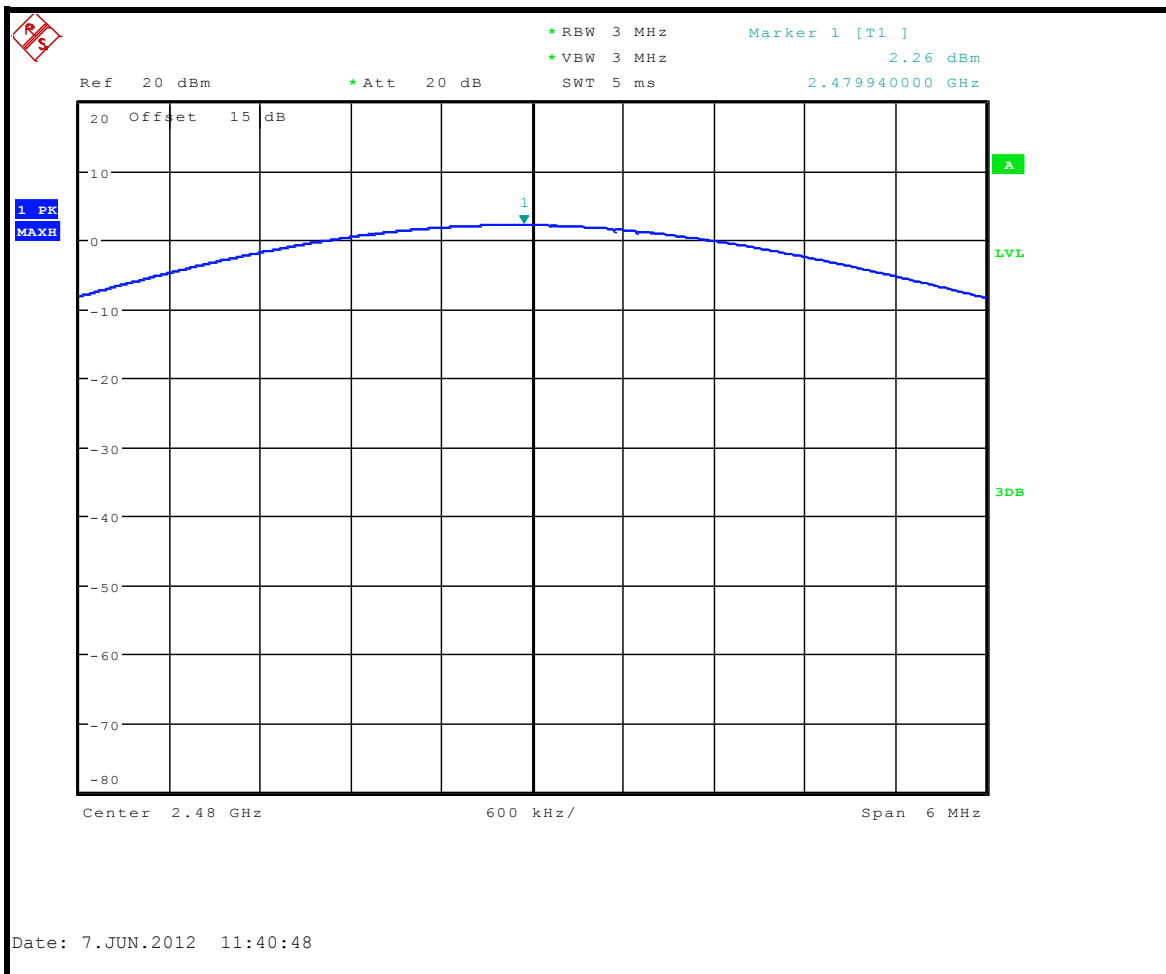

4.8 CONDUCTED OUT OF BAND EMISSION MEASUREMENT

4.8.1 LIMITS OF CONDUCTED OUT OF BAND EMISSION MEASUREMENT

Below -20dB of the highest emission level of operating band (in 100kHz RBW).

4.8.2 TEST INSTRUMENTS

Refer to section 4.1.2 to get information of above instrument.

4.8.3 TEST PROCEDURE

1. Set RBW = 100 kHz .
2. Set VBW = 300 kHz .
3. Set span to encompass the spectrum to be examined
4. Detector = peak.
5. Trace Mode = max hold.
6. Sweep = auto couple.

4.8.4 DEVIATION FROM TEST STANDARD

No deviation.

4.8.5 EUT OPERATING CONDITION

The software provided by client enabled the EUT to transmit continuously.

4.8.6 TEST RESULTS

The spectrum plots are attached on the following images. D1 line indicates the highest level, D2 line indicates the 20dB offset below D1. It shows compliance with the requirement.



A D T

GFSK

Hopping disabled_Low Channel

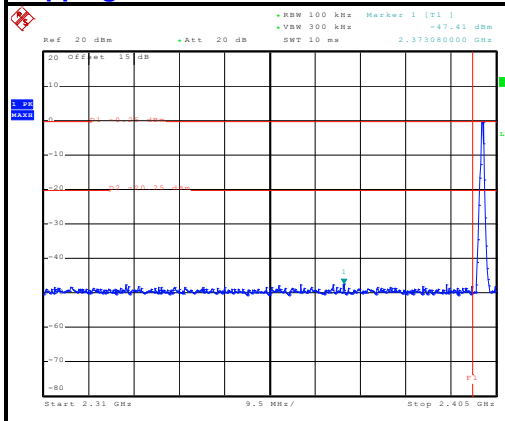

Date: 4.JUL.2012 17:27:20

Hopping disabled_High Channel

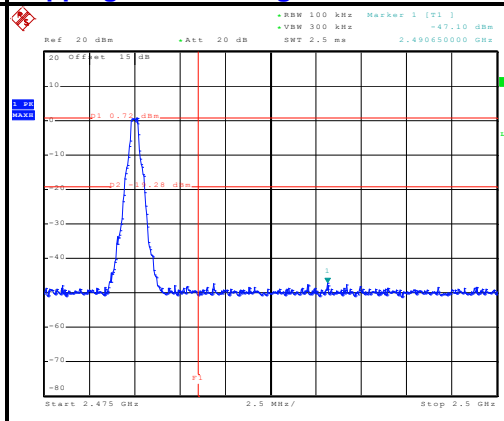

Date: 4.JUL.2012 17:29:50

Hopping enabled_Low Channel

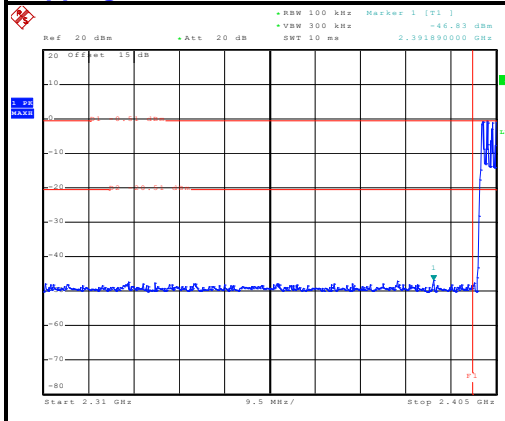

Date: 4.JUL.2012 16:02:17

Hopping enabled_High Channel

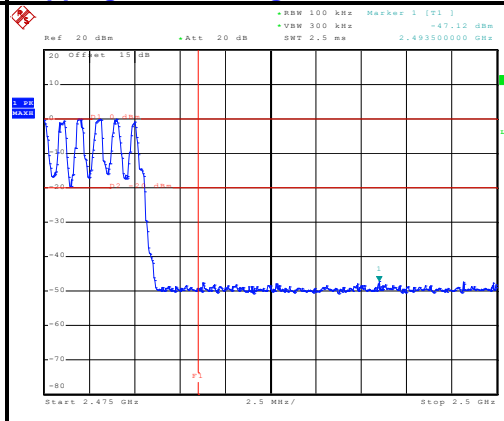

Date: 4.JUL.2012 16:04:21



A D T

$\pi/4$ -DQPSK

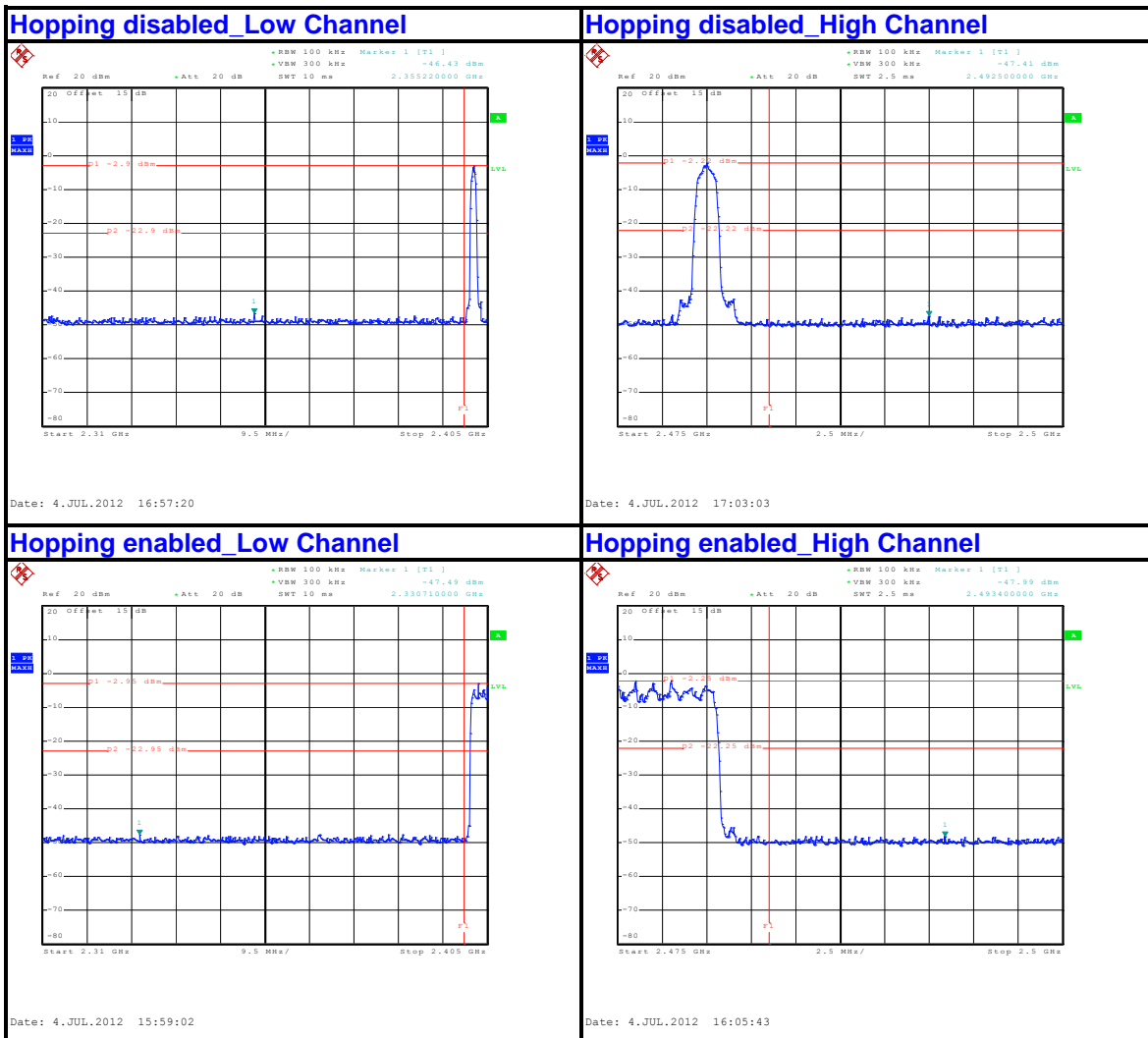



A D T

8DPSK

Hopping disabled_Low Channel

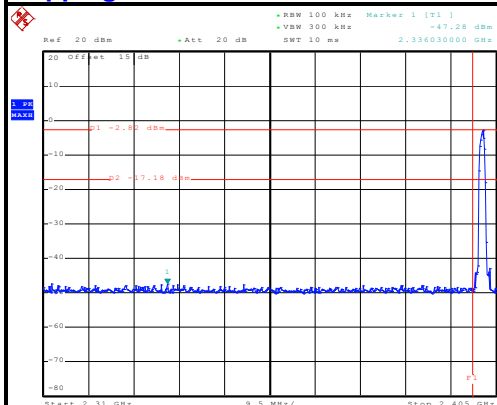

Date: 4.JUL.2012 17:13:01

Hopping disabled_High Channel

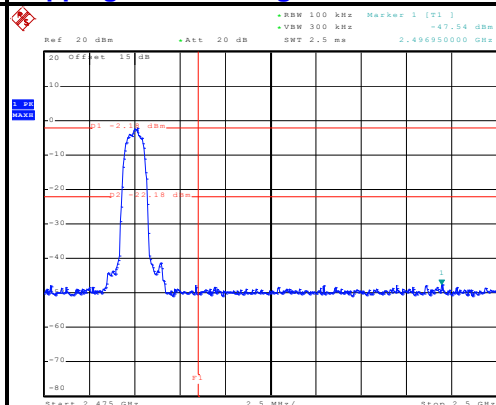

Date: 4.JUL.2012 17:24:13

Hopping enabled_Low Channel

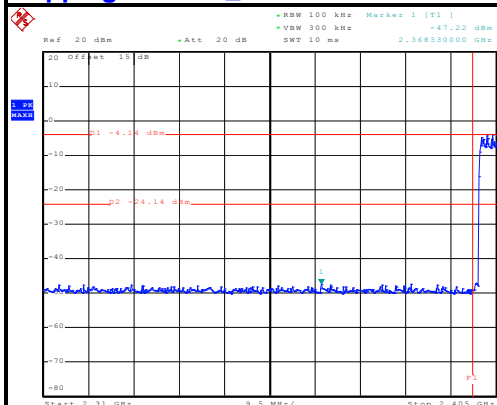

Date: 4.JUL.2012 16:00:53

Hopping enabled_High Channel

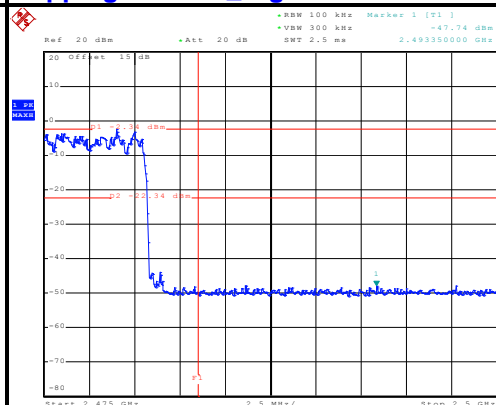

Date: 4.JUL.2012 16:06:51

5. TEST TYPES AND RESULTS (FOR Bluetooth LE 4.0)

5.1 RADIATED EMISSION AND BANDEGE MEASUREMENT

5.1.1 LIMITS OF RADIATED EMISSION AND BANDEGE MEASUREMENT

Same as 4.1.1.

5.1.2 TEST INSTRUMENTS

Same as 4.1.2.

5.1.3 TEST PROCEDURES

Same as 4.1.3.

5.1.4 DEVIATION FROM TEST STANDARD

No deviation.

5.1.5 TEST SETUP

Same as 4.1.5.

5.1.6 EUT OPERATING CONDITIONS

Same as 4.1.6.



A D T

5.1.7 TEST RESULTS

ABOVE 1GHz DATA



Bureau Veritas Consumer Products Services Ltd., Taoyuan Branch

A D T

Data: 19

Date: 2012-06-14

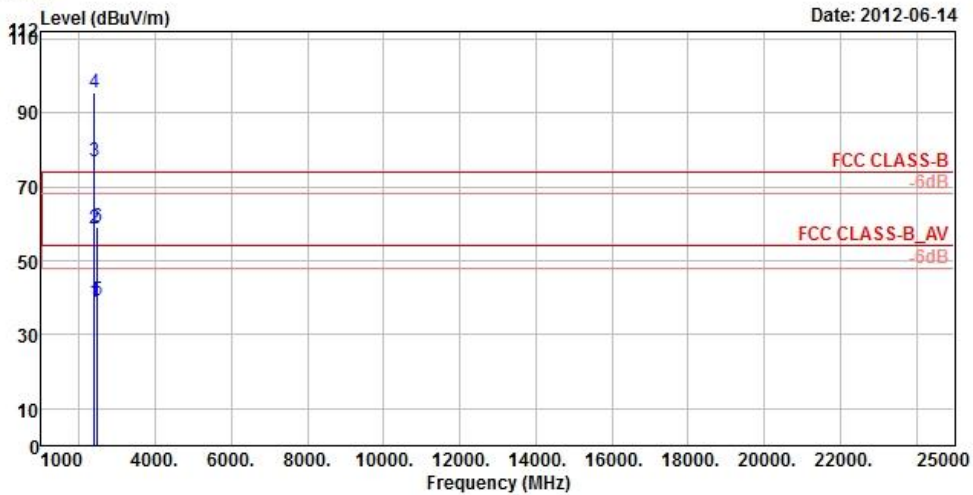

Site : 966 Chamber 5
 Condition : FCC CLASS-B 3m ANT_18G~40G_HF HORIZONTAL
 Brand/Model: PL01210
 Remark : BT 4.0 TX CH00
 Tested by : Kay Wu
 Temperature : 25°C
 Humidity : 65%
 Plane : Y
 Rate : 11110000

	Freq	Level	Read Level	Limit Line	OverAntenna Limit	Antenna Factor	Cable Loss	Preamp Factor	A/Pos	T/Pos	Remark
	MHz	dBuV/m	dBuV	dBuV/m	dB	dB/m	dB	dB	cm	deg	
1	2390.00	38.91	44.30	54.00	-15.09	27.26	4.87	37.52	129	61	Average
2	2390.00	58.58	63.97	74.00	-15.42	27.26	4.87	37.52	129	61	Peak
3	2402.00	76.87	82.26			27.26	4.87	37.52	129	61	Average
4	2402.00	95.43	100.82			27.26	4.87	37.52	129	61	Peak
5	2483.50	39.26	44.16	54.00	-14.74	27.50	4.92	37.32	129	61	Average
6	2483.50	59.10	64.00	74.00	-14.90	27.50	4.92	37.32	129	61	Peak



A D T



Bureau Veritas Consumer Products Services Ltd., Taoyuan Branch

A D T

Data: 20

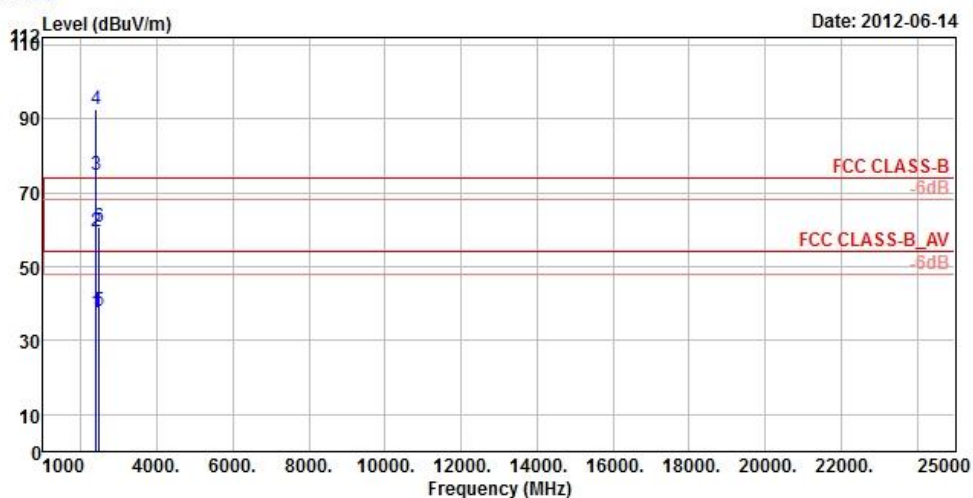

Site : 966 Chamber 5
 Condition : FCC CLASS-B 3m ANT_18G~40G_HF VERTICAL
 Brand/Model: PL01210
 Remark : BT 4.0 TX CH00
 Tested by : Kay Wu
 Temperature : 25°C
 Humidity : 65%
 Plane : Y
 Rate : 11110000

	Freq	Level	Read Level	Limit Line	OverLimit	Antenna Factor	Cable Loss	Preamp Factor	A/Pos	T/Pos	Remark
	MHz	dBuV/m	dBuV	dBuV/m	dB	dB/m	dB	dB	cm	deg	
1	2390.00	37.45	42.84	54.00	-16.55	27.26	4.87	37.52	121	23	Average
2	2390.00	59.34	64.73	74.00	-14.66	27.26	4.87	37.52	121	23	Peak
3 pp	2402.00	74.93	80.32			27.26	4.87	37.52	121	23	Average
4 pk	2402.00	92.41	97.80			27.26	4.87	37.52	121	23	Peak
5	2483.50	37.88	42.78	54.00	-16.12	27.50	4.92	37.32	121	23	Average
6	2483.50	60.79	65.69	74.00	-13.21	27.50	4.92	37.32	121	23	Peak



A D T



Bureau Veritas Consumer Products Services Ltd., Taoyuan Branch

A D T

Data: 19

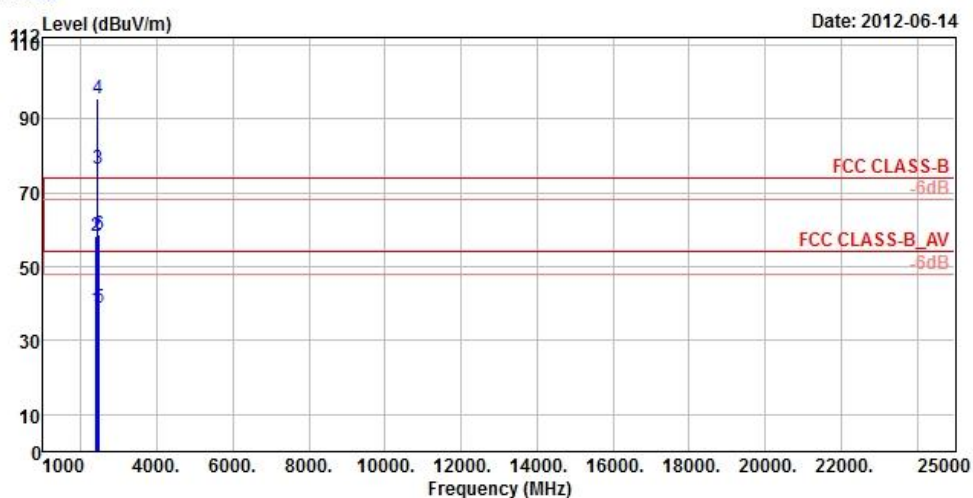

Site : 966 Chamber 5
 Condition : FCC CLASS-B 3m ANT_18G~40G_HF HORIZONTAL
 Brand/Model: PL01210
 Remark : BT 4.0 TX CH19
 Tested by : Kay Wu
 Temperature : 25°C
 Humidity : 65%
 Plane : Y
 Rate : 11110000

	Read	Limit	OverAntenna	Cable	Preamp	A/Pos	T/Pos			
Level	Level	Line	Limit	Loss	Loss	Factor	Factor	cm	deg	
dBuV	dBuV	dBuV/m	dB	dB	dB	dB	dB			
MHz	dBuV/m	dBuV	dBuV/m	dB	dB/m	dB	dB	cm	deg	Remark
1	2390.00	38.45	43.84	54.00	-15.55	27.26	4.87	37.52	127	61 Average
2	2390.00	58.40	63.79	74.00	-15.60	27.26	4.87	37.52	127	61 Peak
3 pp	2440.00	76.49	81.66			27.40	4.89	37.46	127	61 Average
4 pk	2440.00	95.42	100.59			27.40	4.89	37.46	127	61 Peak
5	2483.50	38.89	43.79	54.00	-15.11	27.50	4.92	37.32	127	61 Average
6	2483.50	58.83	63.73	74.00	-15.17	27.50	4.92	37.32	127	61 Peak



A D T



Bureau Veritas Consumer Products Services Ltd., Taoyuan Branch

A D T

Data: 20

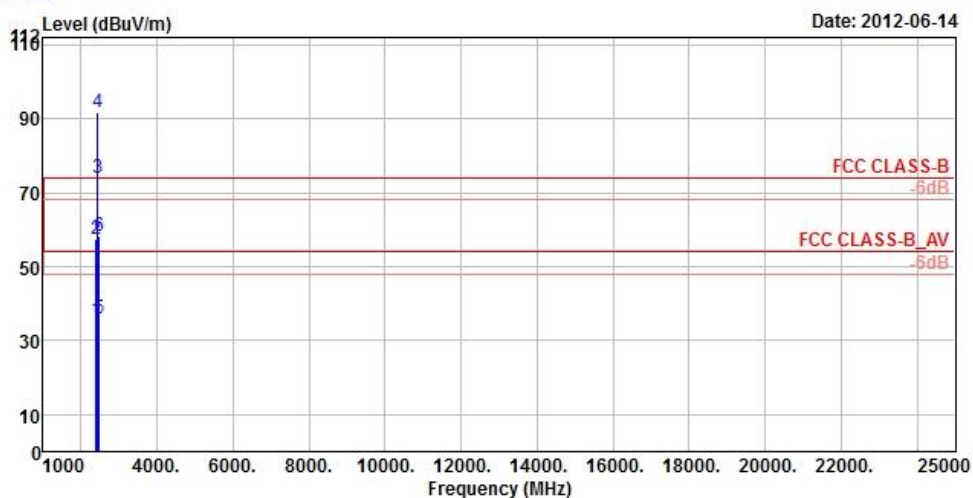

Site : 966 Chamber 5
 Condition : FCC CLASS-B 3m ANT_18G~40G_HF VERTICAL
 Brand/Model: PL01210
 Remark : BT 4.0 TX CH19
 Tested by : Kay Wu
 Temperature : 25°C
 Humidity : 65%
 Plane : Y
 Rate : 11110000

	Freq	Level	Read Level	Limit Line	OverLimit	Antenna Factor	Cable Loss	Preamp Factor	A/Pos	T/Pos	Remark
	MHz	dBuV/m	dBuV	dBuV/m	dB	dB/m	dB	dB	cm	deg	
1	2390.00	35.73	41.12	54.00	-18.27	27.26	4.87	37.52	118	12	Average
2	2390.00	57.49	62.88	74.00	-16.51	27.26	4.87	37.52	118	12	Peak
3 pp	2440.00	74.02	79.19			27.40	4.89	37.46	118	12	Average
4 pk	2440.00	91.61	96.78			27.40	4.89	37.46	118	12	Peak
5	2483.50	36.10	41.00	54.00	-17.90	27.50	4.92	37.32	118	12	Average
6	2483.50	58.20	63.10	74.00	-15.80	27.50	4.92	37.32	118	12	Peak



A D T



Bureau Veritas Consumer Products Services Ltd., Taoyuan Branch

A D T

Data: 19

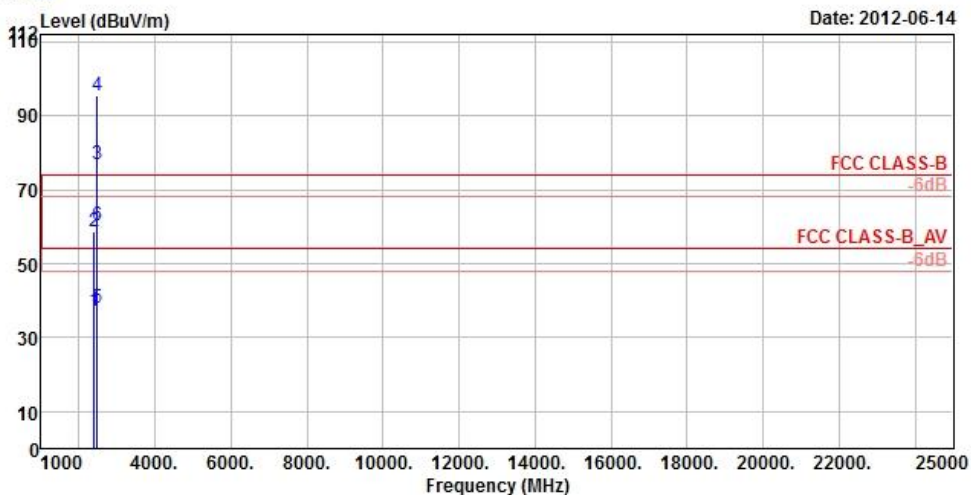

Site : 966 Chamber 5
 Condition : FCC CLASS-B 3m ANT_18G~40G_HF HORIZONTAL
 Brand/Model: PL01210
 Remark : BT 4.0 TX CH39
 Tested by : Kay Wu
 Temperature : 25°C
 Humidity : 65%
 Plane : Y
 Rate : 11110000

	Freq	Level	Read Level	Limit Line	OverLimit	Antenna Factor	Cable Loss	Preamp Factor	A/Pos	T/Pos	Remark
	MHz	dBuV/m	dBuV	dBuV/m	dB	dB/m	dB	dB	cm	deg	
1	2390.00	37.25	42.64	54.00	-16.75	27.26	4.87	37.52	129	63	Average
2	2390.00	58.89	64.28	74.00	-15.11	27.26	4.87	37.52	129	63	Peak
3 pp	2480.00	77.06	81.96			27.50	4.92	37.32	129	63	Average
4 pk	2480.00	95.64	100.54			27.50	4.92	37.32	129	63	Peak
5	2483.50	37.95	42.85	54.00	-16.05	27.50	4.92	37.32	129	63	Average
6	2483.50	60.37	65.27	74.00	-13.63	27.50	4.92	37.32	129	63	Peak



A D T



Bureau Veritas Consumer Products Services Ltd., Taoyuan Branch

A D T

Data: 20

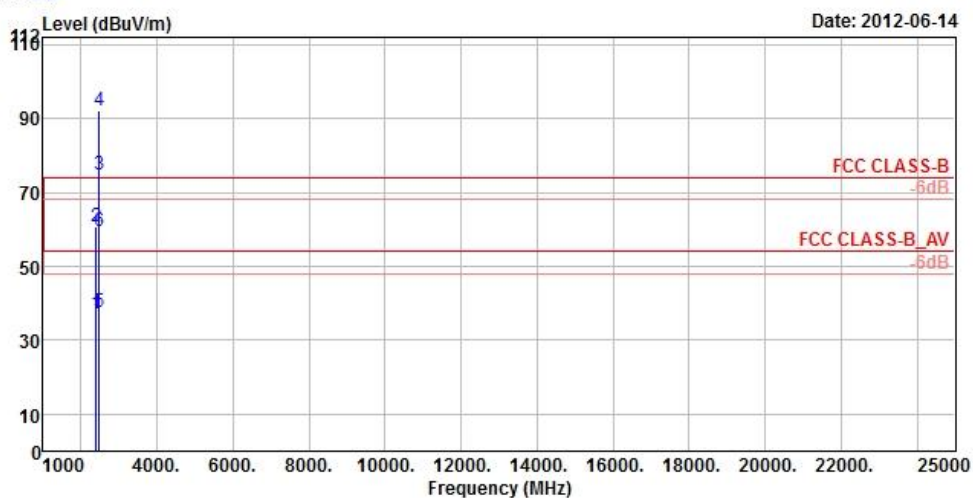

Site : 966 Chamber 5
 Condition : FCC CLASS-B 3m ANT_18G~40G_HF VERTICAL
 Brand/Model: PL01210
 Remark : BT 4.0 TX CH39
 Tested by : Kay Wu
 Temperature : 25°C
 Humidity : 65%
 Plane : Y
 Rate : 11110000

	Freq	Level	Read Level	Limit Line	OverLimit	Antenna Factor	Cable Loss	Preamp Factor	A/Pos	T/Pos	Remark
	MHz	dBuV/m	dBuV	dBuV/m	dB	dB/m	dB	dB	cm	deg	
1	2390.00	37.37	42.76	54.00	-16.63	27.26	4.87	37.52	121	9	Average
2	2390.00	60.71	66.10	74.00	-13.29	27.26	4.87	37.52	121	9	Peak
3 pp	2480.00	74.89	79.79			27.50	4.92	37.32	121	9	Average
4 pk	2480.00	92.00	96.90			27.50	4.92	37.32	121	9	Peak
5	2483.50	37.75	42.65	54.00	-16.25	27.50	4.92	37.32	121	9	Average
6	2483.50	59.42	64.32	74.00	-14.58	27.50	4.92	37.32	121	9	Peak



A D T

BELOW 1GHz WORST-CASE DATA



Bureau Veritas Consumer Products Services Ltd., Taoyuan Branch

A D T

Data: 5

Date: 2012-06-15

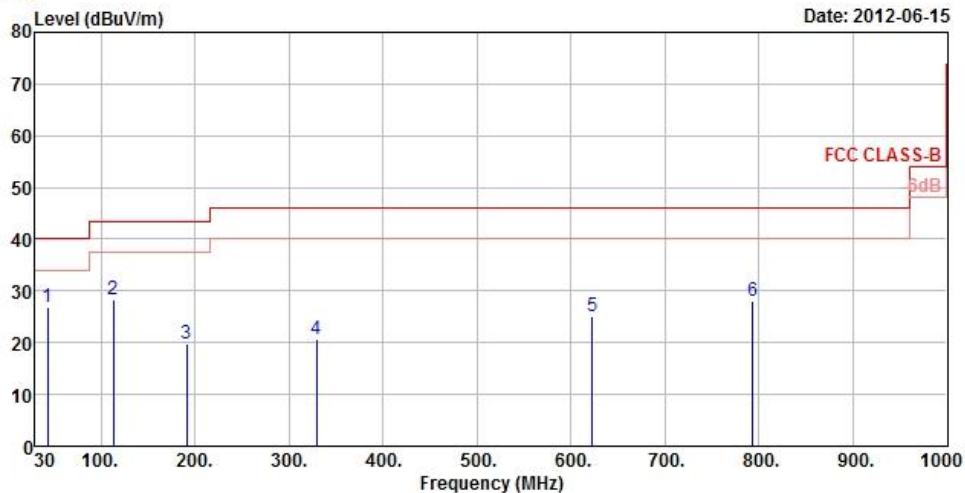

Site : 966 Chamber 5
 Condition : FCC CLASS-B 3m ANT_30M~1G_LF HORIZONTAL
 Brand/Model: PL01210
 Remark : BT 4.0 TX LF
 Tested by : Kay Wu
 Temperature : 25°C
 Humidity : 65%
 Plane : Y
 Rate : 11110000

	Freq	Level	Read Level	Limit Line	OverLimit	Antenna Factor	Cable Loss	Preamp Factor	A/Pos	T/Pos	Remark
	MHz	dBuV/m	dBuV	dBuV/m	dB	dB/m	dB	dB	cm	deg	
1 pp	43.50	26.87	43.68	40.00	-13.13	13.59	0.71	31.11	102	122	Peak
2	112.89	28.45	48.90	43.50	-15.05	10.27	1.14	31.86	107	44	Peak
3	190.92	19.64	39.79	43.50	-23.86	9.98	1.55	31.68	220	136	Peak
4	329.40	20.68	36.67	46.00	-25.32	13.66	2.16	31.81	100	199	Peak
5	622.70	25.09	34.21	46.00	-20.91	19.88	3.16	32.16	201	84	Peak
6	793.50	28.16	33.76	46.00	-17.84	22.13	3.68	31.41	120	285	Peak



A D T



Bureau Veritas Consumer Products Services Ltd., Taoyuan Branch

A D T

Data: 6

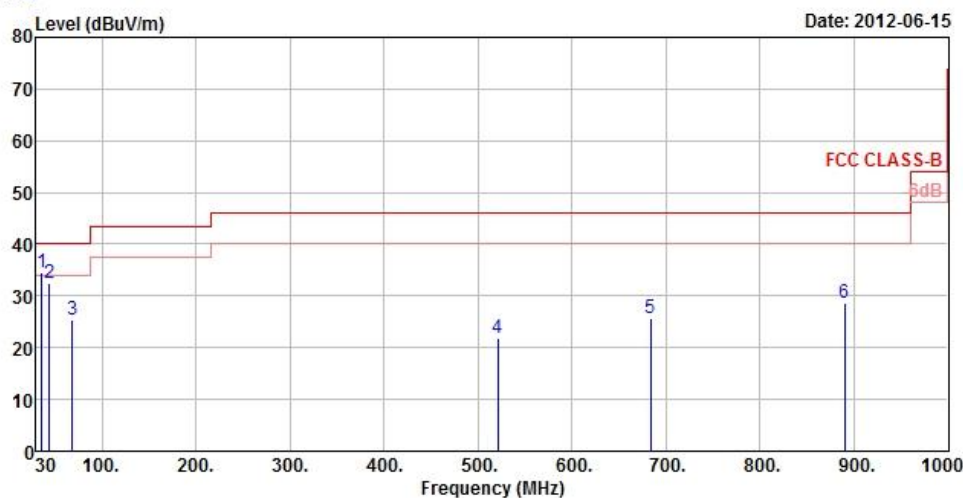

Date: 2012-06-15

Site : 966 Chamber 5
 Condition : FCC CLASS-B 3m ANT_30M~1G_LF VERTICAL
 Brand/Model: PL01210
 Remark : BT 4.0 TX LF
 Tested by : Kay Wu
 Temperature : 25°C
 Humidity : 65%
 Plane : Y
 Rate : 11110000

	Freq	Level	Read Level	Limit Line	OverLimit	Antenna Factor	Cable Loss	Preamp Factor	A/Pos	T/Pos	Remark
	MHz	dBuV/m	dBuV	dBuV/m	dB	dB/m	dB	dB	cm	deg	
1	pp	36.21	34.40	51.90	40.00	-5.60	12.94	0.61	31.05	100	360 QP
2		44.04	32.44	49.25	40.00	-7.56	13.59	0.71	31.11	100	311 QP
3	pk	68.34	25.40	45.39	40.00	-14.60	10.89	0.89	31.77	103	133 Peak
4		521.20	21.99	32.93	46.00	-24.01	17.79	2.85	31.58	100	199 Peak
5		683.60	25.75	33.60	46.00	-20.25	20.62	3.37	31.84	132	252 Peak
6		890.10	28.67	33.33	46.00	-17.33	23.39	3.94	31.99	100	85 Peak

5.2 CONDUCTED EMISSION MEASUREMENT

5.2.1 LIMITS OF CONDUCTED EMISSION MEASUREMENT

Same as 4.2.1.

5.2.2 TEST INSTRUMENTS

Same as 4.2.2.

5.2.3 TEST PROCEDURES

Same as 4.2.3.

5.2.4 DEVIATION FROM TEST STANDARD

No deviation.

5.2.5 TEST SETUP

Same as 4.2.5.

5.2.6 EUT OPERATING CONDITIONS

Same as 4.2.6.

5.2.7 TEST RESULTS

CONDUCTED WORST CASE DATA:

PHASE	Line 1	6dB BANDWIDTH	9kHz
-------	--------	---------------	------

No	Freq. [MHz]	Corr. Factor (dB)	Reading Value		Emission Level		Limit		Margin	
			[dB (uV)]		[dB (uV)]		[dB (uV)]		(dB)	
			Q.P.	AV.	Q.P.	AV.	Q.P.	AV.	Q.P.	AV.
1	0.18125	0.15	45.38	32.21	45.53	32.36	64.43	54.43	-18.90	-22.07
2	0.55625	0.18	43.89	30.87	44.07	31.05	56.00	46.00	-11.93	-14.95
3	0.97813	0.19	43.06	34.56	43.25	34.75	56.00	46.00	-12.75	-11.25
4	1.16797	0.20	44.10	35.12	44.30	35.32	56.00	46.00	-11.70	-10.68
5	2.62891	0.29	46.29	38.71	46.58	39.00	56.00	46.00	-9.42	-7.00
6	6.50391	0.38	42.52	33.42	42.90	33.80	60.00	50.00	-17.10	-16.20

REMARKS:

1. Q.P. and AV. are abbreviations of quasi-peak and average individually.
2. The emission levels of other frequencies were very low against the limit.
3. Margin value = Emission level - Limit value
4. Correction factor = Insertion loss + Cable loss
5. Emission Level = Correction Factor + Reading Value.

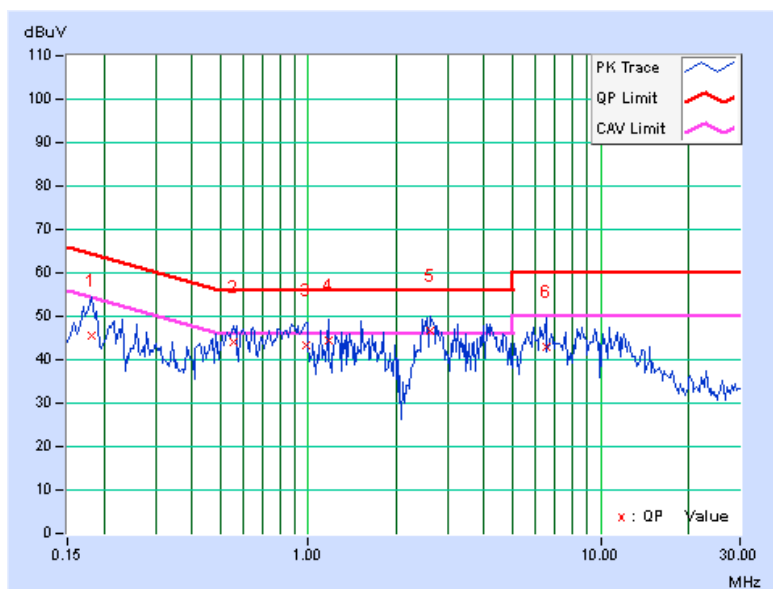



A D T

PHASE	Line 1	6dB BANDWIDTH	9kHz
-------	--------	---------------	------

No	Freq. [MHz]	Corr. Factor (dB)	Reading Value		Emission Level		Limit		Margin	
			[dB (uV)]		[dB (uV)]		[dB (uV)]		(dB)	
			Q.P.	AV.	Q.P.	AV.	Q.P.	AV.	Q.P.	AV.
1	0.17344	0.13	45.81	32.77	45.94	32.90	64.79	54.79	-18.85	-21.89
2	0.54844	0.17	43.34	27.33	43.51	27.50	56.00	46.00	-12.49	-18.50
3	0.84531	0.18	41.71	33.30	41.89	33.48	56.00	46.00	-14.11	-12.52
4	1.24609	0.21	44.10	36.49	44.31	36.70	56.00	46.00	-11.69	-9.30
5	2.63281	0.29	45.32	38.18	45.61	38.47	56.00	46.00	-10.39	-7.53
6	6.41016	0.40	42.91	33.68	43.31	34.08	60.00	50.00	-16.69	-15.92

REMARKS:

1. Q.P. and AV. are abbreviations of quasi-peak and average individually.
2. The emission levels of other frequencies were very low against the limit.
3. Margin value = Emission level - Limit value
4. Correction factor = Insertion loss + Cable loss
5. Emission Level = Correction Factor + Reading Value.

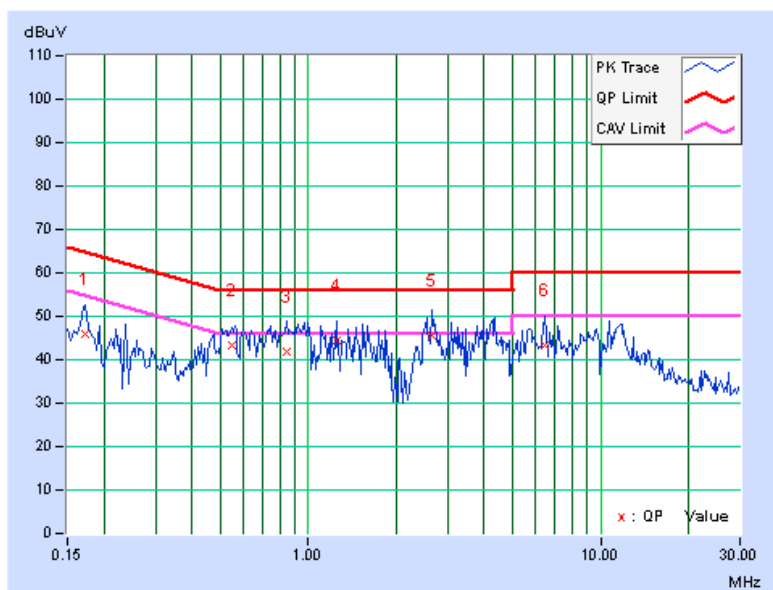

5.3 6dB BANDWIDTH MEASUREMENT

5.3.1 LIMITS OF 6dB BANDWIDTH MEASUREMENT

The minimum of 6dB Bandwidth Measurement is 0.5 MHz.

5.3.2 TEST SETUP

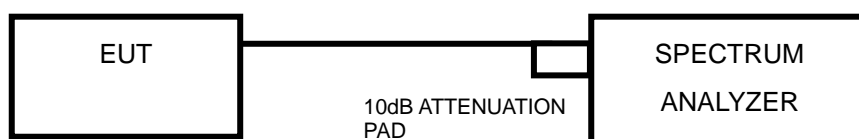

5.3.3 TEST INSTRUMENTS

Refer to section 4.1.2 to get information of above instrument.

5.3.4 TEST PROCEDURE

1. Set resolution bandwidth (RBW) = approximately 1% of the emission bandwidth
2. Set the video bandwidth (VBW) $\geq 3 \times$ RBW, Detector = Peak.
3. Trace mode = max hold.
4. Sweep = auto couple.
5. Measure the maximum width of the emission that is constrained by the frequencies associated with the two amplitude points (upper and lower) that are attenuated by 6 dB relative to the maximum level measured in the fundamental emission.

5.3.5 DEVIATION FROM TEST STANDARD

No deviation.

5.3.6 EUT OPERATING CONDITIONS

The software provided by client to enable the EUT under transmission condition continuously at lowest, middle and highest channel frequencies individually.

5.3.7 TEST RESULTS

CHANNEL	FREQUENCY (MHz)	6dB BANDWIDTH (MHz)	MINIMUM LIMIT (MHz)	PASS / FAIL
0	2402	0.662	0.5	PASS
19	2440	0.662	0.5	PASS
39	2480	0.666	0.5	PASS

5.4 CONDUCTED OUTPUT POWER

5.4.1 LIMITS OF CONDUCTED OUTPUT POWER MEASUREMENT

For systems using digital modulation in the 2400–2483.5 MHz: 1 Watt (30dBm)

5.4.2 TEST SETUP

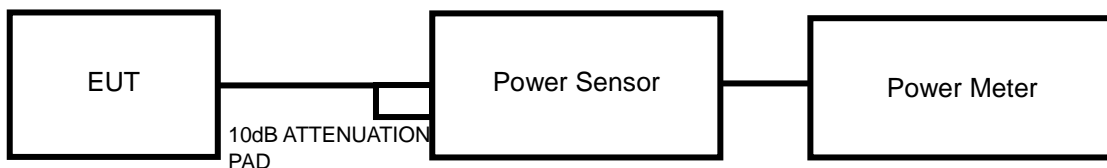

5.4.3 TEST INSTRUMENTS

Refer to section 4.1.2 to get information of above instrument.

5.4.4 TEST PROCEDURES

A peak power sensor was used on the output port of the EUT. A power meter was used to read the response of the peak power sensor. Record the peak power level.

5.4.5 DEVIATION FROM TEST STANDARD

No deviation.

5.4.6 EUT OPERATING CONDITIONS

Same as Item 4.3.6.

5.4.7 TEST RESULTS

CHANNEL	FREQUENCY (MHz)	PEAK POWER (W)	PEAK POWER (dBm)	LIMIT (dBm)	PASS/FAIL
0	2402	0.002	2.61	30	PASS
19	2440	0.002	3.17	30	PASS
39	2480	0.002	3.27	30	PASS

5.5 POWER SPECTRAL DENSITY MEASUREMENT

5.5.1 LIMITS OF POWER SPECTRAL DENSITY MEASUREMENT

The Maximum of Power Spectral Density Measurement is 8dBm.

5.5.2 TEST SETUP

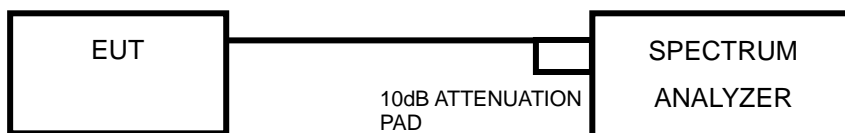

5.5.3 TEST INSTRUMENTS

Refer to section 4.1.2 to get information of above instrument.

5.5.4 TEST PROCEDURE

- a. Set the RBW = 100 kHz, VBW =300 kHz, Detector = peak.
- b. Sweep time = auto couple, Trace mode = max hold, allow trace to fully stabilize.
- c. Use the peak marker function to determine the maximum power level in any 100 kHz band segment within the fundamental EBW.
- d. Scale the observed power level to an equivalent value in 3 kHz by adjusting (reducing) the measured power by a bandwidth correction factor (BWCF) where $BWCF = 10\log(3 \text{ kHz}/100\text{kHz})$

5.5.5 DEVIATION FROM TEST STANDARD

No deviation.

5.5.6 EUT OPERATING CONDITION

Same as Item 4.3.6

5.5.7 TEST RESULTS

Channel	FREQ. (MHz)	PSD (dBm/100kHz)	PSD (dBm/3kHz)	Limit (dBm/3kHz)	PASS /FAIL
0	2402	-0.52	-15.72	8	PASS
19	2440	0.04	-15.16	8	PASS
39	2480	0.12	-15.08	8	PASS

5.6 CONDUCTED OUT OF BAND EMISSION MEASUREMENT

5.6.1 LIMITS OF OUT OF BAND EMISSION MEASUREMENT

Below -20dB of the highest emission level of operating band (in 100kHz Resolution Bandwidth).

5.6.2 TEST SETUP

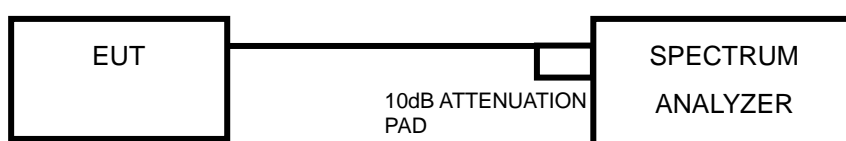

5.6.3 TEST INSTRUMENTS

Refer to section 4.1.2 to get information of above instrument.

5.6.4 TEST PROCEDURE

MEASUREMENT PROCEDURE REF

1. Set the RBW = 100 kHz.
2. Set the VBW \geq 300 kHz.
3. Detector = peak.
4. Sweep time = auto couple.
5. Trace mode = max hold.
6. Allow trace to fully stabilize.
7. Use the peak marker function to determine the maximum power level in any 100 kHz band segment within the fundamental EBW.

MEASUREMENT PROCEDURE OOB

1. Set RBW = 100 kHz.
2. Set VBW \geq 300 kHz.
3. Set span to encompass the spectrum to be examined
4. Detector = peak.
5. Trace Mode = max hold.
6. Sweep = auto couple.

5.6.5 DEVIATION FROM TEST STANDARD

No deviation.

5.6.6 EUT OPERATING CONDITION

Same as Item 4.3.6

5.6.7 TEST RESULTS

The spectrum plots are attached on the following pages. D1 line indicates the highest level, and D2 line indicates the 20dB offset below D1. It shows compliance with the requirement.

5.6.8 TEST RESULTS

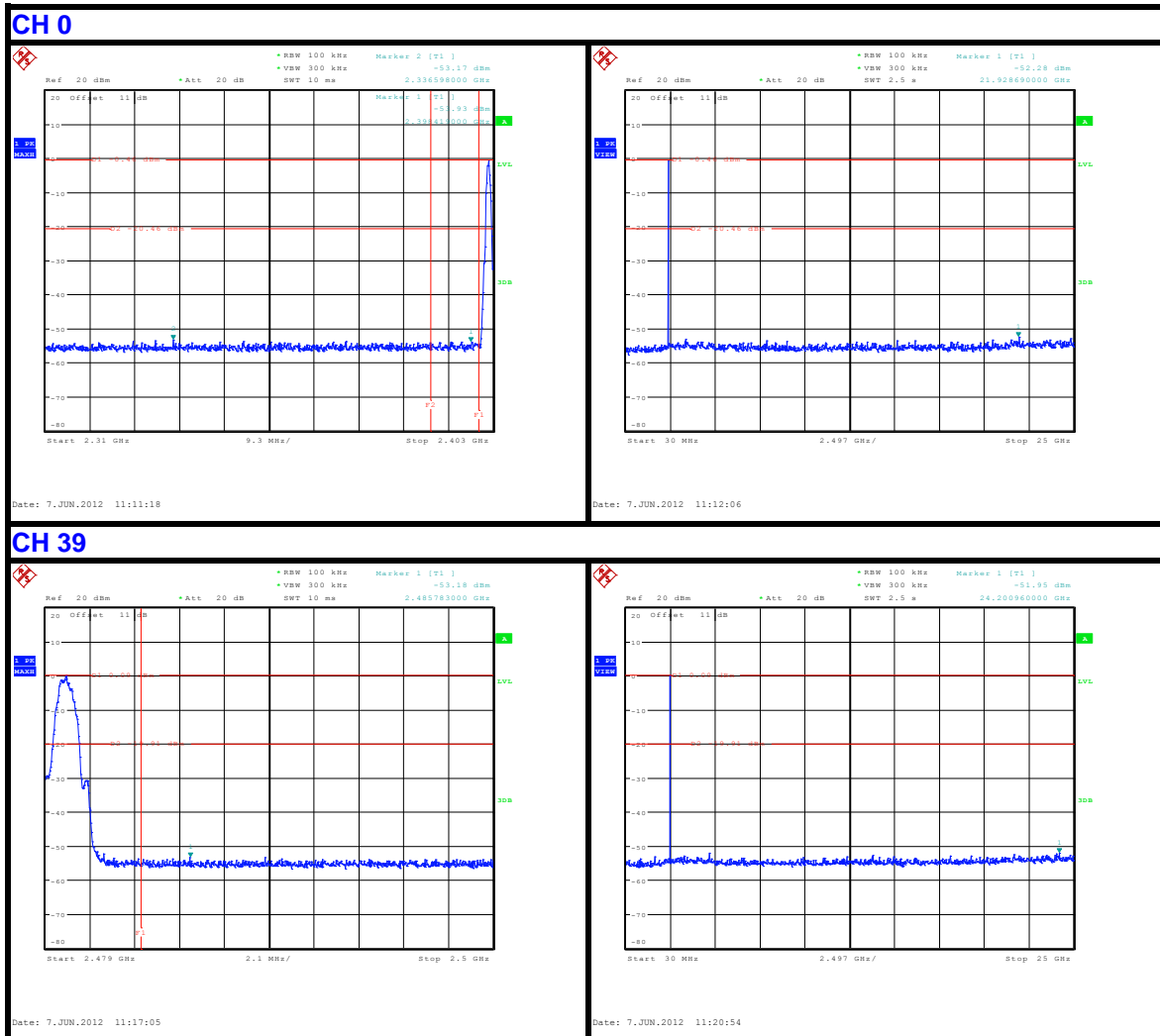

6. PHOTOGRAPHS OF THE TEST CONFIGURATION

Please refer to the attached file (Test Setup Photo).



7. INFORMATION ON THE TESTING LABORATORIES

We, Bureau Veritas Consumer Products Services (H.K.) Ltd., Taoyuan Branch, were founded in 1988 to provide our best service in EMC, Radio, Telecom and Safety consultation. Our laboratories are accredited and approved according to ISO/IEC 17025.

If you have any comments, please feel free to contact us at the following:

Linko EMC/RF Lab:

Tel: 886-2-26052180

Fax: 886-2-26051924

Hsin Chu EMC/RF Lab:

Tel: 886-3-5935343

Fax: 886-3-5935342

Hwa Ya EMC/RF/Safety Telecom Lab:

Tel: 886-3-3183232

Fax: 886-3-3185050

Email: service.adt@tw.bureauveritas.com

Web Site: www.adt.com.tw

The address and road map of all our labs can be found in our web site also.

8. APPENDIX A - MODIFICATIONS RECORDERS FOR ENGINEERING CHANGES TO THE EUT BY THE LAB

No modifications were made to the EUT by the lab during the test.

--- END ---