



HAC (RF Emission) TEST REPORT

Summary Result: M-Rating Category = M4

REPORT NO.: SA120522C28-1

MODEL NO.: PL01210

FCC ID: NM8PL01210

RECEIVED: May 22, 2012

TESTED: Jun. 28, 2012

ISSUED: Jul. 12, 2012

APPLICANT: HTC Corporation

ADDRESS: 23, Xinghua Rd., Taoyuan 330, Taiwan, R.O.C.

ISSUED BY: Bureau Veritas Consumer Products Services
(H.K.) Ltd., Taoyuan Branch

LAB ADDRESS: No. 47, 14th Ling, Chia Pau Tsuen, Lin Kou
Dist., New Taipei City 244, Taiwan, R.O.C.

TEST LOCATION: No. 19, Hwa Ya 2nd Rd, Wen Hwa Tsuen, Kwei
Shan Hsiang, Taoyuan Hsien 333, Taiwan,
R.O.C.

This test report consists of 26 pages in total except Appendix. It may be duplicated completely for legal use with the approval of the applicant. It should not be reproduced except in full, without the written approval of our laboratory. The client should not use it to claim product certification, approval, or endorsement by any government agency. The test results in the report only apply to the tested sample.

TABLE OF CONTENTS

RELEASE CONTROL RECORD	3
1. CERTIFICATION	4
2. GENERAL INFORMATION	5
2.1 GENERAL DESCRIPTION OF EUT	5
2.2 DESCRIPTION OF SUPPORT UNITS	6
2.3 GENERAL DESCRIPTION OF APPLIED STANDARDS	6
3. GENERAL INFORMATION OF THE DASY5 SYSTEM	7
3.1. GENERAL INFORMATION OF TEST EQUIPMENT	7
3.2. TEST EQUIPMENT LIST	10
3.3. MEASUREMENT UNCERTAINTY	11
3.4. GENERAL DESCRIPTION OF THE HAC EVALUATION	12
4. PERFORMANCE CATEGORIES	14
5. SYSTEM CHECK	16
5.1. VALIDATION STRUCTURE	16
5.2. SYSTEM CHECK PROCEDURE	17
5.3. VALIDATION RESULTS	18
6. MODULATION FACTOR	19
6.1 MODULATION FACTOR TEST RESULTS	20
7. RF EMISSION TEST PROCEDURES	21
7.1. TEST INSTRUCTION	21
7.2. TEST PROCEDURES	22
7.3. DESCRIPTION OF TEST POSITION AND CONFIGURATIONS	23
7.4. SUMMARY OF MEASURED HAC RESULTS	24
8. INFORMATION ON THE TESTING LABORATORIES	26
APPENDIX A: TEST CONFIGURATIONS AND TEST DATA	
APPENDIX B: SYSTEM CERTIFICATE & CALIBRATION	



RELEASE CONTROL RECORD

ISSUE NO.	REASON FOR CHANGE	DATE ISSUED
SA120522C28-1	Original Release	Jul. 12, 2012



1. CERTIFICATION

PRODUCT : Smartphone
MODEL NO. : PL01210
BRAND : HTC
APPLICANT : HTC Corporation
TESTED : Jun. 28, 2012
STANDARDS : FCC 47 CFR Part 20.19
ANSI C63.19-2007
TEST ITEM: RF Emissions

The above equipment have been tested by **Bureau Veritas Consumer Products Services (H.K.) Ltd., Taoyuan Branch**, and found compliance with the requirement of the above standards. The test record, data evaluation & Equipment Under Test (EUT) configurations represented herein are true and accurate accounts of the measurements of the sample's characteristics under the conditions specified in this report.

PREPARED BY : Ivonne Wu , **DATE**: Jul. 12, 2012
Ivonne Wu / Senior Specialist

APPROVED BY : Roy Wu , **DATE**: Jul. 12, 2012
Roy Wu / Manager

2. GENERAL INFORMATION

2.1 GENERAL DESCRIPTION OF EUT

EUT	Smartphone
MODEL NO.	PL01210
CLASSIFICATION	Production Unit
MODULATION TYPE	QPSK
TX FREQUENCY RANGE (MHz)	CDMA2000 BC0 : 824 ~ 849 CDMA2000 BC1 : 1850 ~ 1910
ANTENNA TYPE	Fixed Internal Antenna

Air Interfaces/Bands List						
Air Interface	Band	Type	C63.19 Tested	Simultaneous Transmissions	Reduced Power	VOIP
CDMA2000 1xRTT	BC0	Voice	Yes	WLAN/BT	N/A	N/A
	BC1	Voice	Yes	WLAN/BT	N/A	N/A
CDMA2000 1xEVDO	BC0	Data	N/A	WLAN/BT	N/A	Yes
	BC1	Data	N/A	WLAN/BT	N/A	Yes
WLAN	2.4G	Data	N/A	CDMA	N/A	Yes
BT	2.4G	Data	N/A	CDMA	N/A	N/A

Note: The HAC rating was evaluated for voice mode only.

NOTE:

1. The EUT's accessories list refers to Ext Pho.pdf.
2. Conducted power list as below:

Mode	RC	SO	Type	Data Rate	CDMA2000 BC0			CDMA2000 BC1		
					Low Ch (1013)	Mid Ch (384)	High Ch (777)	Low Ch (25)	Mid Ch (600)	High Ch (1175)
CDMA 1XRTT	1	2	Loop	Full	24.73	24.71	24.75	24.86	24.88	24.98
				Eighth	24.78	24.78	24.83	24.94	25.08	25.13
	1	3	Voice	-	24.77	24.75	24.82	24.85	24.87	25.09
	1	55	Loop	Full	24.73	24.76	24.79	24.89	24.88	24.94
				Eighth	24.78	24.84	24.87	24.99	25.03	25.32
	2	17	Voice	-	24.77	24.83	24.84	25.04	25.09	25.33
	2	32768	Voice	-	24.78	24.83	24.88	25.09	25.09	25.35
	3	2	Loop	Full	24.73	24.79	24.78	25.03	24.98	24.93
				Eighth	24.74	24.79	24.77	25.02	24.98	25.07
	3	3	Voice	-	24.76	24.79	24.79	25.04	24.90	25.06
	3	55	Loop	Full	24.71	24.77	24.80	24.86	24.87	24.97
				Eighth	24.57	24.79	24.79	25.03	24.98	24.91
	4	3	Voice	-	24.73	24.79	24.78	25.04	24.99	25.02
	5	17	Voice	-	24.76	24.79	24.78	25.02	24.98	24.88
5	32768	Voice	-	24.78	24.82	24.80	25.04	24.99	24.87	

3. The above EUT information is declared by manufacturer and for more detailed features description, please refer to the manufacturer's specifications or User's Manual.



2.2 DESCRIPTION OF SUPPORT UNITS

The EUT has been tested as an independent unit together with other necessary accessories or support units. The following support units or accessories were used to form a representative test configuration during the tests.

NO.	PRODUCT	BRAND	MODEL NO.	SERIAL NO.
1	Universal Radio Communication Tester	R&S	CMU200	104484

NO.	SIGNAL CABLE DESCRIPTION OF THE ABOVE SUPPORT UNITS
1	NA

NOTE: All power cords of the above support units are non shielded (1.8m).

2.3 GENERAL DESCRIPTION OF APPLIED STANDARDS

According to the specifications of the manufacturer, this product must comply with the requirements of the following standards:

FCC 47 CFR Part 20.19

ANSI C63.19 – 2007

All test items have been performed and recorded as per the above standards.



3. GENERAL INFORMATION OF THE DASY5 SYSTEM

3.1. GENERAL INFORMATION OF TEST EQUIPMENT

DASY5 consists of high precision robot, probe alignment sensor, phantom, robot controller, controlled measurement server and near-field probe. The robot includes six axes that can move to the precision position of the DASY5 software defined. The DASY5 software can define the area that is detected by the probe. The robot is connected to controlled box. Controlled measurement server is connected to the controlled robot box. The DAE includes amplifier, signal multiplexing, AD converter, offset measurement and surface detection. It is connected to the Electro-optical coupler (ECO). The ECO performs the conversion from the optical into digital electric signal of the DAE and transfers data to the PC.

ER3DV6 E-FIELD PROBE

CONSTRUCTION	One dipole parallel, two dipoles normal to probe axis Built-in shielding against static charges
CALIBRATION	In air from 100MHz to 3.0GHz (absolute accuracy $\pm 6.0\%$, $k = 2$)
FREQUENCY	100MHz to > 6 GHz; Linearity: ± 0.2 dB (100MHz to 3GHz)
DIRECTIVITY	± 0.2 dB in air (rotation around probe axis) ± 0.4 dB in air (rotation normal to probe axis)
DYNAMIC RANGE	2V/m to > 1000 V/m (M3 or better device readings fall well below diode compression point) Linearity: ± 0.2 dB
DIMENSIONS	Overall length: 330mm (Tip: 16mm) Tip diameter: 8mm (Body: 12mm) Distance from probe tip to dipole centers: 2.5mm

H3DV6 H-FIELD PROBE

CONSTRUCTION	Three concentric loop sensors with 3.8mm loop diameters Resistively loaded detector diodes for linear response Built-in shielding against static charges
FREQUENCY	200MHz to 3GHz (absolute accuracy $\pm 6.0\%$, $k = 2$); Output linearized
DIRECTIVITY	± 0.25 dB (spherical isotropy error)
DYNAMIC RANGE	10mA/m to 2A/m at 1GHz (M3 or better device readings fall well below diode compression point)
DIMENSIONS	Overall length: 330mm (Tip: 40mm) Tip diameter: 6mm (Body: 12mm) Distance from probe tip to dipole centers: 3mm
E-FIELD INTERFERENCE	$< 10\%$ at 3GHz (for plane wave)

NOTE: The Probe parameters have been calibrated by the SPEAG. Please reference "APPENDIX D" for the Calibration Certification Report.

HAC ARCH

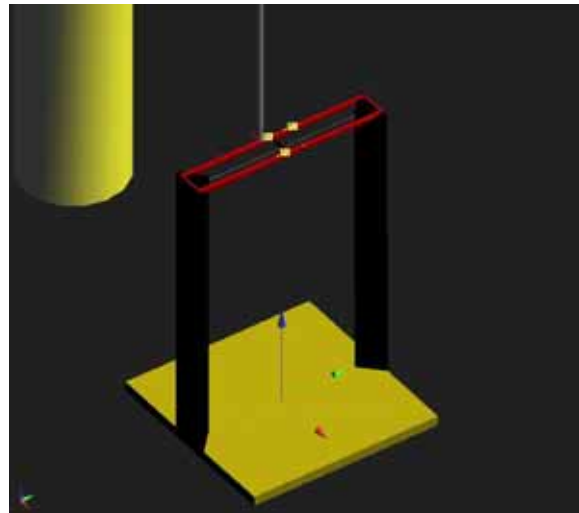

DIMENSIONS 370 x 370 x 370mm

SYSTEM VALIDATION KITS:

CD835V3 **Frequency Band:** 800 ~ 960MHz (free space)

Return Loss: > 15dB

Calibrated at: 835MHz

Power Capability: 50W continuous

Length & Height: 166 x 330mm

CD1880V3 **Frequency Band:** 1710 ~ 2000MHz (free space)

Return Loss: > 18dB

Calibrated at: 1880MHz

Power Capability: 50W continuous

Length & Height: 80.8 x 330mm



DEVICE HOLDER



CONSTRUCTION Supports accurate and reliable positioning of any phone effect on near field $\pm 0.5\text{dB}$

DATA ACQUISITION ELECTRONICS (DAE)



CONSTRUCTION The data acquisition electronics (DAE3) consists of a highly sensitive electrometer grade preamplifier with auto-zeroing, a channel and gain-switching multiplex, a fast 16 bit AD converter and a command decoder and control logic unit. Transmission to the measurement server is accomplished through an optical downlink for data and status information as well as an optical uplink for commands and the clock. The mechanical probe is mounting device includes two different sensor systems for frontal and sideways probe contacts. They are used for mechanical surface detection and probe collision detection. The input impedance of the DAE3 box is $200\text{M}\Omega$; the inputs are symmetrical and floating. Common mode rejection is above 80dB.



3.2. TEST EQUIPMENT LIST

NAME	BRAND	TYPE	SERIES NO.	DATE OF CALIBRATION	DUE DATE OF CALIBRATION
E-Field Probe	SPEAG	ER3DV6	2445	Feb. 17, 2012	Feb. 16, 2013
H-Field Probe	SPEAG	H3DV6	6274	Feb. 17, 2012	Feb. 16, 2013
DAE	SPEAG	DAE3	579	Apr. 27, 2012	Apr. 26, 2013
Validation Dipole	SPEAG	CD835V3	1041	Mar. 19, 2012	Mar. 18, 2013
Validation Dipole	SPEAG	CD1880V3	1032	Apr. 26, 2012	Apr. 25, 2013

NOTE: Before starting the measurement, all test equipment shall be warmed up for 30min.

3.3. MEASUREMENT UNCERTAINTY

HAC UNCERTAINTY BUDGET ACCORDING TO ANSI C63.19[1]							
ERROR DESCRIPTION	UNCERTAINTY VALUE	PROBABILITY DISTRIBUTION	DIVISOR	(Ci) E	(Ci) H	STD. UNC. E (%)	STD. UNC. H (%)
MEASUREMENT SYSTEM							
Probe calibration	5.1	Normal	1	1	1	5.1	5.1
Axial isotropy	0.5	Rectangular	$\sqrt{3}$	1	1	0.3	0.3
Sensor Displacement	16.5	Rectangular	$\sqrt{3}$	1	0.145	9.5	1.4
Boundary Effects	2.4	Rectangular	$\sqrt{3}$	1	1	1.4	1.4
Linearity	0.6	Rectangular	$\sqrt{3}$	1	1	0.3	0.3
Scaling to Peak Envelope Power	2.0	Rectangular	$\sqrt{3}$	1	1	1.2	1.2
System Detection Limit	1.0	Rectangular	$\sqrt{3}$	1	1	0.6	0.6
Readout Electronics	0.3	Rectangular	$\sqrt{3}$	1	1	0.2	0.2
Response Time	0.8	Rectangular	$\sqrt{3}$	1	1	0.5	0.5
Integration Time	2.6	Rectangular	$\sqrt{3}$	1	1	1.5	1.5
RF Ambient Condition	3.0	Rectangular	$\sqrt{3}$	1	1	1.7	1.7
RF Reflections	12.0	Rectangular	$\sqrt{3}$	1	1	6.9	6.9
Probe Positioner	1.2	Rectangular	$\sqrt{3}$	1	0.67	0.7	0.5
Probe Positioning	4.7	Rectangular	$\sqrt{3}$	1	0.67	2.7	1.8
Extrap. And Interpolation	1.0	Rectangular	$\sqrt{3}$	1	1	0.6	0.6
TEST SAMPLE RELATED							
Device Positioning Vertical	2.6	Normal	1	1	1	2.6	2.6
Device Positioning Lateral	2.6	Normal	1	1	1	2.6	2.6
Device Holder and Phantom	2.4	Rectangular	$\sqrt{3}$	1	1	1.4	1.4
Power Drift	5.0	Rectangular	$\sqrt{3}$	1	1	2.9	2.9
PHANTOM AND SETUP RELATED							
Phantom Thickness	2.4	Rectangular	$\sqrt{3}$	1	0.67	1.4	0.9
COMBINED STD. UNCERTAINTY						14.4	10.7
EXPANDED STD. UNCERTAINTY ON POWER						28.8	21.3
EXPANDED STD. UNCERTAINTY ON FIELD						14.4	10.7

NOTE: Worst-case uncertainty budget for HAC free field assessment according to ANSI C63.19 [1]. The budget is valid for the frequency range 800MHz ~ 3GHz and represents a worst-case analysis. For specific tests and configurations, the uncertainty could be considerably smaller.

3.4. GENERAL DESCRIPTION OF THE HAC EVALUATION

The DASY5 post-processing software (SEMCAD) automatically executes the following procedures to calculate the field units from the micro-volt readings at the probe connector. The parameters used in the evaluation are stored in the configuration modules of the software:

Probe parameters: - Sensitivity	Norm _i , a _{i0} , a _{i1} , a _{i2}
- Conversion factor	ConvF _i
- Diode compression point	dcp _i
Device parameters: - Frequency	F
- Crest factor	Cf

The first step of the evaluation is a linearization of the filtered input signal to account for the compression characteristics of the detector diode. The compensation depends on the input signal, the diode type and the DC-transmission factor from the diode to the evaluation electronics. If the exciting field is pulsed, the crest factor of the signal must be known to correctly compensate for peak power. The formula for each channel can be given as:

$$V_i = U_i + U_i^2 \cdot \frac{cf}{dcp_i}$$

V _i = compensated signal of channel i	(i = x, y, z)
U _i = input signal of channel i	(i = x, y, z)
Cf = crest factor of exciting field	(DASY parameter)
dcp _i = diode compression point	(DASY parameter)

From the compensated input signals the primary field data for each channel can be evaluated:

$$\mathbf{E\text{-field probes: } } E_i = \sqrt{\frac{V_i}{\text{Norm}_i \cdot \text{Conv}F}}$$

$$\mathbf{H\text{-field probes: } } H_i = \sqrt{V_i} \cdot \frac{a_{i0} + a_{i1}f + a_{i2}f^2}{f}$$

V_i = compensated signal of channel i ($i = x, y, z$)

Norm_i = sensor sensitivity of channel i $\mu\text{V}/(\text{V/m})^2$ for E-field Probes ($i = x, y, z$)

$\text{Conv}F$ = sensitivity enhancement in solution

a_{ij} = sensor sensitivity factors for H-field probes

F = carrier frequency [GHz]

E_i = electric field strength of channel i in V/m

H_i = magnetic field strength of channel i in A/m

The RSS value of the field components gives the total field strength (Hermitian magnitude):

$$E_{tot} = \sqrt{E_x^2 + E_y^2 + E_z^2}$$

The primary field data are used to calculate the derived field units.

E = field strength in V/m

E_{tot} = total field strength in V/m

NOTE: The signal response time is evaluated as the time required by the system to reach 90% of the expected final value after an on/off switch of the power source with an integration time of 500ms and a probe response time of < 5ms. In the current implementation, DASY5 waits longer than 100ms after having reached the grid point before starting a measurement, i.e., the response time uncertainty is negligible.

4. PERFORMANCE CATEGORIES

The ANSI Standard presents performance requirements for acceptable interoperability of hearing aids with wireless communications devices. When these parameters are met, a hearing aid operates acceptably in close proximity to a wireless communications device.

CATEGORY NEAR FIELD	TELEPHONE RF PARAMETERS < 960MHz				
	AWF	E-FIELD EMISSION CW (dBV/m)	E-FIELD EMISSION CW (V/m)	H-FIELD EMISSION CW (dBA/m)	H-FIELD EMISSION CW (A/m)
M1	0	56.0 to 61.0	631.0 to 1122.0	5.6 to 10.6	1.91 to 3.39
	-5	53.5 to 58.5	473.2 to 841.4	3.1 to 8.1	1.43 to 2.54
M2	0	51.0 to 56.0	354.8 to 631.0	0.6 to 5.6	1.07 to 1.91
	-5	48.5 to 53.5	266.1 to 473.2	-1.9 to 3.1	0.80 to 1.43
M3	0	46.0 to 51.0	199.5 to 354.8	-4.4 to 0.6	0.60 to 1.07
	-5	43.5 to 48.5	149.6 to 266.1	-6.9 to -1.9	0.45 to 0.80
M4	0	< 46.0	< 199.5	< -4.4	< 0.60
	-5	< 43.5	< 149.6	< -6.9	< 0.45

CATEGORY NEAR FIELD	TELEPHONE RF PARAMETERS > 960MHz				
	AWF	E-FIELD EMISSION CW (dBV/m)	E-FIELD EMISSION CW (V/m)	H-FIELD EMISSION CW (dBA/m)	H-FIELD EMISSION CW (A/m)
M1	0	46.0 to 51.0	199.5 to 354.8	-4.4 to 0.6	0.60 to 1.07
	-5	43.5 to 48.5	149.6 to 266.1	-6.9 to -1.9	0.45 to 0.80
M2	0	41.0 to 46.0	112.2 to 199.5	-9.4 to -4.4	0.34 to 0.60
	-5	48.5 to 53.5	84.1 to 149.6	-11.9 to -6.9	0.25 to 0.45
M3	0	36.0 to 41.0	63.1 to 112.2	-14.4 to -9.4	0.19 to 0.34
	-5	33.5 to 38.5	47.3 to 84.1	-16.9 to -11.9	0.14 to 0.25
M4	0	< 36.0	< 63.1	< -14.4	< 0.19
	-5	< 33.5	< 47.3	< -16.9	< 0.14



ARTICULATION WEIGHING FACTOR (AWF)

The following AWF factors shall be used for the standard transmission protocols:

STANDARD	TECHNOLOGY	AWF (dB)
TIA/EIA/IS-2000	CDMA	0
TIA/EIA-136	TDMA (50Hz)	0
iDENTM	TDMA (22 and 11Hz)	0
J-STD-007	GSM (217)	-5
T1/T1P1/3GPP	UMTS (WCDMA)	0

5. SYSTEM CHECK

The measured values (E-field and H-field) were compared with the values provided by the probe manufacturer and must within the allowed tolerance of **25%**.

5.1. VALIDATION STRUCTURE

The input signal was an un-modulated continuous wave. The following points were taken into consideration in performing this check:

- Average Input Power $P = 100\text{mW RMS}$ (20dBm RMS) after adjustment for return loss
- The test fixture must meet the 2 wavelength separation criterion
- The proper measurement of the 1cm probe to dipole separation, which is measured from top surface of the dipole to the calibration reference point of the sensor, defined by the probe manufacturer is shown in the following diagram:

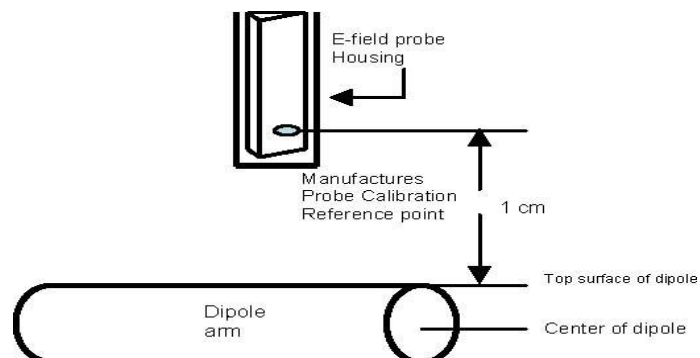

5.2. SYSTEM CHECK PROCEDURE

1. Before you start the system performance check, need only to tell the system with which components (probe type, validation dipole and HAC arch) are performing the system performance check; the system will take care of all parameters.

The system check configuration is shown in the following figure:

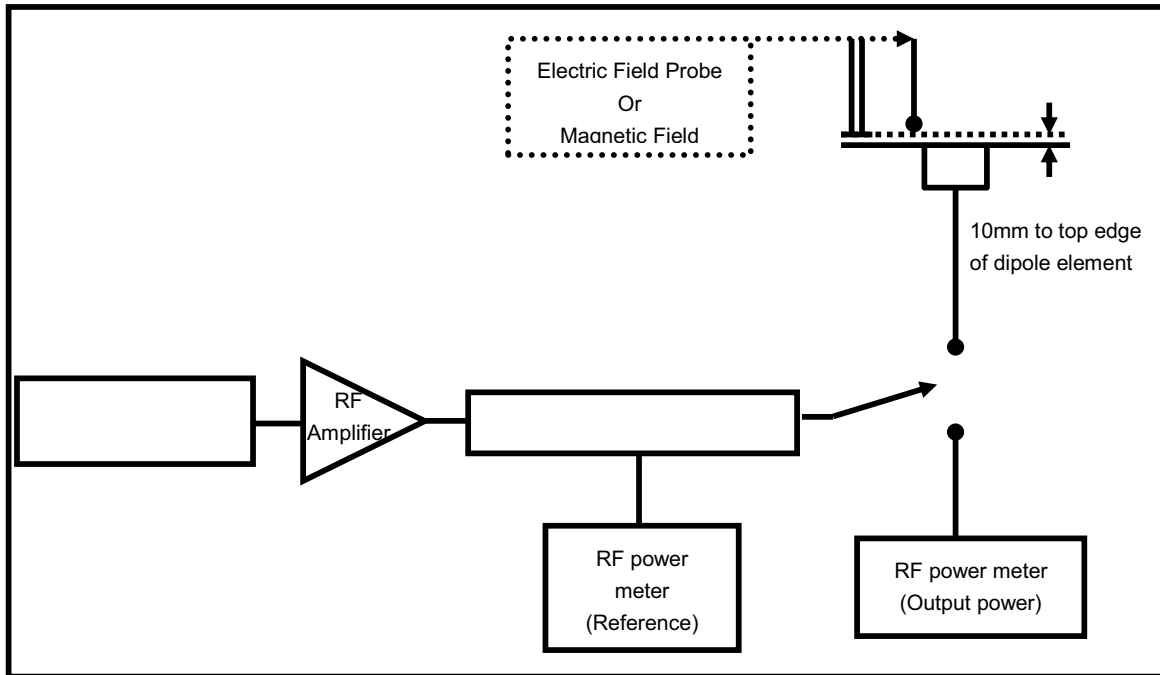

2. The dipole was energized with a 20dBm un-modulated continuous-wave signal.
3. The length of the dipole was scanned with both E-field and H-field probes and the maximum values for each were recorded.

5.3. VALIDATION RESULTS

Frequency (MHz)	Input Power (dBm)	Target Value (V/m)	E-Field 1 (V/m)	E-Field 2 (V/m)	Average Value (V/m)	Deviation (%)	Date
835	20	168.0	164.6	163.5	164.05	-2.35	Jun. 28, 2012
1880	20	140.1	142.1	134.4	138.25	-1.32	Jun. 28, 2012
Frequency (MHz)	Input Power (dBm)	Target Value (A/m)	H-Field (A/m)			Deviation (%)	Date
835	20	0.471	0.43			-8.70	Jun. 28, 2012
1880	20	0.461	0.447			-3.04	Jun. 28, 2012

NOTE: Please see Appendix for the system validation test data.

6. MODULATION FACTOR

A calibration was made of the modulation response of the probe and its instrumentation chain. This calibration was performed with the field probe, attached to its instrumentation. The response of the probe system to a CW field at the frequency of interest is compared to its response to a modulated signal with equal peak amplitude to that of a CW signal. The field level of the test signals are ensured to be more than 10dB above the ambient level and the noise floor of the instrumentation being used. The ratio of the CW reading to that taken with a modulated reading was applied to the DUT measurements.

This was done using the following procedure:

1. Fixing the probe in a set location relative to a field generating device, such as a reference dipole antenna, as illustrated in the system check procedure.
2. Illuminate the probe using the wireless device connected to the reference dipole with a test signal at the intended measurement frequency, Ensure there is sufficient field coupling between the probe and the antenna so the resulting reading is greater than 10dB above the probe system noise floor but within the systems operating range.
3. Record the amplitude applied to the antenna during transmission and the field strength measured by the E-field probe located near the tip of the dipole antenna.
4. Replace the wireless device with an RF signal generator producing an unmodulated CW signal and set to the wireless device operating frequency.
5. Set the amplitude of the unmodulated signal to equal that recorded from the wireless device.
6. Record the reading of the probe measurement system of the unmodulated signal.
7. The RF signal generator producing an 80%AM signal and set to the wireless device operating frequency. Set the amplitude of the signal to equal that recorded from the wireless device.
8. Record the reading of the probe measurement system of the 80%AM signal.
9. The ratio, in linear units, of the probe reading in Step 3) or 8) to the reading in Step 6) is the E-field modulation factor.
10. Steps 1-9 were repeated at all frequency bands and for both E and H field probes.

NOTE: The ratio of the CW to modulated signal reading is the modulation factor. The modulation factors obtained were applied to readings taken of the actual wireless device, in order to obtain an accurate peak field reading using the formula:

$$\text{Peak} = 20 \cdot \log(\text{Raw} \cdot \text{ProbeModulationFactor})$$

6.1 MODULATION FACTOR TEST RESULTS

TEST FREQUENCY (MHz)	PROTOCOL	MODULATION FACTOR
835	CDMA	1.02
1880	CDMA	1.02

7. RF EMISSION TEST PROCEDURES

7.1. TEST INSTRUCTION

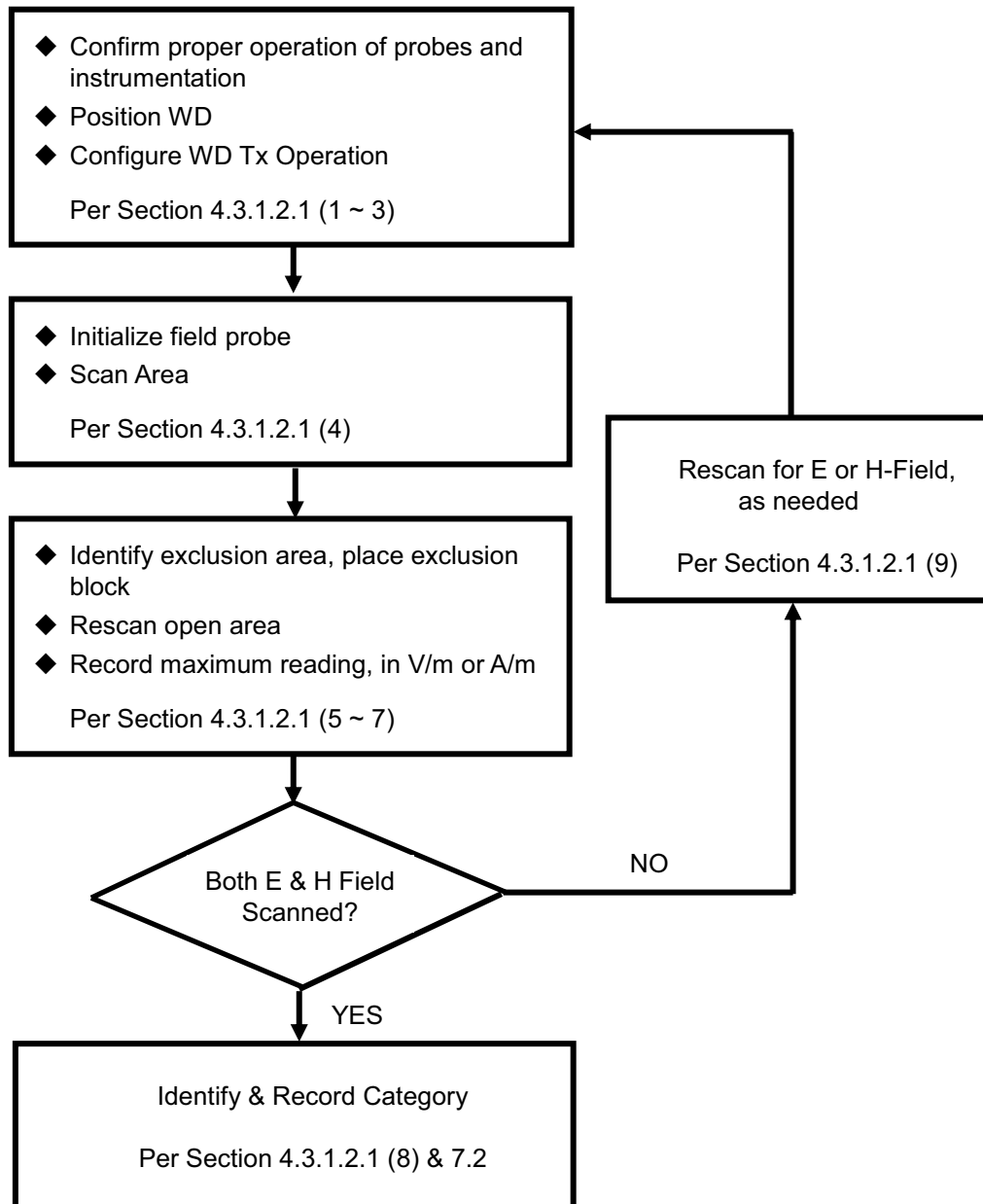

7.2. TEST PROCEDURES

The EUT makes a phone call to the GSM base station. Establish the simulation communication configuration rather the actual communication. Then the EUT could continuous the transmission mode. Adjust the PCL of the base station could controlled the EUT to transmitted the maximum output power. The base station also could control the transmission channel.

The recommended procedure for assessing the RF emission value consists of the following steps:

1. Proper operation of the field probe, probe measurement system, other instrumentation, and the positioning system was confirmed.
2. WD is positioned in its intended test position, acoustic output point of the device perpendicular to the field probe.
3. The center sub-grid was centered over the center of the acoustic output (also audio band magnetic output, if applicable). The WD audio output was positioned tangent (as physically possible) to the measurement plane.
4. A surface calibration was performed before each setup change to ensure repeatable spacing and proper maintenance of the measurement plane using the HAC arch.
5. The measurement system measured the field strength at the reference location.
6. Measurements at 2mm increments in the 5 x 5cm region were performed and recorded. A 360° rotation about the azimuth axis at the maximum interpolated position was measured. For the worst-case condition, the peak reading from this rotation was used in re-evaluating the HAC category.
7. Steps 1-6 were done for both the E and H-Field measurements.

7.3. DESCRIPTION OF TEST POSITION AND CONFIGURATIONS

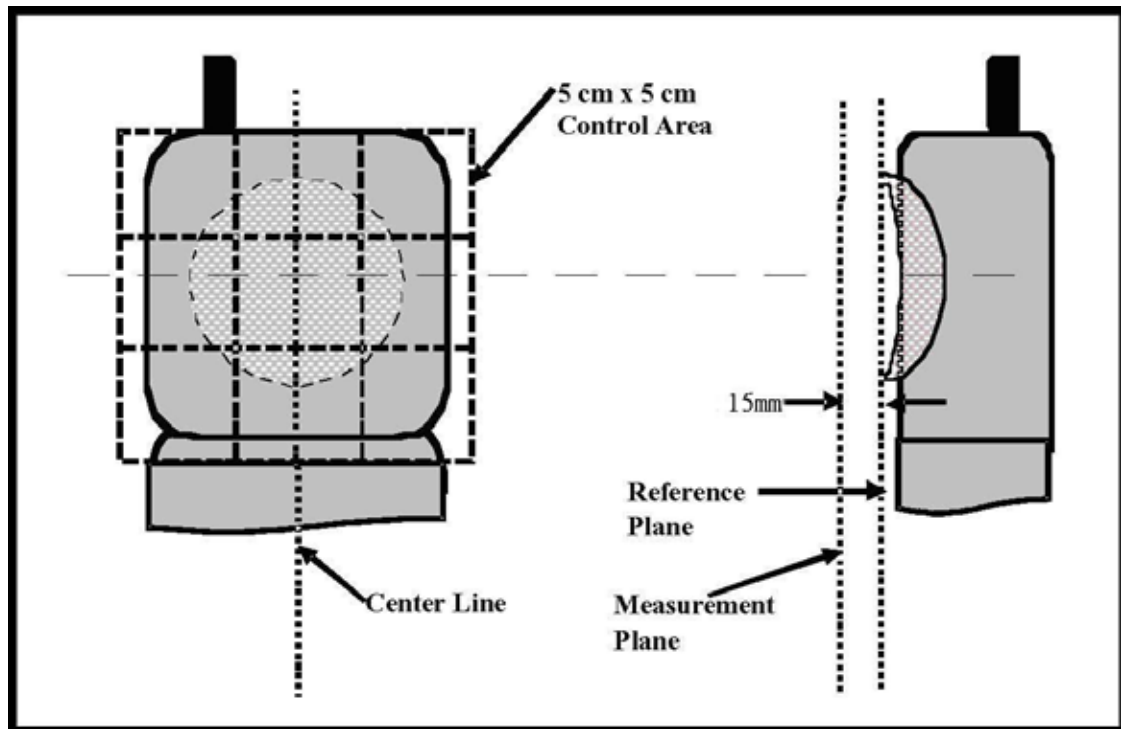

7.4. SUMMARY OF MEASURED HAC RESULTS

Band	Mode	Channel	Battery	Peak E-Field (V/m)
CDMA2000 BC0	RC1+SO2_Full	384	1	43.7
CDMA2000 BC0	RC1+SO2_Eighth	384	1	42.8
CDMA2000 BC0	RC1+SO3_Voice	384	1	45.5
CDMA2000 BC0	RC1+SO55_Full	384	1	41.3
CDMA2000 BC0	RC1+SO55_Eighth	384	1	37.8
CDMA2000 BC0	RC2+SO17_Voice	384	1	40.0
CDMA2000 BC0	RC2+SO32768_Voice	384	1	45.3
CDMA2000 BC0	RC3+SO2_Full	384	1	42.2
CDMA2000 BC0	RC3+SO2_Eighth	384	1	41.7
CDMA2000 BC0	RC3+SO3_Voice	384	1	46.0
CDMA2000 BC0	RC3+SO55_Full	384	1	45.8
CDMA2000 BC0	RC3+SO55_Eighth	384	1	45.4
CDMA2000 BC0	RC4+SO3_Voice	384	1	42.0
CDMA2000 BC0	RC5+SO17_Voice	384	1	42.0

Note:

Per above pretest, the worst mode is RC3+SO3 which will be performed complete E and H field testing as follow.



E-FIELD EMISSION

Plot No.	Band	Mode	Channel	Battery	Peak E-Field (V/m)	E-Field M Rating
10	CDMA2000 BC0	RC3+SO3_Voice	384	1	46.0	M4
16	CDMA2000 BC0	RC3+SO3_Voice	1013	1	48.4	M4
17	CDMA2000 BC0	RC3+SO3_Voice	777	1	43.8	M4
18	CDMA2000 BC0	RC3+SO3_Voice	1013	2	48.1	M4
19	CDMA2000 BC1	RC3+SO3_Voice	600	1	31.1	M4
20	CDMA2000 BC1	RC3+SO3_Voice	25	1	29.3	M4
21	CDMA2000 BC1	RC3+SO3_Voice	1175	1	27.8	M4
22	CDMA2000 BC1	RC3+SO3_Voice	600	2	31.0	M4

NOTE: Please see the Appendix A for the measured data and test plots.

H-FIELD EMISSION

Plot No.	Band	Mode	Channel	Battery	Peak H-Field (A/m)	H-Field M Rating
23	CDMA2000 BC0	RC3+SO3_Voice	384	1	0.088	M4
24	CDMA2000 BC0	RC3+SO3_Voice	1013	1	0.113	M4
25	CDMA2000 BC0	RC3+SO3_Voice	777	1	0.077	M4
26	CDMA2000 BC0	RC3+SO3_Voice	1013	2	0.112	M4
27	CDMA2000 BC1	RC3+SO3_Voice	600	1	0.092	M4
28	CDMA2000 BC1	RC3+SO3_Voice	25	1	0.1	M4
29	CDMA2000 BC1	RC3+SO3_Voice	1175	1	0.089	M4
30	CDMA2000 BC1	RC3+SO3_Voice	25	2	0.091	M4

NOTE: Please see the Appendix A for the measured data and test plots.



8. INFORMATION ON THE TESTING LABORATORIES

We, Bureau Veritas Consumer Products Services (H.K.) Ltd., Taoyuan Branch, were founded in 1988 to provide our best service in EMC, Radio, Telecom and Safety consultation. Our laboratories are accredited and approved according to ISO/IEC 17025.

If you have any comments, please feel free to contact us at the following:

Linko EMC/RF Lab:

Tel: 886-2-26052180

Fax: 886-2-26051924

Hsin Chu EMC/RF Lab:

Tel: 886-3-5935343

Fax: 886-3-5935342

Hwa Ya EMC/RF/Safety/Telecom Lab:

Tel: 886-3-3183232

Fax: 886-3-327-0892

Email: service.adt@tw.bureauveritas.com

Web Site: www.adt.com.tw

The address and road map of all our labs can be found in our web site also.

---END---

System Check_E-Field_835_120628

DUT: HAC Dipole 835 MHz; Type: CD835V3; SN: 1041

Communication System: CW; Frequency: 835 MHz; Duty Cycle: 1:1

Medium: Air Medium parameters used: $\sigma = 0$ mho/m, $\epsilon_r = 1$; $\rho = 1000$ kg/m³

Ambient Temperature : 21.8 °C;

DASY5 Configuration:

- Probe: ER3DV6 - SN2445; ConvF(1, 1, 1); Calibrated: 2012/02/17
- Sensor-Surface: (Fix Surface)
- Electronics: DAE3 Sn579; Calibrated: 2012/04/27
- Phantom: HAC Test Arch with AMCC; Type: SD HAC P01 BA;
- Measurement SW: DASY52, V52.8 Build 1; SEMCAD X Version 14.0 Build 61

Hearing Aid Compatibility Test (41x361x1): Measurement grid: dx=5mm, dy=5mm

Maximum value of peak Total field = 164.6 V/m

Probe Modulation Factor = 1

Device Reference Point: 0, 0, -6.3 mm

Reference Value = 119.9 V/m; Power Drift = -0.016 dB

Hearing Aid Near-Field Category: M4 (AWF 0 dB)

Peak E-field in V/m

Grid 1 157.8 M4	Grid 2 164.6 M4	Grid 3 157.7 M4
Grid 4 84.3 M4	Grid 5 85.9 M4	Grid 6 82.7 M4
Grid 7 160.4 M4	Grid 8 163.5 M4	Grid 9 153.5 M4

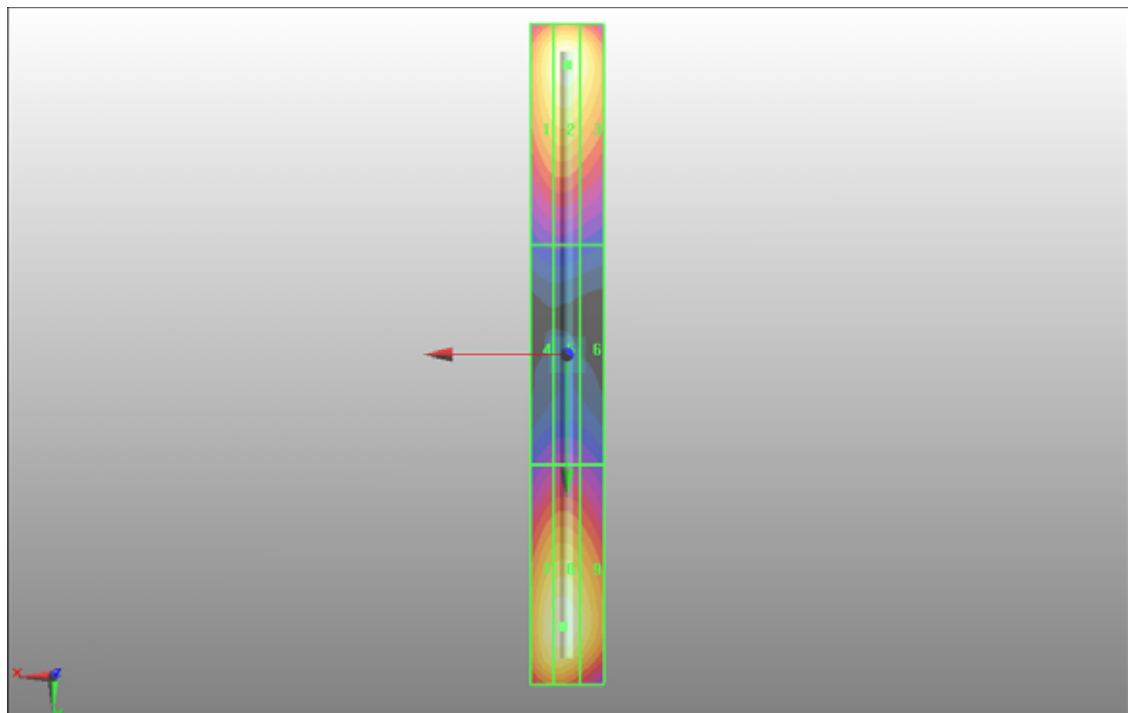
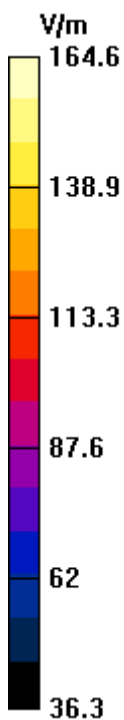

System Check_E-Field_1880_120628

DUT: HAC Dipole 1880 MHz; Type: CD1880V3; SN: 1032

Communication System: CW; Frequency: 1880 MHz; Duty Cycle: 1:1

Medium: Air Medium parameters used: $\sigma = 0$ mho/m, $\epsilon_r = 1$; $\rho = 1000$ kg/m³

Ambient Temperature : 21.8 °C;

DASY5 Configuration:

- Probe: ER3DV6 - SN2445; ConvF(1, 1, 1); Calibrated: 2012/02/17

- Sensor-Surface: (Fix Surface)

- Electronics: DAE3 Sn579; Calibrated: 2012/04/27

- Phantom: HAC Test Arch with AMCC; Type: SD HAC P01 BA;

- Measurement SW: DASY52, V52.8 Build 1; SEMCAD X Version 14.0 Build 61

Hearing Aid Compatibility Test (41x181x1): Measurement grid: dx=5mm, dy=5mm

Maximum value of peak Total field = 142.1 V/m

Probe Modulation Factor = 1

Device Reference Point: 0, 0, -6.3 mm

Reference Value = 141.0 V/m; Power Drift = -0.025 dB

Hearing Aid Near-Field Category: M2 (AWF 0 dB)

Peak E-field in V/m

Grid 1 138.4 M2	Grid 2 142.1 M2	Grid 3 131.3 M2
Grid 4 84 M3	Grid 5 87.8 M3	Grid 6 85.9 M3
Grid 7 131.4 M2	Grid 8 134.4 M2	Grid 9 128.3 M2

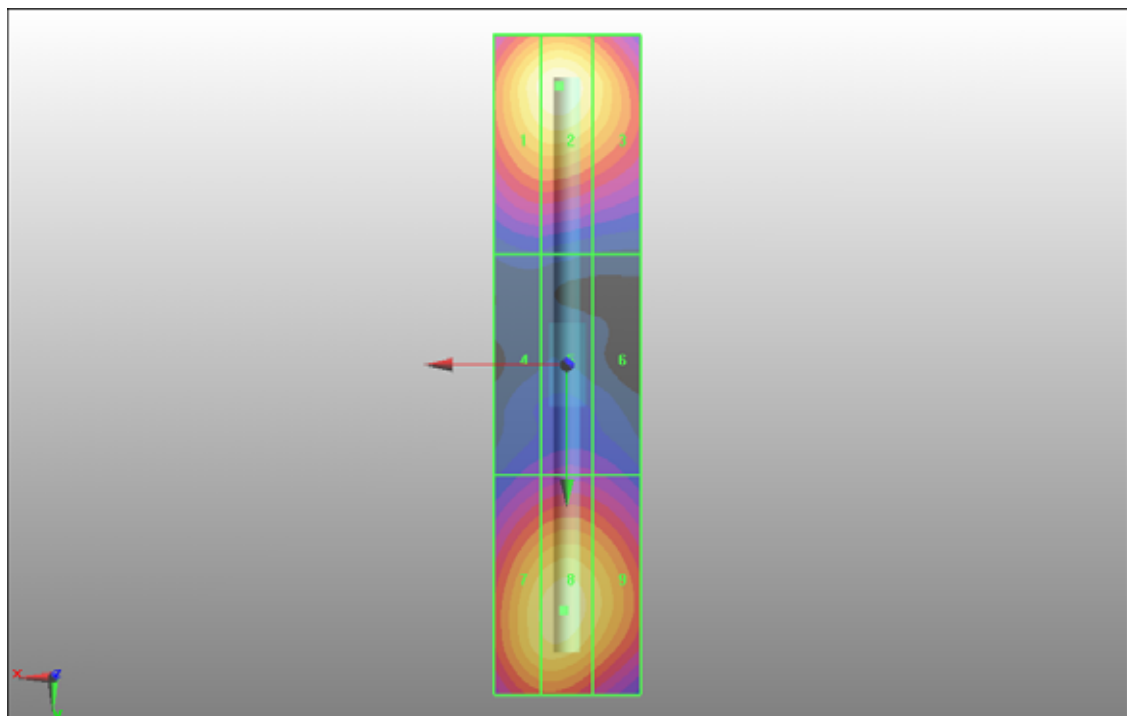
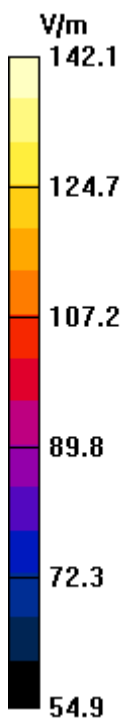

System Check_H-Field_835_120628

DUT: HAC Dipole 835 MHz; Type: CD835V3; SN: 1041

Communication System: CW; Frequency: 835 MHz; Duty Cycle: 1:1

Medium: Air Medium parameters used: $\sigma = 0$ mho/m, $\epsilon_r = 1$; $\rho = 1$ kg/m³

Ambient Temperature : 21.8 °C;

DASY5 Configuration:

- Probe: H3DV6 - SN6274; ; Calibrated: 2012/02/17
- Sensor-Surface: (Fix Surface)
- Electronics: DAE3 Sn579; Calibrated: 2012/04/27
- Phantom: HAC Test Arch with AMCC; Type: SD HAC P01 BA;
- Measurement SW: DASY52, V52.8 Build 1; SEMCAD X Version 14.0 Build 61

Hearing Aid Compatibility Test (41x361x1): Measurement grid: dx=5mm, dy=5mm

Maximum value of peak Total field = 0.430 A/m

Probe Modulation Factor = 1

Device Reference Point: 0, 0, -6.3 mm

Reference Value = 0.456 A/m; Power Drift = 0.012 dB

Hearing Aid Near-Field Category: M4 (AWF 0 dB)

Peak H-field in A/m

Grid 1 0.366 M4	Grid 2 0.377 M4	Grid 3 0.359 M4
Grid 4 0.414 M4	Grid 5 0.430 M4	Grid 6 0.406 M4
Grid 7 0.368 M4	Grid 8 0.381 M4	Grid 9 0.359 M4

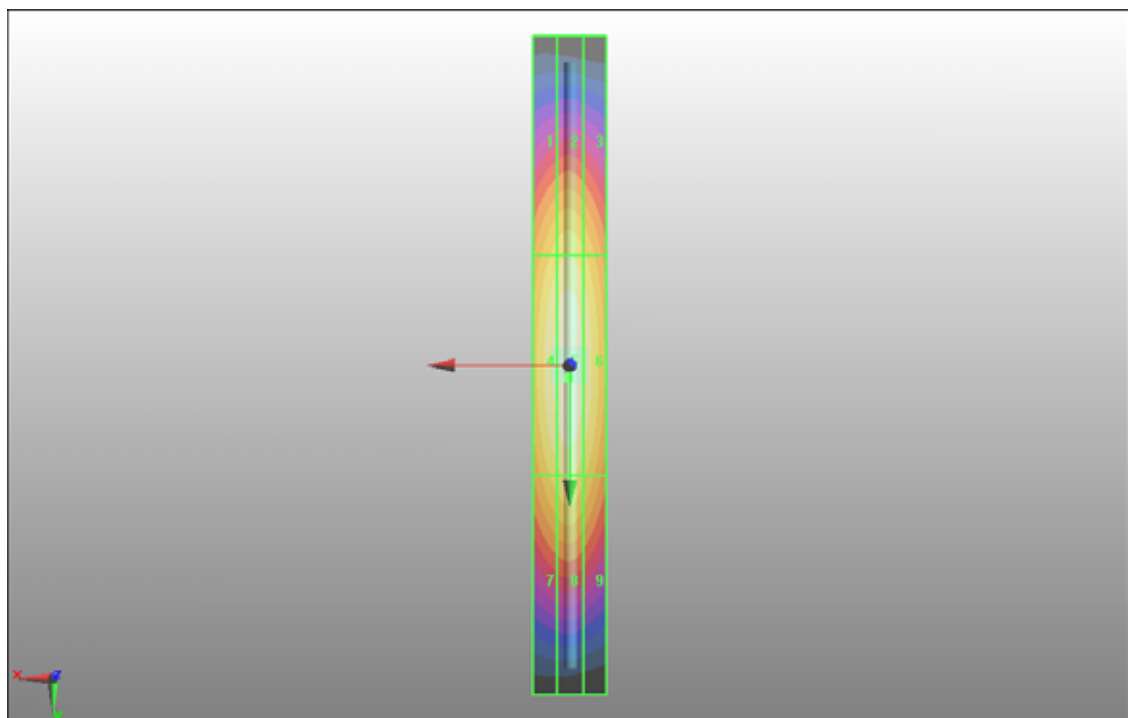
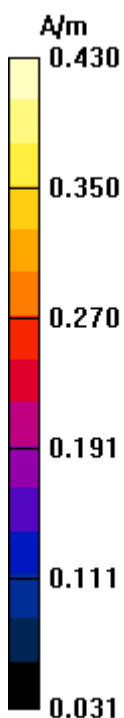

System Check_H-Field_1880_120628

DUT: HAC Dipole 1880 MHz; Type: CD1880V3; SN: 1032

Communication System: CW; Frequency: 1880 MHz; Duty Cycle: 1:1

Medium: Air Medium parameters used: $\sigma = 0$ mho/m, $\epsilon_r = 1$; $\rho = 1$ kg/m³

Ambient Temperature : 21.8 °C;

DASY5 Configuration:

- Probe: H3DV6 - SN6274; ; Calibrated: 2012/02/17
- Sensor-Surface: (Fix Surface)
- Electronics: DAE3 Sn579; Calibrated: 2012/04/27
- Phantom: HAC Test Arch with AMCC; Type: SD HAC P01 BA;
- Measurement SW: DASY52, V52.8 Build 1; SEMCAD X Version 14.0 Build 61

Hearing Aid Compatibility Test (41x181x1): Measurement grid: dx=5mm, dy=5mm

Maximum value of peak Total field = 0.447 A/m

Probe Modulation Factor = 1

Device Reference Point: 0, 0, -6.3 mm

Reference Value = 0.472 A/m; Power Drift = 0.00713 dB

Hearing Aid Near-Field Category: M2 (AWF 0 dB)

Peak H-field in A/m

Grid 1 0.395 M2	Grid 2 0.404 M2	Grid 3 0.385 M2
Grid 4 0.436 M2	Grid 5 0.447 M2	Grid 6 0.426 M2
Grid 7 0.401 M2	Grid 8 0.412 M2	Grid 9 0.390 M2

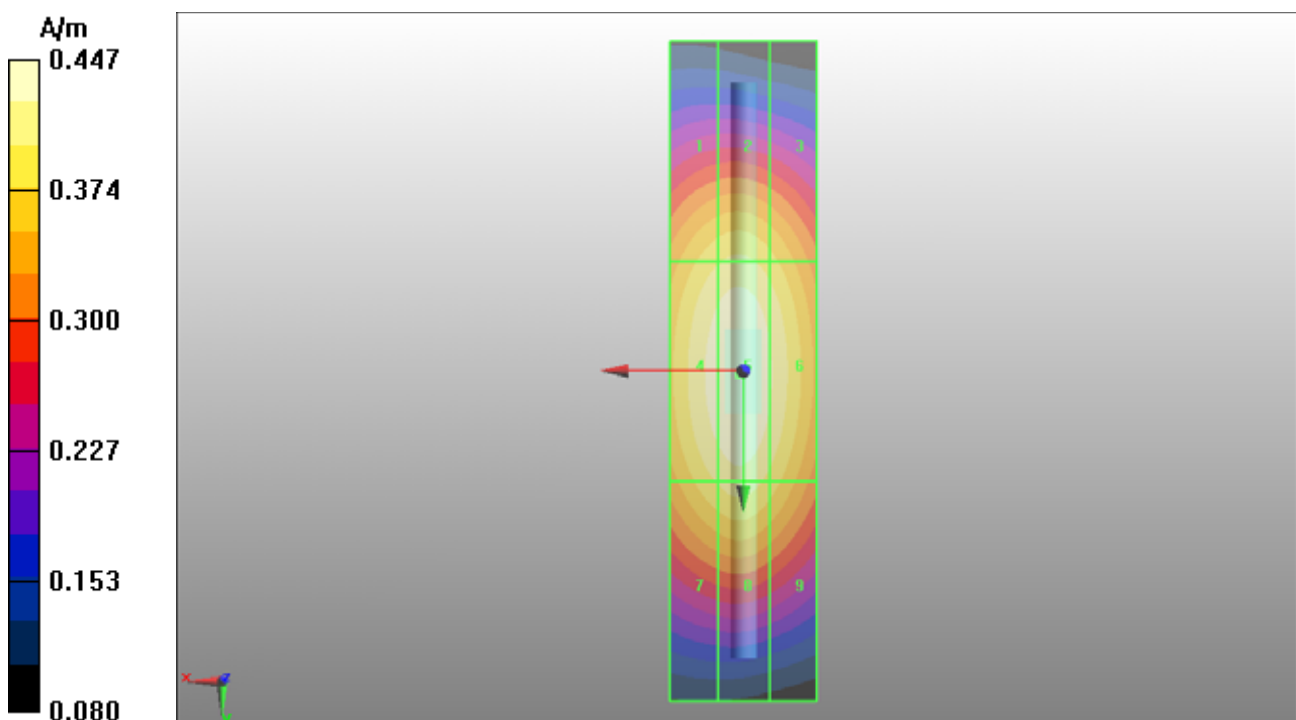

P10 E_Field CDMA2000 BC0_RC3+SO3_Voice_Ch384_Battery1

DUT: 120522C28

Communication System: CDMA2000 BC0; Frequency: 836.52 MHz; Duty Cycle: 1:1

Medium: Air Medium parameters used: $\sigma = 0$ mho/m, $\epsilon_r = 1$; $\rho = 1000$ kg/m³

Ambient Temperature : 21.8 °C;

DASY5 Configuration:

- Probe: ER3DV6 - SN2445; ConvF(1, 1, 1); Calibrated: 2012/02/17
- Sensor-Surface: (Fix Surface)
- Electronics: DAE3 Sn579; Calibrated: 2012/04/27
- Phantom: HAC Test Arch with AMCC; Type: SD HAC P01 BA;
- Measurement SW: DASY52, V52.8 Build 1; SEMCAD X Version 14.0 Build 61

Ch384/Hearing Aid Compatibility Test (101x101x1): Measurement grid: dx=5mm, dy=5mm

Maximum value of peak Total field = 46 V/m

Probe Modulation Factor = 1.02

Device Reference Point: 0, 0, -6.3 mm

Reference Value = 59.1 V/m; Power Drift = -0.087 dB

Hearing Aid Near-Field Category: M4 (AWF 0 dB)

Peak E-field in V/m

Grid 1 43 M4	Grid 2 44.9 M4	Grid 3 42.7 M4
Grid 4 43.9 M4	Grid 5 46 M4	Grid 6 43.7 M4
Grid 7 42.9 M4	Grid 8 45.1 M4	Grid 9 42.9 M4

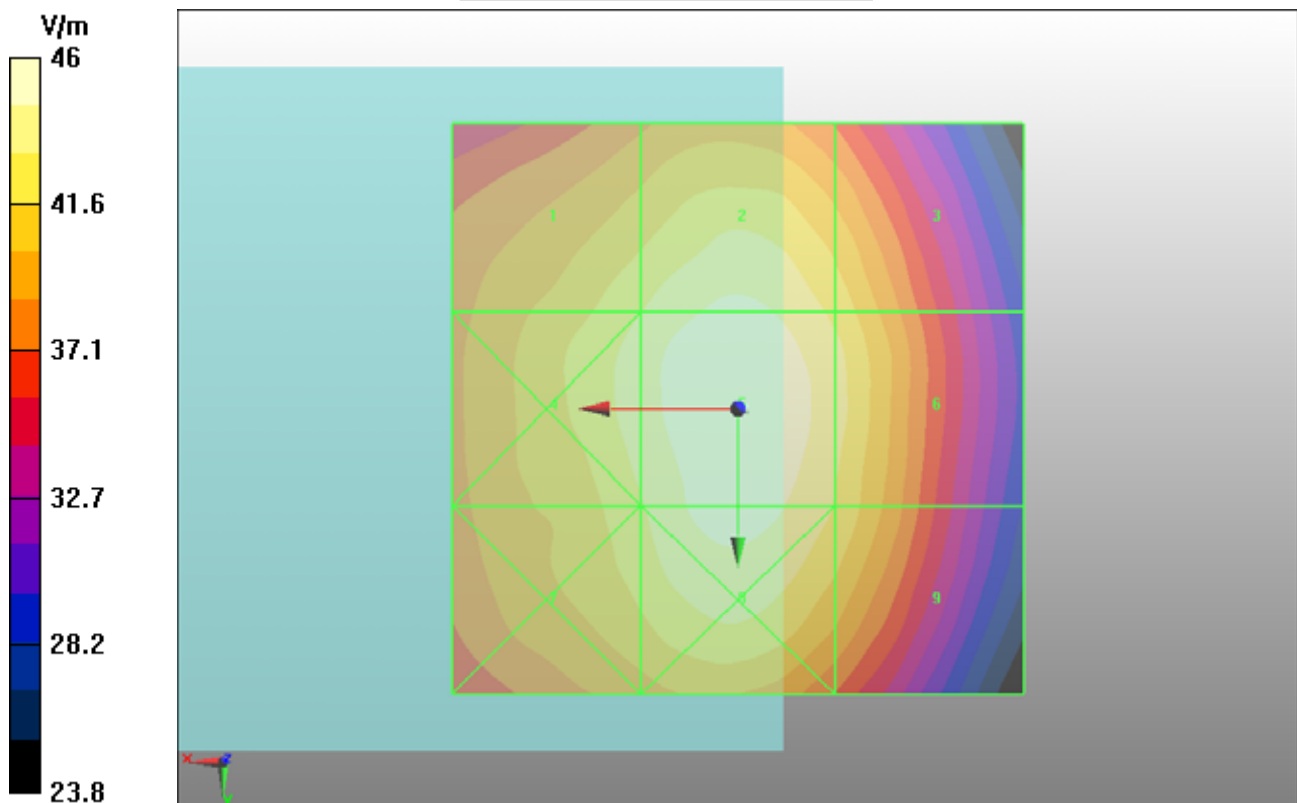

P16 E_Field CDMA2000 BC0_RC3+SO3_Voice_Ch1013_Battery1

DUT: 120522C28

Communication System: CDMA2000; Frequency: 848.31 MHz; Duty Cycle: 1:1

Medium: Air Medium parameters used: $\sigma = 0$ mho/m, $\epsilon_r = 1$; $\rho = 1000$ kg/m³

Ambient Temperature : 21.8 °C;

DASY5 Configuration:

- Probe: ER3DV6 - SN2445; ConvF(1, 1, 1); Calibrated: 2012/02/17
- Sensor-Surface: (Fix Surface)
- Electronics: DAE3 Sn579; Calibrated: 2012/04/27
- Phantom: HAC Test Arch with AMCC; Type: SD HAC P01 BA;
- Measurement SW: DASY52, V52.8 Build 1; SEMCAD X Version 14.0 Build 61

Ch1013/Hearing Aid Compatibility Test (101x101x1): Measurement grid:

dx=5mm, dy=5mm

Maximum value of peak Total field = 48.4 V/m

Probe Modulation Factor = 1.02

Device Reference Point: 0, 0, -6.3 mm

Reference Value = 62.1 V/m; Power Drift = 0.030 dB

Hearing Aid Near-Field Category: M4 (AWF 0 dB)

Peak E-field in V/m

Grid 1 44.3 M4	Grid 2 47.6 M4	Grid 3 45.5 M4
Grid 4 45.1 M4	Grid 5 48.4 M4	Grid 6 46.2 M4
Grid 7 43.4 M4	Grid 8 47.1 M4	Grid 9 45 M4

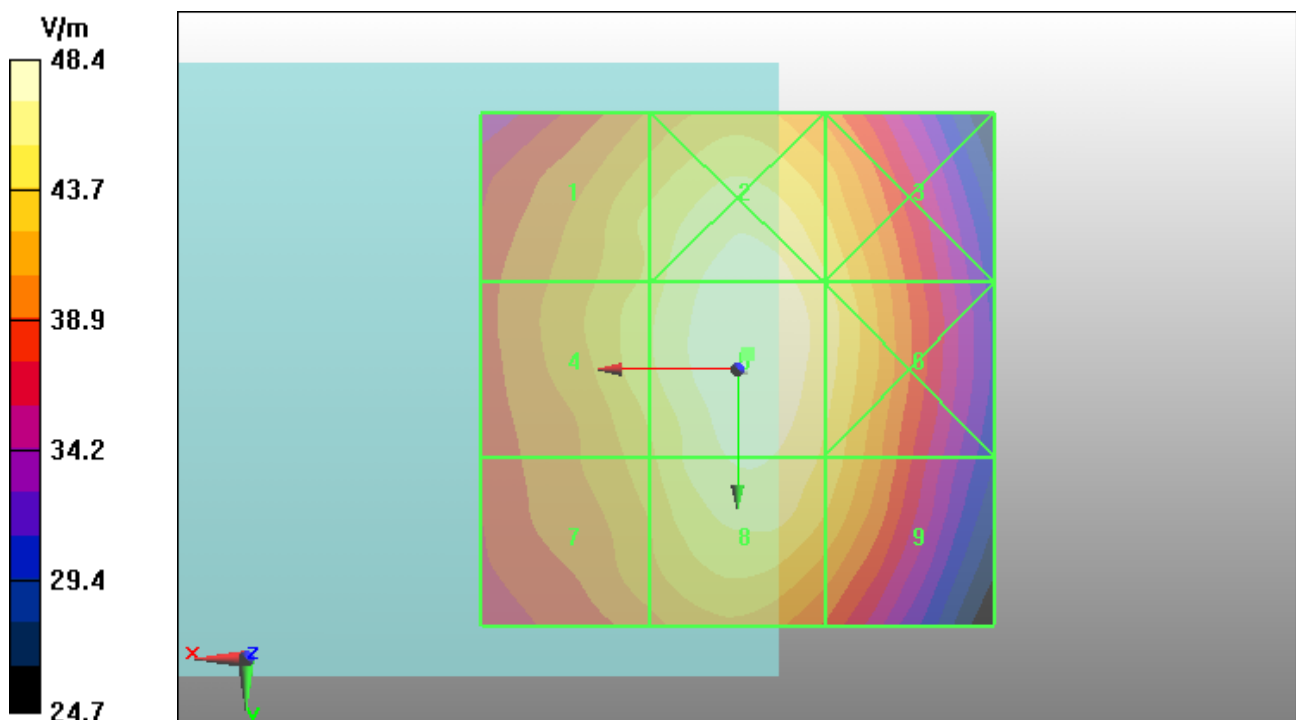

P17 E_Field CDMA2000 BC0_RC3+SO3_Voice_Ch777_Battery1

DUT: 120522C28

Communication System: CDMA2000; Frequency: 848.31 MHz; Duty Cycle: 1:1

Medium: Air Medium parameters used: $\sigma = 0$ mho/m, $\epsilon_r = 1$; $\rho = 1000$ kg/m³

Ambient Temperature : 21.8 °C;

DASY5 Configuration:

- Probe: ER3DV6 - SN2445; ConvF(1, 1, 1); Calibrated: 2012/02/17
- Sensor-Surface: (Fix Surface)
- Electronics: DAE3 Sn579; Calibrated: 2012/04/27
- Phantom: HAC Test Arch with AMCC; Type: SD HAC P01 BA;
- Measurement SW: DASY52, V52.8 Build 1; SEMCAD X Version 14.0 Build 61

Ch777/Hearing Aid Compatibility Test (101x101x1): Measurement grid: dx=5mm, dy=5mm

Maximum value of peak Total field = 43.8 V/m

Probe Modulation Factor = 1.02

Device Reference Point: 0, 0, -6.3 mm

Reference Value = 55.9 V/m; Power Drift = 0.042 dB

Hearing Aid Near-Field Category: M4 (AWF 0 dB)

Peak E-field in V/m

Grid 1 41 M4	Grid 2 42.6 M4	Grid 3 40.2 M4
Grid 4 41.6 M4	Grid 5 43.8 M4	Grid 6 41 M4
Grid 7 40.8 M4	Grid 8 42.7 M4	Grid 9 40.3 M4

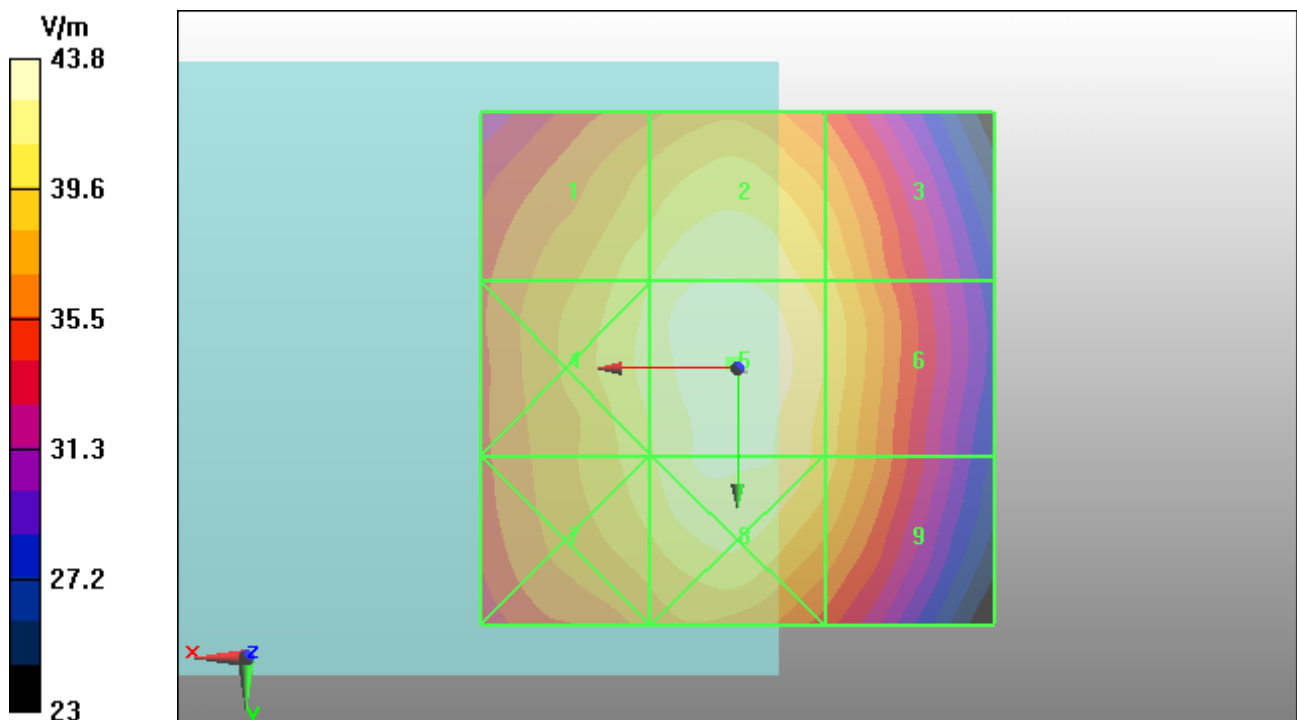

P18 E_Field CDMA2000 BC0_RC3+SO3_Voice_Ch1013_Battery2

DUT: 120522C28

Communication System: CDMA2000; Frequency: 824.7 MHz; Duty Cycle: 1:1

Medium: Air Medium parameters used: $\sigma = 0$ mho/m, $\epsilon_r = 1$; $\rho = 1000$ kg/m³

Ambient Temperature : 21.8 °C;

DASY5 Configuration:

- Probe: ER3DV6 - SN2445; ConvF(1, 1, 1); Calibrated: 2012/02/17

- Sensor-Surface: (Fix Surface)

- Electronics: DAE3 Sn579; Calibrated: 2012/04/27

- Phantom: HAC Test Arch with AMCC; Type: SD HAC P01 BA;

- Measurement SW: DASY52, V52.8 Build 1; SEMCAD X Version 14.0 Build 61

Ch1013/Hearing Aid Compatibility Test (101x101x1): Measurement grid:

dx=5mm, dy=5mm

Maximum value of peak Total field = 48.1 V/m

Probe Modulation Factor = 1.02

Device Reference Point: 0, 0, -6.3 mm

Reference Value = 61.8 V/m; Power Drift = 0.081 dB

Hearing Aid Near-Field Category: M4 (AWF 0 dB)

Peak E-field in V/m

Grid 1 44.6 M4	Grid 2 47.5 M4	Grid 3 45.6 M4
Grid 4 45 M4	Grid 5 48.1 M4	Grid 6 46.2 M4
Grid 7 43.3 M4	Grid 8 46.9 M4	Grid 9 44.9 M4

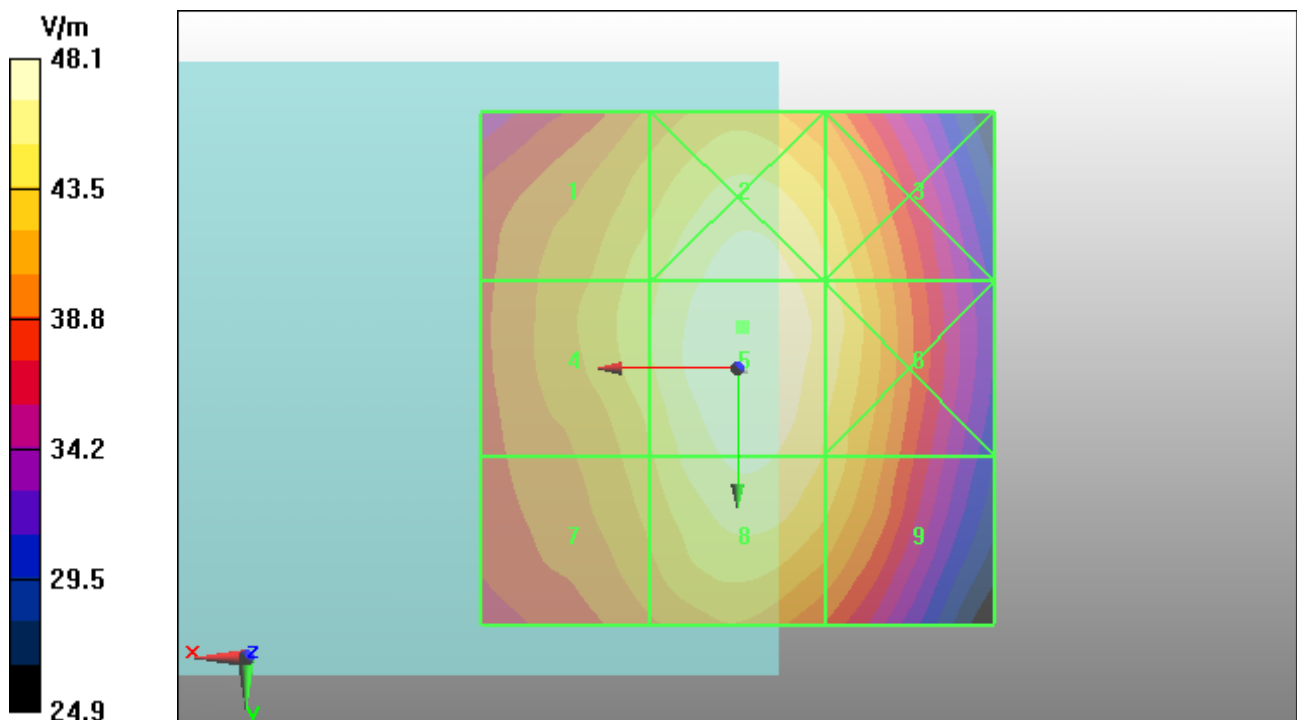

P19 E_Field CDMA2000 BC1_RC3+SO3_Voice_Ch600_Battery1

DUT: 120522C28

Communication System: CDMA2000; Frequency: 1880 MHz; Duty Cycle: 1:1

Medium: Air Medium parameters used: $\sigma = 0$ mho/m, $\epsilon_r = 1$; $\rho = 1000$ kg/m³

Ambient Temperature : 21.8 °C;

DASY5 Configuration:

- Probe: ER3DV6 - SN2445; ConvF(1, 1, 1); Calibrated: 2012/02/17
- Sensor-Surface: (Fix Surface)
- Electronics: DAE3 Sn579; Calibrated: 2012/04/27
- Phantom: HAC Test Arch with AMCC; Type: SD HAC P01 BA;
- Measurement SW: DASY52, V52.8 Build 1; SEMCAD X Version 14.0 Build 61

Ch600/Hearing Aid Compatibility Test (101x101x1): Measurement grid: dx=5mm, dy=5mm

Maximum value of peak Total field = 31.1 V/m

Probe Modulation Factor = 1.02

Device Reference Point: 0, 0, -6.3 mm

Reference Value = 26.8 V/m; Power Drift = -0.010 dB

Hearing Aid Near-Field Category: M4 (AWF 0 dB)

Peak E-field in V/m

Grid 1 32.6 M4	Grid 2 22 M4	Grid 3 18 M4
Grid 4 24.9 M4	Grid 5 27 M4	Grid 6 26.6 M4
Grid 7 31.6 M4	Grid 8 31.1 M4	Grid 9 30.4 M4

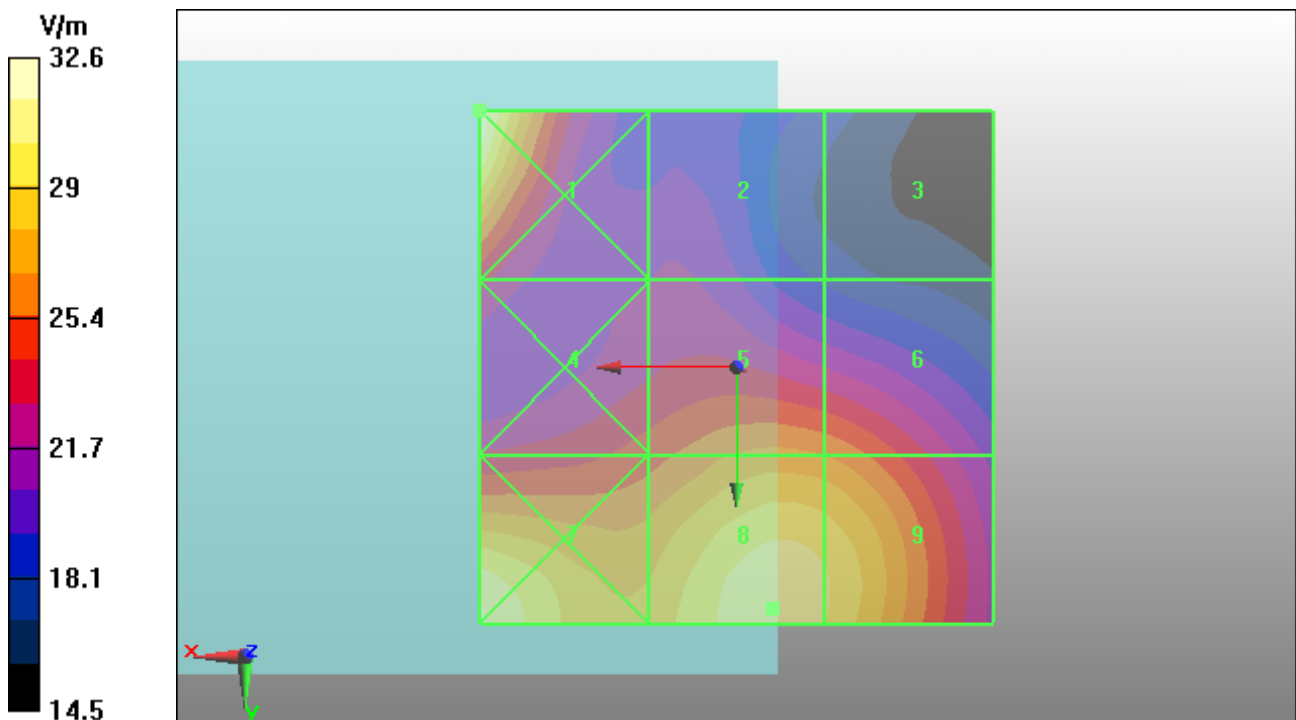

P20 E_Field CDMA2000 BC1_RC3+SO3_Voice_Ch25_Battery1

DUT: 120522C28

Communication System: CDMA2000; Frequency: 1851.25 MHz; Duty Cycle: 1:1

Medium: Air Medium parameters used: $\sigma = 0$ mho/m, $\epsilon_r = 1$; $\rho = 1000$ kg/m³

Ambient Temperature : 21.8 °C;

DASY5 Configuration:

- Probe: ER3DV6 - SN2445; ConvF(1, 1, 1); Calibrated: 2012/02/17

- Sensor-Surface: (Fix Surface)

- Electronics: DAE3 Sn579; Calibrated: 2012/04/27

- Phantom: HAC Test Arch with AMCC; Type: SD HAC P01 BA;

- Measurement SW: DASY52, V52.8 Build 1; SEMCAD X Version 14.0 Build 61

Ch25/Hearing Aid Compatibility Test (101x101x1): Measurement grid: dx=5mm, dy=5mm

Maximum value of peak Total field = 29.3 V/m

Probe Modulation Factor = 1.02

Device Reference Point: 0, 0, -6.3 mm

Reference Value = 24.5 V/m; Power Drift = -0.053 dB

Hearing Aid Near-Field Category: M4 (AWF 0 dB)

Peak E-field in V/m

Grid 1 29.3 M4	Grid 2 21.5 M4	Grid 3 16.3 M4
Grid 4 23.3 M4	Grid 5 25.1 M4	Grid 6 24.6 M4
Grid 7 31.3 M4	Grid 8 29.3 M4	Grid 9 28.3 M4

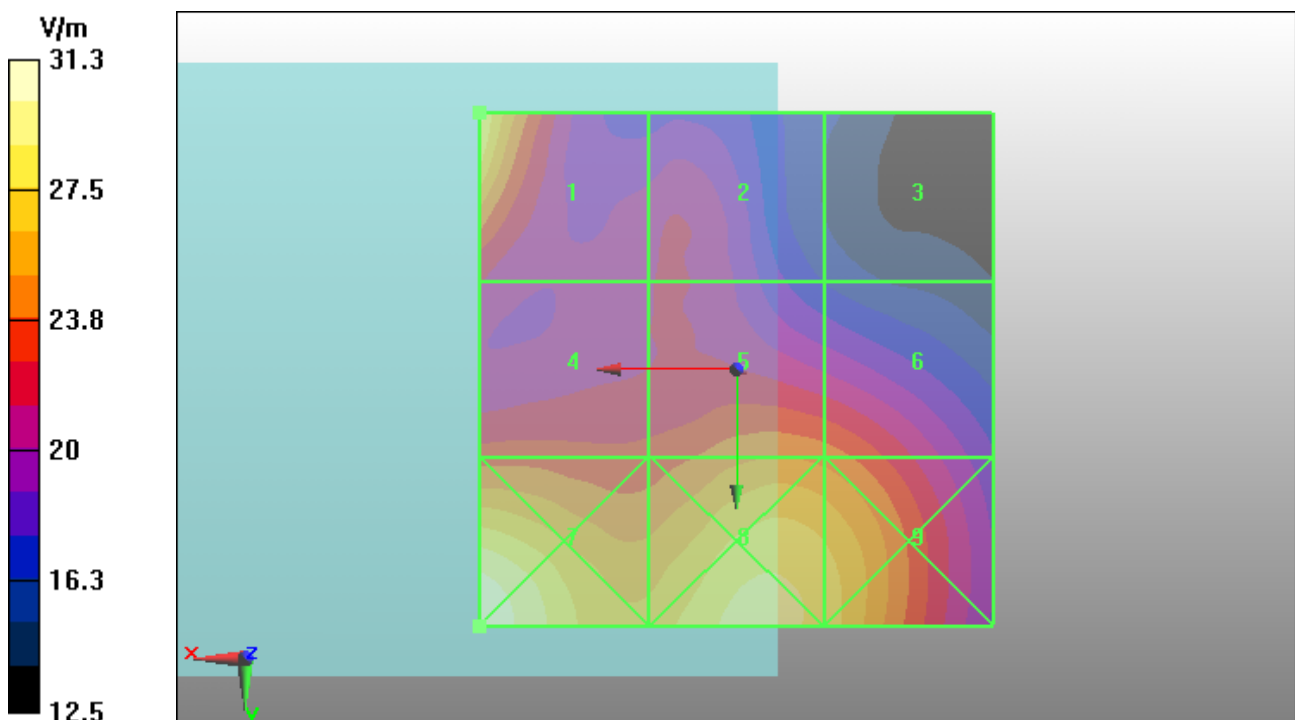

P21 E_Field CDMA2000 BC1_RC3+SO3_Voice_Ch1175_Battery1

DUT: 120522C28

Communication System: CDMA2000; Frequency: 1908.75 MHz; Duty Cycle: 1:1

Medium: Air Medium parameters used: $\sigma = 0$ mho/m, $\epsilon_r = 1$; $\rho = 1000$ kg/m³

Ambient Temperature : 21.8 °C;

DASY5 Configuration:

- Probe: ER3DV6 - SN2445; ConvF(1, 1, 1); Calibrated: 2012/02/17

- Sensor-Surface: (Fix Surface)

- Electronics: DAE3 Sn579; Calibrated: 2012/04/27

- Phantom: HAC Test Arch with AMCC; Type: SD HAC P01 BA;

- Measurement SW: DASY52, V52.8 Build 1; SEMCAD X Version 14.0 Build 61

Ch1175/Hearing Aid Compatibility Test (101x101x1): Measurement grid:

dx=5mm, dy=5mm

Maximum value of peak Total field = 27.8 V/m

Probe Modulation Factor = 1.02

Device Reference Point: 0, 0, -6.3 mm

Reference Value = 23.7 V/m; Power Drift = -0.187 dB

Hearing Aid Near-Field Category: M4 (AWF 0 dB)

Peak E-field in V/m

Grid 1 30.3 M4	Grid 2 18.1 M4	Grid 3 16.9 M4
Grid 4 21.9 M4	Grid 5 23.3 M4	Grid 6 22.3 M4
Grid 7 27.6 M4	Grid 8 27.8 M4	Grid 9 26.2 M4

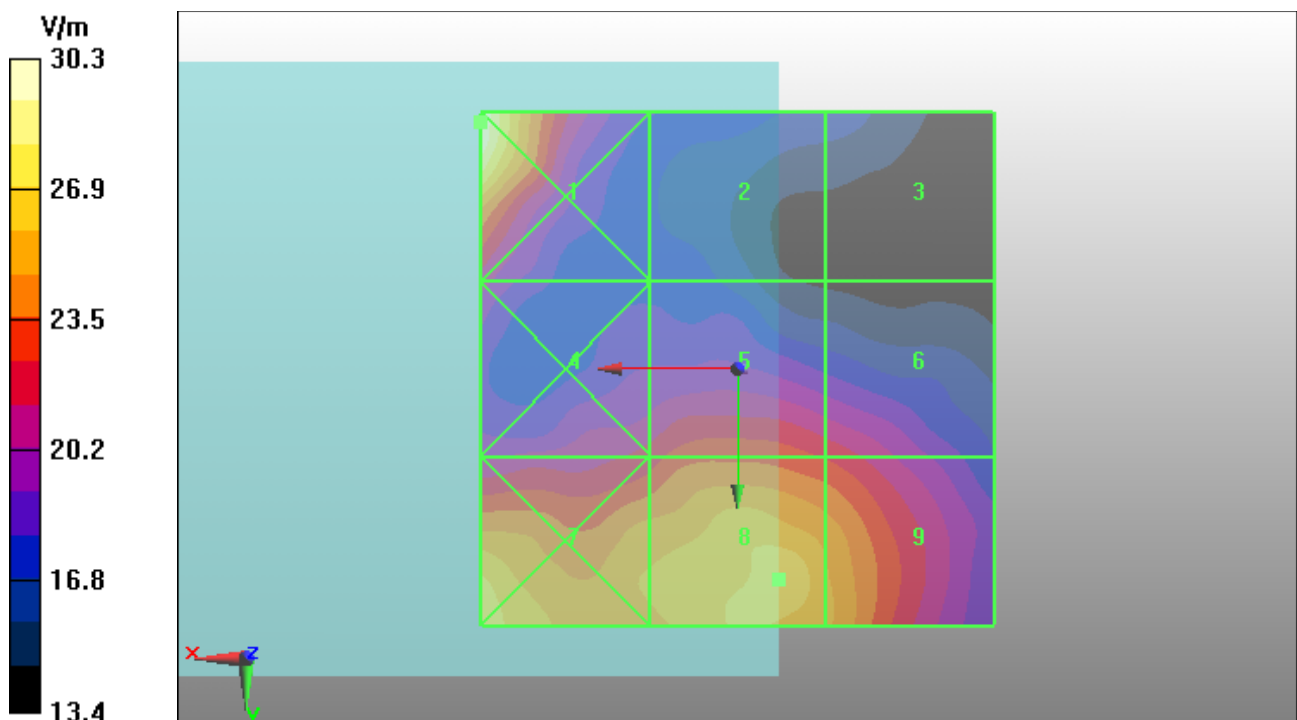

P22 E_Field CDMA2000 BC1_RC3+SO3_Voice_Ch600_Battery2

DUT: 120522C28

Communication System: CDMA2000; Frequency: 1880 MHz; Duty Cycle: 1:1

Medium: Air Medium parameters used: $\sigma = 0$ mho/m, $\epsilon_r = 1$; $\rho = 1000$ kg/m³

Ambient Temperature : 21.8 °C;

DASY5 Configuration:

- Probe: ER3DV6 - SN2445; ConvF(1, 1, 1); Calibrated: 2012/02/17
- Sensor-Surface: (Fix Surface)
- Electronics: DAE3 Sn579; Calibrated: 2012/04/27
- Phantom: HAC Test Arch with AMCC; Type: SD HAC P01 BA;
- Measurement SW: DASY52, V52.8 Build 1; SEMCAD X Version 14.0 Build 61

Ch600/Hearing Aid Compatibility Test (101x101x1): Measurement grid: dx=5mm, dy=5mm

Maximum value of peak Total field = 31 V/m

Probe Modulation Factor = 1.02

Device Reference Point: 0, 0, -6.3 mm

Reference Value = 26.4 V/m; Power Drift = 0.037 dB

Hearing Aid Near-Field Category: M4 (AWF 0 dB)

Peak E-field in V/m

Grid 1 32.1 M4	Grid 2 22.1 M4	Grid 3 17.9 M4
Grid 4 25 M4	Grid 5 26.8 M4	Grid 6 26.4 M4
Grid 7 31.8 M4	Grid 8 31 M4	Grid 9 30.4 M4

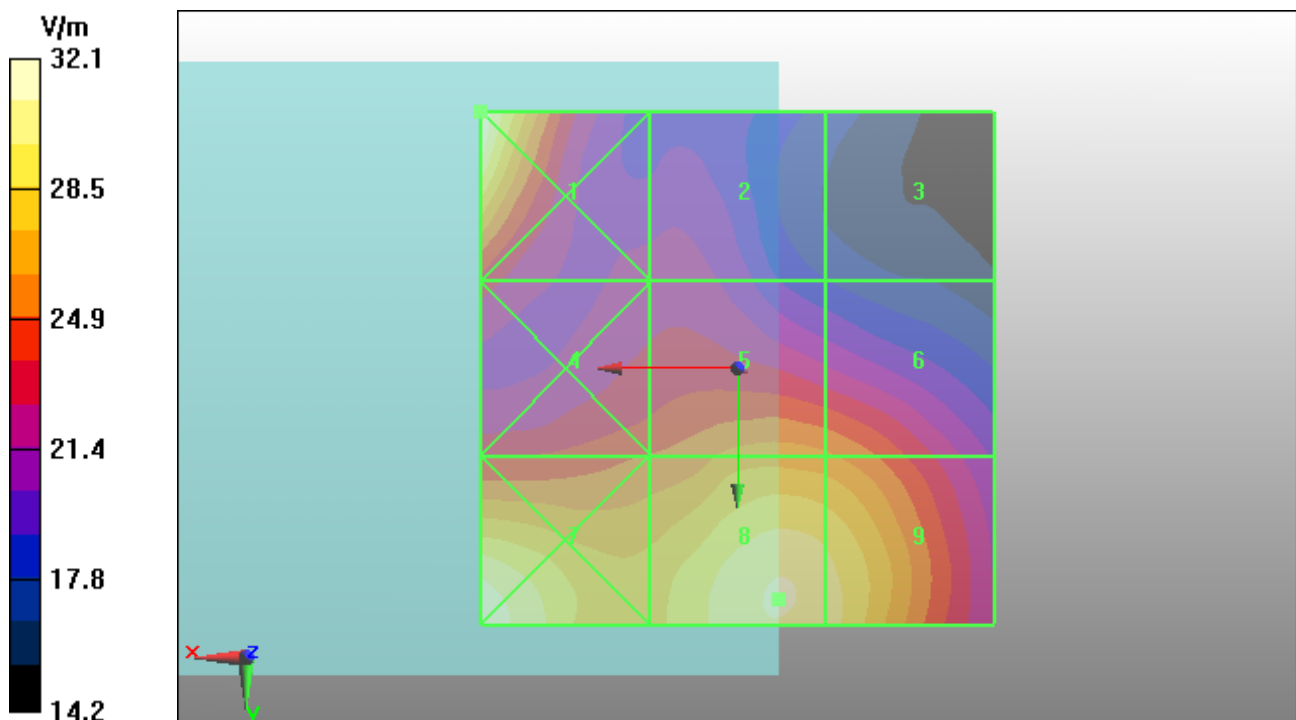

P23 H_Field CDMA2000 BC0_RC3+SO3_Voice_Ch384_Battery1

DUT: 120522C28

Communication System: CDMA2000; Frequency: 836.52 MHz; Duty Cycle: 1:1

Medium: Air Medium parameters used: $\sigma = 0$ mho/m, $\epsilon_r = 1$; $\rho = 1$ kg/m³

Ambient Temperature : 21.8 °C;

DASY5 Configuration:

- Probe: H3DV6 - SN6274; ; Calibrated: 2012/02/17
- Sensor-Surface: (Fix Surface)
- Electronics: DAE3 Sn579; Calibrated: 2012/04/27
- Phantom: HAC Test Arch with AMCC; Type: SD HAC P01 BA;
- Measurement SW: DASY52, V52.8 Build 1; SEMCAD X Version 14.0 Build 61

Ch384/Hearing Aid Compatibility Test (101x101x1): Measurement grid: dx=5mm, dy=5mm

Maximum value of peak Total field = 0.088 A/m

Probe Modulation Factor = 1.02

Device Reference Point: 0, 0, -6.3 mm

Reference Value = 0.053 A/m; Power Drift = -0.165 dB

Hearing Aid Near-Field Category: M4 (AWF 0 dB)

Peak H-field in A/m

Grid 1 0.103 M4	Grid 2 0.069 M4	Grid 3 0.039 M4
Grid 4 0.080 M4	Grid 5 0.073 M4	Grid 6 0.035 M4
Grid 7 0.097 M4	Grid 8 0.088 M4	Grid 9 0.040 M4

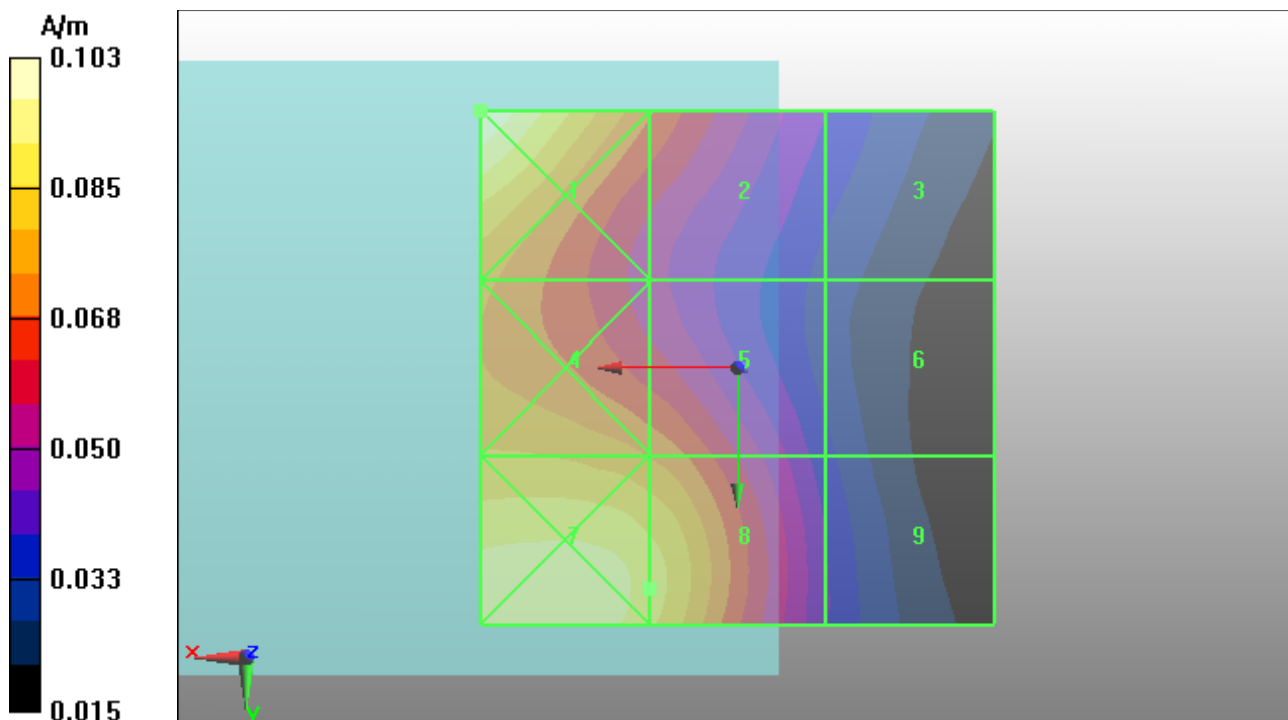

P24 H_Field CDMA2000 BC0_RC3+SO3_Voice_Ch1013_Battery1

DUT: 120522C28

Communication System: CDMA2000; Frequency: 824.7 MHz; Duty Cycle: 1:1

Medium: Air Medium parameters used: $\sigma = 0$ mho/m, $\epsilon_r = 1$; $\rho = 1$ kg/m³

Ambient Temperature : 21.8 °C;

DASY5 Configuration:

- Probe: H3DV6 - SN6274; ; Calibrated: 2012/02/17

- Sensor-Surface: (Fix Surface)

- Electronics: DAE3 Sn579; Calibrated: 2012/04/27

- Phantom: HAC Test Arch with AMCC; Type: SD HAC P01 BA;

- Measurement SW: DASY52, V52.8 Build 1; SEMCAD X Version 14.0 Build 61

Ch1013/Hearing Aid Compatibility Test (101x101x1): Measurement grid: dx=5mm, dy=5mm

Maximum value of peak Total field = 0.113 A/m

Probe Modulation Factor = 1.02

Device Reference Point: 0, 0, -6.3 mm

Reference Value = 0.065 A/m; Power Drift = -0.00999 dB

Hearing Aid Near-Field Category: M4 (AWF 0 dB)

Peak H-field in A/m

Grid 1 0.108 M4	Grid 2 0.074 M4	Grid 3 0.041 M4
Grid 4 0.091 M4	Grid 5 0.086 M4	Grid 6 0.043 M4
Grid 7 0.113 M4	Grid 8 0.105 M4	Grid 9 0.049 M4

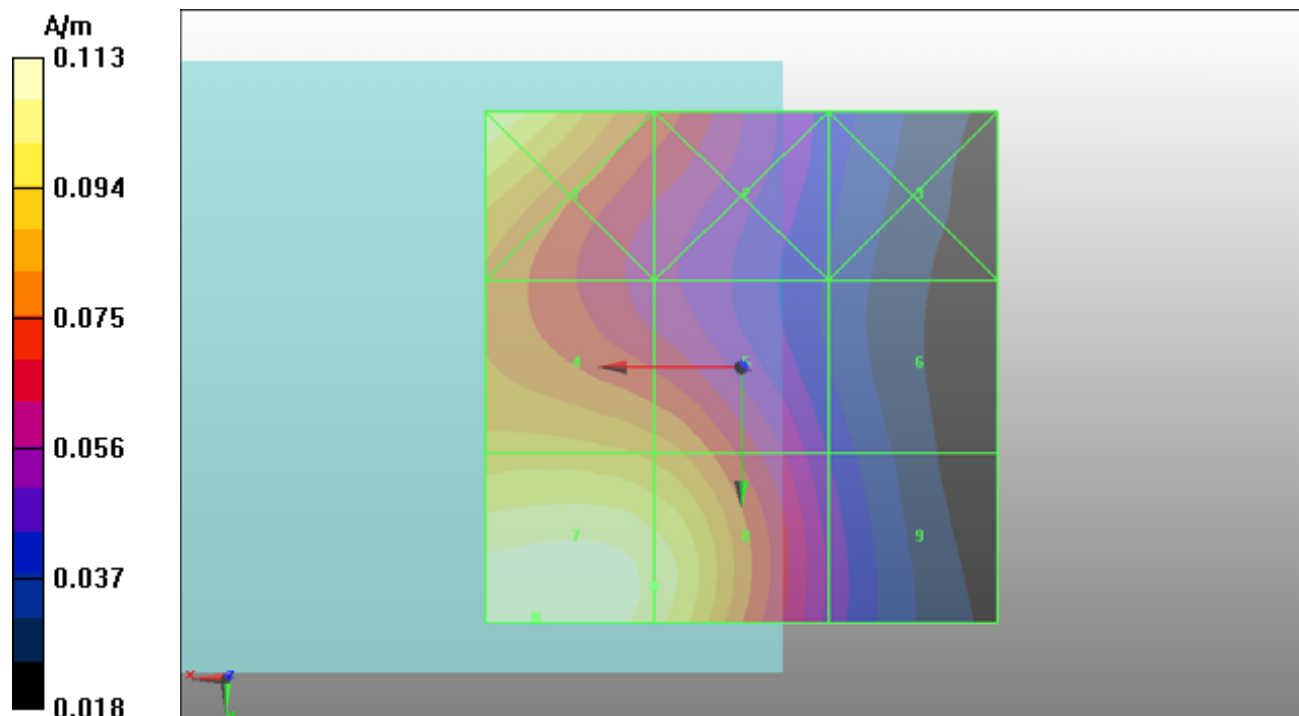

P25 H_Field CDMA2000 BC0_RC3+SO3_Voice_Ch777_Battery1

DUT: 120522C28

Communication System: CDMA2000; Frequency: 848.31 MHz; Duty Cycle: 1:1

Medium: Air Medium parameters used: $\sigma = 0$ mho/m, $\epsilon_r = 1$; $\rho = 1$ kg/m³

Ambient Temperature : 21.8 °C;

DASY5 Configuration:

- Probe: H3DV6 - SN6274; ; Calibrated: 2012/02/17
- Sensor-Surface: (Fix Surface)
- Electronics: DAE3 Sn579; Calibrated: 2012/04/27
- Phantom: HAC Test Arch with AMCC; Type: SD HAC P01 BA;
- Measurement SW: DASY52, V52.8 Build 1; SEMCAD X Version 14.0 Build 61

Ch777/Hearing Aid Compatibility Test (101x101x1): Measurement grid: dx=5mm, dy=5mm

Maximum value of peak Total field = 0.077 A/m

Probe Modulation Factor = 1.02

Device Reference Point: 0, 0, -6.3 mm

Reference Value = 0.044 A/m; Power Drift = -0.084 dB

Hearing Aid Near-Field Category: M4 (AWF 0 dB)

Peak H-field in A/m

Grid 1 0.077 M4	Grid 2 0.054 M4	Grid 3 0.034 M4
Grid 4 0.070 M4	Grid 5 0.063 M4	Grid 6 0.028 M4
Grid 7 0.088 M4	Grid 8 0.080 M4	Grid 9 0.033 M4

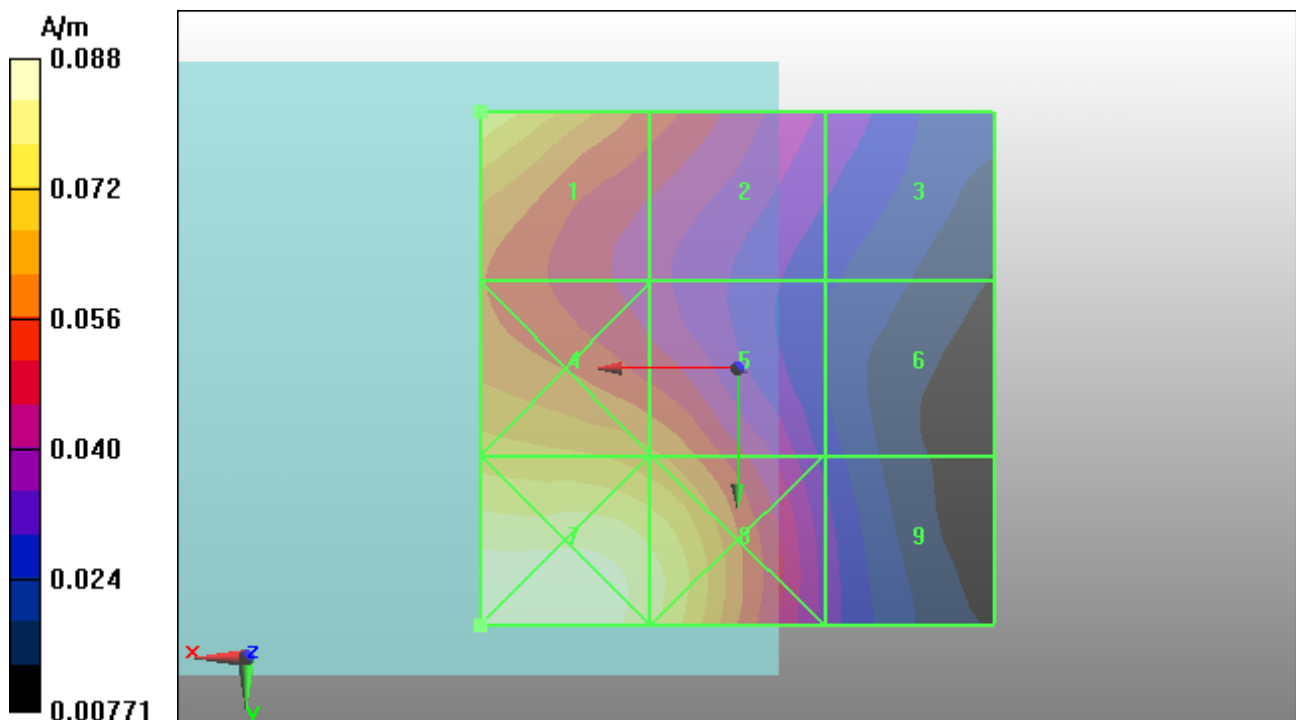

P26 H_Field CDMA2000 BC0_RC3+SO3_Voice_Ch1013_Battery2

DUT: 120522C28

Communication System: CDMA2000; Frequency: 824.7 MHz; Duty Cycle: 1:1

Medium: Air Medium parameters used: $\sigma = 0$ mho/m, $\epsilon_r = 1$; $\rho = 1$ kg/m³

Ambient Temperature : 21.8 °C;

DASY5 Configuration:

- Probe: H3DV6 - SN6274; ; Calibrated: 2012/02/17
- Sensor-Surface: (Fix Surface)
- Electronics: DAE3 Sn579; Calibrated: 2012/04/27
- Phantom: HAC Test Arch with AMCC; Type: SD HAC P01 BA;
- Measurement SW: DASY52, V52.8 Build 1; SEMCAD X Version 14.0 Build 61

Ch1013/Hearing Aid Compatibility Test (101x101x1): Measurement grid: dx=5mm, dy=5mm

Maximum value of peak Total field = 0.112 A/m

Probe Modulation Factor = 1.02

Device Reference Point: 0, 0, -6.3 mm

Reference Value = 0.064 A/m; Power Drift = 0.017 dB

Hearing Aid Near-Field Category: M4 (AWF 0 dB)

Peak H-field in A/m

Grid 1 0.107 M4	Grid 2 0.073 M4	Grid 3 0.041 M4
Grid 4 0.091 M4	Grid 5 0.086 M4	Grid 6 0.043 M4
Grid 7 0.112 M4	Grid 8 0.104 M4	Grid 9 0.049 M4

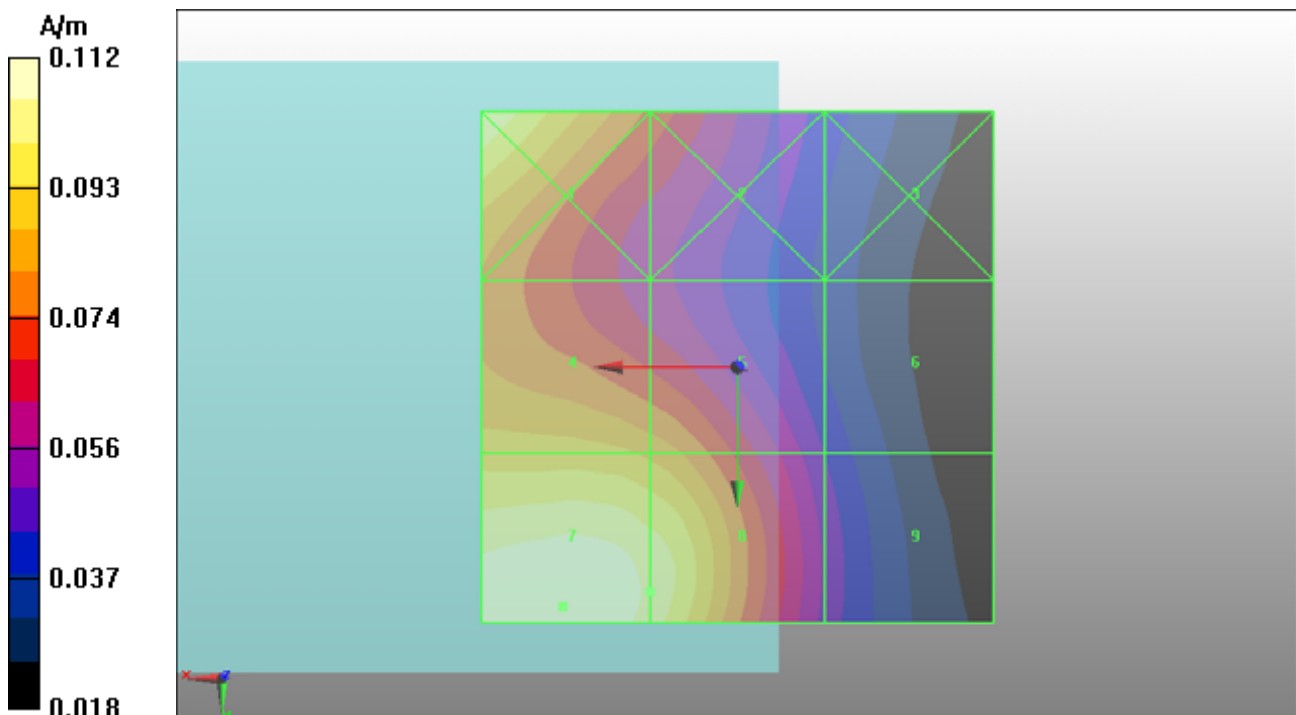

P27 H_Field CDMA2000 BC0_RC3+SO3_Voice_Ch600_Battery1

DUT: 120522C28

Communication System: CDMA2000; Frequency: 1880 MHz; Duty Cycle: 1:1

Medium: Air Medium parameters used: $\sigma = 0$ mho/m, $\epsilon_r = 1$; $\rho = 1$ kg/m³

Ambient Temperature : 21.8 °C;

DASY5 Configuration:

- Probe: H3DV6 - SN6274; ; Calibrated: 2012/02/17
- Sensor-Surface: (Fix Surface)
- Electronics: DAE3 Sn579; Calibrated: 2012/04/27
- Phantom: HAC Test Arch with AMCC; Type: SD HAC P01 BA;
- Measurement SW: DASY52, V52.8 Build 1; SEMCAD X Version 14.0 Build 61

Ch600/Hearing Aid Compatibility Test (101x101x1): Measurement grid: dx=5mm, dy=5mm

Maximum value of peak Total field = 0.092 A/m

Probe Modulation Factor = 1.02

Device Reference Point: 0, 0, -6.3 mm

Reference Value = 0.119 A/m; Power Drift = 0.000343 dB

Hearing Aid Near-Field Category: M4 (AWF 0 dB)

Peak H-field in A/m

Grid 1 0.098 M4	Grid 2 0.095 M4	Grid 3 0.078 M4
Grid 4 0.092 M4	Grid 5 0.092 M4	Grid 6 0.082 M4
Grid 7 0.075 M4	Grid 8 0.085 M4	Grid 9 0.078 M4

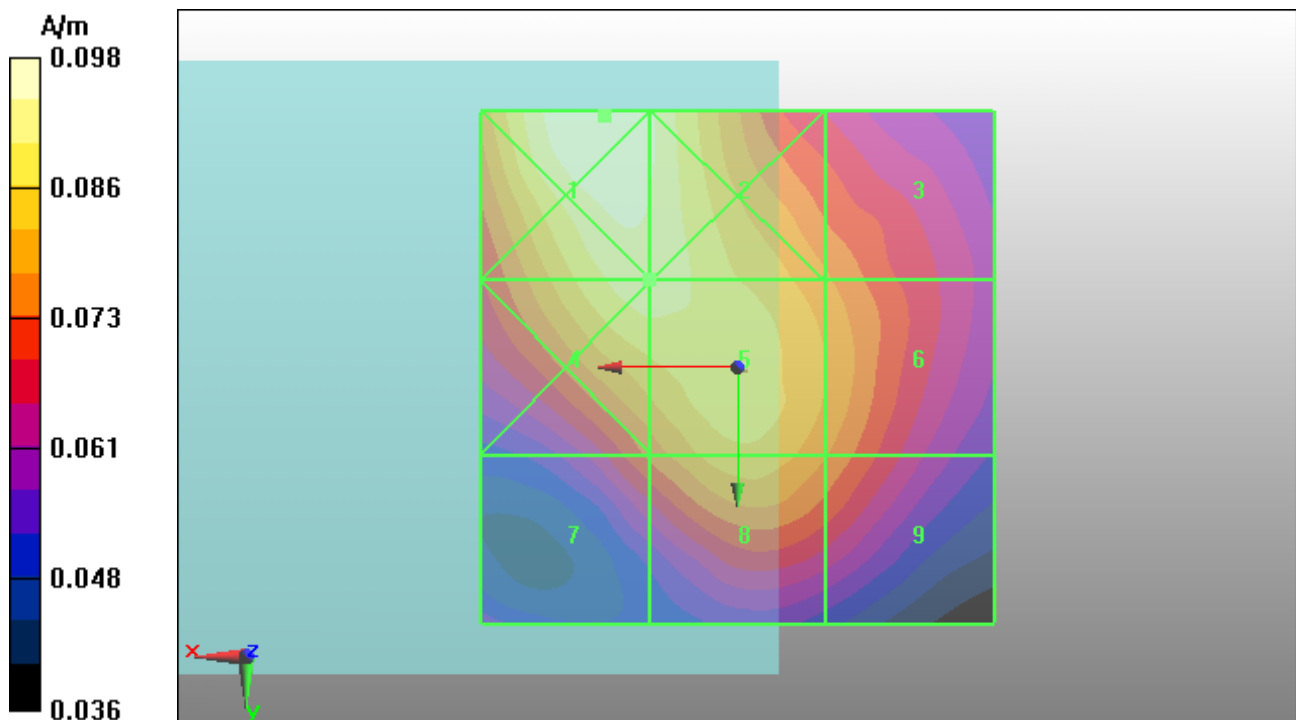

P28 H_Field CDMA2000 BC0_RC3+SO3_Voice_Ch25_Battery1

DUT: 120522C28

Communication System: CDMA2000; Frequency: 1851.25 MHz; Duty Cycle: 1:1

Medium: Air Medium parameters used: $\sigma = 0$ mho/m, $\epsilon_r = 1$; $\rho = 1$ kg/m³

Ambient Temperature : 21.8 °C;

DASY5 Configuration:

- Probe: H3DV6 - SN6274; ; Calibrated: 2012/02/17
- Sensor-Surface: (Fix Surface)
- Electronics: DAE3 Sn579; Calibrated: 2012/04/27
- Phantom: HAC Test Arch with AMCC; Type: SD HAC P01 BA;
- Measurement SW: DASY52, V52.8 Build 1; SEMCAD X Version 14.0 Build 61

Ch25/Hearing Aid Compatibility Test (101x101x1): Measurement grid: dx=5mm, dy=5mm

Maximum value of peak Total field = 0.100 A/m

Probe Modulation Factor = 1.02

Device Reference Point: 0, 0, -6.3 mm

Reference Value = 0.111 A/m; Power Drift = -0.010 dB

Hearing Aid Near-Field Category: M4 (AWF 0 dB)

Peak H-field in A/m

Grid 1 0.100 M4	Grid 2 0.091 M4	Grid 3 0.079 M4
Grid 4 0.083 M4	Grid 5 0.082 M4	Grid 6 0.076 M4
Grid 7 0.066 M4	Grid 8 0.076 M4	Grid 9 0.071 M4

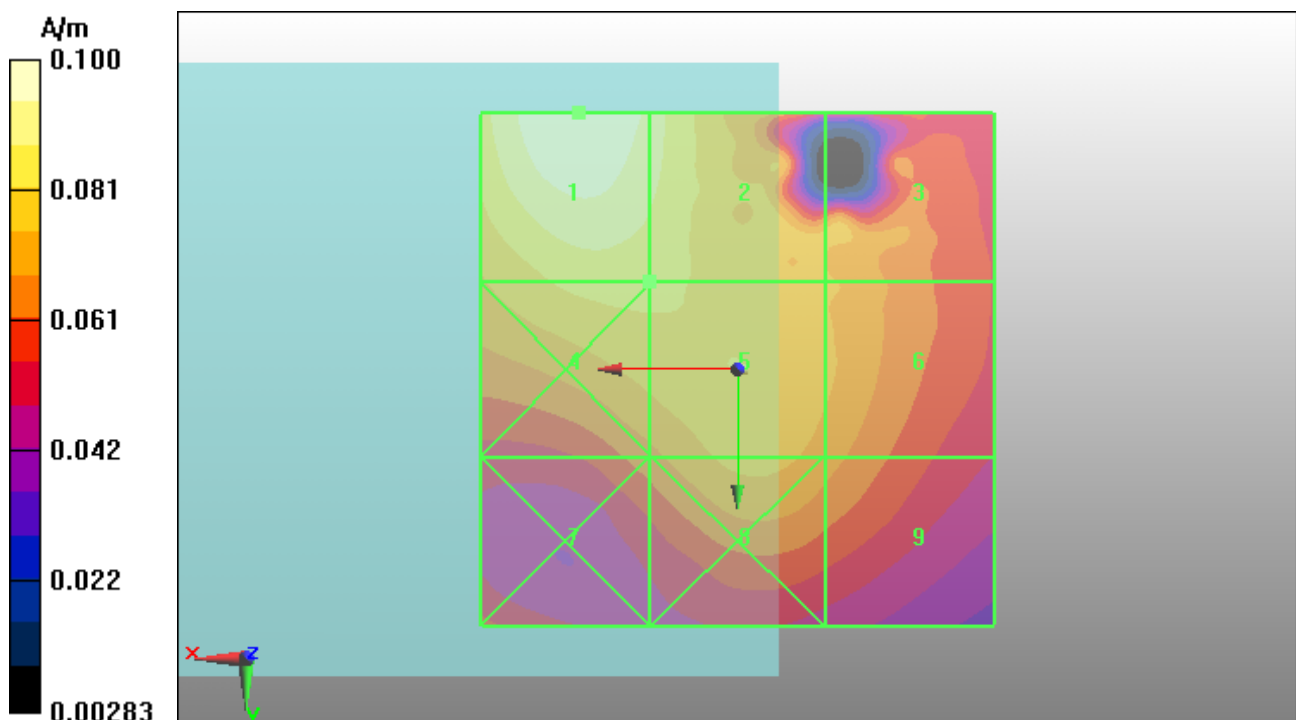

P29 H_Field CDMA2000 BC0_RC3+SO3_Voice_Ch1175_Battery1

DUT: 120522C28

Communication System: CDMA2000; Frequency: 1908.75 MHz; Duty Cycle: 1:1

Medium: Air Medium parameters used: $\sigma = 0$ mho/m, $\epsilon_r = 1$; $\rho = 1$ kg/m³

Ambient Temperature : 21.8 °C;

DASY5 Configuration:

- Probe: H3DV6 - SN6274; ; Calibrated: 2012/02/17
- Sensor-Surface: (Fix Surface)
- Electronics: DAE3 Sn579; Calibrated: 2012/04/27
- Phantom: HAC Test Arch with AMCC; Type: SD HAC P01 BA;
- Measurement SW: DASY52, V52.8 Build 1; SEMCAD X Version 14.0 Build 61

Ch1175/Hearing Aid Compatibility Test (101x101x1): Measurement grid:

dx=5mm, dy=5mm

Maximum value of peak Total field = 0.089 A/m

Probe Modulation Factor = 1.02

Device Reference Point: 0, 0, -6.3 mm

Reference Value = 0.116 A/m; Power Drift = -0.045 dB

Hearing Aid Near-Field Category: M4 (AWF 0 dB)

Peak H-field in A/m

Grid 1 0.090 M4	Grid 2 0.089 M4	Grid 3 0.075 M4
Grid 4 0.088 M4	Grid 5 0.089 M4	Grid 6 0.079 M4
Grid 7 0.075 M4	Grid 8 0.083 M4	Grid 9 0.074 M4

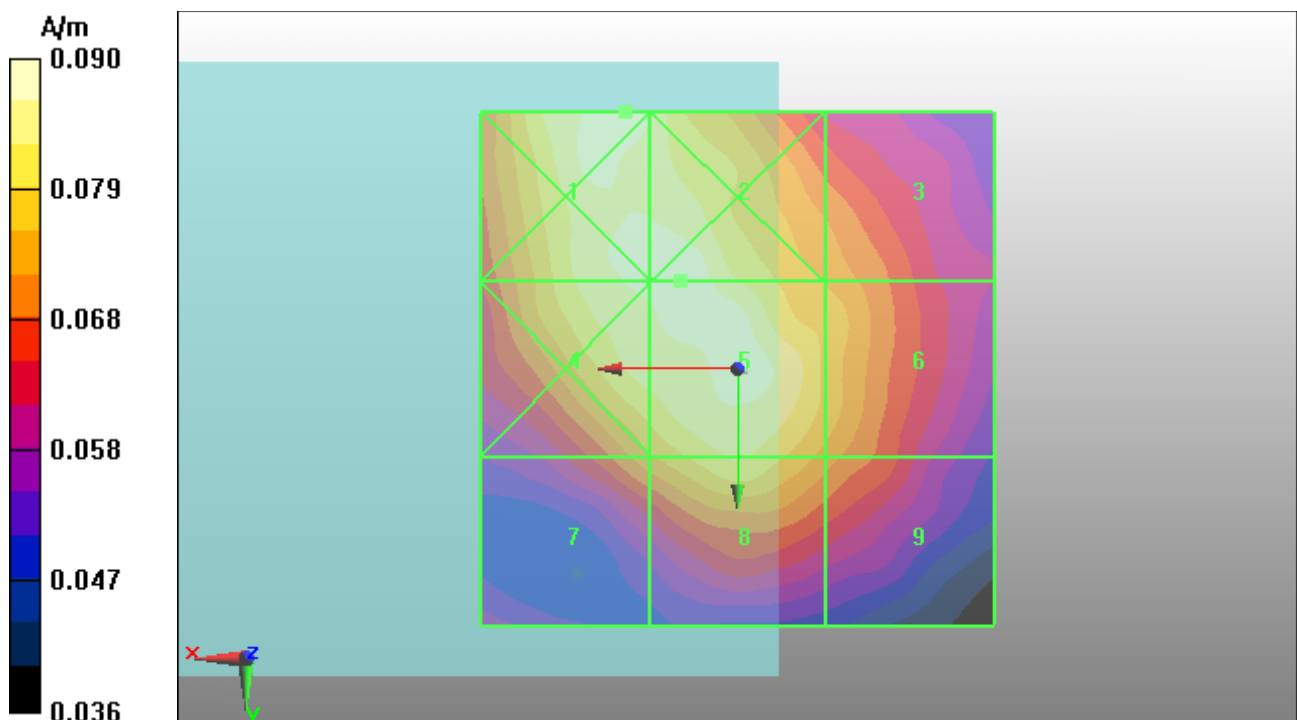

P30 H_Field CDMA2000 BC0_RC3+SO3_Voice_Ch25_Battery2

DUT: 120522C28

Communication System: CDMA2000; Frequency: 1851.25 MHz; Duty Cycle: 1:1

Medium: Air Medium parameters used: $\sigma = 0$ mho/m, $\epsilon_r = 1$; $\rho = 1$ kg/m³

Ambient Temperature : 21.8 °C;

DASY5 Configuration:

- Probe: H3DV6 - SN6274; ; Calibrated: 2012/02/17
- Sensor-Surface: (Fix Surface)
- Electronics: DAE3 Sn579; Calibrated: 2012/04/27
- Phantom: HAC Test Arch with AMCC; Type: SD HAC P01 BA;
- Measurement SW: DASY52, V52.8 Build 1; SEMCAD X Version 14.0 Build 61

Ch25/Hearing Aid Compatibility Test (101x101x1): Measurement grid: dx=5mm, dy=5mm

Maximum value of peak Total field = 0.091 A/m

Probe Modulation Factor = 1.02

Device Reference Point: 0, 0, -6.3 mm

Reference Value = 0.113 A/m; Power Drift = 0.092 dB

Hearing Aid Near-Field Category: M4 (AWF 0 dB)

Peak H-field in A/m

Grid 1 0.091 M4	Grid 2 0.091 M4	Grid 3 0.077 M4
Grid 4 0.090 M4	Grid 5 0.091 M4	Grid 6 0.079 M4
Grid 7 0.074 M4	Grid 8 0.081 M4	Grid 9 0.076 M4

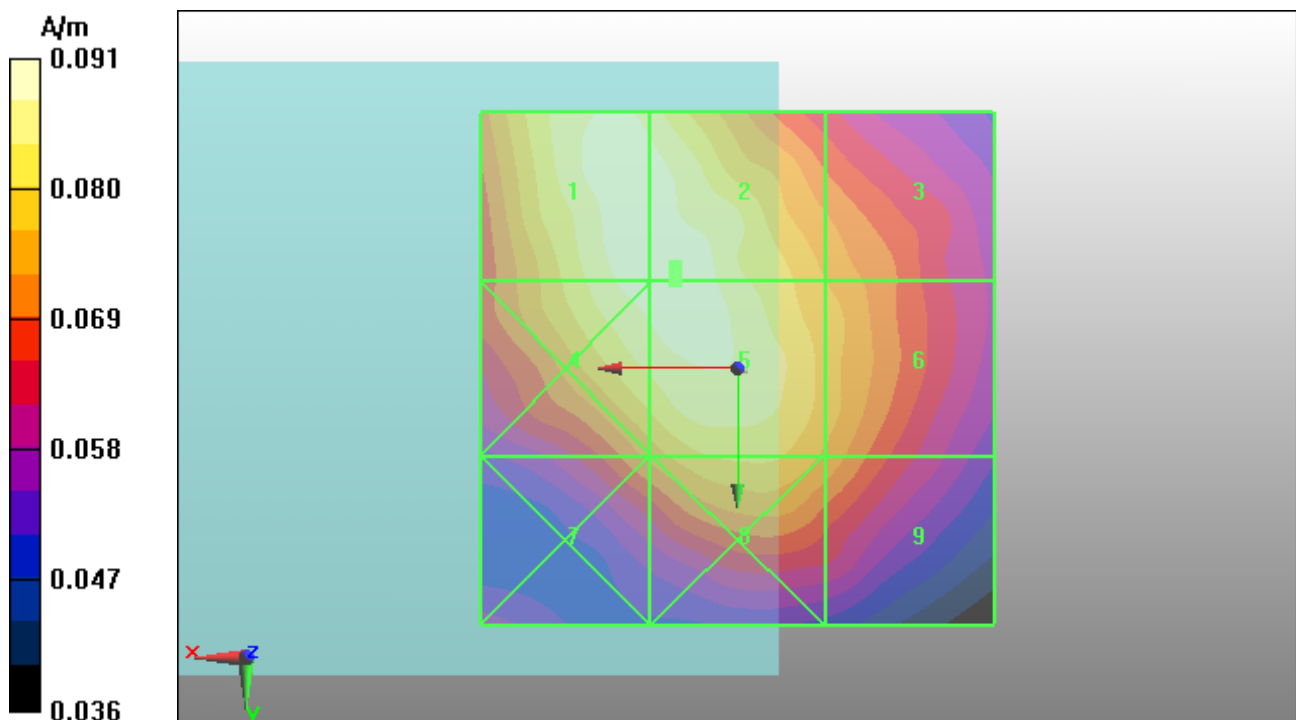



Accredited by the Swiss Accreditation Service (SAS)
The Swiss Accreditation Service is one of the signatories to the EA
Multilateral Agreement for the recognition of calibration certificates

Accreditation No.: **SCS 108**

Client **B.V. ADT (Auden)**

Certificate No: **CD835V3-1041_Mar12**

CALIBRATION CERTIFICATE

Object **CD835V3 - SN: 1041**

Calibration procedure(s) **QA CAL-20.v6
Calibration procedure for dipoles in air**

Calibration date: **March 19, 2012**

This calibration certificate documents the traceability to national standards, which realize the physical units of measurements (SI).
The measurements and the uncertainties with confidence probability are given on the following pages and are part of the certificate.

All calibrations have been conducted in the closed laboratory facility: environment temperature $(22 \pm 3)^{\circ}\text{C}$ and humidity $< 70\%$.

Calibration Equipment used (M&TE critical for calibration)

Primary Standards	ID #	Cal Date (Certificate No.)	Scheduled Calibration
Power meter EPM-442A	GB37480704	05-Oct-11 (No. 217-01451)	Oct-12
Power sensor HP 8481A	US37292783	05-Oct-11 (No. 217-01451)	Oct-12
Probe ER3DV6	SN: 2336	29-Dec-11 (No. ER3-2336_Dec11)	Dec-12
Probe H3DV6	SN: 6065	29-Dec-11 (No. H3-6065_Dec11)	Dec-12
DAE4	SN: 781	20-Apr-11 (No. DAE4-781_Apr11)	Apr-12

Secondary Standards	ID #	Check Date (in house)	Scheduled Check
Power meter Agilent 4419B	SN: GB42420191	09-Oct-09 (in house check Oct-11)	In house check: Oct-12
Power sensor HP 8482H	SN: 3318A09450	09-Oct-09 (in house check Oct-11)	In house check: Oct-12
Power sensor HP 8482A	SN: US37295597	09-Oct-09 (in house check Oct-11)	In house check: Oct-12
Network Analyzer HP 8753E	US37390585	18-Oct-01 (in house check Oct-11)	In house check: Oct-12
RF generator E4433B	MY 41000675	03-Nov-04 (in house check Oct-11)	In house check: Oct-13

Calibrated by: **Claudio Leubler** Name: Claudio Leubler Function: Laboratory Technician

Signature

Approved by: **Fin Bomholt** Name: Fin Bomholt R&D Director

Issued: March 20, 2012

This calibration certificate shall not be reproduced except in full without written approval of the laboratory.



Accredited by the Swiss Accreditation Service (SAS)

The Swiss Accreditation Service is one of the signatories to the EA
Multilateral Agreement for the recognition of calibration certificates

Accreditation No.: **SCS 108**

References

- [1] ANSI-C63.19-2007
American National Standard for Methods of Measurement of Compatibility between Wireless Communications Devices and Hearing Aids.

Methods Applied and Interpretation of Parameters:

- *Coordinate System:* y-axis is in the direction of the dipole arms. z-axis is from the basis of the antenna (mounted on the table) towards its feed point between the two dipole arms. x-axis is normal to the other axes. In coincidence with the standards [1], the measurement planes (probe sensor center) are selected to be at a distance of 10 mm above the top edge of the dipole arms.
- *Measurement Conditions:* Further details are available from the hardcopies at the end of the certificate. All figures stated in the certificate are valid at the frequency indicated. The forward power to the dipole connector is set with a calibrated power meter connected and monitored with an auxiliary power meter connected to a directional coupler. While the dipole under test is connected, the forward power is adjusted to the same level.
- *Antenna Positioning:* The dipole is mounted on a HAC Test Arch phantom using the matching dipole positioner with the arms horizontal and the feeding cable coming from the floor. The measurements are performed in a shielded room with absorbers around the setup to reduce the reflections. It is verified before the mounting of the dipole under the Test Arch phantom, that its arms are perfectly in a line. It is installed on the HAC dipole positioner with its arms parallel below the dielectric reference wire and able to move elastically in vertical direction without changing its relative position to the top center of the Test Arch phantom. The vertical distance to the probe is adjusted after dipole mounting with a DASY5 Surface Check job. Before the measurement, the distance between phantom surface and probe tip is verified. The proper measurement distance is selected by choosing the matching section of the HAC Test Arch phantom with the proper device reference point (upper surface of the dipole) and the matching grid reference point (tip of the probe) considering the probe sensor offset. The vertical distance to the probe is essential for the accuracy.
- *Feed Point Impedance and Return Loss:* These parameters are measured using a HP 8753E Vector Network Analyzer. The impedance is specified at the SMA connector of the dipole. The influence of reflections was eliminated by applying the averaging function while moving the dipole in the air, at least 70cm away from any obstacles.
- *E-field distribution:* E field is measured in the x-y-plane with an isotropic ER3D-field probe with 100 mW forward power to the antenna feed point. In accordance with [1], the scan area is 20mm wide, its length exceeds the dipole arm length (180 or 90mm). The sensor center is 10 mm (in z) above the top of the dipole arms. Two 3D maxima are available near the end of the dipole arms. Assuming the dipole arms are perfectly in one line, the average of these two maxima (in subgrid 2 and subgrid 8) is determined to compensate for any non-parallelity to the measurement plane as well as the sensor displacement. The E-field value stated as calibration value represents the maximum of the interpolated 3D-E-field, 10mm above the dipole surface.
- *H-field distribution:* H-field is measured with an isotropic H-field probe with 100mW forward power to the antenna feed point, in the x-y-plane. The scan area and sensor distance is equivalent to the E-field scan. The maximum of the field is available at the center (subgrid 5) above the feed point. The H-field value stated as calibration value represents the maximum of the interpolated H-field, 10mm above the dipole surface at the feed point.

The reported uncertainty of measurement is stated as the standard uncertainty of measurement multiplied by the coverage factor $k=2$, which for a normal distribution corresponds to a coverage probability of approximately 95%.

Measurement Conditions

DASY system configuration, as far as not given on page 1.

DASY Version	DASY5	V52.8.0
Extrapolation	Advanced Extrapolation	
Phantom	HAC Test Arch	
Distance Dipole Top - Probe Center	10mm	
Scan resolution	dx, dy = 5 mm	
Frequency	835 MHz \pm 1 MHz	
Input power drift	< 0.05 dB	

Maximum Field values at 835 MHz

H-field 10 mm above dipole surface	condition	interpolated maximum
Maximum measured	100 mW input power	0.455 A / m \pm 8.2 % (k=2)

E-field 10 mm above dipole surface	condition	Interpolated maximum
Maximum measured above high end	100 mW input power	163.6 V / m
Maximum measured above low end	100 mW input power	159.3 V / m
Averaged maximum above arm	100 mW input power	161.5 V / m \pm 12.8 % (k=2)

Appendix

Antenna Parameters

Frequency	Return Loss	Impedance
800 MHz	15.7 dB	42.5 Ω - 13.5 j Ω
835 MHz	28.7 dB	48.0 Ω + 3.0 j Ω
900 MHz	16.6 dB	57.5 Ω - 14.1 j Ω
950 MHz	17.3 dB	45.3 Ω + 12.2 j Ω
960 MHz	13.0 dB	56.0 Ω + 23.6 j Ω

3.2 Antenna Design and Handling

The calibration dipole has a symmetric geometry with a built-in two stub matching network, which leads to the enhanced bandwidth.

The dipole is built of standard semirigid coaxial cable. The internal matching line is open ended. The antenna is therefore open for DC signals.

Do not apply force to dipole arms, as they are liable to bend. The soldered connections near the feedpoint may be damaged. After excessive mechanical stress or overheating, check the impedance characteristics to ensure that the internal matching network is not affected.

After long term use with 40W radiated power, only a slight warming of the dipole near the feedpoint can be measured.

Impedance Measurement Plot

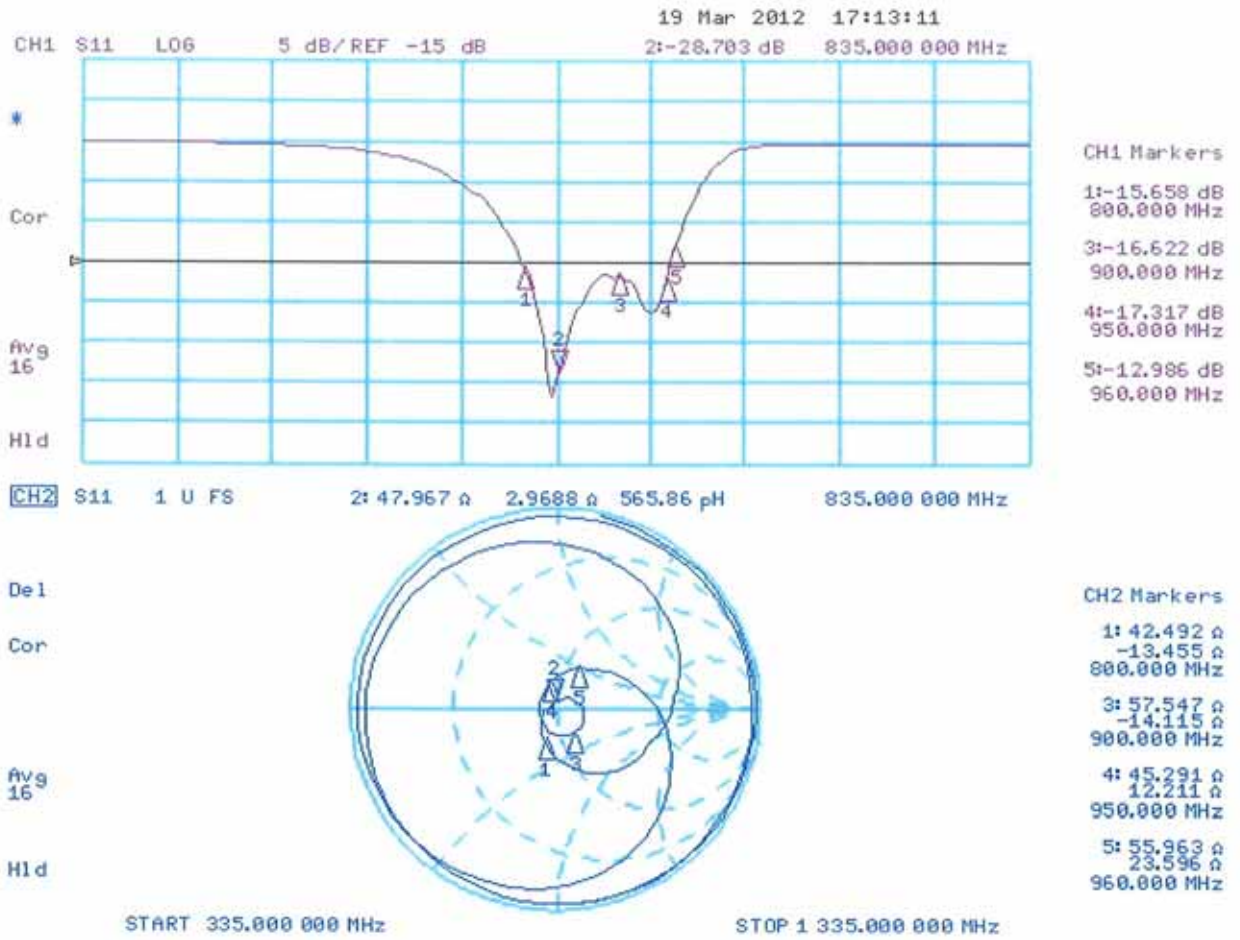

DASY5 H-field Result

Date: 19.03.2012

Test Laboratory: SPEAG Lab2

DUT: HAC-Dipole 835 MHz; Type: CD835V3; Serial: CD835V3 - SN: 1041

Communication System: CW; Frequency: 835 MHz

Medium parameters used: $\sigma = 0$ mho/m, $\epsilon_r = 1$; $\rho = 1$ kg/m³

Phantom section: RF Section

Measurement Standard: DASY5 (IEEE/IEC/ANSI C63.19-2007)

DASY52 Configuration:

- Probe: H3DV6 - SN6065; ; Calibrated: 29.12.2011
- Sensor-Surface: (Fix Surface)
- Electronics: DAE4 Sn781; Calibrated: 20.04.2011
- Phantom: HAC Test Arch with AMCC; Type: SD HAC P01 BA; Serial: 1070
- DASY52 52.8.0(692); SEMCAD X 14.6.4(4989)

Dipole H-Field measurement @ 835MHz/H-Scan - 835MHz d=10mm/Hearing Aid Compatibility Test (41x361x1):

Measurement grid: dx=5mm, dy=5mm

Device Reference Point: 0, 0, -6.3 mm

Reference Value = 0.48 V/m; Power Drift = -0.00 dB

PMR not calibrated. PMF = 1.000 is applied.

H-field emissions = 0.46 A/m

Near-field category: M4 (AWF 0 dB)

PMF scaled H-field

Grid 1 M4	Grid 2 M4	Grid 3 M4
0.37 A/m	0.40 A/m	0.39 A/m
Grid 4 M4	Grid 5 M4	Grid 6 M4
0.42 A/m	0.46 A/m	0.44 A/m
Grid 7 M4	Grid 8 M4	Grid 9 M4
0.36 A/m	0.40 A/m	0.39 A/m

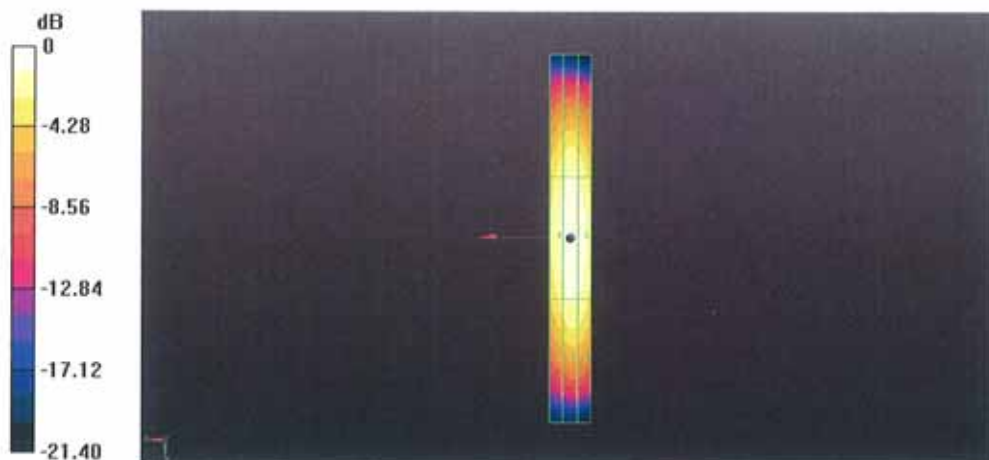

DASY5 E-field Result

Date: 19.03.2012

Test Laboratory: SPEAG Lab2

DUT: HAC-Dipole 835 MHz; Type: CD835V3; Serial: CD835V3 - SN: 1041

Communication System: CW; Frequency: 835 MHz
 Medium parameters used: $\sigma = 0$ mho/m, $\epsilon_r = 1$; $\rho = 1000$ kg/m³
 Phantom section: RF Section
 Measurement Standard: DASY5 (IEEE/IEC/ANSI C63.19-2007)

DASY52 Configuration:

- Probe: ER3DV6 - SN2336; ConvF(1, 1, 1); Calibrated: 29.12.2011
- Sensor-Surface: (Fix Surface)
- Electronics: DAE4 Sn781; Calibrated: 20.04.2011
- Phantom: HAC Test Arch with AMCC; Type: SD HAC P01 BA; Serial: 1070
- DASY52 52.8.0(692); SEMCAD X 14.6.4(4989)

Dipole E-Field measurement @ 835MHz/E-Scan - 835MHz d=10mm/Hearing Aid Compatibility Test (41x361x1):

Measurement grid: dx=5mm, dy=5mm
 Device Reference Point: 0, 0, -6.3 mm
 Reference Value = 106.2 V/m; Power Drift = 0.00 dB
 PMR not calibrated. PMF = 1.000 is applied.
 E-field emissions = 163.6 V/m
Near-field category: M4 (AWF 0 dB)

PMF scaled E-field

Grid 1 M4	Grid 2 M4	Grid 3 M4
155.3 V/m	159.3 V/m	154.2 V/m
Grid 4 M4	Grid 5 M4	Grid 6 M4
84.98 V/m	87.25 V/m	85.11 V/m
Grid 7 M4	Grid 8 M4	Grid 9 M4
150.4 V/m	163.6 V/m	163.2 V/m

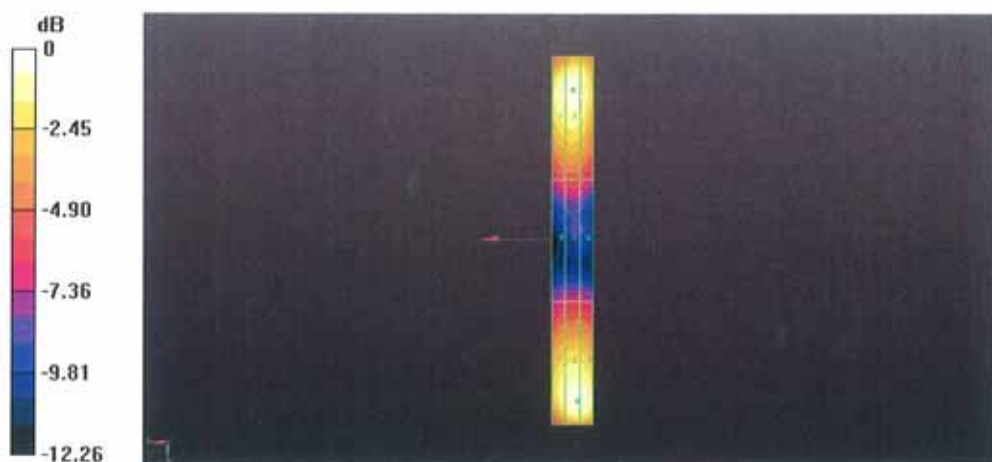

0 dB = 163.6V/m = 44.28 dB V/m



Accredited by the Swiss Accreditation Service (SAS)
The Swiss Accreditation Service is one of the signatories to the EA
Multilateral Agreement for the recognition of calibration certificates

Accreditation No.: **SCS 108**

Client **B.V. ADT (Auden)**

Certificate No: **CD1880V3-1032_Apr12**

CALIBRATION CERTIFICATE

Object **CD1880V3 - SN: 1032**

Calibration procedure(s) **QA CAL-20.v6
Calibration procedure for dipoles in air**

Calibration date: **April 26, 2012**

This calibration certificate documents the traceability to national standards, which realize the physical units of measurements (SI).
The measurements and the uncertainties with confidence probability are given on the following pages and are part of the certificate.

All calibrations have been conducted in the closed laboratory facility: environment temperature (22 ± 3)°C and humidity < 70%.

Calibration Equipment used (M&TE critical for calibration)

Primary Standards	ID #	Cal Date (Certificate No.)	Scheduled Calibration
Power meter EPM-442A	GB37480704	05-Oct-11 (No. 217-01451)	Oct-12
Power sensor HP 8481A	US37292783	05-Oct-11 (No. 217-01451)	Oct-12
Probe ER3DV6	SN: 2336	29-Dec-11 (No. ER3-2336_Dec11)	Dec-12
Probe H3DV6	SN: 6065	29-Dec-11 (No. H3-6065_Dec11)	Dec-12
DAE4	SN: 781	25-Apr-12 (No. DAE4-781_Apr12)	Apr-13

Secondary Standards	ID #	Check Date (in house)	Scheduled Check
Power meter Agilent 4419B	SN: GB42420191	09-Oct-09 (in house check Oct-11)	In house check: Oct-12
Power sensor HP 8482H	SN: 3318A09450	09-Oct-09 (in house check Oct-11)	In house check: Oct-12
Power sensor HP 8482A	SN: US37295597	09-Oct-09 (in house check Oct-11)	In house check: Oct-12
Network Analyzer HP 8753E	US37390585	18-Oct-01 (in house check Oct-11)	In house check: Oct-12
RF generator E4433B	MY 41000675	03-Nov-04 (in house check Oct-11)	In house check: Oct-13

Calibrated by:	Name Claudio Leubler	Function Laboratory Technician	Signature
Approved by:	Name Fin Bornholt	Function R&D Director	

Issued: April 27, 2012

This calibration certificate shall not be reproduced except in full without written approval of the laboratory.



Accredited by the Swiss Accreditation Service (SAS)
The Swiss Accreditation Service is one of the signatories to the EA
Multilateral Agreement for the recognition of calibration certificates

Accreditation No.: **SCS 108**

References

- [1] ANSI-C63.19-2007
American National Standard for Methods of Measurement of Compatibility between Wireless Communications Devices and Hearing Aids.
- [2] ANSI-C63.19-2011
American National Standard, Methods of Measurement of Compatibility between Wireless Communications Devices and Hearing Aids.

Methods Applied and Interpretation of Parameters:

- *Coordinate System:* y-axis is in the direction of the dipole arms. z-axis is from the basis of the antenna (mounted on the table) towards its feed point between the two dipole arms. x-axis is normal to the other axes. In coincidence with the standards [1], the measurement planes (probe sensor center) are selected to be at a distance of 10 mm (15 mm for [2]) above the top metal edge of the dipole arms.
- *Measurement Conditions:* Further details are available from the hardcopies at the end of the certificate. All figures stated in the certificate are valid at the frequency indicated. The forward power to the dipole connector is set with a calibrated power meter connected and monitored with an auxiliary power meter connected to a directional coupler. While the dipole under test is connected, the forward power is adjusted to the same level.
- *Antenna Positioning:* The dipole is mounted on a HAC Test Arch phantom using the matching dipole positioner with the arms horizontal and the feeding cable coming from the floor. The measurements are performed in a shielded room with absorbers around the setup to reduce the reflections. It is verified before the mounting of the dipole under the Test Arch phantom, that its arms are perfectly in a line. It is installed on the HAC dipole positioner with its arms parallel below the dielectric reference wire and able to move elastically in vertical direction without changing its relative position to the top center of the Test Arch phantom. The vertical distance to the probe is adjusted after dipole mounting with a DASY5 Surface Check job. Before the measurement, the distance between phantom surface and probe tip is verified. The proper measurement distance is selected by choosing the matching section of the HAC Test Arch phantom with the proper device reference point (upper surface of the dipole) and the matching grid reference point (tip of the probe) considering the probe sensor offset. The vertical distance to the probe is essential for the accuracy.
- *Feed Point Impedance and Return Loss:* These parameters are measured using a HP 8753E Vector Network Analyzer. The impedance is specified at the SMA connector of the dipole. The influence of reflections was eliminating by applying the averaging function while moving the dipole in the air, at least 70cm away from any obstacles.
- *E-field distribution:* E field is measured in the x-y-plane with an isotropic ER3D-field probe with 100 mW forward power to the antenna feed point. In accordance with [1] and [2], the scan area is 20mm wide, its length exceeds the dipole arm length (180 or 90mm). The sensor center is 10 mm (15 mm for [2]) (in z) above the metal top of the dipole arms. Two 3D maxima are available near the end of the dipole arms. Assuming the dipole arms are perfectly in one line, the average of these two maxima (in subgrid 2 and subgrid 8) is determined to compensate for any non-parallelity to the measurement plane as well as the sensor displacement. The E-field value stated as calibration value represents the maximum of the interpolated 3D-E-field, in the plane above the dipole surface.
- *H-field distribution:* H-field is measured with an isotropic H-field probe with 100mW forward power to the antenna feed point, in the x-y-plane. The scan area and sensor distance is equivalent to the E-field scan. The maximum of the field is available at the center (subgrid 5) above the feed point. The H-field value stated as calibration value represents the maximum of the interpolated H-field, 10mm above the dipole surface at the feed point.

Measurement Conditions

DASY system configuration, as far as not given on page 1.

DASY Version	DASY5	V52.8.1
Extrapolation	Advanced Extrapolation	
Phantom	HAC Test Arch	
Distance Dipole Top - Probe Center	10mm 15mm	
Scan resolution	dx, dy = 5 mm	
Frequency	1880 MHz \pm 1 MHz	
Input power drift	< 0.05 dB	

Maximum Field values at 1880 MHz

H-field 10 mm above dipole surface	condition	interpolated maximum
Maximum measured	100 mW input power	0.461 A / m \pm 8.2 % (k=2)

E-field 10 mm above dipole surface	condition	Interpolated maximum
Maximum measured above high end	100 mW input power	142.2 V / m
Maximum measured above low end	100 mW input power	138.0 V / m
Averaged maximum above arm	100 mW input power	140.1 V / m \pm 12.8 % (k=2)

E-field 15 mm above dipole surface	condition	Interpolated maximum
Maximum measured above high end	100 mW input power	88.6 V / m
Maximum measured above low end	100 mW input power	87.8 V / m
Averaged maximum above arm	100 mW input power	88.2 V / m \pm 12.8 % (k=2)

The reported uncertainty of measurement is stated as the standard uncertainty of measurement multiplied by the coverage factor k=2, which for a normal distribution corresponds to a coverage probability of approximately 95%.

Appendix

Antenna Parameters

Frequency	Return Loss	Impedance
1730 MHz	24.9 dB	$50.9 \Omega + 5.7 j\Omega$
1880 MHz	20.8 dB	$51.6 \Omega + 9.2 j\Omega$
1900 MHz	21.0 dB	$54.4 \Omega + 8.2 j\Omega$
1950 MHz	27.6 dB	$54.3 \Omega + 0.6 j\Omega$
2000 MHz	21.8 dB	$42.8 \Omega + 2.2 j\Omega$

3.2 Antenna Design and Handling

The calibration dipole has a symmetric geometry with a built-in two stub matching network, which leads to the enhanced bandwidth.

The dipole is built of standard semirigid coaxial cable. The internal matching line is open ended. The antenna is therefore open for DC signals.

Do not apply force to dipole arms, as they are liable to bend. The soldered connections near the feedpoint may be damaged. After excessive mechanical stress or overheating, check the impedance characteristics to ensure that the internal matching network is not affected.

After long term use with 40W radiated power, only a slight warming of the dipole near the feedpoint can be measured.

Impedance Measurement Plot

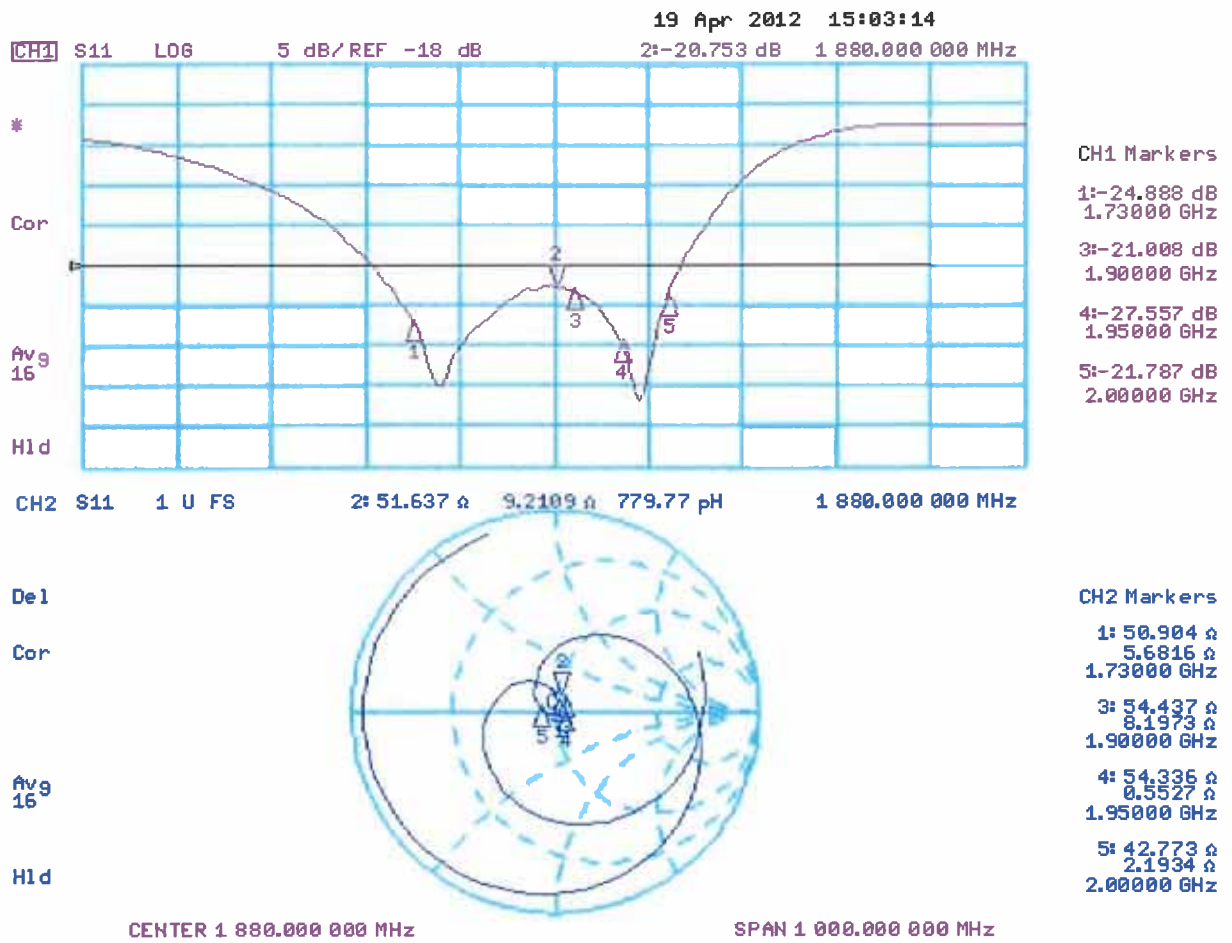

Dipole E-Field measurement @ 1880MHz/E-Scan - 1880MHz d=15mm/Hearing Aid Compatibility Test (41x181x1):

Measurement grid: dx=5mm, dy=5mm

Device Reference Point: 0, 0, -6.3 mm

Reference Value = 157.1 V/m; Power Drift = -0.00 dB

PMR not calibrated. PMF = 1.000 is applied.

E-field emissions = 87.77 V/m

Near-field category: M3 (AWF 0 dB)

PMF scaled E-field

Grid 1 M3 86.19 V/m	Grid 2 M3 87.77 V/m	Grid 3 M3 86.19 V/m
Grid 4 M3 67.85 V/m	Grid 5 M3 68.46 V/m	Grid 6 M3 67.31 V/m
Grid 7 M3 87.74 V/m	Grid 8 M3 88.63 V/m	Grid 9 M3 86.31 V/m

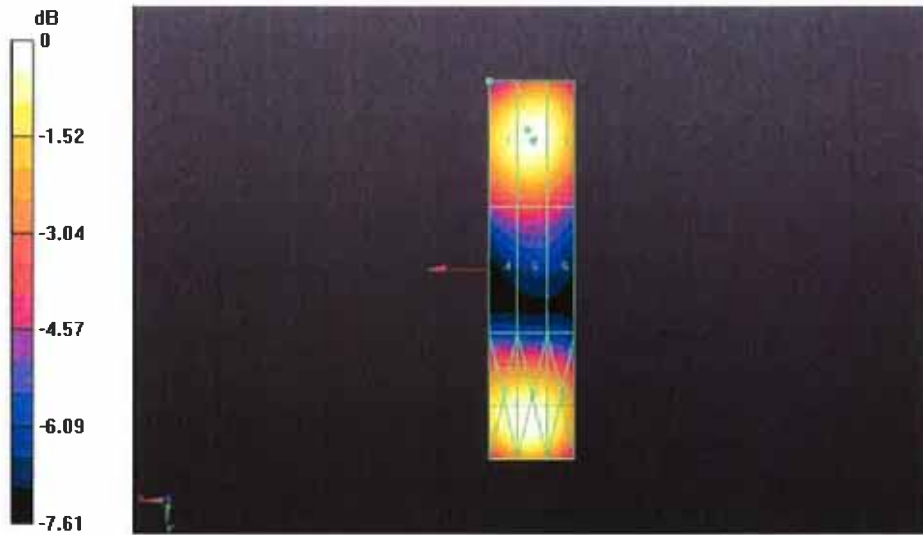

0 dB = 142.2 V/m = 43.06 dB V/m



Accredited by the Swiss Accreditation Service (SAS)
The Swiss Accreditation Service is one of the signatories to the EA
Multilateral Agreement for the recognition of calibration certificates

Accreditation No.: **SCS 108**

Client **B. V. ADT (Auden)**

Certificate No: **ER3-2445_Feb12**

CALIBRATION CERTIFICATE

Object **ER3DV6 - SN:2445**

Calibration procedure(s) **QA CAL-02.v6, QA CAL-25.v4
Calibration procedure for E-field probes optimized for close near field
evaluations in air**

Calibration date: **February 17, 2012**

This calibration certificate documents the traceability to national standards, which realize the physical units of measurements (SI).
The measurements and the uncertainties with confidence probability are given on the following pages and are part of the certificate.

All calibrations have been conducted in the closed laboratory facility: environment temperature (22 ± 3)°C and humidity < 70%.

Calibration Equipment used (M&TE critical for calibration)

Primary Standards	ID	Cal Date (Certificate No.)	Scheduled Calibration
Power meter E4419B	GB41293874	31-Mar-11 (No. 217-01372)	Apr-12
Power sensor E4412A	MY41498087	31-Mar-11 (No. 217-01372)	Apr-12
Reference 3 dB Attenuator	SN: S5054 (3c)	29-Mar-11 (No. 217-01369)	Apr-12
Reference 20 dB Attenuator	SN: S5086 (20b)	29-Mar-11 (No. 217-01367)	Apr-12
Reference 30 dB Attenuator	SN: S5129 (30b)	29-Mar-11 (No. 217-01370)	Apr-12
Reference Probe ER3DV6	SN: 2328	11-Oct-11 (No. ER3-2328_Oct11)	Oct-12
DAE4	SN: 789	30-Jan-12 (No. DAE4-789_Jan12)	Jan-13
Secondary Standards	ID	Check Date (in house)	Scheduled Check
RF generator HP 8648C	US3642U01700	4-Aug-99 (in house check Apr-11)	In house check: Apr-13
Network Analyzer HP 8753E	US37390585	18-Oct-01 (in house check Oct-11)	In house check: Oct-12

	Name	Function	Signature
Calibrated by:	Jeton Kastrati	Laboratory Technician	
Approved by:	Katja Pokovic	Technical Manager	
			Issued: February 22, 2012

This calibration certificate shall not be reproduced except in full without written approval of the laboratory.



Accredited by the Swiss Accreditation Service (SAS)

Accreditation No.: **SCS 108**

The Swiss Accreditation Service is one of the signatories to the EA
Multilateral Agreement for the recognition of calibration certificates

Glossary:

NORM _{x,y,z}	sensitivity in free space
DCP	diode compression point
CF	crest factor (1/duty_cycle) of the RF signal
A, B, C	modulation dependent linearization parameters
Polarization φ	φ rotation around probe axis
Polarization ϑ	ϑ rotation around an axis that is in the plane normal to probe axis (at measurement center), i.e., $\vartheta = 0$ is normal to probe axis
Connector Angle	information used in DASY system to align probe sensor X to the robot coordinate system

Calibration is Performed According to the Following Standards:

- IEEE Std 1309-2005, "IEEE Standard for calibration of electromagnetic field sensors and probes, excluding antennas, from 9 kHz to 40 GHz", December 2005.

Methods Applied and Interpretation of Parameters:

- NORM_{x,y,z}*: Assessed for E-field polarization $\vartheta = 0$ for XY sensors and $\vartheta = 90$ for Z sensor ($f \leq 900$ MHz in TEM-cell; $f > 1800$ MHz: R22 waveguide).
- NORM(f)_{x,y,z}* = *NORM_{x,y,z}* * *frequency_response* (see Frequency Response Chart).
- DCP_{x,y,z}*: DCP are numerical linearization parameters assessed based on the data of power sweep with CW signal (no uncertainty required). DCP does not depend on frequency nor media.
- PAR*: PAR is the Peak to Average Ratio that is not calibrated but determined based on the signal characteristics
- A_{x,y,z}; B_{x,y,z}; C_{x,y,z}; VR_{x,y,z}*: A, B, C are numerical linearization parameters assessed based on the data of power sweep for specific modulation signal. The parameters do not depend on frequency nor media. VR is the maximum calibration range expressed in RMS voltage across the diode.
- Spherical isotropy (3D deviation from isotropy)*: in a locally homogeneous field realized using an open waveguide setup.
- Sensor Offset*: The sensor offset corresponds to the offset of virtual measurement center from the probe tip (on probe axis). No tolerance required.
- Connector Angle*: The angle is assessed using the information gained by determining the *NORM_x* (no uncertainty required).

Probe ER3DV6

SN:2445

Manufactured: January 22, 2008
Calibrated: February 17, 2012

Calibrated for DASY/EASY Systems
(Note: non-compatible with DASY2 system!)

DASY/EASY - Parameters of Probe: ER3DV6 - SN:2445

Basic Calibration Parameters

	Sensor X	Sensor Y	Sensor Z	Unc (k=2)
Norm ($\mu\text{V}/(\text{V}/\text{m})^2$)	1.47	1.69	1.82	$\pm 10.1 \%$
DCP (mV) ^B	99.1	99.0	102.5	

Modulation Calibration Parameters

UID	Communication System Name	PAR		A dB	B dB	C dB	VR mV	Unc ^E (k=2)
10000	CW	0.00	X	0.00	0.00	1.00	102.1	$\pm 2.7 \%$
			Y	0.00	0.00	1.00	88.3	
			Z	0.00	0.00	1.00	109.2	
10011	UMTS-FDD (WCDMA)	3.40	X	3.36	64.9	17.8	110.1	$\pm 0.9 \%$
			Y	3.56	66.2	18.8	130.2	
			Z	3.46	65.9	18.4	117.2	
10021	GSM-FDD (TDMA, GMSK)	9.40	X	17.21	99.7	28.7	147.3	$\pm 2.5 \%$
			Y	14.07	99.7	29.3	115.6	
			Z	20.54	99.8	28.5	120.2	
10039	CDMA2000 (1xRTT, RC1)	4.57	X	4.52	65.5	18.5	111.5	$\pm 0.7 \%$
			Y	4.77	66.9	19.5	131.9	
			Z	4.52	66.1	18.8	117.5	
10056	UMTS-TDD (TD-SCDMA, 1.28 Mcps)	11.01	X	12.20	98.8	38.5	116.8	$\pm 1.9 \%$
			Y	11.19	99.1	39.5	130.5	
			Z	14.41	99.8	37.5	133.6	
10081	CDMA2000 (1xRTT, RC3)	3.96	X	3.74	65.0	18.2	108.7	$\pm 0.7 \%$
			Y	3.89	65.9	18.8	128.1	
			Z	3.80	65.8	18.6	115.1	
10082	IS-54 / IS-136 FDD (TDMA/FDM, PI/4-DQPSK, Fullrate)	4.77	X	34.62	99.7	23.0	146.7	$\pm 2.5 \%$
			Y	31.16	99.9	23.2	120.4	
			Z	62.19	99.9	21.9	115.1	
10100	LTE-FDD (SC-FDMA, 100% RB, 20 MHz, QPSK)	5.66	X	6.32	67.2	19.7	125.0	$\pm 1.9 \%$
			Y	6.73	68.9	21.0	146.5	
			Z	6.33	67.4	19.9	130.8	
10101	LTE-FDD (SC-FDMA, 100% RB, 20 MHz, 16-QAM)	6.41	X	7.56	68.1	20.6	132.2	$\pm 2.5 \%$
			Y	7.40	67.7	20.5	110.4	
			Z	7.48	68.1	20.5	140.9	
10108	LTE-FDD (SC-FDMA, 100% RB, 10 MHz, QPSK)	5.79	X	6.28	67.1	19.9	121.8	$\pm 2.2 \%$
			Y	6.61	68.6	21.0	144.1	
			Z	6.23	67.2	19.9	129.4	

10109	LTE-FDD (SC-FDMA, 100% RB, 10 MHz, 16-QAM)	6.42	X	7.29	67.8	20.5	128.9	±2.5 %
			Y	7.15	67.4	20.4	108.0	
			Z	7.20	67.7	20.4	136.4	
10110	LTE-FDD (SC-FDMA, 100% RB, 5 MHz, QPSK)	5.75	X	5.98	66.6	19.7	118.9	±1.7 %
			Y	6.24	67.9	20.6	140.7	
			Z	5.88	66.6	19.6	125.6	
10111	LTE-FDD (SC-FDMA, 100% RB, 5 MHz, 16-QAM)	6.44	X	7.06	67.6	20.5	125.3	±3.0 %
			Y	7.37	69.0	21.5	148.3	
			Z	6.94	67.6	20.3	132.5	
10148	LTE-FDD (SC-FDMA, 50% RB, 20 MHz, QPSK)	5.83	X	6.31	67.0	19.9	122.2	±1.9 %
			Y	6.68	68.6	21.0	144.9	
			Z	6.27	67.1	19.9	129.4	
10149	LTE-FDD (SC-FDMA, 50% RB, 20 MHz, 16-QAM)	6.42	X	7.33	67.9	20.6	129.0	±2.5 %
			Y	7.17	67.4	20.5	108.3	
			Z	7.17	67.6	20.3	136.5	
10154	LTE-FDD (SC-FDMA, 50% RB, 10 MHz, QPSK)	5.76	X	5.92	66.3	19.5	119.1	±1.7 %
			Y	6.22	67.8	20.5	140.9	
			Z	5.87	66.5	19.5	125.8	
10155	LTE-FDD (SC-FDMA, 50% RB, 10 MHz, 16-QAM)	6.43	X	6.91	66.9	19.9	125.5	±1.9 %
			Y	7.20	68.2	20.8	148.9	
			Z	6.92	67.4	20.2	132.5	
10156	LTE-FDD (SC-FDMA, 50% RB, 5 MHz, QPSK)	5.79	X	5.73	66.1	19.5	116.4	±1.9 %
			Y	6.03	67.6	20.5	137.2	
			Z	5.66	66.3	19.5	122.9	
10157	LTE-FDD (SC-FDMA, 50% RB, 5 MHz, 16-QAM)	6.49	X	6.79	67.4	20.5	121.0	±2.5 %
			Y	6.93	68.0	20.8	143.2	
			Z	6.65	67.3	20.2	127.4	
10160	LTE-FDD (SC-FDMA, 50% RB, 15 MHz, QPSK)	5.81	X	6.39	67.1	19.9	123.4	±2.2 %
			Y	6.73	68.6	20.9	146.6	
			Z	6.31	67.1	19.8	130.7	
10161	LTE-FDD (SC-FDMA, 50% RB, 15 MHz, 16-QAM)	6.42	X	7.25	67.3	20.1	130.2	±2.2 %
			Y	7.27	67.7	20.6	108.6	
			Z	7.21	67.7	20.3	137.3	
10163	LTE-FDD (SC-FDMA, 50% RB, 3 MHz, QPSK)	5.68	X	5.55	66.0	19.4	115.2	±1.7 %
			Y	5.87	67.6	20.5	135.6	
			Z	5.48	66.2	19.3	121.5	
10164	LTE-FDD (SC-FDMA, 50% RB, 3 MHz, 16-QAM)	6.44	X	6.50	66.6	19.8	119.4	±1.9 %
			Y	6.84	68.3	21.0	140.6	
			Z	6.57	67.6	20.4	125.9	

10166	LTE-FDD (SC-FDMA, 50% RB, 1.4 MHz, QPSK)	5.45	X	4.91	65.5	19.0	109.7	±1.2 %
			Y	5.17	67.0	20.1	128.4	
			Z	4.95	66.1	19.3	116.5	
10167	LTE-FDD (SC-FDMA, 50% RB, 1.4 MHz, 16-QAM)	6.21	X	5.92	67.0	20.0	112.3	±2.2 %
			Y	6.21	68.6	21.2	131.3	
			Z	5.87	67.2	20.1	118.4	
10042	IS-54 / IS-136 FDD (TDMA/FDM, PI/4-DQPSK, Halfrate)	7.78	X	5.88	73.4	17.3	141.1	±4.1 %
			Y	32.95	99.5	25.8	114.1	
			Z	10.44	80.1	20.1	118.5	

The reported uncertainty of measurement is stated as the standard uncertainty of measurement multiplied by the coverage factor $k=2$, which for a normal distribution corresponds to a coverage probability of approximately 95%.

^B Numerical linearization parameter: uncertainty not required.

^E Uncertainty is determined using the max. deviation from linear response applying rectangular distribution and is expressed for the square of the field value.

Frequency Response of E-Field

(TEM-Cell:ifi110 EXX, Waveguide: R22)

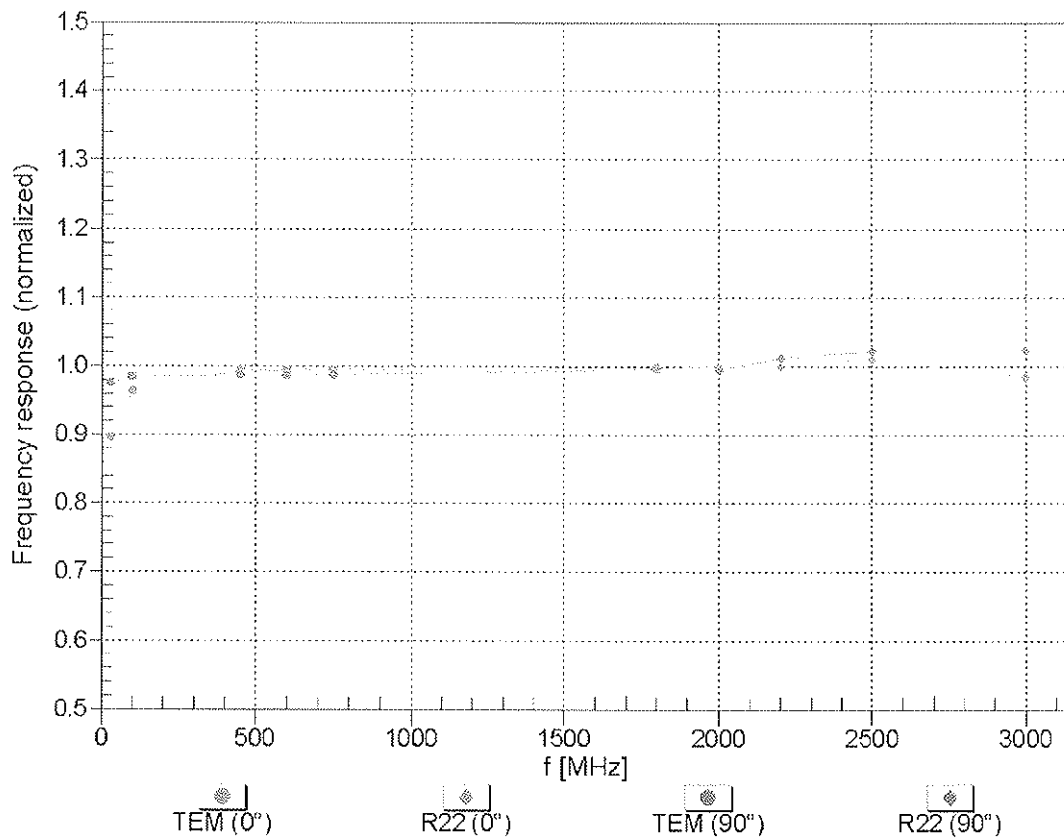

Uncertainty of Frequency Response of E-field: $\pm 6.3\%$ ($k=2$)

Receiving Pattern (ϕ), $\vartheta = 0^\circ$

f=600 MHz,TEM,0°

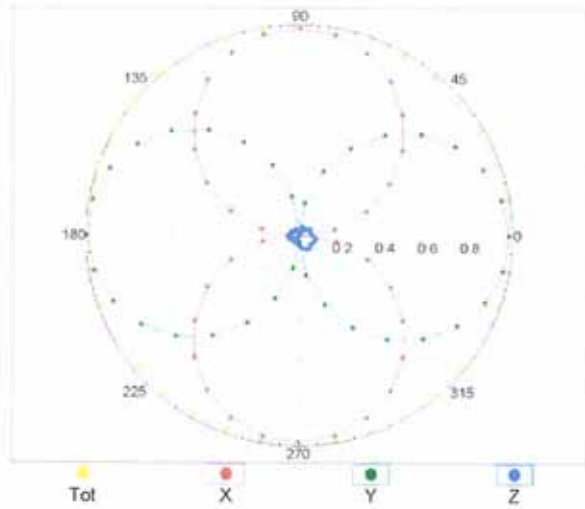

f=2500 MHz,R22,0°

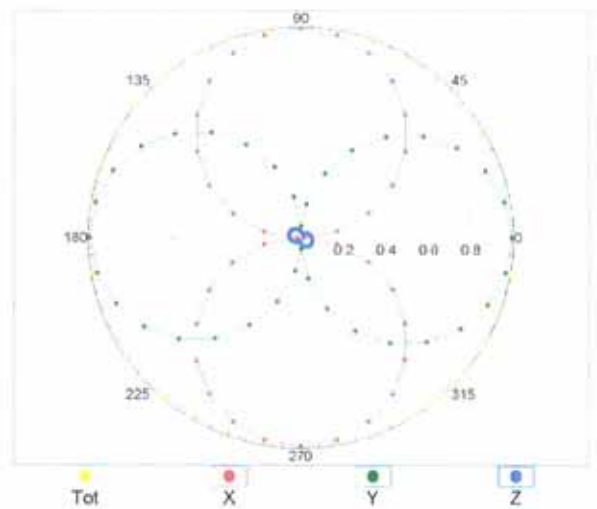

Receiving Pattern (ϕ), $\vartheta = 90^\circ$

f=600 MHz,TEM,90°

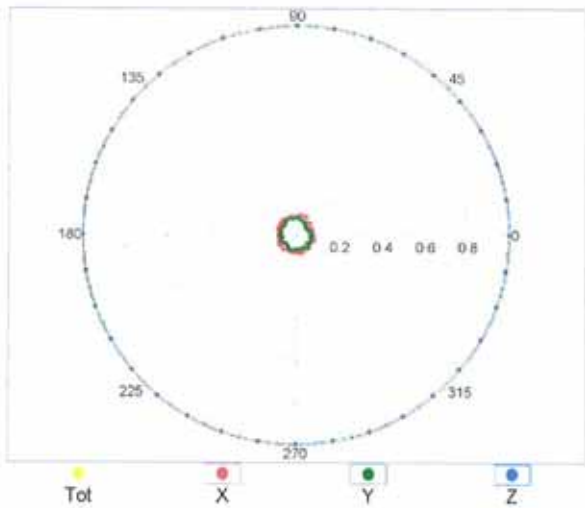

f=2500 MHz,R22,90°

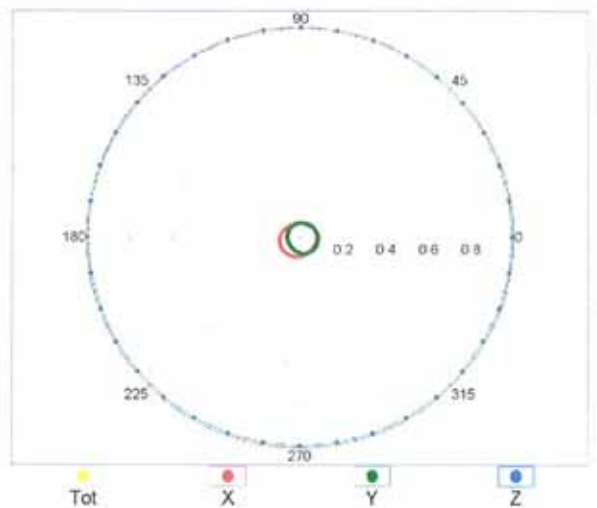

Receiving Pattern (ϕ), $\vartheta = 0^\circ$



Uncertainty of Axial Isotropy Assessment: $\pm 0.5\%$ (k=2)

Receiving Pattern (ϕ), $\vartheta = 90^\circ$

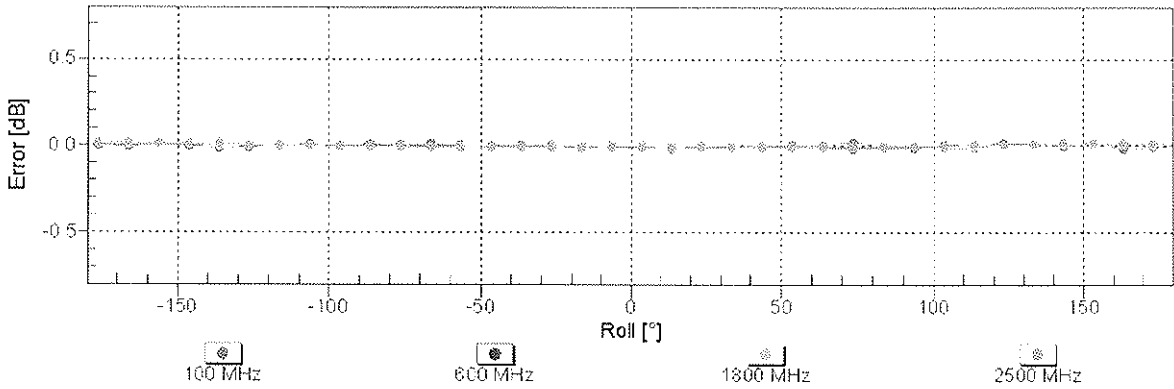

Uncertainty of Axial Isotropy Assessment: $\pm 0.5\%$ (k=2)

Dynamic Range f(E-field)

(TEM cell , f = 900 MHz)

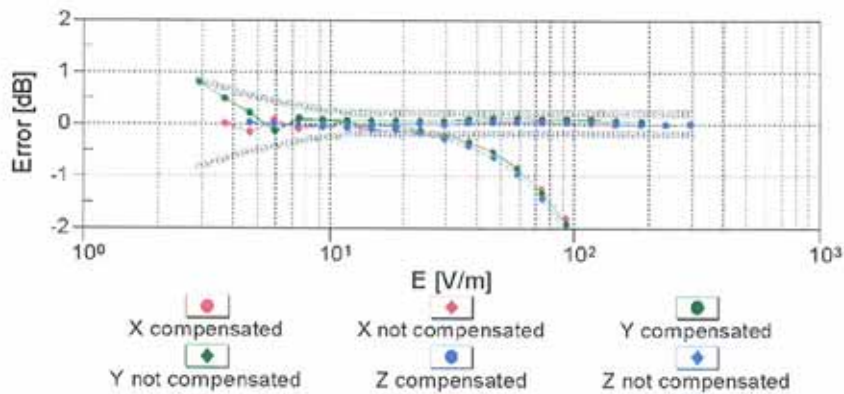
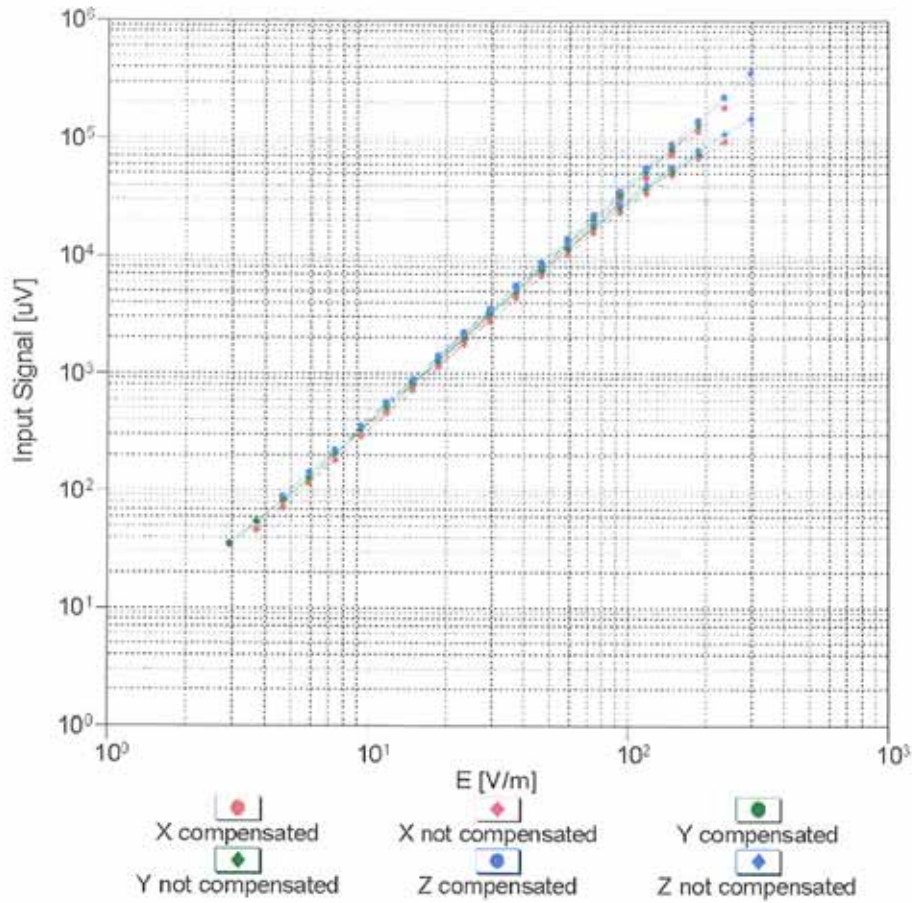

Uncertainty of Linearity Assessment: ± 0.6% (k=2)

Deviation from Isotropy in Air Error (ϕ, ϑ), $f = 900$ MHz

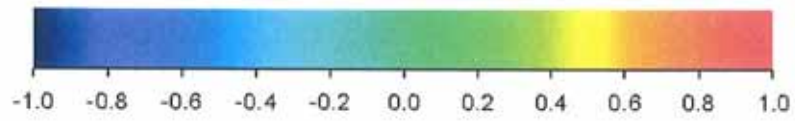
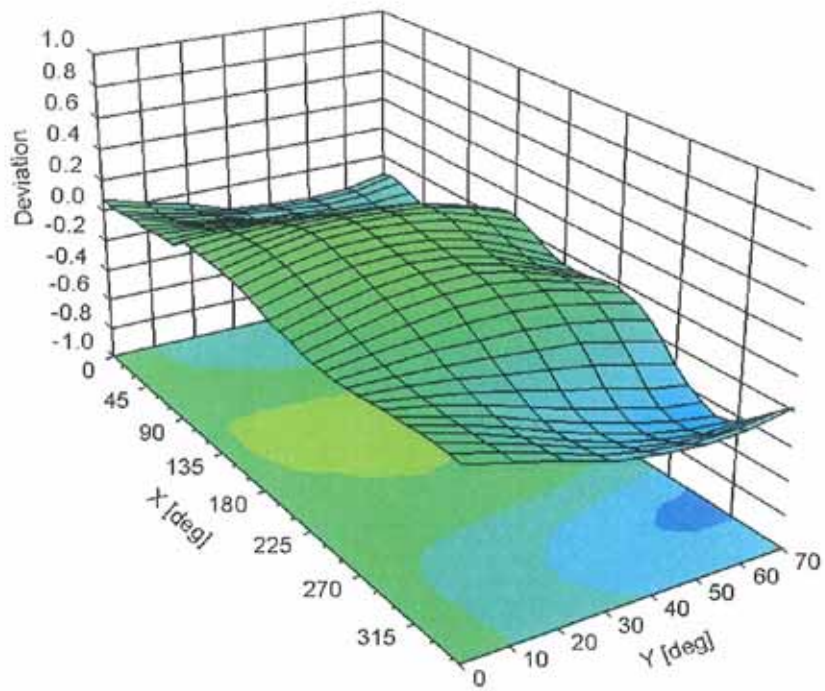

Uncertainty of Spherical Isotropy Assessment: $\pm 2.6\%$ ($k=2$)

DASY/EASY - Parameters of Probe: ER3DV6 - SN:2445

Other Probe Parameters

Sensor Arrangement	Rectangular
Connector Angle (°)	43.6
Mechanical Surface Detection Mode	enabled
Optical Surface Detection Mode	disabled
Probe Overall Length	337 mm
Probe Body Diameter	10 mm
Tip Length	10 mm
Tip Diameter	8 mm
Probe Tip to Sensor X Calibration Point	2.5 mm
Probe Tip to Sensor Y Calibration Point	2.5 mm
Probe Tip to Sensor Z Calibration Point	2.5 mm



Accredited by the Swiss Accreditation Service (SAS)
The Swiss Accreditation Service is one of the signatories to the EA
Multilateral Agreement for the recognition of calibration certificates

Accreditation No.: **SCS 108**

Client **B. V. ADT (Auden)**

Certificate No: **H3-6274_Feb12**

CALIBRATION CERTIFICATE

Object **H3DV6 - SN:6274**

Calibration procedure(s) **QA CAL-03.v6, QA CAL-25.v4
Calibration procedure for H-field probes optimized for close near field
evaluations in air**

Calibration date: **February 17, 2012**

This calibration certificate documents the traceability to national standards, which realize the physical units of measurements (SI).
The measurements and the uncertainties with confidence probability are given on the following pages and are part of the certificate.

All calibrations have been conducted in the closed laboratory facility: environment temperature (22 ± 3)°C and humidity < 70%.

Calibration Equipment used (M&TE critical for calibration)

Primary Standards	ID	Cal Date (Certificate No.)	Scheduled Calibration
Power meter E4419B	GB41293874	31-Mar-11 (No. 217-01372)	Apr-12
Power sensor E4412A	MY41498087	31-Mar-11 (No. 217-01372)	Apr-12
Reference 3 dB Attenuator	SN: S5054 (3c)	29-Mar-11 (No. 217-01369)	Apr-12
Reference 20 dB Attenuator	SN: S5086 (20b)	29-Mar-11 (No. 217-01367)	Apr-12
Reference 30 dB Attenuator	SN: S5129 (30b)	29-Mar-11 (No. 217-01370)	Apr-12
Reference Probe H3DV6	SN: 6182	11-Oct-11 (No. H3-6182_Oct11)	Oct-12
DAE4	SN: 789	30-Jan-12 (No. DAE4-789_Jan12)	Jan-13
Secondary Standards	ID	Check Date (in house)	Scheduled Check
RF generator HP 8648C	US3642U01700	4-Aug-99 (in house check Apr-11)	In house check: Apr-13
Network Analyzer HP 8753E	US37390585	18-Oct-01 (in house check Oct-11)	In house check: Oct-12

	Name	Function	Signature
Calibrated by:	Jeton Kastrati	Laboratory Technician	
Approved by:	Katja Pokovic	Technical Manager	

Issued: February 22, 2012

This calibration certificate shall not be reproduced except in full without written approval of the laboratory.



Accredited by the Swiss Accreditation Service (SAS)
The Swiss Accreditation Service is one of the signatories to the EA
Multilateral Agreement for the recognition of calibration certificates

Accreditation No.: **SCS 108**

Glossary:

NORM _{x,y,z}	sensitivity in free space
DCP	diode compression point
CF	crest factor (1/duty_cycle) of the RF signal
A, B, C	modulation dependent linearization parameters
Polarization φ	φ rotation around probe axis
Polarization ϑ	ϑ rotation around an axis that is in the plane normal to probe axis (at measurement center), i.e., $\vartheta = 0$ is normal to probe axis
Connector Angle	information used in DASY system to align probe sensor X to the robot coordinate system

Calibration is Performed According to the Following Standards:

- a) IEEE Std 1309-2005, " IEEE Standard for calibration of electromagnetic field sensors and probes, excluding antennas, from 9 kHz to 40 GHz", December 2005.

Methods Applied and Interpretation of Parameters:

- *NORM_{x,y,z}*: Assessed for E-field polarization $\vartheta = 0$ for XY sensors and $\vartheta = 90$ for Z sensor ($f \leq 900$ MHz in TEM-cell; $f > 1800$ MHz: R22 waveguide).
- *X,Y,Z(f)* = *X,Y,Z* * *frequency_response* (see Frequency Response Chart).
- *DCP_{x,y,z}*: DCP are numerical linearization parameters assessed based on the data of power sweep with CW signal (no uncertainty required). DCP does not depend on frequency nor media.
- *PAR*: PAR is the Peak to Average Ratio that is not calibrated but determined based on the signal characteristics
- *A_{x,y,z}; B_{x,y,z}; C_{x,y,z}; VR_{x,y,z}*: A, B, C are numerical linearization parameters assessed based on the data of power sweep for specific modulation signal. The parameters do not depend on frequency nor media. VR is the maximum calibration range expressed in RMS voltage across the diode.
- *Spherical isotropy (3D deviation from isotropy)*: in a locally homogeneous field realized using an open waveguide setup.
- *Sensor Offset*: The sensor offset corresponds to the offset of virtual measurement center from the probe tip (on probe axis). No tolerance required.
- *Connector Angle*: The angle is assessed using the information gained by determining the *X* (no uncertainty required).

Probe H3DV6

SN:6274

Manufactured: November 30, 2007
Calibrated: February 17, 2012

Calibrated for DASY/EASY Systems
(Note: non-compatible with DASY2 system!)

DASY/EASY - Parameters of Probe: H3DV6 - SN:6274

Basic Calibration Parameters

		Sensor X	Sensor Y	Sensor Z	Unc (k=2)
Norm (A/m / $\sqrt{\text{mV}}$)	a0	2.49E-003	2.58E-003	2.90E-003	$\pm 5.1 \%$
Norm (A/m / $\sqrt{\text{mV}}$)	a1	-1.39E-004	-1.92E-004	-1.14E-004	$\pm 5.1 \%$
Norm (A/m / $\sqrt{\text{mV}}$)	a2	3.08E-005	7.89E-006	1.16E-005	$\pm 5.1 \%$
DCP (mV) ^B		94.0	95.4	94.9	

Modulation Calibration Parameters

UID	Communication System Name	PAR		A dB	B dB	C dB	VR mV	Unc ^E (k=2)
10000	CW	0.00	X	0.00	0.00	1.00	105.5	$\pm 2.7 \%$
			Y	0.00	0.00	1.00	105.1	
			Z	0.00	0.00	1.00	103.2	
10011	UMTS-FDD (WCDMA)	3.40	X	3.45	64.7	17.8	115.2	$\pm 0.7 \%$
			Y	3.42	64.8	17.9	114.9	
			Z	3.43	64.6	17.7	112.6	
10021	GSM-FDD (TDMA, GMSK)	9.40	X	9.04	74.3	23.8	145.7	$\pm 2.2 \%$
			Y	8.40	72.0	22.5	101.9	
			Z	9.68	73.8	23.9	110.8	
10039	CDMA2000 (1xRTT, RC1)	4.57	X	5.46	66.8	19.0	125.3	$\pm 1.2 \%$
			Y	5.45	66.8	19.0	125.1	
			Z	5.45	66.7	18.9	123.6	
10056	UMTS-TDD (TD-SCDMA, 1.28 Mcps)	11.01	X	11.61	75.9	26.4	117.7	$\pm 2.7 \%$
			Y	11.85	76.3	26.5	119.5	
			Z	13.11	77.7	27.4	131.8	
10081	CDMA2000 (1xRTT, RC3)	3.96	X	4.18	65.2	18.1	118.1	$\pm 0.9 \%$
			Y	4.22	65.6	18.4	117.3	
			Z	4.28	65.8	18.4	116.2	
10082	IS-54 / IS-136 FDD (TDMA/FDM, PI/4-DQPSK, Fullrate)	4.77	X	3.48	75.9	18.3	149.5	$\pm 1.4 \%$
			Y	6.06	83.6	21.0	149.8	
			Z	25.84	99.6	25.6	115.7	
10100	LTE-FDD (SC-FDMA, 100% RB, 20 MHz, QPSK)	5.66	X	7.21	69.0	20.5	134.4	$\pm 1.7 \%$
			Y	7.21	69.1	20.6	132.7	
			Z	7.22	69.1	20.6	131.6	
10101	LTE-FDD (SC-FDMA, 100% RB, 20 MHz, 16-QAM)	6.41	X	7.72	67.1	19.7	101.3	$\pm 1.9 \%$
			Y	8.76	70.2	21.4	148.5	
			Z	8.78	70.1	21.4	148.1	
10108	LTE-FDD (SC-FDMA, 100% RB, 10 MHz, QPSK)	5.79	X	7.51	69.5	20.8	136.3	$\pm 1.7 \%$
			Y	7.52	69.7	20.9	134.5	
			Z	7.56	69.7	20.9	134.6	

10109	LTE-FDD (SC-FDMA, 100% RB, 10 MHz, 16-QAM)	6.42	X	7.80	67.2	19.8	101.5	±1.9 %
			Y	8.89	70.5	21.6	149.0	
			Z	8.92	70.4	21.5	149.2	
10110	LTE-FDD (SC-FDMA, 100% RB, 5 MHz, QPSK)	5.75	X	7.34	69.2	20.7	135.4	±1.7 %
			Y	7.31	69.3	20.7	133.4	
			Z	7.36	69.3	20.7	133.4	
10111	LTE-FDD (SC-FDMA, 100% RB, 5 MHz, 16-QAM)	6.44	X	7.73	67.0	19.8	101.4	±1.9 %
			Y	8.78	70.2	21.5	148.5	
			Z	8.78	70.1	21.4	147.9	
10148	LTE-FDD (SC-FDMA, 50% RB, 20 MHz, QPSK)	5.83	X	7.65	69.7	21.0	137.7	±1.7 %
			Y	7.55	69.6	20.9	135.5	
			Z	7.56	69.4	20.8	135.2	
10149	LTE-FDD (SC-FDMA, 50% RB, 20 MHz, 16-QAM)	6.42	X	7.87	67.5	20.0	101.9	±1.9 %
			Y	8.91	70.5	21.6	149.5	
			Z	8.99	70.6	21.6	148.9	
10154	LTE-FDD (SC-FDMA, 50% RB, 10 MHz, QPSK)	5.76	X	7.37	69.2	20.7	136.1	±1.7 %
			Y	7.33	69.3	20.7	133.8	
			Z	7.34	69.2	20.7	132.8	
10155	LTE-FDD (SC-FDMA, 50% RB, 10 MHz, 16-QAM)	6.43	X	7.75	67.1	19.8	101.6	±1.9 %
			Y	8.75	70.1	21.4	148.1	
			Z	8.77	70.1	21.4	147.6	
10156	LTE-FDD (SC-FDMA, 50% RB, 5 MHz, QPSK)	5.79	X	7.45	69.4	20.8	136.4	±1.7 %
			Y	7.39	69.3	20.8	134.3	
			Z	7.36	69.1	20.7	133.8	
10157	LTE-FDD (SC-FDMA, 50% RB, 5 MHz, 16-QAM)	6.49	X	7.83	67.2	19.9	102.1	±1.9 %
			Y	8.83	70.2	21.5	149.0	
			Z	8.89	70.3	21.5	147.7	
10160	LTE-FDD (SC-FDMA, 50% RB, 15 MHz, QPSK)	5.81	X	7.67	69.4	20.7	140.2	±1.7 %
			Y	7.60	69.3	20.7	138.1	
			Z	7.62	69.3	20.7	136.8	
10161	LTE-FDD (SC-FDMA, 50% RB, 15 MHz, 16-QAM)	6.42	X	7.82	67.0	19.7	103.2	±1.9 %
			Y	7.78	67.0	19.7	101.6	
			Z	8.78	69.8	21.2	149.3	
10163	LTE-FDD (SC-FDMA, 50% RB, 3 MHz, QPSK)	5.68	X	7.26	68.9	20.5	136.6	±1.7 %
			Y	7.18	68.8	20.4	134.9	
			Z	7.21	68.7	20.4	133.2	
10164	LTE-FDD (SC-FDMA, 50% RB, 3 MHz, 16-QAM)	6.44	X	7.82	67.1	19.8	102.8	±1.9 %
			Y	7.83	67.2	19.8	101.2	
			Z	8.82	70.0	21.3	148.4	

10166	LTE-FDD (SC-FDMA, 50% RB, 1.4 MHz, QPSK)	5.45	X	6.89	68.6	20.2	134.2	±1.4 %
			Y	6.77	68.3	20.1	132.1	
			Z	6.84	68.5	20.2	130.7	
10167	LTE-FDD (SC-FDMA, 50% RB, 1.4 MHz, 16-QAM)	6.21	X	8.20	69.1	20.7	145.7	±1.9 %
			Y	8.15	69.0	20.8	143.9	
			Z	8.17	69.0	20.7	141.4	
10042	IS-54 / IS-136 FDD (TDMA/FDM, PI/4-DQPSK, Halfrate)	7.78	X	8.28	80.4	23.0	114.2	±1.2 %
			Y	7.91	79.0	22.2	114.7	
			Z	7.08	73.9	19.6	122.5	

The reported uncertainty of measurement is stated as the standard uncertainty of measurement multiplied by the coverage factor $k=2$, which for a normal distribution corresponds to a coverage probability of approximately 95%.

^B Numerical linearization parameter: uncertainty not required.

^E Uncertainty is determined using the max. deviation from linear response applying rectangular distribution and is expressed for the square of the field value.

Frequency Response of H-Field

(TEM-Cell: ifi110 EXX, Waveguide: R22)

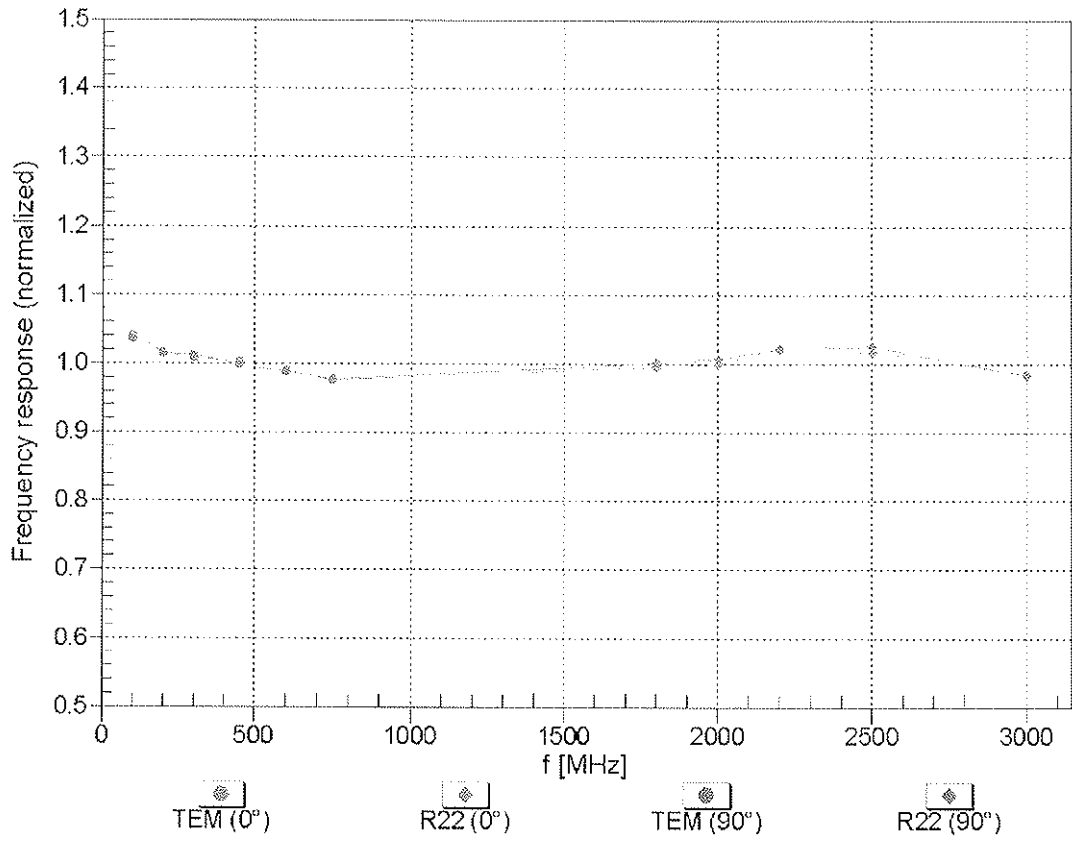

Uncertainty of Frequency Response of H-field: $\pm 6.3\%$ (k=2)

Receiving Pattern (ϕ), $\vartheta = 0^\circ$

f=600 MHz,TEM,0°

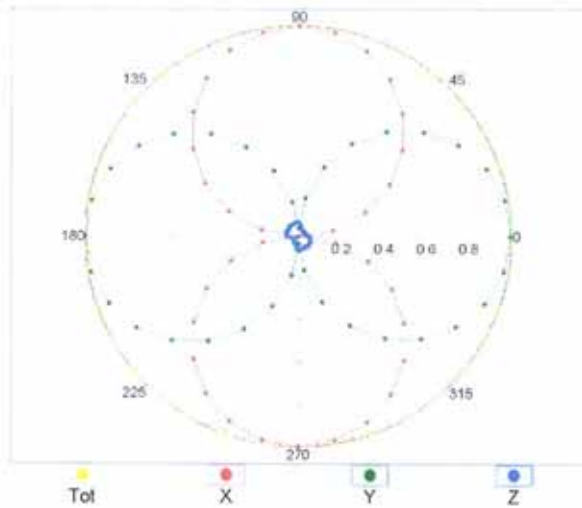

f=2500 MHz,R22,0°

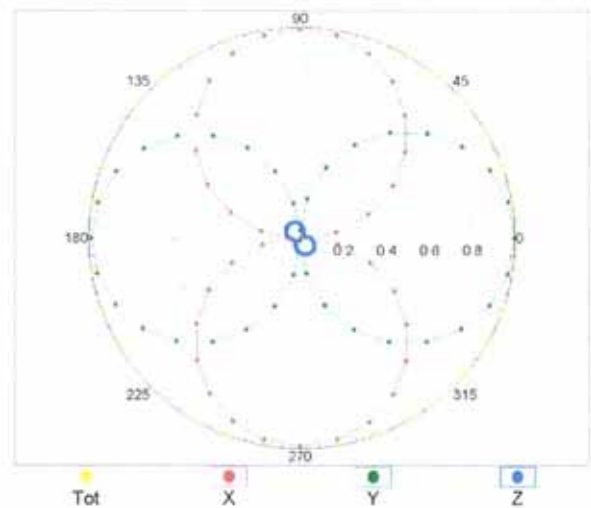

Receiving Pattern (ϕ), $\vartheta = 90^\circ$

f=600 MHz,TEM,90°

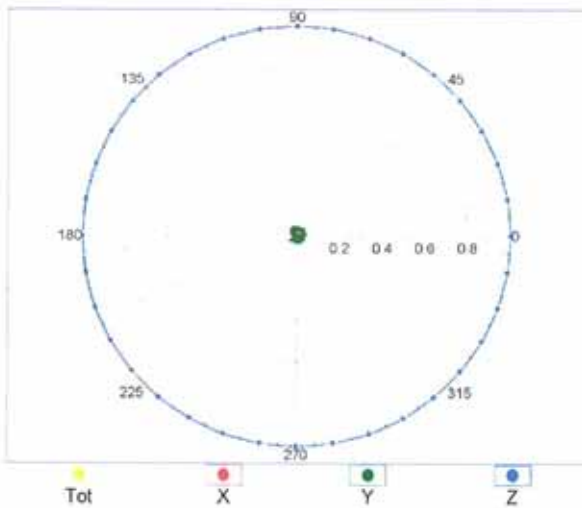

f=2500 MHz,R22,90°

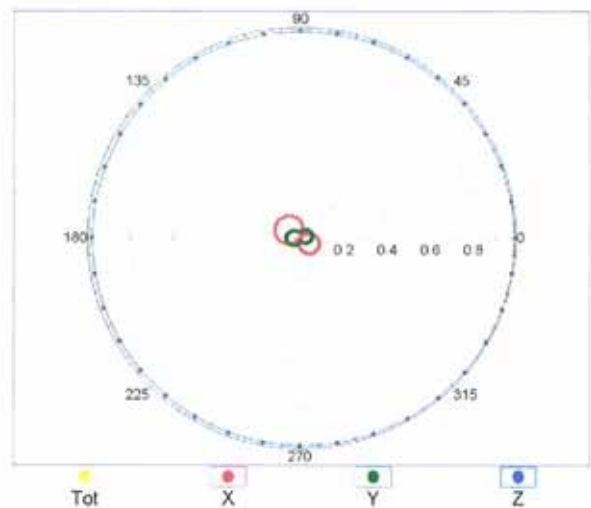

Receiving Pattern (ϕ), $\vartheta = 0^\circ$

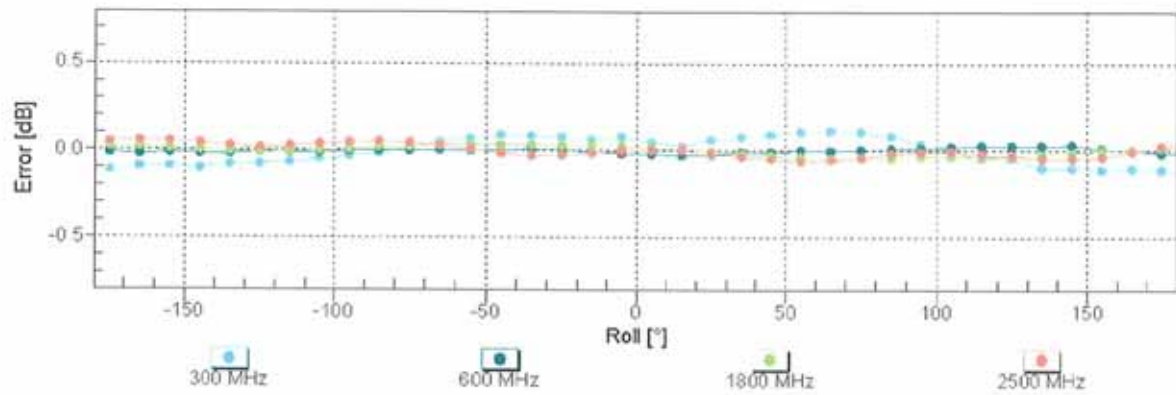

Uncertainty of Axial Isotropy Assessment: $\pm 0.5\%$ ($k=2$)

Receiving Pattern (ϕ), $\vartheta = 90^\circ$

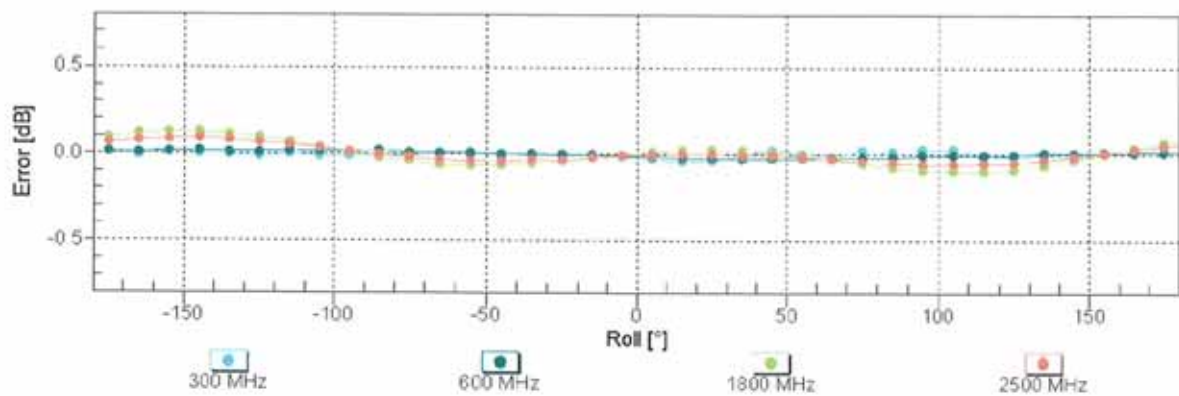

Uncertainty of Axial Isotropy Assessment: $\pm 0.5\%$ ($k=2$)

Dynamic Range f(H-field) (TEM cell, f = 900 MHz)

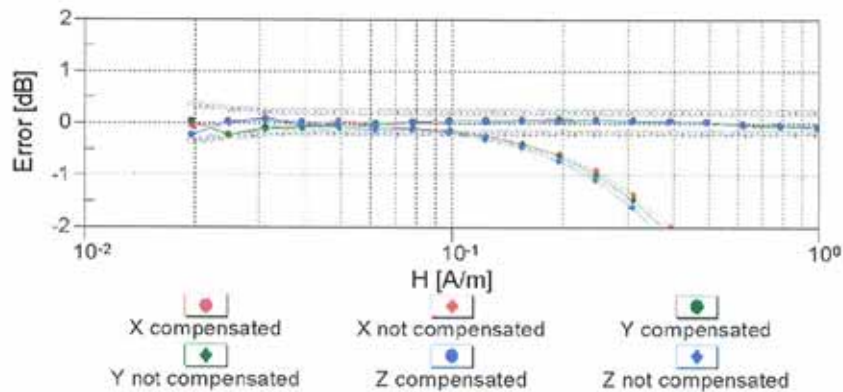
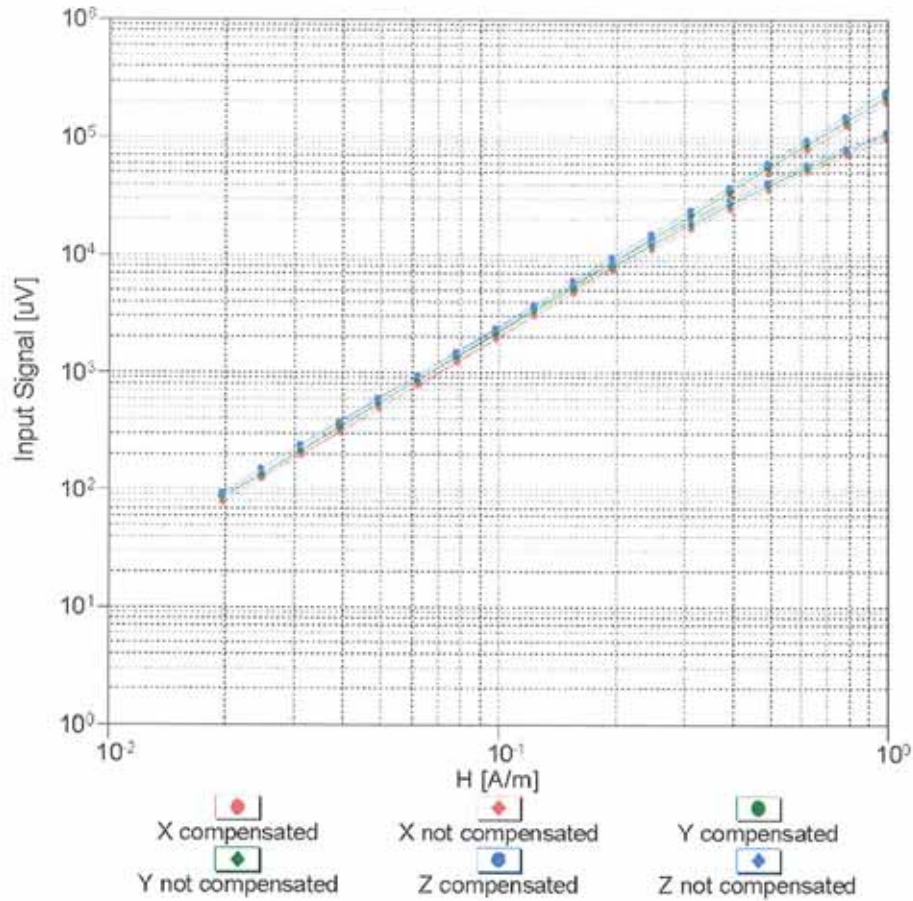

Uncertainty of Linearity Assessment: $\pm 0.6\%$ ($k=2$)

Deviation from Isotropy in Air

Error (ϕ, θ), $f = 900$ MHz

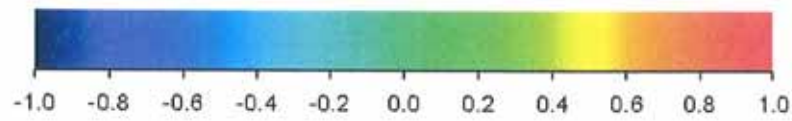
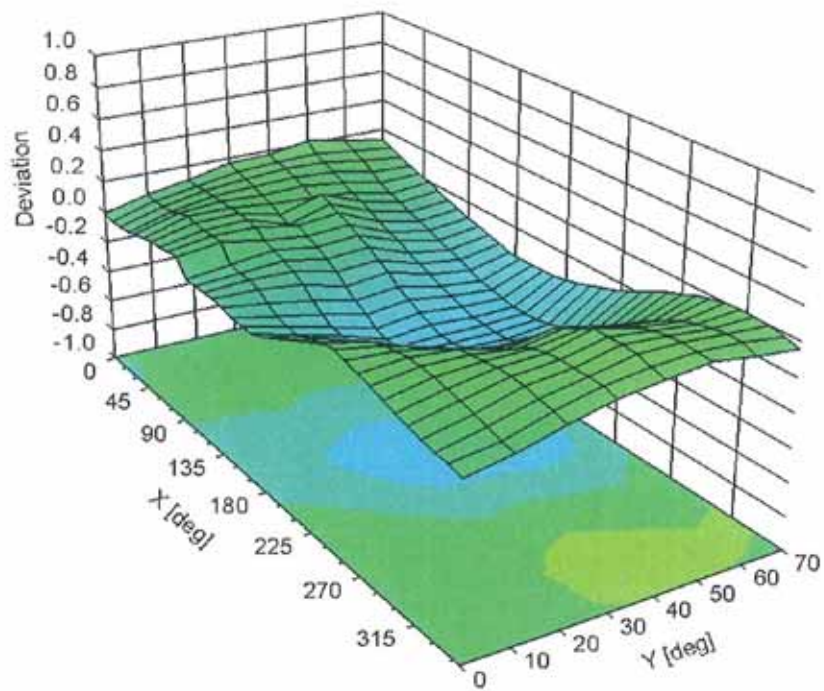

Uncertainty of Spherical Isotropy Assessment: $\pm 2.6\%$ ($k=2$)

DASY/EASY - Parameters of Probe: H3DV6 - SN:6274

Other Probe Parameters

Sensor Arrangement	Rectangular
Connector Angle (°)	-125
Mechanical Surface Detection Mode	enabled
Optical Surface Detection Mode	disabled
Probe Overall Length	337 mm
Probe Body Diameter	10 mm
Tip Length	20 mm
Tip Diameter	6 mm
Probe Tip to Sensor X Calibration Point	3 mm
Probe Tip to Sensor Y Calibration Point	3 mm
Probe Tip to Sensor Z Calibration Point	3 mm