



FCC TEST REPORT (BLUETOOTH)

REPORT NO.: RF120405C02-1

MODEL NO.: PL01130

FCC ID: NM8PL01130

RECEIVED: Apr. 05, 2012

TESTED: Apr. 10 ~ Apr. 12, 2012

ISSUED: Apr. 18, 2012

APPLICANT: HTC Corporation

ADDRESS: 23, Xinghua Rd., Taoyuan 330, Taiwan, R.O.C.

ISSUED BY: Bureau Veritas Consumer Products Services (H.K.)
Ltd., Taoyuan Branch

LAB ADDRESS: No. 47, 14th Ling, Chia Pau Vil., Lin Kou Dist., New
Taipei City, Taiwan (R.O.C)

TEST LOCATION: No. 19, Hwa Ya 2nd Rd, Wen Hwa Tsuen, Kwei
Shan Hsiang, Taoyuan Hsien 333, Taiwan, R.O.C.

This test report consists of 71 pages in total. It may be duplicated completely for legal use with the approval of the applicant. It should not be reproduced except in full, without the written approval of our laboratory. The client should not use it to claim product certification, approval, or endorsement by TAF or any government agency. The test results in the report only apply to the tested sample.



Table of Contents

RELEASE CONTROL RECORD	5
1. CERTIFICATION.....	6
2. SUMMARY OF TEST RESULTS	7
2.1 MEASUREMENT UNCERTAINTY	8
3. GENERAL INFORMATION.....	9
3.1 GENERAL DESCRIPTION OF EUT	9
3.2 DESCRIPTION OF TEST MODES.....	10
3.2.1 CONFIGURATION OF SYSTEM UNDER TEST	11
3.2.2 TEST MODE APPLICABILITY AND TESTED CHANNEL DETAIL.....	12
3.3 GENERAL DESCRIPTION OF APPLIED STANDARDS	15
3.4 DESCRIPTION OF SUPPORT UNITS	15
4. TEST TYPES AND RESULTS (FOR BLUETOOTH EDR).....	16
4.1 RADIATED EMISSION AND BANDEDGE MEASUREMENT.....	16
4.1.1 LIMITS OF RADIATED EMISSION AND BANDEDGE MEASUREMENT	16
4.1.2 TEST INSTRUMENTS	17
4.1.3 TEST PROCEDURES	18
4.1.4 DEVIATION FROM TEST STANDARD	18
4.1.5 TEST SETUP	19
4.1.6 EUT OPERATING CONDITIONS	19
4.1.7 TEST RESULTS	20
4.2 CONDUCTED EMISSION MEASUREMENT	24
4.2.1 LIMITS OF CONDUCTED EMISSION MEASUREMENT.....	24
4.2.2 TEST INSTRUMENTS	24
4.2.3 TEST PROCEDURES	25
4.2.4 DEVIATION FROM TEST STANDARD	25
4.2.5 TEST SETUP	26
4.2.6 EUT OPERATING CONDITIONS	26
4.2.7 TEST RESULTS	27
4.3 NUMBER OF HOPPING FREQUENCY USED	29
4.3.1 LIMIT OF HOPPING FREQUENCY USED	29
4.3.2 TEST SETUP	29
4.3.3 TEST INSTRUMENTS	29
4.3.4 TEST PROCEDURES	29
4.3.5 DEVIATION FROM TEST STANDARD	29
4.3.6 TEST RESULTS	29
4.4 DWELL TIME ON EACH CHANNEL	33
4.4.1 LIMIT OF DWELL TIME USED.....	33
4.4.2 TEST SETUP	33
4.4.3 TEST INSTRUMENTS	33
4.4.4 TEST PROCEDURES	33
4.4.5 DEVIATION FROM TEST STANDARD	33
4.4.6 TEST RESULTS	34
4.5 CHANNEL BANDWIDTH.....	37
4.5.1 LIMITS OF CHANNEL BANDWIDTH	37
4.5.2 TEST SETUP	37
4.5.3 TEST INSTRUMENTS	37
4.5.4 TEST PROCEDURE	37



4.5.5	DEVIATION FROM TEST STANDARD	37
4.5.6	EUT OPERATING CONDITION	37
4.5.7	TEST RESULTS	38
4.6	HOPPING CHANNEL SEPARATION	41
4.6.1	LIMIT OF HOPPING CHANNEL SEPARATION	41
4.6.2	TEST SETUP	41
4.6.3	TEST INSTRUMENTS	41
4.6.4	TEST PROCEDURES	41
4.6.5	DEVIATION FROM TEST STANDARD	41
4.6.6	TEST RESULTS	42
4.7	MAXIMUM OUTPUT POWER.....	44
4.7.1	LIMITS OF MAXIMUM OUTPUT POWER MEASUREMENT	44
4.7.2	TEST SETUP	44
4.7.3	TEST INSTRUMENTS	44
4.7.4	TEST PROCEDURES	44
4.7.5	DEVIATION FROM TEST STANDARD	44
4.7.6	EUT OPERATING CONDITION	44
4.7.7	TEST RESULTS	45
4.8	CONDUCTED OUT OF BAND EMISSION MEASUREMENT.....	47
4.8.1	LIMITS OF CONDUCTED OUT OF BAND EMISSION MEASUREMENT	47
4.8.2	TEST INSTRUMENTS	47
4.8.3	TEST PROCEDURE	47
4.8.4	DEVIATION FROM TEST STANDARD	47
4.8.5	EUT OPERATING CONDITION	47
4.8.6	TEST RESULTS	47
5.	TEST TYPES AND RESULTS (FOR BLUETOOTH LE 4.0).....	54
5.1	RADIATED EMISSION AND BANDEDGE MEASUREMENT.....	54
5.1.1	LIMITS OF RADIATED EMISSION AND BANDEDGE MEASUREMENT	54
5.1.2	TEST INSTRUMENTS	54
5.1.3	TEST PROCEDURES	54
5.1.4	DEVIATION FROM TEST STANDARD	54
5.1.5	TEST SETUP	54
5.1.6	EUT OPERATING CONDITIONS	54
5.1.7	TEST RESULTS	55
5.2	CONDUCTED EMISSION MEASUREMENT	59
5.2.1	LIMITS OF CONDUCTED EMISSION MEASUREMENT.....	59
5.2.2	TEST INSTRUMENTS	59
5.2.3	TEST PROCEDURES	59
5.2.4	DEVIATION FROM TEST STANDARD	59
5.2.5	TEST SETUP	59
5.2.6	EUT OPERATING CONDITIONS	59
5.2.7	TEST RESULTS	60
5.3	6dB BANDWIDTH MEASUREMENT	62
5.3.1	LIMITS OF 6dB BANDWIDTH MEASUREMENT	62
5.3.2	TEST SETUP	62
5.3.3	TEST INSTRUMENTS	62
5.3.4	TEST PROCEDURE	62
5.3.5	DEVIATION FROM TEST STANDARD	62
5.3.6	EUT OPERATING CONDITIONS	62
5.3.7	TEST RESULTS	63
5.4	CONDUCTED OUTPUT POWER	64



A D T

5.4.1	LIMITS OF CONDUCTED OUTPUT POWER MEASUREMENT	64
5.4.2	TEST SETUP	64
5.4.3	TEST INSTRUMENTS	64
5.4.4	TEST PROCEDURES	64
5.4.5	DEVIATION FROM TEST STANDARD	64
5.4.6	EUT OPERATING CONDITIONS	64
5.4.7	TEST RESULTS	64
5.5	POWER SPECTRAL DENSITY MEASUREMENT	65
5.5.1	LIMITS OF POWER SPECTRAL DENSITY MEASUREMENT	65
5.5.2	TEST SETUP	65
5.5.3	TEST INSTRUMENTS	65
5.5.4	TEST PROCEDURE	65
5.5.5	DEVIATION FROM TEST STANDARD	65
5.5.6	EUT OPERATING CONDITION	65
5.5.7	TEST RESULTS	65
5.6	CONDUCTED OUT OF BAND EMISSION MEASUREMENT	66
5.6.1	LIMITS OF OUT OF BAND EMISSION MEASUREMENT	66
5.6.2	TEST SETUP	66
5.6.3	TEST INSTRUMENTS	66
5.6.4	TEST PROCEDURE	66
5.6.5	DEVIATION FROM TEST STANDARD	67
5.6.6	EUT OPERATING CONDITION	67
5.6.7	TEST RESULTS	67
5.6.8	TEST RESULTS	68
6.	PHOTOGRAPHS OF THE TEST CONFIGURATION	69
7.	INFORMATION ON THE TESTING LABORATORIES	70
8.	APPENDIX A - MODIFICATIONS RECORDERS FOR ENGINEERING CHANGES TO THE EUT BY THE LAB	71



A D T

RELEASE CONTROL RECORD

ISSUE NO.	REASON FOR CHANGE	DATE ISSUED
RF120405C02-1	Original release	Apr. 18, 2012



1. CERTIFICATION

PRODUCT: Smart Phone

MODEL: PL01130

BRAND: HTC

APPLICANT: HTC Corporation

TESTED: Apr. 10 ~ Apr. 12, 2012

TEST SAMPLE: Production Unit

STANDARDS: **FCC Part 15, Subpart C (Section 15.247)**

ANSI C63.10-2009

The above equipment (Model: PL01130) has been tested by **Bureau Veritas Consumer Products Services (H.K.) Ltd., Taoyuan Branch**, and found compliance with the requirement of the above standards. The test record, data evaluation & Equipment Under Test (EUT) configurations represented herein are true and accurate accounts of the measurements of the sample's EMC characteristics under the conditions specified in this report.

PREPARED BY : Andrea Hsia , DATE : Apr. 18, 2012
Andrea Hsia / Specialist

APPROVED BY : Gary Chang , DATE : Apr. 18, 2012
Gary Chang / Technical Manager

2. SUMMARY OF TEST RESULTS

The EUT has been tested according to the following specifications:

APPLIED STANDARD: FCC Part 15, Subpart C (Bluetooth EDR)			
STANDARD SECTION	TEST TYPE AND LIMIT	RESULT	REMARK
15.207	AC Power Conducted Emission	PASS	Meet the requirement of limit. Minimum passing margin is -18.85dB at 0.55625MHz.
15.247(a)(1) (iii)	Number of Hopping Frequency Used	PASS	Meet the requirement of limit.
15.247(a)(1) (iii)	Dwell Time on Each Channel	PASS	Meet the requirement of limit.
15.247(a)(1)	1. Hopping Channel Separation 2. Spectrum Bandwidth of a Frequency Hopping Sequence Spread Spectrum System	PASS	Meet the requirement of limit.
15.247(b)	Maximum Peak Output Power	PASS	Meet the requirement of limit.
15.247(d)	Transmitter Radiated Emissions	PASS	Meet the requirement of limit. Minimum passing margin is -11.5dB at 45.52MHz.
15.247(d)	Band Edge Measurement	PASS	Meet the requirement of limit.
15.203	Antenna Requirement	PASS	No antenna connector is used.

NOTE: If The Frequency Hopping System operating in 2400-2483.5MHz band and the output power less than 125mW. The hopping channel carrier frequencies separated by a minimum of 25kHz or two-thirds of the 20dB bandwidth of hopping channel whichever is greater.

APPLIED STANDARD: FCC PART 15, SUBPART C (SECTION 15.247) (Bluetooth LE 4.0)			
STANDARD SECTION	TEST TYPE AND LIMIT	RESULT	REMARK
15.207	AC Power Conducted Emission	PASS	Meet the requirement of limit. Minimum passing margin is -15.19dB at 0.56406MHz.
15.247(d) 15.209	Radiated Emissions	PASS	Meet the requirement of limit. Minimum passing margin is -8.5dB at 2483.50MHz.
15.247(d)	Band Edge Measurement	PASS	Meet the requirement of limit.
15.247(a)(2)	6dB bandwidth	PASS	Meet the requirement of limit.
15.247(b)	Conducted power	PASS	Meet the requirement of limit.
15.247(e)	Power Spectral Density	PASS	Meet the requirement of limit.
15.203	Antenna Requirement	PASS	No antenna connector is used.



A D T

2.1 MEASUREMENT UNCERTAINTY

Where relevant, the following measurement uncertainty levels have been estimated for tests performed on the EUT as specified in CISPR 16-4-2:

MEASUREMENT	FREQUENCY	UNCERTAINTY
Conducted emissions	9kHz~30MHz	2.44 dB
Radiated emissions	30MHz ~ 200MHz	2.93 dB
	200MHz ~1000MHz	2.95 dB
	1GHz ~ 18GHz	2.26 dB
	18GHz ~ 40GHz	1.94 dB

This uncertainty represents an expanded uncertainty expressed at approximately the 95% confidence level using a coverage factor of $k=2$.

3. GENERAL INFORMATION

3.1 GENERAL DESCRIPTION OF EUT

EUT	Smart Phone	
MODEL NO.	PL01130	
POWER SUPPLY	5.0Vdc (adapter or host equipment) 3.7Vdc (Li-ion battery)	
MODULATION TYPE	Bluetooth EDR	GFSK, $\pi/4$ -DQPSK, 8DPSK
	Bluetooth LE 4.0	GFSK
TRANSFER RATE	Bluetooth EDR	1/2/3Mbps
	Bluetooth LE 4.0	1Mbps
OPERATING FREQUENCY	2402 ~ 2480MHz	
NUMBER OF CHANNEL	Bluetooth EDR	79
	Bluetooth LE 4.0	40
CHANNEL SPACING	Bluetooth EDR	1MHz
	Bluetooth LE 4.0	2MHz
OUTPUT POWER	Bluetooth EDR	1.297mW
	Bluetooth LE 4.0	1.21mW
ANTENNA TYPE	PIFA antenna with 0dBi gain	
ANTENNA CONNECTOR	NA	
DATA CABLE	Refer to Note as below	
I/O PORTS	Refer to user's manual	
ACCESSORY DEVICES	Refer to Note as below	

NOTE:

- The EUT's accessories list refers to EUT photo.pdf.
*Item 1, 6, 8, 10 were the worst for the final test.
- The above EUT information is declared by the manufacturer and for more detailed features description, please refer to the manufacturer's specifications or User's Manual.

3.2 DESCRIPTION OF TEST MODES

For Bluetooth EDR:

79 channels are provided to this EUT:

CHANNEL	FREQ. (MHz)	CHANNEL	FREQ. (MHz)	CHANNEL	FREQ. (MHz)	CHANNEL	FREQ. (MHz)
0	2402	20	2422	40	2442	60	2462
1	2403	21	2423	41	2443	61	2463
2	2404	22	2424	42	2444	62	2464
3	2405	23	2425	43	2445	63	2465
4	2406	24	2426	44	2446	64	2466
5	2407	25	2427	45	2447	65	2467
6	2408	26	2428	46	2448	66	2468
7	2409	27	2429	47	2449	67	2469
8	2410	28	2430	48	2450	68	2470
9	2411	29	2431	49	2451	69	2471
10	2412	30	2432	50	2452	70	2472
11	2413	31	2433	51	2453	71	2473
12	2414	32	2434	52	2454	72	2474
13	2415	33	2435	53	2455	73	2475
14	2416	34	2436	54	2456	74	2476
15	2417	35	2437	55	2457	75	2477
16	2418	36	2438	56	2458	76	2478
17	2419	37	2439	57	2459	77	2479
18	2420	38	2440	58	2460	78	2480
19	2421	39	2441	59	2461		

For Bluetooth LE 4.0:

40 channels are provided to this EUT:

CHANNEL	FREQ. (MHz)	CHANNEL	FREQ. (MHz)	CHANNEL	FREQ. (MHz)	CHANNEL	FREQ. (MHz)
0	2402	10	2422	20	2442	30	2462
1	2404	11	2424	21	2444	31	2464
2	2406	12	2426	22	2446	32	2466
3	2408	13	2428	23	2448	33	2468
4	2410	14	2430	24	2450	34	2470
5	2412	15	2432	25	2452	35	2472
6	2414	16	2434	26	2454	36	2474
7	2416	17	2436	27	2456	37	2476
8	2418	18	2438	28	2458	38	2478
9	2420	19	2440	29	2460	39	2480

3.2.1 CONFIGURATION OF SYSTEM UNDER TEST

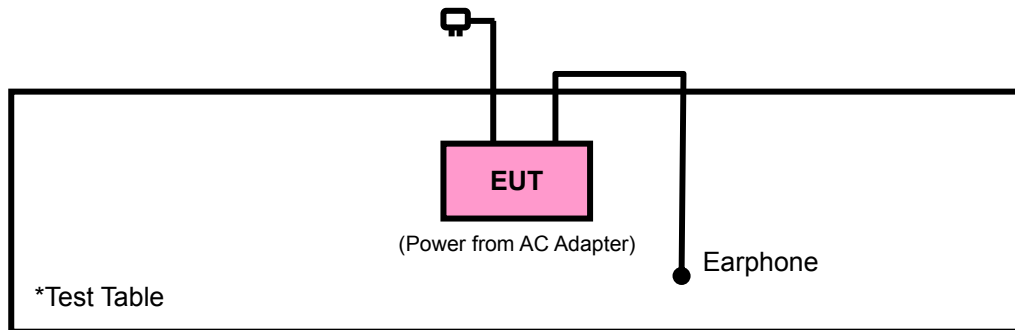

3.2.2 TEST MODE APPLICABILITY AND TESTED CHANNEL DETAIL

For Bluetooth EDR:

EUT CONFIGURE MODE	APPLICABLE TO				DESCRIPTION
	RE \geq 1G	RE<1G	PLC	APCM	
-	√	√	√	√	-

Where **RE \geq 1G**: Radiated Emission above 1GHz **RE<1G**: Radiated Emission below 1GHz
PLC: Power Line Conducted Emission **APCM**: Antenna Port Conducted Measurement

NOTE 1: For Radiated emission test, pre-tested GFSK, $\pi/4$ -DQPSK, 8DPSK modulation type and found 8DPSK was the worse, therefore chosen for the final test and presented in the test report.

NOTE 2: The EUT had been pre-tested on the positioned of each 3 axis. The worst case was found when positioned on Y-plane.

RADIATED EMISSION TEST (ABOVE 1 GHz):

- Pre-Scan has been conducted to determine the worst-case mode from all possible combinations between available modulations, antenna ports (if EUT with antenna diversity architecture) and packet type.
- Following channel(s) was (were) selected for the final test as listed below.

AVAILABLE CHANNEL	TESTED CHANNEL	MODULATION TYPE	PACKET TYPE
0 to 78	0, 39, 78	8DPSK	DH5

RADIATED EMISSION TEST (BELOW 1 GHz):

- Pre-Scan has been conducted to determine the worst-case mode from all possible combinations between available modulations, antenna ports (if EUT with antenna diversity architecture) and packet type.
- Following channel(s) was (were) selected for the final test as listed below.

AVAILABLE CHANNEL	TESTED CHANNEL	MODULATION TYPE	PACKET TYPE
0 to 78	39	8DPSK	DH5

POWER LINE CONDUCTED EMISSION TEST:

- Pre-Scan has been conducted to determine the worst-case mode from all possible combinations between available modulations, antenna ports (if EUT with antenna diversity architecture), and packet types.
- Following channel(s) was (were) selected for the final test as listed below.

AVAILABLE CHANNEL	TESTED CHANNEL	MODULATION TYPE	PACKET TYPE
0 to 78	39	8DPSK	DH5



ANTENNA PORT CONDUCTED MEASUREMENT:

- This item includes all test value of each mode, but only includes spectrum plot of worst value of each mode.
- Pre-Scan has been conducted to determine the worst-case mode from all possible combinations between available modulations, antenna ports (if EUT with antenna diversity architecture), and packet types.
- Following channel(s) was (were) selected for the final test as listed below.

AVAILABLE CHANNEL	TESTED CHANNEL	MODULATION TYPE	PACKET TYPE
0 to 78	0, 39, 78	GFSK	DH5
0 to 78	0, 39, 78	$\pi/4$ -DQPSK	DH5
0 to 78	0, 39, 78	8DPSK	DH5

TEST CONDITION:

APPLICABLE TO	ENVIRONMENTAL CONDITIONS	INPUT POWER	TESTED BY
RE \geq 1G	25deg. C, 65%RH	120Vac, 60Hz	Anderson Hong
RE<1G	21deg. C, 65%RH	120Vac, 60Hz	Sun Lin
PLC	25deg. C, 65%RH	120Vac, 60Hz	Mark Liao
APCM	23deg. C, 65%RH	120Vac, 60Hz	Brad Wu



FOR Bluetooth LE 4.0:

EUT CONFIGURE MODE	APPLICABLE TO				DESCRIPTION
	RE≥1G	RE<1G	PLC	APCM	
	√	√	√	√	-

Where **RE≥1G**: Radiated Emission above 1GHz **RE<1G**: Radiated Emission below 1GHz
PLC: Power Line Conducted Emission **APCM**: Antenna Port Conducted Measurement

NOTE: The EUT had been pre-tested on the positioned of each 3 axis. The worst case was found when positioned on **Z-plane**.

RADIATED EMISSION TEST (ABOVE 1GHz):

- Pre-Scan has been conducted to determine the worst-case mode from all possible combinations between available modulations and antenna ports (if EUT with antenna diversity architecture).
- Following channel(s) was (were) selected for the final test as listed below.

AVAILABLE CHANNEL	TESTED CHANNEL	MODULATION TYPE	DATA RATE (Mbps)
0 to 39	0, 19, 39	GFSK	1.0

RADIATED EMISSION TEST (BELOW 1GHz):

- Pre-Scan has been conducted to determine the worst-case mode from all possible combinations between available modulations and antenna ports (if EUT with antenna diversity architecture).
- Following channel(s) was (were) selected for the final test as listed below.

AVAILABLE CHANNEL	TESTED CHANNEL	MODULATION TYPE	DATA RATE (Mbps)
0 to 39	0	GFSK	1.0

POWER LINE CONDUCTED EMISSION TEST:

- Pre-Scan has been conducted to determine the worst-case mode from all possible combinations between available modulations and antenna ports (if EUT with antenna diversity architecture).
- Following channel(s) was (were) selected for the final test as listed below.

AVAILABLE CHANNEL	TESTED CHANNEL	MODULATION TYPE	DATA RATE (Mbps)
0 to 39	0	GFSK	1.0

ANTENNA PORT CONDUCTED MEASUREMENT:

- Pre-Scan has been conducted to determine the worst-case mode from all possible combinations between available modulations, data rates and antenna ports (if EUT with antenna diversity architecture).
- Following channel(s) was (were) selected for the final test as listed below.

AVAILABLE CHANNEL	TESTED CHANNEL	MODULATION TYPE	DATA RATE (Mbps)
0 to 39	0, 19, 39	GFSK	1.0

TEST CONDITION:

APPLICABLE TO	ENVIRONMENTAL CONDITIONS	INPUT POWER	TESTED BY
RE \geq 1G	25deg. C, 65%RH	120Vac, 60Hz	Anderson Hong
RE<1G	21deg. C, 65%RH	120Vac, 60Hz	Sun Lin
PLC	25deg. C, 65%RH	120Vac, 60Hz	Mark Liao
APCM	23deg. C, 65%RH	120Vac, 60Hz	Brad Wu

3.3 GENERAL DESCRIPTION OF APPLIED STANDARDS

The EUT is a RF Product. According to the specifications of the manufacturer, it must comply with the requirements of the following standards:

FCC Part 15, Subpart C (15.247)
ANSI C63.10-2009

All test items have been performed and recorded as per the above standards.

NOTE: The EUT is also considered as a kind of computer peripheral, because the connection to computer is necessary for typical use. It has been verified to comply with the requirements of FCC Part 15, Subpart B, Class B (DoC). The test report has been issued separately.

3.4 DESCRIPTION OF SUPPORT UNITS

The EUT has been tested as an independent unit.

4. TEST TYPES AND RESULTS (FOR Bluetooth EDR)

4.1 RADIATED EMISSION AND BANDEGE MEASUREMENT

4.1.1 LIMITS OF RADIATED EMISSION AND BANDEGE MEASUREMENT

Radiated emissions which fall in the restricted bands must comply with the radiated emission limits specified as below table. Other emissions shall be at least 20dB below the highest level of the desired power:

FREQUENCIES (MHz)	FIELD STRENGTH (microvolts/meter)	MEASUREMENT DISTANCE (meters)
0.009 ~ 0.490	2400/F(kHz)	300
0.490 ~ 1.705	24000/F(kHz)	30
1.705 ~ 30.0	30	30
30 ~ 88	100	3
88 ~ 216	150	3
216 ~ 960	200	3
Above 960	500	3

NOTE:

1. The lower limit shall apply at the transition frequencies.
2. Emission level (dBuV/m) = 20 log Emission level (uV/m).
3. For frequencies above 1000MHz, the field strength limits are based on average detector, however, the peak field strength of any emission shall not exceed the maximum permitted average limits, specified above by more than 20dB under any condition of modulation.



4.1.2 TEST INSTRUMENTS

DESCRIPTION & MANUFACTURER	MODEL NO.	SERIAL NO.	DATE OF CALIBRATION	DUE DATE OF CALIBRATION
Test Receiver ROHDE & SCHWARZ	ESCI	100744	Apr. 19, 2011	Apr. 18, 2012
Spectrum Analyzer ROHDE & SCHWARZ	FSP40	100040	Aug. 04, 2011	Aug. 03, 2012
BILOG Antenna SCHWARZBECK	VULB9168	9168-156	Apr. 03, 2012	Apr. 02, 2013
HORN Antenna SCHWARZBECK	BBHA 9120 D	9120D-563	Sep. 06, 2011	Sep. 05, 2012
HORN Antenna SCHWARZBECK	BBHA 9170	148	Jul. 20, 2011	Jul. 19, 2012
Preamplifier Agilent	8449B	3008A01911	Oct. 29, 2011	Oct. 28, 2012
Preamplifier Agilent	8447D	2944A10638	Oct. 29, 2011	Oct. 28, 2012
RF signal cable HUBER+SUHNNER	SUCOFLEX 104	295013/4 283403/4	Aug. 19, 2011	Aug. 18, 2012
RF signal cable Worken	8D-FB	Cable-HYCH9-01	Aug. 13, 2011	Aug. 12, 2012
Software	ADT_Radiated_ V7.6.15.9.2	NA	NA	NA
Antenna Tower EMCO	2070/2080	512.835.4684	NA	NA
Turn Table EMCO	2087-2.03	NA	NA	NA
Antenna Tower & Turn Table Controller EMCO	2090	NA	NA	NA
High Speed Peak Power Meter	ML2495A	0824011	Aug. 04, 2011	Aug. 03, 2012
Power Sensor	MA2411B	0738171	Aug. 04, 2011	Aug. 03, 2012

- NOTE:**
1. The calibration interval of the above test instruments is 12 months and the calibrations are traceable to NML/ROC and NIST/USA.
 2. The test was performed in HwaYa Chamber 9.
 3. The horn antenna and HP preamplifier (model: 8449B) are used only for the measurement of emission frequency above 1GHz if tested.
 4. The FCC Site Registration No. is 460141.
 5. The IC Site Registration No. is IC 7450F-4.

4.1.3 TEST PROCEDURES

- a. The EUT was placed on the top of a rotating table 0.8 meters above the ground at a 3 meter semi-anechoic chamber. The table was rotated 360 degrees to determine the position of the highest radiation.
- b. The EUT was set 3 meters away from the interference-receiving antenna, which was mounted on the top of a variable-height antenna tower.
- c. The antenna is a broadband antenna, and its height is varied from one meter to four meters above the ground to determine the maximum value of the field strength. Both horizontal and vertical polarizations of the antenna are set to make the measurement.
- d. For each suspected emission, the EUT was arranged to its worst case and then the antenna was tuned to heights from 1 meter to 4 meters and the rotatable table was turned from 0 degrees to 360 degrees to find the maximum reading.
- e. The test-receiver system was set to Peak Detect Function and Specified Bandwidth with Maximum Hold Mode.
- f. If the emission level of the EUT in peak mode was lower than the limit specified, then testing could be stopped and the peak values of the EUT would be reported. Otherwise the emissions would be re-tested one by one using peak, quasi-peak or average method as specified and then reported in a data sheet.

NOTE:

1. The resolution bandwidth and video bandwidth of test receiver/spectrum analyzer is 120kHz for Quasi-peak detection at frequency below 1GHz.
2. The resolution bandwidth of test receiver/spectrum analyzer is 1 MHz and video bandwidth is 3MHz for Peak detection at frequency above 1GHz.
3. All modes of operation were investigated and the worst-case emissions are reported.

4.1.4 DEVIATION FROM TEST STANDARD

No deviation.

4.1.5 TEST SETUP

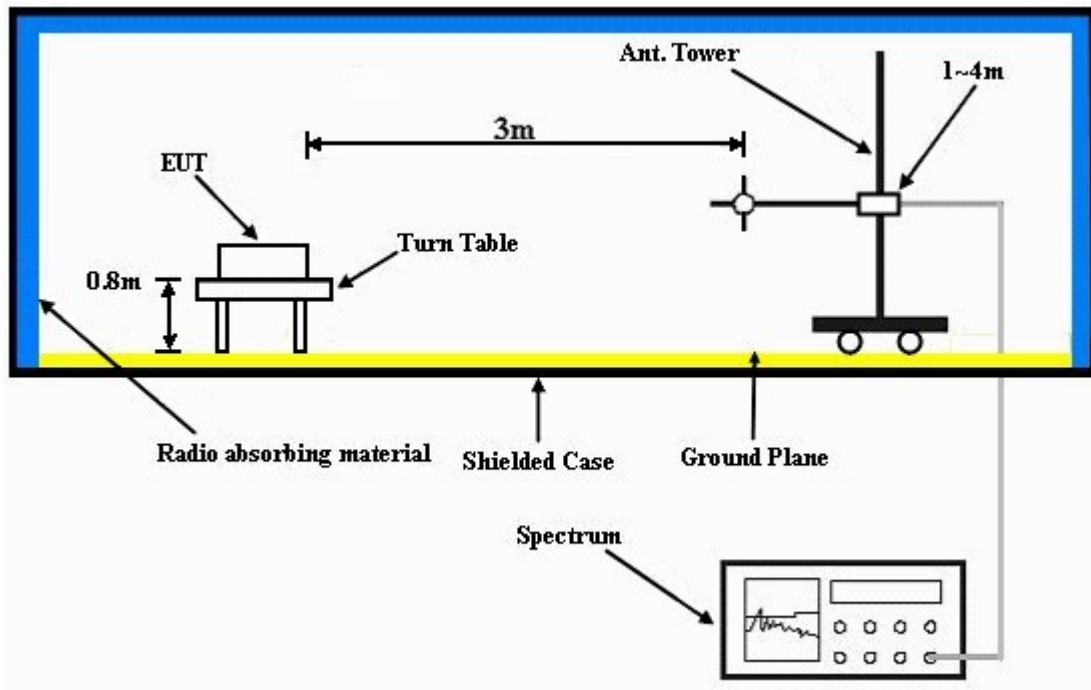

For the actual test configuration, please refer to the attached file (Test Setup Photo).

4.1.6 EUT OPERATING CONDITIONS

- a. Placed the EUT on a testing table.
- b. Use the software to control the EUT under transmission condition continuously at specific channel frequency.



4.1.7 TEST RESULTS

ABOVE 1GHz WORST-CASE DATA : 8DPSK

EUT TEST CONDITION		MEASUREMENT DETAIL	
CHANNEL	Channel 0	FREQUENCY RANGE	1 ~ 25GHz
INPUT POWER (SYSTEM)	120Vac, 60 Hz	DETECTOR FUNCTION	Peak (PK) Average (AV)
ENVIRONMENTAL CONDITIONS	25deg. C, 65%RH	TESTED BY	Anderson Hong

ANTENNA POLARITY & TEST DISTANCE: HORIZONTAL AT 3 M								
NO.	FREQ. (MHz)	EMISSION LEVEL (dBuV/m)	LIMIT (dBuV/m)	MARGIN (dB)	ANTENNA HEIGHT (m)	TABLE ANGLE (Degree)	RAW VALUE (dBuV)	CORRECTION FACTOR (dB/m)
1	2338.00	45.3 PK	74.0	-28.7	1.37 H	60	14.10	31.20
2	2338.00	37.8 AV	54.0	-16.2	1.37 H	60	6.60	31.20
3	2398.00	40.3 PK	74.0	-33.7	1.33 H	60	8.90	31.40
4	2398.00	30.5 AV	54.0	-23.5	1.33 H	60	-0.90	31.40
5	2400.00	40.1 PK	74.0	-33.9	1.33 H	30	8.70	31.40
6	2400.00	10.0 AV	54.0	-44.0	1.33 H	30	-21.40	31.40
7	*2402.00	96.5 PK			1.33 H	60	65.10	31.40
8	*2402.00	66.4 AV			1.33 H	60	35.00	31.40
9	4804.00	50.2 PK	74.0	-23.8	1.64 H	22	12.80	37.40
10	4804.00	20.1 AV	54.0	-33.9	1.64 H	22	-17.30	37.40

ANTENNA POLARITY & TEST DISTANCE: VERTICAL AT 3 M								
NO.	FREQ. (MHz)	EMISSION LEVEL (dBuV/m)	LIMIT (dBuV/m)	MARGIN (dB)	ANTENNA HEIGHT (m)	TABLE ANGLE (Degree)	RAW VALUE (dBuV)	CORRECTION FACTOR (dB/m)
1	2338.00	41.3 PK	74.0	-32.7	1.22 V	30	10.10	31.20
2	2338.00	32.2 AV	54.0	-21.8	1.22 V	30	1.00	31.20
3	2398.00	38.2 PK	74.0	-35.8	1.25 V	36	6.80	31.40
4	2398.00	28.1 AV	54.0	-25.9	1.25 V	36	-3.30	31.40
5	2400.00	37.1 PK	74.0	-36.9	1.25 V	36	5.70	31.40
6	2400.00	7.0 AV	54.0	-47.0	1.25 V	36	-24.40	31.40
7	*2402.00	91.5 PK			1.25 V	36	60.10	31.40
8	*2402.00	61.4 AV			1.25 V	36	30.00	31.40
9	4804.00	50.5 PK	74.0	-23.5	1.24 V	40	13.10	37.40
10	4804.00	20.4 AV	54.0	-33.6	1.24 V	40	-17.00	37.40

REMARKS:

1. Emission level (dBuV/m) = Raw Value (dBuV) + Correction Factor (dB/m).
2. Correction Factor (dB/m) = Antenna Factor (dB/m) + Cable Factor (dB).
3. The other emission levels were very low against the limit.
4. Margin value = Emission level – Limit value.
5. “ * “: Fundamental frequency.
6. The DH5 packet was the worse case duty cycle for a transmit dwell time on a channel, based upon bluetooth theory the transmitter is on 0.625 * 5 per 296.25 ms per channel. Therefore, the duty cycle correlation factor be equal to: $20\log(3.125 / 100) = -30.1$ dB.
7. Average value = peak reading + $20\log(\text{duty cycle})$.



EUT TEST CONDITION		MEASUREMENT DETAIL	
CHANNEL	Channel 39	FREQUENCY RANGE	1 ~ 25GHz
INPUT POWER (SYSTEM)	120Vac, 60 Hz	DETECTOR FUNCTION	Peak (PK) Average (AV)
ENVIRONMENTAL CONDITIONS	25deg. C, 65%RH	TESTED BY	Anderson Hong

ANTENNA POLARITY & TEST DISTANCE: HORIZONTAL AT 3 M								
NO.	FREQ. (MHz)	EMISSION LEVEL (dBuV/m)	LIMIT (dBuV/m)	MARGIN (dB)	ANTENNA HEIGHT (m)	TABLE ANGLE (Degree)	RAW VALUE (dBuV)	CORRECTION FACTOR (dB/m)
1	*2441.00	96.4 PK			1.29 H	59	64.80	31.60
2	*2441.00	66.3 AV			1.29 H	59	34.70	31.60
3	4882.00	50.0 PK	74.0	-24.0	1.65 H	25	12.40	37.60
4	4882.00	19.9 AV	54.0	-34.1	1.65 H	25	-17.70	37.60
5	7323.00	50.4 PK	74.0	-23.6	1.23 H	250	6.60	43.80
6	7323.00	20.3 AV	54.0	-33.7	1.23 H	250	-23.50	43.80
ANTENNA POLARITY & TEST DISTANCE: VERTICAL AT 3 M								
NO.	FREQ. (MHz)	EMISSION LEVEL (dBuV/m)	LIMIT (dBuV/m)	MARGIN (dB)	ANTENNA HEIGHT (m)	TABLE ANGLE (Degree)	RAW VALUE (dBuV)	CORRECTION FACTOR (dB/m)
1	*2441.00	92.1 PK			1.25 V	3	60.50	31.60
2	*2441.00	62.0 AV			1.25 V	3	30.40	31.60
3	4882.00	50.2 PK	74.0	-23.8	1.25 V	43	12.60	37.60
4	4882.00	20.1 AV	54.0	-33.9	1.25 V	43	-17.50	37.60
5	7323.00	50.6 PK	74.0	-23.4	1.03 V	93	6.80	43.80
6	7323.00	20.5 AV	54.0	-33.5	1.03 V	93	-23.30	43.80

REMARKS:

1. Emission level (dBuV/m) = Raw Value (dBuV) + Correction Factor (dB/m).
2. Correction Factor (dB/m) = Antenna Factor (dB/m) + Cable Factor (dB).
3. The other emission levels were very low against the limit.
4. Margin value = Emission level – Limit value.
5. “ * “: Fundamental frequency.
6. The DH5 packet was the worse case duty cycle for a transmit dwell time on a channel, based upon bluetooth theory the transmitter is on 0.625 * 5 per 296.25 ms per channel. Therefore, the duty cycle correlation factor be equal to: $20\log(3.125 / 100) = -30.1$ dB.
7. Average value = peak reading + $20\log(\text{duty cycle})$.



EUT TEST CONDITION		MEASUREMENT DETAIL	
CHANNEL	Channel 78	FREQUENCY RANGE	1 ~ 25GHz
INPUT POWER (SYSTEM)	120Vac, 60 Hz	DETECTOR FUNCTION	Peak (PK) Average (AV)
ENVIRONMENTAL CONDITIONS	25deg. C, 65%RH	TESTED BY	Anderson Hong

ANTENNA POLARITY & TEST DISTANCE: HORIZONTAL AT 3 M								
NO.	FREQ. (MHz)	EMISSION LEVEL (dBuV/m)	LIMIT (dBuV/m)	MARGIN (dB)	ANTENNA HEIGHT (m)	TABLE ANGLE (Degree)	RAW VALUE (dBuV)	CORRECTION FACTOR (dB/m)
1	*2480.00	96.0 PK			1.27 H	71	64.30	31.70
2	*2480.00	65.9 AV			1.27 H	71	34.20	31.70
3	2483.50	37.4 PK	74.0	-36.6	1.27 H	71	5.70	31.70
4	2483.50	7.3 AV	54.0	-46.7	1.27 H	71	-24.40	31.70
5	2485.50	37.5 PK	74.0	-36.5	1.27 H	71	5.80	31.70
6	2485.50	27.4 AV	54.0	-26.6	1.27 H	71	-4.30	31.70
7	4960.00	49.7 PK	74.0	-24.3	1.66 H	31	11.90	37.80
8	4960.00	19.6 AV	54.0	-34.4	1.66 H	31	-18.20	37.80
ANTENNA POLARITY & TEST DISTANCE: VERTICAL AT 3 M								
NO.	FREQ. (MHz)	EMISSION LEVEL (dBuV/m)	LIMIT (dBuV/m)	MARGIN (dB)	ANTENNA HEIGHT (m)	TABLE ANGLE (Degree)	RAW VALUE (dBuV)	CORRECTION FACTOR (dB/m)
1	*2480.00	91.2 PK			1.20 V	33	59.50	31.70
2	*2480.00	61.1 AV			1.20 V	33	29.40	31.70
3	2483.50	37.2 PK	74.0	-36.8	1.20 V	33	5.50	31.70
4	2483.50	7.1 AV	54.0	-46.9	1.20 V	33	-24.60	31.70
5	2485.50	37.4 PK	74.0	-36.6	1.20 V	33	5.70	31.70
6	2485.50	26.9 AV	54.0	-27.1	1.20 V	33	-4.80	31.70
7	4960.00	49.8 PK	74.0	-24.2	1.28 V	41	12.00	37.80
8	4960.00	19.7 AV	54.0	-34.3	1.28 V	41	-18.10	37.80

REMARKS:

- Emission level (dBuV/m) = Raw Value (dBuV) + Correction Factor (dB/m).
- Correction Factor (dB/m) = Antenna Factor (dB/m) + Cable Factor (dB).
- The other emission levels were very low against the limit.
- Margin value = Emission level – Limit value.
- * * *: Fundamental frequency.
- The DH5 packet was the worse case duty cycle for a transmit dwell time on a channel, based upon bluetooth theory the transmitter is on 0.625 * 5 per 296.25 ms per channel. Therefore, the duty cycle correlation factor be equal to: $20\log(3.125 / 100) = -30.1$ dB.
- Average value = peak reading + $20\log(\text{duty cycle})$.



A D T

BELOW 1GHz WORST-CASE DATA : 8DPSK

EUT TEST CONDITION		MEASUREMENT DETAIL	
CHANNEL	Channel 39	FREQUENCY RANGE	Below 1000MHz
INPUT POWER (SYSTEM)	120Vac, 60 Hz	DETECTOR FUNCTION	Quasi-Peak
ENVIRONMENTAL CONDITIONS	21deg. C, 65%RH	TESTED BY	Sun Lin

ANTENNA POLARITY & TEST DISTANCE: HORIZONTAL AT 3 M								
NO.	FREQ. (MHz)	EMISSION LEVEL (dBuV/m)	LIMIT (dBuV/m)	MARGIN (dB)	ANTENNA HEIGHT (m)	TABLE ANGLE (Degree)	RAW VALUE (dBuV)	CORRECTION FACTOR (dB/m)
1	64.92	23.7 QP	40.0	-16.3	1.25 H	359	10.80	12.90
2	113.42	29.9 QP	43.5	-13.6	1.50 H	321	18.80	11.10
3	140.58	22.2 QP	43.5	-21.3	1.00 H	91	8.60	13.60
4	262.80	22.6 QP	46.0	-23.4	1.25 H	250	9.10	13.50
5	321.00	22.1 QP	46.0	-23.9	1.00 H	277	6.70	15.40
6	544.10	26.9 QP	46.0	-19.1	2.00 H	3	5.80	21.10

ANTENNA POLARITY & TEST DISTANCE: VERTICAL AT 3 M								
NO.	FREQ. (MHz)	EMISSION LEVEL (dBuV/m)	LIMIT (dBuV/m)	MARGIN (dB)	ANTENNA HEIGHT (m)	TABLE ANGLE (Degree)	RAW VALUE (dBuV)	CORRECTION FACTOR (dB/m)
1	45.52	28.5 QP	40.0	-11.5	1.00 V	238	14.60	13.90
2	64.92	27.4 QP	40.0	-12.6	1.00 V	127	14.50	12.90
3	111.48	24.7 QP	43.5	-18.8	1.00 V	20	13.90	10.80
4	189.08	23.1 QP	43.5	-20.4	1.00 V	234	11.10	12.00
5	216.24	22.3 QP	46.0	-23.7	1.25 V	31	10.50	11.80
6	243.40	26.6 QP	46.0	-19.4	1.00 V	17	13.80	12.80

REMARKS:

1. Emission level (dBuV/m) = Raw Value (dBuV) + Correction Factor (dB/m).
2. Correction Factor (dB/m) = Antenna Factor (dB/m) + Cable Factor (dB).
3. The other emission levels were very low against the limit.
4. Margin value = Emission level – Limit value.

4.2 CONDUCTED EMISSION MEASUREMENT

4.2.1 LIMITS OF CONDUCTED EMISSION MEASUREMENT

FREQUENCY OF EMISSION (MHz)	CONDUCTED LIMIT (dB μ V)	
	Quasi-peak	Average
0.15 ~ 0.5	66 to 56	56 to 46
0.5 ~ 5	56	46
5 ~ 30	60	50

- NOTE:**
1. The lower limit shall apply at the transition frequencies.
 2. The limit decreases in line with the logarithm of the frequency in the range of 0.15 to 0.50 MHz.
 3. All emanations from a class A/B digital device or system, including any network of conductors and apparatus connected thereto, shall not exceed the level of field strengths specified above.

4.2.2 TEST INSTRUMENTS

DESCRIPTION & MANUFACTURER	MODEL NO.	SERIAL NO.	DATE OF CALIBRATION	DUE DATE OF CALIBRATION
Test Receiver ROHDE & SCHWARZ	ESCS30	100289	Nov. 19, 2011	Nov. 18, 2012
RF signal cable Woken	5D-FB	Cable-HYCO2-01	Dec. 22, 2011	Dec. 21, 2012
LISN ROHDE & SCHWARZ	ESH2-Z5	100100	Dec. 30, 2011	Dec. 29, 2012
LISN ROHDE & SCHWARZ	ESH3-Z5	100312	Jul. 07, 2011	Jul. 06, 2012
V-LISN SCHWARZBECK	NNBL 8226-2	8226-142	Jun. 30, 2011	Jun. 29, 2012
LISN ROHDE & SCHWARZ	ENV216	100072	Jun. 10, 2011	Jun. 09, 2012
Software ADT	ADT_Cond_ V7.3.7	NA	NA	NA

- NOTE:**
1. The calibration interval of the above test instruments is 12 months and the calibrations are traceable to NML/ROC and NIST/USA.
 2. The test was performed in HwaYa Shielded Room 2.
 3. The VCCI Site Registration No. is C-2047.

4.2.3 TEST PROCEDURES

- a. The EUT was placed 0.4 meters from the conducting wall of the shielded room with EUT being connected to the power mains through a line impedance stabilization network (LISN). Other support units were connected to the power mains through another LISN. The two LISNs provide 50 ohm/ 50uH of coupling impedance for the measuring instrument.
- b. Both lines of the power mains connected to the EUT were checked for maximum conducted interference.
- c. The frequency range from 150kHz to 30MHz was searched. Emission levels under (Limit - 20dB) was not recorded.

NOTE: All modes of operation were investigated and the worst-case emissions are reported.

4.2.4 DEVIATION FROM TEST STANDARD

No deviation.

4.2.5 TEST SETUP

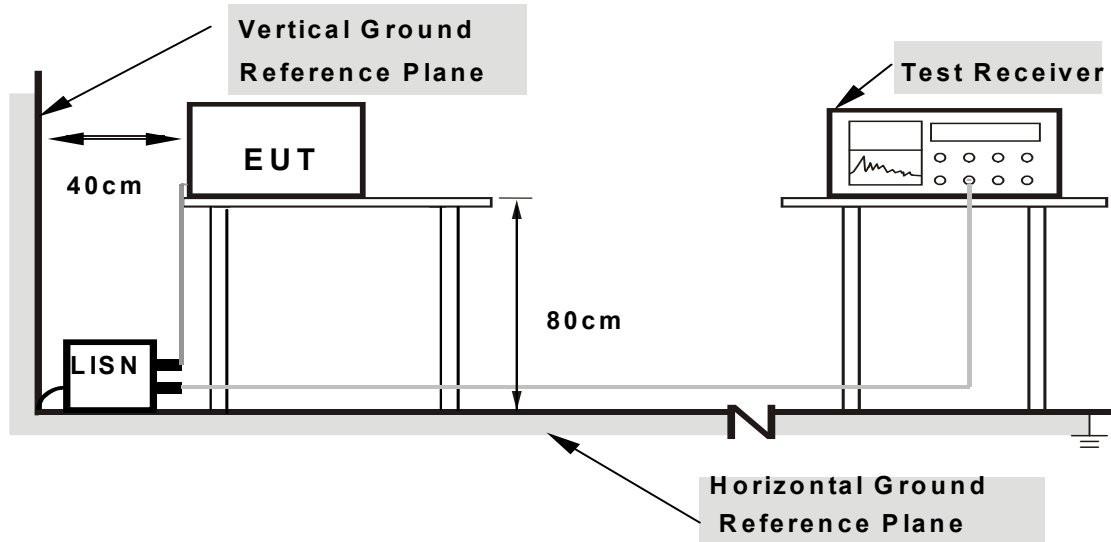

Note: 1.Support units were connected to second LISN.

2.Both of LISNs (AMN) are 80 cm from EUT and at least 80 from other units and other metal planes

For the actual test configuration, please refer to the attached file (Test Setup Photo).

4.2.6 EUT OPERATING CONDITIONS

Same as 4.1.6.

4.2.7 TEST RESULTS

CONDUCTED WORST CASE DATA: 8DPSK

PHASE	Line 1	6dB BANDWIDTH	9kHz
-------	--------	---------------	------

No	Freq. [MHz]	Corr. Factor (dB)	Reading Value		Emission Level		Limit		Margin	
			[dB (uV)]		[dB (uV)]		[dB (uV)]		(dB)	
			Q.P.	AV.	Q.P.	AV.	Q.P.	AV.	Q.P.	AV.
1	0.15000	0.17	36.17	15.08	36.34	15.25	66.00	56.00	-29.66	-40.75
2	0.16953	0.17	38.55	19.64	38.72	19.81	64.98	54.98	-26.26	-35.17
3	0.55625	0.21	34.96	26.94	35.17	27.15	56.00	46.00	-20.83	-18.85
4	0.90781	0.23	30.09	22.73	30.32	22.96	56.00	46.00	-25.68	-23.04
5	8.18750	0.45	34.18	25.59	34.63	26.04	60.00	50.00	-25.37	-23.96
6	11.70703	0.52	33.11	25.89	33.63	26.41	60.00	50.00	-26.37	-23.59

- REMARKS:**
1. Q.P. and AV. are abbreviations of quasi-peak and average individually.
 2. The emission levels of other frequencies were very low against the limit.
 3. Margin value = Emission level - Limit value
 4. Correction factor = Insertion loss + Cable loss
 5. Emission Level = Correction Factor + Reading Value.

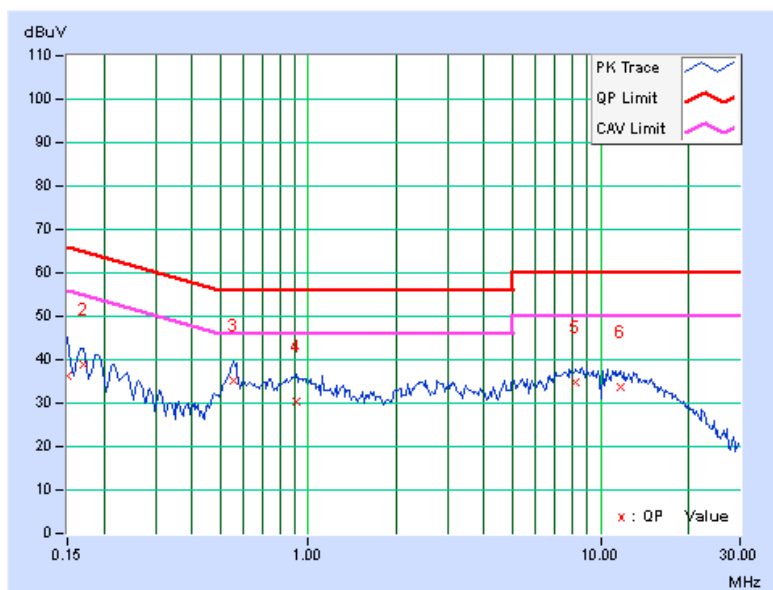

PHASE	Line 2	6dB BANDWIDTH	9kHz
-------	--------	---------------	------

No	Freq. [MHz]	Corr. Factor (dB)	Reading Value		Emission Level		Limit		Margin	
			[dB (uV)]		[dB (uV)]		[dB (uV)]		(dB)	
			Q.P.	AV.	Q.P.	AV.	Q.P.	AV.	Q.P.	AV.
1	0.16743	0.16	40.66	25.92	40.82	26.08	65.09	55.09	-24.26	-29.00
2	0.18906	0.15	37.29	17.84	37.44	17.99	64.08	54.08	-26.63	-36.08
3	0.54453	0.18	29.80	20.95	29.98	21.13	56.00	46.00	-26.02	-24.87
4	0.94688	0.19	27.67	19.96	27.86	20.15	56.00	46.00	-28.14	-25.85
5	7.51953	0.49	27.85	20.91	28.34	21.40	60.00	50.00	-31.66	-28.60
6	9.04688	0.54	30.17	23.77	30.71	24.31	60.00	50.00	-29.29	-25.69

- REMARKS:**
1. Q.P. and AV. are abbreviations of quasi-peak and average individually.
 2. The emission levels of other frequencies were very low against the limit.
 3. Margin value = Emission level - Limit value
 4. Correction factor = Insertion loss + Cable loss
 5. Emission Level = Correction Factor + Reading Value.

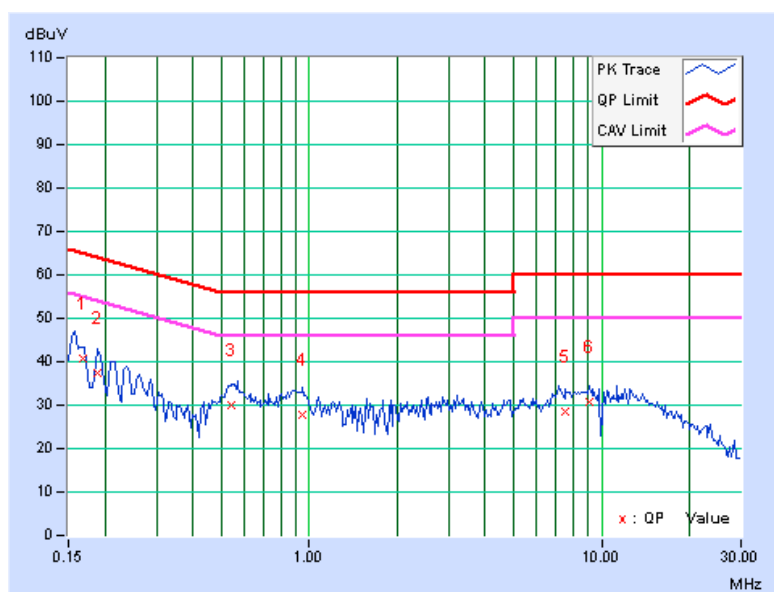

4.3 NUMBER OF HOPPING FREQUENCY USED

4.3.1 LIMIT OF HOPPING FREQUENCY USED

At least 15 channels frequencies, and should be equally spaced.

4.3.2 TEST SETUP

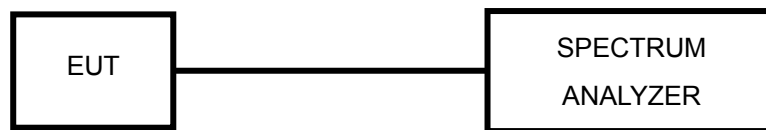

4.3.3 TEST INSTRUMENTS

Refer to section 4.1.2 to get information of above instrument.

4.3.4 TEST PROCEDURES

- a. Check the calibration of the measuring instrument (SA) using either an internal calibrator or a known signal from an external generator.
- b. Turn on the EUT and connect its antenna terminal to measurement via a low loss cable. Then set it to any one measured frequency within its operating range and make sure the instrument is operated in its linear range.
- c. Set the SA on MaxHold Mode, and then keep the EUT in hopping mode. Record all the signals from each channel until each one has been recorded.
- d. Set the SA on View mode and then plot the result on SA screen.
- e. Repeat above procedures until all frequencies measured were complete.

4.3.5 DEVIATION FROM TEST STANDARD

No deviation.

4.3.6 TEST RESULTS

There are 79 hopping frequencies in the hopping mode. Please refer to next two pages for the test result. On the plots, it shows that the hopping frequencies are equally spaced.



A D T

GFSK

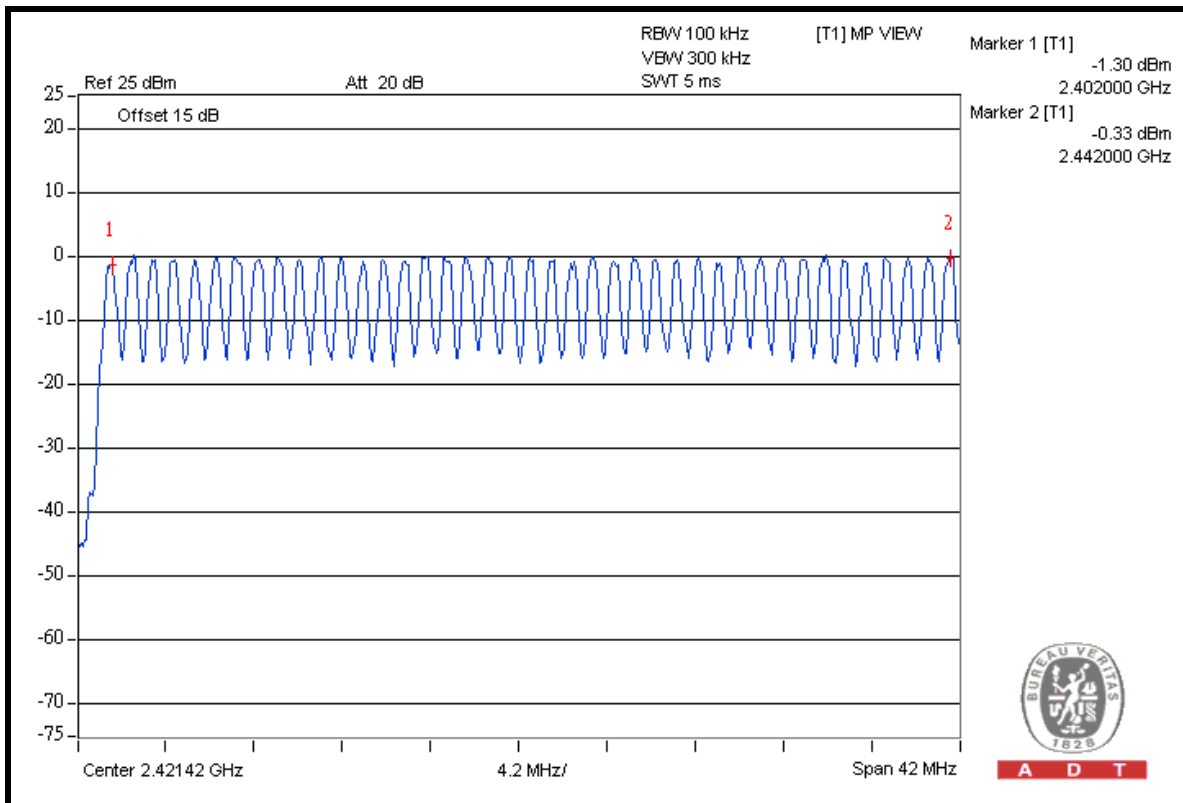

A D T

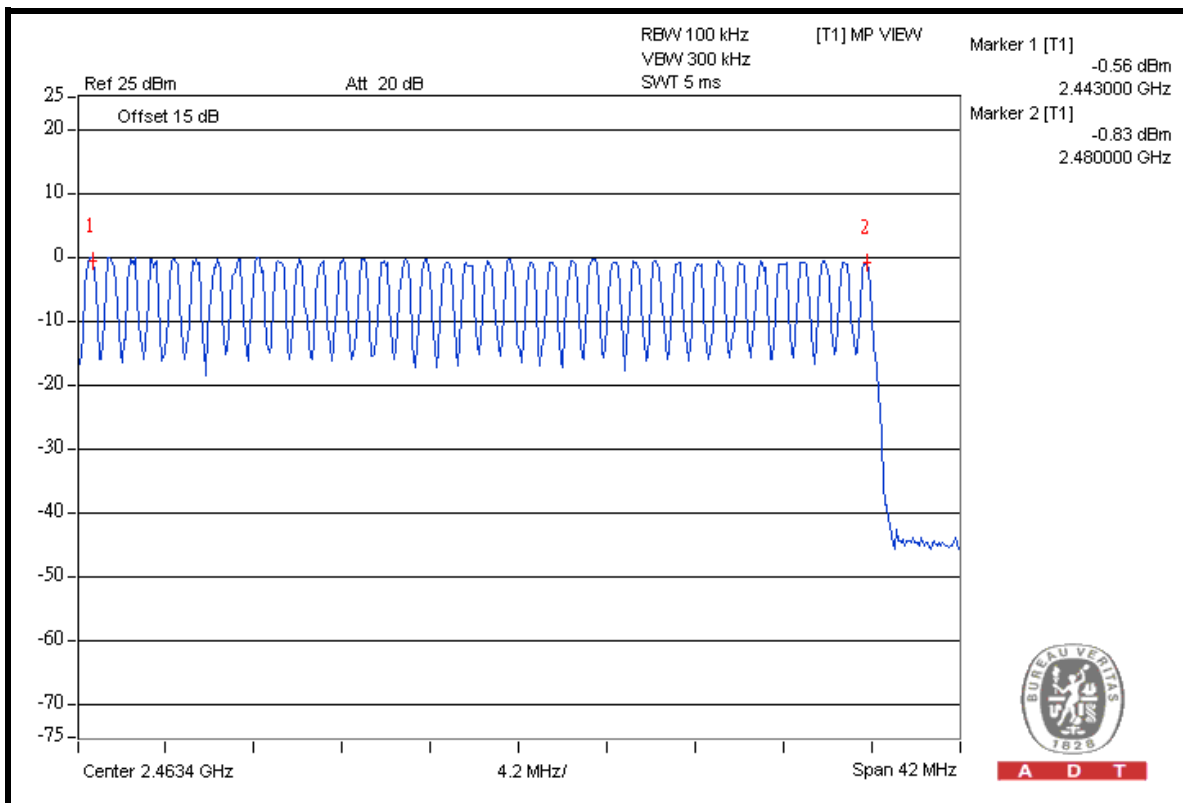

A D T



A D T

$\pi/4$ -DQPSK

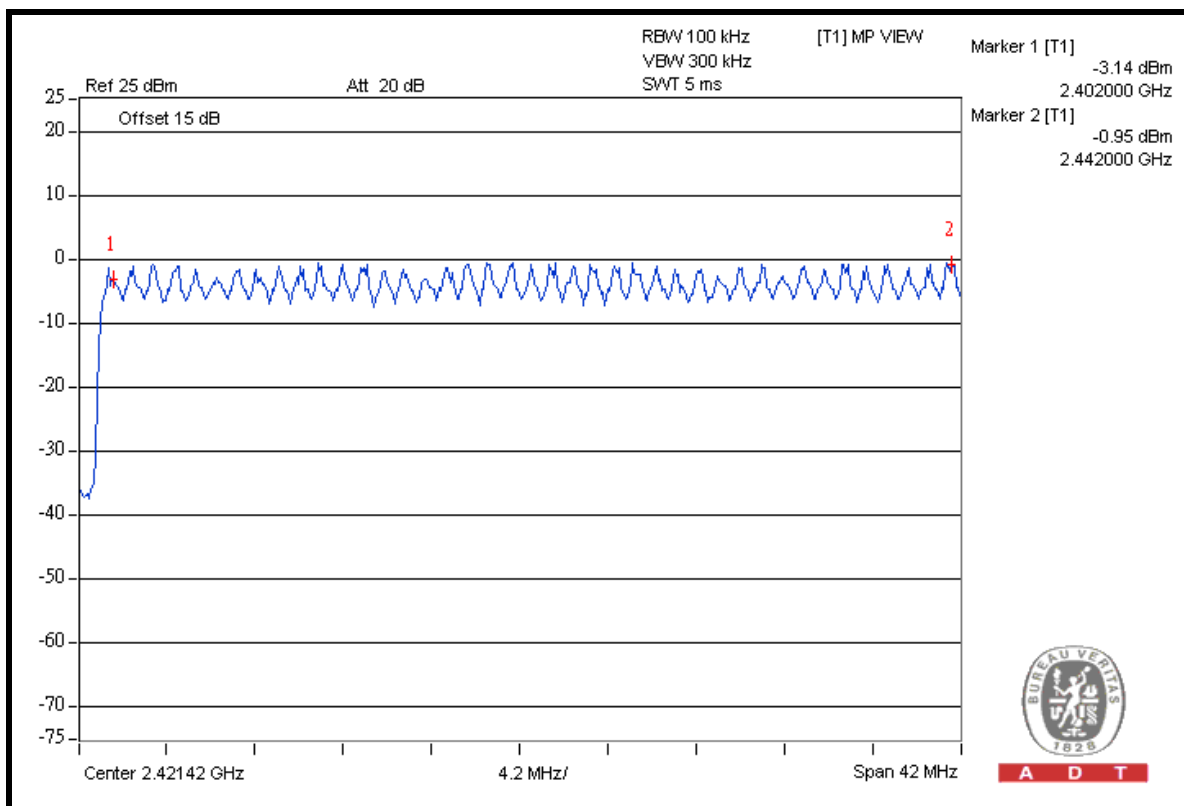

A D T

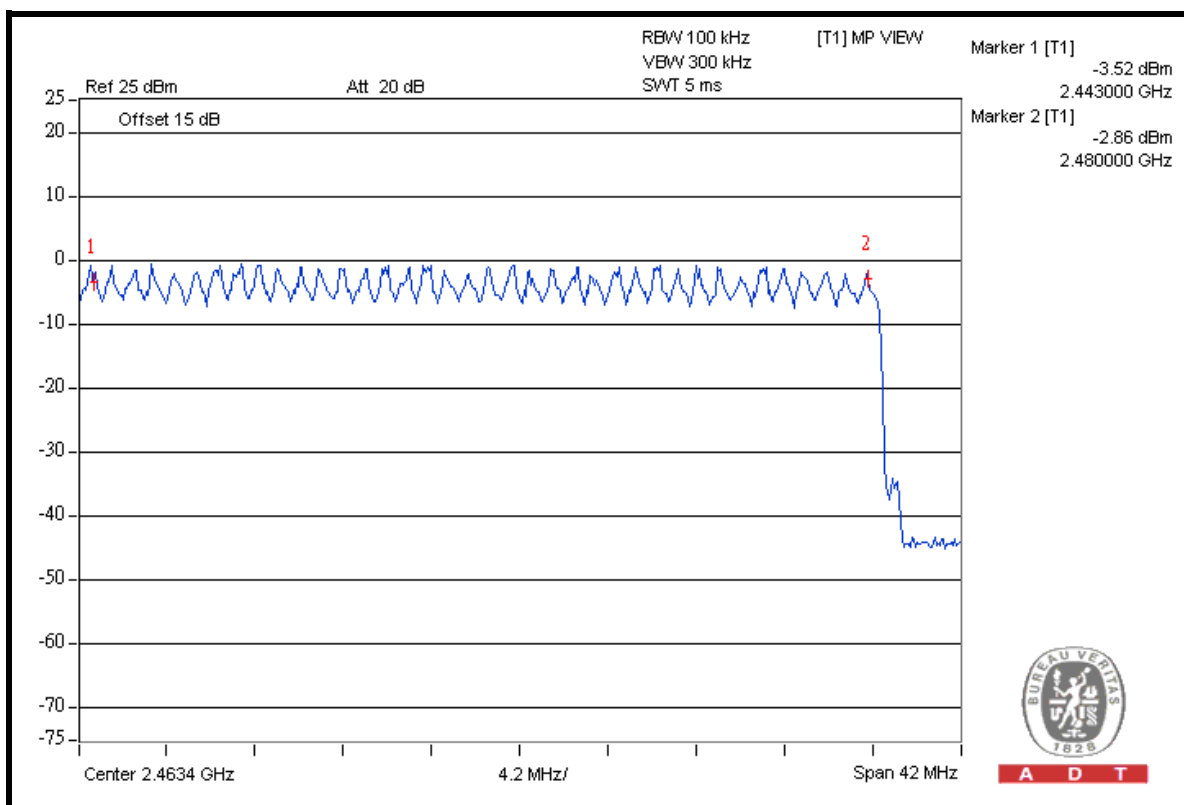

A D T



A D T

8DPSK

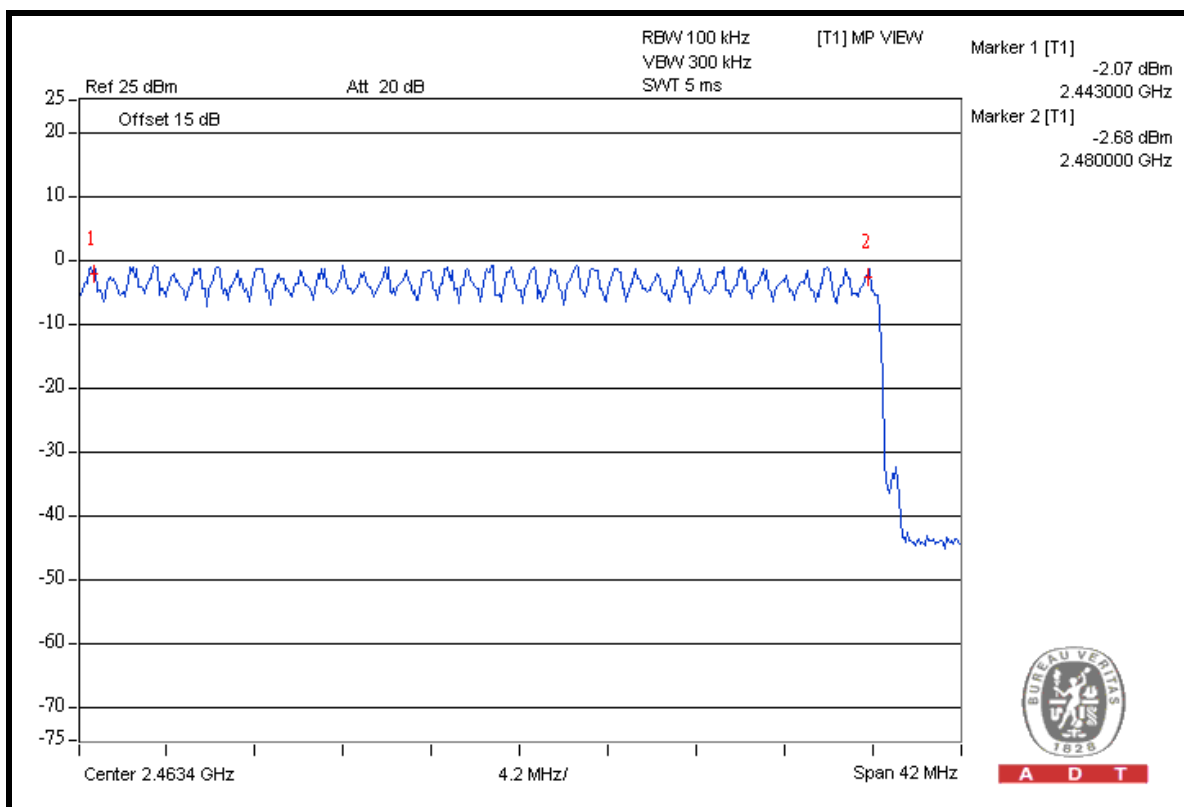
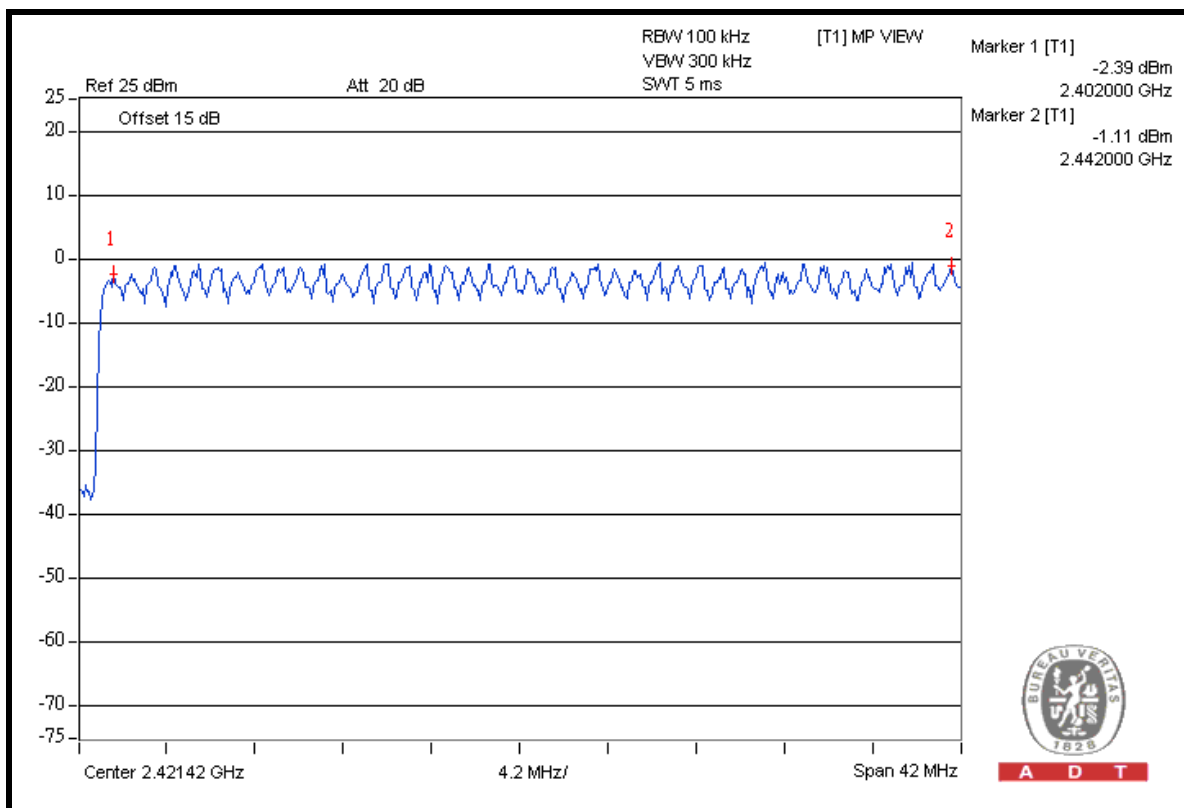

4.4 DWELL TIME ON EACH CHANNEL

4.4.1 LIMIT OF DWELL TIME USED

The average time of occupancy on any channel shall not be greater than 0.4 seconds within a period of 0.4 seconds multiplied by the number of hopping channels employed.

4.4.2 TEST SETUP

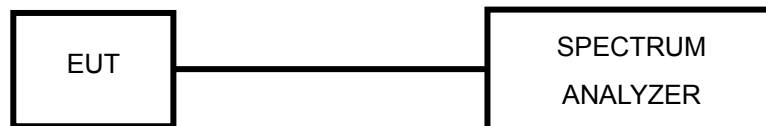

4.4.3 TEST INSTRUMENTS

Refer to section 4.1.2 to get information of above instrument.

4.4.4 TEST PROCEDURES

- a. Check the calibration of the measuring instrument (SA) using either an internal calibrator or a known signal from an external generator.
- b. Turn on the EUT and connect its antenna terminal to measurement via a low loss cable. Then set it to any one measured frequency within its operating range and make sure the instrument is operated in its linear range.
- c. Adjust the center frequency of SA on any frequency be measured and set SA to zero span mode. And then, set RBW and VBW of spectrum analyzer to proper value.
- d. Measure the time duration of one transmission on the measured frequency. And then plot the result with time difference of this time duration.
- e. Repeat above procedures until all different time-slot modes have been completed.

4.4.5 DEVIATION FROM TEST STANDARD

No deviation.



A D T

4.4.6 TEST RESULTS

GFSK

Mode	Number of transmission in a 31.6 (79Hopping*0.4)	Length of transmission time (msec)	Result (msec)	Limit (msec)
DH1	$50 \text{ (times / 5 sec)} * 6.32 = 316.00 \text{ times}$	0.444	140.304	400
DH3	$25 \text{ (times / 5 sec)} * 6.32 = 158.00 \text{ times}$	1.728	273.024	400
DH5	$17 \text{ (times / 5 sec)} * 6.32 = 107.44 \text{ times}$	2.980	320.171	400

NOTE: Test plots of the transmitting time slot are shown as below.

DH1

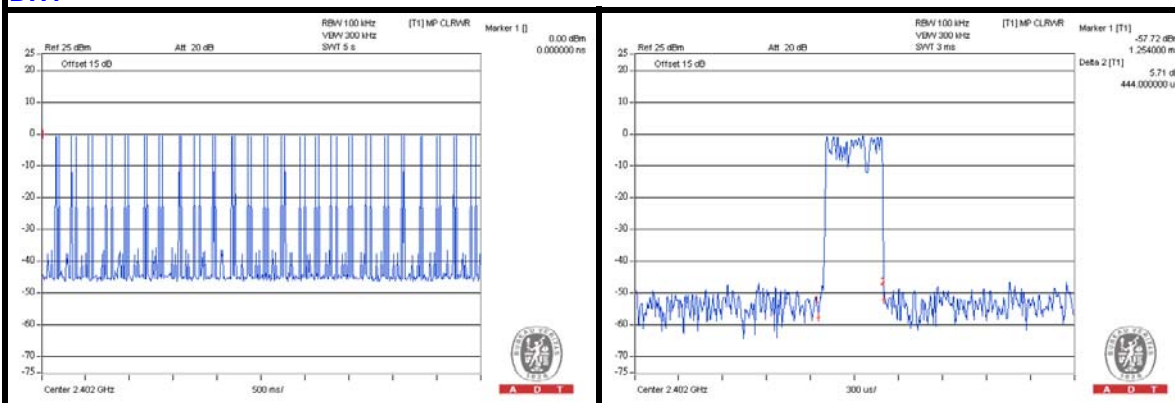

DH3

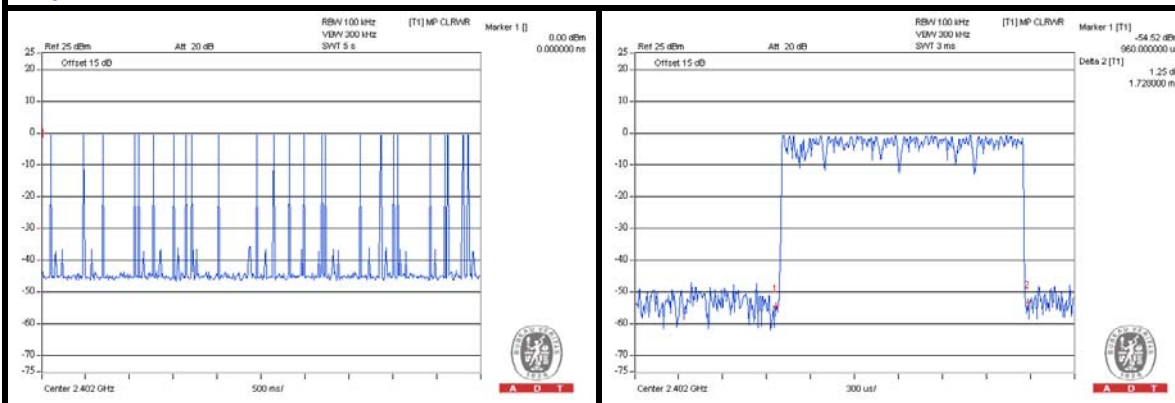

DH5

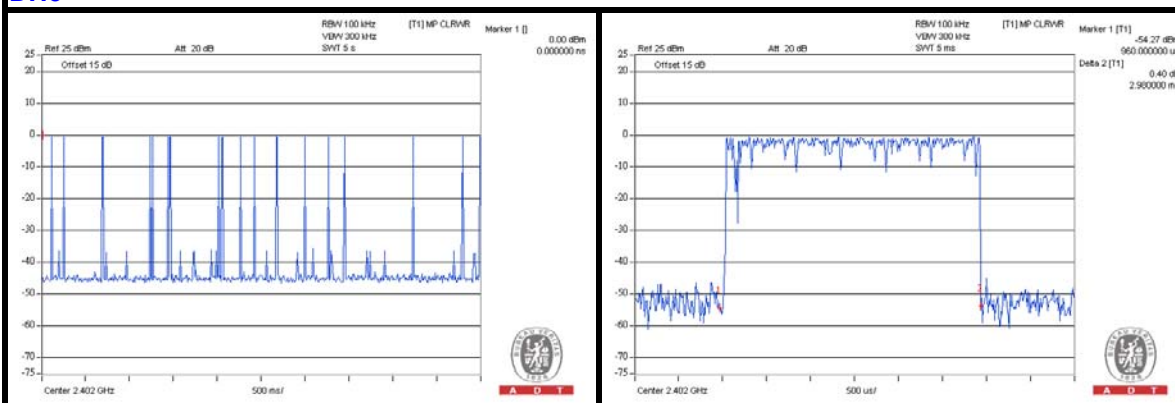

$\pi/4$ -DQPSK

Mode	Number of transmission in a 31.6 (79Hopping*0.4)	Length of transmission time (msec)	Result (msec)	Limit (msec)
DH1	50 (times / 5 sec) * 6.32 = 316.00 times	0.462	145.992	400
DH3	27 (times / 5 sec) * 6.32 = 170.64 times	1.692	288.723	400
DH5	17 (times / 5 sec) * 6.32 = 107.44 times	2.940	315.874	400

NOTE: Test plots of the transmitting time slot are shown as below.

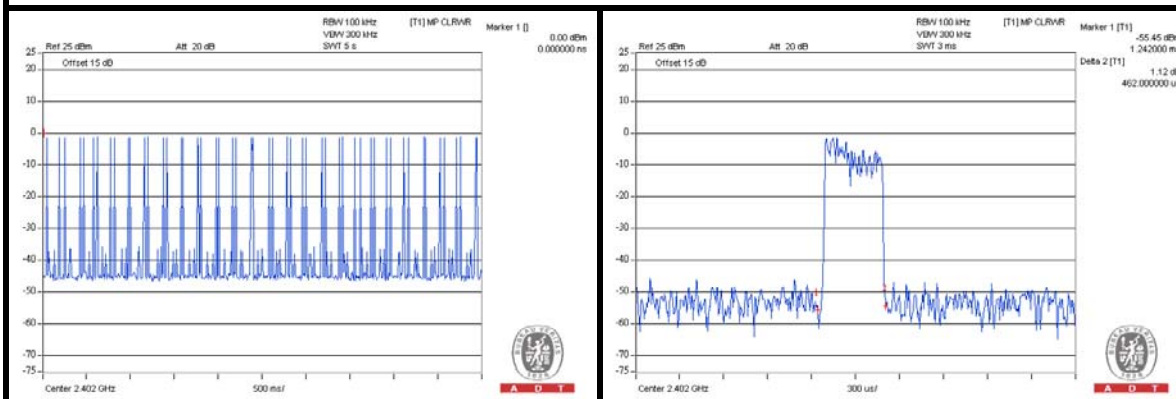
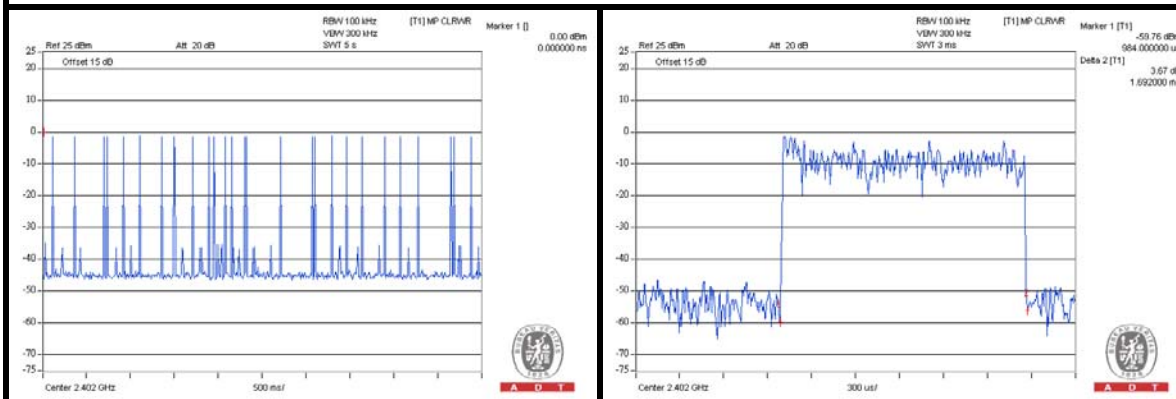
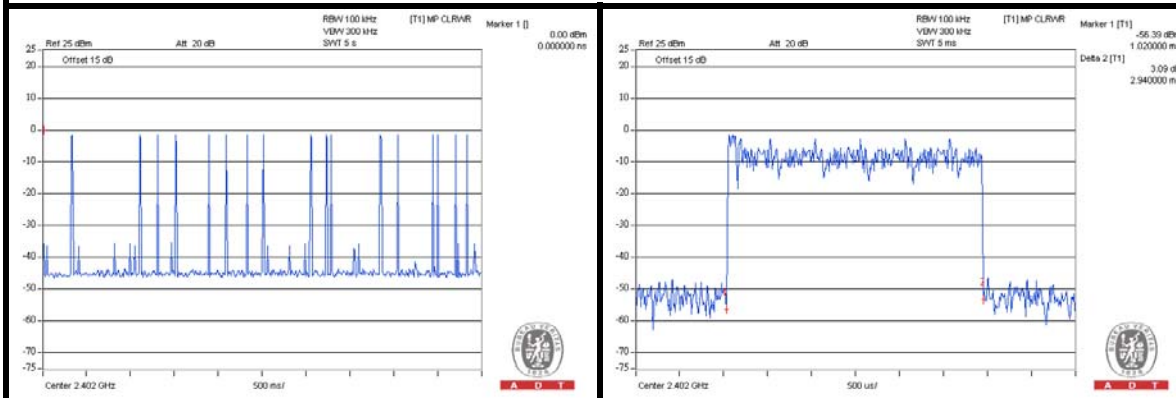
DH1

DH3

DH5



A D T

8DPSK

Mode	Number of transmission in a 31.6 (79Hopping*0.4)	Length of transmission time (msec)	Result (msec)	Limit (msec)
DH1	50 (times / 5 sec) * 6.32 = 316.00 times	0.456	144.096	400
DH3	27 (times / 5 sec) * 6.32 = 170.64 times	1.704	290.771	400
DH5	18 (times / 5 sec) * 6.32 = 113.76 times	2.960	336.730	400

NOTE: Test plots of the transmitting time slot are shown as below.

DH1

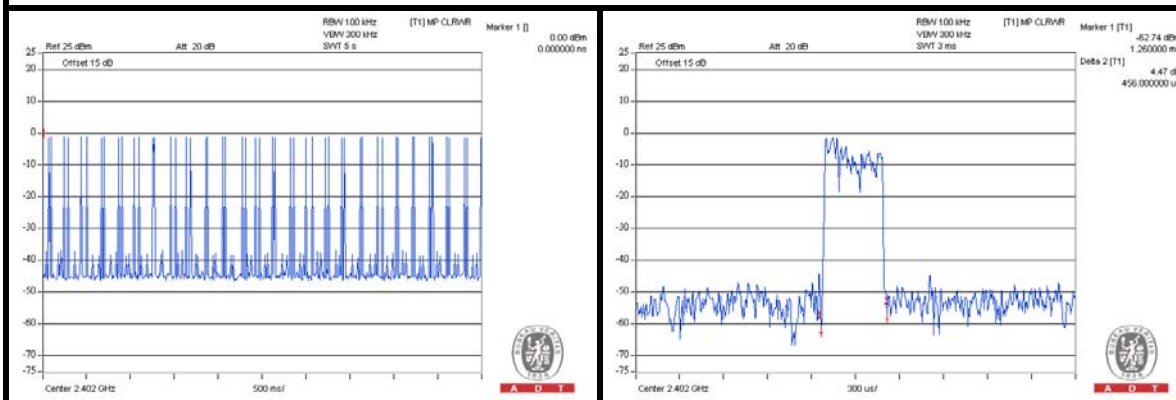

DH3

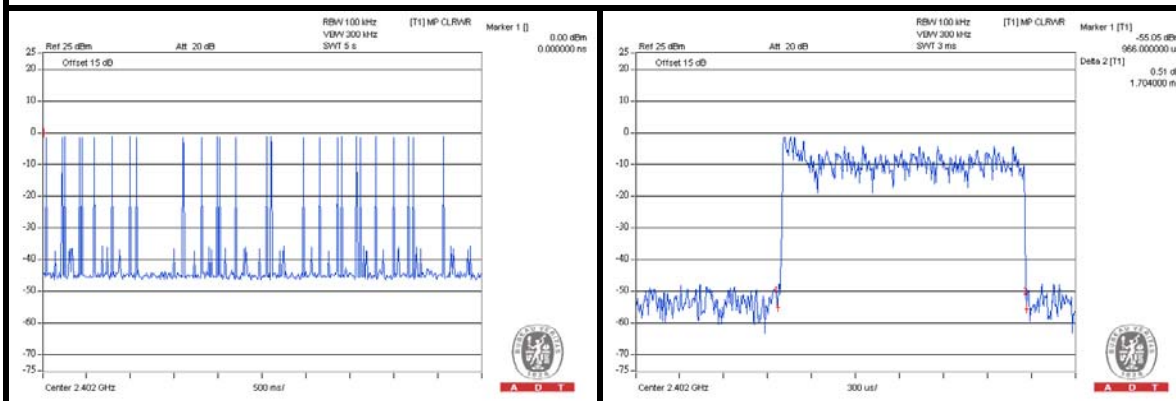

DH5

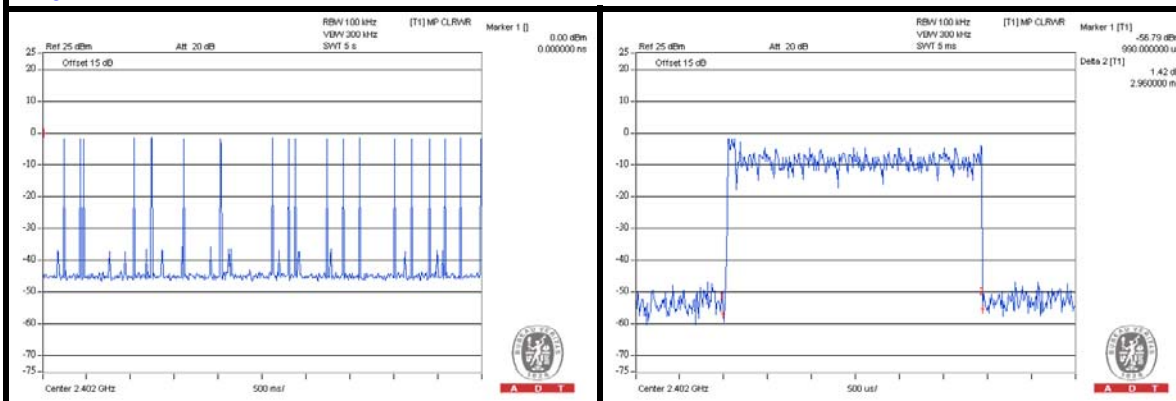

4.5 CHANNEL BANDWIDTH

4.5.1 LIMITS OF CHANNEL BANDWIDTH

For frequency hopping system operating in the 2400-2483.5MHz, If the 20dB bandwidth of hopping channel is greater than 25kHz, two-thirds 20dB bandwidth of hopping channel shall be a minimum limit for the hopping channel separation.

4.5.2 TEST SETUP

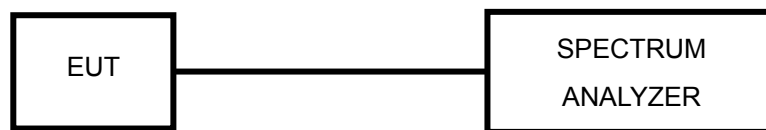

4.5.3 TEST INSTRUMENTS

Refer to section 4.1.2 to get information of above instrument.

4.5.4 TEST PROCEDURE

- a. Check the calibration of the measuring instrument using either an internal calibrator or a known signal from an external generator.
- b. Turn on the EUT and connect it to measurement instrument. Then set it to any one convenient frequency within its operating range. Set a reference level on the measuring instrument equal to the highest peak value.
- c. Measure the frequency difference of two frequencies that were attenuated 20dB from the reference level. Record the frequency difference as the emission bandwidth.
- d. Repeat above procedures until all frequencies measured were complete.

4.5.5 DEVIATION FROM TEST STANDARD

No deviation.

4.5.6 EUT OPERATING CONDITION

The software provided by client enabled the EUT to transmit and receive data at lowest, middle and highest channel frequencies individually.

4.5.7 TEST RESULTS

GFSK

CHANNEL	CHANNEL FREQUENCY (MHz)	20dB BANDWIDTH (MHz)
0	2402	0.948
39	2441	0.965
78	2480	1.000

CH 78

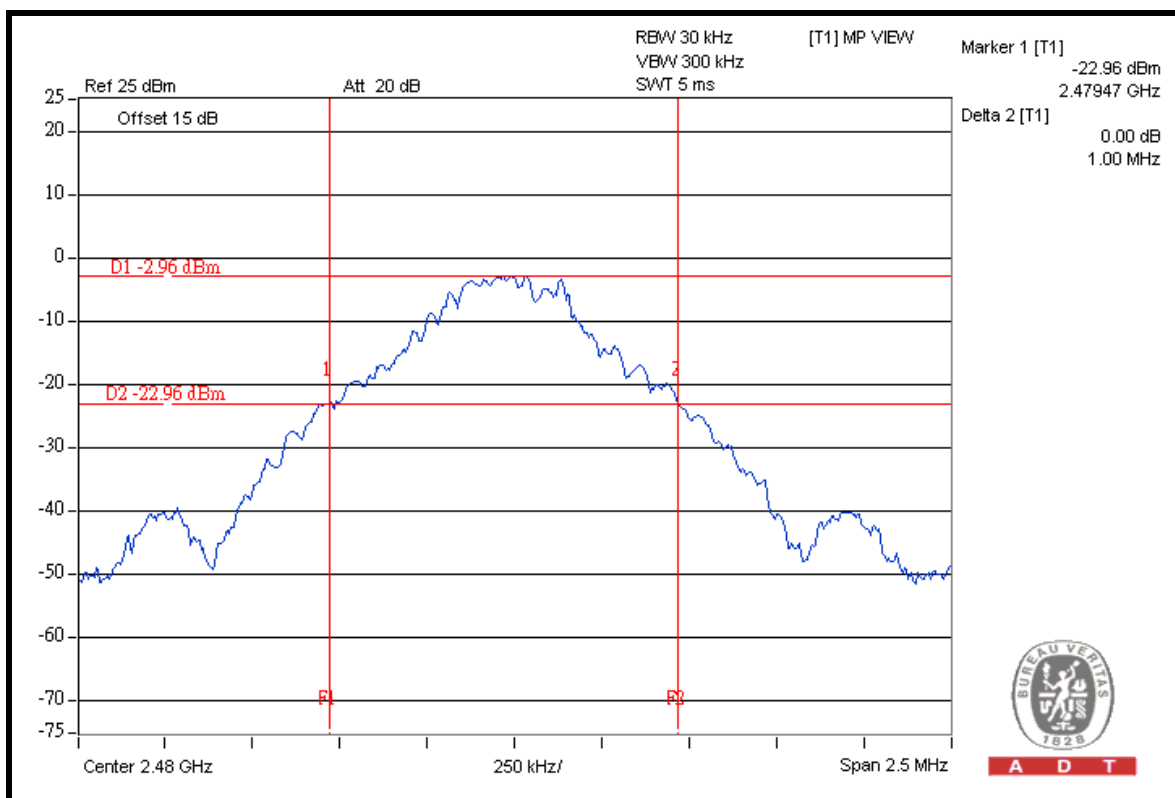



A D T

$\pi/4$ -DQPSK

CHANNEL	CHANNEL FREQUENCY (MHz)	20dB BANDWIDTH (MHz)
0	2402	1.280
39	2441	1.320
78	2480	1.310

CH 39

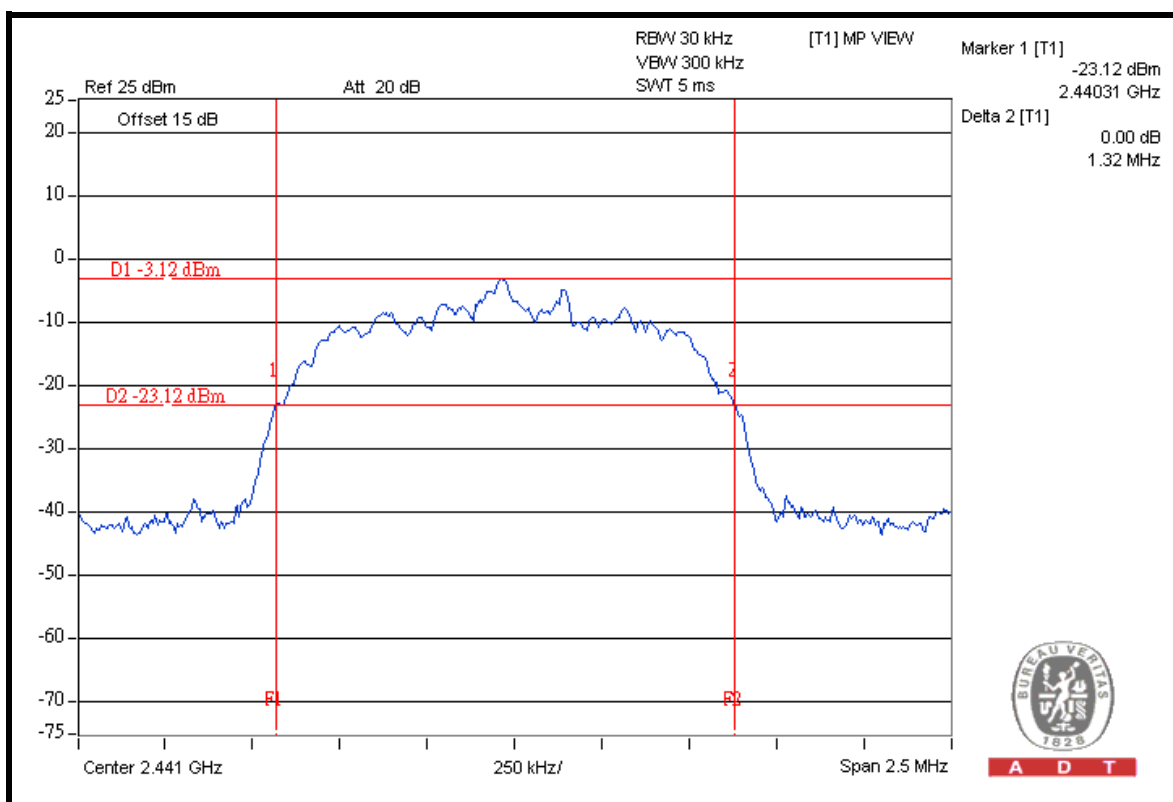

A D T



A D T

8DPSK

CHANNEL	CHANNEL FREQUENCY (MHz)	20dB BANDWIDTH (MHz)
0	2402	1.310
39	2441	1.310
78	2480	1.310

CH 0

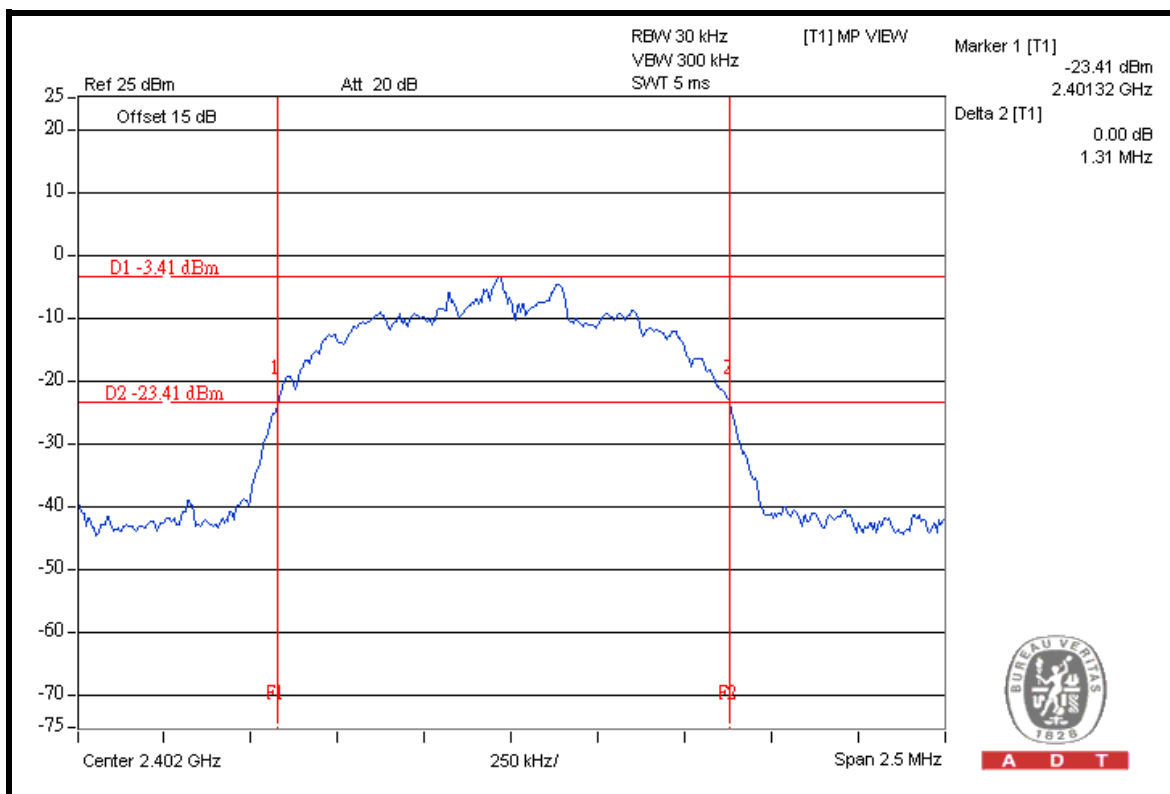

4.6 HOPPING CHANNEL SEPARATION

4.6.1 LIMIT OF HOPPING CHANNEL SEPARATION

At least 25kHz or two-third of 20dB hopping channel bandwidth (whichever is greater).

4.6.2 TEST SETUP

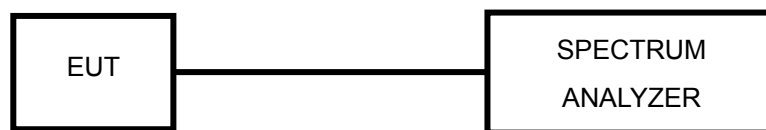

4.6.3 TEST INSTRUMENTS

Refer to section 4.1.2 to get information of above instrument.

4.6.4 TEST PROCEDURES

1. Check the calibration of the measuring instrument using either an internal calibrator or a known signal from an external generator.
2. Turn on the EUT and connect it to measurement instrument. Then set it to any one convenient frequency within its operating range.
3. By using the MaxHold function record the separation of two adjacent channels.
4. Measure the frequency difference of these two adjacent channels by SA MARK function. And then plot the result on SA screen.
5. Repeat above procedures until all frequencies measured were complete.

4.6.5 DEVIATION FROM TEST STANDARD

No deviation.

4.6.6 TEST RESULTS

GFSK

CHANNEL	FREQUENCY (MHz)	ADJACENT CHANNEL SEPARATION (MHz)	20dB BANDWIDTH (MHz)	MINIMUM LIMIT (MHz)	PASS / FAIL
0	2402	1.000	0.948	0.632	PASS
39	2441	1.000	0.965	0.643	PASS
78	2480	1.000	1.000	0.667	PASS

$\pi/4$ -DQPSK

CHANNEL	FREQUENCY (MHz)	ADJACENT CHANNEL SEPARATION (MHz)	20dB BANDWIDTH (MHz)	MINIMUM LIMIT (MHz)	PASS / FAIL
0	2402	1.010	1.280	0.853	PASS
39	2441	1.010	1.320	0.880	PASS
78	2480	1.000	1.310	0.873	PASS

8DPSK

CHANNEL	FREQUENCY (MHz)	ADJACENT CHANNEL SEPARATION (MHz)	20dB BANDWIDTH (MHz)	MINIMUM LIMIT (MHz)	PASS / FAIL
0	2402	1.000	1.310	0.873	PASS
39	2441	1.010	1.310	0.873	PASS
78	2480	1.010	1.310	0.873	PASS

NOTE: The minimum limit is two-third 20dB bandwidth.



A D T

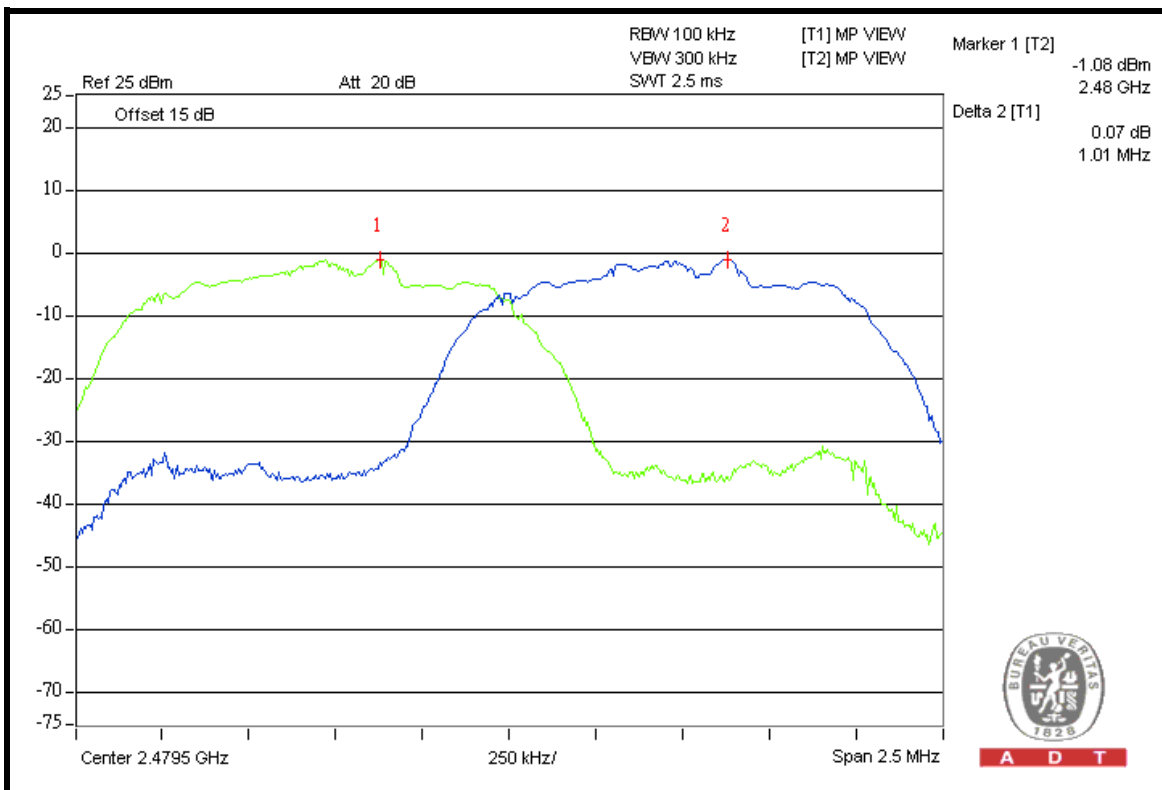

A D T

4.7 MAXIMUM OUTPUT POWER

4.7.1 LIMITS OF MAXIMUM OUTPUT POWER MEASUREMENT

The Maximum Output Power Measurement is 125mW.

4.7.2 TEST SETUP

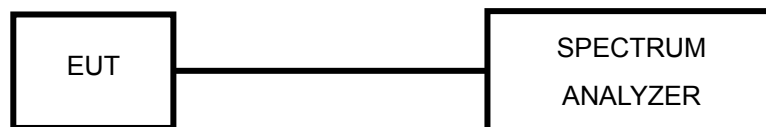

4.7.3 TEST INSTRUMENTS

Refer to section 4.1.2 to get information of above instrument.

4.7.4 TEST PROCEDURES

- a. Check the calibration of the measuring instrument using either an internal calibrator or a known signal from an external generator.
- b. Turn on the EUT and connect it to measurement instrument. Then set it to any one convenient frequency within its operating range. Set a reference level on the measuring instrument equal to the highest peak value.
- c. The center frequency of the spectrum analyzer is set to the fundamental frequency and using 3MHz RBW and 10 MHz VBW.
- d. Measure the captured power within the band and recording the plot.
- e. Repeat above procedures until all frequencies required were complete.

4.7.5 DEVIATION FROM TEST STANDARD

No deviation.

4.7.6 EUT OPERATING CONDITION

The software provided by client enabled the EUT to transmit and receive data at lowest, middle and highest channel frequencies individually.

4.7.7 TEST RESULTS

GFSK

CHANNEL	CHANNEL FREQUENCY (MHz)	OUTPUT POWER (mW)	OUTPUT POWER (dBm)	POWER LIMIT (mW)	PASS/FAIL
0	2402	1.045	0.19	125	PASS
39	2441	1.089	0.37	125	PASS
78	2480	0.993	-0.03	125	PASS

$\pi/4$ -DQPSK

CHANNEL	CHANNEL FREQUENCY (MHz)	OUTPUT POWER (mW)	OUTPUT POWER (dBm)	POWER LIMIT (mW)	PASS/FAIL
0	2402	1.211	0.83	125	PASS
39	2441	1.262	1.01	125	PASS
78	2480	1.151	0.61	125	PASS

8DPSK

CHANNEL	CHANNEL FREQUENCY (MHz)	OUTPUT POWER (mW)	OUTPUT POWER (dBm)	POWER LIMIT (mW)	PASS/FAIL
0	2402	1.253	0.98	125	PASS
39	2441	1.297	1.13	125	PASS
78	2480	1.186	0.74	125	PASS



A D T

8DPSK CH 39

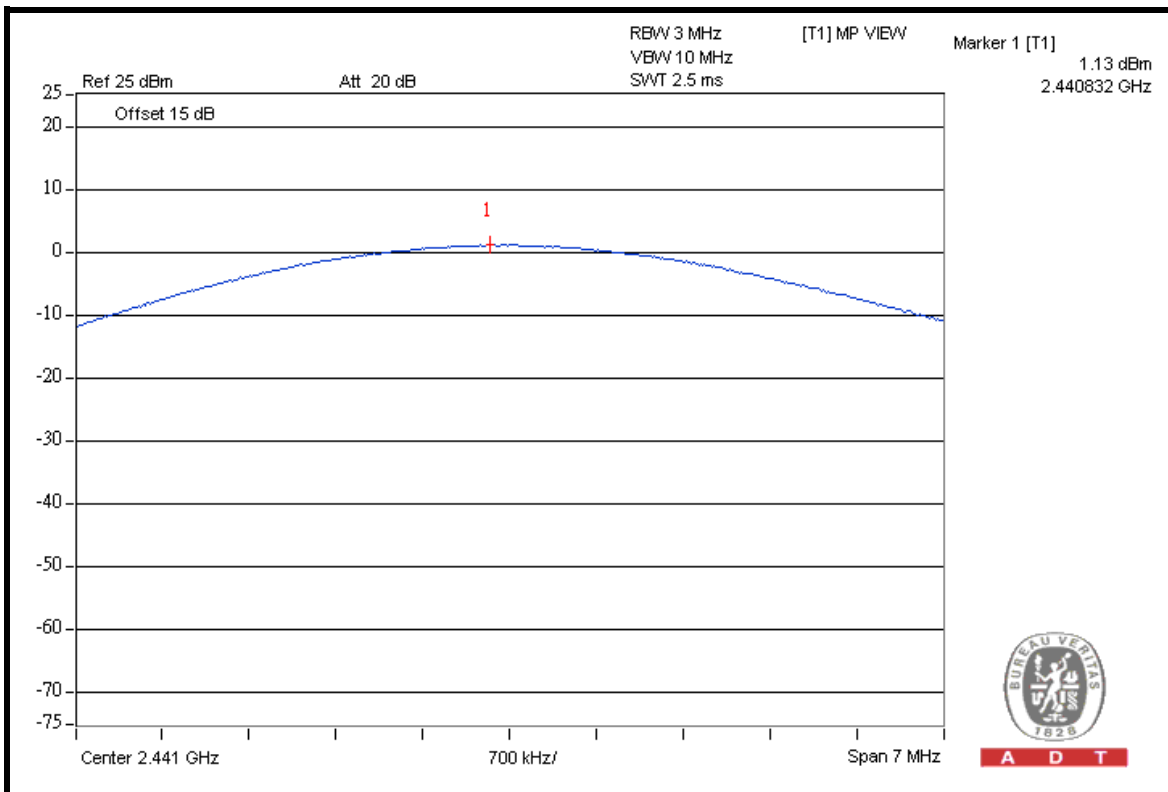

A D T

4.8 CONDUCTED OUT OF BAND EMISSION MEASUREMENT

4.8.1 LIMITS OF CONDUCTED OUT OF BAND EMISSION MEASUREMENT

Below -20dB of the highest emission level of operating band (in 100kHz RBW).

4.8.2 TEST INSTRUMENTS

Refer to section 4.1.2 to get information of above instrument.

4.8.3 TEST PROCEDURE

1. Set RBW = 100 kHz .
2. Set VBW = 300 kHz .
3. Set span to encompass the spectrum to be examined
4. Detector = peak.
5. Trace Mode = max hold.
6. Sweep = auto couple.

4.8.4 DEVIATION FROM TEST STANDARD

No deviation.

4.8.5 EUT OPERATING CONDITION

The software provided by client enabled the EUT to transmit continuously.

4.8.6 TEST RESULTS

The spectrum plots are attached on the following images. D1 line indicates the highest level, D2 line indicates the 20dB offset below D1. It shows compliance with the requirement.



A D T

GFSK

Hopping disabled

Low Channel

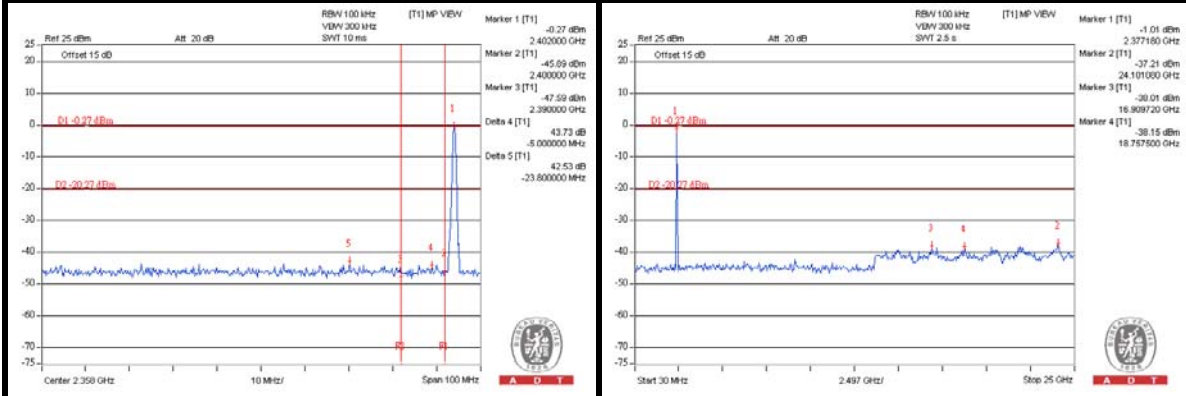

High Channel

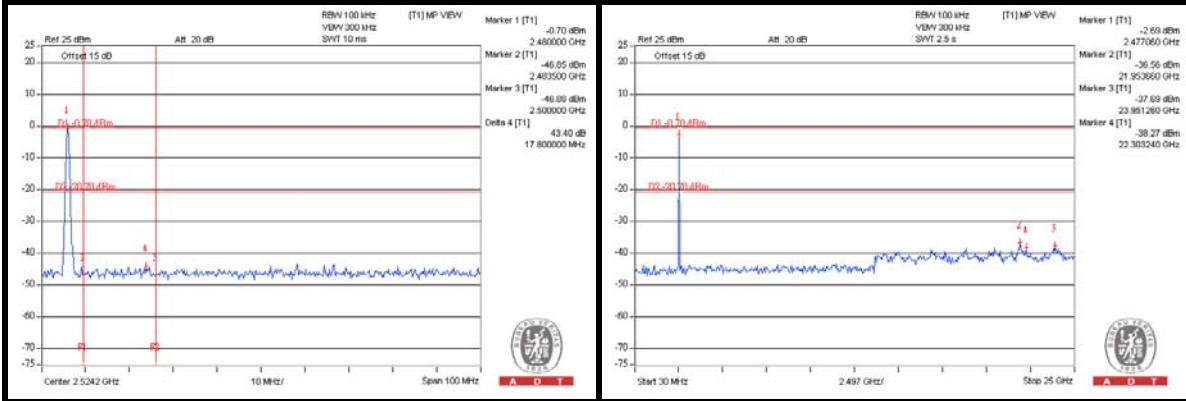



A D T

Hopping enabled

Low Channel

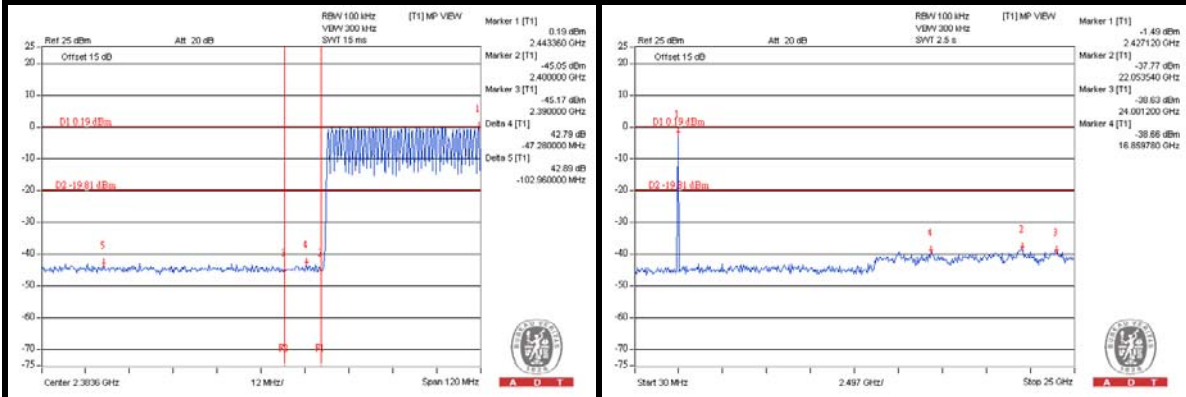

High Channel

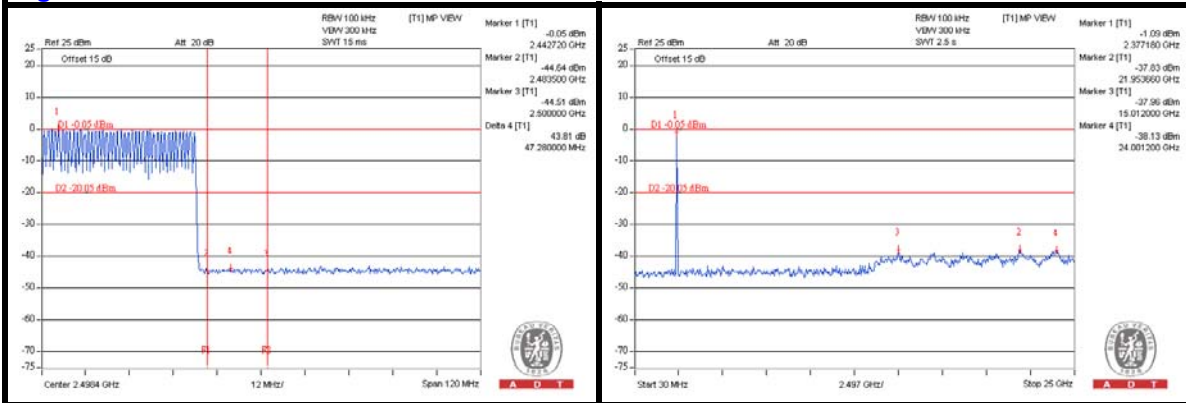



A D T

$\pi/4$ -DQPSK Hopping disabled

Low Channel

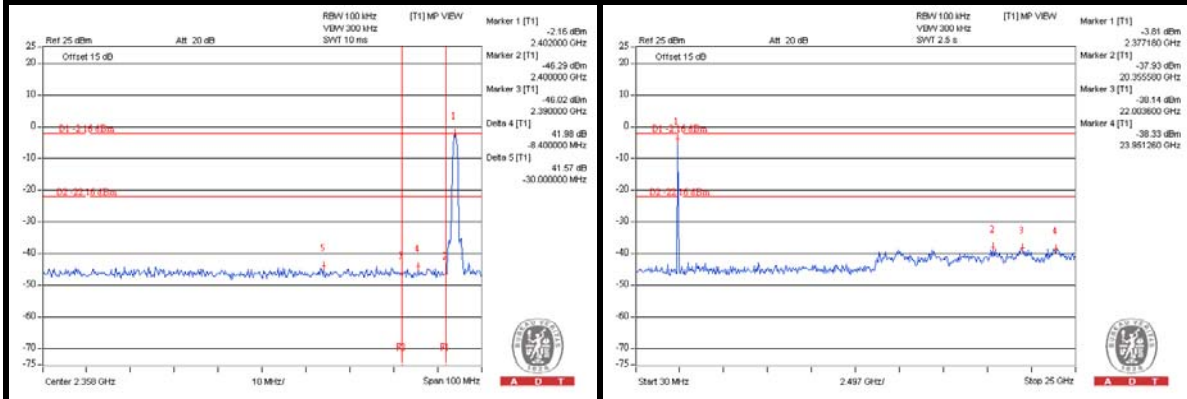

High Channel

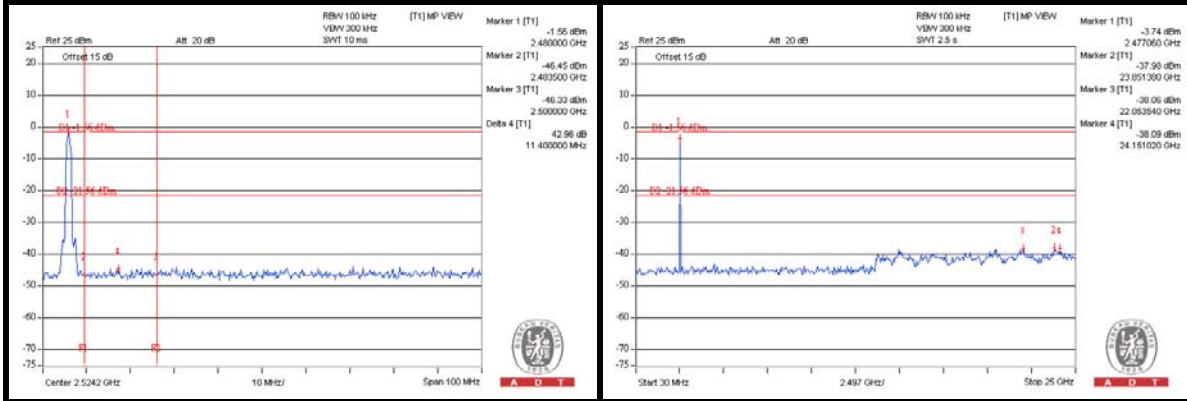



A D T

Hopping enabled

Low Channel

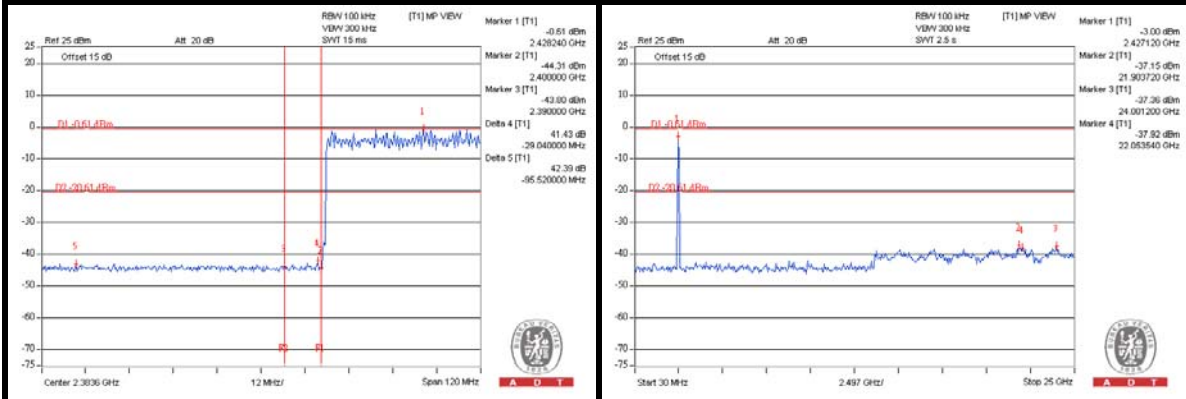

High Channel

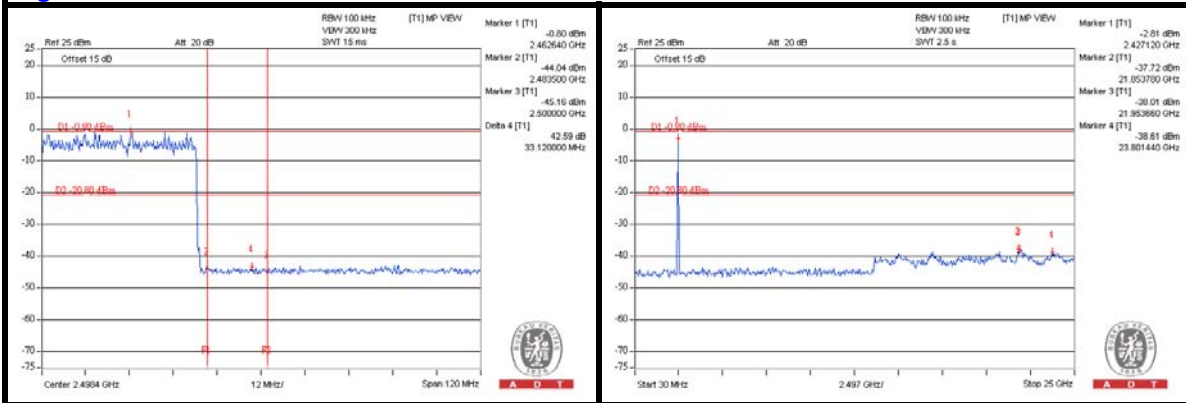

8DPSK
Hopping disabled

Low Channel

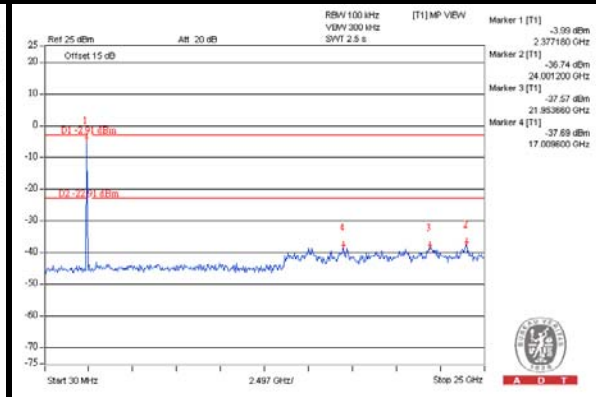
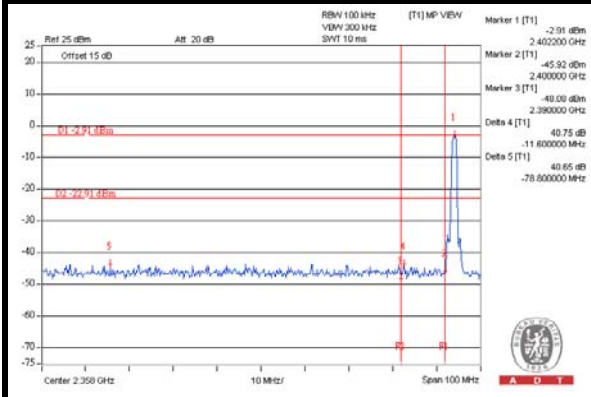

High Channel

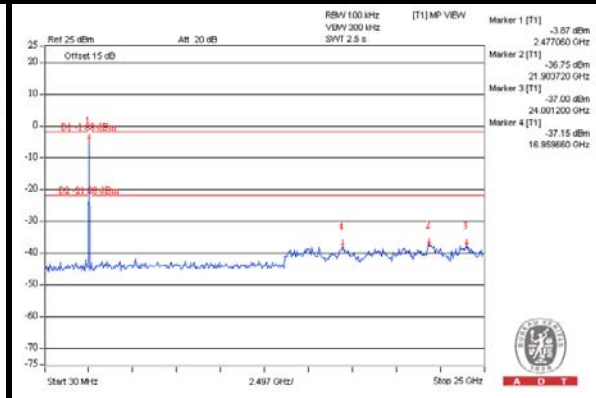
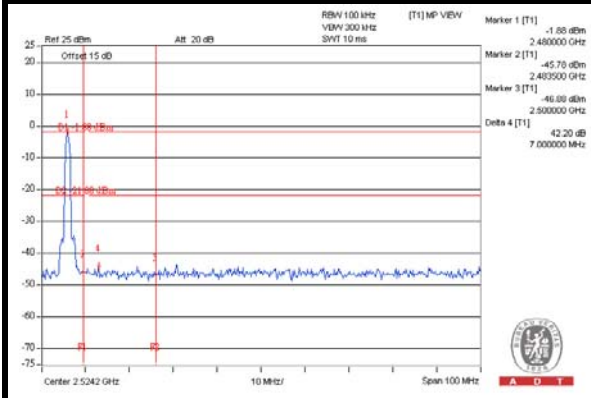



A D T

Hopping enabled

Low Channel

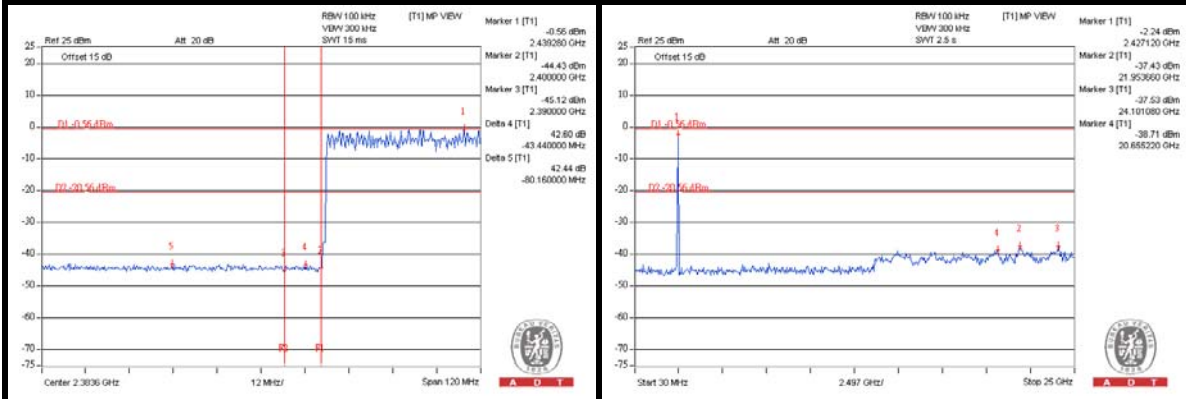

High Channel

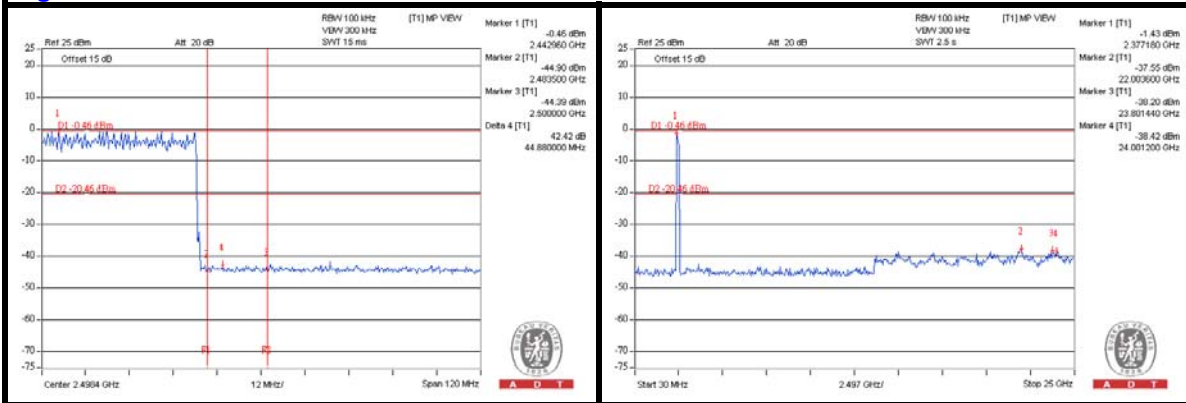

5. TEST TYPES AND RESULTS (FOR Bluetooth LE 4.0)

5.1 RADIATED EMISSION AND BANDEDGE MEASUREMENT

5.1.1 LIMITS OF RADIATED EMISSION AND BANDEDGE MEASUREMENT

Same as 4.1.1.

5.1.2 TEST INSTRUMENTS

Same as 4.1.2.

5.1.3 TEST PROCEDURES

Same as 4.1.3.

5.1.4 DEVIATION FROM TEST STANDARD

No deviation.

5.1.5 TEST SETUP

Same as 4.1.5.

5.1.6 EUT OPERATING CONDITIONS

Same as 4.1.6.

5.1.7 TEST RESULTS

ABOVE 1GHz DATA

EUT TEST CONDITION		MEASUREMENT DETAIL	
CHANNEL	Channel 0	FREQUENCY RANGE	1 ~ 25GHz
INPUT POWER (SYSTEM)	120Vac, 60 Hz	DETECTOR FUNCTION	Peak (PK) Average (AV)
ENVIRONMENTAL CONDITIONS	25deg. C, 65%RH	TESTED BY	Anderson Hong

ANTENNA POLARITY & TEST DISTANCE: HORIZONTAL AT 3 M								
NO.	FREQ. (MHz)	EMISSION LEVEL (dBuV/m)	LIMIT (dBuV/m)	MARGIN (dB)	ANTENNA HEIGHT (m)	TABLE ANGLE (Degree)	RAW VALUE (dBuV)	CORRECTION FACTOR (dB/m)
1	2390.00	54.5 PK	74.0	-19.5	1.33 H	60	23.10	31.40
2	2390.00	43.8 AV	54.0	-10.2	1.33 H	60	12.40	31.40
3	*2402.00	95.9 PK			1.33 H	60	64.50	31.40
4	*2402.00	94.6 AV			1.33 H	60	63.20	31.40
5	4804.00	50.9 PK	74.0	-23.1	1.30 H	27	13.50	37.40
6	4804.00	42.8 AV	54.0	-11.2	1.30 H	27	5.40	37.40
ANTENNA POLARITY & TEST DISTANCE: VERTICAL AT 3 M								
NO.	FREQ. (MHz)	EMISSION LEVEL (dBuV/m)	LIMIT (dBuV/m)	MARGIN (dB)	ANTENNA HEIGHT (m)	TABLE ANGLE (Degree)	RAW VALUE (dBuV)	CORRECTION FACTOR (dB/m)
1	2390.00	54.5 PK	74.0	-19.5	1.23 V	343	23.10	31.40
2	2390.00	43.6 AV	54.0	-10.4	1.23 V	343	12.20	31.40
3	*2402.00	91.1 PK			1.23 V	343	59.70	31.40
4	*2402.00	89.8 AV			1.23 V	343	58.40	31.40
5	4804.00	53.0 PK	74.0	-21.0	1.22 V	29	15.60	37.40
6	4804.00	45.1 AV	54.0	-8.9	1.22 V	29	7.70	37.40

REMARKS:

1. Emission level (dBuV/m) = Raw Value (dBuV) + Correction Factor (dB/m).
2. Correction Factor (dB/m) = Antenna Factor (dB/m) + Cable Factor (dB).
3. The other emission levels were very low against the limit.
4. Margin value = Emission level – Limit value.
5. “ * “: Fundamental frequency.



A D T

EUT TEST CONDITION		MEASUREMENT DETAIL	
CHANNEL	Channel 19	FREQUENCY RANGE	1 ~ 25GHz
INPUT POWER (SYSTEM)	120Vac, 60 Hz	DETECTOR FUNCTION	Peak (PK) Average (AV)
ENVIRONMENTAL CONDITIONS	25deg. C, 65%RH	TESTED BY	Anderson Hong

ANTENNA POLARITY & TEST DISTANCE: HORIZONTAL AT 3 M								
NO.	FREQ. (MHz)	EMISSION LEVEL (dBuV/m)	LIMIT (dBuV/m)	MARGIN (dB)	ANTENNA HEIGHT (m)	TABLE ANGLE (Degree)	RAW VALUE (dBuV)	CORRECTION FACTOR (dB/m)
1	*2440.00	96.6 PK			1.31 H	64	65.00	31.60
2	*2440.00	95.4 AV			1.31 H	64	63.80	31.60
3	4880.00	50.6 PK	74.0	-23.4	1.27 H	24	13.00	37.60
4	4880.00	42.6 AV	54.0	-11.4	1.27 H	24	5.00	37.60
5	7320.00	50.1 PK	74.0	-23.9	1.61 H	324	6.30	43.80
6	7320.00	38.0 AV	54.0	-16.0	1.61 H	324	-5.80	43.80
ANTENNA POLARITY & TEST DISTANCE: VERTICAL AT 3 M								
NO.	FREQ. (MHz)	EMISSION LEVEL (dBuV/m)	LIMIT (dBuV/m)	MARGIN (dB)	ANTENNA HEIGHT (m)	TABLE ANGLE (Degree)	RAW VALUE (dBuV)	CORRECTION FACTOR (dB/m)
1	*2440.00	91.9 PK			1.16 V	346	60.30	31.60
2	*2440.00	90.5 AV			1.16 V	346	58.90	31.60
3	4880.00	52.9 PK	74.0	-21.1	1.22 V	8	15.30	37.60
4	4880.00	45.3 AV	54.0	-8.7	1.22 V	8	7.70	37.60
5	7320.00	49.9 PK	74.0	-24.1	1.23 V	69	6.10	43.80
6	7320.00	37.8 AV	54.0	-16.2	1.23 V	69	-6.00	43.80

REMARKS:

1. Emission level (dBuV/m) = Raw Value (dBuV) + Correction Factor (dB/m).
2. Correction Factor (dB/m) = Antenna Factor (dB/m) + Cable Factor (dB).
3. The other emission levels were very low against the limit.
4. Margin value = Emission level – Limit value.
5. “ * ”: Fundamental frequency.



A D T

EUT TEST CONDITION		MEASUREMENT DETAIL	
CHANNEL	Channel 39	FREQUENCY RANGE	1 ~ 25GHz
INPUT POWER (SYSTEM)	120Vac, 60 Hz	DETECTOR FUNCTION	Peak (PK) Average (AV)
ENVIRONMENTAL CONDITIONS	25deg. C, 65%RH	TESTED BY	Anderson Hong

ANTENNA POLARITY & TEST DISTANCE: HORIZONTAL AT 3 M								
NO.	FREQ. (MHz)	EMISSION LEVEL (dBuV/m)	LIMIT (dBuV/m)	MARGIN (dB)	ANTENNA HEIGHT (m)	TABLE ANGLE (Degree)	RAW VALUE (dBuV)	CORRECTION FACTOR (dB/m)
1	*2480.00	95.7 PK			1.28 H	61	64.00	31.70
2	*2480.00	94.4 AV			1.28 H	61	62.70	31.70
3	2483.50	54.6 PK	74.0	-19.4	1.28 H	61	22.90	31.70
4	2483.50	45.5 AV	54.0	-8.5	1.28 H	61	13.80	31.70
5	4960.00	50.3 PK	74.0	-23.7	1.30 H	21	12.50	37.80
6	4960.00	42.2 AV	54.0	-11.8	1.30 H	21	4.40	37.80
ANTENNA POLARITY & TEST DISTANCE: VERTICAL AT 3 M								
NO.	FREQ. (MHz)	EMISSION LEVEL (dBuV/m)	LIMIT (dBuV/m)	MARGIN (dB)	ANTENNA HEIGHT (m)	TABLE ANGLE (Degree)	RAW VALUE (dBuV)	CORRECTION FACTOR (dB/m)
1	*2480.00	91.4 PK			1.16 V	359	59.70	31.70
2	*2480.00	90.0 AV			1.16 V	359	58.30	31.70
3	2483.50	54.2 PK	74.0	-19.8	1.16 V	359	22.50	31.70
4	2483.50	44.1 AV	54.0	-9.9	1.16 V	359	12.40	31.70
5	4960.00	52.7 PK	74.0	-21.3	1.25 V	11	14.90	37.80
6	4960.00	45.0 AV	54.0	-9.0	1.25 V	11	7.20	37.80

REMARKS:

1. Emission level (dBuV/m) = Raw Value (dBuV) + Correction Factor (dB/m).
2. Correction Factor (dB/m) = Antenna Factor (dB/m) + Cable Factor (dB).
3. The other emission levels were very low against the limit.
4. Margin value = Emission level – Limit value.
5. “ * ”: Fundamental frequency.

BELOW 1GHZ WORST-CASE DATA

EUT TEST CONDITION		MEASUREMENT DETAIL	
CHANNEL	Channel 19	FREQUENCY RANGE	Below 1000MHz
INPUT POWER (SYSTEM)	120Vac, 60 Hz	DETECTOR FUNCTION	Quasi-Peak
ENVIRONMENTAL CONDITIONS	21deg. C, 65%RH	TESTED BY	Sun Lin

ANTENNA POLARITY & TEST DISTANCE: HORIZONTAL AT 3 M								
NO.	FREQ. (MHz)	EMISSION LEVEL (dBuV/m)	LIMIT (dBuV/m)	MARGIN (dB)	ANTENNA HEIGHT (m)	TABLE ANGLE (Degree)	RAW VALUE (dBuV)	CORRECTION FACTOR (dB/m)
1	64.92	22.8 QP	40.0	-17.2	1.25 H	3	9.90	12.90
2	113.42	29.4 QP	43.5	-14.1	1.50 H	299	18.30	11.10
3	138.64	21.8 QP	43.5	-21.7	1.25 H	281	8.30	13.50
4	262.80	23.0 QP	46.0	-23.0	1.25 H	261	9.50	13.50
5	515.00	25.6 QP	46.0	-20.4	2.00 H	266	5.10	20.50
6	544.10	27.2 QP	46.0	-18.8	1.00 H	330	6.10	21.10
ANTENNA POLARITY & TEST DISTANCE: VERTICAL AT 3 M								
NO.	FREQ. (MHz)	EMISSION LEVEL (dBuV/m)	LIMIT (dBuV/m)	MARGIN (dB)	ANTENNA HEIGHT (m)	TABLE ANGLE (Degree)	RAW VALUE (dBuV)	CORRECTION FACTOR (dB/m)
1	43.58	28.3 QP	40.0	-11.7	1.00 V	261	14.50	13.80
2	64.92	26.7 QP	40.0	-13.3	1.00 V	174	13.80	12.90
3	107.60	24.7 QP	43.5	-18.8	1.25 V	184	14.30	10.40
4	189.08	22.9 QP	43.5	-20.6	1.00 V	65	10.90	12.00
5	243.40	26.8 QP	46.0	-19.2	1.00 V	40	14.00	12.80
6	838.98	29.7 QP	46.0	-16.3	1.25 V	214	4.10	25.60

REMARKS:

1. Emission level (dBuV/m) = Raw Value (dBuV) + Correction Factor (dB/m).
2. Correction Factor (dB/m) = Antenna Factor (dB/m) + Cable Factor (dB).
3. The other emission levels were very low against the limit.
4. Margin value = Emission level – Limit value.

5.2 CONDUCTED EMISSION MEASUREMENT

5.2.1 LIMITS OF CONDUCTED EMISSION MEASUREMENT

Same as 4.2.1.

5.2.2 TEST INSTRUMENTS

Same as 4.2.2.

5.2.3 TEST PROCEDURES

Same as 4.2.3.

5.2.4 DEVIATION FROM TEST STANDARD

No deviation.

5.2.5 TEST SETUP

Same as 4.2.5.

5.2.6 EUT OPERATING CONDITIONS

Same as 4.2.6.

5.2.7 TEST RESULTS

CONDUCTED WORST CASE DATA:

PHASE	Line 1	6dB BANDWIDTH	9kHz
--------------	--------	----------------------	------

No	Freq. [MHz]	Corr. Factor (dB)	Reading Value		Emission Level		Limit		Margin	
			[dB (uV)]		[dB (uV)]		[dB (uV)]		(dB)	
			Q.P.	AV.	Q.P.	AV.	Q.P.	AV.	Q.P.	AV.
1	0.15000	0.17	36.97	17.17	37.14	17.34	66.00	56.00	-28.86	-38.66
2	0.20078	0.17	33.57	15.73	33.74	15.90	63.58	53.58	-29.84	-37.68
3	0.56406	0.21	37.93	30.60	38.14	30.81	56.00	46.00	-17.86	-15.19
4	0.98594	0.23	32.05	24.05	32.28	24.28	56.00	46.00	-23.72	-21.72
5	2.39453	0.32	36.53	26.74	36.85	27.06	56.00	46.00	-19.15	-18.94
6	8.07813	0.45	33.56	25.88	34.01	26.33	60.00	50.00	-25.99	-23.67

- REMARKS:**
1. Q.P. and AV. are abbreviations of quasi-peak and average individually.
 2. The emission levels of other frequencies were very low against the limit.
 3. Margin value = Emission level - Limit value
 4. Correction factor = Insertion loss + Cable loss
 5. Emission Level = Correction Factor + Reading Value.

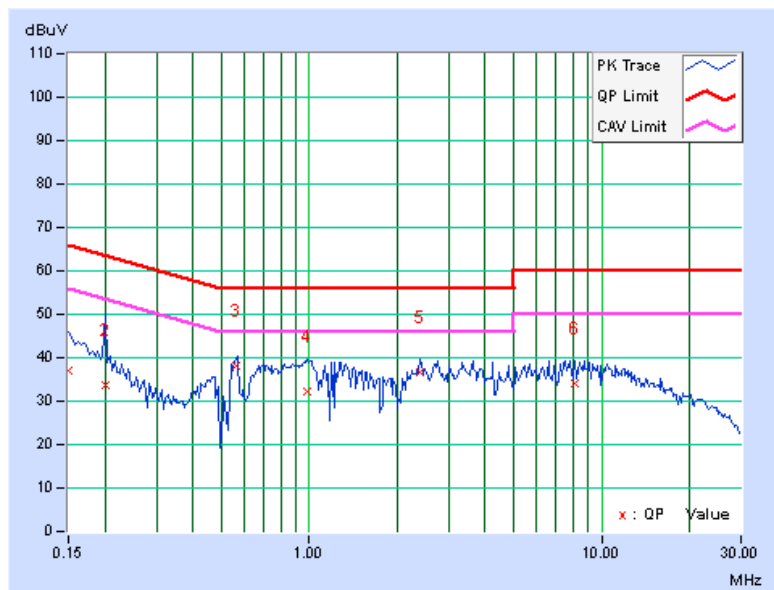

PHASE	Line 2	6dB BANDWIDTH	9kHz
-------	--------	---------------	------

No	Freq. [MHz]	Corr. Factor (dB)	Reading Value		Emission Level		Limit		Margin	
			[dB (uV)]		[dB (uV)]		[dB (uV)]		(dB)	
			Q.P.	AV.	Q.P.	AV.	Q.P.	AV.	Q.P.	AV.
1	0.18125	0.16	40.21	19.49	40.37	19.65	64.43	54.43	-24.06	-34.78
2	0.97813	0.19	30.27	20.00	30.46	20.19	56.00	46.00	-25.54	-25.81
3	1.41016	0.22	33.15	23.64	33.37	23.86	56.00	46.00	-22.63	-22.14
4	2.58594	0.30	32.17	21.46	32.47	21.76	56.00	46.00	-23.53	-24.24
5	5.80859	0.44	27.27	13.34	27.71	13.78	60.00	50.00	-32.29	-36.22
6	8.67578	0.53	30.41	21.86	30.94	22.39	60.00	50.00	-29.06	-27.61

- REMARKS:**
1. Q.P. and AV. are abbreviations of quasi-peak and average individually.
 2. The emission levels of other frequencies were very low against the limit.
 3. Margin value = Emission level - Limit value
 4. Correction factor = Insertion loss + Cable loss
 5. Emission Level = Correction Factor + Reading Value.

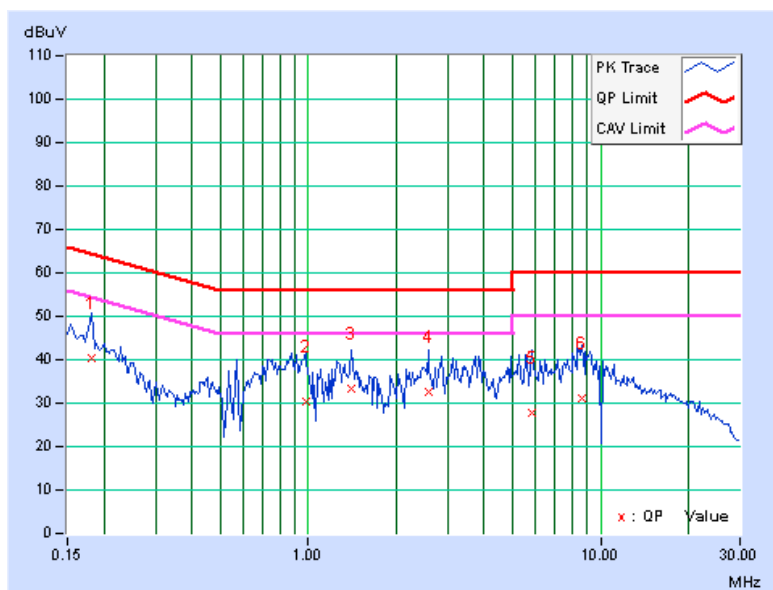

5.3 6dB BANDWIDTH MEASUREMENT

5.3.1 LIMITS OF 6dB BANDWIDTH MEASUREMENT

The minimum of 6dB Bandwidth Measurement is 0.5 MHz.

5.3.2 TEST SETUP

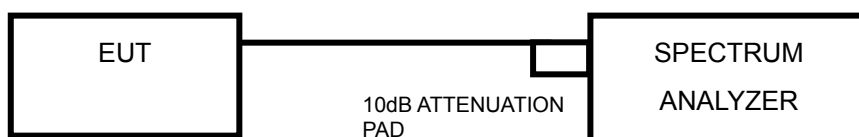

5.3.3 TEST INSTRUMENTS

Refer to section 4.1.2 to get information of above instrument.

5.3.4 TEST PROCEDURE

1. Set resolution bandwidth (RBW) = approximately 1% of the emission bandwidth
2. Set the video bandwidth (VBW) $\geq 3 \times$ RBW, Detector = Peak.
3. Trace mode = max hold.
4. Sweep = auto couple.
5. Measure the maximum width of the emission that is constrained by the frequencies associated with the two amplitude points (upper and lower) that are attenuated by 6 dB relative to the maximum level measured in the fundamental emission.

5.3.5 DEVIATION FROM TEST STANDARD

No deviation.

5.3.6 EUT OPERATING CONDITIONS

The software provided by client to enable the EUT under transmission condition continuously at lowest, middle and highest channel frequencies individually.

5.3.7 TEST RESULTS

CHANNEL	FREQUENCY (MHz)	6dB BANDWIDTH (MHz)	MINIMUM LIMIT (MHz)	PASS / FAIL
0	2402	0.72218	0.5	PASS
19	2440	0.72228	0.5	PASS
39	2480	0.74484	0.5	PASS

5.4 CONDUCTED OUTPUT POWER

5.4.1 LIMITS OF CONDUCTED OUTPUT POWER MEASUREMENT

For systems using digital modulation in the 2400–2483.5 MHz: 1 Watt (30dBm)

5.4.2 TEST SETUP

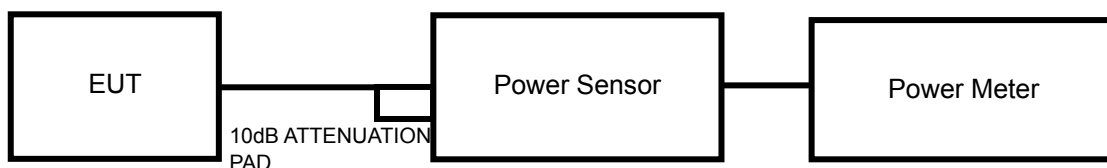

5.4.3 TEST INSTRUMENTS

Refer to section 4.1.2 to get information of above instrument.

5.4.4 TEST PROCEDURES

A peak power sensor was used on the output port of the EUT. A power meter was used to read the response of the peak power sensor. Record the peak power level.

5.4.5 DEVIATION FROM TEST STANDARD

No deviation.

5.4.6 EUT OPERATING CONDITIONS

Same as Item 4.3.6.

5.4.7 TEST RESULTS

CHANNEL	FREQUENCY (MHz)	PEAK POWER (mW)	PEAK POWER (dBm)	LIMIT (dBm)	PASS/FAIL
0	2402	1.16	0.63	30	PASS
19	2440	1.21	0.81	30	PASS
39	2480	1.16	0.64	30	PASS

5.5 POWER SPECTRAL DENSITY MEASUREMENT

5.5.1 LIMITS OF POWER SPECTRAL DENSITY MEASUREMENT

The Maximum of Power Spectral Density Measurement is 8dBm.

5.5.2 TEST SETUP

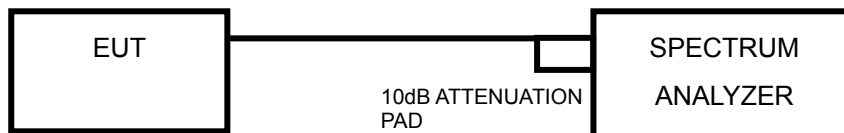

5.5.3 TEST INSTRUMENTS

Refer to section 4.1.2 to get information of above instrument.

5.5.4 TEST PROCEDURE

- a. Set the RBW = 100 kHz, VBW =300 kHz, Detector = peak.
- b. Sweep time = auto couple, Trace mode = max hold, allow trace to fully stabilize.
- c. Use the peak marker function to determine the maximum power level in any 100 kHz band segment within the fundamental EBW.
- d. Scale the observed power level to an equivalent value in 3 kHz by adjusting (reducing) the measured power by a bandwidth correction factor (BWCF) where $BWCF = 10\log(3 \text{ kHz}/100\text{kHz})$

5.5.5 DEVIATION FROM TEST STANDARD

No deviation.

5.5.6 EUT OPERATING CONDITION

Same as Item 4.3.6

5.5.7 TEST RESULTS

Channel	FREQ. (MHz)	PSD (dBm/100kHz)	PSD (dBm/3kHz)	Limit (dBm/3kHz)	PASS /FAIL
0	2402	0.09	-15.14	8	PASS
19	2440	0.28	-14.95	8	PASS
39	2480	-0.06	-15.29	8	PASS

5.6 CONDUCTED OUT OF BAND EMISSION MEASUREMENT

5.6.1 LIMITS OF OUT OF BAND EMISSION MEASUREMENT

Below -20dB of the highest emission level of operating band (in 100kHz Resolution Bandwidth).

5.6.2 TEST SETUP

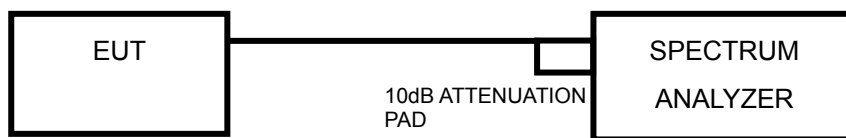

5.6.3 TEST INSTRUMENTS

Refer to section 4.1.2 to get information of above instrument.

5.6.4 TEST PROCEDURE

MEASUREMENT PROCEDURE REF

1. Set the RBW = 100 kHz.
2. Set the VBW \geq 300 kHz.
3. Detector = peak.
4. Sweep time = auto couple.
5. Trace mode = max hold.
6. Allow trace to fully stabilize.
7. Use the peak marker function to determine the maximum power level in any 100 kHz band segment within the fundamental EBW.

MEASUREMENT PROCEDURE OOBE

1. Set RBW = 100 kHz.
2. Set VBW \geq 300 kHz.
3. Set span to encompass the spectrum to be examined
4. Detector = peak.
5. Trace Mode = max hold.
6. Sweep = auto couple.

5.6.5 DEVIATION FROM TEST STANDARD

No deviation.

5.6.6 EUT OPERATING CONDITION

Same as Item 4.3.6

5.6.7 TEST RESULTS

The spectrum plots are attached on the following pages. D1 line indicates the highest level, and D2 line indicates the 20dB offset below D1. It shows compliance with the requirement.

5.6.8 TEST RESULTS

CH 0

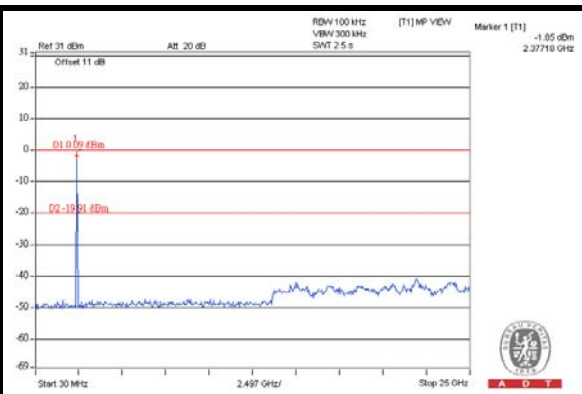
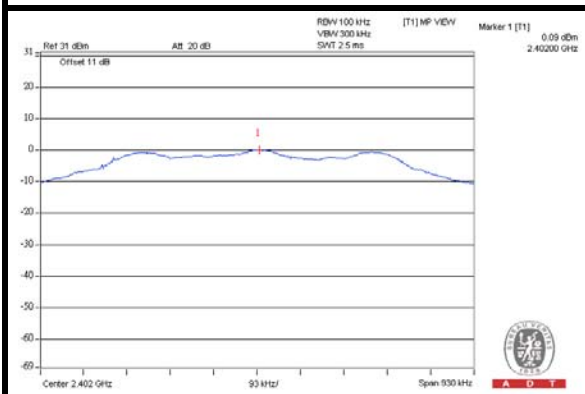

CH 19

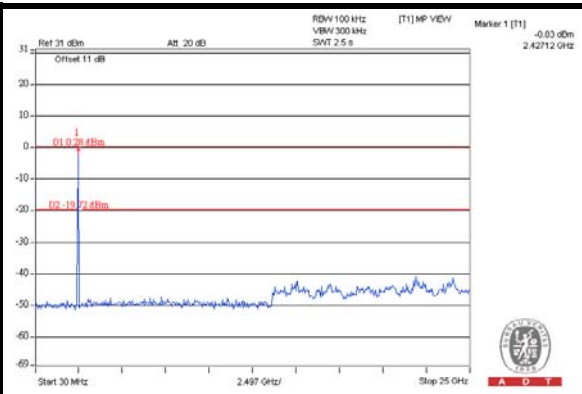
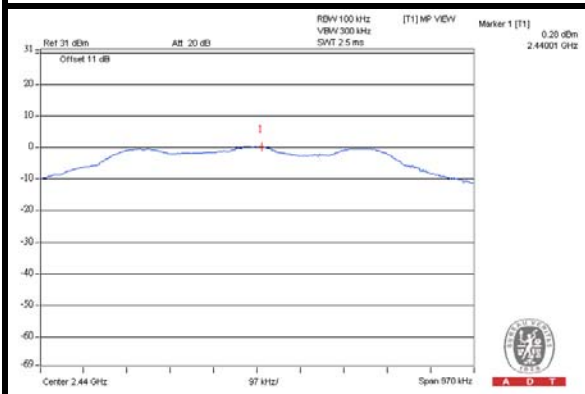

CH 39

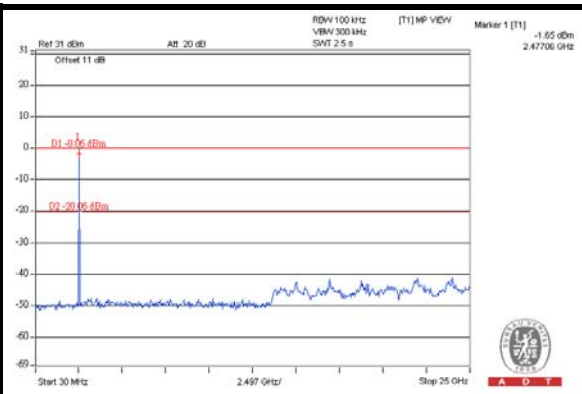
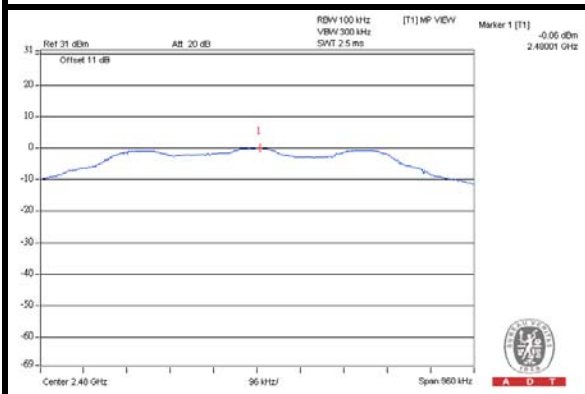



A D T

6. PHOTOGRAPHS OF THE TEST CONFIGURATION

Please refer to the attached file (Test Setup Photo).



7. INFORMATION ON THE TESTING LABORATORIES

We, Bureau Veritas Consumer Products Services (H.K.) Ltd., Taoyuan Branch, were founded in 1988 to provide our best service in EMC, Radio, Telecom and Safety consultation. Our laboratories are accredited and approved according to ISO/IEC 17025.

Copies of accreditation and authorization certificates of our laboratories obtained from approval agencies can be downloaded from our web site: www.adt.com.tw/index.5.phtml. If you have any comments, please feel free to contact us at the following:

Linko EMC/RF Lab:

Tel: 886-2-26052180

Fax: 886-2-26051924

Hsin Chu EMC/RF Lab:

Tel: 886-3-5935343

Fax: 886-3-5935342

Hwa Ya EMC/RF/Safety Telecom Lab:

Tel: 886-3-3183232

Fax: 886-3-3185050

Email: service.adt@tw.bureauveritas.com

Web Site: www.adt.com.tw

The address and road map of all our labs can be found in our web site also.

8. APPENDIX A - MODIFICATIONS RECORDERS FOR ENGINEERING CHANGES TO THE EUT BY THE LAB

No modifications were made to the EUT by the lab during the test.

--- END ---