



FCC TEST REPORT (PART 24)

REPORT NO.: RF111130C18-1

MODEL NO.: PJ83100

FCC ID: NM8PJ83100

RECEIVED: Nov. 30, 2011

TESTED: Jan. 10 ~ Jan. 13, 2012

ISSUED: Jan. 18, 2012

APPLICANT: HTC Corporation

ADDRESS: 23,Xinghua Rd., Taoyuan 330,Taiwan,R.O.C.

ISSUED BY: Bureau Veritas Consumer Products Services
(H.K.) Ltd., Taoyuan Branch

LAB ADDRESS: No. 47, 14th Ling, Chia Pau Vil., Lin Kou Dist.,
New Taipei City, Taiwan (R.O.C)

TEST LOCATION: No. 19, Hwa Ya 2nd Rd, Wen Hwa Tsuen, Kwei
Shan Hsiang, Taoyuan Hsien 333, Taiwan, R.O.C.

This test report consists of 57 pages in total. It may be duplicated completely for legal use with the approval of the applicant. It should not be reproduced except in full, without the written approval of our laboratory. The client should not use it to claim product endorsement by TAF or any government agencies. The test results in the report only apply to the tested sample.





TABLE OF CONTENTS

RELEASE CONTROL RECORD	4
1 CERTIFICATION.....	5
2 SUMMARY OF TEST RESULTS.....	6
2.1 MEASUREMENT UNCERTAINTY	6
3 GENERAL INFORMATION	7
3.1 GENERAL DESCRIPTION OF EUT	7
3.2 DESCRIPTION OF TEST MODES.....	8
3.2.1 CONFIGURATION OF SYSTEM UNDER TEST	9
3.2.2 TEST MODE APPLICABILITY AND TESTED CHANNEL DETAIL.....	10
3.3 GENERAL DESCRIPTION OF APPLIED STANDARDS.....	14
3.4 DESCRIPTION OF SUPPORT UNITS	14
4 TEST TYPES AND RESULTS.....	15
4.1 OUTPUT POWER MEASUREMENT	15
4.1.1 LIMITS OF OUTPUT POWER MEASUREMENT	15
4.1.2 TEST INSTRUMENTS	16
4.1.3 TEST PROCEDURES.....	17
4.1.4 TEST SETUP.....	18
4.1.5 EUT OPERATING CONDITIONS.....	18
4.1.6 TEST RESULTS	19
4.2 FREQUENCY STABILITY MEASUREMENT	21
4.2.1 LIMITS OF FREQUENCY STABILITY MEASUREMENT	21
4.2.2 TEST INSTRUMENTS	21
4.2.3 TEST PROCEDURE	22
4.2.4 TEST SETUP.....	22
4.2.5 TEST RESULTS	23
4.3 OCCUPIED BANDWIDTH MEASUREMENT	26
4.3.1 LIMITS OF OCCUPIED BANDWIDTH MEASUREMENT	26
4.3.2 TEST INSTRUMENTS	26
4.3.3 TEST SETUP.....	26
4.3.4 TEST PROCEDURES.....	27
4.3.5 EUT OPERATING CONDITION	27
4.3.6 TEST RESULTS	28
4.4 BAND EDGE MEASUREMENT	31
4.4.1 LIMITS OF BAND EDGE MEASUREMENT	31
4.4.2 TEST INSTRUMENTS	31



A D T

4.4.3	TEST SETUP.....	31
4.4.4	TEST PROCEDURES.....	32
4.4.5	EUT OPERATING CONDITION	32
4.4.6	TEST RESULTS	33
4.5	CONDUCTED SPURIOUS EMISSIONS.....	36
4.5.1	LIMITS OF CONDUCTED SPURIOUS EMISSIONS MEASUREMENT	36
4.5.2	TEST INSTRUMENTS	36
4.5.3	TEST PROCEDURE	37
4.5.4	TEST SETUP.....	37
4.5.5	EUT OPERATING CONDITIONS.....	37
4.5.6	TEST RESULTS	38
4.6	RADIATED EMISSION MEASUREMENT	47
4.6.1	LIMITS OF RADIATED EMISSION MEASUREMENT	47
4.6.2	TEST INSTRUMENTS	47
4.6.3	TEST PROCEDURES.....	47
4.6.4	DEVIATION FROM TEST STANDARD	47
4.6.5	TEST SETUP.....	48
4.6.6	EUT OPERATING CONDITIONS.....	48
4.6.7	TEST RESULTS	49
5	PHOTOGRAPHS OF THE TEST CONFIGURATION	55
6	INFORMATION ON THE TESTING LABORATORIES	56
7	APPENDIX A – MODIFICATIONS RECORDERS FOR ENGINEERING CHANGES TO THE EUT BY THE LAB.....	57



A D T

RELEASE CONTROL RECORD

ISSUE NO.	REASON FOR CHANGE	DATE ISSUED
Original release	N/A	Jan. 18, 2012



1 CERTIFICATION

PRODUCT: Smart Phone
MODEL NO.: PJ83100
BRAND: HTC
APPLICANT: HTC Corporation
TEST SAMPLE: Production Unit
TESTED: Jan. 10 ~ Jan. 13, 2012
TEST STANDARDS: **FCC Part 24, Subpart E**
ANSI C63.4-2003

The above equipment (model: PJ83100) has been tested by **Bureau Veritas Consumer Products Services (H.K.) Ltd., Taoyuan Branch**, and found compliance with the requirement of the above standards. The test record, data evaluation & Equipment Under Test (EUT) configurations represented herein are true and accurate accounts of the measurements of the sample's EMC characteristics under the conditions specified in this report.

PREPARED BY : Ivonne Wu , DATE : Jan. 18, 2012
Ivonne Wu / Senior Specialist

APPROVED BY : Gary Chang , DATE : Jan. 18, 2012
Gary Chang / Technical Manager

2 SUMMARY OF TEST RESULTS

The EUT has been tested according to the following specifications:

APPLIED STANDARD: FCC Part 24 & Part 2			
STANDARD SECTION	TEST TYPE AND LIMIT	RESULT	REMARK
2.1046 24.232	Maximum Peak Output Power Limit: max. 2 watts e.i.r.p peak power	PASS	Meet the requirement of limit. Max. e.i.r.p is 30.43dBm at 1909.8MHz.
2.1055 24.235	Frequency Stability AFC Freq. Error vs. Voltage AFC Freq. Error vs. Temperature Limit: max. +/-2.5ppm	PASS	Meet the requirement of limit.
2.1049 24.238(b)	Occupied Bandwidth	PASS	Meet the requirement of limit.
24.238(b)	Band Edge Measurements	PASS	Meet the requirement of limit.
2.1051 24.238	Conducted Spurious Emissions	PASS	Meet the requirement of limit.
2.1053 24.238	Radiated Spurious Emissions	PASS	Meet the requirement of limit. Minimum passing margin is -23.73dB at 3760.00MHz.

2.1 MEASUREMENT UNCERTAINTY

Where relevant, the following measurement uncertainty levels have been estimated for tests performed on the EUT as specified in CISPR 16-4-2:

MEASUREMENT	FREQUENCY	UNCERTAINTY
Conducted emissions	9kHz~30MHz	2.44 dB
Radiated emissions	30MHz ~ 200MHz	3.34 dB
	200MHz ~1000MHz	3.35 dB
	1GHz ~ 18GHz	2.26 dB
	18GHz ~ 40GHz	1.94 dB

This uncertainty represents an expanded uncertainty expressed at approximately the 95% confidence level using a coverage factor of k=2.

3 GENERAL INFORMATION

3.1 GENERAL DESCRIPTION OF EUT

EUT	Smart Phone	
MODEL NO.	PJ83100	
FCC ID	NM8PJ83100	
POWER SUPPLY	5.0Vdc (adapter or host equipment) 3.7Vdc (battery)	
MODULATION TYPE	GSM, GPRS, E-GPRS	GMSK, 8PSK
	WCDMA	BPSK
FREQUENCY RANGE	GSM, GPRS, E-GPRS	1850.2MHz ~ 1909.8MHz
	WCDMA	1852.4MHz ~ 1907.6MHz
MAX. EIRP POWER	GSM	1.10Watts
	E-GPRS	0.49Watts
	WCDMA	0.18Watts
MULTI-SLOTS CLASS	10	
WCDMA RELEASE VERSION	6	
ANTENNA TYPE	Fixed Internal antenna with -1dBi gain	
I/O PORTS	Refer to users' manual	
DATA CABLE	Refer to Note as below	
ACCESSORY DEVICES	Refer to Note as below	

NOTE:

1. The EUT's accessories list refers to Ext Pho_NM8PJ83100.
2. The above EUT information was declared by manufacturer and for more detailed features description, please refer to the manufacturer's specifications or User's Manual.

3.2 DESCRIPTION OF TEST MODES

FOR GSM, GPRS & E-GPRS:

299 channels are provided to this EUT. Therefore, the low, middle and high channels are chosen for testing.

	CHANNEL	FREQUENCY	TX MODE
LOW	512	1850.2 MHz	GSM, GPRS, E-GPRS
MIDDLE	661	1880.0 MHz	GSM, GPRS, E-GPRS
HIGH	810	1909.8 MHz	GSM, GPRS, E-GPRS

NOTE:

1. The channel 512, 661, and 810 were pre-tested in chamber. The channel 661 was chosen for final test.
2. The worst case for final test is chosen when the power control level set 0.
3. The channel space is 0.2MHz.
4. The EUT is an E-GPRS class 10 device (Multislot class: 10), which provide 2 up-link. After pre-tested 2 functions, found up-link with 1 time slot is worse, therefore, test results of output power, frequency stability, occupied bandwidth and band edge tests came out from this.
5. The EUT has GSM, GPRS & E-GPRS functions. After pre-testing, GSM function is the worst case for all the emission tests.

FOR WCDMA:

277 channels are provided to this EUT. Therefore, the low, middle and high channels are chosen for testing.

	CHANNEL	FREQUENCY	TX MODE
LOW	9262	1852.4 MHz	WCDMA, HSDPA, HSUPA
MIDDLE	9400	1880.0 MHz	WCDMA, HSDPA, HSUPA
HIGH	9538	1907.6 MHz	WCDMA, HSDPA, HSUPA

NOTE:

1. The channel 9262, 9400 and 9538 were pre-tested in chamber. The channel 9400 was chosen for final test.
2. The channel space is 0.2MHz.
3. After pretest of output power and spurious emission under WCDMA-RMC, HSDPA & HSUPA mode, find the worst mode is WCDMA-RMC. Therefore, select WCDMA-RMC mode to do final test.

3.2.1 CONFIGURATION OF SYSTEM UNDER TEST

<For Radiated Emission Test>

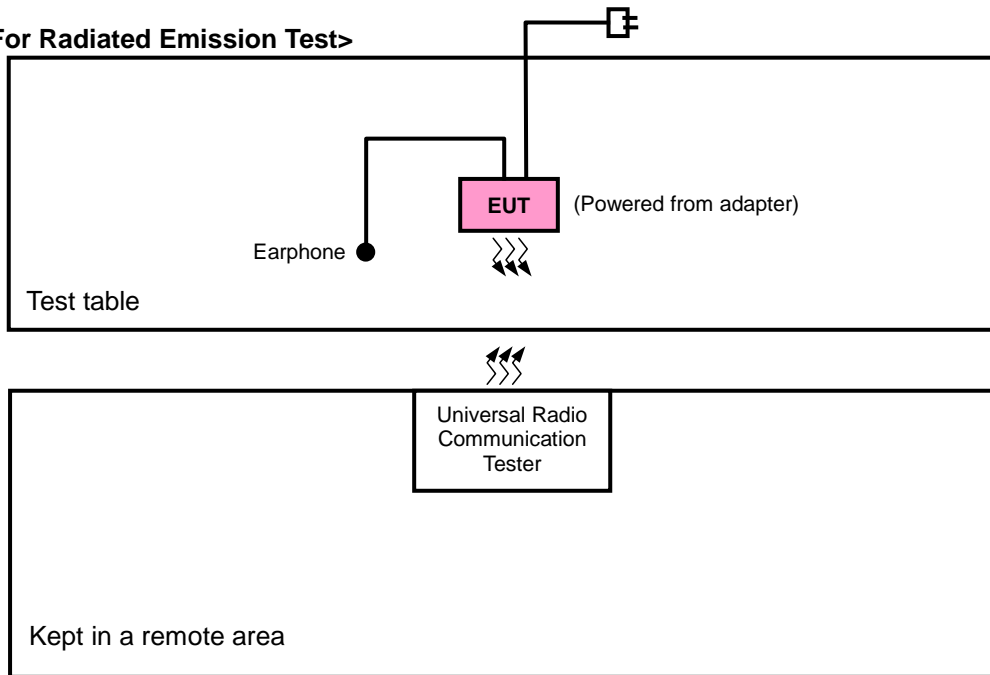

<For Output Power Test>

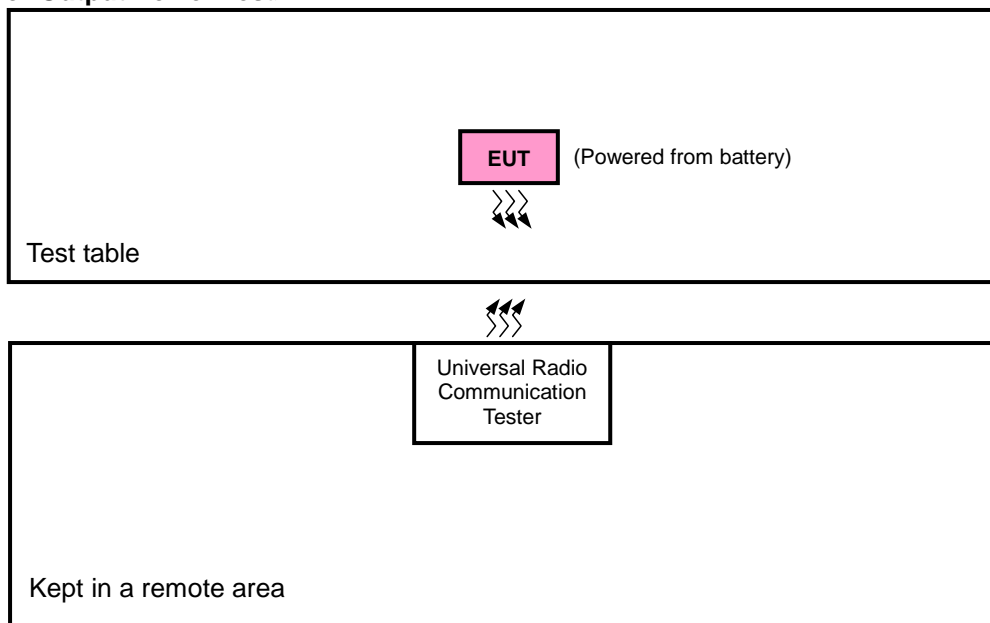

3.2.2 TEST MODE APPLICABILITY AND TESTED CHANNEL DETAIL

FOR GSM, GPRS & E-GPRS:

EUT CONFIGURE MODE	APPLICABLE TO						DESCRIPTION
	OP	FS	OB	BE	CE	RE	
-	√	√	√	√	√	√	-

Where **OP**: Output power **FS**: Frequency stability
OB: Occupied bandwidth **BE**: Band edge
CE: Conducted spurious emissions **RE**: Radiated emission

OUTPUT POWER MEASUREMENT:

- Pre-Scan has been conducted to determine the worst-case mode from all possible combinations between available modulations, data rates, XYZ axis and antenna ports (if EUT with antenna diversity architecture).
- Following channel(s) was (were) selected for the final test as listed below.

AVAILABLE CHANNEL	TESTED CHANNEL	MODULATION TECHNOLOGY	AXIS
512 to 810	512, 661, 810	GSM, GPRS, E-GPRS	X

FREQUENCY STABILITY MEASUREMENT:

- Pre-Scan has been conducted to determine the worst-case mode from all possible combinations between available modulations and antenna ports (if EUT with antenna diversity architecture).
- Following channel(s) was (were) selected for the final test as listed below.

AVAILABLE CHANNEL	TESTED CHANNEL	MODULATION TECHNOLOGY
512 to 810	661	GSM, E-GPRS

OCCUPIED BANDWIDTH MEASUREMENT:

- This item includes all test value of each mode, but only includes spectrum plot of worst value of each mode.
- Pre-Scan has been conducted to determine the worst-case mode from all possible combinations between available modulations and antenna ports (if EUT with antenna diversity architecture).
- Following channel(s) was (were) selected for the final test as listed below.

AVAILABLE CHANNEL	TESTED CHANNEL	MODULATION TECHNOLOGY
512 to 810	512, 661, 810	GSM, EGPRS

BAND EDGE MEASUREMENT:

- Pre-Scan has been conducted to determine the worst-case mode from all possible combinations between available modulations and antenna ports (if EUT with antenna diversity architecture).
- Following channel(s) was (were) selected for the final test as listed below.

AVAILABLE CHANNEL	TESTED CHANNEL	MODULATION TECHNOLOGY
512 to 810	512, 810	GSM, EGPRS

CONDUCTED SPURIOUS EMISSIONS MEASUREMENT:

- Pre-Scan has been conducted to determine the worst-case mode from all possible combinations between available modulations and antenna ports (if EUT with antenna diversity architecture).
- Following channel(s) was (were) selected for the final test as listed below.

AVAILABLE CHANNEL	TESTED CHANNEL	MODULATION TECHNOLOGY
512 to 810	661	GSM, E-GPRS

RADIATED EMISSION MEASUREMENT:

- Pre-Scan has been conducted to determine the worst-case mode from all possible combinations between available modulations, data rates, XYZ axis and antenna ports (if EUT with antenna diversity architecture).
- Following channel(s) was (were) selected for the final test as listed below.

AVAILABLE CHANNEL	TESTED CHANNEL	MODULATION TECHNOLOGY	AXIS
512 to 810	661	GSM, E-GPRS	Z

TEST CONDITION:

APPLICABLE TO	ENVIRONMENTAL CONDITIONS	INPUT POWER	TESTED BY
OP	25deg. C, 65%RH	3.7Vdc	Phoenix Chen
FS	25deg. C, 65%RH	3.7Vdc	Phoenix Chen
OB	25deg. C, 65%RH	3.7Vdc	Phoenix Chen
EM	25deg. C, 65%RH	3.7Vdc	Phoenix Chen
BE	25deg. C, 65%RH	3.7Vdc	Phoenix Chen
CE	25deg. C, 65%RH	3.7Vdc	Phoenix Chen
RE	25deg. C, 65%RH	120Vac, 60Hz	Kay Wu



FOR WCDMA:

EUT CONFIGURE MODE	APPLICABLE TO						DESCRIPTION
	OP	FS	OB	BE	CE	RE	
-	√	√	√	√	√	√	-

Where **OP:** Output power **FS:** Frequency stability
OB: Occupied bandwidth **BE:** Band edge
CE: Conducted spurious emissions **RE:** Radiated emission

OUTPUT POWER MEASUREMENT:

- Pre-Scan has been conducted to determine the worst-case mode from all possible combinations between available modulations, data rates, XYZ axis and antenna ports (if EUT with antenna diversity architecture).
- Following channel(s) was (were) selected for the final test as listed below.

AVAILABLE CHANNEL	TESTED CHANNEL	MODULATION TECHNOLOGY	AXIS
9262 to 9538	9262, 9400, 9538	WCDMA	X

FREQUENCY STABILITY MEASUREMENT:

- Pre-Scan has been conducted to determine the worst-case mode from all possible combinations between available modulations and antenna ports (if EUT with antenna diversity architecture).
- Following channel(s) was (were) selected for the final test as listed below.

AVAILABLE CHANNEL	TESTED CHANNEL	MODULATION TECHNOLOGY
9262 to 9538	9400	WCDMA

OCCUPIED BANDWIDTH MEASUREMENT:

- This item includes all test value of each mode, but only includes spectrum plot of worst value of each mode.
- Pre-Scan has been conducted to determine the worst-case mode from all possible combinations between available modulations and antenna ports (if EUT with antenna diversity architecture).
- Following channel(s) was (were) selected for the final test as listed below.

AVAILABLE CHANNEL	TESTED CHANNEL	MODULATION TECHNOLOGY
9262 to 9538	9262, 9400, 9538	WCDMA

BAND EDGE MEASUREMENT:

- Pre-Scan has been conducted to determine the worst-case mode from all possible combinations between available modulations and antenna ports (if EUT with antenna diversity architecture).
- Following channel(s) was (were) selected for the final test as listed below.

AVAILABLE CHANNEL	TESTED CHANNEL	MODULATION TECHNOLOGY
9262 to 9538	9262, 9538	WCDMA

CONDUCTED SPURIOUS EMISSIONS MEASUREMENT:

- Pre-Scan has been conducted to determine the worst-case mode from all possible combinations between available modulations and antenna ports (if EUT with antenna diversity architecture).
- Following channel(s) was (were) selected for the final test as listed below.

AVAILABLE CHANNEL	TESTED CHANNEL	MODULATION TECHNOLOGY
9262 to 9538	9400	WCDMA

RADIATED EMISSION MEASUREMENT:

- Pre-Scan has been conducted to determine the worst-case mode from all possible combinations between available modulations, data rates, XYZ axis and antenna ports (if EUT with antenna diversity architecture).
- Following channel(s) was (were) selected for the final test as listed below.

AVAILABLE CHANNEL	TESTED CHANNEL	MODULATION TECHNOLOGY	AXIS
9262 to 9538	9400	WCDMA	Z

TEST CONDITION:

APPLICABLE TO	ENVIRONMENTAL CONDITIONS	INPUT POWER	TESTED BY
OP	25deg. C, 65%RH	3.7Vdc	Phoenix Chen
FS	25deg. C, 65%RH	3.7Vdc	Phoenix Chen
OB	25deg. C, 65%RH	3.7Vdc	Phoenix Chen
EM	25deg. C, 65%RH	3.7Vdc	Phoenix Chen
BE	25deg. C, 65%RH	3.7Vdc	Phoenix Chen
CE	25deg. C, 65%RH	3.7Vdc	Phoenix Chen
RE	25deg. C, 65%RH	120Vac, 60Hz	Kay Wu

3.3 GENERAL DESCRIPTION OF APPLIED STANDARDS

The EUT is a RF product. According to the specifications of the manufacturer, it must comply with the requirements of the following standards:

FCC 47 CFR Part 2

FCC 47 CFR Part 24

ANSI C63.4-2003

ANSI/TIA/EIA-603-C 2004

NOTE: All test items have been performed and recorded as per the above standards.

3.4 DESCRIPTION OF SUPPORT UNITS

The EUT has been tested as an independent unit together with other necessary accessories or support units. The following support units or accessories were used to form a representative test configuration during the tests.

NO.	PRODUCT	BRAND	MODEL NO.	SERIAL NO.	FCC ID
1	UNIVERSAL RADIO COMMUNICATION TESTER	R&S	CMU200	104484	NA
2	Radio Communication Analyzer	Anritsu	MT8820C	6201010284	NA

NO.	SIGNAL CABLE DESCRIPTION OF THE ABOVE SUPPORT UNITS
1	NA
2	NA

NOTE 1: All power cords of the above support units are non shielded (1.8m).

NOTE 2: Item 1-2 acted as a communication partners to transfer data.

4 TEST TYPES AND RESULTS

4.1 OUTPUT POWER MEASUREMENT

4.1.1 LIMITS OF OUTPUT POWER MEASUREMENT

The radiated peak output power shall be according to the specific rule Part 24.232(b) that “Mobile / Portable station are limited to 2 watts e.i.r.p” and 24.232(c) specific that “Peak transmit power must be measure over any interval of continuous transmission using instrumentation calibration in terms of rms-equivalent voltage.”

4.1.2 TEST INSTRUMENTS

DESCRIPTION & MANUFACTURER	MODEL NO.	SERIAL NO.	DATE OF CALIBRATION	DUE DATE OF CALIBRATION
Test Receiver ROHDE & SCHWARZ	ESIB7	100212	Aug. 02, 2011	Aug. 01, 2012
Spectrum Analyzer ROHDE & SCHWARZ	FSP40	100041	Jul. 21, 2011	Jul. 20, 2012
BILOG Antenna SCHWARZBECK	VULB9168	9168-160	Apr. 13, 2011	Apr. 12, 2012
HORN Antenna SCHWARZBECK	9120D	209	Aug. 25, 2011	Aug. 24, 2012
HORN Antenna SCHWARZBECK	BBHA 9170	148	Jul. 20, 2011	Jul. 19, 2012
Preamplifier Agilent	8447D	2944A10633	Oct. 29, 2011	Oct. 28, 2012
Preamplifier Agilent	8449B	3008A01964	Oct. 29, 2011	Oct. 28, 2012
RF signal cable HUBER+SUHNNER	SUCOFLEX 104	250723/4	Aug. 30, 2011	Aug. 29, 2012
RF signal cable HUBER+SUHNNER	SUCOFLEX 106	12738/6+309224/4	Aug. 30, 2011	Aug. 29, 2012
Software ADT.	ADT_Radiated_ V7.6.15.9.2	NA	NA	NA
Antenna Tower inn-co GmbH	MA 4000	013303	NA	NA
Antenna Tower Controller inn-co GmbH	CO2000	017303	NA	NA
Turn Table ADT.	TT100.	TT93021703	NA	NA
Turn Table Controller ADT.	SC100.	SC93021703	NA	NA

- NOTE:**
1. The calibration interval of the above test instruments is 12 months and the calibrations are traceable to NML/ROC and NIST/USA.
 2. The test was performed in HwaYa Chamber 3.
 3. The horn antenna and HP preamplifier (model: 8449B) are used only for the measurement of emission frequency above 1GHz if tested.
 4. The FCC Site Registration No. is 988962.
 5. The IC Site Registration No. is IC 7450F-3.

4.1.3 TEST PROCEDURES

EIRP MEASUREMENT:

- a. The power was measured with R&S Spectrum Analyzer. All measurements were done at 3 channels, 512, 661 and 810 (GSM & E-GPRS) / 9262, 9400 and 9538 (WCDMA) (low, middle and high operational frequency range.) RWB and VBW is 1MHz for GSM/EGPRS and 5MHz for WCDMA mode.
- b. Substitution method is used for E.I.R.P measurement. In the semi-anechoic chamber, EUT placed on the 0.8m height of Turn Table, rotated the table around 360 degrees to search the maximum radiation power and receiver antenna shall be rotated vertical and horizontal polarization and moved height from 1m to 4m to find the maximum polar radiated power. The “Read Value” is the spectrum reading the maximum power value.
- c. The substitution horn antenna is substituted for EUT at the same position and signals generator export the CW signal to the substitution antenna via a tx cable . Rotated the Turn Table and moved receiving antenna to find the maximum radiation power. Adjust output power level of S.G to get a Value of spectrum reading equal to “Read Value” of step c. Record the power level of S.G
- d. $EIRP = \text{Output power level of S.G} - \text{TX cable loss} + \text{Antenna gain of substitution horn.}$

CONDUCTED POWER MEASUREMENT:

- a. The EUT was set up for the maximum power with GSM, GPRS & EGPRS/WCDMA link data modulation and link up with simulator.
- b. Set the EUT to transmit under low, middle and high channel and record the power level shown on simulator.

4.1.4 TEST SETUP

EIRP POWER MEASUREMENT:

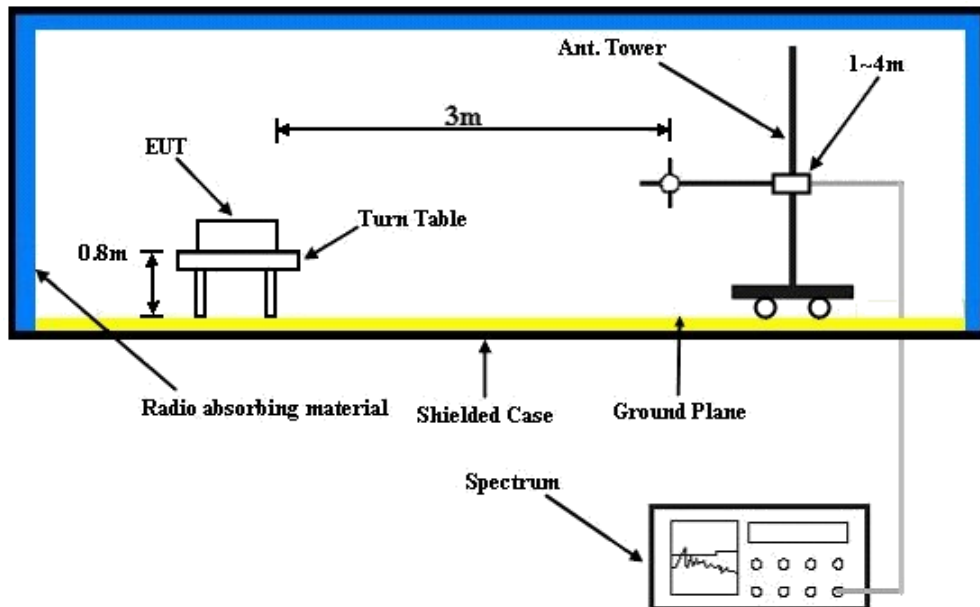

For the actual test configuration, please refer to the attached file (Test Setup Photo).

CONDUCTED POWER MEASUREMENT:

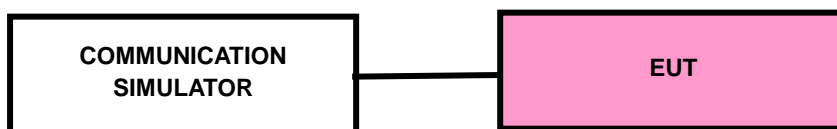

For the actual test configuration, please refer to the attached file (Test Setup Photo).

4.1.5 EUT OPERATING CONDITIONS

- a. The EUT makes a call to the communication simulator.
- b. The communication simulator station system controlled an EUT to export maximum output power under transmission mode and specific channel frequency.

4.1.6 TEST RESULTS

CONDUCTED OUTPUT POWER (dBm)

Band	GSM1900		
Channel	512	661	810
Frequency (MHz)	1850.2	1880	1909.8
GSM	30.55	30.27	30.61
GPRS 8	30.51	30.16	30.52
GPRS 10	29.59	29.54	29.50
EDGE 8 (MCS9)	26.28	26.23	26.15
EDGE 10 (MCS9)	26.40	26.30	26.21

Band	WCDMA II		
Channel	9262	9400	9538
Frequency (MHz)	1852.4	1880	1907.6
RMC 12.2K	23.12	23.26	23.13
HSDPA Subtest-1	22.37	22.62	22.56
HSDPA Subtest-2	22.35	22.62	22.57
HSDPA Subtest-3	21.53	21.72	21.69
HSDPA Subtest-4	21.55	21.75	21.65
HSUPA Subtest-1	21.72	22.28	22.07
HSUPA Subtest-2	19.14	18.90	19.15
HSUPA Subtest-3	20.22	20.27	20.25
HSUPA Subtest-4	19.12	19.06	19.17
HSUPA Subtest-5	22.31	22.47	22.42



A D T

**EIRP POWER
FOR GSM MODE**

Plane	Channel	Frequency (MHz)	LVL (dBm)	Correction Factor(dB)	EIRP(dBm)	EIRP(W)	Polarization (H/V)
X	512	1850.2	-8.07	38.19	30.12	1.03	H
	661	1880.0	-9.27	38.70	29.43	0.88	H
	810	1909.8	-8.92	39.35	30.43	1.10	H
	512	1850.2	-16.54	38.48	21.94	0.16	V
	661	1880.0	-14.46	38.59	24.13	0.26	V
	810	1909.8	-16.50	38.87	22.37	0.17	V

FOR E-GPRS MODE

Plane	Channel	Frequency (MHz)	LVL (dBm)	Correction Factor(dB)	EIRP(dBm)	EIRP(W)	Polarization (H/V)
X	512	1850.2	-11.29	38.19	26.90	0.49	H
	661	1880.0	-12.16	38.70	26.54	0.45	H
	810	1909.8	-13.05	39.35	26.30	0.43	H
	512	1850.2	-18.27	38.48	20.21	0.10	V
	661	1880.0	-19.68	38.59	18.91	0.08	V
	810	1909.8	-19.26	38.87	19.61	0.09	V

FOR WCDMA MODE

Plane	Channel	Frequency (MHz)	LVL (dBm)	Correction Factor(dB)	EIRP(dBm)	EIRP(W)	Polarization (H/V)
X	9262	1852.4	-15.78	38.19	22.41	0.17	H
	9400	1880.0	-17.29	38.70	21.41	0.14	H
	9538	1907.6	-16.72	39.35	22.63	0.18	H
	9262	1852.4	-20.85	38.48	17.63	0.06	V
	9400	1880.0	-22.90	38.59	15.69	0.04	V
	9538	1907.6	-24.39	38.87	14.48	0.03	V



4.2 FREQUENCY STABILITY MEASUREMENT

4.2.1 LIMITS OF FREQUENCY STABILITY MEASUREMENT

According to the FCC part 24.235 shall be tested the frequency stability. The rule is defined that "The frequency stability shall be sufficient to ensure that the fundamental emission stays within the authorized frequency block." The frequency error rate is according to the JTC standard that the frequency error rate shall be accurate to within 2.5ppm of the received frequency from the base station.

4.2.2 TEST INSTRUMENTS

DESCRIPTION & MANUFACTURER	MODEL NO.	SERIAL NO.	DATE OF CALIBRATION	DUE DATE OF CALIBRATION
Spectrum Analyzer Agilent	E4446A	MY43360128	Feb. 22, 2011	Feb. 21, 2012
Hewlett Packard RF cable	8120-6192	01428251	NA	NA
RF cable	SUCOFLEX 104	257029	Sep. 11, 2011	Sep. 10, 2012
WIT Standard Temperature & Humidity Chamber	MHU-225AU	920842	Jun. 15, 2011	Jun. 14, 2012

NOTE: The calibration interval of the above test instruments is 12 months. And the calibrations are traceable to NML/ROC and NIST/USA.

4.2.3 TEST PROCEDURE

- a. Because of the measure the carrier frequency under the condition of the AFC lock, it shall be used the mobile station in the GSM / WCDMA link mode. This is accomplished with the use of the R&S CMU200 / JRC NJZ-2000 simulator station. The oven room could control the temperatures and humidity. The GSM link channel is the 190 and the WCDMA link channel is the 9400.
- b. Power must be removed when changing from one temperature to another or one voltage to another voltage. Power warm up is at least 15 min and power applied should perform before recording frequency error.
- c. EUT is connected the external power supply to control the DC input power. The various Volts from the minimum 3.6Volts to 4.2Volts. Each step shall be record the frequency error rate.
- d. The temperature range step is 10 degrees in this test items. All temperature levels shall be hold the $\pm 0.5^{\circ}\text{C}$ during the measurement testing.
- e. The each temperature step shall be at least 0.5 hours, consider the EUT could be test under the stability condition.

NOTE: The frequency error was recorded frequency error from the GSM simulator.

4.2.4 TEST SETUP

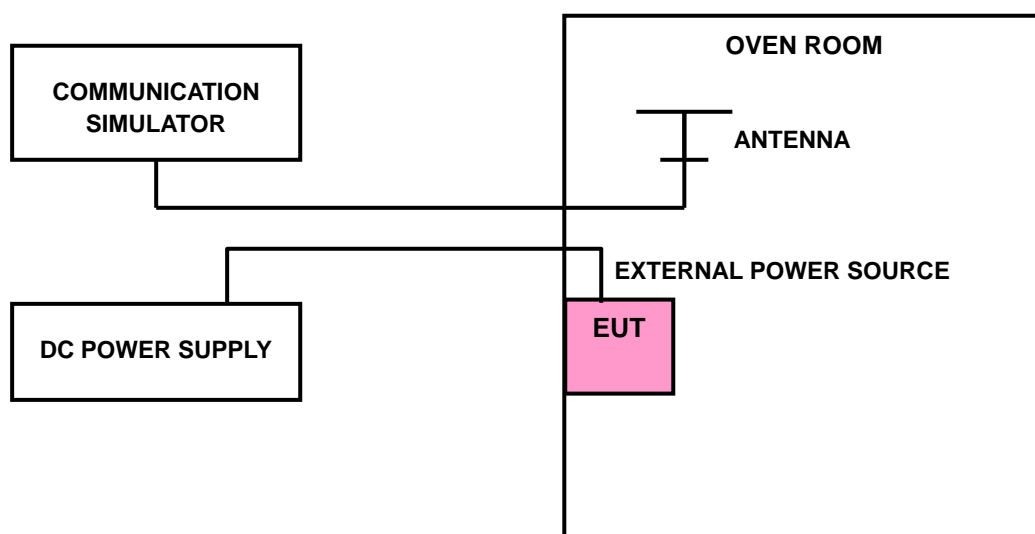

4.2.5 TEST RESULTS

FOR GSM:

AFC FREQUENCY ERROR vs. VOLTAGE			
VOLTAGE (Volts)	FREQUENCY ERROR (Hz)	FREQUENCY ERROR (ppm)	LIMIT (ppm)
3.8	-19.16	-0.01	2.5
3.6	-21.33	-0.01	2.5
4.2	-17.11	-0.01	2.5

NOTE: The applicant defined the normal working voltage of the battery is from 3.6Vdc to 4.2Vdc.

AFC FREQUENCY ERROR vs. TEMP.			
TEMP. (°C)	FREQUENCY ERROR (Hz)	FREQUENCY ERROR (ppm)	LIMIT (ppm)
-10	-18.72	-0.01	2.5
0	-15.63	-0.01	2.5
10	-17.19	-0.01	2.5
20	22.31	0.01	2.5
30	-25.12	-0.01	2.5
40	-21.4	-0.01	2.5
50	-23.87	-0.01	2.5
55	-17.69	-0.01	2.5



A D T

FOR E-GPRS:

AFC FREQUENCY ERROR vs. VOLTAGE			
VOLTAGE (Volts)	FREQUENCY ERROR (Hz)	FREQUENCY ERROR (ppm)	LIMIT (ppm)
3.8	-21.82	-0.01	2.5
3.6	-23.75	-0.01	2.5
4.2	20.99	0.01	2.5

NOTE: The applicant defined the normal working voltage of the battery is from 3.6Vdc to 4.2Vdc.

AFC FREQUENCY ERROR vs. TEMP.			
TEMP. (°C)	FREQUENCY ERROR (Hz)	FREQUENCY ERROR (ppm)	LIMIT (ppm)
-10	-19.18	-0.01	2.5
0	-21.35	-0.01	2.5
10	-18.22	-0.01	2.5
20	23.42	0.01	2.5
30	21.38	0.01	2.5
40	23.67	0.01	2.5
50	-18.14	-0.01	2.5
55	-19.33	-0.01	2.5



A D T

FOR WCDMA:

AFC FREQUENCY ERROR vs. VOLTAGE			
VOLTAGE (Volts)	FREQUENCY ERROR (Hz)	FREQUENCY ERROR (ppm)	LIMIT (ppm)
3.8	-30.12	-0.02	2.5
3.6	-28.1	-0.01	2.5
4.2	21.18	0.01	2.5

NOTE: The applicant defined the normal working voltage of the battery is from 3.6Vdc to 4.2Vdc.

AFC FREQUENCY ERROR vs. TEMP.			
TEMP. (°C)	FREQUENCY ERROR (Hz)	FREQUENCY ERROR (ppm)	LIMIT (ppm)
-10	-31.52	-0.02	2.5
0	-28.71	-0.02	2.5
10	-27.66	-0.01	2.5
20	-23.45	-0.01	2.5
30	25.51	0.01	2.5
40	25.99	0.01	2.5
50	-24.87	-0.01	2.5
55	-23.9	-0.01	2.5

4.3 OCCUPIED BANDWIDTH MEASUREMENT

4.3.1 LIMITS OF OCCUPIED BANDWIDTH MEASUREMENT

The width of a frequency band such that, below the lower and above the upper frequency limits, the mean powers emitted are each equal to a specified percentage 0.5 %of the totalmean power of a given emission.

4.3.2 TEST INSTRUMENTS

DESCRIPTION & MANUFACTURER	MODEL NO.	SERIAL NO.	DATE OF CALIBRATION	DUE DATE OF CALIBRATION
SPECTRUM ANALYZER R&S	FSP40	100039	Feb. 23, 2011	Feb. 22, 2012
Mini-Circuits Power Splitter	ZN2PD-9G	NA	May 25, 2011	May 24, 2012
RF cable	SUCOFLEX 104	274403/4	Aug. 20, 2011	Aug. 19, 2012
RF cable	SUCOFLEX 104	250729/4	Aug. 19, 2011	Aug. 18, 2012
RF cable	SUCOFLEX 104	214377/4	Aug. 19, 2011	Aug. 18, 2012
JFW 20dB attenuation	50HF-020-SMA	NA	NA	NA

NOTE: The calibration interval of the above test instruments is 12 months. And the calibrations are traceable to NML/ROC and NIST/USA.

4.3.3 TEST SETUP

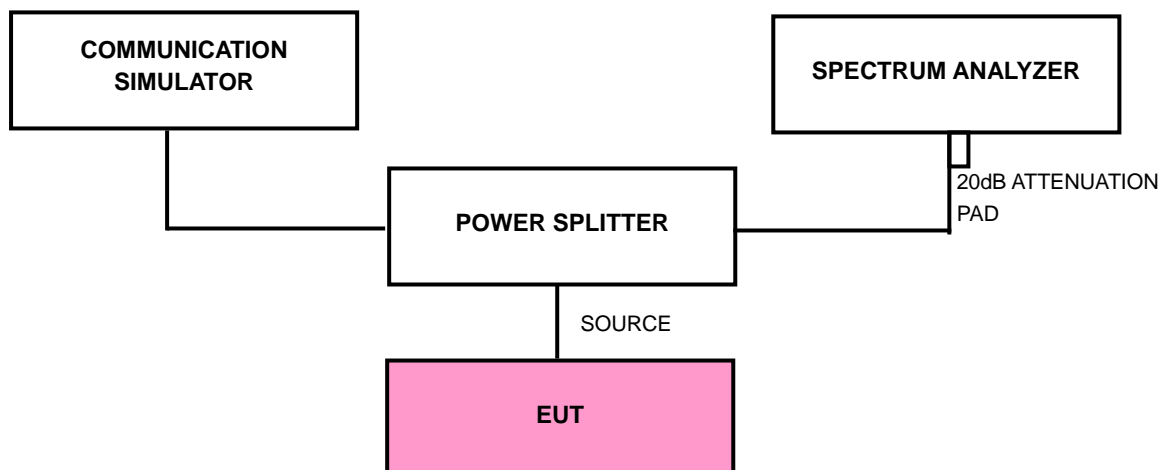

4.3.4 TEST PROCEDURES

- a. The EUT makes a call to the communication simulator. The power was measured with R&S Spectrum Analyzer. All measurements were done at 3 channels, 512, 661 and 810 (GSM / E-GPRS) / 9262, 9400 and 9538 (WCDMA) (low, middle and high operational frequency range.)
- b. The conducted occupied bandwidth used the power splitter via EUT RF power connector between simulation base station and spectrum analyzer.
- c. The communication simulator station system controlled a EUT to export maximum output power under transmission mode and specific channel frequency. Use OBW measurement function of Spectrum analyzer to measure 99 % occupied bandwidth.

4.3.5 EUT OPERATING CONDITION

- a. The EUT makes a call to the communication simulator.
- b. The communication simulator station system controlled a EUT to export maximum and minimum output power under transmission mode and specific channel frequency.



A D T

4.3.6 TEST RESULTS

FOR GSM MODE

CHANNEL	FREQUENCY (MHz)	99% OCCUPIED BANDWIDTH (kHz)
512	1850.2	246
661	1880.0	244
810	1909.8	244

CH 512

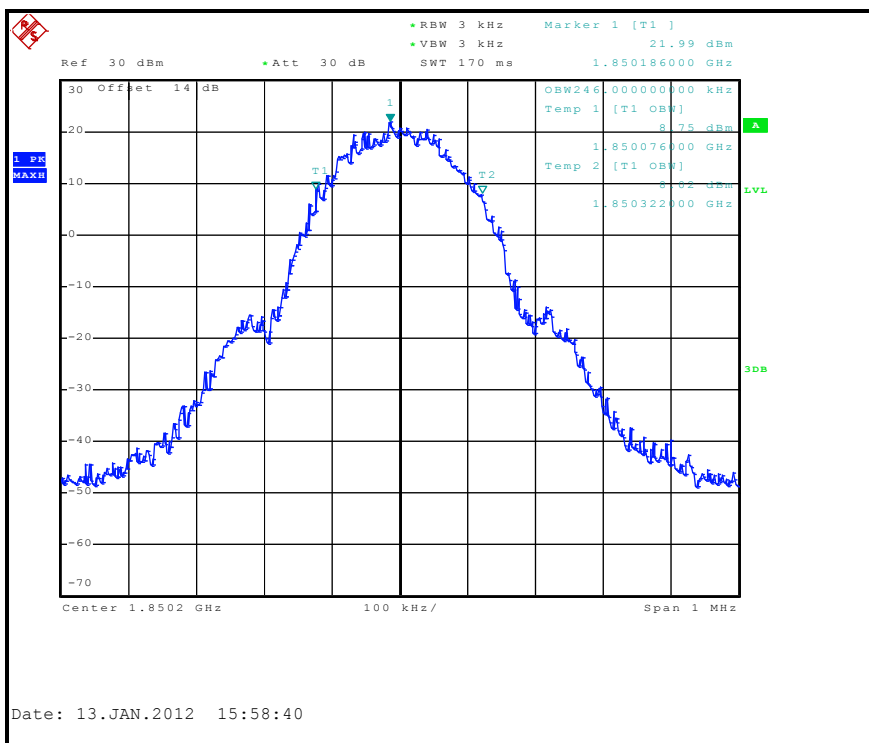



A D T

FOR E-GPRS MODE

CHANNEL	FREQUENCY (MHz)	99% OCCUPIED BANDWIDTH (kHz)
512	1850.2	244
661	1880.0	250
810	1909.8	246

CH 661

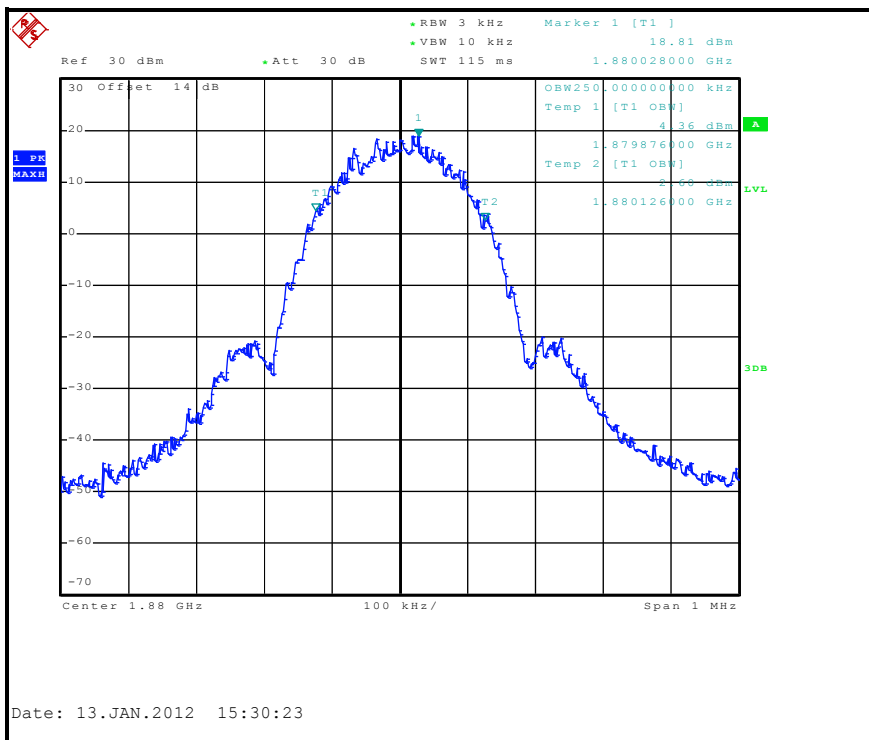



A D T

FOR WCDMA:

CHANNEL	FREQUENCY (MHz)	99% OCCUPIED BANDWIDTH (MHz)
9262	1852.4	4.18
9400	1880.0	4.16
9538	1907.6	4.18

CH 9262

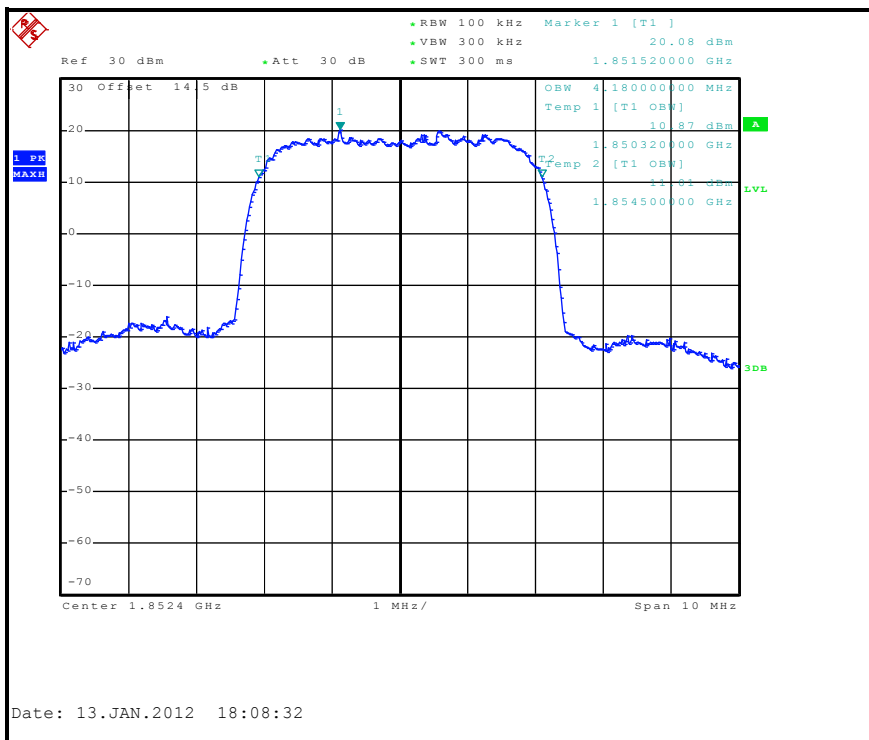

4.4 BAND EDGE MEASUREMENT

4.4.1 LIMITS OF BAND EDGE MEASUREMENT

According to FCC 24.238(a) specified that power of any emission outside of the authorized operating frequency ranges must be attenuated below the transmitting power (P) by a factor of at least $43 + 10 \log(P)$ dB. In the 1 MHz bands immediately outside and adjacent to the frequency block a resolution bandwidth of at least one percent of the emission bandwidth of the fundamental emission of the transmitter may be employed.

4.4.2 TEST INSTRUMENTS

DESCRIPTION & MANUFACTURER	MODEL NO.	SERIAL NO.	DATE OF CALIBRATION	DUE DATE OF CALIBRATION
SPECTRUM ANALYZER R&S	FSP40	100039	Feb. 23, 2011	Feb. 22, 2012
Mini-Circuits Power Splitter	ZN2PD-9G	NA	May 25, 2011	May 24, 2012
RF cable	SUCOFLEX 104	274403/4	Aug. 20, 2011	Aug. 19, 2012
RF cable	SUCOFLEX 104	250729/4	Aug. 19, 2011	Aug. 18, 2012
RF cable	SUCOFLEX 104	214377/4	Aug. 19, 2011	Aug. 18, 2012
JFW 20dB attenuation	50HF-020-SMA	NA	NA	NA

NOTE: The calibration interval of the above test instruments is 12 months. And the calibrations are traceable to NML/ROC and NIST/USA.

4.4.3 TEST SETUP

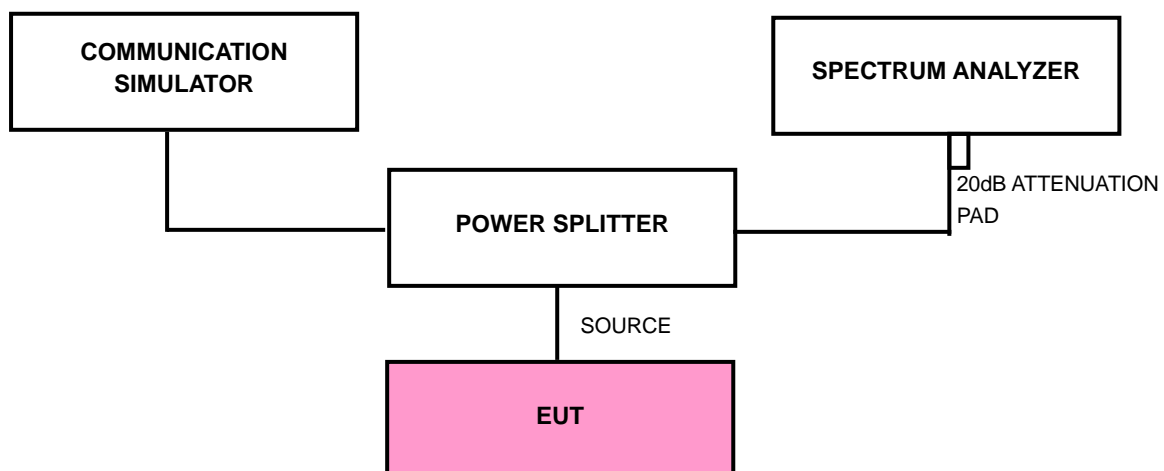

4.4.4 TEST PROCEDURES

- a. The EUT makes a call to the communication simulator. The power was measured with R&S Spectrum Analyzer. All measurements were done at 2 channels, 512 and 810 (GSM / E-GPRS) / 9262 and 9538 (WCDMA) (low and high operational frequency range.)
- b. The band edge measurement used the power splitter via EUT RF power connector between simulation base station and spectrum analyzer.
- c. The center frequency of spectrum is the band edge frequency and span is 1 MHz. RB of the spectrum is 3kHz and VB of the spectrum is 3kHz (GSM / E-GPRS).
- d. The center frequency of spectrum is the band edge frequency and span is 5 MHz. RB of the spectrum is 100kHz and VB of the spectrum is 100kHz (WCDMA).
- e. Record the max trace plot into the test report.

4.4.5 EUT OPERATING CONDITION

- a. The EUT makes a call to the communication simulator.
- b. The communication simulator station system controlled an EUT to export maximum output power under transmission mode and specific channel frequency.



A D T

4.4.6 TEST RESULTS

FOR GSM MODE

LOWER BAND EDGE

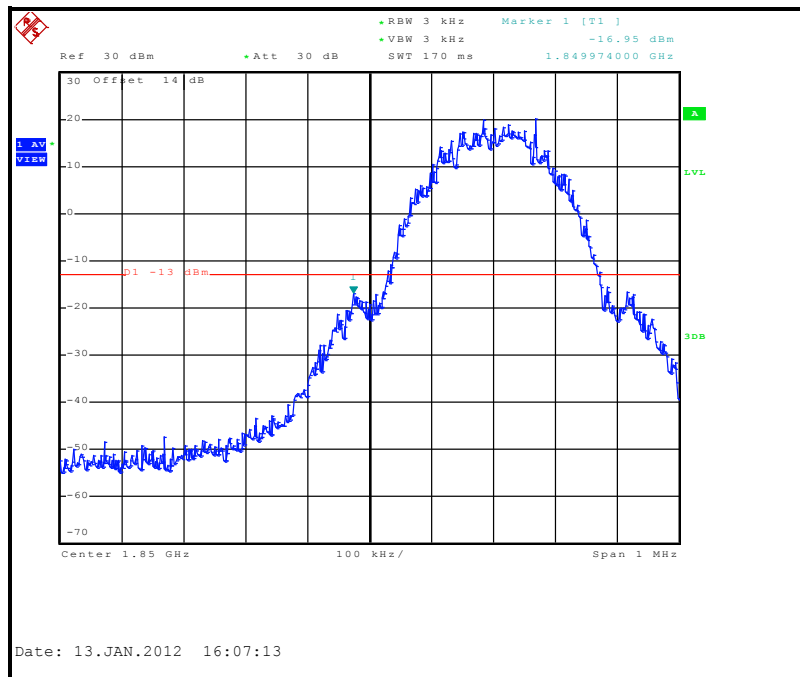

HIGHER BAND EDGE

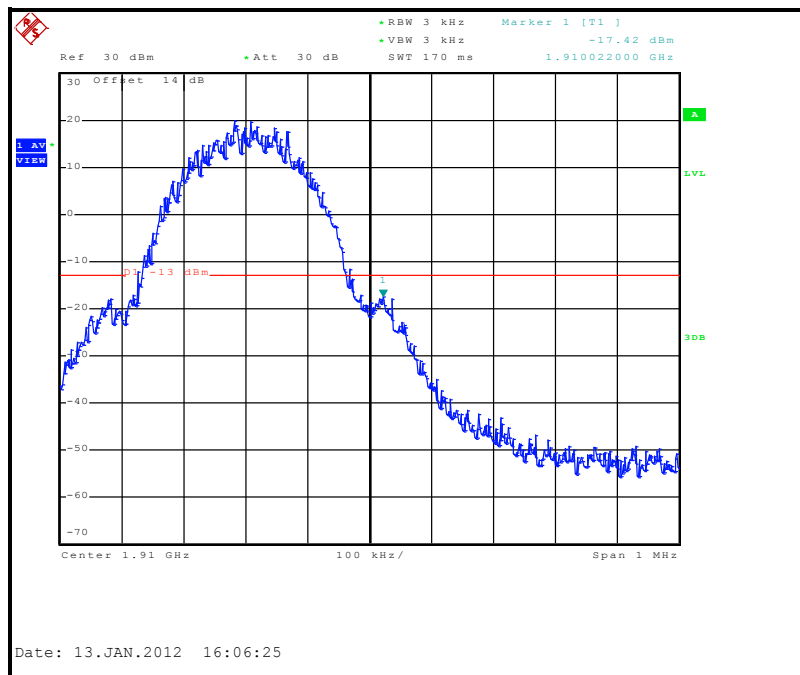



A D T

FOR E-GPRS MODE

LOWER BAND EDGE

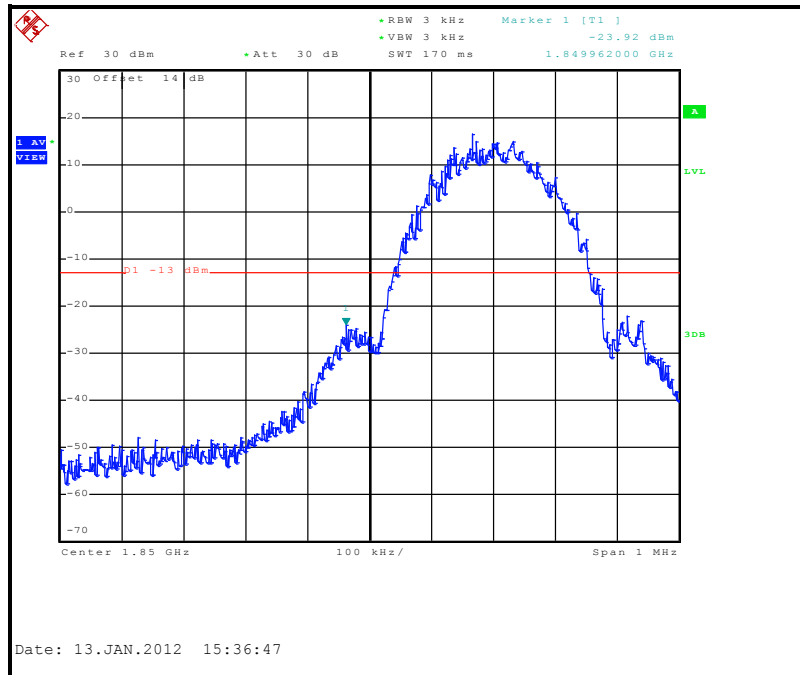

HIGHER BAND EDGE

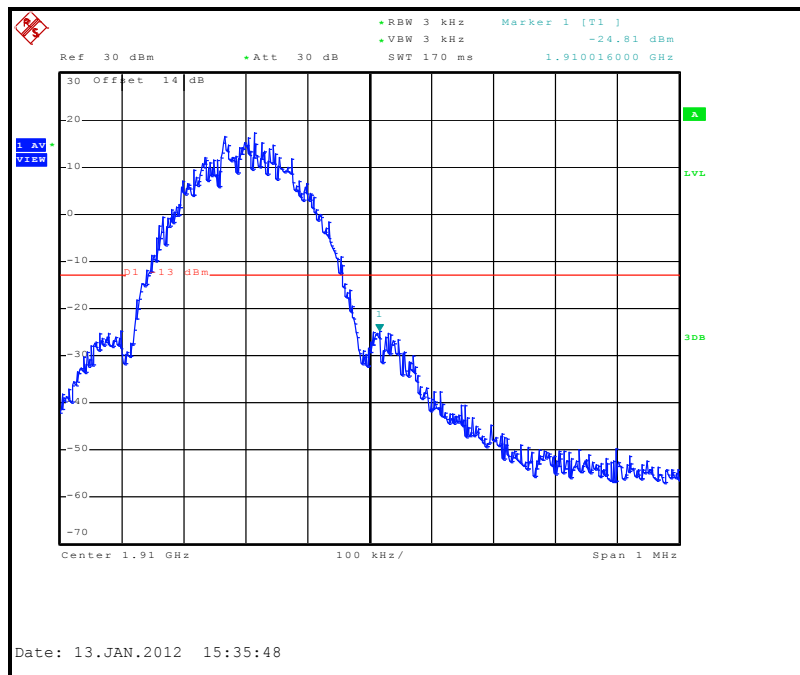



A D T

FOR WCDMA MODE

LOWER BAND EDGE

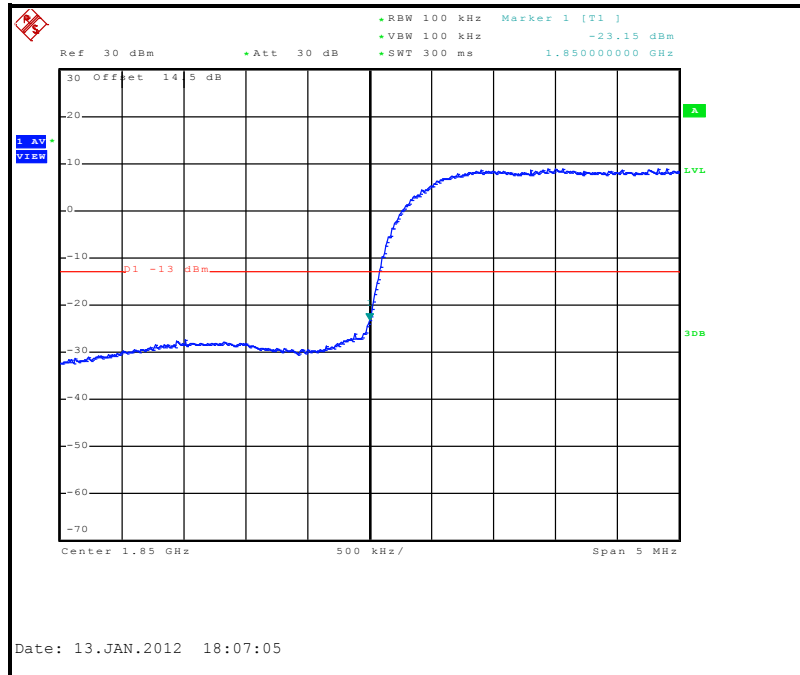

HIGHER BAND EDGE

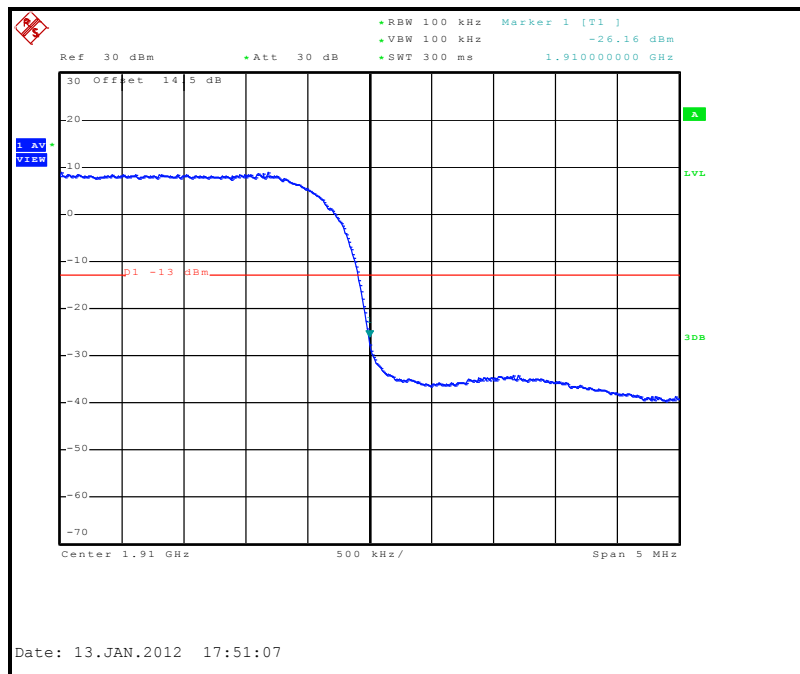



4.5 CONDUCTED SPURIOUS EMISSIONS

4.5.1 LIMITS OF CONDUCTED SPURIOUS EMISSIONS MEASUREMENT

In the FCC 24.238(a), On any frequency outside a licensee's frequency block within USPCS spectrum, the power of any emission shall be attenuated below the transmitter power (P) by at least $43 + 10 \log (P)$ dB. The specified minimum attenuation becomes 43dB and the limit of emission equal to -13dBm .

4.5.2 TEST INSTRUMENTS

DESCRIPTION & MANUFACTURER	MODEL NO.	SERIAL NO.	DATE OF CALIBRATION	DUE DATE OF CALIBRATION
SPECTRUM ANALYZER R&S	FSP40	100039	Feb. 23, 2011	Feb. 22, 2012
Mini-Circuits Power Splitter	ZN2PD-9G	NA	May 25, 2011	May 24, 2012
RF cable	SUCOFLEX 104	274403/4	Aug. 20, 2011	Aug. 19, 2012
RF cable	SUCOFLEX 104	250729/4	Aug. 19, 2011	Aug. 18, 2012
RF cable	SUCOFLEX 104	214377/4	Aug. 19, 2011	Aug. 18, 2012
JFW 20dB attenuation	50HF-020-SMA	NA	NA	NA

NOTE: The calibration interval of the above test instruments is 12 months. And the calibrations are traceable to NML/ROC and NIST/USA.

4.5.3 TEST PROCEDURE

- a. The EUT makes a phone call to the communication simulator. The power was measured with R&S Spectrum Analyzer. All measurements were done at channel 661 (GSM / E-GPRS) and channel 9400 (WCDMA).
- b. The conducted spurious emission used the power splitter via EUT RF power connector between simulation base station and spectrum analyzer.
- c. Measuring frequency range is from 30 MHz to 19.1GHz. RBW=1MHz and VBW=3MHz is used for conducted emission measurement.

4.5.4 TEST SETUP

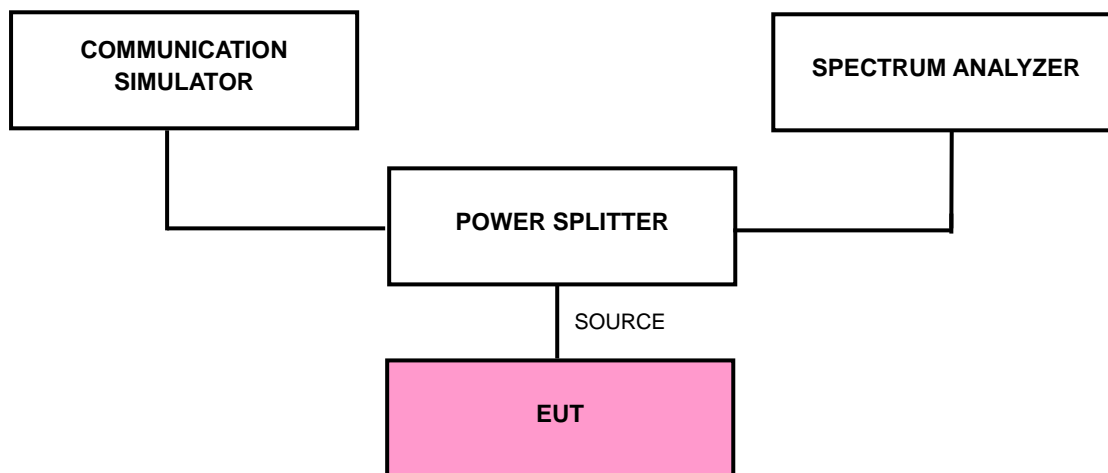

4.5.5 EUT OPERATING CONDITIONS

- a. The EUT makes a call to the communication simulator.
- b. The communication simulator station system controlled an EUT to export maximum output power under transmission mode and specific channel frequency.



A D T

4.5.6 TEST RESULTS

FOR GSM:

CH 661: 30MHz ~ 1GHz

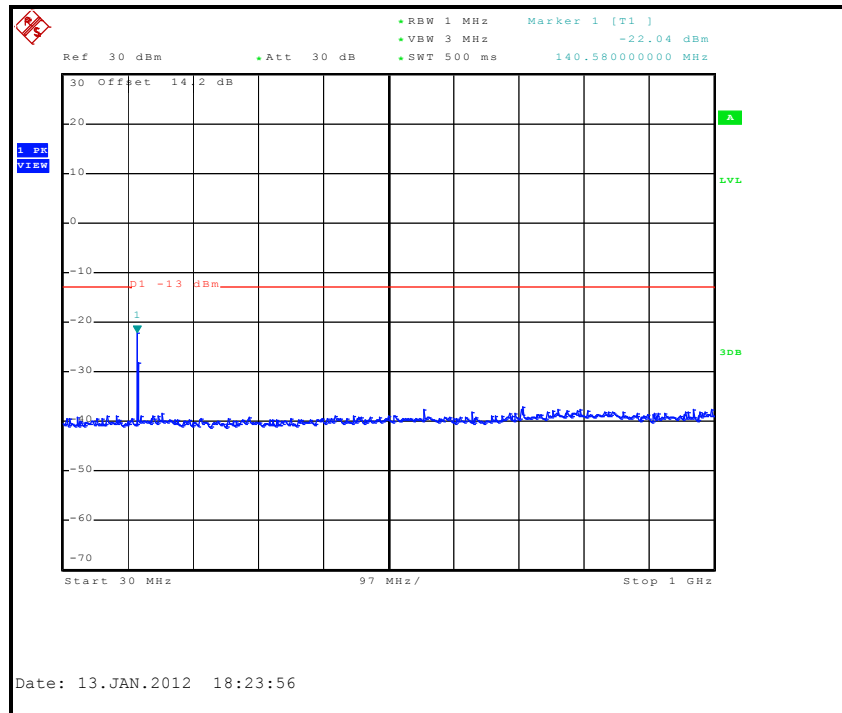

1GHz ~ 3GHz

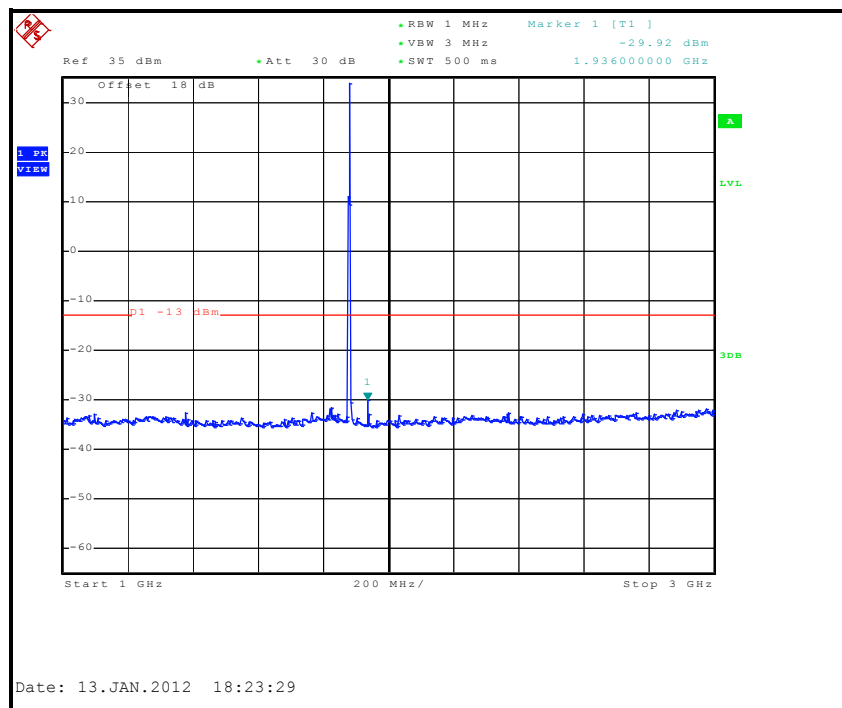



A D T

3GHz ~ 7GHz

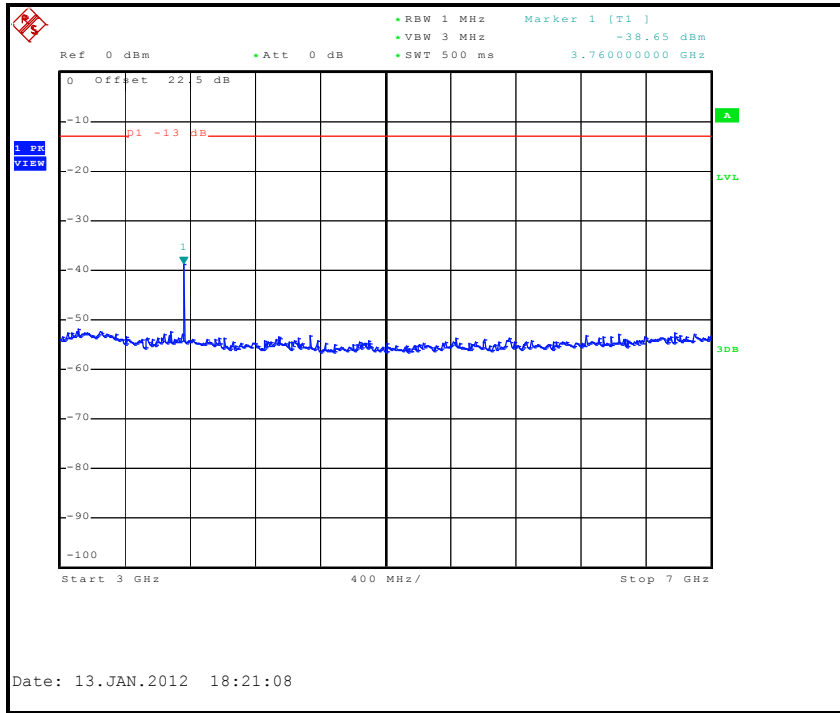

7GHz ~ 13.6GHz

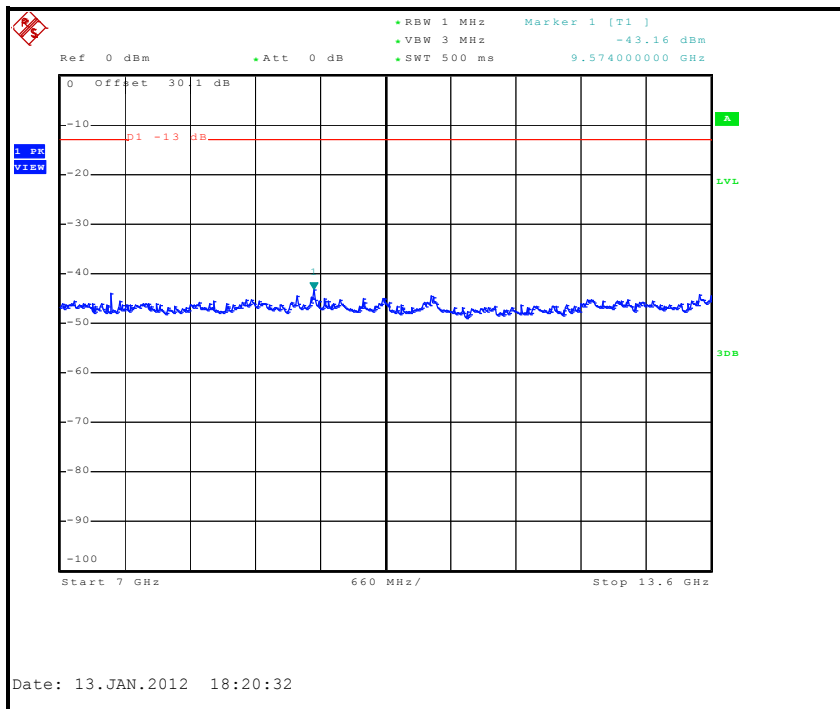



A D T

13.6GHz ~ 19.1GHz

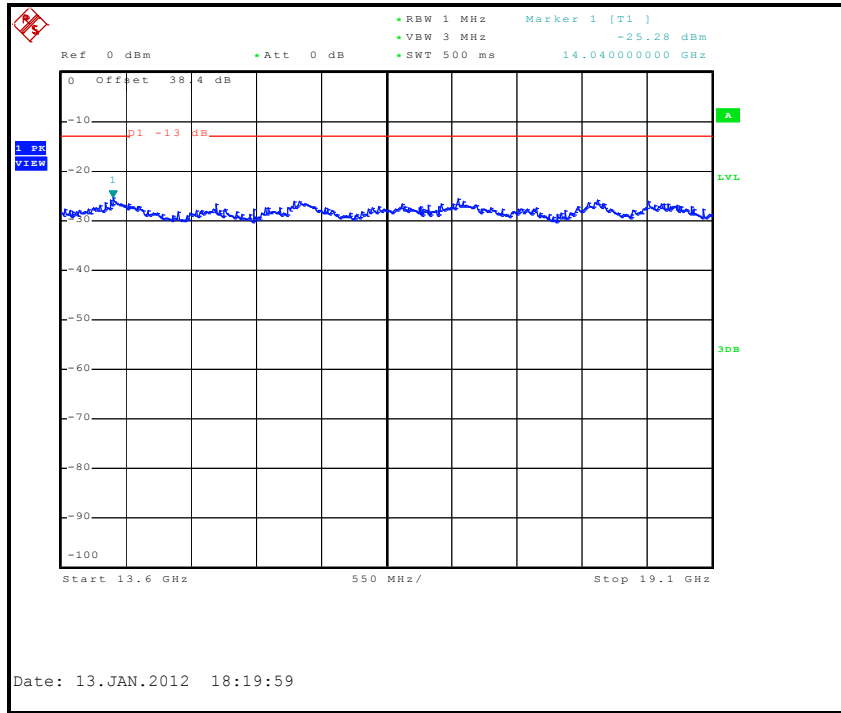



A D T

FOR E-GPRS:

CH 661: 30MHz ~ 1GHz

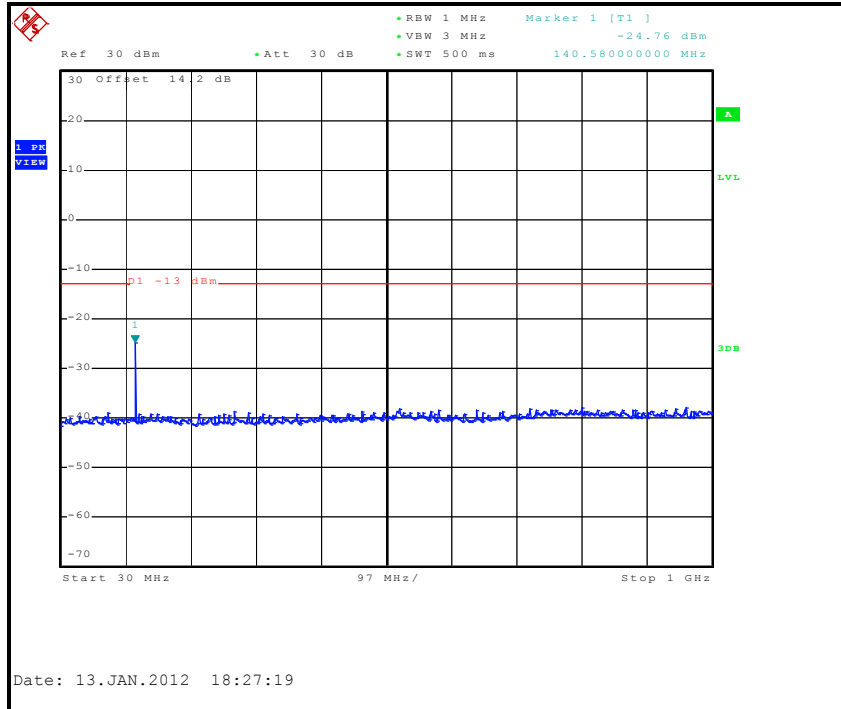

1GHz ~ 3GHz

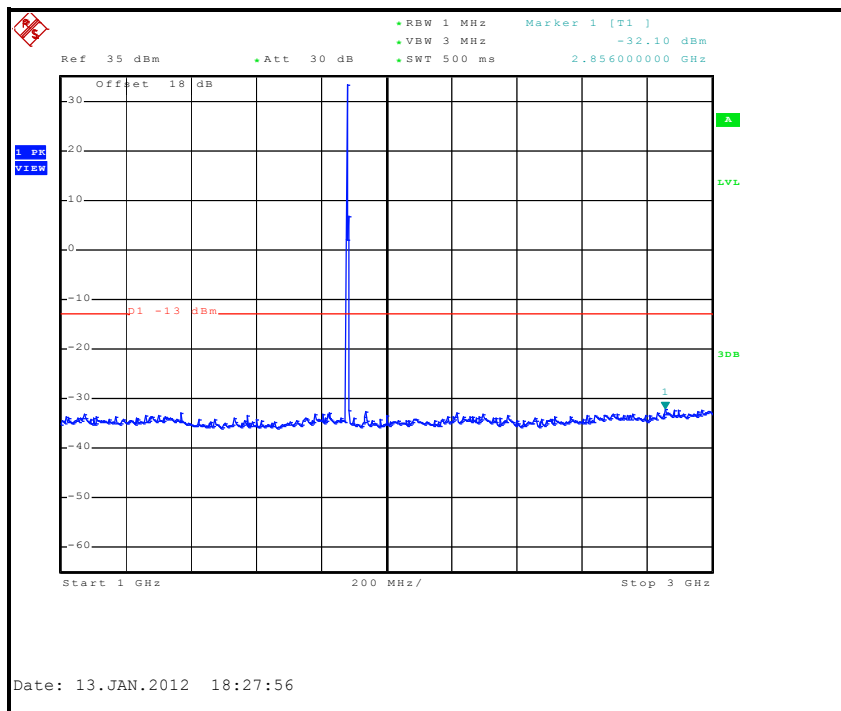



A D T

3GHz ~ 7GHz

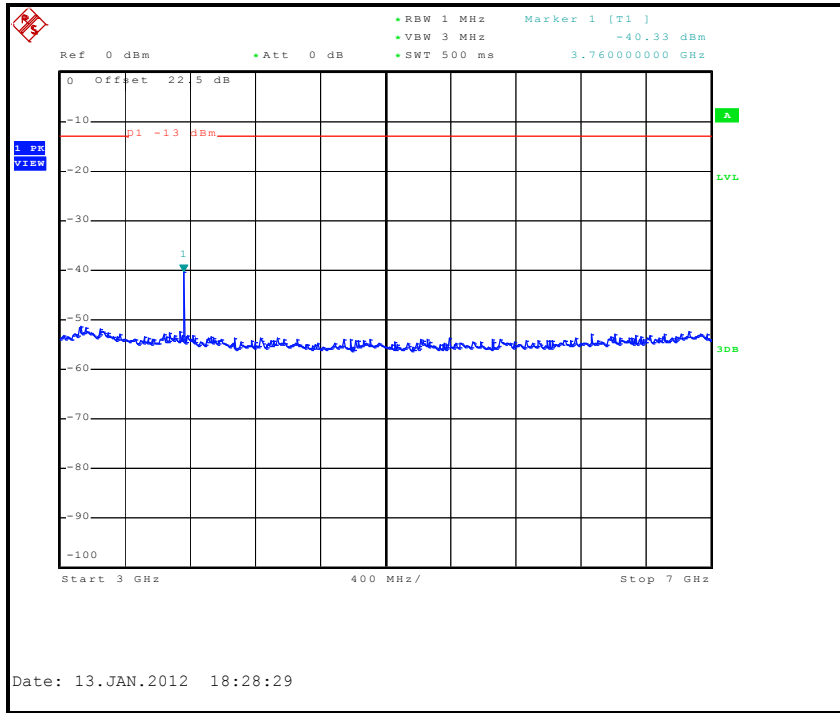

7GHz ~ 13.6GHz

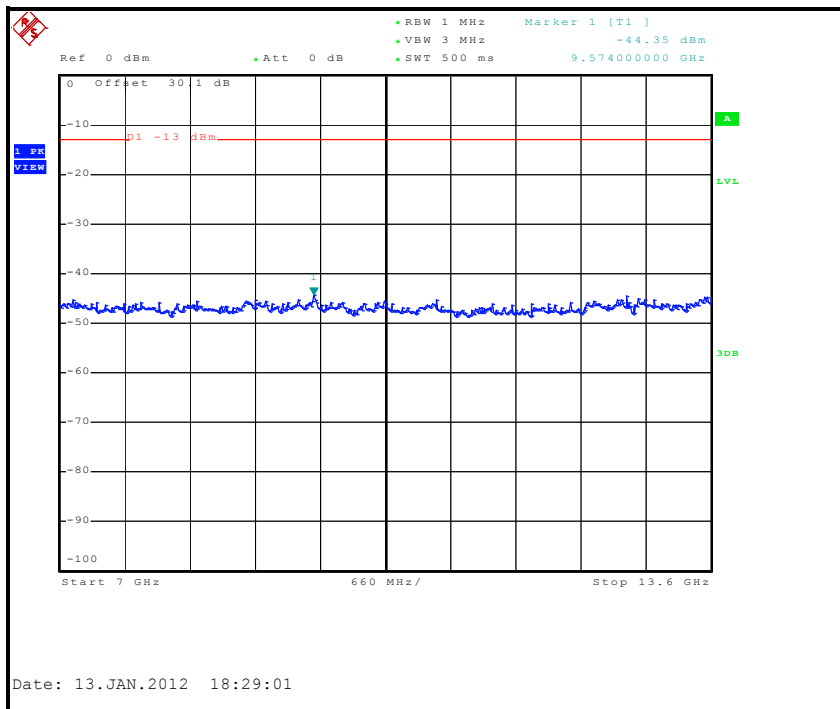



A D T

13.6GHz ~ 19.1GHz

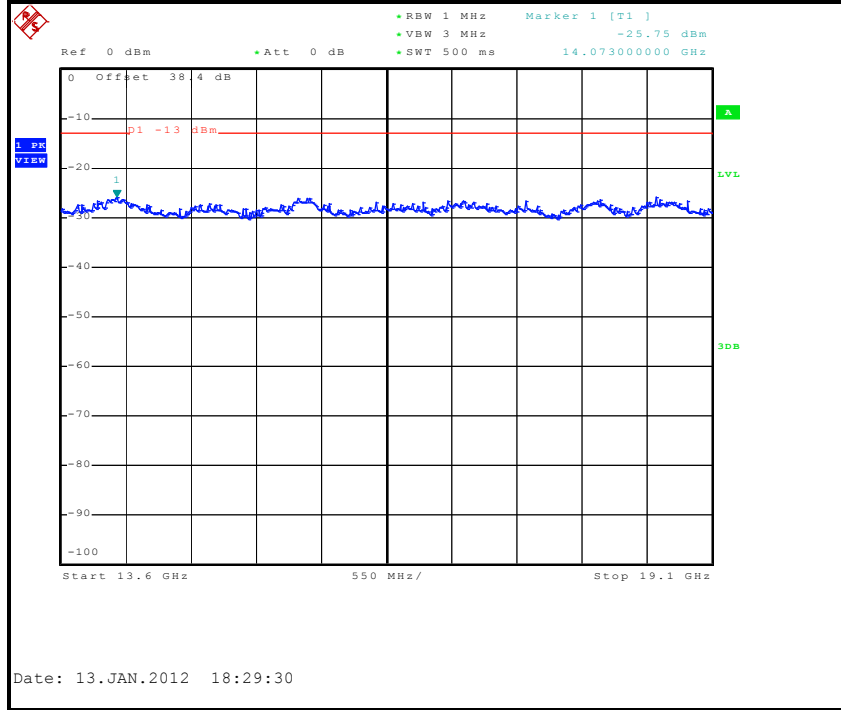



A D T

FOR WCDMA:

CH 9400: 30MHz ~ 1GHz

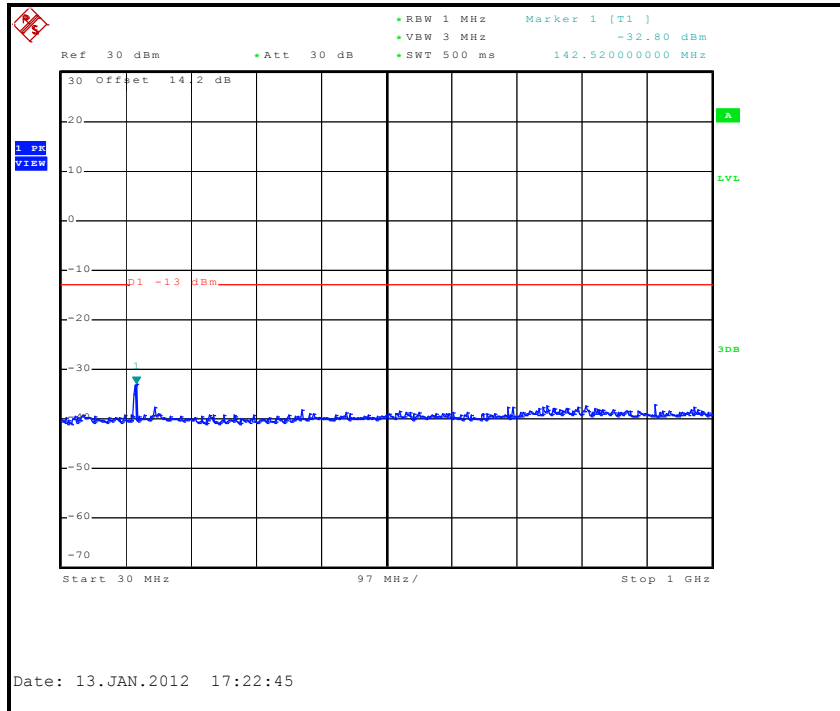

1GHz ~ 3GHz

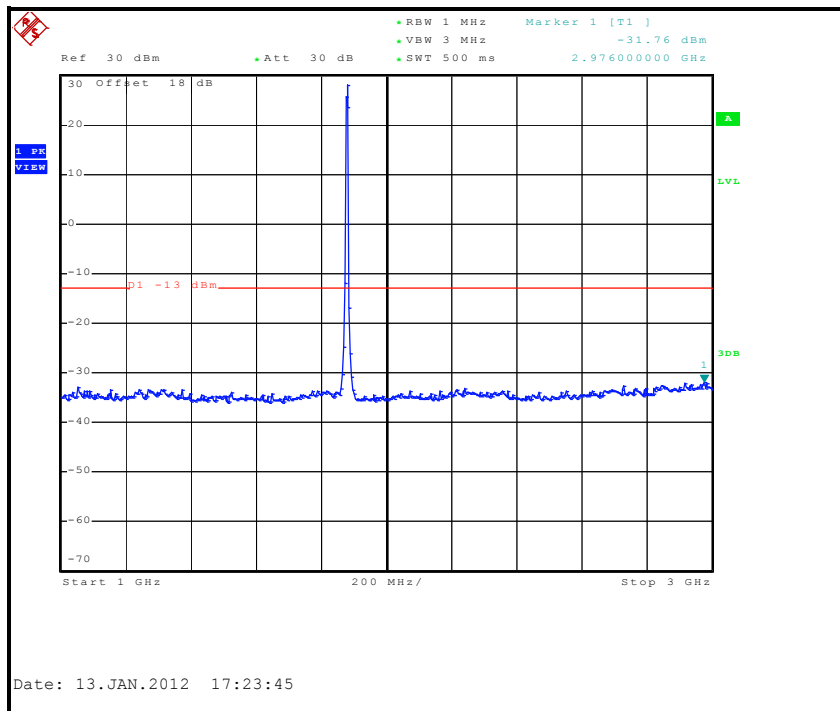



A D T

3GHz ~ 7GHz

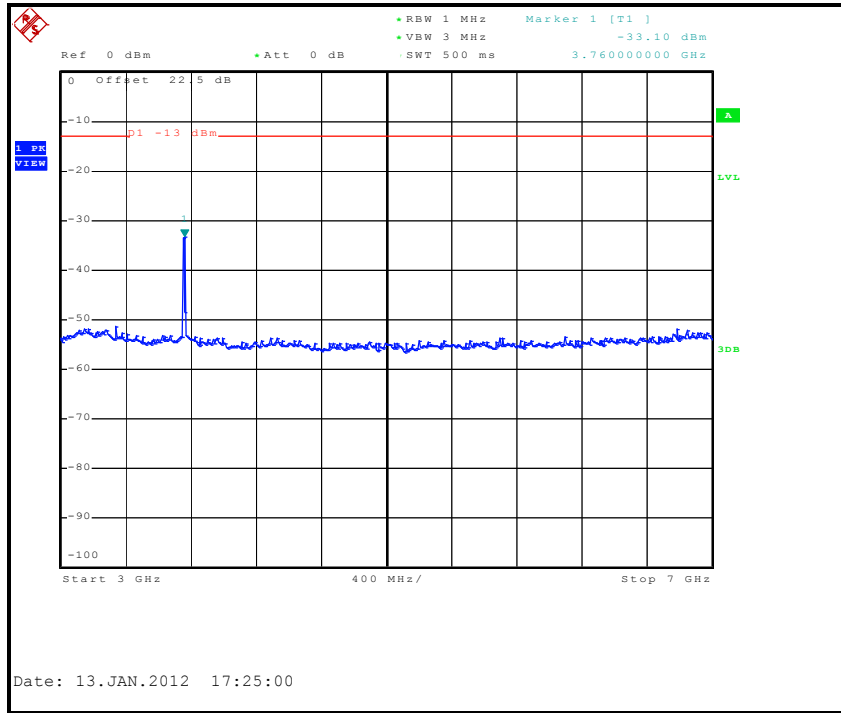

7GHz ~ 13.6GHz

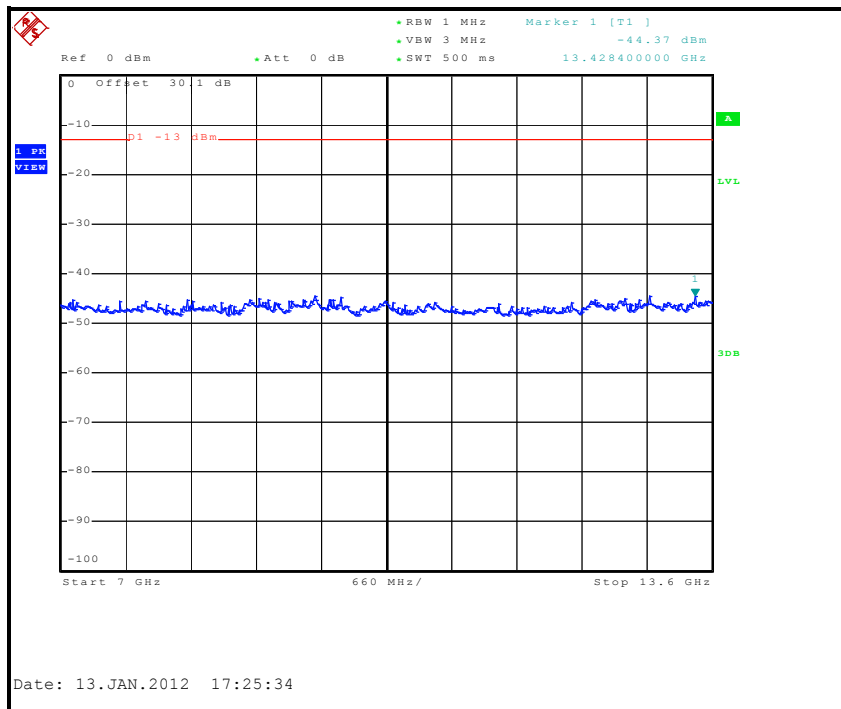



A D T

13.6GHz ~ 19.1GHz

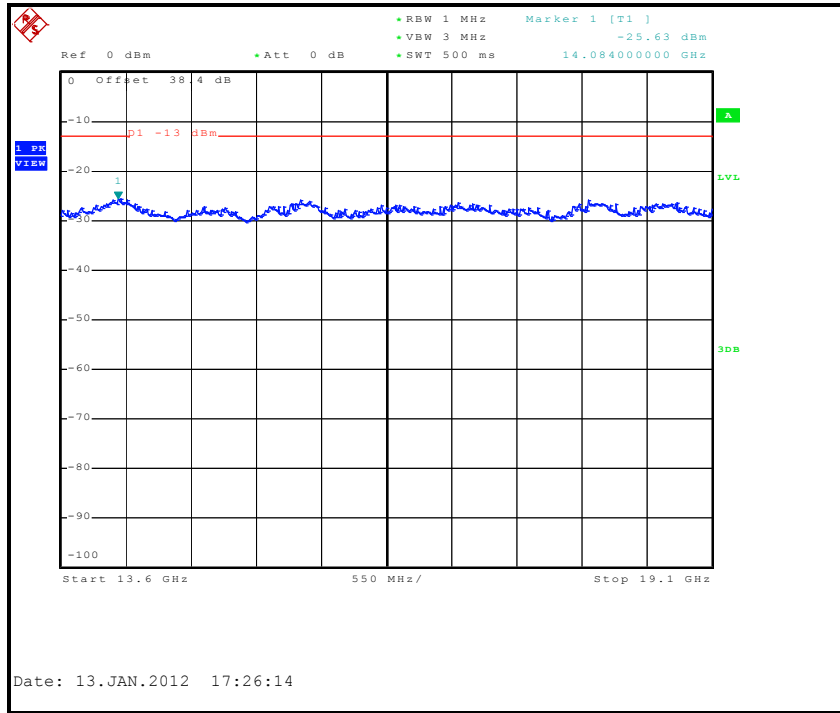

4.6 RADIATED EMISSION MEASUREMENT

4.6.1 LIMITS OF RADIATED EMISSION MEASUREMENT

In the FCC 24.238(a), On any frequency outside a licensee's frequency block within USPCS spectrum, the power of any emission shall be attenuated below the transmitter power (P) by at least $43 + 10 \log (P)$ dB. The emission of limit equal to -13dBm .

4.6.2 TEST INSTRUMENTS

Same as 4.1.2.

4.6.3 TEST PROCEDURES

- a. Substitution method is used for E.I.R.P measurement. In the semi-anechoic chamber, EUT placed on the 0.8m height of Turn Table, rotated the table around 360 degrees to search the maximum radiation power and receiver antenna shall be rotated vertical and horizontal polarization and moved height from 1m to 4m to find the maximum polar radiated power. The "Read Value" is the spectrum reading the maximum power value.
- b. The substitution horn antenna is substituted for EUT at the same position and signals generator export the CW signal to the substitution antenna via a TX cable. Rotated the Turn Table and moved receiving antenna to find the maximum radiation power. Adjust output power level of S.G to get a Value of spectrum reading equal to "Read Value" of step a. Record the power level of S.G
- c. $\text{EIRP} = \text{Output power level of S.G} - \text{TX cable loss} + \text{Antenna gain of substitution horn}$.

NOTE: The resolution bandwidth and video bandwidth of test receiver/spectrum analyzer is 1MHz/3MHz.

4.6.4 DEVIATION FROM TEST STANDARD

No deviation

4.6.5 TEST SETUP

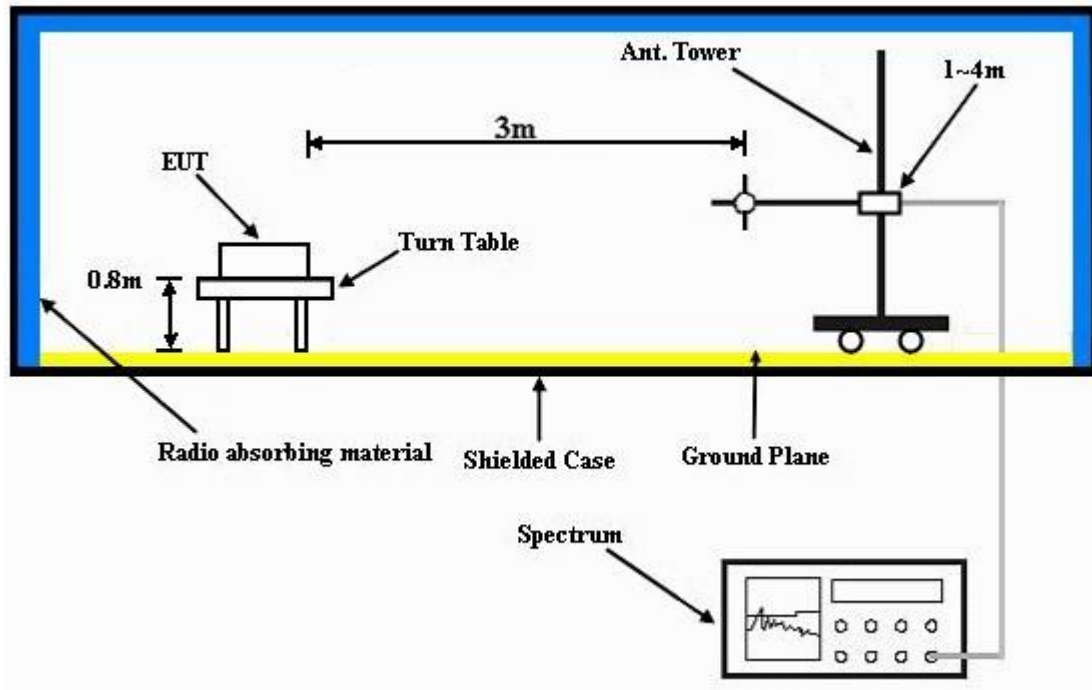

For the actual test configuration, please refer to the attached file (Test Setup Photo).

4.6.6 EUT OPERATING CONDITIONS

- The EUT makes a call to the communication simulator.
- The communication simulator station system controlled an EUT to export maximum output power under transmission mode and specific channel frequency.

4.6.7 TEST RESULTS

FOR GSM:

ENVIRONMENTAL CONDITIONS	25deg. C, 65%RH	INPUT POWER	120Vac, 60 Hz
TESTED BY	Kay Wu	POLARIZATION	Horizontal

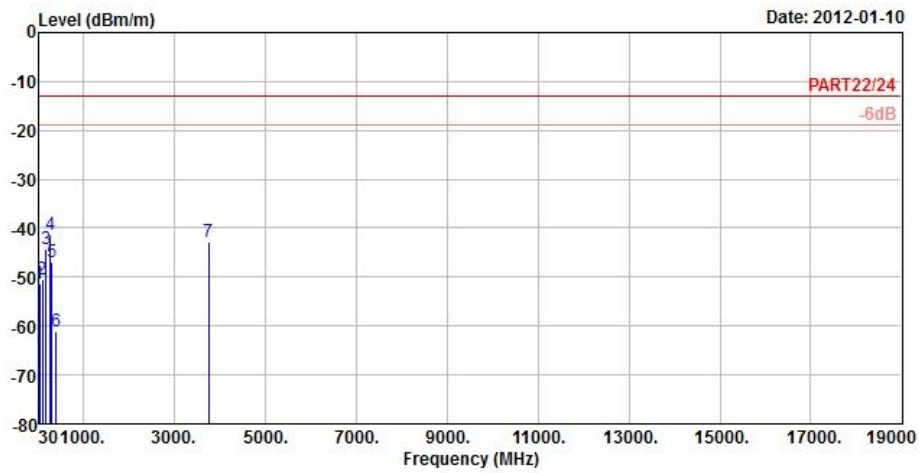

Site : 966 Chamber 2
 Condition: PART22/24 3m EIRP_RSE _1G~19G HORIZONTAL
 EUT : RJ83100
 Mode : PCS1900 link CH661
 Plane : Z
 Sample NO: C120110-004-004-005

	Freq	Level	Limit	Read	Over		Remark
	MHz	dBm/m	dBm/m	dBm	dB	dB/m	
1	33.51	-51.51	-13.00	-49.67	-38.51	-1.84	Peak
2	95.61	-50.48	-13.00	-40.01	-37.48	-10.47	Peak
3	170.67	-44.20	-13.00	-37.48	-31.20	-6.72	Peak
4 pp	268.95	-41.42	-13.00	-35.48	-28.42	-5.94	Peak
5	300.70	-46.96	-13.00	-40.59	-33.96	-6.37	Peak
6	402.20	-61.02	-13.00	-55.45	-48.02	-5.57	Peak
7	3760.00	-42.68	-13.00	-34.60	-29.68	-8.08	Peak



A D T

ENVIRONMENTAL CONDITIONS	25deg. C, 65%RH	INPUT POWER	120Vac, 60 Hz
TESTED BY	Kay Wu	POLARIZATION	Vertical

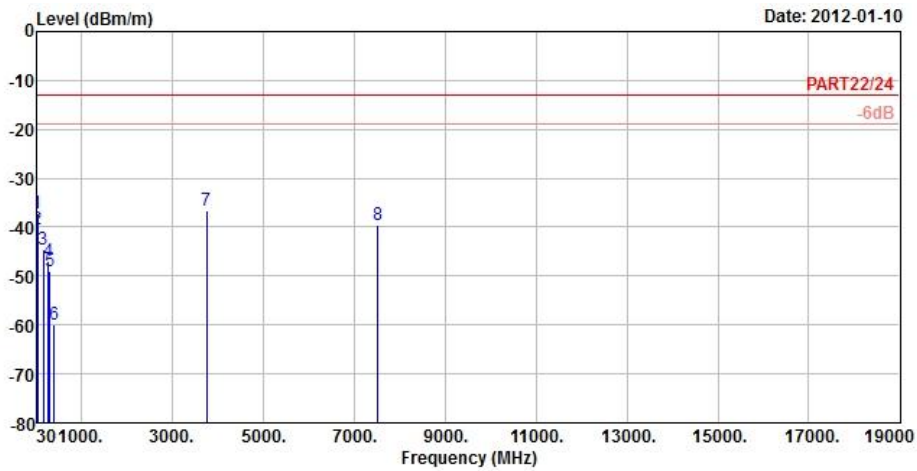

Site : 966 Chamber 2
 Condition: PART22/24 3m EIRP_RSE _1G~19G VERTICAL
 EUT : RJ83100
 Mode : PCS1900 link CH661
 Plane : Z
 Sample NO: C120110-004-004-005

	Freq	Level	Limit	Read	Over		
	MHz	dBm/m	dBm/m	dBm	dB	dB/m	
1	30.00	-37.21	-13.00	-38.28	-24.21	1.07	Peak
2	42.15	-40.56	-13.00	-39.23	-27.56	-1.33	Peak
3	165.54	-44.65	-13.00	-38.03	-31.65	-6.62	Peak
4	269.49	-46.86	-13.00	-40.91	-33.86	-5.95	Peak
5	300.70	-49.01	-13.00	-42.64	-36.01	-6.37	Peak
6	403.60	-60.04	-13.00	-54.50	-47.04	-5.54	Peak
7 pp	3760.00	-36.73	-13.00	-28.65	-23.73	-8.08	Peak
8	7520.00	-39.59	-13.00	-44.54	-26.59	4.95	Peak



A D T

FOR E-GPRS:

ENVIRONMENTAL CONDITIONS	25deg. C, 65%RH	INPUT POWER	120Vac, 60 Hz
TESTED BY	Kay Wu	POLARIZATION	Horizontal

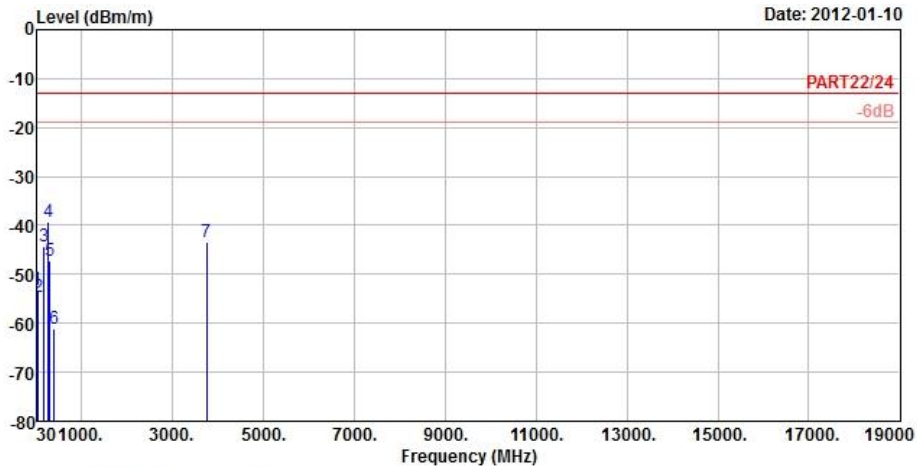

Site : 966 Chamber 2
 Condition: PART22/24 3m EIRP_RSE _1G~19G HORIZONTAL
 EUT : RJ83100
 Mode : EDGE1900 link CH661
 Plane : Z
 Sample NO: C120110-004-004-005

	Freq	Level	Limit	Read	Over		
	MHz	dBm/m	dBm/m	dBm	dB	dB/m	Remark
1	33.51	-53.28	-13.00	-51.44	-40.28	-1.84	Peak
2	42.96	-54.52	-13.00	-53.19	-41.52	-1.33	Peak
3	170.67	-44.24	-13.00	-37.52	-31.24	-6.72	Peak
4 pp	267.06	-39.16	-13.00	-33.25	-26.16	-5.91	Peak
5	300.00	-47.11	-13.00	-40.73	-34.11	-6.38	Peak
6	402.20	-61.04	-13.00	-55.47	-48.04	-5.57	Peak
7	3760.00	-43.54	-13.00	-35.46	-30.54	-8.08	Peak



A D T

ENVIRONMENTAL CONDITIONS	25deg. C, 65%RH	INPUT POWER	120Vac, 60 Hz
TESTED BY	Kay Wu	POLARIZATION	Vertical

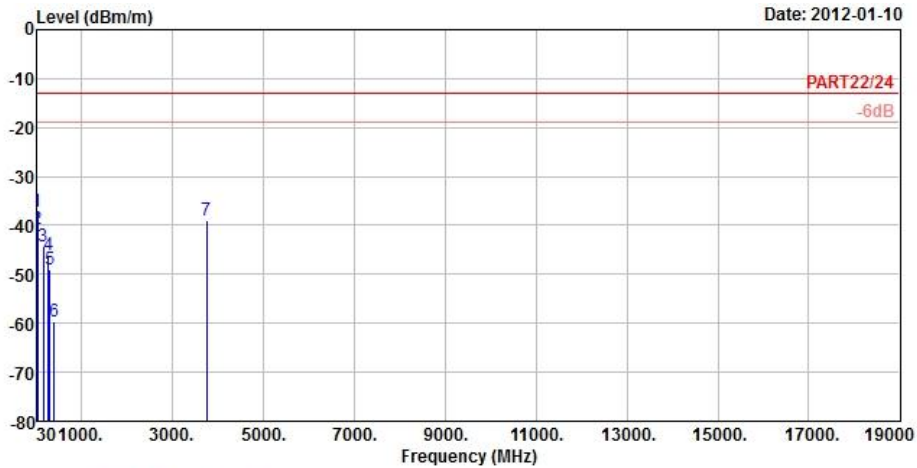

Site : 966 Chamber 2
 Condition: PART22/24 3m EIRP_RSE _1G~19G VERTICAL
 EUT : RJ83100
 Mode : EDGE1900 link CH661
 Plane : Z
 Sample NO: C120110-004-004-005

	Freq	Level	Limit	Read	Over		
	MHz	dBm/m	dBm/m	dBm	dB	dB/m	
1	pp	30.00	-37.05	-13.00	-38.12	-24.05	1.07 Peak
2		42.42	-40.87	-13.00	-39.54	-27.87	-1.33 Peak
3		166.62	-44.35	-13.00	-37.71	-31.35	-6.64 Peak
4		269.22	-46.03	-13.00	-40.08	-33.03	-5.95 Peak
5		300.70	-49.13	-13.00	-42.76	-36.13	-6.37 Peak
6		405.00	-59.68	-13.00	-54.19	-46.68	-5.49 Peak
7		3760.00	-38.87	-13.00	-30.79	-25.87	-8.08 Peak



A D T

FOR WCDMA:

ENVIRONMENTAL CONDITIONS	25deg. C, 65%RH	INPUT POWER	120Vac, 60 Hz
TESTED BY	Kay Wu	POLARIZATION	Horizontal

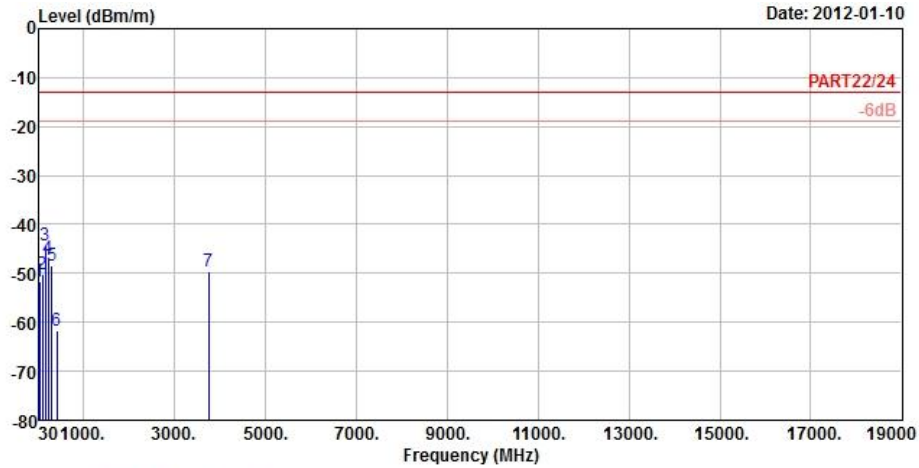

Site : 966 Chamber 2
 Condition: PART22/24 3m EIRP_RSE _1G~19G HORIZONTAL
 EUT : RJ83100
 Mode : Band II link CH9400
 Plane : Z
 Sample NO: C120110-004-004-005

	Freq	Level	Limit	Read	Over	
	MHz	dBm/m	dBm/m	dBm	dB	dB/m
1	33.51	-51.67	-13.00	-49.83	-38.67	-1.84 Peak
2	94.80	-50.27	-13.00	-39.78	-37.27	-10.49 Peak
3 pp	166.08	-44.19	-13.00	-37.57	-31.19	-6.62 Peak
4	224.67	-46.99	-13.00	-40.18	-33.99	-6.81 Peak
5	300.00	-48.55	-13.00	-42.17	-35.55	-6.38 Peak
6	421.80	-61.66	-13.00	-56.58	-48.66	-5.08 Peak
7	3760.00	-49.60	-13.00	-41.52	-36.60	-8.08 Peak



A D T

ENVIRONMENTAL CONDITIONS	25deg. C, 65%RH	INPUT POWER	120Vac, 60 Hz
TESTED BY	Kay Wu	POLARIZATION	Vertical

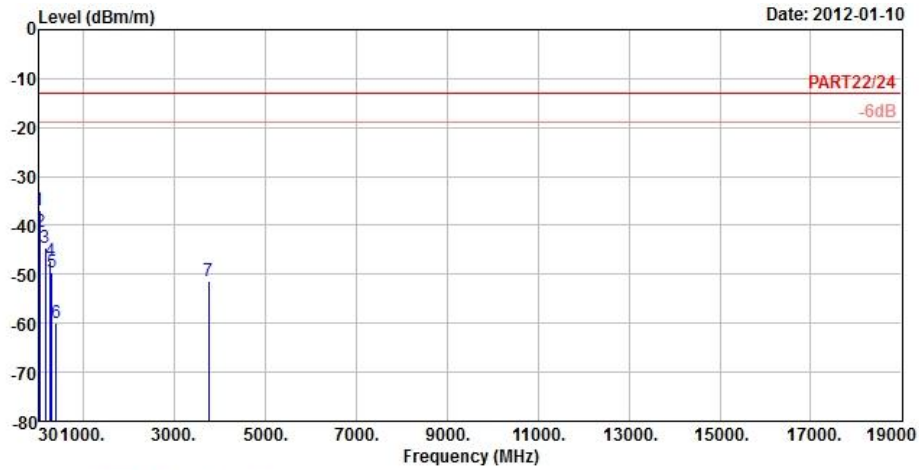

Site : 966 Chamber 2
 Condition: PART22/24 3m EIRP_RSE _1G~19G VERTICAL
 EUT : RJ83100
 Mode : Band II link CH9400
 Plane : Z
 Sample NO: C120110-004-004-005

	Freq	Level	Limit	Read	Over		
	MHz	dBm/m	dBm/m	dBm	dB	dB/m	Remark
1	pp	30.00	-37.02	-13.00	-38.09	-24.02	1.07 Peak
2		42.96	-41.42	-13.00	-40.09	-28.42	-1.33 Peak
3		165.27	-44.53	-13.00	-37.93	-31.53	-6.60 Peak
4		271.92	-47.17	-13.00	-41.19	-34.17	-5.98 Peak
5		300.00	-49.71	-13.00	-43.33	-36.71	-6.38 Peak
6		404.30	-59.85	-13.00	-54.33	-46.85	-5.52 Peak
7		3760.00	-51.28	-13.00	-43.20	-38.28	-8.08 Peak



5 PHOTOGRAPHS OF THE TEST CONFIGURATION

Please refer to the attached file (Test Setup Photo).



6 INFORMATION ON THE TESTING LABORATORIES

We, Bureau Veritas Consumer Products Services (H.K.) Ltd., Taoyuan Branch, were founded in 1988 to provide our best service in EMC, Radio, Telecom and Safety consultation. Our laboratories are accredited and approved according to ISO/IEC 17025.

Copies of accreditation and authorization certificates of our laboratories obtained from approval agencies can be downloaded from our web site:

www.adt.com.tw/index.5.phtml. If you have any comments, please feel free to contact us at the following:

Linko EMC/RF Lab:

Tel: 886-2-26052180

Fax: 886-2-26051924

Hsin Chu EMC/RF Lab:

Tel: 886-3-5935343

Fax: 886-3-5935342

Hwa Ya EMC/RF/Safety/Telecom Lab:

Tel: 886-3-3183232

Fax: 886-3-3185050

Email: service.adt@tw.bureauveritas.com

Web Site: www.adt.com.tw

The address and road map of all our labs can be found in our web site also.

7 APPENDIX A – MODIFICATIONS RECORDERS FOR ENGINEERING CHANGES TO THE EUT BY THE LAB

No modifications were made to the EUT by the lab during the test.

---END---