



A D T

FCC TEST REPORT (PART 22)

REPORT NO.: RF120409C36D-2

MODEL NO.: PJ40200

FCC ID: NM8PJ40200

RECEIVED: Apr. 23, 2012

TESTED: Apr. 26, 2012

ISSUED: May 16, 2012

APPLICANT: HTC Corporation

ADDRESS: 23, Xinghua Rd., Taoyuan 330, Taiwan, R.O.C.

ISSUED BY: Bureau Veritas Consumer Products Services
(H.K.) Ltd., Taoyuan Branch

LAB ADDRESS: No. 47, 14th Ling, Chia Pau Vil., Lin Kou Dist., New
Taipei City, Taiwan (R.O.C.)

TEST LOCATION: No. 19, Hwa Ya 2nd Rd, Wen Hwa Tsuen, Kwei
Shan Hsiang, Taoyuan Hsien 333, Taiwan, R.O.C.

This test report consists of 39 pages in total. It may be duplicated completely for legal use with the approval of the applicant. It should not be reproduced except in full, without the written approval of our laboratory. The client should not use it to claim product endorsement by TAF or any government agencies. The test results in the report only apply to the tested sample.





TABLE OF CONTENTS

RELEASE CONTROL RECORD.....	3
1 CERTIFICATION.....	4
2 SUMMARY OF TEST RESULTS.....	5
2.1 MEASUREMENT UNCERTAINTY.....	5
2.2 TEST SITE AND INSTRUMENTS.....	6
3 GENERAL INFORMATION.....	7
3.1 GENERAL DESCRIPTION OF EUT.....	7
3.2 CONFIGURATION OF SYSTEM UNDER TEST.....	8
3.3 DESCRIPTION OF SUPPORT UNITS.....	9
3.4 TEST ITEM AND TEST CONFIGURATION.....	10
3.5 EUT OPERATING CONDITIONS.....	11
3.6 GENERAL DESCRIPTION OF APPLIED STANDARDS.....	11
4 TEST TYPES AND RESULTS.....	12
4.1 OUTPUT POWER MEASUREMENT.....	12
4.1.1 LIMITS OF OUTPUT POWER MEASUREMENT.....	12
4.1.2 TEST PROCEDURES.....	12
4.1.3 TEST SETUP.....	13
4.1.4 TEST RESULTS.....	14
4.2 FREQUENCY STABILITY MEASUREMENT.....	17
4.2.1 LIMITS OF FREQUENCY STABILITY MEASUREMENT.....	17
4.2.2 TEST PROCEDURE.....	17
4.2.3 TEST SETUP.....	17
4.2.4 TEST RESULTS.....	18
4.3 OCCUPIED BANDWIDTH MEASUREMENT.....	19
4.3.1 TEST PROCEDURES.....	19
4.3.2 TEST SETUP.....	19
4.3.3 TEST RESULTS.....	20
4.4 BAND EDGE MEASUREMENT.....	21
4.4.1 LIMITS OF BAND EDGE MEASUREMENT.....	21
4.4.2 TEST SETUP.....	21
4.4.3 TEST PROCEDURES.....	21
4.4.4 TEST RESULTS.....	22
4.5 CONDUCTED SPURIOUS EMISSIONS.....	23
4.5.1 LIMITS OF CONDUCTED SPURIOUS EMISSIONS MEASUREMENT.....	23
4.5.2 TEST PROCEDURE.....	23
4.5.3 TEST SETUP.....	23
4.5.4 TEST RESULTS.....	24
4.6 RADIATED EMISSION MEASUREMENT.....	27
4.6.1 LIMITS OF RADIATED EMISSION MEASUREMENT.....	27
4.6.2 TEST PROCEDURES.....	27
4.6.3 DEVIATION FROM TEST STANDARD.....	27
4.6.4 TEST SETUP.....	28
4.6.5 TEST RESULTS.....	29
5 PHOTOGRAPHS OF THE TEST CONFIGURATION.....	37
6 INFORMATION ON THE TESTING LABORATORIES.....	38
7 APPENDIX A – MODIFICATIONS RECORDERS FOR ENGINEERING CHANGES TO THE EUT BY THE LAB.....	39



A D T

RELEASE CONTROL RECORD

ISSUE NO.	REASON FOR CHANGE	DATE ISSUED
RF120409C36D-2	Original release	May 16, 2012



A D T

1 CERTIFICATION

PRODUCT: Smartphone

MODEL: PJ40200

BRAND: HTC

APPLICANT: HTC Corporation

TESTED: Apr. 26, 2012

TEST SAMPLE: Production Unit

STANDARDS: FCC PART 22, Subpart H

The above equipment (model: PJ40200) has been tested by **Bureau Veritas Consumer Products Services (H.K.) Ltd., Taoyuan Branch**, and found compliance with the requirement of the above standards. The test record, data evaluation & Equipment Under Test (EUT) configurations represented herein are true and accurate accounts of the measurements of the sample's EMC characteristics under the conditions specified in this report.

PREPARED BY :  , **DATE** : May 16, 2012
Pettie Chen / Specialist

APPROVED BY :  , **DATE** : May 16, 2012
Gary Chang / Technical Manager

2 SUMMARY OF TEST RESULTS

The EUT has been tested according to the following specifications:

APPLIED STANDARD: FCC Part 22 & Part 2			
STANDARD SECTION	TEST TYPE	RESULT	REMARK
2.1046 22.913 (a)	Effective radiated power	PASS	Meet the requirement of limit.
2.1055 22.355	Frequency Stability	PASS	Meet the requirement of limit.
2.1049	Occupied Bandwidth	PASS	Meet the requirement of limit.
22.917	Band Edge Measurements	PASS	Meet the requirement of limit.
2.1051 22.917	Conducted Spurious Emissions	PASS	Meet the requirement of limit.
2.1053 22.917	Radiated Spurious Emissions	PASS	Meet the requirement of limit. Minimum passing margin is -18.06dB at 30.00MHz.

2.1 MEASUREMENT UNCERTAINTY

Where relevant, the following measurement uncertainty levels have been estimated for tests performed on the EUT as specified in CISPR 16-4-2:

MEASUREMENT	FREQUENCY	UNCERTAINTY
Conducted emissions	150kHz~30MHz	2.44 dB
Radiated emissions	30MHz ~ 200MHz	2.93 dB
	200MHz ~1000MHz	2.95 dB
	1GHz ~ 18GHz	2.26 dB
	18GHz ~ 40GHz	1.94 dB

This uncertainty represents an expanded uncertainty expressed at approximately the 95% confidence level using a coverage factor of k=2.



A D T

2.2 TEST SITE AND INSTRUMENTS

DESCRIPTION & MANUFACTURER	MODEL NO.	SERIAL NO.	DATE OF CALIBRATION	DUE DATE OF CALIBRATION
Test Receiver Agilent	N9038A	MY51210203	Dec. 22, 2011	Dec. 21, 2012
Spectrum Analyzer ROHDE & SCHWARZ	FSU43	101261	Dec. 21, 2011	Dec. 20, 2012
BILOG Antenna SCHWARZBECK	VULB9168	9168-472	Dec. 20, 2011	Dec. 19, 2012
HORN Antenna SCHWARZBECK	BBHA 9120 D	9120D-969	Dec. 20, 2011	Dec. 19, 2012
HORN Antenna SCHWARZBECK	BBHA 9170	9170-480	Dec. 20, 2011	Dec. 19, 2012
Preamplifier EMCI	EMC 012645	980115	Dec. 30, 2011	Dec. 29, 2012
Preamplifier EMCI	EMC 330H	980112	Dec. 30, 2011	Dec. 29, 2012
RF signal cable HUBER+SUHNNER	SUCOFLEX 104	309219/4	Oct. 21, 2011	Oct. 20, 2012
RF signal cable HUBER+SUHNNER	SUCOFLEX 104	250130/4	Jan. 02, 2012	Jan. 01, 2013
RF signal cable Worken	RG-213	NA	Jan. 02, 2012	Jan. 01, 2013
Software	E3 6.120103	NA	NA	NA
Antenna Tower MF	MFA-440H	NA	NA	NA
Turn Table MF	MFT-201SS	NA	NA	NA
Antenna Tower & Turn Table Controller MF	MF-7802	NA	NA	NA
Mini-Circuits Power Splitter	ZN2PD-9G	NA	May 25, 2011	May 24, 2012
JFW 20dB attenuation	50HF-020-SMA	NA	NA	NA

- NOTE:** 1. The calibration interval of the above test instruments is 12 months and the calibrations are traceable to NML/ROC and NIST/USA.
2. The test was performed in HwaYa Chamber 9.
3. The horn antenna and HP preamplifier (model: 8449B) are used only for the measurement of emission frequency above 1GHz if tested.
4. The FCC Site Registration No. is 460141.
5. The IC Site Registration No. is IC 7450F-4.



3 GENERAL INFORMATION

3.1 GENERAL DESCRIPTION OF EUT

EUT	Smartphone
MODEL NO.	PJ40200
POWER SUPPLY	5.0Vdc (adapter or host equipment) 3.7Vdc (battery)
MODULATION TYPE	GSM, GPRS: GMSK EDGE: 8PSK WCDMA : BPSK
FREQUENCY RANGE	GSM, GPRS, EDGE: 824.2MHz ~ 848.8MHz WCDMA: 826.4MHz ~ 846.6MHz
MAX. ERP POWER	GSM: 0.49Watts EDGE: 0.05Watts WCDMA: 0.03Watts
MULTI-SLOTS CLASS	12
WCDMA RELEASE VERSION	6
ANTENNA TYPE	Fixed Internalantenna with -7.69dBi gain
I/O PORTS	Refer to users' manual
DATA CABLE	Refer to Note as below
ACCESSORY DEVICES	Refer to Note as below

NOTE:

1. The EUT's accessories list refers to Ext Pho.pdf.
2. The above EUT information was declared by manufacturer and for more detailed features description, please refer to the manufacturer's specifications or User's Manual.

3.2 CONFIGURATION OF SYSTEM UNDER TEST

FOR RADIATION EMISSION TEST

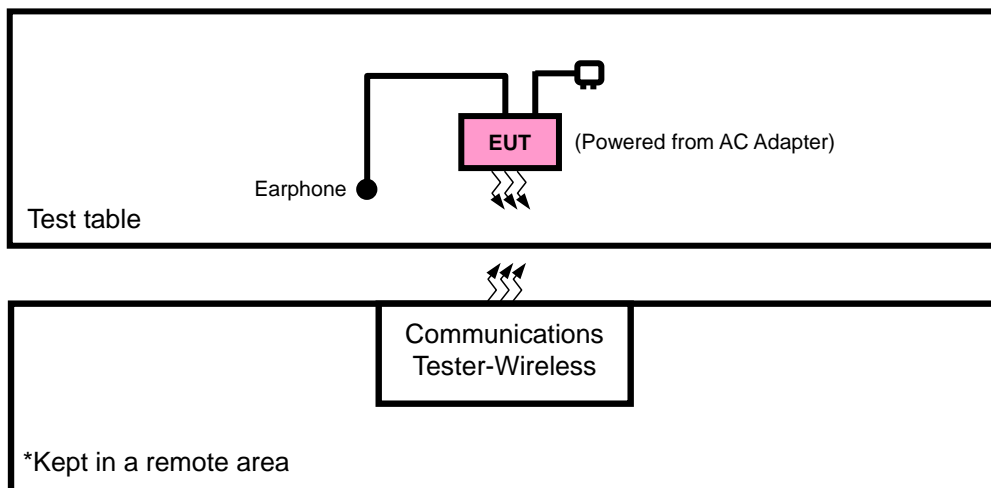

FOR E.R.P. TEST

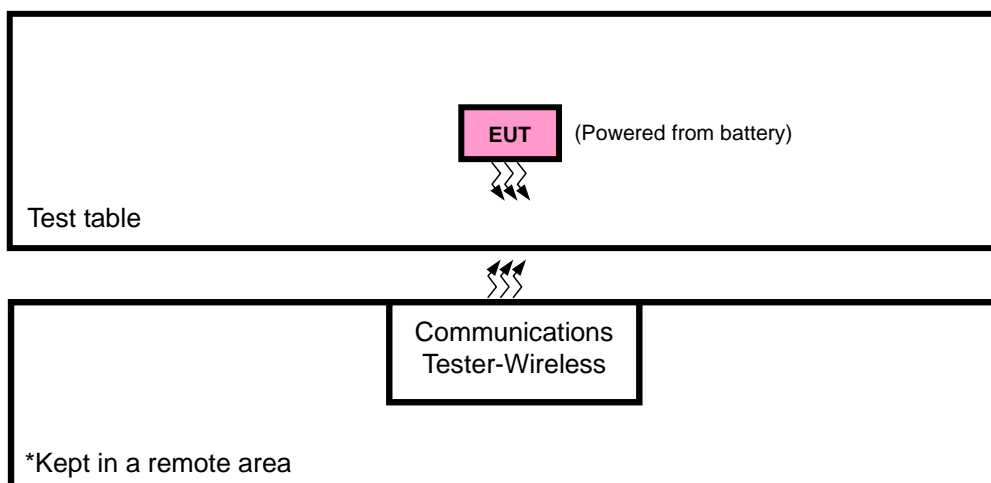



3.3 DESCRIPTION OF SUPPORT UNITS

The EUT has been tested as an independent unit together with other necessary accessories or support units. The following support units or accessories were used to form a representative test configuration during the tests.

NO.	PRODUCT	BRAND	MODEL NO.	SERIAL NO.	FCC ID
1	Communications Tester-Wireless	Agilent	E5515C	MY50266653	NA

NO.	SIGNAL CABLE DESCRIPTION OF THE ABOVE SUPPORT UNITS
1	NA

NOTE:

1. All power cords of the above support units are non shielded (1.8m).
2. Item 1 acted as a communication partners to transfer data.



3.4 TEST ITEM AND TEST CONFIGURATION

Pre-Scan has been conducted to determine the worst-case mode from all possible combinations between available modulations, data rates, XYZ axis and antenna ports. The worst case was found when positioned on Y-plane for ERP and Y-axis for radiated emission (Test Mode A), X-axis for radiated emission (Test Mode B). Following channel(s) was (were) selected for the final test as listed below:

EUT CONFIGURE MODE	DESCRIPTION
A	Main Sample
B	Second Sample

GSM MODE

EUT CONFIGURE MODE	TEST ITEM	AVAILABLE CHANNEL	TESTED CHANNEL	MODE
A, B	ERP	128 to 251	128, 189, 251	GSM, EDGE
A	FREQUENCY STABILITY	128 to 251	189	GSM, EDGE
A	OCCUPIED BANDWIDTH	128 to 251	128, 189, 251	GSM, EDGE
A	BAND EDGE	128 to 251	128, 251	GSM, EDGE
A	CONDCUDED EMISSION	128 to 251	189	GSM, EDGE
A	RADIATED EMISSION	128 to 251	189	GSM, EDGE
B	RADIATED EMISSION	128 to 251	189	GSM

WCDMA MODE

EUT CONFIGURE MODE	TEST ITEM	AVAILABLE CHANNEL	TESTED CHANNEL	MODE
A, B	ERP	4132 to 4233	4132, 4182, 4233	WCDMA
A	FREQUENCY STABILITY	4132 to 4233	4182	WCDMA
A	OCCUPIED BANDWIDTH	4132 to 4233	4132, 4182, 4233	WCDMA
A	BAND EDGE	4132 to 4233	4132, 4233	WCDMA
A	CONDCUDED EMISSION	4132 to 4233	4182	WCDMA
A	RADIATED EMISSION	4132 to 4233	4182	WCDMA

TEST CONDITION:

TEST ITEM	ENVIRONMENTAL CONDITIONS	INPUT POWER	TESTED BY
ERP	25deg. C, 65%RH	3.7Vdc	Phoenix Chen
FREQUENCY STABILITY	25deg. C, 65%RH	3.7Vdc	Phoenix Chen
OCCUPIED BANDWIDTH	25deg. C, 65%RH	3.7Vdc	Phoenix Chen
BAND EDGE	25deg. C, 65%RH	3.7Vdc	Phoenix Chen
CONDCUDED EMISSION	25deg. C, 65%RH	3.7Vdc	Phoenix Chen
RADIATED EMISSION	25deg. C, 65%RH	120Vac, 60Hz	Kay Wu

3.5 EUT OPERATING CONDITIONS

The EUT makes a call to the communication simulator. The communication simulator station system controlled a EUT to export maximum output power under transmission mode and specific channel frequency

3.6 GENERAL DESCRIPTION OF APPLIED STANDARDS

The EUT is a RF product. According to the specifications of the manufacturer, it must comply with the requirements of the following standards:

FCC 47 CFR Part 2

FCC 47 CFR Part 22

ANSI/TIA/EIA-603-C 2004

NOTE: All test items have been performed and recorded as per the above standards.

4 TEST TYPES AND RESULTS

4.1 OUTPUT POWER MEASUREMENT

4.1.1 LIMITS OF OUTPUT POWER MEASUREMENT

Mobile / Portable station are limited to 7 watts e.r.p.

4.1.2 TEST PROCEDURES

EIRP / ERP MEASUREMENT:

- a. All measurements were done at low, middle and high operational frequency range. RWB and VBW is 1MHz for GSM & EDGE and 5MHz for WCDMA mode.
- b. Substitution method is used for E.I.R.P measurement. In the semi-anechoic chamber, EUT placed on the 0.8m height of Turn Table, rotated the table around 360 degrees to search the maximum radiation power and receiver antenna shall be rotated vertical and horizontal polarization and moved height from 1m to 4m to find the maximum polar radiated power. The “Read Value” is the spectrum reading the maximum power value.
- c. The substitution horn antenna is substituted for EUT at the same position and signals generator export the CW signal to the substitution antenna via a tx cable. Rotated the Turn Table and moved receiving antenna to find the maximum radiation power. Adjust output power level of S.G to get a Value of spectrum reading equal to “Read Value” of step b. Record the power level of S.G
- d. $EIRP = \text{Output power level of S.G} - \text{TX cable loss} + \text{Antenna gain of substitution horn.}$
E.R.P power can be calculated form E.I.R.P power by subtracting the gain of dipole, $E.R.P \text{ power} = E.I.P.R \text{ power} - 2.15\text{dBi.}$

CONDUCTED POWER MEASUREMENT:

The EUT was set up for the maximum power with GSM, EDGE & WCDMA link data modulation and link up with simulator. Set the EUT to transmit under low, middle and high channel and record the power level shown on simulator.

4.1.3 TEST SETUP

EIRP / ERP MEASUREMENT:

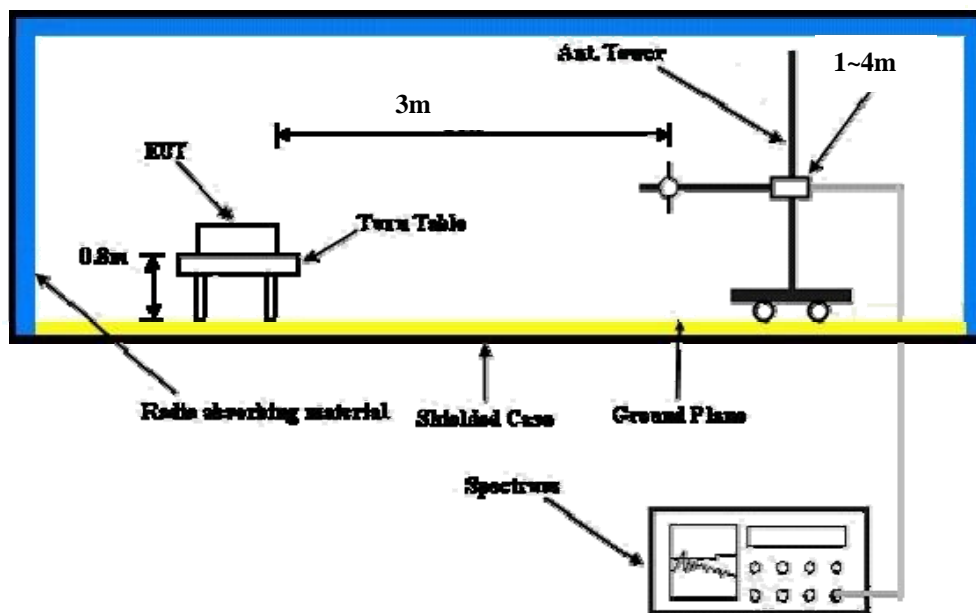

For the actual test configuration, please refer to the attached file (Test Setup Photo).

CONDUCTED POWER MEASUREMENT:

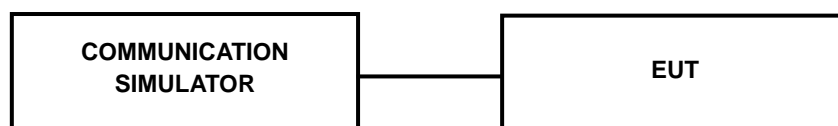

For the actual test configuration, please refer to the attached file (Test Setup Photo).

4.1.4 TEST RESULTS

CONDUCTED OUTPUT POWER (dBm)

Band	GSM850		
Channel	128	189	251
Frequency (MHz)	824.2	836.4	848.8
GSM (GMSK, 1 slot)	33.32	33.18	33.31
GPRS 8 (GMSK, 1 slot)	33.31	33.17	33.30
GPRS 10 (GMSK, 2 slot)	30.39	30.42	30.55
GPRS 11 (GMSK, 3 slot)	28.30	28.48	28.47
GPRS 12 (GMSK, 4 slot)	27.78	27.74	27.53
DTM 9 (GMSK, 2 slot)	30.63	30.65	30.75
DTM 11 (GMSK, 3 slot)	28.65	28.79	28.70
EDGE 8 (8PSK, 1 slot)	25.87	25.84	25.83
EDGE 10 (8PSK, 2 slot)	25.35	25.38	25.41
EDGE 11 (8PSK, 3 slot)	24.78	24.79	24.80
EDGE 12 (8PSK, 4 slot)	23.94	23.92	23.90
DTM 9 (8PSK, 2 slot)	26.38	26.42	26.31
DTM 11 (8PSK, 3 slot)	26.03	26.07	25.95

Band	WCDMA V		
Channel	4132	4182	4233
Frequency (MHz)	826.4	836.4	846.6
RMC 12.2K	23.34	23.41	23.29
HSDPA Subtest-1	22.89	22.98	22.85
HSDPA Subtest-2	22.86	22.96	22.86
HSDPA Subtest-3	22.41	22.49	22.39
HSDPA Subtest-4	22.40	22.40	22.36
HSUPA Subtest-1	22.05	22.21	22.22
HSUPA Subtest-2	21.12	21.26	21.24
HSUPA Subtest-3	20.92	20.97	21.14
HSUPA Subtest-4	21.26	21.33	21.63
HSUPA Subtest-5	22.76	22.86	22.70

ERP POWER (dBm)
Test Mode A
GSM 850

Plane	Channel	Frequency (MHz)	LVL (dBm)	Correction Factor(dB)	ERP(dBm)	ERP(W)	Polarization (H/V)
Y	128	824.2	-7.26	32.62	23.21	0.21	H
	189	836.4	-7.17	32.52	23.20	0.21	H
	251	848.8	-6.86	32.65	23.64	0.23	H
	128	824.2	-17.54	32.76	13.07	0.02	V
	189	836.4	-16.73	32.39	13.51	0.02	V
	251	848.8	-16.81	32.54	13.58	0.02	V

EDGE 850

Plane	Channel	Frequency (MHz)	LVL (dBm)	Correction Factor(dB)	ERP(dBm)	ERP(W)	Polarization (H/V)
Y	128	824.2	-14.08	32.62	16.39	0.04	H
	189	836.4	-13.46	32.52	16.91	0.05	H
	251	848.8	-13.26	32.65	17.24	0.05	H
	128	824.2	-23.43	32.76	7.18	0.01	V
	189	836.4	-23.39	32.39	6.85	0.00	V
	251	848.8	-23.22	32.54	7.17	0.01	V

WCDMA 850

Plane	Channel	Frequency (MHz)	LVL (dBm)	Correction Factor(dB)	ERP(dBm)	ERP(W)	Polarization (H/V)
Y	4132	826.4	-16.72	32.62	13.75	0.02	H
	4182	836.4	-16.08	32.52	14.29	0.03	H
	4233	846.6	-16.16	32.65	14.34	0.03	H
	4132	826.4	-26.03	32.76	4.58	0.00	V
	4182	836.4	-26.24	32.39	4.00	0.00	V
	4233	846.6	-26.35	32.54	4.04	0.00	V



A D T

Test Mode B

GSM 850

Plane	Channel	Frequency (MHz)	LVL (dBm)	Correction Factor(dB)	ERP(dBm)	ERP(W)	Polarization (H/V)
Y	128	824.2	-3.59	32.62	26.88	0.49	H
	189	836.4	-3.59	32.52	26.78	0.48	H
	251	848.8	-3.60	32.65	26.90	0.49	H
	128	824.2	-12.48	32.76	18.13	0.07	V
	189	836.4	-12.09	32.39	18.15	0.07	V
	251	848.8	-12.14	32.54	18.25	0.07	V

EDGE 850

Plane	Channel	Frequency (MHz)	LVL (dBm)	Correction Factor(dB)	ERP(dBm)	ERP(W)	Polarization (H/V)
Y	128	824.2	-14.05	32.62	16.42	0.04	H
	189	836.4	-13.70	32.52	16.67	0.05	H
	251	848.8	-13.83	32.65	16.67	0.05	H
	128	824.2	-23.08	32.76	7.53	0.01	V
	189	836.4	-21.82	32.39	8.42	0.01	V
	251	848.8	-22.31	32.54	8.08	0.01	V

WCDMA 850

Plane	Channel	Frequency (MHz)	LVL (dBm)	Correction Factor(dB)	ERP(dBm)	ERP(W)	Polarization (H/V)
Y	4132	826.4	-16.90	32.62	13.57	0.02	H
	4182	836.4	-16.09	32.52	14.28	0.03	H
	4233	846.6	-16.66	32.65	13.84	0.02	H
	4132	826.4	-25.69	32.76	4.92	0.00	V
	4182	836.4	-24.54	32.39	5.70	0.00	V
	4233	846.6	-24.48	32.54	5.91	0.00	V

4.2 FREQUENCY STABILITY MEASUREMENT

4.2.1 LIMITS OF FREQUENCY STABILITY MEASUREMENT

1.5 ppm is for base and fixed station. 2.5 ppm is for mobile station.

4.2.2 TEST PROCEDURE

- Device is placed at the oven room. The oven room could control the temperatures and humidity. Power warm up is at least 15 min and power applied should perform before recording frequency error.
- EUT is connected the external power supply to control the DC input power. The test voltage range is from minimum to maximum working voltage. Each step shall be record the frequency error rate.
- The temperature range step is 10 degrees in this test items. All temperature levels shall be hold the $\pm 0.5^{\circ}\text{C}$ during the measurement testing. The each temperature step shall be at least 0.5 hours, consider the EUT could be test under the stability condition.

NOTE: The frequency error was recorded frequency error from the communication simulator.

4.2.3 TEST SETUP

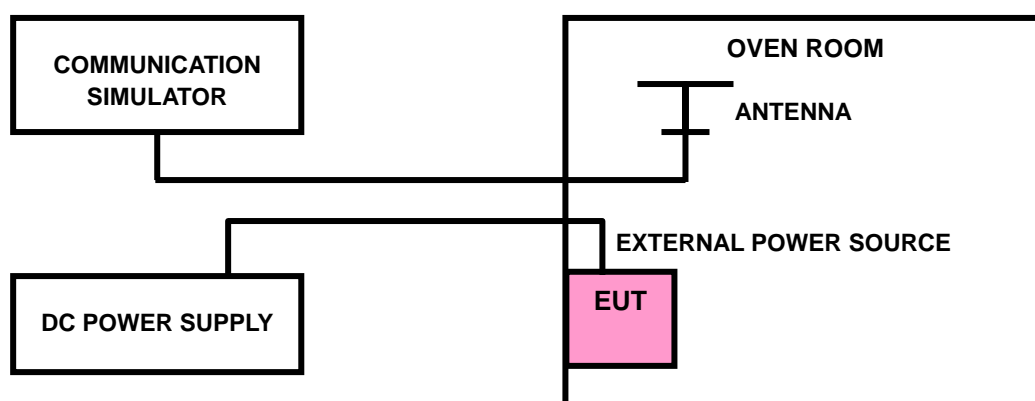



4.2.4 TEST RESULTS

FREQUENCY ERROR VS. VOLTAGE

VOLTAGE (Volts)	FREQUENCY ERROR (ppm)			LIMIT (ppm)
	GSM	EDGE	WCDMA	
3.8	-0.03	-0.01	-0.02	2.5
3.6	-0.03	-0.01	-0.02	2.5
4.2	-0.03	-0.01	-0.02	2.5

NOTE: The applicant defined the normal working voltage of the battery is from 3.6Vdc to 4.2Vdc.

FREQUENCY ERROR vs. TEMPERATURE.

TEMP. (°C)	FREQUENCY ERROR (ppm)			LIMIT (ppm)
	GSM	EDGE	WCDMA	
-10	-0.03	-0.02	-0.03	2.5
0	-0.03	-0.01	-0.02	2.5
10	-0.03	-0.01	-0.02	2.5
20	-0.03	-0.02	0.01	2.5
30	-0.03	-0.02	-0.03	2.5
40	-0.03	-0.02	-0.02	2.5
50	-0.03	-0.01	-0.02	2.5
55	-0.03	-0.01	-0.02	2.5

4.3 OCCUPIED BANDWIDTH MEASUREMENT

4.3.1 TEST PROCEDURES

The EUT makes a call to the communication simulator. All measurements were done at low, middle and high operational frequency range. The communication simulator station system controlled a EUT to export maximum output power under transmission mode and specific channel frequency. Use OBW measurement function of Spectrum analyzer to measure 99 % occupied bandwidth.

4.3.2 TEST SETUP

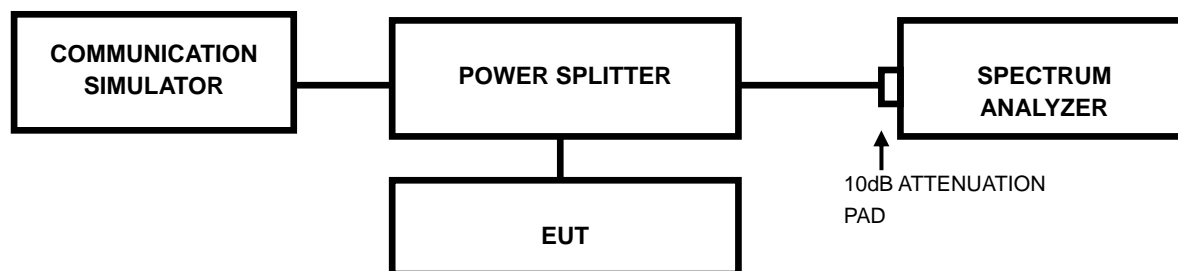



A D T

4.3.3 TEST RESULTS

CHANNEL	FREQUENCY (MHz)	99% OCCUPIED BANDWIDTH (kHz)		CHANNEL	FREQUENCY (MHz)	99% OCCUPIED BANDWIDTH (MHz)
		GSM	EDGE			WCDMA
128	824.2	245.16	246.50	4132	826.4	4.15
189	836.4	244.82	245.17	4182	836.4	4.14
251	848.8	246.44	247.01	4233	846.6	4.15

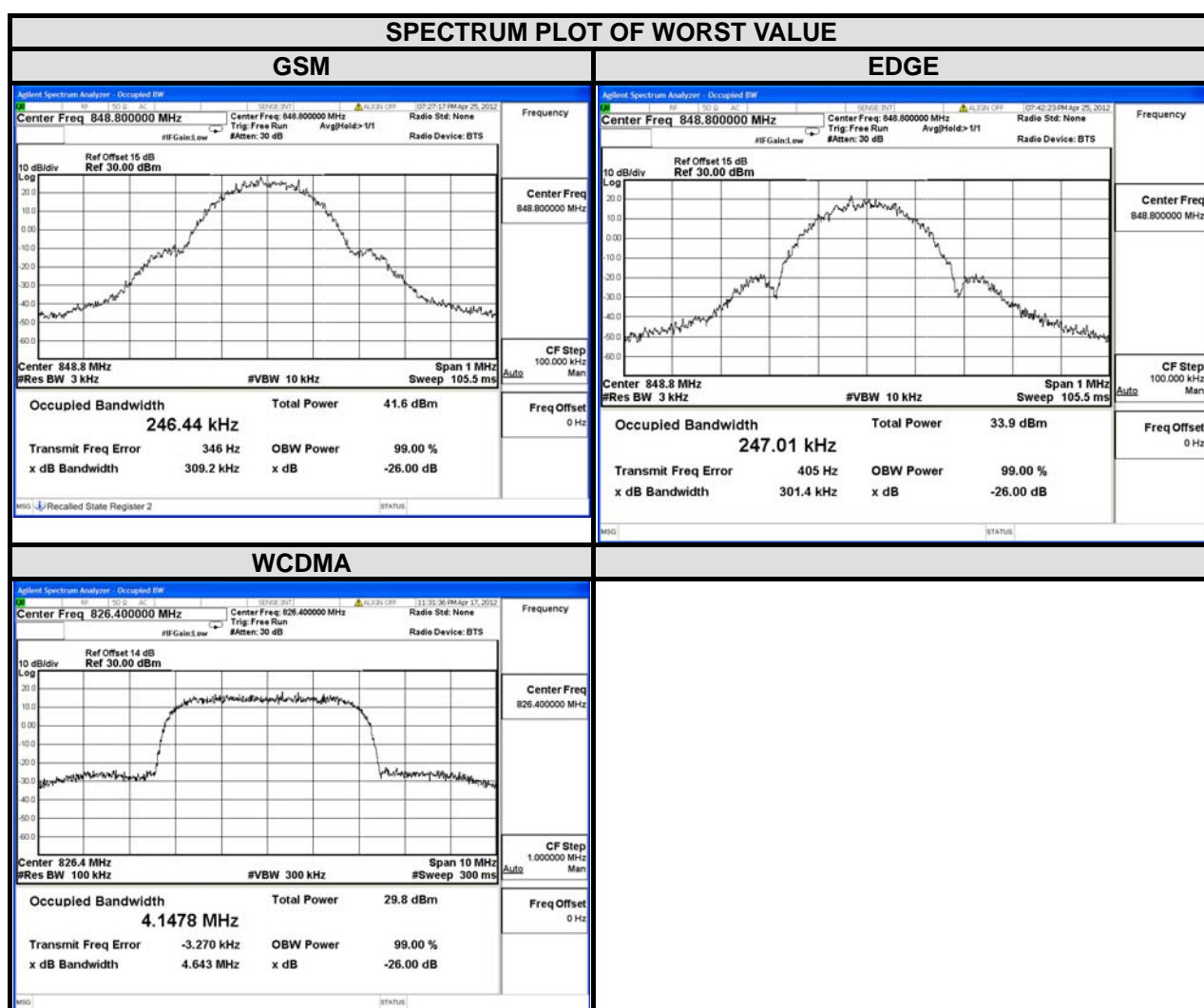

4.4 BAND EDGE MEASUREMENT

4.4.1 LIMITS OF BAND EDGE MEASUREMENT

Power of any emission outside of the authorized operating frequency ranges must be attenuated below the transmitting power (P) by a factor of at least $43 + 10 \log(P)$ dB. In the 1 MHz bands immediately outside and adjacent to the frequency block a resolution bandwidth of at least one percent of the emission bandwidth of the fundamental emission of the transmitter may be employed.

4.4.2 TEST SETUP

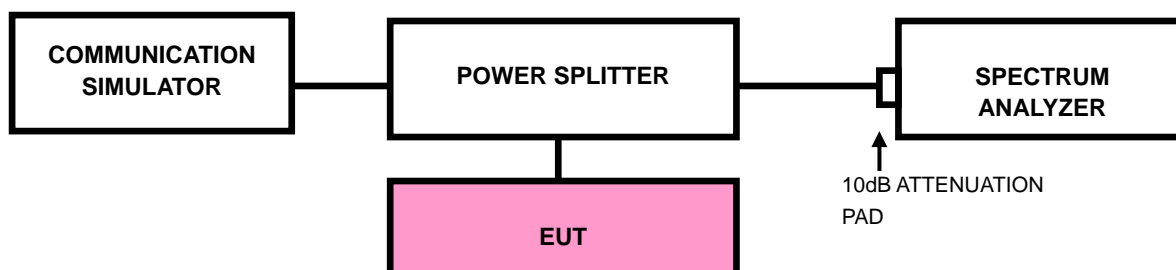

4.4.3 TEST PROCEDURES

- All measurements were done at low and high operational frequency range.
- The center frequency of spectrum is the band edge frequency and span is 1.5 MHz. RB of the spectrum is 3kHz and VB of the spectrum is 3kHz (GSM / EDGE).
- The center frequency of spectrum is the band edge frequency and span is 10MHz. RB of the spectrum is 100kHz and VB of the spectrum is 300kHz (WCDMA).
- Record the max trace plot into the test report.



A D T

4.4.4 TEST RESULTS

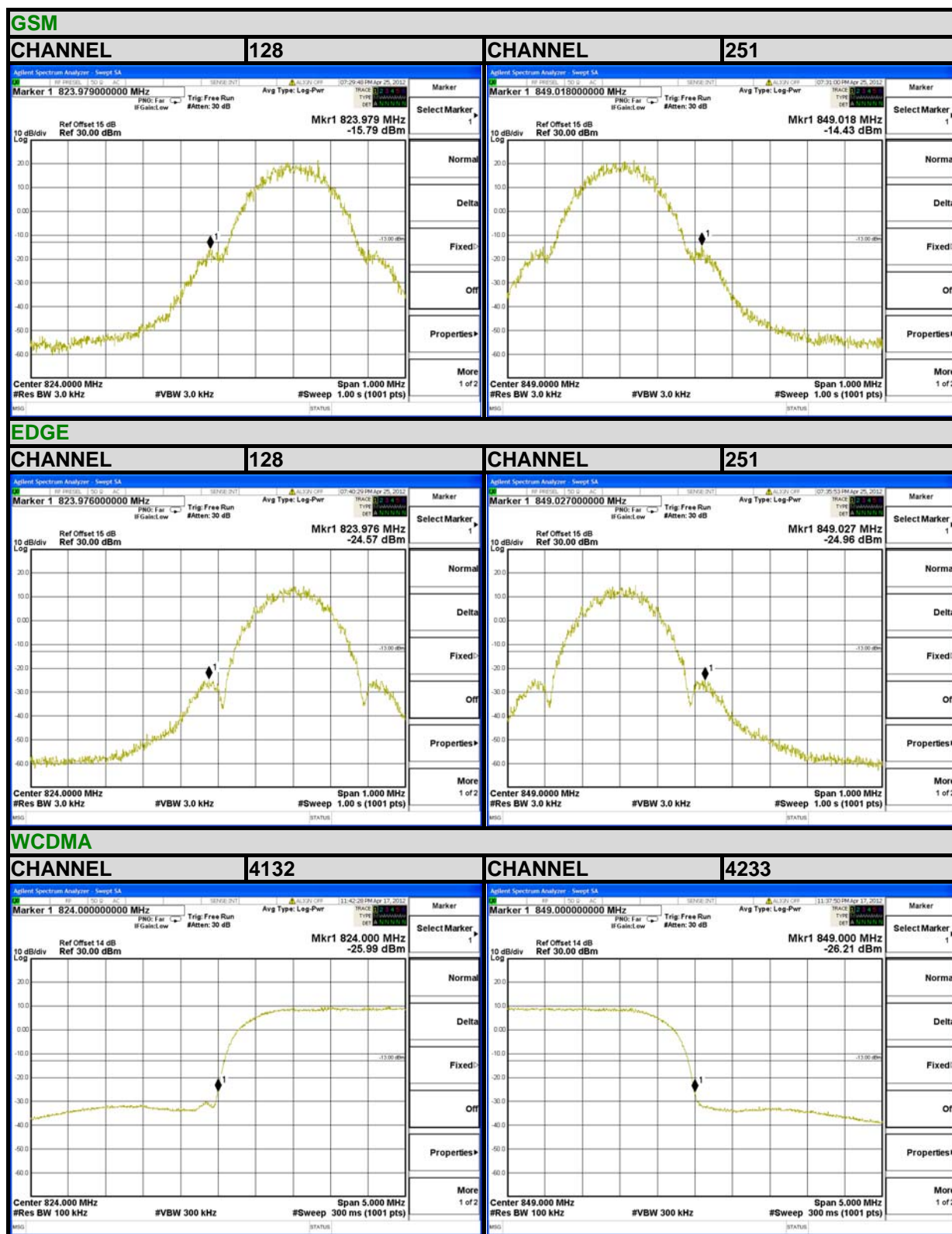

4.5 CONDUCTED SPURIOUS EMISSIONS

4.5.1 LIMITS OF CONDUCTED SPURIOUS EMISSIONS MEASUREMENT

The power of any emission outside of the authorized operating frequency ranges must be attenuated below the transmitting power (P) by a factor of at least $43 + 10 \log(P)$ dB. The emission limit equal to -13dBm .

4.5.2 TEST PROCEDURE

- a. The EUT makes a phone call to the communication simulator. All measurements were done at low, middle and high operational frequency range.
- b. Measuring frequency range is from 30MHz to 9GHz. 10dB attenuation pad is connected with spectrum. RBW=1MHz and VBW=3MHz is used for conducted emission measurement.

4.5.3 TEST SETUP

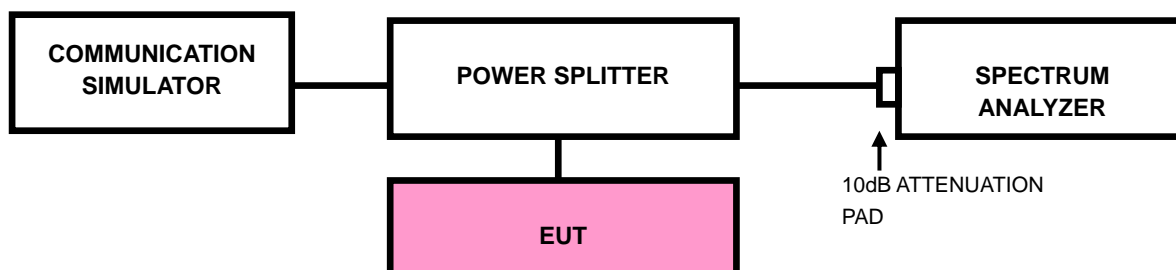



A D T

4.5.4 TEST RESULTS

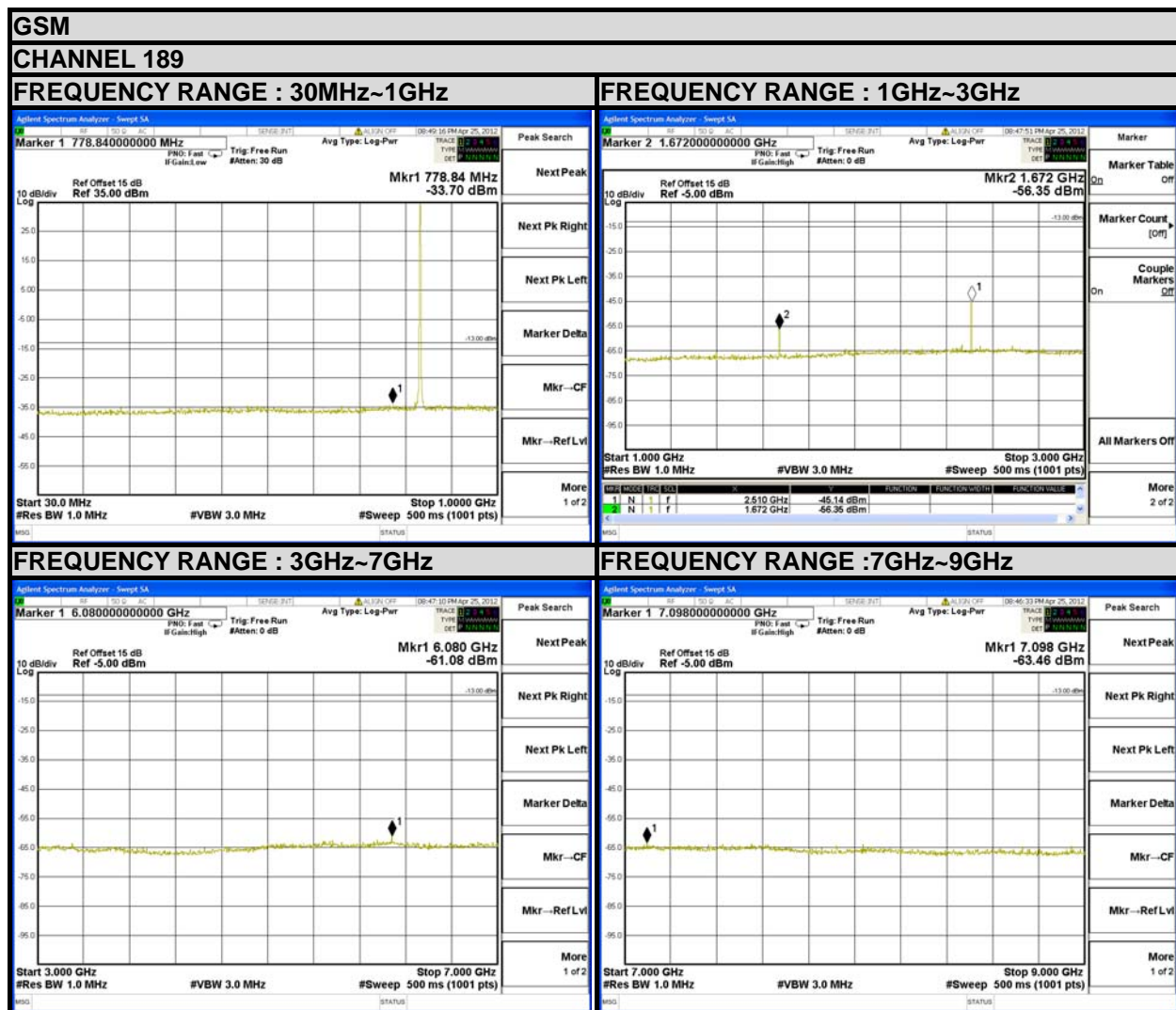



A D T

EDGE

CHANNEL 189

FREQUENCY RANGE : 30MHz~1GHz

FREQUENCY RANGE : 1GHz~3GHz

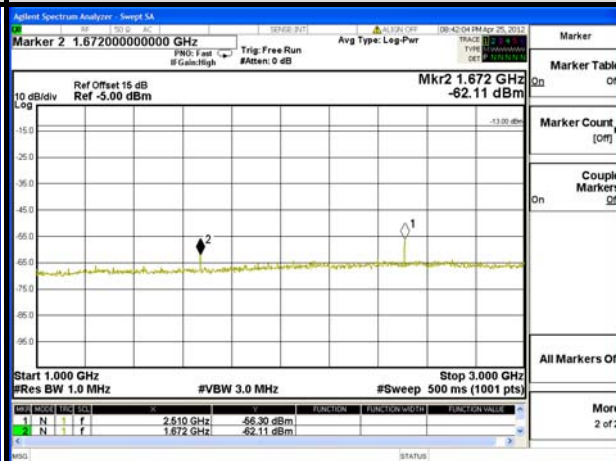

FREQUENCY RANGE : 3GHz~7GHz

FREQUENCY RANGE : 7GHz~9GHz

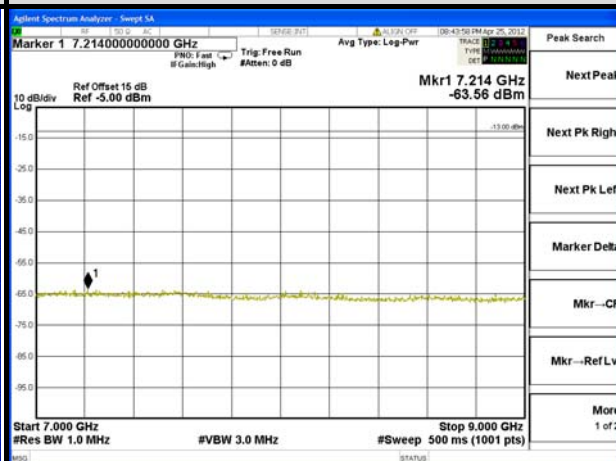
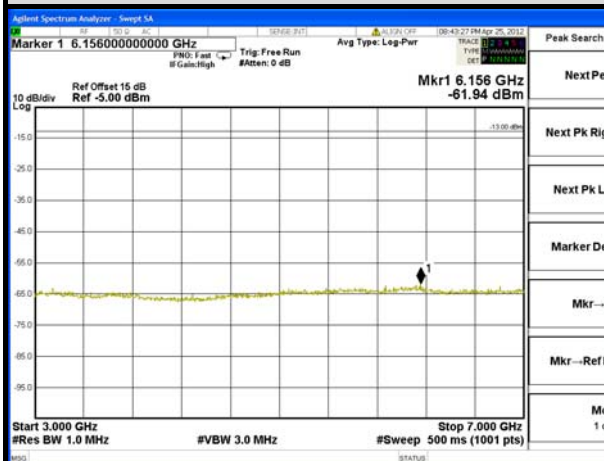



A D T

WCDMA

CHANNEL 4182

FREQUENCY RANGE : 30MHz~1GHz

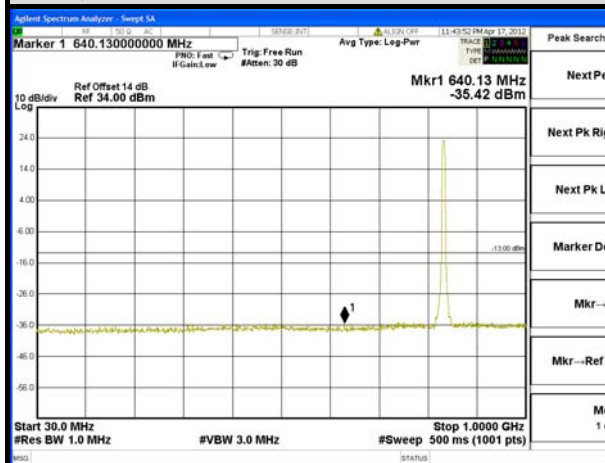

FREQUENCY RANGE : 1GHz~3GHz

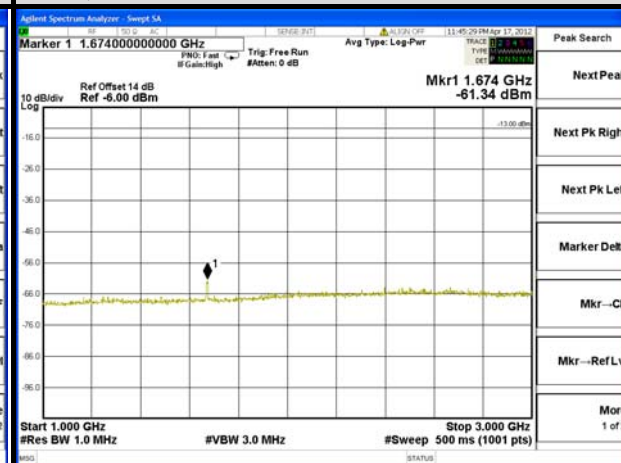

FREQUENCY RANGE : 3GHz~7GHz

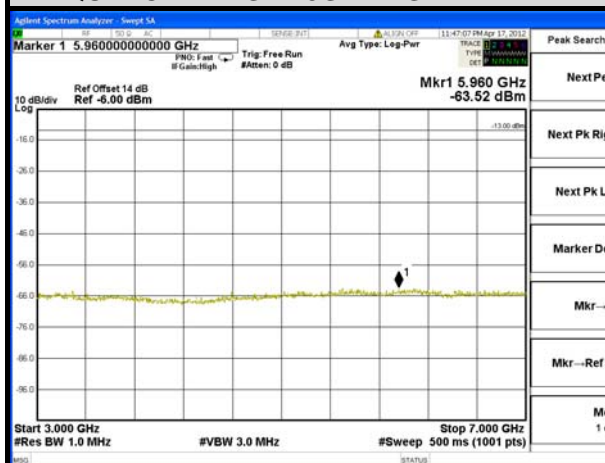

FREQUENCY RANGE : 7GHz~9GHz

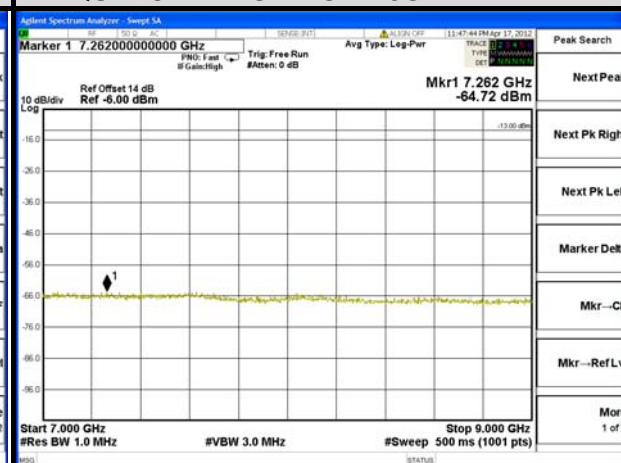

4.6 RADIATED EMISSION MEASUREMENT

4.6.1 LIMITS OF RADIATED EMISSION MEASUREMENT

The power of any emission outside of the authorized operating frequency ranges must be attenuated below the transmitting power (P) by a factor of at least $43 + 10 \log(P)$ dB. The emission limit equal to -13dBm .

4.6.2 TEST PROCEDURES

- a. Substitution method is used for E.I.R.P measurement. In the semi-anechoic chamber, EUT placed on the 0.8m height of Turn Table, rotated the table around 360 degrees to search the maximum radiation power and receiver antenna shall be rotated vertical and horizontal polarization and moved height from 1m to 4m to find the maximum polar radiated power. The “Read Value” is the spectrum reading the maximum power value.
- b. The substitution horn antenna is substituted for EUT at the same position and signals generator export the CW signal to the substitution antenna via a TX cable. Rotated the Turn Table and moved receiving antenna to find the maximum radiation power. Adjust output power level of S.G to get a Value of spectrum reading equal to “Read Value” of step a. Record the power level of S.G
- c. $\text{EIRP} = \text{Output power level of S.G} - \text{TX cable loss} + \text{Antenna gain of substitution horn}$.
- d. E.R.P power can be calculated form E.I.R.P power by subtracting the gain of dipole,
 $\text{E.R.P power} = \text{E.I.P.R power} - 2.15\text{dBi}$.

NOTE: The resolution bandwidth and video bandwidth of test receiver/spectrum analyzer is 1MHz/3MHz.

4.6.3 DEVIATION FROM TEST STANDARD

No deviation

4.6.4 TEST SETUP

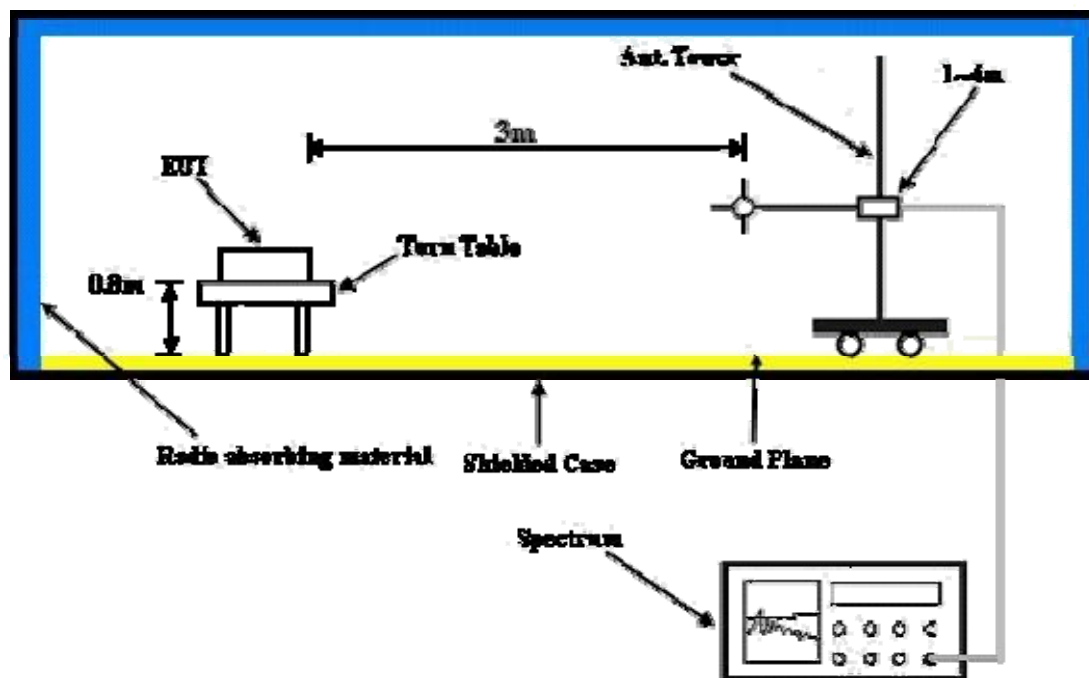

For the actual test configuration, please refer to the attached file (Test Setup Photo).



A D T

4.6.5 TEST RESULTS

Test Mode A



Bureau Veritas Consumer Products Services Ltd., Taoyuan Branch

A D T

Data: 9

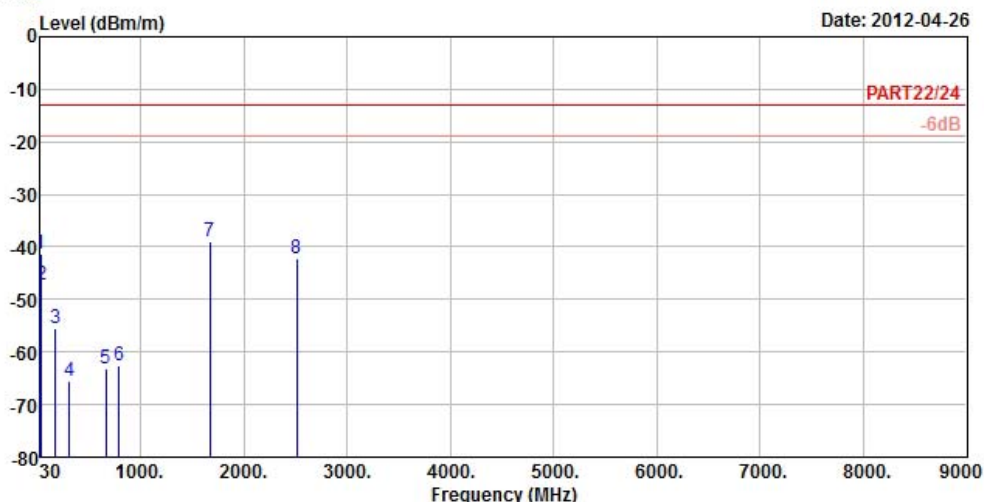

Site : 966 Chamber 5
 Condition : PART22/24 3m EIRP_RSE_1G~19G_3 HORIZONTAL
 Brand/Model: PJ40200
 Remark : GSM850 Link
 Tested by : Kay Wu
 Temperature : 25°C
 Humidity : 65%
 Plane : Y

	Read	Limit	Over			
Level	Level	Line	Limit	Factor	Remark	
dBm	dBm	dBm/m	dB	dB/m		
1	30.00	-41.38	-42.45	-13.00	-28.38	1.07 Peak
2	43.50	-47.11	-45.85	-13.00	-34.11	-1.26 Peak
3	174.18	-55.43	-48.64	-13.00	-42.43	-6.79 Peak
4	311.20	-65.40	-59.11	-13.00	-52.40	-6.29 Peak
5	664.00	-63.04	-63.84	-13.00	-50.04	0.80 Peak
6	787.90	-62.45	-64.49	-13.00	-49.45	2.04 Peak
7 pp	1672.80	-38.87	-26.05	-13.00	-25.87	-12.82 Peak
8	2509.20	-42.30	-33.13	-13.00	-29.30	-9.17 Peak



A D T



Bureau Veritas Consumer Products Services Ltd., Taoyuan Branch

A D T

Data: 10

Date: 2012-04-26

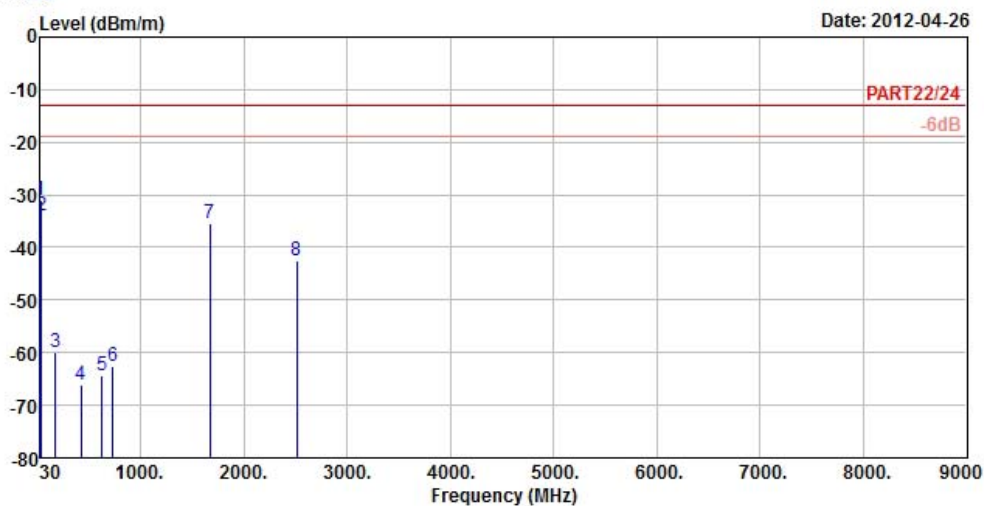

Site : 966 Chamber 5
 Condition : PART22/24 3m EIRP_RSE_1G~19G_3 VERTICAL
 Brand/Model: PJ40200
 Remark : GSM850 Link
 Tested by : Kay Wu
 Temperature : 25°C
 Humidity : 65%
 Plane : Y

	Read	Limit	Over				
1	2	3	4	5	6	7	
pp	Freq	Level	Level	Line	Limit	Factor	Remark
	MHz	dBm/m	dBm	dBm/m	dB	dB/m	
1	30.00	-31.06	-32.13	-13.00	-18.06	1.07	Peak
2	42.42	-33.85	-32.52	-13.00	-20.85	-1.33	Peak
3	175.26	-59.99	-53.39	-13.00	-46.99	-6.60	Peak
4	419.70	-66.21	-61.08	-13.00	-53.21	-5.13	Peak
5	623.40	-64.37	-64.44	-13.00	-51.37	0.07	Peak
6	729.80	-62.68	-64.33	-13.00	-49.68	1.65	Peak
7	1672.80	-35.40	-22.58	-13.00	-22.40	-12.82	Peak
8	2509.20	-42.58	-33.41	-13.00	-29.58	-9.17	Peak



A D T



Bureau Veritas Consumer Products Services Ltd., Taoyuan Branch

A D T

Data: 9

Date: 2012-04-26

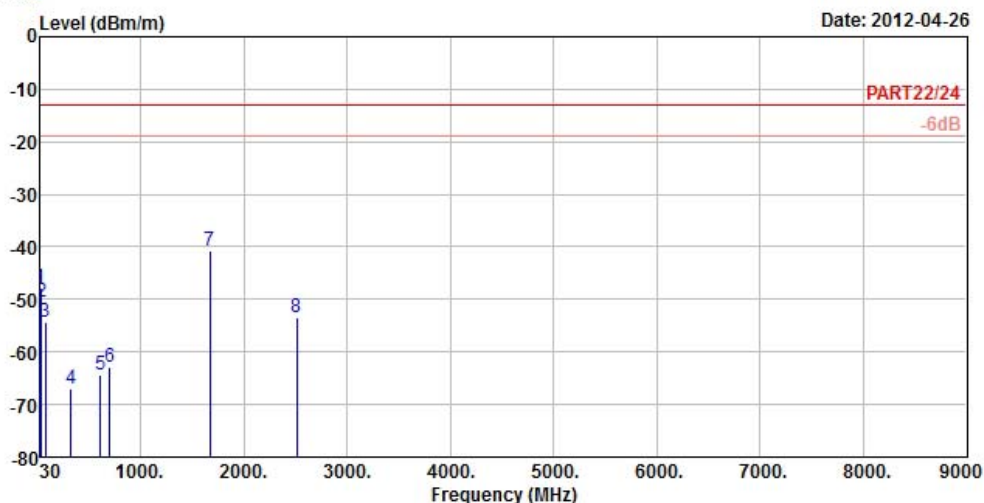

Site : 966 Chamber 5
 Condition : PART22/24 3m EIRP_RSE_1G~19G_3 HORIZONTAL
 Brand/Model: PJ40200
 Remark : EDGE Link
 Tested by : Kay Wu
 Temperature : 25°C
 Humidity : 65%
 Plane : Y

	Read	Limit	Over			
Level	Level	Line	Limit	Factor	Remark	
dBm/m	dBm	dBm/m	dB	dB/m		
1	30.27	-47.77	-48.84	-13.00	-34.77	1.07 Peak
2	43.50	-50.53	-49.27	-13.00	-37.53	-1.26 Peak
3	81.03	-54.25	-43.95	-13.00	-41.25	-10.30 Peak
4	325.90	-67.09	-60.90	-13.00	-54.09	-6.19 Peak
5	610.10	-64.39	-64.21	-13.00	-51.39	-0.18 Peak
6	699.70	-62.78	-64.21	-13.00	-49.78	1.43 Peak
7 pp	1672.80	-40.73	-27.91	-13.00	-27.73	-12.82 Peak
8	2509.20	-53.46	-44.29	-13.00	-40.46	-9.17 Peak



A D T



Bureau Veritas Consumer Products Services Ltd., Taoyuan Branch

A D T

Data: 10

Date: 2012-04-26

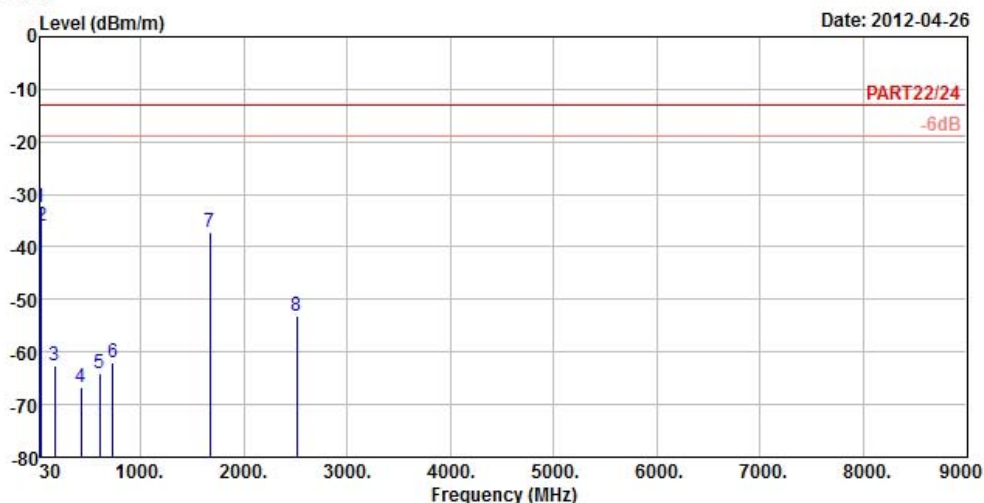

Site : 966 Chamber 5
 Condition : PART22/24 3m EIRP_RSE_1G~19G_3 VERTICAL
 Brand/Model: PJ40200
 Remark : EDGE Link
 Tested by : Kay Wu
 Temperature : 25°C
 Humidity : 65%
 Plane : Y

	Read	Limit	Over			
1	2	3	4	5	6	7
Freq	Level	Level	Line	Limit	Factor	Remark
MHz	dBm/m	dBm	dBm/m	dB	dB/m	
1 pp	31.08 -32.44	-32.78	-13.00	-19.44	0.34	Peak
2	42.42 -35.94	-34.61	-13.00	-22.94	-1.33	Peak
3	167.70 -62.52	-55.86	-13.00	-49.52	-6.66	Peak
4	421.10 -66.69	-61.59	-13.00	-53.69	-5.10	Peak
5	603.80 -63.93	-63.65	-13.00	-50.93	-0.28	Peak
6	727.70 -62.05	-63.68	-13.00	-49.05	1.63	Peak
7	1672.80 -37.22	-24.40	-13.00	-24.22	-12.82	Peak
8	2509.20 -53.25	-44.08	-13.00	-40.25	-9.17	Peak



A D T



Bureau Veritas Consumer Products Services Ltd., Taoyuan Branch

A D T

Data: 9

Date: 2012-04-18

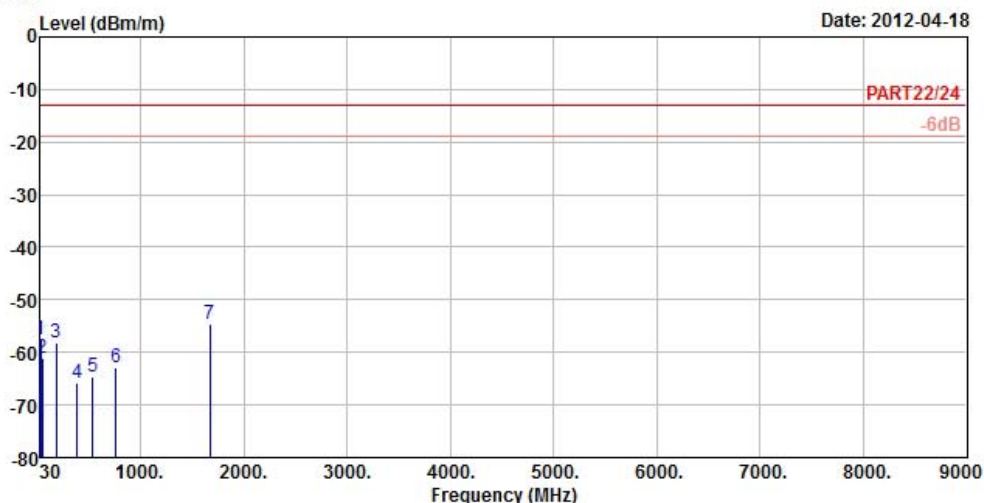

Site : 966 Chamber 5
 Condition : PART22/24 3m EIRP_RSE_1G~19G_3 HORIZONTAL
 Brand/Model: PJ40200
 Remark : Band V Link
 Tested by : Kay Wu
 Temperature : 25°C
 Humidity : 65%
 Plane : Y
 Sample No : C120413-003-003-001

	Freq	Level	Read Level	Limit Line	Over Limit	Factor	Remark
	MHz	dBm/m	dBm	dBm/m	dB	dB/m	
1	30.00	-57.43	-58.50	-13.00	-44.43	1.07	Peak
2	44.31	-61.09	-59.90	-13.00	-48.09	-1.19	Peak
3	180.93	-58.30	-52.52	-13.00	-45.30	-5.78	Peak
4	382.60	-65.72	-59.96	-13.00	-52.72	-5.76	Peak
5	538.00	-64.54	-62.49	-13.00	-51.54	-2.05	Peak
6	758.50	-62.74	-64.59	-13.00	-49.74	1.85	Peak
7 pp	1672.80	-54.72	-41.90	-13.00	-41.72	-12.82	Peak



A D T



Bureau Veritas Consumer Products Services Ltd., Taoyuan Branch

A D T

Data: 10

Date: 2012-04-18

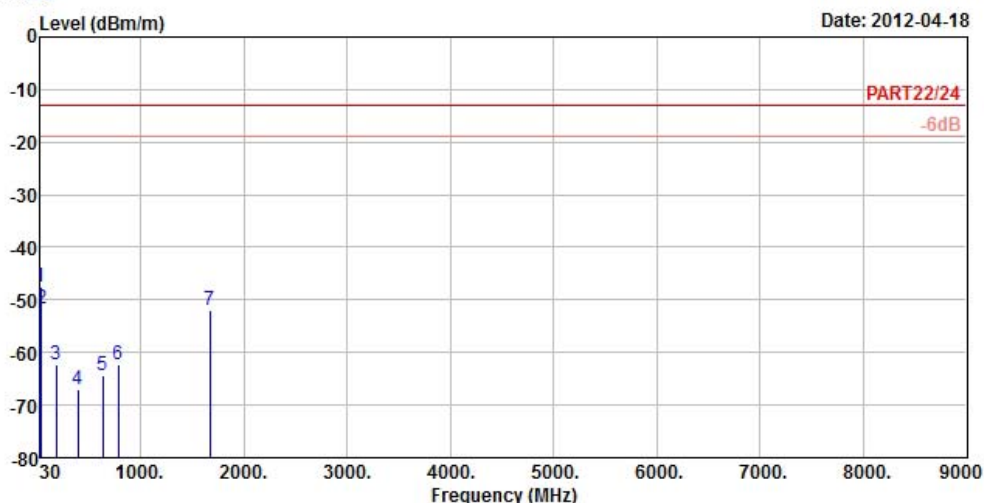

Site : 966 Chamber 5
 Condition : PART22/24 3m EIRP_RSE_1G~19G_3 VERTICAL
 Brand/Model: PJ40200
 Remark : Band V Link
 Tested by : Kay Wu
 Temperature : 25°C
 Humidity : 65%
 Plane : Y
 Sample No : C120413-003-003-001

	Freq	Level	Read Level	Limit Line	Over Limit	Factor	Remark
	MHz	dBm/m	dBm	dBm/m	dB	dB/m	
1	pp	31.62	-47.60	-47.21	-13.00	-34.60	-0.39 Peak
2		41.61	-51.54	-50.15	-13.00	-38.54	-1.39 Peak
3		180.66	-62.17	-56.50	-13.00	-49.17	-5.67 Peak
4		395.20	-67.15	-61.47	-13.00	-54.15	-5.68 Peak
5		635.30	-64.41	-64.69	-13.00	-51.41	0.28 Peak
6		783.70	-62.43	-64.45	-13.00	-49.43	2.02 Peak
7		1672.80	-51.83	-39.01	-13.00	-38.83	-12.82 Peak



A D T

Test Mode B



Bureau Veritas Consumer Products Services Ltd., Taoyuan Branch

A D T

Data: 9

Date: 2012-04-26

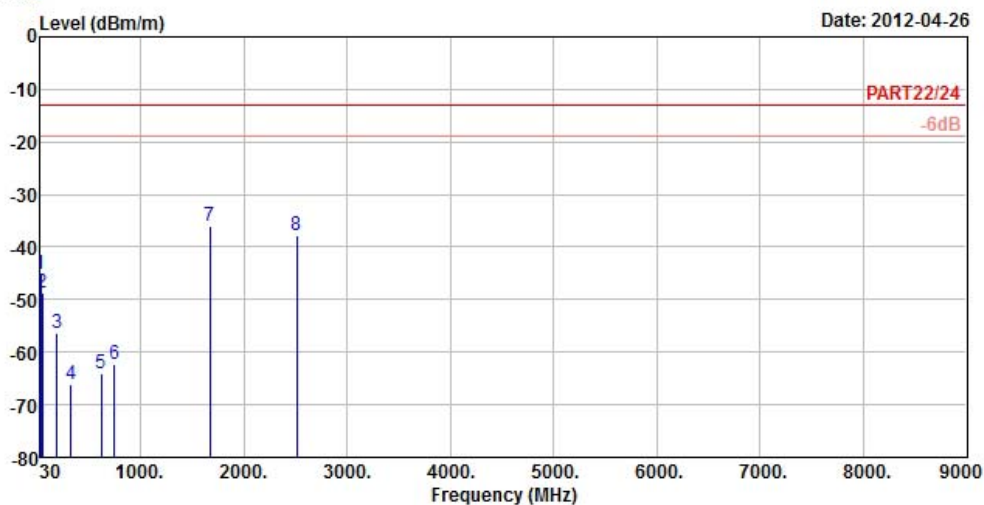

Site : 966 Chamber 5
 Condition : PART22/24 3m EIRP_RSE_1G~19G_3 HORIZONTAL
 Brand/Model: PJ40200
 Remark : GSM850 Link
 Tested by : Kay Wu
 Temperature : 25°C
 Humidity : 65%
 Plane : X

	Read	Limit	Over			
Level	Level	Line	Limit	Factor	Remark	
Freq	Level	Level	Line	Factor	Remark	
MHz	dBm/m	dBm	dBm/m	dB	dB/m	
1	30.00 -45.30	-46.37	-13.00	-32.30	1.07	Peak
2	43.77 -48.64	-47.38	-13.00	-35.64	-1.26	Peak
3	189.03 -56.34	-49.64	-13.00	-43.34	-6.70	Peak
4	325.90 -66.06	-59.87	-13.00	-53.06	-6.19	Peak
5	619.90 -64.00	-64.00	-13.00	-51.00	0.00	Peak
6	749.40 -62.27	-64.06	-13.00	-49.27	1.79	Peak
7 pp	1672.80 -35.91	-23.09	-13.00	-22.91	-12.82	Peak
8	2509.20 -37.79	-28.62	-13.00	-24.79	-9.17	Peak



A D T



Bureau Veritas Consumer Products Services Ltd., Taoyuan Branch

A D T

Data: 10

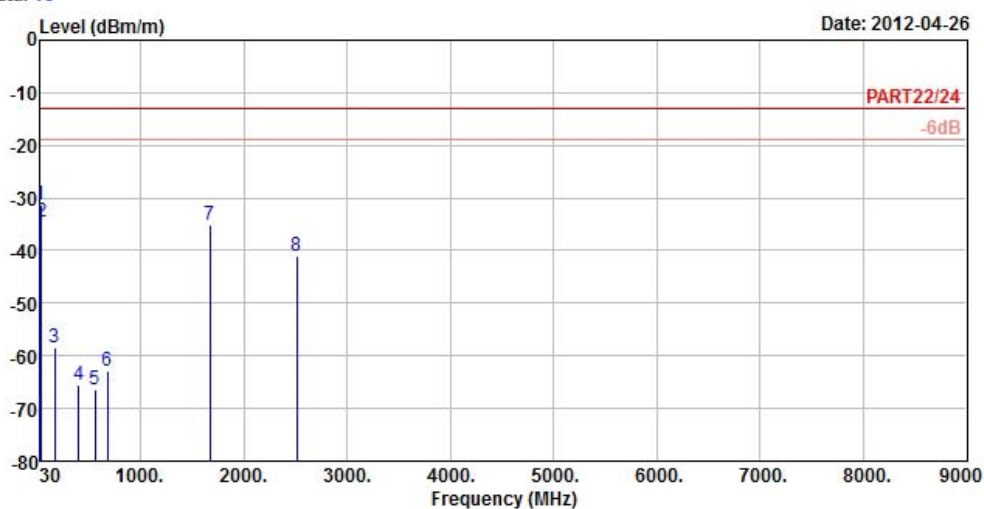

Date: 2012-04-26

Site : 966 Chamber 5
 Condition : PART22/24 3m EIRP_RSE_1G~19G_3 VERTICAL
 Brand/Model: PJ40200
 Remark : GSM850 Link
 Tested by : Kay Wu
 Temperature : 25°C
 Humidity : 65%
 Plane : X

	Read	Limit	Over			
Freq	Level	Level	Line	Limit	Factor	Remark
MHz	dBm/m	dBm	dBm/m	dB	dB/m	
1 pp	30.00	-31.19	-32.26	-13.00	-18.19	1.07 Peak
2	42.69	-34.63	-33.30	-13.00	-21.63	-1.33 Peak
3	166.35	-58.60	-51.96	-13.00	-45.60	-6.64 Peak
4	400.10	-65.58	-59.96	-13.00	-52.58	-5.62 Peak
5	554.80	-66.53	-64.93	-13.00	-53.53	-1.60 Peak
6	681.50	-62.78	-63.90	-13.00	-49.78	1.12 Peak
7	1672.80	-35.26	-22.44	-13.00	-22.26	-12.82 Peak
8	2509.20	-41.09	-31.92	-13.00	-28.09	-9.17 Peak

5 PHOTOGRAPHS OF THE TEST CONFIGURATION

Please refer to the attached file (Test Setup Photo).



A D T

6 INFORMATION ON THE TESTING LABORATORIES

We, Bureau Veritas Consumer Products Services (H.K.) Ltd., Taoyuan Branch, were founded in 1988 to provide our best service in EMC, Radio, Telecom and Safety consultation. Our laboratories are accredited and approved according to ISO/IEC 17025.

Copies of accreditation and authorization certificates of our laboratories obtained from approval agencies can be downloaded from our web site:

www.adt.com.tw/index.5.phtml. If you have any comments, please feel free to contact us at the following:

Linko EMC/RF Lab:

Tel: 886-2-26052180

Fax: 886-2-26051924

Hsin Chu EMC/RF Lab:

Tel: 886-3-5935343

Fax: 886-3-5935342

Hwa Ya EMC/RF/Safety/Telecom Lab:

Tel: 886-3-3183232

Fax: 886-3-3270892

Email: service.adt@tw.bureauveritas.com

Web Site: www.adt.com.tw

The address and road map of all our labs can be found in our web site also.



A D T

7 APPENDIX A – MODIFICATIONS RECORDERS FOR ENGINEERING CHANGES TO THE EUT BY THE LAB

No any modifications are made to the EUT by the lab during the test.

---END---