

Your **HTC** Explorer

User guide

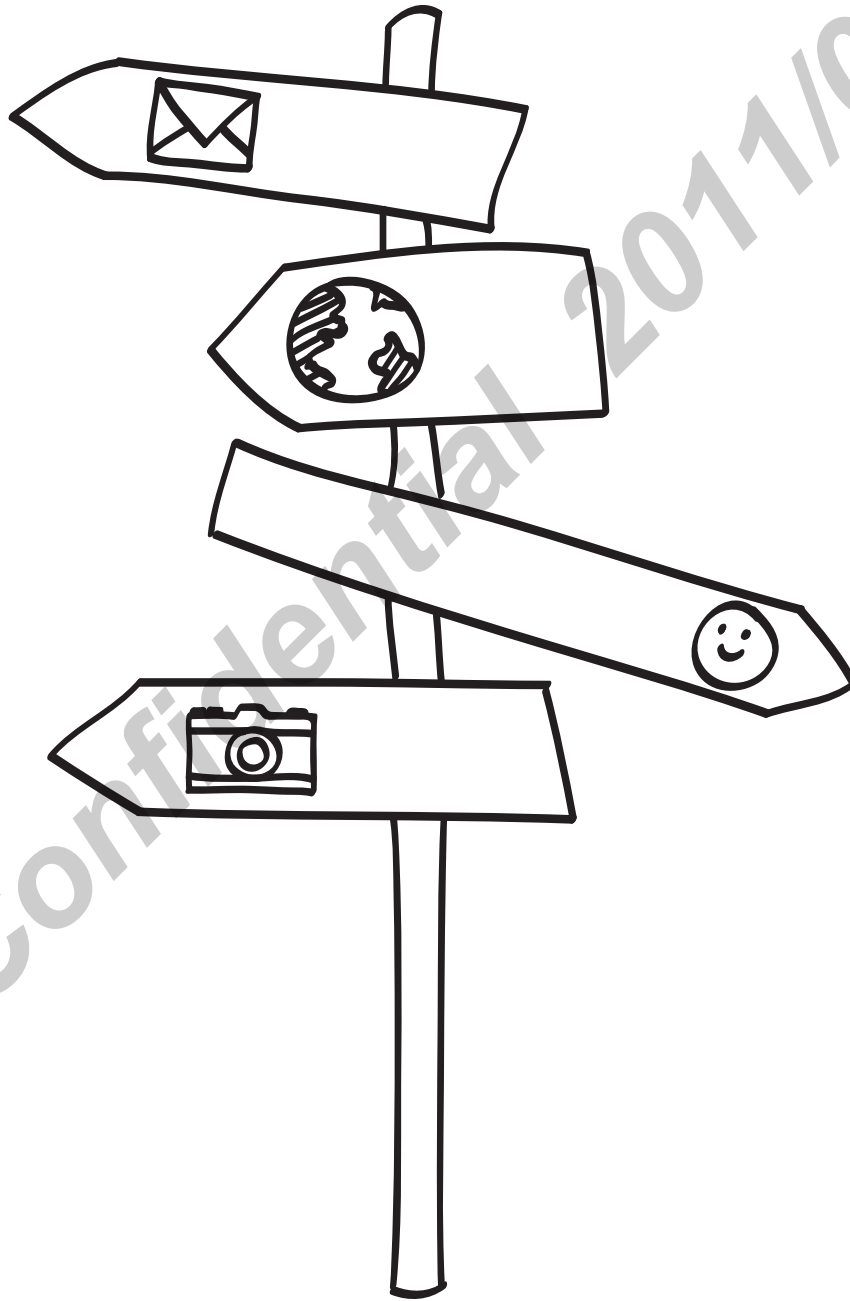

Contents

Getting started

| | |
|--|----|
| Inside the box | 8 |
| HTC Explorer | 8 |
| Back cover | 10 |
| SIM card | 11 |
| Storage card | 12 |
| Battery | 13 |
| Switching the power on or off | 14 |
| Entering your PIN | 15 |
| Finger gestures | 15 |
| Setting up HTC Explorer for the first time | 16 |
| Ways of getting contacts into HTC Explorer | 16 |
| Home screen | 17 |

Basics

| | |
|---|----|
| Adjusting the volume | 19 |
| Sleep mode | 20 |
| Status and notifications | 21 |
| Notifications panel | 23 |
| Connecting HTC Explorer to a computer | 25 |
| Copying files to or from the storage card | 25 |
| Copying text, looking up information, and sharing | 26 |

Personalizing

| | |
|---|----|
| Making HTC Explorer truly yours | 28 |
| Personalizing HTC Explorer with scenes | 28 |
| Changing your wallpaper | 29 |
| Applying a new skin | 30 |
| Personalizing your Home screen with widgets | 30 |
| Adding icons and other shortcuts on your Home screen | 31 |
| Adding folders on your Home screen | 32 |
| Rearranging or removing widgets and icons on your Home screen | 32 |
| Rearranging the Home screen | 33 |
| Customizing the shortcuts on the lock screen | 33 |
| Using sound sets | 34 |
| Rearranging or hiding application tabs | 35 |
| Shortcuts & Clock widget | 36 |

Phone calls

| | |
|--|----|
| Different ways of making calls | 38 |
| Making a call on the Phone dialer screen | 38 |
| Using Speed dial | 39 |

| | |
|--|----|
| Calling a phone number in a text message | 40 |
| Calling a phone number in an email | 40 |
| Calling a phone number in a Calendar event | 40 |
| Making an emergency call | 40 |
| Receiving calls | 41 |
| What can I do during a call? | 42 |
| Setting up a conference call | 43 |
| Internet calls | 44 |
| Using Call history | 45 |
| Using Home dialing | 46 |
| Call services | 47 |
| Turning Airplane mode on or off | 48 |

Search and Web browser

| | |
|--|----|
| Searching HTC Explorer and the Web | 49 |
| Using the web browser | 50 |
| Downloading from the Web | 52 |
| Viewing bookmarks and previously visited pages | 53 |
| Setting browser options | 54 |

Accounts and sync

| | |
|-------------------------------------|----|
| About online accounts | 56 |
| Synchronizing with a Google Account | 56 |
| Adding a social network account | 57 |
| Managing your online accounts | 57 |

People

| | |
|---|----|
| Transferring contacts from your old phone | 59 |
| About the People app | 60 |
| Your contacts list | 61 |
| Setting up your profile | 62 |
| Importing contacts from your SIM card | 62 |
| Adding a new contact | 63 |
| Searching for contacts | 63 |
| Importing a contact from an Exchange ActiveSync account | 64 |
| Merging contact information | 65 |
| Backing up your contacts to the storage card | 66 |
| Contact information and conversations | 66 |
| Sending contact information as a vCard | 68 |
| Contact groups | 69 |
| Adding People widgets | 71 |

Social

| | |
|------------------------------------|----|
| Facebook for HTC Sense | 73 |
| Enjoying Facebook in Friend Stream | 74 |
| Chatting in Google Talk | 75 |

Camera

| | |
|-----------------|----|
| Camera basics | 78 |
| Taking a photo | 79 |
| Recording video | 80 |

| | |
|--------------------------|----|
| Adding effects | 80 |
| After capturing | 80 |
| Changing camera settings | 81 |

Photos, videos, and music

| | |
|---------|----|
| Gallery | 82 |
| Music | 89 |

Android Market and other apps

| | |
|---|-----|
| Finding and installing apps from Android Market | 93 |
| Using the Clock | 95 |
| Checking Weather | 98 |
| Watching videos on YouTube | 99 |
| Listening to FM Radio | 100 |
| Recording your voice | 101 |
| Sharing games and apps | 102 |

Messages

| | |
|--|-----|
| Opening Messages | 103 |
| Sending a text message (SMS) | 103 |
| Sending a multimedia message (MMS) | 104 |
| Resuming a draft message | 106 |
| Viewing and replying to a message | 106 |
| Forwarding a message | 107 |
| Viewing and saving an attachment from a multimedia message | 108 |
| Push messages | 108 |
| Managing message conversations | 109 |
| Backing up your text messages to the storage card | 110 |
| Setting message options | 111 |

Email

| | |
|-------|-----|
| Gmail | 112 |
| Mail | 113 |

Calendar

| | |
|---|-----|
| About Calendar | 122 |
| Creating an event | 122 |
| Changing Calendar views | 123 |
| Managing Calendar events | 124 |
| Accepting or declining a meeting invitation | 125 |
| Dismissing or snoozing event reminders | 126 |
| Showing or hiding calendars | 126 |
| Changing Calendar settings | 126 |
| About the Calendar widget | 127 |

Maps and location

| | |
|-------------------|-----|
| Location settings | 128 |
| Google Maps | 128 |

HTC Sync

| | |
|--|-----|
| About HTC Sync | 133 |
| Installing HTC Sync | 133 |
| Setting up HTC Sync to recognize HTC Explorer | 134 |
| Getting to know the workspace | 134 |
| Setting up synchronization | 135 |
| Synchronizing HTC Explorer | 138 |
| Installing an app from your computer to HTC Explorer | 138 |
| Synchronizing another device with your computer | 139 |
| Downloading the latest HTC Sync upgrade | 139 |

HTCSense.com

| | |
|--|-----|
| Signing up for your HTCSense.com account | 140 |
| Turning on Device finder | 140 |
| Using HTCSense.com | 141 |
| Deleting your HTCSense.com account | 142 |

Keyboard

| | |
|-------------------------------------|-----|
| Using the onscreen keyboard | 143 |
| Entering words with predictive text | 144 |
| Entering text by speaking | 146 |
| Entering text by tracing | 147 |
| Editing text | 147 |
| Adjusting input settings | 148 |

Internet connections

| | |
|--|-----|
| Data connection | 150 |
| Wi-Fi | 151 |
| Connecting to a virtual private network (VPN) | 152 |
| Using HTC Explorer as a modem (USB tethering) | 154 |
| Connecting HTC Explorer to the Internet through a computer (Internet Pass-through) | 154 |

Bluetooth

| | |
|--|-----|
| Bluetooth basics | 155 |
| Connecting a Bluetooth headset or car kit | 155 |
| Disconnecting or unpairing from a Bluetooth device | 156 |
| Sending information using Bluetooth | 157 |
| Receiving information using Bluetooth | 158 |

Security

| | |
|--|-----|
| Protecting your SIM card with a PIN | 160 |
| Protecting HTC Explorer with a screen lock pattern, PIN, or password | 160 |
| Encrypting data on HTC Explorer | 162 |

Settings

| | |
|---------------------------|-----|
| Settings on HTC Explorer | 163 |
| Changing display settings | 165 |
| Changing sound settings | 166 |
| Changing the language | 167 |

| | |
|---|-----|
| Optimizing battery life | 168 |
| Managing memory | 169 |
| Checking information about HTC Explorer | 171 |

Update and reset

| | |
|-------------------------|-----|
| Software updates | 172 |
| Restarting HTC Explorer | 173 |
| Resetting HTC Explorer | 173 |

Trademarks and copyrights

Index

HTC Confidential 2011/09/16

Conventions used in this guide

In this user guide, we use the following symbols to indicate useful and important information:



This is a note. A note often gives additional information, such as what happens when you choose to do or not to do a certain action. A note also provides information that may only be applicable to some situations.



This is a tip. A tip gives you an alternative way to do a particular step or procedure, or lets you know of an option that you may find helpful.



This indicates important information that you need in order to accomplish a certain task or to get a feature to work properly.



This provides safety precaution information, that is, information that you need to be careful about to prevent potential problems.

HTC Confidential 2017/09/16

Getting started

Inside the box





You will find the following inside the box:

- HTC Explorer
- Battery
- USB cable
- Power adapter
- Quick start guide
- Safety and regulatory guide

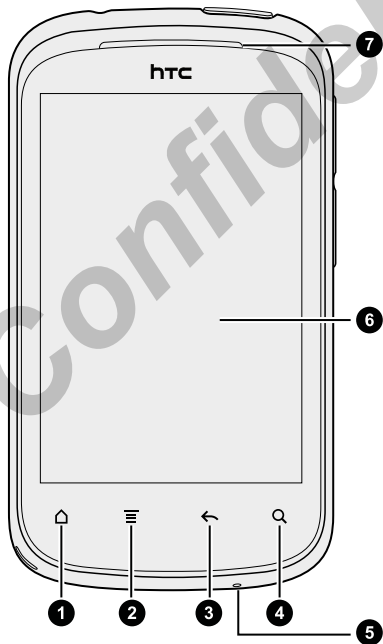
HTC Explorer

Front panel



1. Home 
2. Menu 
3. Back 
4. Search 
5. Microphone
6. Touch screen
7. Earpiece

Left and right panels

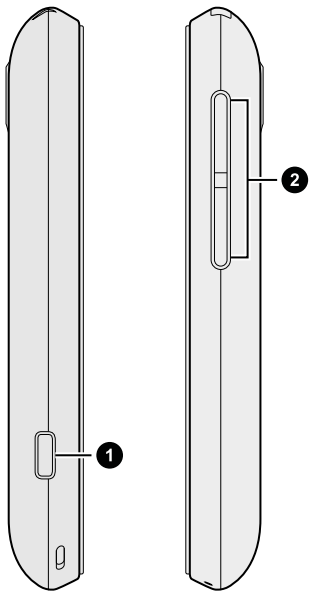

- 1. USB connector
- 2. VOLUME controls

Back panel

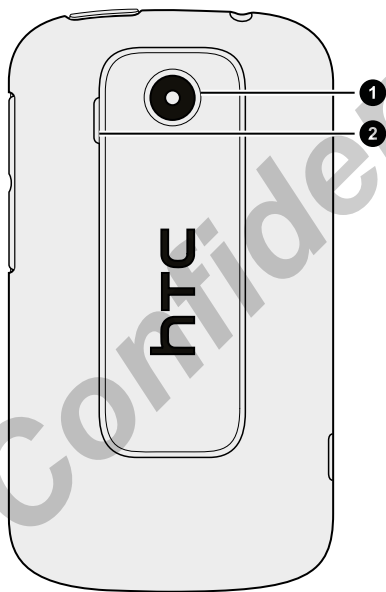

- 1. 3 megapixel camera
- 2. Speaker

Top panel

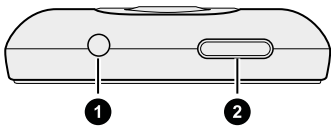

- 1. 3.5mm headset jack
- 2. POWER

Back cover

Removing the back cover

Remove the back cover to access the battery compartment, SIM card slot, and storage card slot.

1. Turn off HTC Explorer and hold it securely upside down with the front facing away from you.
2. With your fingers, pry the bottom of the back cover away from the phone while pressing in with your thumb against the middle of the back cover.

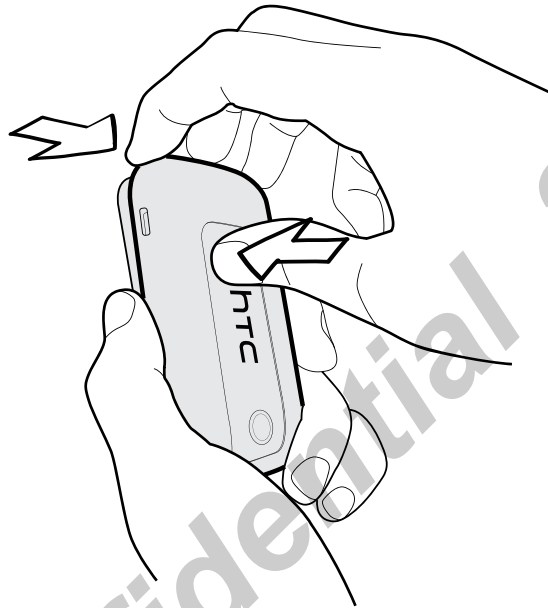

Replacing the back cover

1. Insert the top half of the phone into the top of the back cover.

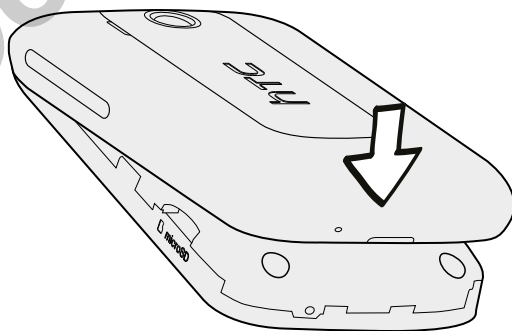

2. Press the bottom part of the back cover towards the phone to lock the cover in place. You'll hear a click when the back cover is locked in place.

SIM card

The SIM card contains your phone number, service details, and memory for storing phonebook contacts and/or text messages.

Inserting the SIM card

1. Take the back cover off.
2. Remove the battery.
3. With the SIM card's gold contacts facing down and its cut-off corner facing out, insert the SIM card all the way into the SIM card slot.

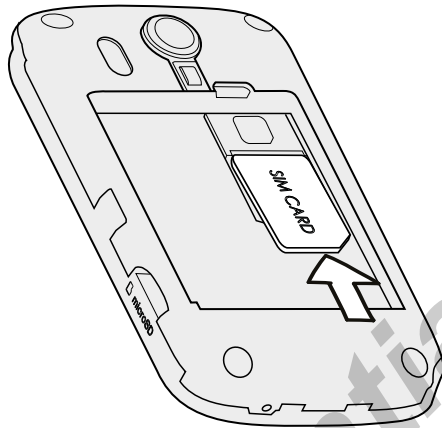

Removing the SIM card



Make sure to switch off HTC Explorer before removing your SIM card.

1. Take the back cover off.
2. Remove the battery.
3. Press and hold the SIM card tab.

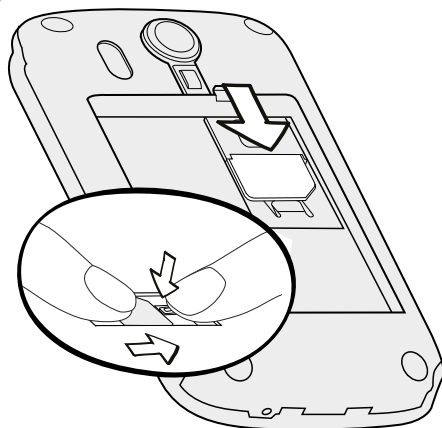

4. Slide the SIM card out from the SIM card slot.

Storage card

Use the storage card to store your photos, videos, and music.

Inserting the storage card

1. Take the back cover off.
2. Insert the microSD card into the storage card slot with its gold contacts facing down and slide it in until it is securely in place.

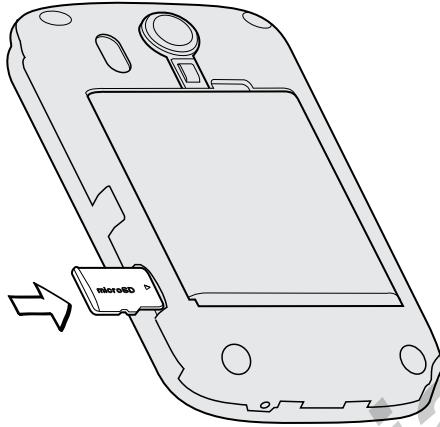

Removing the storage card

⚠ If HTC Explorer is on you must first "unmount" the storage card before removing it to prevent corrupting or damaging the files in the storage card.

1. Take the back cover off.
2. Slide the storage card out from its slot.

Unmounting the storage card

When you need to remove the storage card while HTC Explorer is on, unmount the storage card first to prevent corrupting or damaging the files in the storage card.

1. From the Home screen, press , and then tap **Settings**.
2. Tap **Storage > Unmount SD card**.

Battery

HTC Explorer uses a rechargeable battery. How long the battery can last before it needs recharging depends on how you use HTC Explorer. The features and accessories you use can affect battery life. For example, leaving your Bluetooth® connection always on uses more power. Long phone calls and frequent web browsing use up a lot of battery power. Also, consider your location: poor signal strength from your mobile network and extreme temperature make the battery work harder.

Removing the battery

1. Take the back cover off.
2. With your thumb or finger, lift the battery from the battery compartment.

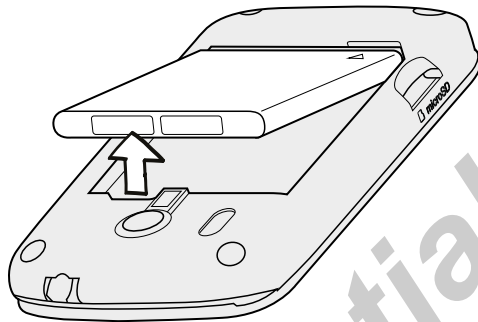

Inserting the battery



Please use only original batteries that came in the box or replacements that we recommend.

1. Take the back cover off.
2. Insert the battery (with its exposed copper contacts first) into the battery compartment.

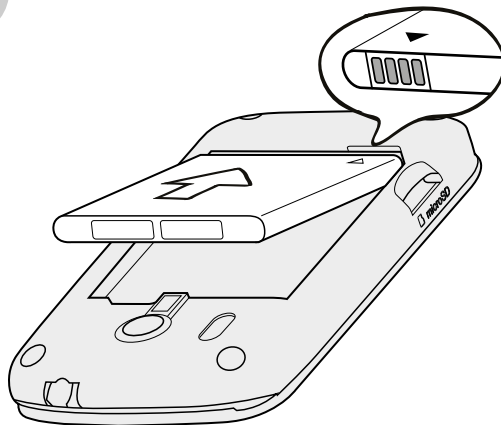

Charging the battery

Before you turn on and start using HTC Explorer, it is recommended that you charge the battery.



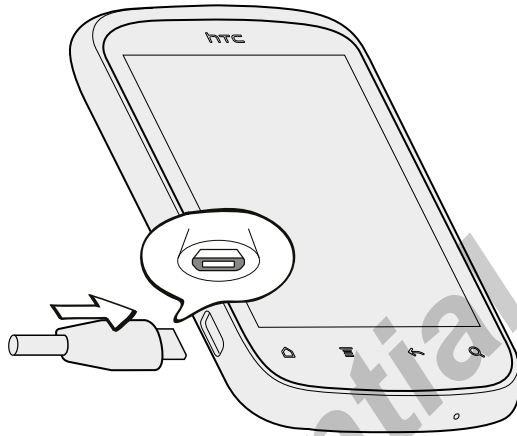

- Only the power adapter and USB cable provided in the box must be used to charge the battery.
- Do not remove the battery from HTC Explorer while you are charging it using the power or car adapter.

1. Insert the small end of the USB cable into the USB connector.



2. Insert the other end of the USB cable into the power adapter.
3. Plug in the power adapter to an electrical outlet to start charging the battery.

When you charge the battery and HTC Explorer is on, the charging battery icon  is displayed in the status bar. After the battery has been fully charged, the charging battery icon turns to a full battery icon .



As a safety precaution, the battery stops charging when it overheats.

Switching the power on or off

Switching the power on

Press the POWER button. Easy.



When you turn on HTC Explorer for the first time, you'll need to set it up.

Switching the power off

1. If the display is off, press the POWER button to turn it back on, then unlock the screen.
2. Press and hold the POWER button for a few seconds.
3. When the Power options menu appears, tap **Power off**.

Entering your PIN

Most SIM cards come with a PIN (personal identification number) set by your mobile operator. If you're asked for a PIN, enter it and then tap **OK**.



If you enter the wrong PIN three times, your SIM card is blocked. No problem. Just contact your mobile operator and ask for the PUK (PIN Unblocking Key).

Finger gestures

| | |
|----------------|--|
| Tap | When you want to type using the keyboard, select items onscreen such as application and settings icons, or press onscreen buttons, simply tap them with your finger. |
| Press and hold | To open the available options for an item (for example, a contact or link in a web page), simply press and hold the item. |
| Swipe or slide | To swipe or slide means to quickly drag your finger vertically or horizontally across the screen. |
| Drag | Press and hold your finger with some pressure before you start to drag. While dragging, do not release your finger until you have reached the target position. |
| Flick | Flicking the screen is similar to swiping, except that you need to swipe your finger in light, quicker strokes. This finger gesture is always in a vertical direction, such as when flicking the contacts or message list. |
| Rotate | For most screens, you can automatically change the screen orientation from portrait to landscape by turning HTC Explorer sideways. When entering text, you can turn HTC Explorer sideways to bring up a bigger keyboard. |
| Pinch | In some apps, like Gallery or the web browser, you can "pinch" the screen using two fingers (for example, thumb and index finger) to zoom in or zoom out when viewing a picture or a web page. |

Setting up HTC Explorer for the first time

When you switch on HTC Explorer for the first time, you'll be asked to set it up. You can choose how you want to connect to the Internet and whether you want your current location to be automatically detected. If you still have personal contacts and calendar events stored on your old phone, you can easily transfer them to HTC Explorer through Bluetooth as well.

Be sure to sign in to your Google® Account so you can use Google apps like Gmail™ and Android Market™. You can also set up your other email accounts and Facebook®.

Just follow the onscreen instructions and you'll be up and running in no time.



Some features that need to connect to the Internet such as location-based services and auto-sync of your online accounts may incur extra data fees. Don't worry. You can enable or disable them in settings later on.

Ways of getting contacts into HTC Explorer

There are several ways you can add contacts to HTC Explorer. You can sync HTC Explorer with contacts from your Google Account, computer, Facebook, and more.

| | |
|--------------------------------|--|
| HTC Sync™ | Sync the contacts from your old phone to your computer, and then use HTC Sync to sync HTC Explorer with your computer's Microsoft® Outlook®, Outlook Express or Windows® Contacts. |
| Gmail | Google contacts are imported to HTC Explorer after you sign in to your Google Account. You can also create more Google contacts right from HTC Explorer. |
| Facebook | Log in to your Facebook account to import your Facebook friends' contact information. |
| Phone contacts | You can choose to create and store contacts directly in HTC Explorer or transfer existing ones from your old phone. |
| SIM card | Copy all your SIM contacts to HTC Explorer. |
| Microsoft Exchange ActiveSync® | HTC Explorer syncs your work contacts from the Microsoft Exchange ActiveSync Server in your workplace. |
| Transfer | Use the Transfer app to transfer not only your contacts, but also calendar events and text messages from your old phone to HTC Explorer. |

Home screen

Your Home screen is where you make HTC Explorer your own. It comes with a Shortcuts & Clock widget that contains shortcuts to your favorite apps and shows the time and weather in your city. You can also add your favorite applications, shortcuts, folders and widgets so they're always just a tap away. To find out how, see [Personalizing](#) on page 28.

Extended Home screen

As you start to do more things with HTC Explorer, you might find that one Home screen is not enough. No problem. You can use up to six extra screens. It should be plenty.

Slide your finger horizontally to the left or right and you'll discover more space for adding icons, widgets, and more.

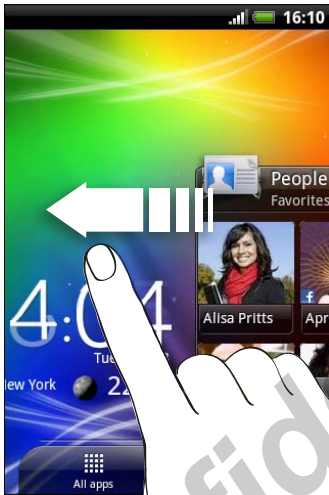

Press  to return to the main Home screen (that is, the center home screen).

Using Leap view

To jump straight to the screen that you want, press  or pinch the screen to show the Leap view. It reveals all seven Home screens as thumbnails.



Just tap the one you want and you'll leap right there.



HTC Confidential 2011/09/16

Basics

Adjusting the volume

Adjusting the ringer volume changes the volume level of the ringtone, while adjusting the media volume changes the volume level of sound notifications and music or video playback.

Adjusting the ringer volume

- Press the VOLUME UP or VOLUME DOWN button to adjust the ringer volume to your desired level. The Ringer volume window appears on the screen to display the volume levels.
- While in the lowest ringer volume level (Silent mode), press VOLUME DOWN once to switch to Vibrate mode. The vibrate mode icon  appears in the status bar.
- While in Vibrate mode, press VOLUME UP once to switch to silent mode. The speaker mute icon  displays in the status bar.

Adjusting the media volume

When playing music or watching video, press the VOLUME UP or VOLUME DOWN button to adjust the volume. The Media volume window appears on the screen to display the volume level.

Adjusting the earpiece volume for calls

During a call, press the VOLUME UP or VOLUME DOWN button.

Adjusting the volume via settings

1. From the Home screen, press , and then tap **Settings > Sound > Volume**.
2. Drag the volume sliders to the left or right to adjust the volume levels of the ringtone, media playback, alarms, and notifications. A sample tone is briefly played with the volume being adjusted as you drag a slider.
3. If you want the same volume for your ringtone and notifications, select **Use incoming call volume for notifications**.
4. When you're done, tap **OK**.

Sleep mode

Sleep mode saves battery power by putting HTC Explorer into a low power state while the display is off. It also stops accidental button presses when HTC Explorer is in your bag. You'll still receive messages and calls though.

Switching to Sleep mode

Briefly press the POWER button to turn off the display and switch to Sleep mode. HTC Explorer also automatically goes into Sleep mode when it's idle for a while.

Waking up from Sleep mode

To wake HTC Explorer up manually, press the POWER button. You'll need to unlock the screen.



HTC Explorer automatically wakes up when you have an incoming call.

Unlocking the screen

Pull the ring up to unlock the screen.



If you have set up a screen unlock pattern, pin, or password, you will be asked to draw the pattern on the screen or enter the PIN or password before it unlocks.

If you've set an event reminder or an alarm, you can drag  or  to the ring to snooze or dismiss the event or alarm.

Opening an app from the lock screen

On the lock screen, drag an app icon to the ring to unlock the screen and directly go to the app.



You can customize the lock screen in **Settings > Personalize > Lock screen shortcuts** to show your four favorite apps.







Status and notifications

Status icons



Here's what each icon means:

| | |
|---|---|
|  Signal strength |  Battery is full |
|  GPRS connected |  Battery is charging |
|  GPRS in use |  Battery is low (20% remaining) |
|  EDGE connected |  Battery is very low (10% or less remaining) |
|  EDGE in use |  Silent mode |
|  3G connected |  Vibrate mode |
|  3G in use |  Microphone is mute |
|  HSDPA connected |  Speakerphone is on |
|  HSDPA in use |  Wired microphone headset connected |
|  Roaming |  Wired headset connected |
|  No signal |  Bluetooth is on |



















| | |
|---|---|
|  No SIM card installed |  Connected to a Bluetooth device |
|  Connected to a Wi-Fi® network |  Airplane mode |
|  Data synchronizing |  GPS is on |
|  Network sharing is on |  Alarm is set |



Notification icons

Notification icons on the status bar make it easy for you to keep on top of your messages, calendar events, and alarms.



Here's what each one means:

| | |
|---|---|
|  New Gmail message |  General notification |
|  New Microsoft Exchange ActiveSync or POP3/IMAP email |  Call in progress |
|  Problem with email delivery |  Missed call |
|  New SMS/MMS |  Call on hold |
|  Problem with SMS/MMS delivery |  Call forwarding on |
|  New Google Talk™ instant message |  Message forwarding on |
|  New voicemail |  HTC Explorer is connected to a computer via USB cable |
|  Upcoming event |  Wi-Fi is on and wireless networks are available |
|  New updates from your social networks | |
|  Matched contacts suggestion |  Uploading data (animated) |

| | |
|--|--|
|  Bluetooth pairing request |  Downloading data (animated) |
|  HTC Explorer software update available |  Waiting to upload |
|  Song is playing |  Downloaded Android Market app installed successfully |
|  FM Radio app in use |  Update available for an app downloaded from Android Market |
|  Voice recording is on |  Blank card |
|  More (not displayed) notifications |  Internal storage is low |

Notifications panel

When you get a new notification, you can open the Notifications panel to see what event notification or new information you've received. The Notifications panel lets you quickly switch between recently-opened apps, and also lets you easily turn on settings such as Wi-Fi and Bluetooth.

To open the Notifications panel, press and hold the status bar, then slide your finger downward.

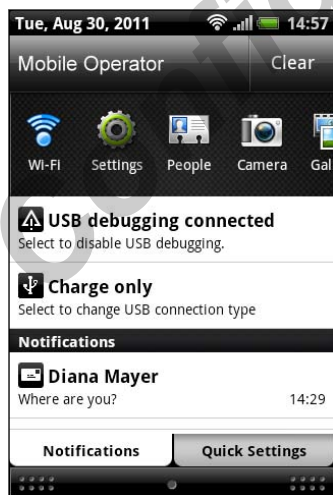

If you have several notifications, you can scroll down the screen to see them all.



You can also open the Notifications panel on the Home screen by pressing  and then tapping Notifications.

Switching between recently opened apps

On the Notifications panel, you can easily access up to eight apps you just recently opened.

1. Press and hold the status bar, then slide your finger downward to open the Notifications panel.
2. In the Recent apps section, slide your finger left or right to see recently-opened apps.

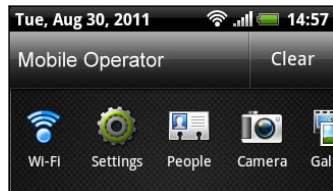

3. Tap an app to open it.



Press and hold  to view recently used apps.

Using Quick Settings

The Quick Settings tab lets you easily turn on Wi-Fi, Bluetooth, and more, and also provides a quick shortcut to all HTC Explorer settings.

1. Press and hold the status bar, then slide your finger downward to open the Notifications panel.
2. Tap the Quick Settings tab.
3. Tap the check box next to an item to turn it off or on.

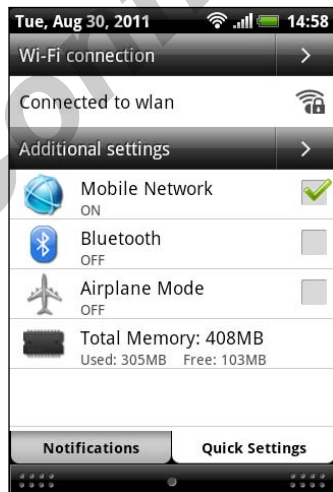

Closing the Notifications panel

Press and hold the bottom bar of the Notifications panel, then slide your finger up the screen. Or just press .

Connecting HTC Explorer to a computer

Whenever you connect HTC Explorer to a computer using the USB cable, the Choose a connection type screen opens and lets you choose the type of USB connection.

Select one of the following choices, and then tap **Done**:

| | |
|------------------------------|--|
| Charge only | Select this option if you only want to charge the battery while connected to your computer. |
| Disk drive | This mode is available only when there's a storage card installed on HTC Explorer. Select this mode when you want to copy files between the storage card and your computer. When Disk drive mode is enabled while HTC Explorer is connected to the computer, you will not be able to use apps on HTC Explorer to access the storage card. |
| HTC Sync | Select this option to synchronize contacts, calendar, and other information between your computer and HTC Explorer. |
| USB tethering | When you do not have an Internet connection on your computer, you can select this mode to share the mobile data connection of HTC Explorer with your computer. |
| Internet pass-through | If you don't have a data plan or you don't have access to a Wi-Fi network, you can select this mode to share your computer's Internet connection with HTC Explorer. |

Copying files to or from the storage card

You can copy your music, photos, and other files to the storage card.

1. Connect HTC Explorer to your computer using the supplied USB cable.
2. On the Choose a connection type screen, select **Disk drive**, and then tap **Done**. On your computer, the storage card is recognized as a removable disk.
3. Navigate to the removable disk and open it.
4. Do one of the following:
 - Copy the files from the computer to the storage card's root folder.
 - Copy the files from the storage card to a folder in your computer.
5. After copying the files, unmount the removable disk (that is, the connected HTC Explorer) as required by your computer's operating system to safely remove HTC Explorer.
6. Do one of the following:
 - Disconnect HTC Explorer from the computer.
 - If you want to keep HTC Explorer connected to the computer but want it to be able to access the storage card, open the Notifications panel, tap **Disk drive**, select an option except **Disk drive**, and then tap **Done**.

Copying text, looking up information, and sharing

In apps such as the web browser and Mail, you can select text and choose what you want to do with it.

Selecting text

1. Press and hold on a word.
2. Drag the start and end markers to highlight the surrounding text you want to select.



To copy the address of a linked web page, press and hold the link, and then tap Copy link URL.

Copying and pasting text

1. After you have selected the text you want to copy, tap **Copy**.
The selected text is then copied to the clipboard.
2. In a text entry field (for example while composing an email), press and hold at the point where you want to paste the text.
3. Tap **Paste**.

Searching or translating text

1. After you have selected the text you want to search for or translate, tap .
2. Tap one of the following tabs:



Google Search

Look for related information using Google Search, based on the text that you selected.



Wikipedia

Look for related information on Wikipedia®, based on the text that you selected.



YouTube

Look for videos on YouTube®, based on the text that you selected.



Google Translate

Translate the text to another language.

Sharing text

1. After you have selected the text you want to share, tap .
2. Choose where to paste and share the selected text, such as in an email message or Facebook status update.

HTC Confidential 2011/09/16

Personalizing

Making HTC Explorer truly yours

Make HTC Explorer look and sound just the way you want it. Personalize it with a different wallpaper, skin, ringtone, and notification sound for events such as incoming text, email, and calendar reminders.

On the Home screen, press , and then tap **Personalize** to get started.

Personalizing HTC Explorer with scenes

HTC Explorer becomes multiple phones in one when you use scenes. Scenes are personalized Home screen layouts that you can quickly apply. By switching between scenes, you instantly turn HTC Explorer into your perfect weekend phone, travel phone, work phone, or pure play phone.



Everytime you add or modify something on the Home screen, HTC Explorer automatically saves your changes to the current scene selected.

Using a preset scene

HTC Explorer features preset scenes, each preconfigured with a different wallpaper and collection of widgets that reflect different moments in your life. You can choose a scene that is suitable for work, play, travel, or your social life.



1. From the Home screen, press , and then tap **Personalize**.
2. On the Display tab, tap **Scene**.
3. Slide your finger on the screen from right to left to select the scene you want.
4. Tap **Apply**.



To download more scenes, press , and then tap **Personalize**. On the Display tab, tap **Scene > Get more**.

Creating a new scene

You'll start with an empty Home screen when you create a new scene.



1. From the Home screen, press , and then tap **Personalize**.
2. On the Display tab, tap **Scene**.
3. Press , and then tap **New**.

4. Enter a new scene name, then tap **Done**.
5. Personalize the scene by adding widgets and other elements, arranging the Home screen layout, and changing the skin or wallpaper. All of your changes will be automatically saved to this scene.

Renaming a scene

1. From the Home screen, press , and then tap **Personalize**.
2. On the Display tab, tap **Scene**.
3. Slide your finger on the screen from right to left to select the scene you want to rename.
4. Press and hold a scene thumbnail, then tap **Rename**.
5. Enter a new scene name, then tap **Done**.

Deleting scenes

1. From the Home screen, press , and then tap **Personalize**.
2. On the Display tab, tap **Scene**.
3. Press , and then tap **Delete**.
4. Slide your finger on the screen from right to left to browse through scenes, then tap one or more scenes you want to delete.
5. Tap **Delete**.

Changing your wallpaper

Personalizing your wallpaper with your favorite photo is a quick and easy way to give HTC Explorer a fresh look. Browse the collection of wallpapers included in HTC Explorer or choose from photos that you have taken with the camera. You can also change your Home screen to use an animated wallpaper.

1. From the Home screen, press , and then tap **Personalize**.
2. On the Display tab, tap **Wallpaper**.
3. Tap one of the following:

| | |
|------------------------|---|
| HTC wallpapers | Choose a preset wallpaper, then tap Preview > Apply . |
| Live wallpapers | Choose from preset animated wallpapers. Tap Preview to view the animation, and then tap Apply . |
| Gallery | Choose an existing photo. Crop the photo and then tap Save . |



To download more wallpapers, press , and then tap **Personalize**. On the Display tab, tap **Wallpaper** > **HTC wallpapers** > **Get more**.

Applying a new skin

Personalize beyond the Home screen by applying a new skin. Skins are set to give a different look and feel to most onscreen buttons, application screens, option menus, and other items.

1. From the Home screen, press , and then tap **Personalize**.
2. On the Display tab, tap **Skin**.
3. Slide your finger on the screen from right to left to select the skin you want.
4. Tap **Apply**.



To download more skins, press , and then tap **Personalize**. On the Display tab, tap **Skin > Get more**.

Personalizing your Home screen with widgets

Widgets put at-a-glance important information and media content up front on your Home screen. Some widgets are already added to your Home screen for your convenience. You can add more from the available selections of widgets.

Adding a widget to your Home screen

1. Go to a part of the Home screen where there's space to add a new widget.
2. Press , and then tap **Personalize**.
3. On the Add to home tab, tap **Widget**.
4. Select a widget that you want.
5. Most HTC widgets are available in a variety of designs and sizes to suit your needs. Slide your finger on the screen from right to left to view the different styles, and then tap **Select** to choose one.

You can also add widgets that allow you to quickly switch on or off certain settings such as Wi-Fi and Bluetooth. Scroll down the widgets list, tap **Settings**, and then tap the widget that you want.



To download more widgets, press , and then tap **Personalize**. On the Add to Home tab, tap **Widget > Get more HTC widgets**.

Changing the settings of a widget

You can modify basic settings of some widgets (for example, the People and Mail widgets) from the Home screen.

1. Press and hold a widget on the Home screen. HTC Explorer vibrates and you'll see a colored box around the widget. Don't lift your finger just yet.
2. Drag the widget to .

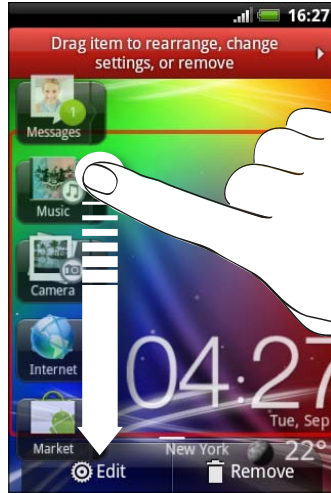

The relevant screen where you can change some settings for this widget then opens.

3. Customize the widget settings.

Adding icons and other shortcuts on your Home screen

Place app icons on your Home screen to open apps quicker. You can also add shortcuts to settings and specific information such as a bookmarked webpage, someone's phone number, a music playlist, route directions, and many other items, to your Home screen.



The shortcuts available depend on the apps that are installed on HTC Explorer.

1. Go to a Home screen where there's space to add a new icon or shortcut.
2. Press , and then tap **Personalize**.
3. On the Add to Home tab, tap **App** to add an app icon, or **Shortcut** to add a shortcut to a setting or information.



To add an app icon on the Home screen, tap , and then press and hold an app icon. Without lifting your finger, drag the icon to an empty area on the Home screen, and then release it.

Adding folders on your Home screen

Use folders to group related apps and other shortcuts to keep your Home screen tidy and organized. You can also add information folders that show up-to-date information such as Bluetooth received files, your Facebook phonebook, and more.

Creating a new folder and adding items to it

1. Go to a part of the Home screen where there's space to add a new folder.
2. Press , and then tap **Personalize**.
3. On the Add to home tab, tap **Folder**.
4. Tap **New Folder**. The new folder appears on the Home screen.
5. Go to the Home screen where there is an app, icon, or shortcut, and then press and hold it. HTC Explorer then vibrates. Don't lift your finger just yet.
6. Drag the app, icon, or shortcut and drop it on the folder.

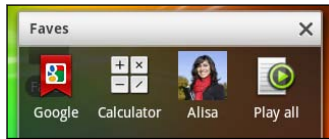

Simply tap the folder to open it so you can access the apps and shortcuts inside the folder.

Renaming a folder

1. Tap the folder to open it.
2. Press and hold the folder window's title bar.
3. Enter a new folder name and then tap **OK**.

Rearranging or removing widgets and icons on your Home screen

Rearrange the widgets and icons on your Home screen to make room for adding more items. You can also remove widgets and icons that you don't frequently use.

Moving a widget or icon

1. Press and hold the widget or icon you want to move. HTC Explorer vibrates and you'll see a colored box around the widget or icon. Don't lift your finger just yet.
2. Drag the widget or icon to a new location on the screen.



- You can pause at the left or right edge of the screen to drag the widget or icon onto another Home screen panel.
- When you drag an icon to a spot that's occupied by another icon, the occupant automatically moves away to give room.

3. When the widget or icon is where you want it, lift your finger.

Removing a widget or icon

1. Press and hold the widget or icon you want to remove. HTC Explorer vibrates and you'll see a colored box around the widget or icon. Don't lift your finger just yet.
2. Drag the widget or icon to .
3. When the widget or icon also turns red, lift your finger.

Rearranging the Home screen

Reorder your Home screen panels in any way that fits how you use them. For example, move the panels with frequently-used widgets, shortcuts, and folders closer to the main Home screen.



The main Home screen is the panel that is bordered by a thin line in Leap view.

1. Pinch the Home screen to show the Leap view.
2. Press and hold the thumbnail of the home screen you want to move. HTC Explorer then vibrates. Don't lift your finger just yet.
3. Drag the thumbnail to its new position, and then lift your finger.



Customizing the shortcuts on the lock screen

You can choose what shortcuts you want for your lock screen so you can unlock the screen straight into your favorite app.



1. From the Home screen, press , and then tap **Personalize**.
2. On the Display tab, tap **Lock screen > Choose lock screen shortcuts**.

3. Tap a shortcut that you want to change, and then choose another app to replace it .
4. Tap Done.

Using sound sets

Each sound set gives you a different combination of sounds for your ringtone and notifications such as incoming messages, email, calendar event reminders, and more. By switching between sound sets, you can instantly make HTC Explorer ring or alert you with fun sounds when you're out with friends or change to subtle sounds while you're at work.



Choosing a preset sound set

1. From the Home screen, press , and then tap **Personalize**.
2. On the Sound tab, tap Sound sets screen, and then tap a sound set name.
3. You can tap  to listen to the different sounds for that sound set.
4. Tap **Apply**.



To download more sound sets, press , and then tap **Personalize** . On the Sound tab, tap **Sound set > Get more**.

Creating a sound set

1. From the Home screen, press , and then tap **Personalize**.
2. On the Sound tab, tap Sound set.
3. Tap .
4. Enter a new sound set name, and then tap **Done**.

The newly created sound set is then added to the list of sound sets. You can assign different tones to the sound set to your preference.

Changing your ringtone, notifications, and sounds

Change your ringtone, notification sounds, and alarms to suit your mood or lifestyle. Choose different sounds from the preset selection or your storage card.

1. From the Home screen, press , and then tap **Personalize**.
2. On the Sound tab, tap **Sound set**.

3. Choose a sound set you want to customize or create a new one, and then tap **Apply**.
4. Change the ringtone, notification sound, and alarm from the Personalize screen.



You can also go to the Messages, Mail, and Calendar apps to choose sounds for new messages, email, and calendar reminders respectively.

HTC Explorer automatically saves your choices to the current sound set.

Deleting sound sets

1. From the Home screen, press , and then tap **Personalize**.
2. On the Sound tab, tap **Sound set**.
3. Press , and then tap **Delete**.
4. Tap one or more sound sets you want to delete.
5. Tap **Delete**.

Rearranging or hiding application tabs

You can rearrange the tabs of some apps to prioritize the types of information you frequently use or remove the tabs you don't really need.

1. Open an app that has the usual tabs at the bottom of its screen.



2. Press and hold a tab. When the screen changes and shows you the area where you can rearrange icons, lift your finger.
3. Do any of the following:

| | |
|---------------------|--|
| Add a tab | Press and hold a tab that you want to add, and then drag it beside the other tabs. |
| Move a tab | Press and hold the tab you want to move, and then drag it to its new position. |
| Remove a tab | Press and hold a tab you want to hide, then drag it up. |

4. When you're done, press .

Adding a tab back

1. Open the app from which you previously removed some tabs.
2. Press and hold a tab. When the screen changes and shows you some of your hidden tabs, lift your finger.

3. Press and hold the tab you want to show, then drag it down to where you want to position it again.



4. When you're done, press .

Shortcuts & Clock widget

Open often-used apps or preview their contents right from the Home screen.



From the Shortcuts & Clock widget, you can:

- Tap the shortcut to an app to open it
- Tap the information bar to extend it and view the contents of that app
- Tap the preview of the content and open it



Customizing the Shortcuts & Clock widget

You can choose which shortcuts and city appear on the Shortcuts & Clock widget.

1. On the Home screen, tap and hold the Shortcuts & Clock widget. Don't lift your finger just yet.
2. Drag the widget to .
3. From this screen, you can:
 - Tap a shortcut slot, and then choose an app or shortcut to assign to it.
 - Tap the time, and then select a city that will appear in the widget. If your city is not included in the list, tap  to add your city.
4. Tap Done.

The Shortcuts & Clock widget is updated.

HTC Confidential 2011/09/16

Phone calls

Different ways of making calls

Besides making calls from the phone dialer screen on HTC Explorer, you can tap a number in a text message or email to call, or press a single number on the phone dialer to quickly call a contact.





Most SIM cards come with a PIN (personal identification number) set by your mobile operator. If you're asked for a PIN, enter it and then tap **OK**. If you enter the wrong PIN three times, your SIM card is blocked. Don't worry. Just contact your mobile operator and ask for the PUK (PIN Unblocking Key).

Making a call on the Phone dialer screen

You can either dial a number directly, or use the Smart dial feature to search and call a stored contact or a number from your call history.

1. On the Home screen, tap .
2. Begin entering the first few digits of a phone number or characters of a contact name on the phone keypad. The Phone dialer screen then displays a list of matching numbers and names.



If you enter a wrong digit or letter, tap  to delete it. To erase the entire entry, press and hold .

3. Slide your finger up on the filtered list to close the phone keypad and see if there are more matching numbers or contacts.
4. To place a call, do one of the following:
 - Tap a phone number or contact from the list.
 - After entering a complete number, tap **Call**.
 - To call a different phone number associated with the contact, you can tap  at the right side of the contact name. On the contact details screen, tap the number you want to call.

While dialing or when the call is in progress, the status bar displays the call in progress icon .

What is Smart dial?

The phone dialer's Smart dial feature makes it quick and easy for you to place a call.

Simply enter the phone number or first few letters of the person's name you want to call. Smart dial automatically searches and filters your stored contacts and the phone numbers from the call history.



Using Speed dial

Use Speed dial to call a phone number with a single tap. For example, if you assign a contact's number to the number 2 key, you can just press and hold 2 to dial the number.



The number 1 key is generally reserved for your voicemail. Press and hold this key to call voicemail and retrieve your voicemail messages.

Assigning a speed dial key

1. On the Home screen, tap **Phone**.
2. Press , and then tap **Speed dial** > .
3. Enter the name of the contact you want to add. When the name comes up in the list, tap the name.
4. On the Speed dial screen, choose the phone number of the contact to use, and a speed dial key to assign.
5. Tap **Save**.



You can also set a speed dial key in People. Tap a contact, press , and then select **Set speed dial** (or **More** > **Set speed dial**).

Calling a phone number in a text message

1. Tap the phone number within the message.

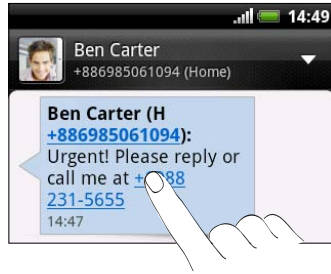

2. Tap Call.



To call the message sender, tap the received message, and then tap **Call** on the options menu.

Calling a phone number in an email

Want to call a number that's in an email? No problem.

1. In the email body, tap the phone number.
2. Edit the number if necessary.
3. Tap Call.

Calling a phone number in a Calendar event

Tapping a phone number in a Calendar event lets you see the event details such as conference call ID number or meeting PIN code while on the Phone dialer screen.

1. Open an event in Calendar.
2. On the Event details screen, tap the phone number.
3. Tap Call.

Making an emergency call

In some regions, you can make emergency calls from HTC Explorer even if you don't have a SIM card installed or your SIM card has been blocked.

1. On the Home screen, tap .
2. Dial the emergency number for your locale, and then tap **Call**.

If you've enabled but forgotten your lock password or lock pattern, you can still make emergency calls by tapping **Emergency call** on the screen.

Receiving calls

When you receive a phone call from a contact, the Incoming call screen appears.



You can use the polite ringer and pocket mode features for receiving calls. To find out how, see [Changing sound settings](#) on page 166.

Answering a call

Do one of the following:

- Tap **Answer**.
- If the display is off when you get a call, the Lock screen appears. Drag  to the ring to unlock the screen and answer the call.



Rejecting a call

Do one of the following:

- Tap **Decline**.
- If the display is off when you get a call, the Lock screen appears. Drag  to the ring on the Lock screen.
- Press the POWER button twice to reject a call.

Muting the ringing sound without rejecting the call

Do one of the following:

- Press the VOLUME DOWN or VOLUME UP button.
- Press the POWER button.
- Place HTC Explorer face down on a level surface.



If HTC Explorer is already facing down, it will still ring when there are subsequent incoming calls.

HTC Caller ID

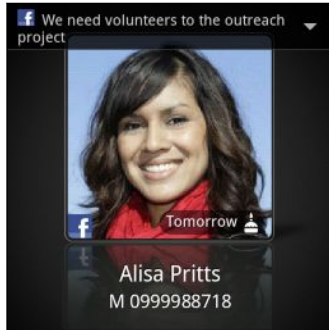

Everytime you make a call or your friend gives you a ring, you get to see your friend's latest status update from social networks like Facebook or Twitter™ right on the call screen. You also won't miss people's birthdays. You'll see a birthday reminder, if your friend's birthday will occur sometime within the next seven days.



What can I do during a call?

When a call is in progress, use the buttons onscreen to mute or unmute the microphone or to turn the speakerphone on or off. You can also press  and choose whether to add a call, place the call on hold, mute the microphone, and more.

Putting a call on hold

1. Press  and then tap **Hold** to put the call on hold. When you put a call on hold, the status bar displays the hold call icon .
2. Press , and then tap **Unhold** to resume the call.

Switching between calls

If you're already on a call and accept another call, you can choose to switch between the two calls.

1. When you receive another call, tap **Answer** to accept the second call and put the first call on hold.
2. To switch between the calls, tap the person you want to talk to on the screen.



3. To end the current call and return to the other call, tap **End call**.

Turning the speakerphone on during a call



To decrease potential damage to your hearing, do not hold HTC Explorer against your ear when the speakerphone is on.

Do one of the following:

- Flip HTC Explorer over during a call (be sure that **Flip for speaker** is selected in > > **Settings** > **Sound**).
- On the call screen, tap .

The speakerphone icon appears in the status bar when the speakerphone is on.

To turn the speakerphone off, just flip HTC Explorer over again, facing it up. Or tap again.

Muting the microphone during a call

On the call screen, tap to toggle between turning the microphone on or off. When the microphone is turned off, the mute icon appears in the status bar.

Ending a call

Do one of the following to end the call:

- On the call screen, tap **End call**.



If the display is off, press **POWER** to turn on the screen so you can tap **End call**.

- Slide open the Notifications panel, then tap .

If the phone number of the person who called is not in your contacts list, you can choose to save the number to your contacts list after you hang up.



Setting up a conference call

Conference calling with your friends, family, or co-workers is easy. Make the first call (or accept a call), and then simply dial each subsequent call to add it to the conference.



Make sure your SIM card is enabled with conference calling service. Contact your mobile operator for details.

1. Make a call to the first conference call participant.
2. When connected, press , tap **Add call**, and then dial the number of the second participant. The first participant is put on hold when you dial the second participant.
3. When connected to the second participant, tap merge .

4. To add another participant to the conference call, tap  on the conference call screen, and then dial the number of the contact you want to invite to the conference call.
5. When connected, tap  to add the participant to the conference call.
6. To talk to a person in the conference call in private, tap  and then select **Private call** on the options menu.

To end the call with a participant, tap  and then tap **Finish this call** on the options menu.



To end the conference call, tap **End call**.

Internet calls

When you're connected to a Wi-Fi network, you can make and receive calls through an Internet calling account.

 Before you add an Internet calling account, make sure that you've registered with an Internet calling service that supports voice calls over Session Initiation Protocol (SIP). Internet calls to phone numbers may incur additional fees.

Adding an Internet calling account

1. From the Home screen, press , and then tap **Settings** > **Call**.
2. Under Internet call settings, tap **Accounts**.
3. Tap **Add account**.
4. Enter your account details.
5. Press  to save your account.
6. To set HTC Explorer to receive Internet calls on your added account, tap the **Receive incoming calls** check box.

Making an Internet call

Make an Internet call to either your contact's Internet calling account or phone number.

Call any of the following:

| | |
|--------------------------|--|
| Internet calling account | <ul style="list-style-type: none"> ▪ In People, tap a contact who has an Internet calling account, and then tap Internet call. ▪ In Call History, tap an Internet call log. |
| Phone number | See Different ways of making calls on page 38. But first, set HTC Explorer to use Internet calling for your outgoing calls. From the Home screen, press  , and then tap Settings > Call . Tap Use Internet calling , and then select either For all calls or Ask for each call . |

Using Call history



Use Call History to check missed calls, your dialed numbers, and received calls.

Checking a missed call

You will see the missed call icon  in the status bar when you miss a call.

1. Slide open the Notifications panel to check who the caller is.
2. To return the call, tap the missed call notification. Then tap the caller's name or number on the Call History screen.

Checking calls in the Call History

1. On the Home screen, tap .
2. Slide to the Call History tab.
3. On the Call History screen, you can:
 - Tap a name or number in the list to call.
 - Press and hold a name or number in the list to display the options menu.
 - Tap  to check only the call history of a particular contact.
 - Press , then tap **View** to display just a particular type of calls such as missed calls or outgoing calls.

Adding a new phone number to your contacts from Call History

1. On the Call History screen, press and hold the phone number that you want to save, and then tap **Save to People**.
2. Choose whether to create a new contact or save the number to an existing contact on HTC Explorer.
3. Do any of the following:
 - When creating a new contact, enter the contact name, contact type, and other information in the blank contact record that appears. The phone number is automatically added to the mobile field in the phone section. To store it as another type of number, for example a home number, tap the **Mobile** button.
 - When saving the number to an existing contact, tap a contact stored on HTC Explorer, and then select the number type.
4. Tap **Save**.

Clearing the Call History list

On the Call History screen, do one of the following:

| | |
|---------------------------|---|
| Remove one name or number | Press and hold the name or number, and then tap Delete from call history . |
| Clear the entire list | Press  , and then tap Remove call history . Tap Select all > Delete . |

Using Home dialing

When you're on a trip abroad, it's easy to dial friends and family from home. Your home country code is automatically added when you make calls to your contacts on HTC Explorer while roaming.

 HTC Explorer dials normally when entering phone numbers that are not saved in People. If you want to call an unsaved phone number in your country, you still need to enter a plus (+) sign and country code before the phone number.

1. On the Home screen, tap .
2. Begin entering the first few digits of a phone number or characters of a contact name on the phone keypad.
3. Tap a phone number or contact from the contact list. HTC Explorer then dials the number with your home country code.

Changing the default country code for Home dialing

1. From the Home screen, press , and then tap **Settings**.
2. Tap **Call > Phone settings > Home dialing settings**.
3. Choose the country that you want from the country code dropdown list.
4. Tap **OK**.

Turning off Home dialing

If you prefer to manually enter complete phone numbers to call while roaming, you can turn off Home dialing.

1. From the Home screen, press , and then tap **Settings > Call > Phone settings**.
2. Clear the **Home dialing** check box.

Call services

HTC Explorer can directly link to the mobile phone network, and enable you to access and change the settings of various phone services. Call services may include call forwarding, call waiting, voicemail, and more. Contact your mobile operator to find out about the availability of call services.

To open call services, press  from the Home screen, and then tap **Settings > Call**.

| | |
|-------------------------------------|---|
| Fixed Dialing Numbers | Restrict outgoing calls to a fixed set of numbers. To enable this feature, you must know your SIM card's PIN2 code. |
| Voicemail service | Shows the current voicemail service being used. |
| Voicemail settings | Specify another voicemail number aside from the one specified by your service provider. |
| Clear voicemail notification | If you have a notification of a new voicemail, you can clear the notification with this option. |
| Phone settings | Modify your phone settings such as automatic saving of an unknown contact number when a call with that number ends. |
| Call forwarding | Select how you want to handle busy, unanswered, and unreachable calls. You can also set the call forwarding option for all incoming calls. |
| Call barring settings | Choose whether to block various categories of incoming and outgoing calls. |
| Additional settings | Enable or disable operator services such as caller ID and call waiting. |
| Cell broadcast | Enable or disable receipt of cell broadcast messages. |
| Cell broadcast settings | Configure channels and language for cell broadcast messages. |
| Accounts | Add, modify, or remove Internet calling accounts. You can also choose whether to receive incoming Internet calls. |
| Use Internet calling | Select whether to use Internet calling for all calls you make or for Internet address calls only, or to be asked which you prefer for each call you make. |

Turning Airplane mode on or off

In many countries, you are required by law to turn off wireless devices while on board an aircraft. A way to turn off wireless functions quickly is to switch HTC Explorer to Airplane mode.

When you enable Airplane mode, all wireless radios on HTC Explorer are turned off, including the call function, data services, Bluetooth, and Wi-Fi. When you disable Airplane mode, the call function is turned back on and the previous state of Bluetooth and Wi-Fi is restored.

To turn Airplane mode on or off, press and hold POWER, and then tap **Airplane mode**.

When enabled, the Airplane mode icon  is displayed in the status bar.

HTC Confidential 2011/09/16

Search and Web browser

Searching HTC Explorer and the Web

You can search for information on HTC Explorer and on the Web by using Google Search. Some applications, such as People or Mail, have their own search function, which you can use to search only within those applications.





Setting search options

1. From the Home screen, press , and then tap **Settings**.
2. Tap **Search > Google search**.
3. Choose the settings that you want.

| | |
|-----------------------------|---|
| Show web suggestions | Display suggestions for Google web searches below the search box as you type. |
| Use My Location | Include your location in searches to get local search results. |
| Search history | Use suggestions from the web-based Google search history, from your Google Account. Tap Manage search history to view or manage the web search history associated with your Google Account on the web browser. |



4. Press .
5. Tap **Searchable items**, and then select the items you want included when doing a search.

Performing searches on the web and HTC Explorer

1. From the Home screen, press .
2. Enter the search item in the search box. As you type, matching items on HTC Explorer and suggestions from Google web search are shown as a list.
3. Do one of the following
 - To narrow your search, tap , select another search location (for example, **Apps**), and then tap .
 - If what you're searching for is in the list of suggestions, tap it in the list. The item opens in the appropriate application.
 - To edit an item in the list, tap . The item will appear in the search box, where you can edit it.
 - If what you're searching for is not in the list, tap  to search the web. The web browser opens, displaying the results of a Google search.

Quickly looking up information on the Web



Quick Lookup helps you learn about something right on the spot. When you enter a new word or phrase, you can easily look it up in popular websites or search services such as Google Search and Wikipedia.

1. From the Home screen, tap  > Quick Lookup.
2. If the onscreen keyboard is open, press  to close it first so you'll see the bottom tabs.
3. Slide across the tabs to pick where you want to look up information. Then in the search box, enter what you want to search for.
4. Tap .



After looking up the item on one tab, you can slide to other tabs to automatically look up the same term there.

Translating words to other languages

1. From the Home screen, tap  > Quick Lookup.
2. If the onscreen keyboard is open, press  to close it first so you'll see the bottom tabs.
3. Slide to the Google Translate tab.
4. Under From language, choose the original language, then enter the word or phrase you want to translate.
5. Under To language, choose from the languages available for translation.
6. Tap Translate.

Using the web browser

Do one of the following to open the web browser and start surfing the Web:

- On the Home screen, tap Internet.
- From the Home screen, tap  > Internet.

Going to a webpage

1. On the browser screen, tap the URL box on top of the screen.
2. Enter the webpage address using the keyboard. As you enter the address, matching webpage addresses will appear on the screen.
3. Do one of the following:
 - Tap an address to go directly to that webpage.
 - Continue typing in the webpage address, then tap .

Changing the screen orientation

Turn HTC Explorer sideways to display the web browser in landscape orientation.



If the screen orientation doesn't change automatically, turn on automatic screen orientation. From the Home screen, press , tap **Settings > Display**, and then select the **Auto-rotate screen** check box.

Navigating and zooming on a webpage

- You can swipe your finger on the screen to navigate and view other areas of the webpage.
- Tap the screen twice quickly to zoom in, then tap the screen twice quickly again to zoom out. You can also use your fingers to spread or pinch the screen to zoom in and out.

Selecting a link on a webpage

You can tap a link to open it, or press and hold a link for more options.

| Link | What to do |
|------------------------|--|
| Webpage address (URLs) | <ul style="list-style-type: none"> ▪ Tap the link to open the webpage. ▪ Press and hold the link to open a menu that allows you to open, bookmark, copy to the clipboard, or share the link. |
| Email address | <ul style="list-style-type: none"> ▪ Tap to send an email message to the email address. ▪ Press and hold, then tap Copy on the menu to copy the email address to the clipboard. You can paste the email address later when creating a new contact or sending a new email message. |



Selecting an address or phone number on a webpage

On a webpage, you can:

- Tap an address to view the location on a map.
- Tap a phone number to call.

Opening a new browser window

Open multiple browser windows to make it easier for you to switch from one website to another.

1. While viewing a webpage, press  and then tap **Windows**.
2. Tap .

A new browser window opens.

Switching between browser windows

1. While viewing a webpage, do one of the following:
 - Press  and then tap **Windows**.
 - Pinch the screen (zoom out) until you see the other browser windows.
2. Slide your finger until the webpage you want to view appears.



3. Tap a webpage to display it in full screen.



Tap  to close a webpage.

Downloading from the Web

Do more than just browsing the Web. You can download files such as photos and music as well as apps using the web browser.



Before downloading an app, check first its compatibility with HTC Explorer to make sure it can be installed.

Downloading apps from the Web

You can download apps directly from your favorite websites. Apps downloaded from the Web can be from unknown sources. To protect HTC Explorer and your personal data, we strongly recommend that you download and install only apps you trust.

1. Open your web browser, then go to the website where you can download the app you want.
2. Follow the website's instructions for downloading the app.

Before you can install the downloaded app, you need to set HTC Explorer to allow installation of third-party apps. From the Home screen, press , then tap **Settings** > **Applications** > **Unknown sources**.

Viewing your downloads

While viewing a webpage, press  and then tap **More > Downloads**.



Viewing bookmarks and previously visited pages

You can store as many bookmarks as you want on HTC Explorer. You can also access a convenient list of the sites you have visited, or quickly view the pages that you access most often.

Bookmarking a webpage

1. While viewing a webpage, press , and then tap **Add > Add bookmark**.
2. To bookmark the web page under a certain category (such as sports or dining), tap **Add tags** and enter a tag name. This groups similar web pages so you can easily locate them.
3. Edit the bookmark name if needed, and then tap **Done**.



Opening a bookmark

1. While viewing a webpage, press , and then tap **Bookmarks**.
2. Do one of the following:
 - On the Bookmarks tab , navigate to the bookmark you want to open, and then tap it.
 - On the Tags tab , open a tag group, navigate to the bookmark you want to open, and then tap it.



Editing a bookmark

1. While viewing a webpage, press , and then tap **Bookmarks**.
2. On the Bookmarks tab , press  and then tap **Edit**.
3. Tap  at the right of the bookmark you want to edit.
4. Enter your changes, and then tap **Done**.



Viewing a previously visited page

1. While viewing a webpage, press , and then tap **Bookmarks**.
2. On the History tab , navigate to the page you want to view and then tap the page.



Clearing the list of previously visited pages

1. While viewing a webpage, press , and then tap **Bookmarks**.
2. On the History tab , press , and then tap **Clear history**.





Viewing a page that you often visit

1. While viewing a webpage, press , and then tap **Bookmarks**.
2. On the Most visited tab , navigate to the page you want to view, and then tap the page.

Clearing the list of most visited pages

1. While viewing a webpage, press , and then tap **Bookmarks**.
2. On the Most visited tab , press , and then tap **Clear all**.

Changing the view of bookmarks or most visited pages

1. While viewing a webpage, press , and then tap **Bookmarks**.
2. On the Bookmarks tab  or the Most visited tab , press , and then tap **Thumbnails**, **List**, or **Grid** to change the view.

For example, if you are in Thumbnails view and you want to view bookmarks in a grid, press  and tap **List**, then press  and tap **Grid**.

Setting browser options

Customize the web browser to suit your browsing style. Set display, privacy, and security options when using the web browser.

From the browser screen, press , and then tap **More > Settings**.

Setting your home page

1. From the browser screen, press , and then tap **More > Settings > Set home page**.
2. Select the home page you want to use.

Browsing full versions of all websites

Some websites display a mobile version of their pages on phone web browsers. You can choose to view the full version of all pages, even for these sites.

From the browser screen, press , tap **More > Settings**, and then clear the **Mobile view** check box.

Choosing when to show Adobe Flash content

Choose which Adobe® Flash® content you want to see on a webpage, and when you want to view it.

1. From the browser screen, press , and then tap **More > Settings > Enable plugins**.
2. Tap **On demand**.

After selecting **On demand**, you can show the Adobe Flash content by tapping  on the webpage.

HTC Confidential 2011/09/16

Accounts and sync

About online accounts

HTC Explorer can sync with your Facebook and email accounts.

The information you can get includes:

- Gmail, Exchange ActiveSync, and other POP3/IMAP email.
- Google and Exchange ActiveSync contacts, as well as your friends' contact information in Facebook.
- Calendar events from your Google Account(s), from Exchange ActiveSync, and from your Facebook account.
- Status updates and links shared by your friends and yourself on Facebook.
- Facebook photo uploads.



You can set up your Exchange ActiveSync and POP3/IMAP email accounts on HTC Explorer either in the Mail app or the Accounts & sync settings.

Synchronizing with a Google Account

Signing in to your Google Account lets you sync Gmail and your Google contacts and calendars between HTC Explorer and the Web. You also need to sign in to a Google Account to use Google apps such as Google Talk and Android Market.



If you skipped adding a Google Account when you first set up HTC Explorer, you may encounter problems when using some Google apps. If these problems persist, you may need to factory reset HTC Explorer and enter your Google Account details when you set up HTC Explorer again.

Adding more Google Accounts

You can add more than one Google Account. However, subsequent Google Accounts can only sync contacts, emails, and calendar events. Other Google services use the first Google Account you added.

1. From the Home screen, press , and then tap **Settings > Accounts & sync**.
2. Tap **Add account > Google**.
3. Follow the onscreen instructions to sign in to an account or create a new account.

Forgot your Google Account password?

If you have forgotten your Google Account password, you can try to recover it by going to the Google website.

1. On HTC Explorer or on your computer, open your web browser and go to <https://www.google.com/accounts/ForgotPasswd>.
2. Enter the email address or username that you use to sign in to your Google Account and click **Submit**.
3. Follow the instructions on the screen to reset your password.

If you don't have an alternate email address or cannot access the email account you used to create your Google Account, you can reset your Google Account after 24 hours by answering the security question for password recovery.

Adding a social network account

If you skipped signing in to your social network account (such as Facebook) when you first turned on and set up HTC Explorer, you can still add the account in the settings.

1. From the Home screen, press , and then tap **Settings > Accounts & sync**.
2. Tap **Add account**, and then tap the account type you want to add.
3. Follow the onscreen instructions to enter the account information.

Your social network account is then added to the list on the Accounts & sync screen. Depending on how you configured the account, the new information may start synchronizing with HTC Explorer.

Managing your online accounts

Changing general sync settings

1. From the Home screen, press , and then tap **Settings > Accounts & sync**.
2. Select or clear the following:

| | |
|------------------------|---|
| Background data | If this is selected, apps can send and receive online account information even if you are not currently using them. |
| Auto-sync | If this is selected, apps can use the sync schedule defined in the account settings. If this is cleared, you will need to sync accounts manually. |

Synchronizing an account manually

1. From the Home screen, press , and then tap **Settings > Accounts & sync**.
2. Tap the account that you want to sync.
3. Tap **Sync now**.

Changing account settings

You can change settings such as the sync frequency and the types of information synchronized, the kinds of notification you receive, and the way that account information is displayed.

1. From the Home screen, press , and then tap **Settings > Accounts & sync**.
2. On the Accounts & sync screen, tap the account that you want to edit.
3. Tap the type of information you want to sync or select an item to edit its settings.

Removing an account

You can remove an account to delete it and all information associated with it from HTC Explorer, for example email, contacts, or settings. Removing an account does not delete information from the online service itself.



You cannot remove some accounts, such as the first Google account you signed into, except by deleting all personal information from HTC Explorer with a hard reset.

1. From the Home screen, press , and then tap **Settings > Accounts & sync**.
2. Tap the account that you want to remove.
3. Tap **Remove account**, and then confirm that you want to remove the account.

People

Transferring contacts from your old phone

Easily transfer contacts from your old phone to HTC Explorer through Bluetooth. Depending on your old phone's model, you may also transfer other types of data such as calendar events and text messages to HTC Explorer.





1. From the Home screen, tap  > **Transfer**.
2. Tap **Next** to begin.
3. Choose your old phone's name and model.
4. On your old phone, turn Bluetooth on and set it to discoverable mode.
5. On HTC Explorer, tap **Next** to continue. HTC Explorer automatically turns Bluetooth on and searches for Bluetooth devices.
6. From the device list, choose your old phone and then tap **Next**. HTC Explorer then tries to pair with your old phone. You'll see a security passkey on the screen.
7. On your old phone, enter this passkey or simply confirm it.
8. Select the **Contacts** check box (and other supported types of data you want to import), and then tap **Next**.
9. When HTC Explorer finishes importing data, tap **Done**.

About the People app

With the People app, easily manage your communications with your contacts via phone, messaging, and email. You can also link your contacts to their social network account such as Facebook to see their updates and events from the account all in one place.

And that's not all. If you have the same contacts from different sources, People lets you merge their contact information so you won't have duplicate entries in your contacts list.

1. From the Home screen, tap  > People.
2. Tap one of the following tabs:

| | |
|---|--|
|  | Phone Launches the Phone dialer screen. |
|  | People Gives you access to all contacts on HTC Explorer, online accounts, and more. |
|  | Groups Lets you assign contacts to groups so you can easily send an SMS, MMS, or email message to a whole group. |
|  | Call History Lists all your dialed numbers and received and missed calls. |



Your contacts list

The People app lists all contacts stored on HTC Explorer and from the online accounts you're logged in to. When you open People after you've just logged in to a new account, you'll be asked whether to add contacts from that account to your contacts list.

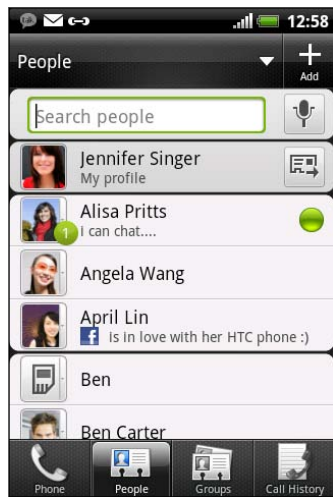
Your contacts list also displays the contacts stored on your SIM card (usually marked with the SIM card icon ).







You can:

- Open your profile and edit your own contact information.
- Create, edit, or find contacts.
- See status updates from friends in your social network account such as Facebook.
- Tap a contact's name to open the contact details screen for that contact.
- See a notification icon such as  when a contact has sent you new messages or when it's the contact's birthday.
- Check out who's online in Google Talk. Online status icons are displayed if you're signed in to Google Talk on HTC Explorer. For example,  means the contact is available to chat.



Filtering your contacts list

You can choose to only display contacts from particular account types (for example, Google contacts or Facebook contacts).

1. From the Home screen, tap  > People.
2. On the People tab, tap  on the top bar to show a list of your online accounts.
3. Choose the online accounts that contain the contacts you want to display in your contacts list, and then press  to save your selection.
4. To set more options on sorting your contacts, press  and then tap **Settings**.



Setting up your profile

Store your personal contact information to easily send it to other people.

1. From the Home screen, tap  > **People**.
2. Do one of the following:
 - If you're logged in to any of your online accounts such as your Google Account or Facebook for HTC Sense, tap your name or email address, and then tap **Edit my contact card**.
 - If you're not logged in to your online accounts, tap **Me**, and then choose whether to link your profile to an existing contact entry that already contains your personal information or edit your profile.
3. Enter or edit your name and contact details.
4. Tap  or your photo, and then choose whether to take your self-portrait or use another photo for your profile.
5. Tap **Save**.



What you can see on your profile

When you tap **My profile**, you'll see the following tabs:

| | |
|---|---|
|  | <p>Details</p> <p>Shows your own contact details. You'll also see your most recent posts in your social network (such as Facebook if you're signed in to Facebook for HTC Sense).</p> <p>From this tab, you can edit your profile or share it with others.</p> |
|  | <p>Updates and events</p> <p>Shows the updates and events that you've posted in your social network .</p> |
|  | <p>Gallery</p> <p>Shows your Facebook albums and photos.</p> |



Importing contacts from your SIM card

When you import SIM contacts, you can either store them on HTC Explorer or add them to your Google contacts or Exchange ActiveSync contacts, if you have set up the relevant accounts.

1. From the Home screen, tap  > **People**.
2. Press , and then tap **Import/Export** > **Import from SIM card**.
3. If you have Google or Exchange ActiveSync accounts set up on HTC Explorer, tap the type for the imported contacts.

4. Do one of the following:
 - Tap one or more SIM contacts you want to import.
 - To import all contacts, tap **Select all**.
5. Tap **Save**.

Adding a new contact

1. From the Home screen, tap  > **People**.
2. Tap .
3. Tap the **Name** field, and then enter the contact name.



Tap  if you want to separately enter the contact's first, middle, and last name. Depending on the contact type, you may also be able to add a name prefix (such as Mr. or Ms.) or a name suffix (such as Ph.D., Jr, or Sr).

4. Select the Contact type, for example Google or Exchange ActiveSync. This determines which account the contact will sync with.





Some fields may not be available when you're adding contacts to your SIM card.

5. Enter the contact information in the fields provided.

Press  if you want to close the onscreen keyboard first and easily scroll through the other fields.
6. Tap **Save**.

Searching for contacts

In addition to searching contacts by name or email address, you can set the People app to search by other criteria such as by their group name or company.



1. From the Home screen, tap  > **People**.
2. Press , and then tap **Settings** > **Search contacts by**.
3. Choose the types of criteria to search for, and then tap **Done**.

When performing your search, simply enter the first few characters of the item you're looking for in the search box. Matching contacts will then be listed.

Importing a contact from an Exchange ActiveSync account

You can search for a work contact from your Exchange ActiveSync account, and then copy it on HTC Explorer.

You need to have your Exchange ActiveSync account set up on HTC Explorer first.

1. From the Home screen, tap  > People.
2. In the search box, enter the first few letters of the contact's name or email address.
3. Tap . Under Company contacts, matching names are listed.
4. Tap the name of the contact you want copied on HTC Explorer, and then tap **Save to People**.

HTC Confidential 2011/09/16

Merging contact information

If you have the same contacts on HTC Explorer, Google Account, and your social network account such as Facebook, HTC Explorer will try to combine them automatically or let you decide which contacts to combine. Combining the same contacts avoids duplicate entries in your contacts list.

Accepting matched contacts suggestions

When HTC Explorer finds contacts that can be merged, you'll see a link icon  in the notifications area of the status bar.

1. Slide the Notifications panel down, and then tap **Matched contacts suggestion**. You'll see a list of suggested contacts to merge.

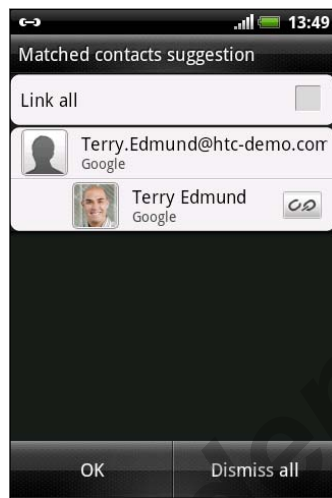



2. To merge, tap .
3. Tap OK.







If you don't want to merge any of your contacts, tap Dismiss all.

Viewing a list of all your linked contacts



1. From the Home screen, tap  > People.
2. Press , and then tap **Linked contacts** (or **More > Linked contacts**). The All linked contacts screen then opens where you can see the account types and information merged.
3. You can choose to break the link of an account type or relink.
4. When you're done, tap OK.

Manually merging contact information



1. From the Home screen, tap  > People.
2. Tap the name of the contact (not the icon or photo) you want to link.

3. Tap  or  (if there are suggested links).
4. You can:
 - Under **Suggest links**, tap  to link the contact to an account.
 - Under **Add contact**, tap one of the options to link to another contact.

Breaking the link



1. From the Home screen, tap  > People.
2. Tap the name of the contact (not the icon or photo) whose link you want to break.
3. Tap .
4. Under the **Linked contacts** section, tap  beside an account type to break the link.

Backing up your contacts to the storage card

1. From the Home screen, tap  > People.
2. Press , and then tap **Import/Export** > **Export to SD card**.
3. Select an account or type of contacts to export, then tap **OK**.

Importing contacts from the storage card

You can only import contacts that were exported to the storage card using the **Export to SD card** feature.

1. From the Home screen, tap  > People.
2. Press , and then tap **Import/Export** > **Import from SD card**.
3. If you have Google or Exchange ActiveSync accounts set up on HTC Explorer, tap the type for the imported contacts.

Contact information and conversations

When you tap a contact on the People screen, the contact details screen opens, showing you the information you've stored or linked for that contact.

The contact details screen has the following tabs:



Details

Shows the information you have stored for the contact. Get in touch with the contact directly by tapping any of the displayed methods. For example, if the contact has a stored work phone number, tap **Call work**.



Thread

Shows SMS messages and emails you've received from the contact. It also lists all your incoming, outgoing, and missed calls to and from the contact.

From this tab, you can reply to a message, send an email, or call the contact.



Updates

Shows the contact's updates and events from your social network account (for example, Facebook).

If you see a notification of the contact's birthday under the Events section, you can tap the notification and choose how you want to greet your contact, such as to write on the person's Facebook wall.



Gallery

Shows the linked contact's Facebook albums and photos.

Editing a contact's information

1. From the Home screen, tap > **People**.
2. Press and hold the contact, and then tap **Edit contact**.



The contact details of your Facebook contacts cannot be edited.

3. Enter the new information for the contact.
4. Tap **Save**.

Deleting contacts

1. From the Home screen, tap > **People**.
2. Press , and then tap **Delete**.
3. Select the contacts you want to remove, and then tap **Delete**.
4. When prompted, tap **OK**.

Sending contact information as a vCard

Easily share with others your own contact information or any contact from HTC Explorer.



1. From the Home screen, tap  > People.
2. Do the any of the following:

| To send | Do this |
|-------------------------------|--|
| Someone's contact information | Press and hold the name of the contact (not the icon or photo) whose contact information you want to send, and then tap Send contact as vCard . |
| Your contact information | Press and hold My profile , and then tap Send my profile . |

3. From the available options, choose how you want to send the vCard.
4. Select the type of information you want to send, and then tap **Send**.

Sending multiple contact cards

Easily share with others the contact information of several contacts from your HTC Explorer.

1. From the Home screen, tap  > People.
2. Press , and then tap **Send contacts**.
3. Select the contacts whose contact information you want to share, and then tap **Send**.



If you can't see the **Send** button while the onscreen keyboard is open, press  to close the keyboard.



4. Choose how you want to send the contact cards:

| | |
|------------------|---|
| Bluetooth | Tap Scan for devices , and then tap the device to which you want to send the contact cards. Follow the onscreen messages on HTC Explorer and the other device to pair them and send the files. |
| Mail | Compose and send your email message, with the contact cards attached. |

Contact groups

Assign contacts to groups so you can easily send a message or email to a whole group. You can also sync groups on HTC Explorer with the groups in your Google account, accessible via your computer's web browser. We've also added the Frequent group as a special group type that automatically stores the contacts you dial or get calls from the most.

Creating a group



1. From the Home screen, tap  > People.
2. On the Groups tab, tap .
3. Enter a name for the group, and then tap .
4. Select the contacts you want to add to the group, and then tap **Save**.



If your contacts list is long, you can use the search bar to search for contacts quickly, or press  to hide the onscreen keyboard and scroll through the list.

5. Tap  to select a photo for the group.
6. Tap **Save**.

Editing a contact group

1. From the Home screen, tap  > People.
2. On the Group tab, press and hold the group, and then tap **Edit group**.
3. You can:
 - Tap the group name to change the name. You can only change the name for groups that you have created.
 - Tap the icon to the left of the group name to change or remove the group photo.
 - To add contacts to the group, tap , select the contacts you want to add, and then tap **Save**.
 - To remove a contact from the group, tap the box beside the contact name.
4. Tap **Save**.

Sending a message or email to a group



You will be charged for each message sent. For example, if you send a message to a group of five people, you will be charged for five messages.

1. From the Home screen, tap > People.
2. On the Groups tab, tap the group you want to send a message or email to.
3. Go to the Group action tab, and then do one of the following:
 - Tap **Send group message** to send a message to the group.
 - Tap **Send group mail** to send an email to the group.

Rearranging your contact groups

1. From the Home screen, tap > People.
2. On the Groups tab, press , and then tap **Edit group**.
3. Press and hold at the end of the group you want to move. When the row is highlighted, drag it to its new position.



4. Tap **Save**.



Rearranging the members of a contact group

1. From the Home screen, tap > People.
2. On the Groups tab, tap the group to see its members.
3. Press , and then tap **Edit group**.
4. Press and hold at the end of the contact's name you want to move. When the row is highlighted, drag it to its new position.
5. Tap **Save**.

Deleting groups



You can only delete groups that you have created.

1. From the Home screen, tap  > People.
2. On the Groups tab, you can:
 - Press and hold a group you want to delete, and then tap **Delete group**.
 - Press  and then tap **Edit groups** to choose several contact groups to remove.

Adding People widgets

Stay in touch with different circles of friends or colleagues in your life. You can add several People widgets on the Home screen, with a different group of contacts on each widget.



1. From the Home screen, press  and then tap **Personalize**.
2. On the Add to home tab, tap **Widget** > **People**.
3. Choose the widget style, and then tap **Select**.
4. Select the group you want to add as a widget.
5. Repeat the above steps to add another People widget.

Setting the default communication method

Depending on how you often reach your contacts, you can choose a different communication method for each of the contacts on the People widget.

1. On the Home screen, go to the People widget.
2. Tap a contact's name or status update (not the photo) on the widget to open the person's contact details screen.

3. Tap **Set default action**, and then tap the communication method you want for the contact.
4. Press  to return to the People widget on the Home screen.

Changing the default communication method

1. On the Home screen, go to the People widget.
2. Tap a contact's name or status update on the widget to open the person's contact details screen.
3. Tap **Set default action**.
4. On the Select default action screen, tap the communication method you want for the contact.
5. Press  to return to the People widget on the Home screen.

Getting in touch with a contact

1. On the Home screen, go to the People widget.
2. Tap a contact's photo (not the name or status update) on the widget. The default communication method you've set for this contact will be performed.





On the People widget:

- Tap a contact's name or status update to open the contact details screen for that contact.
- Tap  to open the People app and view all your contacts.

Adding group members to a People widget

You can add more members to the contact group that's on a People widget.

- To add just one member, tap .
- To add several members, tap .

Social

Facebook for HTC Sense

With Facebook for HTC Sense, you can:

- See all your Facebook contacts and their instant status updates in People.

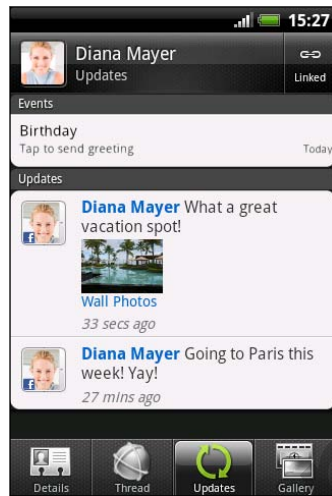

When you tap a contact in People, slide to the Updates tab to see updates such as posted status messages, uploads, and profile changes.

When there is a notification of the contact's birthday, you can tap the notification to send a greeting.

- See Facebook photos right on the Gallery app.



You can also upload one or more photos to Facebook, then tag and add captions that go with it.

When you're viewing the albums of a Facebook friend, you can also share a link to a particular album, or comment on the album photos.

- Check your friends' Facebook status updates in Friend Stream™.
- View your Facebook events and your friends' birthdays on the Calendar app.



- Signing in to your Facebook account from the Accounts & sync settings or the Facebook app (preinstalled or downloaded from Android Market) automatically signs you in to Facebook for HTC Sense.
- You may need to authorize Facebook for HTC Sense to connect to your Facebook account.

Enjoying Facebook in Friend Stream

Post your status updates, write messages on your friends' Facebook walls, or share your location with your social network.

Posting a message on a friend's Facebook wall

Quickly write a wall post to your Facebook friends in Friend Stream.

1. In Friend Stream, tap > Facebook.
2. Tap > My wall, and then tap a friend from the list.
3. Enter your message.
4. Tap to attach a photo.
5. Tap Post.

Commenting on and liking Facebook posts

Tap someone's status update on the All updates tab, and do any of the following:

- Tap a photo or the album name shown in the status update to view and comment on the album photos using the Gallery app.
- Tap Like to like the person's status update.
- Tap the text box, and then enter what you think about the person's status update.

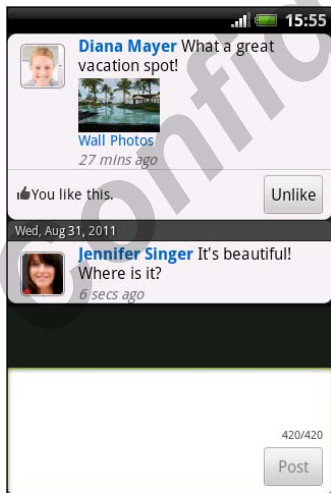

Sharing your location with your Facebook friends

Eating out in your fave restaurant? Tell your friends where you are and invite them along.



- You must be signed in to Facebook for HTC Sense to use this feature in Friend Stream.
- In order to find your location, you also need to enable location sources in **Settings > Location**.

1. Go to the Locations tab, and then tap
2. Do any of the following:
 - Tap a place from the list.
 - Tap , type in your current location name and description, and then tap **Done**.
3. Tap **Check in**.
4. On the next screen, you can add your status message and even tag the friends you're with.
5. When done, tap **Check in**.

Chatting in Google Talk

Google Talk is Google's instant messaging program. It lets you communicate with other people that also use Google Talk. If you signed in to your Google Account when you first set up HTC Explorer, you are already signed in to Google Talk.

To open Google Talk, on the Home screen tap > **Talk**.

Chatting with a friend

1. In Google Talk, tap a friend in the Friends list.
2. Enter your message in the text box. You can also insert a smiley by pressing , and then tapping **More > Insert smiley**.
3. Tap **Send**.
4. While chatting, press and then tap any of these options:

| | |
|------------------------|---|
| Chat off record | Your Google Talk messages are stored in the Chats folder of your Gmail account. Tap this option if you don't want to store your chat messages. |
| Switch chats | If you have more than one chat going, tap to switch chat with another friend. |
| Friends list | Return to the Friends list. |

| | |
|--------------------|--|
| Add to chat | Add another friend to your chat. The friend you invited and the friend you're currently chatting will receive an invitation to a group chat. Each one who accepts the invitation joins the group chat. |
| End chat | End your current chat. |
| More | Clear the chat history, insert a smiley or view your friend's contact details. |

Accepting a chat invitation

When a friend sends you a Google Talk message, you receive a notification. Their entry in the Friends list displays the message.

Do one of the following:

- In the Friends list, tap the friend who sent you the invitation to chat.
- Open the Notifications panel, and then tap the chat notification.

Changing your online status and picture







1. In Google Talk's Friends list, tap your name to open the Set Status screen.
2. Enter your new status message. Or press  to choose a custom status from the list.
3. Tap the online status beside your picture, and then select the status you want on the menu.
4. Tap your picture, and then do one of the following:
 - Tap **Remove** to remove your photo.
 - Tap **Change** to select another picture.
5. Tap **Done**.

Your online status, message, and picture appear in your contacts' Friends list and in other apps where your Google Talk status are displayed.

Adding and managing friends

The Friends list is where you add and manage your friends in Google Talk.

In Google Talk's Friends list, you can:

| | |
|---------------------------------|--|
| Invite a friend | <ol style="list-style-type: none"> 1. Press , and then tap Add friend. 2. Enter the Google Talk instant messaging ID or Gmail address of the friend you want to add. 3. Tap Send invitation. |
| View all friends | Initially, only those friends that you often chat with — the most popular — are shown in the Friends list. To view all your friends, press  , and then tap All friends . To view only friends that you often chat with, press  , and then tap Most popular . |
| Make a friend popular | <ol style="list-style-type: none"> 1. Press , and then tap All friends. 2. Press and hold a friend's name, and then tap Always show friend. |
| Block a friend | <p>You can block a friend from sending you messages. When blocked, your friend is removed from the Friends list and is added to the Blocked friends list.</p> <ol style="list-style-type: none"> 1. Press , and then tap All friends. 2. Press and hold a friend's name, and then tap Block friend. |
| Unblock a friend | <ol style="list-style-type: none"> 1. Press , and then tap More > Blocked. 2. Tap the friend you want to unblock and then tap OK. |
| View all invited friends | Press  , and then tap More > Invites . Friends who have not yet accepted your invitation are listed on the screen. |

Changing settings or signing out



In Google Talk's Friends list, press  and then tap:

- **Settings** to change the app and notification settings.
- **Sign out** to sign out.

Camera

Camera basics





Whether traveling for business or fun, enjoy taking photos and videos of your trip and encounters with HTC Explorer.

- To open the camera in photo mode and take photos, tap  from the Home screen, and then tap **Camera**.
- To open the camera directly in video mode so you can immediately start capturing videos, tap  from the Home screen, and then tap **Camcorder**.

Viewfinder screen

You'll find the following onscreen controls on the Viewfinder screen:



| | |
|---|-------------------------------|
|  | Zoom bar |
|  | Photo/Video mode switch |
|  | Shutter release/Record button |
|  | Effects button |
|  | Gallery button |

Zooming

Before taking a photo or video, you can first use the onscreen zoom bar to zoom in or out of your subject.



Simply slide your finger up or down the zoom bar to zoom in or out.



When you're recording video, the zoom bar is always shown onscreen. You can freely zoom in or out while recording.



Taking your closeup shot

Having a hard time taking your own closeup shot? With the camera, it's easy. Just set it to automatically take your self portrait. You won't even need to tap the shutter release button.



1. Press  to open the settings menu panel.
2. Tap Self-portrait.
3. Press  to close the settings menu panel.
4. Turn the camera to face you.

Once the camera detects your face, it automatically focuses and takes your photo.

Taking a photo

1. From the Home screen, tap  > Camera.
2. Before taking the photo, you can zoom in or out first on your subject.
3. Choose the resolution and other camera settings you want to use.
4. Choose an effect to apply to your photo.
5. Point the camera and focus on your subject.
6. When you're ready to take the photo, tap .
7. Choose what you want to do with the photo you've just taken.

Recording video

1. From the Home screen, tap  > Camcorder.
2. Choose the video quality and other camera settings you want to use.
3. Choose an effect to apply to your video.
4. Frame your subject on the Viewfinder screen.
5. Tap  to start recording.
6. You can freely zoom in or out while recording video.
7. To stop recording, tap  again.
8. Choose what you want to do with the video you've just recorded.

Adding effects





Want to make your photos look more interesting? Easy. Use the available camera effects to make your photos look like they've been taken through special lenses and filters. You can also add certain effects to videos.

Choose an effect first before you start taking a photo or video.

1. Tap .
2. Scroll through the available effects and tap one that you like.

After capturing

After capturing a photo or video, the Review screen will display the photo or the starting image of the video that you have just captured. Tap the onscreen buttons to choose what you want to do next.

| | |
|---|--|
|  | Delete the photo or video |
|  | Send the photo or video to your computer or another device using Bluetooth, send it by email, or select a social network where you want to upload it to. |
|  | Choose how you want to use the photo, such as by setting it as your wallpaper. |
|  | Watch the video. |

Changing camera settings

Open the menu panel to access and change camera settings.

To open the camera settings, press .

| | |
|-------------------------------------|---|
| Self-portrait (photo mode only) | Select this option to take your own closeup shot. |
| Self-timer (photo mode only) | Set a time delay before your camera automatically takes the photo. |
| Image adjustments | Slide your finger across each of the slider bars to adjust the exposure, contrast, saturation, and sharpness. |
| White balance | White balance enables the camera to capture colors more accurately by adjusting to your current lighting environment. |
| Resolution/Video quality | Choose a photo or video resolution to use. |
| ISO (photo mode only) | Choose an ISO level or set it back to Auto. Higher ISO numbers are better for taking pictures in low light conditions. |
| Review duration | Set the time for a captured photo or video to be displayed on the Review screen before the camera changes back to the Viewfinder screen. |
| Widescreen (photo mode only) | When this check box is selected (default), photo resolutions available for selection are in 3:2 ratio and you can use the entire Viewfinder screen to frame your subject. When not selected, photo resolutions available for selection are in standard 4:3 ratio. |
| Geo-tag photos (photo mode only) | Select to store GPS location in your captured photos. |
| Auto enhance (photo mode only) | Select to reduce noise when using a high ISO setting and to automatically adjust photo brightness. |
| Shutter sound | Select to play a sound when you press the shutter release or record button. |
| Grid (photo mode only) | Select to display a grid on the Viewfinder screen so you can easily frame and center your subject before taking the photo. |
| Record with audio (video mode only) | Select to record audio when capturing videos. |
| Reset to default | Change the camera settings back to default. |

Photos, videos, and music

Gallery

About the Gallery app

Relive the fun while viewing photos and videos of your latest travels or your pet's newest tricks. Get an audience by tagging your Facebook friends.

✎ To start using Gallery, check first if you have photos or videos copied on HTC Explorer.

What's more, you can edit and add effects to your photos. You can also easily use a photo as your contact icon, location icon, or wallpaper.

Selecting an album

From the Home screen, tap  > **Gallery**. The Gallery app opens on the Albums screen where your photos and videos are organized by albums for easy viewing.



Viewing photos and videos

After you've selected an album, you can browse through your photos and videos.

Slide your finger up or down to scroll through the thumbnails. Tap a photo or video to view it in full screen.

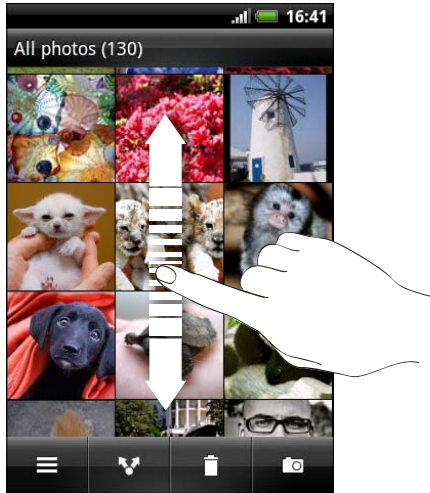

While viewing a photo in full screen, you can press , and then tap **Show on map** to see the location where you took the photo. (**Show on map** is available when you've enabled **Geo-tag photos** in Camera.)

Zooming in or out on a photo

There are two ways you can zoom in or out of a photo.

- Tap the screen twice quickly to zoom in, then tap the screen twice quickly again to zoom out.
- Press your thumb and index finger on the screen and then spread your fingers apart to zoom in; pinch your fingers together to zoom out.

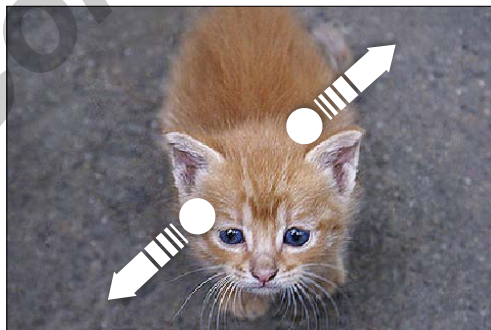

Viewing photos as a slideshow

1. Select an album that has the photos you want to view as a slideshow.
2. Tap Slideshow.



Tap the screen to show the playback controls.

Watching videos

While browsing an album, tap a video to play it.



Another way to easily get to your videos is to tap  from the Homescreen, and then tap **Videos**.

- Use the onscreen controls to play, pause, or stop the video.



- Tap **More** > **Full screen** or **More** > **Best fit** to toggle between full and best-fit screens.

Editing your photos

Do basic editing tasks on your photos such as rotate and crop. You can also enhance your photos by applying effects such as high contrast, vintage, and more.

Rotating a photo

- On the Gallery app's Albums screen, tap an album.
- Press and hold on the photo that you want to rotate.
- In the menu that opens, tap **Edit**, and then tap either **Rotate left** or **Rotate right**.

Cropping a photo

- On the Gallery app's Albums screen, tap an album.
- Press and hold on the photo that you want to crop.
- In the menu that opens, tap **Edit**, and then tap **Crop**. You'll see a crop box around the photo.
- To adjust the crop box size, press and hold the edge of the box.



5. When directional arrows appear, drag your finger inward or outward to resize the crop box.
6. To move the crop box to the part of the photo that you want to crop, drag the crop box to the desired position.
7. Tap **Save** to keep the changes.

The cropped photo is saved as a copy. The original photo remains unedited.

Adding effects

1. On the Gallery app's Albums screen, tap an album.
2. Press and hold on the photo that you want to add effects to.
3. In the menu that opens, tap **Edit**, and then tap **Effects**. On the panel that opens, you'll see options available to you.
4. Tap an effect to apply on the photo.
5. Tap **Save** to keep the changes.



The enhanced photo is saved as a copy. The original photo remains unedited.

Sending your photos and videos

Send photos and videos via email or MMS to your computer or another device using Bluetooth.

Sending photos or videos by email



You can send several photos, videos, or both in an email message. They are added as file attachments in your email.

1. From the Home screen, tap  > **Gallery**.
2. Tap the album that has the photos or videos you want to share.
3. Tap  and then tap **Gmail** or **Mail**.
4. Select the photos or videos you want to share and then tap **Next**.
5. Compose your message and then tap  (Gmail) or **Send** (Mail).



If you selected **Mail** and you have multiple email accounts, the default email account will be used.



Sending a photo or video by MMS

1. From the Home screen, tap  > **Gallery**.
2. Tap the album that has the photos or videos you want to share.
3. Tap  and then tap **Messages**.

4. Tap the photo or video you want to send. The photo or video is automatically added into the MMS message.
5. To add another photo or video to your slideshow attachment, tap  and then tap **Picture** or **Video**.
6. Compose your message and then tap **Send**.

Sending photos or videos using Bluetooth

You can select several photos, videos, or both and send them to someone's device or your computer using Bluetooth.

1. From the Home screen, tap  > **Gallery**.
2. Tap the album that has the photos or videos you want to share.
3. Tap  and then tap **Bluetooth**.
4. Select the photos or videos you want to share and then tap **Next**.

In the next few steps, you'll be asked to turn on Bluetooth on HTC Explorer and connect to the receiving Bluetooth device so the files can be sent.

Sharing your photos and videos on the Web

Using the Gallery app, you can share photos and videos on your social networks. And you can post videos on YouTube.





You can also use the Camera or Camcorder app to share a photo or video right after you've captured it.

Sharing photos or videos on Facebook



You need to be logged in to your account to be able to upload photos or videos.



1. From the Home screen, tap  > **Gallery**.
2. Tap the album that has the photos or videos you want to share.
3. Tap  and then tap **Facebook for HTC Sense**.
4. Select the photos or videos you want to share and then tap **Next**.
5. Select which album to upload to and set privacy settings for the uploaded photos or videos.
6. Tap **Add tag and description**, and then enter a different caption on each photo or video.
7. To tag friends on your photos, tap **Tag this photo**. You can then tap the part where your friend is, and then select who you want to tag from the list. Repeat this step to continue tagging friends.

8. Slide to the left to go to the next photo or video. When finished adding tags and descriptions, tap **Done**.
9. Tap **Done**.

Sharing photos on Picasa





You need to be signed in to a Google Account to be able to upload photos to the Picasa™ photo organizing service.

1. From the Home screen, tap  > **Gallery**.
2. Tap the album that has the photos you want to share.
3. Tap  and then tap **Picasa**.
4. Select the photos you want to share and then tap **Next**.
5. Enter a caption for the photos you're uploading.
6. Select the online album where you want to upload the photos, or tap  to create a new album.
7. Tap **Upload**.

Sharing videos on YouTube

You can share your videos by uploading them to YouTube.

1. From the Home screen, tap  > **Gallery**.
2. Tap the album that has the videos you want to share.
3. Tap  and then tap **YouTube**.
4. Select the videos you want to share and then tap **Next**. Sign in to your YouTube or Google Account, if you're asked to do so.
5. Enter a title for the videos you're uploading.
6. Tap **More details** where you can enter information such as description and tags, and select a privacy option.
7. Tap **Upload**.

Viewing photos in your social networks

Right in the Gallery app, check what you and your friends have uploaded to your social networks.

Viewing photos on Facebook

You need to be logged in to your Facebook account to view Facebook photos.

1. From the Home screen, tap  > Gallery.
2. Tap the **Facebook** tab.
3. Tap your account name or your friend's account on the list to view the photos in the account.

You can view photos in your online albums in the same way as you view photos on your storage card.

Commenting on photos in your social networks

Add comments to your uploaded photos as well as your friends' photos.

1. Do one of the following:
 - While browsing online albums, press and hold a photo and then tap **Add comment**.
 - While viewing a photo in full screen, tap anywhere on the screen, and then tap .
2. Tap the box that says "Write a comment."
3. Enter your text, and then tap **Comment**.

HTC Confidential 2011/09/16

Music

Listening to music





Enjoy listening to songs and music on HTC Explorer using the Music app.



You need to copy music files to your storage card first to use the Music app to play music.

1. From the Home screen, tap  > Music. The Music app opens in the Now playing screen.
2. Swipe your finger left or right across the screen to go to the next or previous music album.
3. Tap the onscreen icons to control music playback, select a song to play, repeat songs, and more.



| | |
|---|--|
|  | Turn shuffle on or off. (Shuffle is off when button is gray.) |
|  | Press and drag your finger across the progress bar to jump to any part of the song. |
|  | Go to the library. |
|  | Switch between showing the Now playing list and Now playing screen. You can rearrange songs in the Now playing list. |
|  | Cycle through the repeat modes: repeat all songs, repeat current song, and don't repeat. |

Playing music from the Lock screen

When you're listening to music and the screen turns off, press POWER to turn the screen back on and control the music playback directly on the Lock screen.

If you don't see the playback controls on the Lock screen, swipe your finger from left to right on the box onscreen.



You can also pause music playback right from the Notifications panel.

About the Music widget

You can use the Music widget to play music right from your Home screen.

Browsing music in the library



1. Tap  on the Music app's Now playing screen or Now playing list to go to the library. In the library, your music is organized by categories such as Artists and Albums. Choose a category by tapping one of the tabs at the bottom of the screen.
2. Tap a song in a category to play it. The Now playing list is updated with the song list from your selected category.



You can add, remove, or rearrange the tabs in the library.

Creating a playlist

Personalize your music experience by creating music playlists. Make a playlist containing just your favorite songs or create one to match your mood for the day. You can make as many playlists as you like.

1. From the Home screen, tap  > Music.
2. Tap  to go to the library.
3. In the library, tap or slide your finger on the bottom row to go to the **Playlists** category.
4. Tap .
5. Enter a playlist name, and then tap **Add songs to playlist**.
6. Choose a category.

7. Select the check boxes of songs you want to add to the playlist and then tap **Add**.
8. Tap **Save**.

Playing the songs in a playlist

1. In the library, tap or slide your finger on the bottom row to go to the **Playlists** category.
2. Tap a playlist to open it.
3. Tap the first song or any song in the playlist.

When you tap a song in the list to play it, the Now playing screen is updated with the songs from your playlist.

Managing playlists

After creating a playlist, you can add more songs to it, rearrange their order, and more.

1. In the library, tap or slide your finger on the bottom row to go to the **Playlists** category.
2. Tap a playlist to open it.
3. Press , and then choose what you want to do:



| | |
|------------------------------|---|
| Add more songs to a playlist | <ol style="list-style-type: none"> 1. Tap Add songs. 2. Go to the Songs category or any other category. 3. Select the songs you want to add to the playlist and then tap Add. |
| Rearrange songs | <ol style="list-style-type: none"> 1. Tap Change order. 2. Press and hold  at the end of the song title you want to move. When the row is highlighted, drag it to its new position, then release. |
| Delete songs from a playlist | <ol style="list-style-type: none"> 1. Tap Remove songs. 2. Select the songs you want to delete and then tap Remove. |
| Change playlist name | Tap Rename playlist . |

Deleting playlists

1. In the library, tap or slide your finger on the bottom row to go to the **Playlists** category.
2. Press  and then tap **Delete playlists**.
3. Select the playlists to delete and then tap **Delete**.

Setting a song as a ringtone

You can set a song from the Music app's library as your regular ringtone or as ringtone for a certain contact.

1. From the Home screen, tap  > Music.
2. Browse for the song that you want to set as a ringtone and then play it back.
3. On the Now playing screen, press  and then tap **Set as ringtone** (or **More > Set as ringtone**).
4. In the **Set as ringtone** options menu, tap **Phone ringtone** or **Contact ringtone**. If you select **Contact ringtone**, you need to choose the contacts you want to associate the song with in the next screen.



Checking if the song was added as a ringtone

1. From the Home screen, press , and then tap **Settings**.
2. On the Settings screen, tap **Sound > Phone ringtone**.

The song should be in the ringtone list and selected.

Sharing music using Bluetooth

You can choose a song from the Music app's library and send it to someone's device or your computer using Bluetooth.

1. From the Home screen, tap  > Music.
2. Tap  to go to the library.
3. In the library, choose the song that you want to send via Bluetooth and then play it back.
4. On the Now playing screen, press  and then tap **Share** (or **More > Share**).
5. Tap **Bluetooth**.

In the next few steps, you'll be asked to turn on Bluetooth on HTC Explorer and connect to the receiving Bluetooth device so the music can be sent.

Finding music videos on YouTube

You can find music videos of the song you're listening to on YouTube. It's simple. On the Now playing screen, just press  and then tap **Find videos**.

Android Market and other apps

Finding and installing apps from Android Market

Android Market is the place to go to find new apps for HTC Explorer. Choose from a wide variety of free and paid apps ranging from productivity apps, entertainment, to games.



A Google Checkout™ payment method is required to purchase a paid app. You will be asked to confirm method of payment when you purchase an app.

Finding and installing an app



When you install apps and use them on HTC Explorer, they may require access to your personal information or access to certain functions or settings. Download and install only apps that you trust.



Be cautious when downloading apps that have access to functions or a significant amount of your data on HTC Explorer. You're responsible for the results of using downloaded apps.

You need a Google Checkout™ account to purchase items on Android Market.

1. From the Home screen, tap  > Market.
2. Do any of the following to find an app:

| | |
|---------------------------|--|
| Browse featured apps | Scroll through the list of featured apps. |
| Browse apps by categories | Tap Apps or Games , and then tap a category. Under a category, you can filter the apps by Top paid , Top free or Just in . |
| Search for an app | Press  , enter the name or type of app you're looking for, and then tap  . |

3. When you find the app that you like, tap it and read its description and user reviews.





4. To download or purchase the app, tap **FREE** (for free apps) or the price button under **Buy** (for paid apps).
5. Tap **OK** to accept the permissions for the app and begin downloading and installing the app.



You can uninstall an app for a refund within a limited time after your purchase. To know more about the refund policy for paid apps, please visit the Android Market Help site (<http://market.android.com/support>).



Opening an installed app

Do one of the following:

- If you see this icon  on the status bar, open the Notifications panel, and then tap the app.
- From the Home screen, tap  > **Market**. Press  and then tap **My apps**. On the My apps screen, tap the app, and then tap **Open**.
- From the Home screen, tap . On the All apps screen, slide to the Downloaded tab, and then tap the app.

Uninstalling an app

You can uninstall any app that you have downloaded and installed from Android Market.

1. From the Home screen, tap  > **Market**.
2. Press  and then tap **My apps**.
3. Tap the app you want to uninstall, and then tap **Uninstall**.
4. When asked, tap **OK**.
5. Choose the reason for removing the app, and then tap **OK**.

Getting help

If you need help or have questions about Android Market, press , and then tap **Help**. The web browser will take you to the Android Market Help site.

Using the Clock



About the HTC Clock widget

Use the HTC Clock widget to see your current date, time, and location. You can also use the Clock to show the time in another city.



Changing the location on the Clock widget

By default, the Clock widget on the Home screen displays your current weather. You can customize the Clock widget on your Home screen to show the weather of another location.

1. Press and hold the clock on the Home screen, and then drag it to the  button.
2. Tap the clock to change its settings.
3. Choose a city.
 - If you don't see the city that you want, tap  to search for it and add it.
4. Tap Done.

Using the Clock app

Get more from the Clock app than just the regular date and time. Use HTC Explorer as a desk clock complete with weather information or as a world clock so you can see what time it is in several cities across the globe. You can also use it as an alarm clock, stopwatch, and countdown timer.

To open the Clock app, do one of the following:

- Tap the Clock widget on the Home screen.
- From the Home screen, tap  and then tap **Clock**.

Tap the tabs on the bottom row or slide your finger across the tabs to switch between the different functions of the Clock app.

Using Desk Clock

The Desk Clock displays the current date, time, and weather. It also shows an alarm clock indicator.

Tap the weather image or information to open the Weather app where you can see weather forecasts for the next few days.

Using World Clock

Use the Clock app's World Clock tab to check the current time in several places around the globe. You can also set your home city, add more cities to the world clock list, and manually set your time zone, date, and time.

Setting your home city

1. On the World Clock tab, press  and then tap **Home settings**.
2. Enter your home city's name. As you enter letters, the list is filtered to show matching cities and countries.
3. Scroll through the list and tap your home city.

Setting the time zone, date, and time

To set the time zone, date, and time on HTC Explorer manually, you need to turn off auto time sync first.

1. On the World Clock tab, press  and then tap **Local time settings**.
2. Clear the **Automatic** check box, and then set the time zone, date, and time as required.



From the Home screen, you can also press  and then tap **Settings > Date & time** to open the Date & time settings screen.

Adding a city to the World Clock screen

Add more cities to the World Clock screen so you can instantly check the date and time in these cities.

1. On the World Clock tab, tap .
2. Enter the city name you want to add. As you enter letters, the list is filtered to show matching cities and countries.
3. Scroll through the matching list and tap the city that you want to add.

Setting an alarm

You can use the Clock app's Alarms tab to set up one or more wake-up alarms.

1. On the Alarms tab, select the check box of an alarm and then tap that alarm.
2. Under Set alarm, drag your finger up or down to roll the time scroll wheels and set the alarm time.

3. Choose from the available options. You can:
 - Enter the alarm **Description** and choose the **Alarm sound** to use.
 - Tap **Repeat**. Select which days of the week to sound the alarm, and then tap **OK**.
 - Select the **Vibrate** check box if you want HTC Explorer to also vibrate when the alarm goes off.
4. After you've finished setting the alarm, tap **Done**.



- To turn off an alarm, clear the check box of that alarm.
- If you need to set more than three alarms, tap **+**.

Deleting an alarm

1. On the Alarms tab, press and then tap **Delete**.
2. Select the alarms you want to delete and then tap **Delete**.

Changing alarm sound settings

On the Alarms tab, press and then tap **Settings**. You can change the following settings:



| | |
|-----------------------------|---|
| Alarm in silent mode | Selected by default, this option allows the alarm to sound even when the volume is set to silent. Clear this check box if you want to silence the alarm when HTC Explorer is in silent mode. |
| Alarm volume | Set the volume level that you want for the alarm. |
| Snooze duration | Set how long to snooze between alarms. |
| Side button behavior | Choose what happens to the alarm when pressing the side button (VOLUME UP/VOLUME DOWN). You can set the button to snooze, dismiss the alarm, or disable the button. The side button works only when the screen is not locked. |

Checking Weather

Use the Weather app and widget to check the current weather and weather forecasts for the next few days. In addition to your current location, you can view weather forecasts for other cities around the globe. Your settings in the Weather app also control the weather information that is shown in the Clock and Calendar.



F For HTC Explorer to detect your current location and display your local weather in the Weather app and widget as well as in Clock and Calendar:

- You need to connect to the Internet.
- Location services must be enabled. If you didn't enable it when you first set up HTC Explorer, you can do so in **Settings > Location**.



1. From the Home screen, tap  > **Weather**.
2. Swipe your finger up or down the screen to check the weather in other cities.
3. While viewing forecasts, you can:
 - Swipe your finger up or down the screen to check the weather in other cities.
 - Tap  to update the weather information at any time.

Adding a city to the Weather screen

Add more cities to the Weather screen so you can instantly check the weather forecasts in these cities. In addition to your current location, the Weather screen can display up to fifteen cities.

1. On the Weather screen, tap . Or press  and then tap **Add**.
2. Enter the location you want to add. As you type, the list is filtered to show the possible locations based on the letters you entered.
3. Tap the desired city to select it.

Changing the order of cities on the Weather screen

1. On the Weather screen, press  and then tap **Rearrange**.
2. Press and hold  at the end of the item you want to move. When the row is highlighted, drag it to its new position, then release.
3. Tap **Done**.

Deleting cities from the Weather screen

1. On the Weather screen, press  and then tap **Delete**.
2. Select the cities you want to remove and then tap **Delete**.

Changing Weather options

1. On the Weather screen, press  and then tap **Settings**.
2. You can change the following weather settings:

| | |
|-----------------------------|---|
| Update when opened | Select this check box to refresh weather updates every time you open the Weather app. |
| Update automatically | Select this check box to automatically download weather updates. |
| Update schedule | Set an auto update schedule. |
| Temperature scale | Choose whether to display the temperature in Celsius or Fahrenheit. |
| Sound effects | Choose whether to play sound effects related to the weather conditions. |



About the Weather widget

Use the Weather widget to instantly check weather forecasts of your current location and other cities without having to open the Weather app. The Weather widget comes in different looks and styles.



You can add this widget to the Home screen, if it's not yet added.

Watching videos on YouTube

Use the YouTube app to check out what's popular on the online video-sharing website.

1. From the Home screen, tap  > **YouTube**.
2. Scroll through the list of videos, and then tap a video to watch it.
3. While watching a video, you can:
 - Turn HTC Explorer sideways or double-tap the screen to watch the video in full screen.
 - Tap the video screen to pause, resume playback, or drag the slider to jump to a different part of the video.
 - Tap a tab to learn more about the video, see related videos, or check out what other viewers think. You can also slide your finger across the tabs to see if there are more items available.
 - Tap the thumbs-up or thumbs-down icon to add your video rating. Tap **More** to see other options.
4. Press , and then tap **Home** to return to the YouTube main screen.

Searching for videos

1. On the YouTube main screen, tap .
2. Enter a search keyword, and then tap .
3. Scroll through the results and tap a video to watch it.



You also have the option to show results that were just recently posted. Tap **All time**, and then select a time period you want.





Clearing the search history

1. On the YouTube main screen, press , and then tap **Settings**.
2. Tap **Clear search history**, and then tap **OK** when prompted.

Sharing a video link

1. On the video's watch screen, tap **More > Share**.
2. Choose how you want to share the video link from the available options.

Capturing and sharing videos on YouTube

1. From the Home screen, tap  > YouTube.
Or if YouTube is already open, return to its main screen.
2. Tap .
3. Tap  to start capturing video.
4. When you're finished capturing, tap  again, and then tap **Done**.
5. Enter a title for your video.
6. Tap **More details** to select the YouTube account you want to use, add a description, set the privacy level, and add tags or location information to your video.
7. Tap **Upload**.

Listening to FM Radio

Tune in and listen to your favorite radio stations using the FM Radio app.











You need to connect a headset first to the audio jack of HTC Explorer to use FM Radio. FM Radio uses the stereo headset as the FM radio antenna.

From the Home screen, tap  > **FM Radio**.

The first time you open FM Radio, it automatically scans for available FM stations, saves them as presets, and plays the first FM station found.

Tuning in to an FM station

There are several things you can do while you're on the FM Radio screen:

- Tap  to view the All presets list, and then select a station you want to listen to.
- Tap  to go to the previous available FM station, or  to go to the next available FM station.
- Drag the slider to tune in to a frequency on the FM band.
- Tap  to fine tune the radio frequency by -0.1 MHz or  to fine tune the radio frequency by +0.1 MHz.
- Tap  to add a preset name for the current station you are tuned into.
- Press the VOLUME UP and VOLUME DOWN buttons to adjust the volume.
- To repeat scanning and saving of FM stations, press , and then tap **Scan & Save**.
- Press  to mute the sound or to change the sound output to **Mono** or **Stereo**. You can also switch the sound output between the **Speaker** and **Headset**.



Closing or turning off FM Radio

You can continue listening to the radio while using other apps on HTC Explorer or close the FM Radio app completely.

| To | Do this |
|---|--|
| To close the FM Radio screen | Press  . FM Radio continues to run in the background. To go back to the FM Radio screen, slide open the Notifications panel, and then tap FM Radio . |
| To turn off completely and close FM Radio | Tap  on the FM Radio screen. |

Recording your voice



Don't just think out loud. Use Voice Recorder to quickly capture your thoughts. You can also record your voice and set it as a ringtone.

1. From the Home screen, tap  > **Voice Recorder**.
2. Hold the microphone near your mouth.
3. Tap  to start recording a voice clip.



Voice Recorder can run on the background while you do other things on HTC Explorer, except when you open other apps that also use audio functions. To go back to the Voice Recorder screen, slide open the Notifications panel, and then tap **Voice Recorder**.

4. Tap  to stop recording.
5. Type a name for the voice clip and tap **Save**.

6. To play back the voice clip, tap .
7. To show options for sharing, deleting, or renaming the voice clip, press .

Sharing a voice clip

1. On the Voice Recorder screen, tap .
2. Press and hold the voice clip you want to share, and then tap **Share**.
3. From the available options, choose how you want to share the voice clip.

Setting a voice clip as a ringtone



1. On the Voice Recorder screen, tap .
2. Press and hold the voice clip you want to set as a ringtone, and then tap **Set as ringtone**.

Sharing games and apps

Having fun with a game or app that you found from Android Market? Share your favorite games and apps instantly with your circle of friends.



For your friends to link to the app and download it from Android Market, they must be using an Android device.

1. From the Home screen, tap .
2. Press , and then tap **Share**. You'll then see the list of games and apps that you downloaded and installed from Android Market.
3. Tap an app, and then choose how to share it.

When your friends see the link in your sent message, email, or status update, they can simply tap the link to go directly to the game or app in Android Market to download it.

Messages

Opening Messages

Keep in touch with important people in your life. Use the Messages app to compose and send text (SMS) and multimedia messages (MMS).

From the Home screen, tap  > **Messages**. The All messages screen opens, where all your sent and received messages are neatly grouped into conversations, by contact name or phone number.





- Scroll up or down the list of conversations by swiping your finger on the screen.
- Tap a contact name or number to view the exchange of messages.



You can also view your messages on the Home screen with the Messages widget.

Sending a text message (SMS)

1. From the Home screen, tap  > **Messages**.
2. Tap .
3. Fill in one or more recipients. You can:
 - Enter the first few letters of a contact name or starting digits of a mobile number. As you type, matching names with phone numbers from your stored contacts are displayed. Tap a name or one of the contact's numbers.
 - Tap , and then select the phone numbers of the contacts to whom you want to send the message. You can also select contact groups as recipients.
 - Enter the complete phone numbers directly in the To field.

4. Tap the box that says **Add text**, and then enter your message.

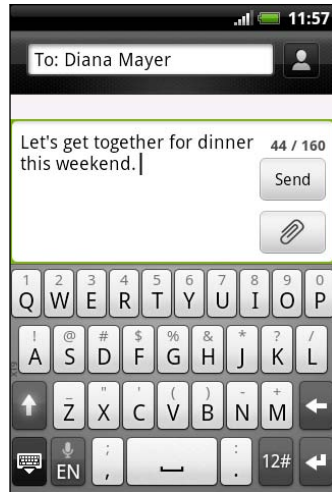

- There is a limit on the number of characters for a single text message (displayed above the **Send** button). If you exceed the limit, your text message will be delivered as one but will be billed as more than one message.
- Your text message automatically becomes a multimedia message if you enter an email address as the recipient, add a message subject, attach an item, or compose a very long message.

5. Tap **Send**, or press to save the message as a draft.

Sending a multimedia message (MMS)

1. From the Home screen, tap > Messages.
2. Tap .
3. Fill in one or more recipients. You can:
 - Enter the first few letters of a contact name or starting digits of a mobile number. As you type, matching names with phone numbers and email addresses from your stored contacts are displayed. Tap a contact's number or email address.
 - Tap , and then select the phone numbers of the contacts to whom you want to send the message. You can also select contact groups as recipients.
 - Enter the complete phone numbers or email address directly in the **To** field.
4. To add a subject line, press and then tap **Add subject**.
5. Tap the box that says **Add text**, and then enter your message.

6. Tap  and then choose the type of attachment.

| | |
|-------------------------|---|
| Picture | Take a photo and attach it, or attach an existing photo. |
| Video | Record a video and attach it, or attach an existing video. |
| Audio | Make a voice recording and attach it, or attach an existing audio file. |
| App recommendation | Choose an app you've installed from Android Market that you want to share with others. The URL from which the app can be downloaded will be inserted to your message. |
| Location | Add your current location (requires GPS to be turned on), or a location you pick on a map to your message. |
| Contact (vCard) | Select a contact, and then select the information to attach. |
| Appointment (vCalendar) | Select the calendar event you want to attach. |





After adding an attachment, tap  to see options for replacing, viewing or removing your attachment.

7. Tap **Send**, or press  to save the message as a draft.

Why isn't the contact's email address showing up when I enter a contact name?





If only phone numbers are showing up when you're entering a contact name, go to the Messages settings to enable displaying email addresses.

1. If you've created a new message, press  first to return to the All messages screen.
2. Press  and then tap **Settings > General**.
3. Select the **Show email address** check box.

Creating a slideshow

1. After you've added either a photo, video, or audio in the multimedia message you're composing, tap  > **Slideshow**.
2. Choose where you want to insert the next slide.

- Right after adding a slide, do any of the following:

| | |
|---|--|
| Add a photo or video to a slide | Tap  , and then choose to add a photo or a video. |
| Add music or a voice recording to a slide | Tap  > Audio . |
| Add a caption to a slide | Tap Add text and then enter your caption. |
| Edit a slide | Tap  , and then choose to replace, remove, or set the duration of the slide. |
| Preview the slideshow | Press  , and then tap Preview (or More > Preview). Tap once on the preview screen to see playback controls. |

- When finished, tap **Send**, or press  to save the message as a draft.

Resuming a draft message

- On the All messages screen, press , and then tap **Drafts**.
- Tap the message and then resume editing it.
- Tap **Send**.

Viewing and replying to a message

Depending on your notification settings, HTC Explorer plays a sound, vibrates, or displays the message briefly in the status bar when you receive a new message. A new message icon  is also displayed in the status bar.



- To open and read the message, you can:
 - Press and hold the status bar, and then slide your finger down to open the Notifications panel. Then tap the new message notification.
 - Go to the Messages app and open the message.
- While reading the message, you can reply with a text or multimedia message.

You can also do the following while reading the message:

- Call the phone number contained in the message by tapping the number.
- Tap the email address contained in the message to send an email.

- Tap a link in the message to open it in the web browser.
- Tap the message to open the options menu and choose what you want to do with the message (such as forward, share, and more).

Adjusting the font size of your messages

While reading a message conversation with a contact, spread out two fingers on the screen to zoom in and make the text size bigger. Pinch the screen to zoom out.



You can also press , and then tap **More > Text size**.

Replying to another phone number of the contact

When a contact has multiple phone numbers stored on HTC Explorer, you'll see the particular phone number used below the contact's name.

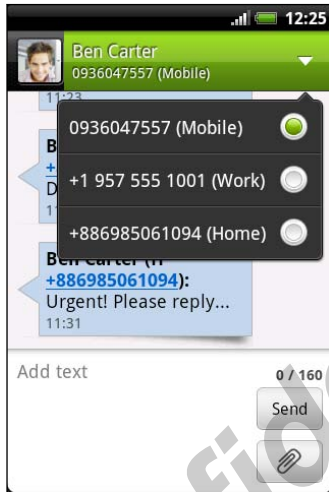

Keep in mind that your response will be sent to the phone number of the latest message you've received from this contact.

1. On the All messages screen, tap a contact (or phone number) to display the exchange of messages with that contact.
2. Tap , and then select another phone number of this contact.
3. Tap the box that says **Add text**, then enter your reply message.
4. Tap **Send**.

Forwarding a message

1. On the All messages screen, tap a contact (or phone number) to view the exchange of messages with that contact.
2. Tap the message you want to forward, and then tap **Forward**.

3. In the **To** field, fill in one or more recipients.
4. Tap **Send**.



While viewing the exchange of messages with the contact, you can also press , tap **Forward** (or **More > Forward**), and then tap the message you want to forward.

Viewing and saving an attachment from a multimedia message

If you are concerned about the size of your data downloads, check the multimedia message size first before you download it.



When **Auto-retrieve** in MMS settings is disabled, only the message header is downloaded. To download the entire message, tap the **Download** button at the right side of the message.

- If there's a media attachment such as a photo or video in a received message, tap it to view the content.
- If the attachment is a contact (vCard), tap it to view the contact information, then tap **Save** to add to your contacts.
- If the attachment is an appointment or event (vCalendar), tap it to choose the calendar where to save it, and then tap **Import**.
- To save the attachment to your storage card, press and hold the multimedia message, and then choose to save the type of attachment from the options menu.

Push messages



Push messages contain a web link. Often, the link will be to download a file that you have requested from a service provider.

When you receive a push message, a notification icon  is displayed in the status bar.

Opening and reading a new push message

1. Press and hold the status bar, and then slide the status bar down to open the Notifications panel.
2. Tap the new message.
3. Tap **Visit website**.

Viewing all your push messages

1. From the Home screen, tap  > Messages.
2. Press , and then tap **Push messages**.



You can only see this option if you've previously received push messages.

Managing message conversations

Protecting a message from deletion

You can lock a message so that it will not be deleted even if you delete the other messages in the conversation.

1. On the All messages screen, tap a contact (or phone number) to display the exchange of messages with that contact.
2. Tap the message that you want to lock.
3. Tap **Lock message** on the options menu. A lock icon  is displayed at the right hand side of the message.

Copying a text message to your SIM card

1. On the All messages screen, tap a contact (or phone number) to display the exchange of messages with that contact.
2. Tap the message, and then tap **Copy to SIM**. A SIM card icon  is displayed at the right hand side of the message.

Deleting a single message

1. On the All messages screen, tap a contact (or phone number) to display the exchange of messages with that contact.
2. Tap the message that you want to delete.
3. If the message is locked, tap **Unlock message** on the options menu, and then tap the message to display the options menu again.
4. Tap **Delete message** on the options menu.
5. When prompted to confirm, tap **OK**.

Deleting several messages within a conversation

1. On the All messages screen, tap a contact (or phone number) to display the exchange of messages with that contact.
2. Press  and then tap **Delete** (or **More** > **Delete**).

3. Tap **Delete by selection**.



You can also tap **Delete by phone number** if the contact used multiple phone numbers throughout the conversation and you want to delete the messages sent from a particular number.

4. Select the messages you want to delete and then tap **Delete**.



In the settings, you can set the Messages app to auto delete old messages per conversation.

Deleting a conversation

1. Do any of the following:

- On the All messages screen, press and hold a contact (or phone number) whose messages you want to delete, and then tap **Delete**
- While looking at the exchange of messages in a conversation, press and then tap **Delete > Delete thread** (or **More > Delete > Delete thread**).

Any locked messages in the conversation thread will not be deleted unless you select the **Delete locked messages** check box.

2. When prompted to confirm, tap **OK** to delete the entire thread.

Deleting several conversations

1. On the All messages screen, press and then tap **Delete**.
2. Select the conversation threads you want to delete.
3. Tap **Delete**. Any locked messages will not be deleted.

Backing up your text messages to the storage card

1. From the Home screen, tap > **Messages**.
2. Press , and then tap **Backup SMS > Backup SMS**.
3. Enter a name for your backup file, and then tap **OK**.

Importing text messages from the storage card

You can only import text messages that were exported to the storage card using the **Backup SMS** feature.

1. From the Home screen, tap > **Messages**.
2. Press , and then tap **Backup SMS > Restore from backup**.
3. Tap the backup file to import.
4. Tap **OK**.

Setting message options

On the All messages screen, press  and then tap **Settings**.

| | |
|----------------------------------|--|
| Notifications | <ul style="list-style-type: none"> ▪ Receive a notification in the status bar and set HTC Explorer to vibrate or play a sound when a message arrives or when a message is not sent successfully, and choose a notification sound. ▪ Allow HTC Explorer to show pop-up notifications on the screen when messages are sent successfully or not, or disable this option. ▪ If you don't want the content of received text messages to appear on the lock screen and status bar, clear the Notification preview check box. |
| Text messages (SMS) | <ul style="list-style-type: none"> ▪ Receive a report on the delivery status of your message. ▪ View or change the message service center number used. (We recommend that you don't change the number here as it may cause problems in receiving and sending messages.) ▪ View or delete text messages stored on your SIM card, or copy SIM card messages to device memory. |
| Multimedia messages (MMS) | <ul style="list-style-type: none"> ▪ Receive a report on the delivery status of your message. ▪ Receive a report whether each recipient has read the message or deleted it without reading. ▪ Automatically download complete MMS messages including the message body and attachments in your service area and when roaming. ▪ Set the message priority and maximum file size of MMS messages. If the MMS message file size is exceeded, the message won't be sent. |
| General | <ul style="list-style-type: none"> ▪ Search and display the sent message history, call history, and email addresses of stored contacts when you're adding message recipients. ▪ Set the number of lines of text to preview for each message on the All messages screen. ▪ Choose the maximum number of text or MMS messages to store in each conversation thread (excluding locked messages), and enable automatic deletion of unlocked older messages when set limits are reached. ▪ Forward received text and MMS messages to another phone number or email address. (This may incur extra fees.) ▪ Add a signature to your messages. |

Email

Gmail

Using Gmail

When you first set up HTC Explorer, make sure you sign into your Google Account to use Gmail. If you didn't do so, go to the **Accounts & sync** setting to sign in.

You can also set up more than one Google Account on HTC Explorer, and then switch between accounts in Gmail.

Viewing your Gmail Inbox

All your received emails are delivered to your Inbox.

From the Home screen, tap  > Gmail. Your Gmail inbox then opens.

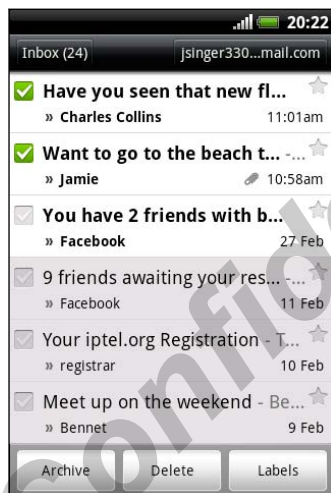

Archive, delete or label multiple conversations

Tap before the email or conversation. Then tap the onscreen buttons at the bottom to choose what to do with the selected messages or conversations.

Display drafts, sent messages, and other labels

Tap **Inbox** at the top left of the screen, and then tap another label (such as **Sent**, **Drafts**, or your created label) to view its messages and conversations.

Switch to your other Gmail account

Tap the current account at the top right of the screen, and then tap another account you want to switch to.

Refresh the Inbox

Press , and then tap **Refresh**.



Sending a new message

1. In the Gmail inbox, press  and then tap **Compose**.
2. If you've set up multiple Google Accounts on HTC Explorer, choose which Gmail address you want to use for sending your email. Tap the box that shows your current Gmail address, and then tap another address that you want to use for sending.



3. Enter the message recipient's email address in the **To** field. If you are sending the email to several recipients, separate the email addresses with a comma.





If you want to send a carbon copy (Cc) or a blind carbon copy (Bcc) of the email to other recipients, press  and then tap **Add Cc/Bcc**.

4. Enter the email subject, and then compose your email.
5. If you want to attach a picture, press  and then tap **Attach**.
6. Locate and then tap the picture you want to attach.
7. After composing your message, tap .



While composing the message, tap  to save it as a draft. Or press  to discard the message.

Replying to or forwarding an email message

1. In the Gmail inbox, tap the email message or conversation.
2. To reply to the sender, tap . Or, tap  and choose whether to **Reply all** or **Forward**.
3. Do one of the following:
 - If you selected **Reply** or **Reply all**, enter your reply message.
 - If you selected **Forward**, specify the message recipients.



Tap **Respond inline** if you want to interleave your new message with the received email. But this removes any attachments or formatting in the original email.

4. Tap .

Getting help

To find out more about using Gmail, press , and then tap **More > Help**. The web browser will take you to the Google Mobile Help site.

Mail



About the Mail app

Use the Mail app to add your webmail and other POP3 or IMAP email accounts. You can also set up and use your Exchange ActiveSync email on HTC Explorer.



You can add the Mail widget to view your POP3/IMAP or Exchange ActiveSync emails on the Home screen.

Adding a POP3/IMAP email account



1. From the Home screen, tap  > Mail.
2. Do one of the following:
 - If this is your first time to add an email account in Mail, tap **Other (POP3/IMAP)** on the Choose a mail provider screen.
 - If you've already added an email account in Mail, press , and then tap **More > New account**. If the Choose a mail provider screen is displayed, tap **Other (POP3/IMAP)**.
3. Enter the email address and password for your email account and then tap **Next**.
4. If the account type you want to set up is not in the internal database, you'll be asked to enter more details.
5. Enter the account name and your name and then tap **Finish setup**.

Adding a Microsoft Exchange ActiveSync account

You can add one or more Microsoft Exchange ActiveSync accounts on HTC Explorer. You can sync with Microsoft Exchange Server 2003 Service Pack (SP2) or later.



You can add up to 15 Exchange ActiveSync accounts on HTC Explorer.

1. From the Home screen, tap  > Mail.
2. Do one of the following:
 - If this is your first time to add an email account in Mail, tap **Microsoft Exchange ActiveSync** on the Choose a mail provider screen.
 - If you've already added an email account in Mail, press , and then tap **More > New account**. If the Choose a mail provider screen is displayed, tap **Microsoft Exchange ActiveSync**.
3. Enter the Exchange ActiveSync account details, and then tap **Next**. If your corporate Exchange Server does not support auto-detect, you'll need to enter your Exchange Server settings after you tap **Next**. Ask your Exchange Server administrator for details.
4. Choose the types of information you want to sync. Also choose how often you want to update and sync email to HTC Explorer, then tap **Next**.
5. Enter the account name, then tap **Finish setup**.

Checking your Mail inbox

When you open the Mail app, it displays the inbox of one of your email accounts that you've set up on HTC Explorer.

To switch between email accounts, tap the bar that shows the current email account, and then tap another account.

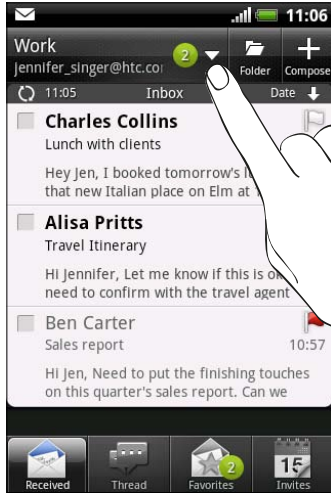

Viewing the unified inbox of all your email accounts

You can view email messages from all your accounts just in one place without having to switch to different accounts.

Just tap the bar that shows the current email account, and then tap **All accounts**. Email messages are color coded so you can easily distinguish which email accounts they belong to.



Up to 15 email accounts can be shown in the unified inbox.

Switching between different views of your inbox

If you have lots of email messages, it may take you some time to browse through the long list and find a single email or related email messages. Use the tabs of the Mail app to sort your emails into different categories.

To skim through your email messages easier, tap one of the following tabs to change the view of your inbox:









Inbox

Displays email messages as individual items.



Thread

Displays email messages as conversations, grouped according to the subject line. Tap a subject in the list to show the email conversation.



| | |
|---|--|
|  | Group Displays all email messages from a contact group. To choose which contact group to display, press  , tap View , and then select a group. |
|  | Unread Displays unread messages. |
|  | Marked (Exchange ActiveSync only) Displays all flagged messages. |
|  | Invites or Meeting invitations (Exchange ActiveSync only) Displays meeting invitations which you have not yet accepted or declined. |
|  | Attachments Displays all messages that have attachments. |



Can't see the tab that you want? Press and hold a tab and wait for the screen to show the other tabs. You can tap and hold a tab, and then drag it to where you want it.

Refreshing an email account

Whatever your automatic synchronization settings are, you can also synchronize your sent and received emails manually at any time.

- While in the account you want to synchronize, press , and then tap **Refresh**.
- If you have several email accounts, you can refresh them all at the same time. Go to the All accounts inbox first. Then press  and tap **Refresh**.

Sorting email messages

You can sort email messages by date received, priority, subject, sender, or size.

On the inbox, press , tap **Sort**, and select from the sorting options.

Quickly browsing your inbox

If you have a long list of email messages in your inbox, it may not be easy to browse the list and find an email that you want. You can quickly browse through your inbox by using finger gestures.

1. Choose a sorting order for displaying your email messages.
2. Press and hold two fingers on any email message, and then drag upward or downward without lifting your fingers. Your screen then jumps to the set of email messages based on your chosen sorting order.

Managing email messages

Deleting an email message

1. On the inbox, press and hold the message you want to delete.
2. On the options menu, tap **Delete**.

Selecting several email messages

1. Tap the check boxes of email messages to select them.
2. Choose what you want to do with the selected messages: **Mark read** (or mark **Mark unread**), **Delete**, or **Move** to another folder.



You cannot move email messages when you're in the unified (All accounts) inbox.

Moving several email messages to another folder

1. Switch to the email account you want to use.
2. Tap the check boxes of email messages you want to move.
3. Tap **Move to**, and then tap the folder where to move the email messages.

Moving an email message after reading

1. While viewing the email, tap **Move to**.
2. Tap the folder where you want to move the email message.

Deleting all messages

1. First tap the check box of any email message.
2. Press , and then tap **Select all**.
3. Tap **Delete**.

Switching to other mail folders

1. Press , and then tap **Folders**.
2. Tap the mail folder whose messages you want to view.

Sending an email message

1. From the Home screen, tap > **Mail**.
2. Switch to the email account that you want to use for sending email.
3. On the email account inbox, tap .

4. Fill in one or more recipients. You can:

- Enter email addresses directly in the **To** field, separating them with a comma. As you enter email addresses, any matching addresses from your contacts list are displayed. Tap a match to enter that address directly.
- Tap the  icon, and then choose the contacts to whom you want to send the message. You can also select contact groups as recipients, or search and add contacts.

If the contact name you entered is not found and you have an Exchange ActiveSync account in the Mail app, you can search for the contact in your company directory.



If you want to send a carbon copy (Cc) or a blind carbon copy (Bcc) of the email to other recipients, press , and then tap **Show Cc/Bcc**.

5. Enter the subject, and then compose your message.

6. To add an attachment, press , tap **Attach**, and choose from the following options:

| | |
|-------------------------|---|
| Picture | Take a photo and attach it, or attach an existing photo. |
| Video | Record a video and attach it, or attach an existing video. |
| Audio | Attach an audio file. |
| App recommendation | Choose an app you've installed from Android Market that you want to tell other people about. The URL from which the app can be downloaded will be inserted in your email. |
| Location | You can attach location information. Send your current location (requires GPS to be turned on) or a location you pick on a map. |
| Document | Attach a PDF file or an Office document such as a text file or a spreadsheet. |
| Contact (vCard) | Attach someone's contact information. |
| Appointment (vCalendar) | Attach a calendar event. |
| File | Attach any other file. |

7. Tap **Send** to send the message immediately, or tap **Save as draft** to send it later.

If there's no Internet connection available or Airplane mode is on when you send your email, the email will be saved to the Outbox folder. Once there's Internet connection available, the saved email will be sent automatically next time HTC Explorer syncs.

Resuming a draft email message

1. In the email account inbox, press , and then tap **Folders > Drafts**.
2. Tap the message.
3. When you finish editing the message, tap **Send**.

Managing the recipient list

Filled up the To field but want to make changes in it? You can manage the recipient list and change who appears in the To, Cc, and Bcc fields.



You must have entered contacts in the To, Cc, or Bcc field.

1. In the To, Cc, or Bcc field, tap the Edit button. The names of the contacts are listed.
2. Tap the checkbox beside the contact that you want to move to another field.
3. Tap the action that apply.
4. When you are done with the changes, press  to go back to composing your email.

Reading and replying to an email message

1. From the Home screen, tap  > Mail.
2. Switch to the email account you want to use.
3. On the email account inbox, tap the email you want to read.
4. Choose an action on the bottom of the screen for your email.



Press  to see options for deleting your email or marking it as unread.

Where are my unread emails?

The Unread tab contains all your unread emails. Add it if it does not appear on your screen.

1. Press and hold a tab. When the screen changes and shows you the area where you can rearrange icons, lift your finger.
2. Press and hold the Unread tab, and then drag it to its new position.
3. Press , and then tap the Unread tab.

Setting the priority for an email message



You can set the priority for an email message that you send.

1. While composing the message, press .
2. Tap **Set priority**.
3. Select the priority for the message.

If you selected **High** or **Low** priority, the priority appears below the subject line of the message.

Searching and filtering emails

Search emails in all your email accounts or in a specific one. You can even refine your search by indicating which part of the email will be searched.

1. Press .
2. If you want to refine or filter your search, tap  and then check the options that apply. For example, you can focus the search on a part of an email or filter emails that have attachments or tagged as high priority.
3. Tap **OK**.
4. Enter the first few characters of the item you're looking for in the search box. Results will then be listed.

Tap a result to open the email.

Searching emails from a contact



Do you remember the sender, but can't find a particular email from this contact? You can search your mail accounts for emails from a specific contact.

1. Switch to the email account you want to use.
2. Press and hold an email from a contact.
3. Tap **Search the mail from the sender**. A list of emails from that contact appears.

Working with Exchange ActiveSync email

You can read, reply, send, and manage your work email in the same easy way as with a POP3/IMAP account. In addition, you can also use some powerful Exchange features.

Flagging an email

- While viewing the inbox, tap the white flag icon  that appears on the right of an email message. The icon turns red  after you flagged the email.
- While reading an email, you can also tap the flag icon in the email.

Setting your Out of the office status

1. Switch to your Exchange ActiveSync account.
2. Press  and then tap **More > Out of the office**.
3. Tap the box, and then select **Out of the office**.
4. Set the dates and times for the period when you will be out of the office.
5. Enter the auto-reply message.



You can also send auto-reply messages to external recipients, which are contacts whose addresses are not in the same Microsoft Exchange server.

6. Tap **Save**.

Sending a meeting request

1. Switch to your Exchange ActiveSync account.
2. Go to the Invitations tab, and then tap .
3. Enter the meeting details.
4. Tap **Save**.

Changing email account settings

1. Switch to the email account whose settings you want to change.
2. Press , and then tap **More > Settings**.
3. Select from the following:

| | |
|------------------------------|---|
| Account settings | Change the email account settings such as the name, email address, password, and description. |
| General settings | Set the font size when reading emails, enable, disable or set the signature, set the account as the default email account, and set where to save email attachments. |
| Send & Receive | Set the sync settings for incoming and outgoing emails such as maximum size limit, update schedule, and more. |
| Notification settings | Set email notification settings. |
| Delete account | Tap to delete the email account. |

4. Press  to save your changes.

Deleting an email account

1. Switch to the email account you want to delete.
2. Press , and then tap **More > Settings > Delete account**.

Calendar

About Calendar

Never miss an important date again. Use the Calendar app to schedule your events, meetings, and appointments.

You can set up HTC Explorer to stay in sync with the following types of calendars:

- On HTC Explorer, sign in to your Google Account so you can sync the Calendar app with your Google Calendar online. You can add multiple Google Accounts.
- If you're using Microsoft Outlook on your computer, you can set up HTC Sync on your computer to sync Outlook Calendar with the Calendar app.
- If you have a Microsoft Exchange ActiveSync account and you've added it on HTC Explorer, you can sync the Calendar app with your Exchange ActiveSync calendar events.



If you've signed in to Facebook, birthdays and events of friends will appear in Calendar.

Creating an event

You can create events that sync with your Google or Exchange ActiveSync calendars, as well as events on HTC Explorer.



Not signed in yet on your accounts? Your calendar events will be created under PC Sync, which you can later sync with your computer's Outlook Calendar through HTC Sync.

1. From the Home screen, tap  > Calendar.
2. On any Calendar view, tap .
3. If you have more than one calendar, select a calendar in which to add the event.
4. If you want to invite people to your event, tap  and choose attendees from your contacts or company directory.
5. Enter a name for the event.
6. To specify the date and time of the event, do one of the following:
 - If there is a time frame for the event, tap the **From** and **To** date and time to set them.
 - If it is a whole-day event, such as a birthday, set the **From** and **To** date, then select the **All day** check box.
7. Enter the event location and description.

- Set the reminder time.



You can add another reminder time in a Google Calendar event. Press  and then tap **Add reminder**.

- If the event occurs on a regular basis, tap the **Repetition** box and then choose how often the event occurs.
- Tap **Save**.

Changing Calendar views

Easily switch between different calendar views by tapping the onscreen buttons.

| | |
|--|---------------------|
|  | Day view |
|  | Week view |
|  | Month view |
|  | Agenda view |
|  | Meeting invitations |



- In Day, Week, and Agenda views, events are color coded to indicate which account or type of calendar they belong to. To find out what each color represents, tap .
- Can't see the tab that you want? Press and hold a tab and wait for the screen to show the other tabs. You can press and hold a tab, and then drag it to where you want it.

Using month view

In month view, you will see markers on days that have events.

Do any of the following in month view:

- Tap a day to view the events for that day.
- Press and hold a day to open an options menu from which you can also choose to create an event or switch to either day or agenda view.
- Slide your finger up or down the screen to view earlier or later months.

Using day and agenda views

Day view shows your events per day, whereas agenda view displays all your events in chronological order.

When in day view:

- Press and hold on a time slot to create a new event at that time.
- Slide left or right across the screen to view earlier or later days.
- You can also see the day's weather, but only if it's within the five-day forecast.

Using week view

Week view displays a chart of the events of one week.



When in week view, you can:

- Press and hold on a time slot to create a new event at that time.
- Tap an event (shown as colored blocks) to view its details.
- Slide left or right across the screen to view earlier or later weeks.

Managing Calendar events

Viewing an event

You can view your own events as well as events that other people have shared with you.

1. In day view or agenda view, tap an event. The Event details screen then opens and shows the summary of the event.
2. Depending on the event information, do any of the following:
 - Find the event's location in Maps.
 - Call any phone number included in the event location or description.
 - Check the participants of the event.
 - If the event was sent as a meeting invitation, respond to the invitation.
 - If it's an Exchange ActiveSync calendar event, reply by email to the organizer or to all the guests. Press , and then tap **Reply** or **Reply all** (or **More > Reply** or **Reply all**).
 - Select any text and look it up on the Web.
 - Tap the reminder time to change it. Press  to save changes.



You can return to the current date by tapping .

Editing an event

You can edit events that you have created.

1. While viewing an event, tap .
2. Make your changes to the event.
3. When you're done editing, tap **Save**.

Deleting an event

Do any of the following:

- While viewing the summary of an event on the Event details screen, press  and then tap **Delete event**.
- In day, agenda or week view, press and hold an event and then tap **Delete event**.
- When editing an event, tap **Delete**.

If the event repeats, you'll be asked whether you want to delete just that occurrence or all occurrences from Calendar.

Sharing an event (vCalendar)

You can share a calendar event as a vCalendar using Bluetooth or by sending it as a file attachment with your email or message.

1. While viewing an event, press , and then tap **Forward**.
2. Do one of the following:
 - Tap **Bluetooth**. You'll be asked to turn on Bluetooth on HTC Explorer and connect to the receiving Bluetooth device.
 - Tap **Mail**. A new message window opens and automatically includes the vCalendar as an attachment. Your default email account will be used to send the message.
 - Tap **Message**. A new message window opens and automatically includes the vCalendar as a multimedia attachment.

Accepting or declining a meeting invitation

1. If you're using an Exchange ActiveSync account on HTC Explorer, tap the **Invites** tab in Calendar to see meeting invitations which you have not yet accepted or declined.
2. Tap a meeting invitation, and then do one of the following:
 - Accept, decline, or tentatively accept the invitation or propose a new time.
 - Press  to see options for replying, moving the invitation to a folder, and more.

Dismissing or snoozing event reminders

If you have set at least one reminder for an event, the upcoming event icon  will appear in the notifications area of the status bar to remind you of the upcoming event.

1. Tap the status bar, then slide your finger down the screen to open the Notifications panel.
2. Do one of the following:
 - Tap **Clear** to dismiss event reminders and all other notifications.
 - After sliding open the Notifications panel, tap the calendar event reminder. You'll then see a list of all pending event reminders. Tap **Snooze all** to snooze all event reminders for five minutes, or tap **Dismiss all** to dismiss all event reminders.
 - Press  to keep the reminders pending in the notifications area of the status bar.

Showing or hiding calendars

In any Calendar view, tap , and then select or clear a calendar to show or hide it.



Calendars are kept synchronized on HTC Explorer, whether or not you hide them.

Changing Calendar settings

You can change Calendar settings to specify how it displays events and how it notifies you of upcoming events.

In any Calendar view, press  and then tap **Settings** (or **More > Settings**).

Reminder settings

| | |
|----------------------------|---|
| All calendars | Select this check box to use the same event reminder settings for all types of calendars. If you clear this check box, you can set different reminder settings for each calendar. |
| Set alerts & notifications | Configure event reminders to open an alert, send you a notification, or turn off event notifications on HTC Explorer. |
| Default reminder time | Choose how soon before an event you want to be notified. |
| Select ringtone | Choose a ringtone to sound when you receive an event reminder. |
| Hide declined events | Choose whether to show or hide events for which you've declined invitations. |

Calendar view settings

| | |
|--------------------------|--|
| First day of week | Set the month and week views to start on a Sunday or Monday. |
| Include weather | Select this check box to show weather information in the day view events list. |
| City | If weather is included, by default, day view displays your current location's weather. You can change it to display the weather of another city. |

About the Calendar widget

You can add a Calendar widget to your Home screen. The widgets offer different calendar views.

Tapping a day or event on the widget brings you to the Calendar app.

HTC Confidential 2011/09/16

Maps and location

Location settings

Turning on location services

In order to find your location on HTC Explorer, you need to enable location sources.

1. From the Home screen, press  and then tap **Settings** > **Location**.
2. Select one or both of the following:

| | |
|------------------------------|--|
| Use wireless networks | Uses Wi-Fi or your mobile data connection to find your approximate location. |
| Use GPS satellites | Finds your exact GPS location. This requires a clear view of the sky and more battery power. |

Google Maps

About Google Maps

Google Maps™ lets you track your current location, view real-time traffic situations, and receive detailed directions to your destination.

It also provides a search tool where you can locate places of interest or an address on a map, or view locations at street level.





- You need to connect to the Internet to use Google Maps.
- To find your location with Google Maps, you need to enable location sources.
- The Google Maps app does not cover every country or city.



Getting around maps

When you open Google Maps, you can easily find your location on the map or check out nearby places by panning and zooming in and out on the map.





To find your location with Google Maps, you need to enable location sources.

1. From the Home screen, tap  > Maps.
2. Tap  to show your current location. The blue marker  shows your current location on the map.
3. Do any of the following:

| | |
|--|---|
| Move around | Swipe your finger to any direction on the screen to view nearby places on the map. |
| Use Compass mode | Tap  to switch to Compass mode. In Compass mode, the map changes to an angled view and automatically orients itself depending on the direction you're facing. |
| Zoom in | <ul style="list-style-type: none"> ▪ Place your thumb and index fingers on top of the area that you want to zoom in, and then spread your fingers across the map. ▪ Tap . ▪ Double-tap the area on the map that you want to zoom in. |
| Zoom out | <ul style="list-style-type: none"> ▪ Pinch your thumb and index finger on the map to zoom out. ▪ Tap . |
| View information for a random location | <ol style="list-style-type: none"> 1. Press and hold a location on the map. A balloon opens over the location, with the address and a thumbnail from street view (if available). 2. Tap the balloon to see more information. You can get directions to the location, check for nearby places of interest, and more. |

Searching for a location

In Google Maps, you can search for a location, such as an address or a type of business or establishment (for example, museums).

1. In Maps, enter the place you want to search for in the search box.
2. Tap  to search for the location you entered or tap a suggested search item. The search results are displayed as markers on the map.
3. Do any of the following:
 - Tap a marker  to see if that is what you're looking for, tap the balloon if it is.
 - Tap  to show the search results as a list, and then tap the location.

Details about the selected location displays on the screen.

4. Do any of the following:
 - Tap the onscreen buttons to view the location on a map, get directions, view the location in Street View, if available, and more. Scroll down the screen to view more options.
 - Swipe left or right across the screen to view the information for the next or previous search result.

Clearing the map

After searching on a map, you can clear away the various markers drawn on it.

Press , and then tap **Clear Map**.

Searching for a place of interest near you

Use Places to find places of interest near your current location. Places uses Google Maps to search common places that you would want to find, such as the nearest gas station or ATM kiosk.





Before using Places, you need to enable location sources.

1. From the Home screen, tap  > **Places**.
2. Tap the type of place you want to search.
3. Do any of the following:
 - When one or two places of interest are found, the search results are displayed as markers on the map. You can tap the marker, and then tap the balloon to view more information about the place.
 - When several places are found, the search results display in a list. Tap a place to view more information.

Getting directions

Get detailed directions to your destination. Google Maps can provide directions for travel by foot, public transportation, or car.

1. While viewing a map, press , and then tap **Directions**.
2. Do any of the following:
 - Use your current location as the starting point, or enter a location from where to start in the first text box. Then enter your destination in the second text box.
 - Tap  to select an address from your contacts or a point that you tap on a map.

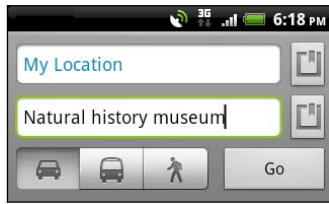

3. Choose how you want to get to your destination by tapping the car, public transit, bike, or walk button.
4. Tap **Get directions**. The next screen displays the directions to your destination in a list.



If the place you've set as your destination has several locations available, choose which one to go to.

5. Tap an item to view the directions on the map.
6. Tap the arrow buttons on the map to follow the directions.

When you're finished viewing or following the directions, press  and then tap **Clear Map** to reset the map. Your destination is automatically saved in the Google Maps history.

Getting help

Get help and more information about Maps.





To open the help, press , and then tap **More > Help**. The web browser opens and takes you to the Google Maps Help site.

Finding your friends with Google Latitude (available by country)

Google Latitude® user location service lets you and your friends share locations and status messages with each other. It also lets you get directions to your friends' locations, send your location details by email, and more.

Your location is not shared automatically. You must join Latitude, and then invite your friends to view your location or accept their invitations. Only friends that you have explicitly invited or accepted can see your location.

Opening and joining Latitude

1. From the Home screen, tap  > **Maps**.
2. While viewing a map, press  and then tap **Join Latitude**.
3. After you've joined Latitude and closed the application, you can do any of the following to open it from the Home screen:
 - Tap  > **Latitude**.
 - Open Maps, press , and then tap **Latitude**.

HTC Sync

About HTC Sync

You have your new vacation photos on HTC Explorer while your business calendar is on your computer. Why not make your files and information available on both devices?

With HTC Sync, you can:

- Sync your contacts between your Microsoft Outlook, Outlook Express or Windows Contacts on your computer and HTC Explorer.
- Sync your calendar events between the Outlook or Windows Calendar on your computer and HTC Explorer.
- Bring your photos, videos, documents, songs, and playlists to HTC Explorer and enjoy them on the go.
- Easily import your captured photos and videos from HTC Explorer to your computer.
- Store the same web bookmarks on both your computer and HTC Explorer.
- Install third-party mobile apps from your computer.



You need a storage card inserted into HTC Explorer to be able to sync multimedia files and documents.

Installing HTC Sync



- HTC Sync requires USB 2.0 on your computer to connect and sync with HTC Explorer.
- For trouble-free installation, first quit all running programs and temporarily exit from your anti-virus program before you start installing HTC Sync.

Do either of the following:

- Check and copy the HTC Sync installer from the storage card (if available), and then install it on your computer.
- Download the HTC Sync software for HTC Explorer from our support website (www.htc.com/support/) and install it on your computer.

Setting up HTC Sync to recognize HTC Explorer

1. Connect HTC Explorer to your computer using the USB cable that came in the box.
2. When HTC Explorer prompts you to choose a type of USB connection, tap **HTC Sync**, and then tap **Done**. Wait for HTC Sync to recognize HTC Explorer.
3. On the Device setup screen, enter a name for HTC Explorer.
4. Click **Save**. The Device panel then opens.



To change the name of HTC Explorer later, click **Overview** > **Device setup**.

Getting to know the workspace

On the Device panel, you can set your sync options, see general information about HTC Explorer, check the used and available storage space, and begin synchronization.



The available categories and options depend on the device you've connected to your computer.

- You can click a category of items to see its sync options on the right side of the Device panel.
Clicking **Overview** displays basic software information and storage usage, and lets you change the name of HTC Explorer, or install third-party applications to HTC Explorer.
- The **Sync now** button lets you start syncing the categories and options you've selected.
- The estimated storage usage bar beside the **Sync now** button shows you the estimated storage space that will be used when there are new items to be synchronized and added to HTC Explorer.

Setting up synchronization

You can choose the types of files and information you want to sync between HTC Explorer and your computer.

Music sync options

Bring the music tracks and songs you play on your computer to HTC Explorer. If you have playlists created in iTunes® or Windows Media® Player, you can sync these too and enjoy them on the go.



You can sync audio files in these formats: *.aac, *.amr, *.m4a, *.mid, *.midi, *.mp3, *.wav, *.wma

1. On the Device panel, click **Music**, and then click the **On** button. Turning Music sync on means you want this category included every time you sync your computer and HTC Explorer.
2. Select **Sync music files from**, and then click **Add**.
3. Choose a folder that contains your audio files, and then click **OK**.
4. Select **Sync music files from iTunes and Windows Media Player** if you're using either of these software on your computer, and then choose the playlists you want to sync on HTC Explorer.

Gallery sync options

You can automatically sync photos and videos between HTC Explorer and a computer.



You can sync photos and videos in these formats:

- Photos: *.bmp, *.gif, *.jpeg, *.jpg, *.png
- Videos: *.3gp, *.3g2, *.mp4, *.wmv

1. On the Device panel, click **Gallery**, and then click the **On** button. Turning Gallery sync on means you want this category included every time you sync your computer and HTC Explorer.
2. To automatically import your camera shots to your computer during synchronization, select **Copy device Camera Shots to PC**. Photos and videos from HTC Explorer will be saved to the \My Photos\Device Camera Shots folder on your computer.
3. Select **Sync PC photos & videos from**, and then click **Add**.
4. Choose a folder that contains your multimedia files, and then click **OK**. All supported image and video files added to this folder will be copied to HTC Explorer during synchronization.

Calendar sync options

HTC Explorer can sync appointments and events with your calendar in Outlook (Outlook XP, Outlook 2003 or Outlook 2007) or Windows Calendar.

1. On the Device panel, click **Calendar**, and then click the **On** button. Turning Calendar sync on means you want this category included every time you sync your computer and HTC Explorer.
2. Select the application you want to sync calendar events with.
3. Choose from which point you want to start synchronizing your calendar events.
4. In cases when conflicting information is found on both HTC Explorer and the computer, choose which information you want to keep.



Only the calendar fields supported on HTC Explorer will be synchronized.

People sync options

Sync HTC Explorer contacts with your Outlook (Outlook XP, Outlook 2003 or Outlook 2007), Outlook Express, or Windows Contacts.

If you have contacts to sync from your SIM card, you have to import these first to HTC Explorer storage.

1. On the Device panel, click **People**, and then click the **On** button. Turning People sync on means you want this category included every time you sync your computer and HTC Explorer.
2. Choose the application you want to sync your contacts with.
3. In cases when conflicting information is found on both HTC Explorer and the computer, choose which information you want to keep.



Only the contact fields supported on HTC Explorer will be synchronized.

Bookmarks sync options

Sync web browser bookmarks between HTC Explorer and a computer.



If you are using Google Chrome™ or Firefox® Internet browser and have selected it to sync with HTC Explorer, make sure to close all browser windows before you begin synchronization.

1. Using your favorite web browser on your computer, create a favorites folder named **HTC bookmarks**. Make sure to save your favorite bookmarks in this folder to be able to sync them with HTC Explorer.
2. On HTC Sync's Device panel, click **Bookmarks**, and then click the **On** button. Turning Bookmarks sync on means you want this category included every time you sync your computer and HTC Explorer.
3. Choose the web browser that stores the bookmarks to sync with HTC Explorer.



When conflicting information is found on both HTC Explorer and computer, HTC Sync keeps the information from your computer.

Documents sync options

You can sync files and documents from your computer to HTC Explorer. You can also sync email attachments that you stored on HTC Explorer to your computer.



- To open a document on HTC Explorer, you'll need a compatible app.
- To sync email attachments stored on HTC Explorer to your computer, you must set up an Exchange ActiveSync or POP3/IMAP email account from the Mail app on HTC Explorer.

1. On the Device panel, click **Documents**, and then click the **On** button. Turning Documents sync on means you want this category included every time you sync your computer and HTC Explorer.
2. To sync email attachments that you've stored on HTC Explorer, select **Copy all download Mail documents to PC**.
3. Select **Sync PC documents from**, and then click **Add**.
4. Choose a folder that contains the documents you want to sync on HTC Explorer, and then click **OK**.

Email attachments will be saved on the `\My Documents\` folder.

Synchronizing HTC Explorer

Check the estimated usage bar beside the **Sync now** button for the estimated file size of new items to sync on HTC Explorer.

1. After selecting and customizing the categories you want to sync, click **Sync now**.
2. After synchronization is complete, click **Disconnect**.
3. Safely remove HTC Explorer as required by your computer's operating system.

The next time you connect HTC Explorer to your computer, synchronization automatically begins based on your sync settings.

Installing an app from your computer to HTC Explorer

If you have application files (*.apk) on your computer, you can use HTC Sync to install them to HTC Explorer. We strongly recommend you install only applications that you trust.



Before you begin, make sure that HTC Explorer is set to allow applications from your computer to be installed to HTC Explorer. To do this, press  while on the Home screen, tap **Settings** > **Applications**, and then select the **Unknown sources** check box.

1. On the Device panel, click **Overview**.
2. Click **Application installer**.
3. Browse for the application file on your computer, and then click **Open**. The installation process starts on HTC Explorer.
4. Check the screen on HTC Explorer to see if there are additional instructions to complete the installation.
5. After installation is complete, you can click **Disconnect**.
6. Safely remove HTC Explorer as required by your computer's operating system.

Synchronizing another device with your computer

You can switch from one device to another, if you have more than one device to sync.

1. Connect another device to your computer, then set up HTC Sync to recognize it.
2. Click the device you want to set up or begin synchronization. The Device panel then opens, where you can separately customize your sync settings for this device.

To switch to another device to sync, click **Devices**, and then click the device's name or image.

Downloading the latest HTC Sync upgrade

Visit the HTC support website (www.htc.com/support/) from time to time to check for the most recent HTC Sync upgrade so you can download and install it on your computer.

After installing the latest upgrade, set up HTC Sync again to recognize and sync with HTC Explorer.

HTC Confidential 2011/09/16

HTCSense.com

Signing up for your HTCSense.com account

You can sign up for your HTCSense.com account on HTC Explorer or your computer's web browser.

Signing up from HTC Explorer

1. From the Home screen, press , and then tap **Settings > Accounts & sync**.
2. Tap **Add account > HTC Sense**.
3. Follow the onscreen instructions to sign up for your HTCSense.com account.

Signing up from your computer

Make sure you have HTC Explorer close by. You'll need it to complete the sign-up process.

1. On your computer, open your web browser.
2. Go to www.htcsense.com.
3. Follow the onscreen instructions to sign up for your HTCSense.com account.

After signing up to HTCSense.com on the Web, you have to sign in using the same account credentials on HTC Explorer.

Updating your HTCSense.com account details

1. On your computer, open your web browser and sign in to your HTCSense.com account.
2. On the upper-right corner, click **Account**.
3. Update your account details, and then click **Save Changes**.

Turning on Device finder

Some features of HTCSense.com require that the Device finder option on HTC Explorer is selected.

1. On HTC Explorer, from the Home screen, press , and then tap **Settings**.
2. Tap **Location**.
3. Select the **Device finder** check box.

Using HTCSense.com

Forgot HTC Explorer at home or you can't find it? Or worse, it slipped out of your pocket while riding the train. Use HTCSense.com to communicate with HTC Explorer so you can forward calls and messages to a different number, make HTC Explorer ring, lock it, and even erase its contents.

 To use these features, you'll need to sign in to HTCSense.com on a computer web browser.

Making HTC Explorer ring

You know HTC Explorer is somewhere in your home but you just can't find it. Make HTC Explorer ring, even if it's on mute, so that you can find it. Hopefully, it's just buried under some clothes in the hamper.

On HTCSense.com, click **Ring**.

Forwarding calls and messages

You can forward calls and messages to another phone if you don't have HTC Explorer with you.

 Before turning on **Forward calls** or **Forward messages**, you need to customize settings first such as specifying an alternate phone number or email address.

- To forward calls, click the **Forward calls** On/Off switch. (Be sure that **Enable call forwarding** is selected in **Settings**.)
- To forward messages, click the **Forward messages** On/Off switch. (You should select **Forward messages to device** or **Forward messages to an email address** in **Settings**.)

Locating HTC Explorer

Left HTC Explorer somewhere while doing your errands? You can use HTCSense.com to find its approximate location.

 You must have the **Phone finder** option selected in **Settings > Location** on HTC Explorer for this feature to work.

On HTCSense.com, check the map to see where HTC Explorer is. Click **Refresh location** to refresh the map.

Locking HTC Explorer

Lost HTC Explorer? Lock HTC Explorer and show a message onscreen so if somebody finds it, they can contact you.

1. On HTC Sense.com, click **Lock device**.
2. Enter a PIN, an alternate phone number to call if somebody finds HTC Explorer, and a short message to show onscreen.



The alternate number is shown on the screen. If somebody happens to find HTC Explorer, that person can simply tap it to call that number using HTC Explorer.

3. Click **Save**.

Erasing the contents of HTC Explorer

If there's no chance of getting HTC Explorer back, you can erase the contents of HTC Explorer and the installed storage card so no one sees sensitive information on HTC Explorer.



There's no way to recover HTC Explorer and storage card data after you erase the contents so be absolutely sure before you proceed.

1. On HTC Sense.com, click **Erase device**.
2. When asked to confirm, click **Erase device**.



Deleting your HTC Sense.com account

1. On your computer, open your web browser and sign in to your HTC Sense.com account.
2. On the upper-right corner, click **Account**.
3. Click **Click here to delete your HTC Sense account**.

Deleting your HTC Sense.com account will also delete your data on HTC Sense.com servers.

Keyboard

Using the onscreen keyboard

When you start an app or select a field that requires text or numbers, the onscreen keyboard becomes available. After entering your text, you can tap  or press  to close the onscreen keyboard.

Selecting a keyboard layout







You can choose from three different keyboard layouts to suit your typing style.

1. From the Home screen, press , and then tap **Settings** > **Language & keyboard** > **Touch Input**.
2. Tap **Keyboard types**, and then select the keyboard layout that you want to use.

| | |
|-----------------|--|
| Standard | This layout is similar to a desktop computer keyboard. This is the default keyboard layout. |
| Phone | This layout resembles the traditional mobile phone keypad. |
| Compact | This layout features two letters on each key. The key size is slightly bigger than on the Standard layout. |

Entering text

Use the following keys while entering text using the onscreen keyboard:

| | |
|---|--|
|  | Press and hold keys with gray characters at the top to enter numbers, symbols, or accented letters. The gray character displayed on the key is the character that will be inserted when you press and hold that key. Some keys have multiple characters or accents associated with them. |
|  | Shift key. Tap to enter an uppercase letter. Tap twice to turn on caps lock. |
|  | Tap to switch to the numeric and symbol keyboard. |
|  | Enter key. Tap to create a new line. |
|  | Backspace key. Tap to delete the previous character. |
|  | Language key. The key you see depends on the keyboard language you are currently using. Tap to switch to another keyboard language. You can also access onscreen keyboard settings. |



Tap to toggle between Multitap and XT9 predictive modes when using the Compact or Phone keyboard layout.



Tap to hide the onscreen keyboard.

Enabling multiple keyboard languages

If there are multiple keyboard languages available on HTC Explorer, you can choose which languages to enable in the onscreen keyboard so that you can switch to these languages and use them to enter text.

1. From the Home screen, press , and then tap **Settings > Language & keyboard > Touch Input**.
2. Tap **International keyboard**.
3. Choose the languages you want.



Available languages depend on the region where you purchased HTC Explorer.

Changing to the landscape onscreen keyboard

When entering text, you can choose to use the landscape orientation of the onscreen keyboard. Turn HTC Explorer sideways to use a larger keyboard for easy typing.



- Select the **Auto-rotate screen** check box in **Home > Menu > Settings > Display** to allow the screen orientation to automatically change.
- The landscape orientation keyboard is not supported in all apps.

Entering words with predictive text

The onscreen keyboard has predictive text to help you type quickly and accurately. Predictive text input is enabled by default, and word suggestions are displayed as you type.

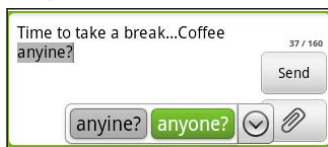

To enter a word in predictive mode, do any of the following:

- If you see the word you want highlighted in green or orange, just tap the space bar to insert the word into your text.
- If you see the word you want shown in the suggestions before you have finished typing the entire word, tap the word to insert it into your text.
- If an arrow is shown to the right of the suggestion list, tap the arrow to see more suggestions.

Setting a second language for the keyboard



Aside from the keyboard language you are currently using, you can set the predictive text to be bilingual. As you type, you'll get word suggestions in two languages that you've selected.

1. From the Home screen, press , and then tap **Settings > Language & keyboard > Touch Input**.
2. Tap **Bilingual prediction**, and then choose the language you want.

Adding a word to the predictive text dictionary



HTC Explorer comes with a list of words that it references for predictive text suggestions. While entering text using the Standard keyboard layout, if you tap any word on the suggestion list, it is automatically added to the predictive text dictionary if it was not in the dictionary already.

You can also add a word to the list manually.

1. From the Home screen, press , and then tap **Settings > Language & keyboard > Touch Input**.
2. Tap **Personal dictionary > Edit personal dictionary > **.
3. Enter the word to add, and then tap **OK**.

Editing or deleting a word in the predictive text dictionary

You can edit or remove words that you previously added to the predictive text dictionary.

1. From the Home screen, press , and then tap **Settings > Language & keyboard > Touch Input**.
2. Tap **Personal dictionary > Edit personal dictionary**.
 - To edit a word, tap the word itself.
 - To delete words from the dictionary, press  and tap **Delete**. Then choose the words to remove and tap **Delete**.

Backing up your personal dictionary to your storage card

If you have a storage card installed, you can back up the new words you've added to the predictive text dictionary.

1. From the Home screen, press , and then tap **Settings > Language & keyboard > Touch Input**.
2. Tap **Personal dictionary > Sync personal dictionary > Copy to storage card**.
3. When prompted, tap **OK**.

Importing your personal dictionary from your storage card

1. From the Home screen, press , and then tap Settings > Language & keyboard > Touch Input.
2. Tap Personal dictionary > Sync personal dictionary > Restore from storage card.
3. When prompted, tap OK.

Entering text by speaking

No time to type? Try speaking the words to enter them in most text fields that let you use the onscreen keyboard.



- First make sure to select the language you'll be using in the **Voice input & output** settings.
- Since HTC Explorer uses Google's speech-recognition service, you need to be connected to the Internet to enter text by speaking.

1. Press and hold the language key. HTC Explorer cues you to speak.
2. Tell HTC Explorer what you want to be typed in.

Setting the voice input language

1. From the Home screen, press , then tap Settings > Voice input & output > Voice recognizer settings.
2. Tap **Language**, then choose the language you want.



Available languages depend on the voice input languages supported by Google.

Entering text by tracing

Instead of tapping the keys on the onscreen keyboard, you can “trace” to type words.

 Trace keyboard in Settings > Language & keyboard > Touch Input > Trace keyboard must be selected for you to use the Trace keyboard.

To trace, slide your finger on the onscreen keyboard to enter words. For example, if you want to type “the”, put your finger on the “t” key, and then trace the word (by sliding your finger) “the” on the onscreen keyboard.

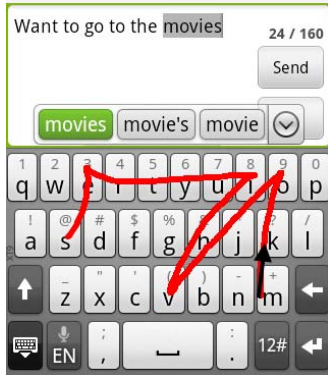

Editing text

It's easy to cut, copy, and paste text using the keyboard.



Some apps may offer their own way of selecting or copying text.

Selecting text

Highlight the text that you want to copy or cut.

1. Press and hold the text field that contains the text to select until the magnifier appears.

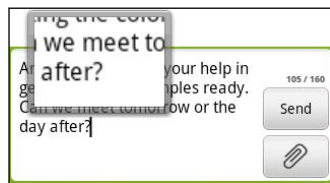

2. Drag your finger to move the text cursor to a letter within the text that you want to select.

3. After positioning the text cursor, lift your finger. The text selection menu then pops up.
4. Do one of the following:
 - Tap **Select word**. When the word where you've placed the text cursor is highlighted, drag the start and end markers to select the text you want.

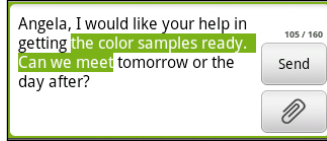



- Tap **Select all** to select everything in the text field.

Copying and pasting text

1. After you have selected the text you want to copy, tap **Copy** or **Cut**. The selected text is then copied to the clipboard.
2. Press and hold a text field in the same or other app until the magnifier appears.
3. Drag your finger to move the text cursor to where you want to paste the text.
4. After positioning the text cursor, lift your finger. The text selection menu then pops up.
5. Tap **Paste**.

Adjusting input settings

Open the Touch Input settings by doing one of the following:

- From the Home screen, press , and then tap **Settings > Language & keyboard > Touch Input**.
- On the onscreen keyboard, tap the language key (for example, tap  if you're currently using the English onscreen keyboard). Then on the International keyboard options menu, tap **Settings**.

You must have more than two keyboard languages selected before you can access Touch Input settings using the language key.

| | |
|-------------------------------|---|
| Keyboard types | Select the keyboard layout to use. |
| International keyboard | Add or remove languages from the onscreen keyboard language list. |
| Bilingual prediction | Select a secondary keyboard language to use. |
| Text input | <ul style="list-style-type: none"> ▪ Turn on or off predictive text, spell correction, and word completion. ▪ Enable audible or vibration feedback when typing. ▪ Calibrate the touch keyboard accuracy. |

| | |
|----------------------------|--|
| Tutorial | Learn how to use the onscreen keyboard with this interactive tutorial. |
| Trace keyboard | Turn on Trace keyboard and set options when tracing to enter text. |
| Personal dictionary | Add, edit, or remove words in the predictive text dictionary. |

HTC Confidential 2011/09/16

Internet connections

Data connection

When you turn on HTC Explorer for the first time, it will be automatically set up to use your mobile operator's data connection (if the SIM card is inserted).

Checking the data connection you're using

1. From the Home screen, press , and then tap **Settings > Wireless & networks**.
2. Tap **Mobile networks > Network operators or Access Point Names**.



Turning the data connection on or off

Turning your data connection off can help save battery life and save money on data charges. However, if you don't have data connection turned on and you're also not connected to a Wi-Fi network, you won't receive automatic updates to your email, social network accounts, and other synchronized information.

1. From the Home screen, press , and then tap **Settings > Wireless & networks**.
2. Select the **Mobile network** check box to turn on the data connection; clear the check box to turn off the data connection.

Adding a new access point

Before you add another data connection, have the access point name and settings (including username and password if required) from your mobile operator ready.

1. From the Home screen, press , and then tap **Settings > Wireless & networks**.
2. Tap **Mobile networks > Access Point Names**.
3. On the APNs screen, press  and then tap **New APN**.
4. On the Edit access point screen, enter the APN settings. Tap an APN setting item to edit it.
5. Press  and then tap **Save**.

Enabling data roaming

Connect to your mobile operator's partner networks and access data services when you're out of your mobile operator's coverage area.



Using data services while roaming will be costly. Check with your mobile operator for data roaming rates before you use data roaming.

1. From the Home screen, press , and then tap **Settings > Wireless & networks**.
2. Tap **Mobile networks**, and then select the **Data roaming** check box.

Select the **Data roaming sound** check box if you'd like HTC Explorer to play a sound so you'll know when it's connecting to a roaming network.

Wi-Fi

To use Wi-Fi, you need access to a wireless access point or "hotspot". The availability and strength of the Wi-Fi signal will vary depending on objects, such as buildings or simply a wall between rooms, the Wi-Fi signal has to pass through.

Turning Wi-Fi on and connecting to a wireless network

1. From the Home screen, press , and then tap **Settings > Wireless & networks**.
2. Select the **Wi-Fi** check box to turn Wi-Fi on.
HTC Explorer then scans for available wireless networks.
3. Tap **Wi-Fi settings**.

Detected Wi-Fi networks will be listed in the Wi-Fi networks section.



If the wireless network that you want is not listed, tap **Add Wi-Fi network** to manually add it.

4. Tap the Wi-Fi network you want to connect to.



If you selected a secured network, you'll be asked to enter the network key or password.

5. Tap **Connect**.

When HTC Explorer is connected to the wireless network, the Wi-Fi icon  appears in the status bar and tells you the approximate signal strength (number of bands that light up).

The next time HTC Explorer connects to a previously accessed secured wireless network, you won't be asked to enter the key or other security information again, unless you reset HTC Explorer to its factory default settings.

Connecting to a Wi-Fi network with EAP-TLS security

You may need to install a network certificate (*.p12) to HTC Explorer before you can connect to a Wi-Fi network with EAP-TLS authentication protocol.

1. Save the certificate file to the root folder of the storage card.
2. From the Home screen, press , and then tap **Settings > Security**.
3. Tap **Install from SD card**.
4. Select the network certificate needed to connect to the EAP-TLS network.
5. Turn on Wi-Fi and connect to a wireless network.

Checking the wireless network status



1. From the Home screen, press , and then tap **Settings > Wireless & networks**.
2. On the Wireless & networks screen, tap **Wi-Fi settings**, and then tap the wireless network that HTC Explorer is currently connected to.

A message box is then displayed showing the Wi-Fi network name, status, speed, signal strength, and more.



If you want to remove the settings for this network, tap **Forget**. If you want to reconnect to a wireless network that you have removed, you'll need to choose the wireless network from the list of available Wi-Fi networks again. If it is a secured wireless network, you'll need to enter the wireless network credentials again.

Connecting to another Wi-Fi network

1. From the Home screen, press , and then tap **Settings > Wireless & networks**.
2. Tap **Wi-Fi settings**. Detected Wi-Fi networks are displayed in the Wi-Fi networks section.
3. To manually scan for available Wi-Fi networks, on the Wi-Fi screen, press , and then tap **Scan**.
4. Tap another Wi-Fi network to connect to it.

Connecting to a virtual private network (VPN)

Add, set up, and manage virtual private networks (VPNs) so you can connect and access resources inside a secured local network, such as your corporate network.

Depending on the type of VPN you're using at work, you may be asked to enter your login credentials and install security certificates before you can connect to your company's local network. You can get this information from your network administrator.

Also, HTC Explorer must first establish a Wi-Fi or data connection before you can start a VPN connection.



Setting up secure credential storage

If your network administrator tells you to download and install security certificates, you must first set up secure credential storage on HTC Explorer.

1. From the Home screen, press , and then tap **Settings > Security**.
2. Tap **Set password**.
3. Enter a new password for the credential storage.
4. Scroll down and confirm the password, and then tap **OK**.
5. Select the **Use secure credentials** check box.



You can then download and install the certificates needed to access your local network. Your network administrator can tell you how to do this.

Adding a VPN connection

1. From the Home screen, press , and then tap **Settings > Wireless & networks**.
2. Tap **VPN settings > Add VPN**, and then tap the type of VPN you want to add.
3. Tap the VPN settings and set them up according to the security details your network administrator gave you.
4. Press , and then tap **Save**.

The VPN is then added to the VPNs section of the VPN settings screen.

Connecting to a VPN

1. From the Home screen, press , and then tap **Settings > Wireless & networks**.
2. Tap **VPN settings**.
3. In the VPNs section, tap the VPN that you want to connect to.
4. When asked, enter your log in credentials, and then tap **Connect**. When you're connected, the VPN connected icon  appears in the notification area of the title bar.

You can then open the web browser to access resources such as your corporate network intranet.

Disconnecting from a VPN

1. Press and hold the title bar, and then slide down your finger to open the Notifications panel.
2. Tap the VPN connection to return to the VPN settings screen, and then tap the VPN connection to disconnect from it.

When HTC Explorer has disconnected from the VPN, the VPN disconnected icon  is displayed in the notification area of the title bar.

Using HTC Explorer as a modem (USB tethering)

No Internet connection available for your computer? No problem. Use the Internet connection of HTC Explorer to connect to the Internet.



- You need your SIM card inserted on HTC Explorer to use the data connection.
- To use HTC Explorer as a modem, you need to install HTC Sync on your computer first.
- You must have an approved data plan associated with your account from your mobile service provider to use this service.

1. Make sure the data connection on HTC Explorer is turned on.
2. Connect HTC Explorer to the computer using the provided USB cable.
3. On the Choose a connection type screen, select **USB tethering**, and then tap **Done**.

Connecting HTC Explorer to the Internet through a computer (Internet Pass-through)

If you temporarily don't have Internet access, you can still go online on HTC Explorer by using your computer's Internet connection.



Before you can use your computer as a modem, be sure to install HTC Sync on your computer first.

1. Make sure your computer is connected to the Internet.



Two things to check for your computer's Internet connection. One, you may need to turn off your local network's firewall. Two, if your computer connects to the Internet via PPP (e.g. Dial UP, xDSL, or VPN), Internet Pass-through will only support TCP protocol.

2. Connect HTC Explorer to the computer using the provided USB cable.
3. On the Choose a connection type screen, select **Internet pass-through**, and then tap **Done**.

Bluetooth

Bluetooth basics

Turning Bluetooth on or off

1. From the Home screen, press , and then tap **Settings** > **Wireless & networks**.
2. Select or clear the **Bluetooth** check box.

An even easier way to turn Bluetooth on or off is with the Bluetooth widget on the Home screen.



Turn off Bluetooth when not in use to save battery power, or in places where using a wireless device is prohibited, such as on board an aircraft and in hospitals.

Changing the device name

The device name identifies HTC Explorer to other devices.

1. From the Home screen, press , and then tap **Settings** > **Wireless & networks**.
2. Tap **Bluetooth settings**.
3. If the **Bluetooth** check box is not selected, select it to turn Bluetooth on.
4. Tap **Device name**.
5. Enter the new name for HTC Explorer in the dialog box, and then tap **OK**.

Connecting a Bluetooth headset or car kit

You can listen to music over a Bluetooth stereo headset, or have hands-free conversations using a compatible Bluetooth headset or car kit. It's the same procedure to set up stereo audio and hands-free.



- For you to listen to music with your headset or car kit, the headset or car kit must support the A2DP Bluetooth profile.
- Before you connect your headset, you need to make it discoverable so HTC Explorer can find it. You can find out how to do this by referring to your headset manual.

1. From the Home screen, press , and then tap **Settings** > **Wireless & networks**.
2. Tap **Bluetooth settings**.
3. If the **Bluetooth** check box is not selected, select it to turn Bluetooth on.

4. Make sure that the headset is discoverable.
5. Tap **Scan for devices**. HTC Explorer will start to scan for Bluetooth devices within range.
6. When you see the name of your headset displayed in the Bluetooth devices section, tap the name. HTC Explorer then automatically tries to pair with the headset.
7. If automatic pairing fails, enter the passcode supplied with your headset.

The pairing and connection status is displayed below the hands-free headset or car kit name in the Bluetooth devices section. When the Bluetooth headset or car kit is connected to HTC Explorer, the Bluetooth connected icon  is displayed in the status bar. Depending on the type of headset or car kit you have connected, you can then start using the headset or car kit.

Reconnecting a headset or car kit

Normally, you can easily reconnect your headset by switching on Bluetooth on HTC Explorer, and then turning on the headset. However, you might have to connect manually if your headset has been used with another Bluetooth device.

1. From the Home screen, press , and then tap **Settings > Wireless & networks**.
2. Tap **Bluetooth settings**.
3. If the **Bluetooth** check box is not selected, select it to turn Bluetooth on.
4. Make sure that the headset is discoverable.
5. Tap the headset's name in the Bluetooth devices section.
6. If prompted to enter a passcode, try 0000 or 1234, or consult the headset/car kit documentation to find the passcode.

If you still cannot reconnect to the headset or car kit, follow the instructions in [Unpairing from a Bluetooth device](#) on page 157, and then follow the steps under [Connecting a Bluetooth headset or car kit](#) on page 155.

Disconnecting or unpairing from a Bluetooth device

Disconnecting a Bluetooth device

1. From the Home screen, press , and then tap **Settings > Wireless & networks**.
2. Tap **Bluetooth settings**.
3. In the Bluetooth devices section, press and hold the device to disconnect.
4. Tap **Disconnect**.

Unpairing from a Bluetooth device

You can make HTC Explorer forget its pairing connection with another Bluetooth device. Doing so may require you to enter or confirm a passcode again if you want to reconnect to the other device.

1. From the Home screen, press , and then tap **Settings > Wireless & networks**.
2. Tap **Bluetooth settings**.
3. In the Bluetooth devices section, press and hold the device to unpair.
4. Tap **Disconnect & unpair**, or tap **Unpair** if the Bluetooth device is currently not connected to HTC Explorer.

Sending information using Bluetooth



You can use Bluetooth to send information from HTC Explorer to another Bluetooth enabled device such as a phone or notebook computer. You can send the following types of information, depending on the device you are sending to:



- Images and videos
- Calendar events
- Contacts
- Audio files



Before you begin, set the receiving device to discoverable mode. You may also need to set it to “Receive Beams” or “Receive Files”. Refer to the device’s documentation for instructions on receiving information over Bluetooth.

1. On HTC Explorer, open the app that contains the information or file you want to send.
2. Follow the steps for the type of item you want to send:

| | |
|--------------------------------|--|
| Captured photo or video | After capturing, on the Camera preview screen, tap  , and then tap Bluetooth . |
| Photos or videos | <ol style="list-style-type: none"> 1. On the Gallery app, choose an album. 2. Tap  > Bluetooth. 3. Choose the photos and videos you want to share, and then tap Next. |
| Contact | <ol style="list-style-type: none"> 1. On the People app, tap a contact to view the contact’s details. 2. Press  and then tap Send contact. 3. Tap the down arrow icon, and then select Bluetooth. 4. Choose which details to share, and then tap Send. |

| | |
|--------------------------------------|---|
| Calendar appointment or event | In Day view, Agenda view, or Week view, press and hold the event, and then tap Forward > Bluetooth . |
| Music track | <ol style="list-style-type: none"> 1. With the track displayed on the Music app's Now playing screen, tap  > Share > Share file. 2. Tap Bluetooth. |
| Voice recording | On the main Voice Recorder screen, tap  , and then tap Bluetooth . |

3. Turn on Bluetooth if you're asked to do so.
4. If you haven't paired with the receiving device before, tap **Scan for devices**.
5. Tap the name of the receiving device.
6. If prompted, accept the pairing request on HTC Explorer and on the receiving device. Also enter the same passcode or confirm the auto-generated passcode on both devices.
7. On the receiving device, accept the file.

Where sent information is saved

When you send information using Bluetooth, the location where it's saved depends on the type of information and the receiving device.

If you send a calendar event or contact, it is normally added directly to the corresponding application on the receiving device. For example, if you send a calendar event to a compatible phone, the event is shown in that phone's calendar application.

If you send another file type to a Windows computer, it is normally saved in the Bluetooth Exchange folder within your personal document folders.

- On Windows XP, the path may be: `C:\Documents and Settings\[your username]\My Documents\Bluetooth Exchange`
- On Windows Vista, the path may be: `C:\Users\[your username]\Documents`
- On Windows 7, the path may be: `C:\Users\[your username]\My Documents\Bluetooth Exchange Folder`

If you send a file to another device, the saved location may depend on the file type. For example, if you send an image file to another mobile phone, it may be saved in a folder named "Images".

Receiving information using Bluetooth

HTC Explorer lets you receive various files with Bluetooth, including photos, music tracks, and documents such as PDFs.

1. From the Home screen, press , and then tap **Settings > Wireless & networks**.
2. Tap **Bluetooth settings**.

3. If the **Bluetooth** check box is not selected, select it to turn Bluetooth on.
4. Select the **Discoverable** check box.
5. On the sending device, send one or more files to HTC Explorer. Refer to the device's documentation for instructions on sending information over Bluetooth.
6. If asked, accept the pairing request on HTC Explorer and on the receiving device. Also enter the same passcode or confirm the auto-generated passcode on both devices.

You'll then get a Bluetooth authorization request.

7. If you want to automatically receive files from the sending device in future, select the **Always** check box.
8. Tap **Accept** or **OK**.
9. When HTC Explorer receives a file transfer request notification, slide down the Notifications panel, tap the incoming file notification, and then tap **Accept**.
10. When a file is transferred, a notification is displayed. To open the file immediately, slide down the Notifications panel, and then tap the relevant notification.

When you open a received file, what happens next depends on the file type:

- Media files and documents are usually opened directly in a compatible app. For example, if you open a music track, it starts playing in the Music app.
- For a vCalendar file, choose the calendar where you want to save the event, and then tap **Import**. The vCalendar is added to your Calendar events.
- For a vCard contact file, you can choose to import one, several, or all of those contacts to your contacts list.

Adding the Bluetooth received folder to the Home screen

You can add a folder to the Home screen that shows all files you have received with Bluetooth.

1. From the Home screen, press  and then tap **Personalize**.
2. On the Personalize screen, tap **Folder > Bluetooth received**.
3. Press and hold the Bluetooth received folder icon, and drag it to the Home screen position you want.

To view the folder contents, tap the folder icon. To open a file, tap the file name.

Security

Protecting your SIM card with a PIN

Add another layer of security for HTC Explorer by assigning a PIN (personal identification number) to your SIM.

Make sure you have the default SIM PIN provided by your mobile operator before continuing.

1. From the Home screen, press , and then tap **Settings** > **Security**.
2. Tap **Set up SIM card lock**, then select **Lock SIM card**.
3. Enter the default SIM card PIN, and then tap **OK**.
4. To change the SIM card PIN, tap **Change SIM PIN**.

Restoring a SIM card that has been locked out

If you enter the wrong PIN more times than the maximum number of attempts allowed, your SIM card will become “PUK-locked.”

You need a PUK code to restore access to HTC Explorer. This code may have been provided by your mobile operator when you received your SIM card.

1. On the Phone dialer screen, enter the PUK code, and then tap **Next**.
2. Enter the new PIN you want to use, and then tap **Next**.
3. Enter the new PIN again, and then tap **OK**.

Protecting HTC Explorer with a screen lock pattern, PIN, or password

Protect your personal information and prevent others from using HTC Explorer without your permission by setting a screen lock pattern, PIN or password.

Your screen lock will be asked every time HTC Explorer is turned on or when it's idle for a certain period of time.

1. From the Home screen, press , and then tap **Settings** > **Security**.
2. Tap **Set up screen lock**.

3. Tap one of the following:

| | |
|-----------------|---|
| None | Disable the screen lock you've previously created. |
| Pattern | Set a screen lock pattern by following the onscreen instructions. |
| PIN | Set a numeric password of at least four digits. |
| Password | Set an alpha-numeric password. |

4. On the Security screen, tap **Lock phone after**, then specify the idle time you can allow before the screen is locked.



You can also clear the **Use visible pattern** or **Visible passwords** on the Security screen if you don't want your screen lock to display as you enter it onscreen.

Changing your screen lock

1. From the Home screen, press , and then tap **Settings > Security**.
2. Tap **Change screen lock**.
3. Enter your current screen lock to confirm that you want to change it.
4. Choose a different screen lock type, then enter your new pattern, PIN, or password. Or tap **None** if you don't want to use a screen lock.

Forgot your screen lock pattern?

If you've forgotten your screen lock pattern, you have up to five attempts to try and unlock HTC Explorer.

If this fails, you can unlock HTC Explorer by entering your Google Account user name and password.

1. On the unlock screen, enter your lock pattern.
2. After the fifth attempt, when you're asked to wait for 30 seconds, tap **OK**.
3. If the display goes off, press the **POWER** button to turn the display back on, and then unlock the screen.
4. Tap the **Forgot pattern?** button when it appears.
5. Enter your Google Account name and password, and then tap **Sign in**. You'll then be asked to create a new screen lock pattern. If you no longer want to do so, tap **Cancel**.

Encrypting data on HTC Explorer

You can encrypt data on HTC Explorer such as your online accounts, settings, and other information.

1. From the Home screen, press , and then tap **Settings**.
2. Tap **SD & phone storage**.
3. Under Internal storage, tap **Storage encryption**.
4. Set a password, and then tap **OK**. The encryption process starts.

If you want to stop encrypting new information on HTC Explorer, deselect the **Storage encryption** checkbox.

HTC Confidential 2011/09/16

Settings

Settings on HTC Explorer

Control and customize phone settings on the Settings screen.

From the Home screen, press , and then tap **Settings**.

| | |
|---------------------|--|
| Personalize | Make HTC Explorer truly yours with the various personalization options available. |
| Wireless & networks | Set up wireless connections, such as Wi-Fi, data connection, and Bluetooth, enable Airplane mode, and more. |
| Call | Set up call services such as voicemail, call forwarding, call waiting, and caller ID. |
| Sound | <ul style="list-style-type: none"> ▪ Choose sounds to use for the ringtones and notifications. ▪ Adjust media playback volume. ▪ Set to lower the ring volume when you move HTC Explorer when it's ringing, make it ring louder when inside a bag or pocket, and turn on the speakerphone when you flip it over. |
| Display | Set up display settings such as automatic screen orientation, brightness, screen timeout, and more. |
| Accounts & sync | <ul style="list-style-type: none"> ▪ Log in or out of your social network accounts, Google Account, and Exchange ActiveSync account. ▪ Sign in or out of your HTCSense.com account. ▪ You can also manage synchronization and other settings for your accounts. |
| Location | <ul style="list-style-type: none"> ▪ Select the sources to use when determining your location. ▪ Select Phone finder so you can use HTCSense.com to locate HTC Explorer. |
| Search | Select items to include when you do a search and set Google search options. |
| Privacy | <ul style="list-style-type: none"> ▪ Choose to automatically back up some settings (e.g. Wi-Fi passwords or Bookmarks) to Google servers using your Google Account so you can restore them when needed. ▪ If you don't want missed calls and your received text message appear on the lock screen, clear the Display message text check box. |

| | |
|---------------------|--|
| Connect to PC | <ul style="list-style-type: none"> ▪ Set the default USB connection type to use whenever you connect HTC Explorer to your computer. ▪ Or, select the Ask me check box to set HTC Explorer to always display the screen for selecting the USB connection type. |
| Security | Set a screen lock, enable the SIM card lock, or manage the credential storage. |
| Power | <ul style="list-style-type: none"> ▪ Turn on power saver to automatically switch to power saving mode when the battery level goes down to the level that you set. ▪ Another power saving option is to select Enable sleep mode. This will turn off auto sync of data in your online accounts. |
| Applications | <ul style="list-style-type: none"> ▪ Manage running applications, move applications to or from the storage card, check how much storage is used by apps, and install or uninstall programs. ▪ Choose how much free memory remains before you're notified about low memory space. |
| SD & phone storage | <ul style="list-style-type: none"> ▪ Check the available space in the internal storage and your storage card. ▪ From this screen, be sure to unmount your storage card before you remove it from HTC Explorer. ▪ Erase the storage card to start afresh and if you don't need to keep the content. You need to unmount the storage card first before you can erase it. ▪ Clear out the cache used by apps, move apps or uninstall apps if HTC Explorer is running low on memory. ▪ You can also do a factory reset. |
| Date & time | <ul style="list-style-type: none"> ▪ Set the date and time, time zone, and date or time format. ▪ Choose the time and date formats that suit you. |
| Language & keyboard | Set the operating system language and region. You can also set onscreen keyboard options. |
| Accessibility | Use these settings when you've downloaded and installed an accessibility tool, such as a screen reader that provides voice feedback. You can turn accessibility functions or services on or off. |

| | |
|---------------------------------|---|
| Voice input & output | Set up the voice input options. Also, if you've installed a text-to-speech (voice data) application, use this to set the text-to-speech settings. |
| About phone | <ul style="list-style-type: none"> ▪ Turn on or off scheduled checks for system software updates, or manually check for updates. ▪ Turn Tell HTC on or off. When enabled, you're helping us know if HTC Explorer encounters a technical problem. ▪ View different information about HTC Explorer, such as the mobile network type, signal strength, battery level, and more. |

Changing display settings

Adjusting the screen brightness manually

1. From the Home screen, press , and then tap **Settings**.
2. Tap **Display > Brightness**.
3. Clear the **Automatic brightness** check box.
4. Drag the brightness slider to the left to decrease or to the right to increase the screen brightness.
5. Tap **OK**.

Adjusting the time before the screen turns off

After a period of inactivity, the screen turns off to conserve battery power. You can set the idle time before the screen turns off.

1. From the Home screen, press , and then tap **Settings**.
2. Tap **Display > Screen timeout**.
3. Tap the time before the screen turns off.

Turning automatic screen rotation off

By default, the screen orientation automatically adjusts depending on how you hold HTC Explorer.



Automatic rotation is not supported in all application screens.

1. From the Home screen, press , and then tap **Settings**.
2. Tap **Display**.
3. Clear the **Auto-rotate screen** check box.

Recalibrating the G-sensor

Recalibrate the screen if you feel that the screen orientation does not respond properly to the way you hold HTC Explorer.

1. From the Home screen, press , and then tap **Settings**.
2. Tap **Display > G-Sensor calibration**.
3. Place HTC Explorer on a flat and level surface, and then tap **Calibrate**.
4. After the recalibration process, tap **OK**.

Keeping the screen on while charging HTC Explorer

You can keep the screen from turning off while you're charging HTC Explorer.

1. From the Home screen, press , and then tap **Settings**.
2. Tap **Applications > Development**.
3. Select the **Stay awake** check box.

Switching animation effects on or off

You can turn off the animation or enable only some animations when switching between screens.

1. From the Home screen, press , and then tap **Settings**.
2. Tap **Display > Animation**.
3. On the options menu, select the animation setting you want.

Changing sound settings

Switching between silent, vibration, and normal modes

Do one of the following:

- To change back from silent to normal mode, simply press the VOLUME UP button.
- To change back from vibration to normal mode, press the VOLUME UP button twice.
- From the Home screen, press , and then tap **Settings > Sound > Sound profile**.

Enabling or disabling audible selection

You can choose to play a sound when you're selecting items onscreen.

1. From the Home screen, press , and then tap **Settings**.
2. Tap **Sound**.
3. Select or clear the **Audible selection** check box.

Lowering the ring volume automatically

HTC Explorer has a quiet ring feature that automatically lowers the ring volume when you move it.

1. From the Home screen, press , and then tap **Settings**.
2. Tap **Sound**.
3. Select or clear the **Quiet ring on pickup** check box.

Making HTC Explorer ring louder with Pocket mode

To help avoid missing incoming calls when HTC Explorer is in your pocket or bag, the pocket mode feature gradually increases the ring volume and vibrates when you receive a call. When not in your pocket or bag, HTC Explorer will ring at the normal volume you set.

1. From the Home screen, press , and then tap **Settings**.
2. Tap **Sound**.
3. Select or clear the **Pocket mode** check box.

Switching to speakerphone automatically

When you're on a call, you can switch to speakerphone by simply flipping HTC Explorer over.

1. From the Home screen, press , and then tap **Settings**.
2. Tap **Sound**.
3. Select or clear the **Flip for speaker** check box.

Changing the language

When you turn HTC Explorer on for the first time, you're asked to choose the language you want to use. If you want, you can still change the language after you set up HTC Explorer. Changing the language adjusts the keyboard layout, date and time formatting, and more.

The languages available to choose from may depend on the version of HTC Explorer you have.

1. From the Home screen, press , and then tap **Settings**.
2. Tap **Language & keyboard** > **Select language**.

3. Tap the language and corresponding region you want to use.
4. Press  to return to the Home screen. The new language will be applied after a few seconds.

Optimizing battery life

You can set HTC Explorer to automatically switch to power saver mode when the battery level reaches a certain level.

1. From the Home screen, press , and then tap **Settings**.
2. Tap **Power**.
3. Tap **Power mode > Economy**.
4. Tap **Turn power saver on at**, and then select when to switch to power saver mode.
5. Tap **Economy mode settings**, and then set and select the behavior when HTC Explorer switches to power saver mode.

Switching to GSM network mode

Switch to using GSM network if you're not using a data connection to connect to the Internet. Connecting to GSM network mode consumes less battery power.

1. From the Home screen, press , and then tap **Settings**.
2. Tap **Wireless & networks > Mobile networks > Network Mode**.
3. Tap **GSM only**.

Checking the power usage of applications

1. From the Home screen, press , and then tap **Settings**.
2. Tap **About phone > Battery > Battery use**.

Scheduling HTC Explorer to switch to Sleep mode

Set the Sleep mode schedule on HTC Explorer so it doesn't consume too much battery power when it's not plugged in at night.



Unlike the usual Sleep mode when you press the POWER button to turn off the screen display, a scheduled Sleep mode turns off the Wi-Fi and data connections during the Sleep mode schedule you defined.

1. From the Home screen, press , and then tap **Settings**.
2. Tap **Power > Enable sleep mode**.
3. Tap any of the following:

| | |
|------------------|---|
| Automatic | Select to automatically switch HTC Explorer to Sleep mode. HTC Explorer adjusts its Sleep mode schedule over a period of time around what it detects as your bedtime. |
| Manual | Select to specify the Sleep mode start and end time. |
| Never | Select to turn scheduled Sleep mode off. |

Managing memory

Checking how much phone memory is available for use

1. From the Home screen, press , and then tap **Settings**.
2. Tap **SD & phone storage**. The available phone memory is displayed in the Internal storage section.

Checking the available storage card space

1. From the Home screen, press , and then tap **Settings**.
2. Tap **SD & phone storage**. The total and available storage card space is displayed in the SD card section.

Making more storage space

Easily free up some storage by cleaning up the application cache, moving or uninstalling apps, and deleting old mails and messages all in one go.



You cannot move or uninstall preinstalled apps.

1. From the Home screen, press , and then tap **Settings**.
2. Tap **SD & phone storage > Make more space**.

3. On the Clear caches screen, choose whether to clear the cache of rarely used apps only or all apps, and then tap **Next**.
4. On the Application storage screen:
 - Tap **Move apps to SD card** if there are apps that you can transfer to the storage card.
 - Tap **Uninstall apps** if there are apps you'd like to remove.
5. Tap **Next**.
6. On the Mail & message storage screen:
 - Set fewer days of mails to download so that older mails will be removed from the storage automatically.
 - Lower the number of text and multimedia messages per conversation.
7. Tap **Finish**.

Clearing application cache and data

1. From the Home screen, press , and then tap **Settings**.
2. Tap **Applications > Manage applications**.
3. On the All tab, tap an application.
4. On the screen, tap **Clear data** and/or **Clear cache**.

Uninstalling third-party applications

You cannot uninstall applications that are preinstalled on HTC Explorer.

1. From the Home screen, press , and then tap **Settings**.
2. Tap **Applications > Manage applications**.
3. On the Downloaded tab, tap the application you want to uninstall.
4. Tap **Uninstall**.

Moving applications to or from the storage card

Move downloaded applications to the storage card if the internal storage on HTC Explorer is getting low. Or, if your storage card is getting full, you can also move applications from the storage card to the internal storage.





You can only move applications that are not preinstalled on HTC Explorer.

1. From the Home screen, press , and then tap **Settings**.
2. Tap **Applications > Manage applications**.
3. On the Downloaded tab, tap the application you want to move.
4. Tap **Move to SD card** or **Move to phone**.

Stopping running applications using Task Manager

Use Task Manager to free up memory by stopping running applications that you're not currently using.

1. From the Home screen, tap  > Task Manager.
2. In the All applications list, tap  to the right of the application name to stop it.

Checking information about HTC Explorer

1. From the Home screen, press , and then tap **Settings**.
2. Tap **About phone**.
3. Select one of the following:

| | |
|----------------------|---|
| Software updates | Enable or disable the automatic check feature for software updates for HTC Explorer. You can also tap Check now to manually check for software updates. |
| Tell HTC | Turn Tell HTC on or off. When enabled, you're helping us know if HTC Explorer encounters a technical problem. You can also choose when you want to send error reports. |
| Network | Check information about your mobile network and its service status. |
| Phone identity | Check information about HTC Explorer and the SIM card you're using. |
| Battery | Check information about the battery such as its current battery level, status, and what programs are using the battery. |
| Hardware information | Check the Wi-Fi MAC and Bluetooth addresses. |
| Software information | Check the version and other information about the Android platform being used by HTC Explorer. You can also check the version of the web browser. |
| Legal information | Read legal information from HTC and Google, and licenses used by HTC Explorer. |

Update and reset

Software updates

From time to time, software updates for HTC Explorer may be available. HTC Explorer can check and then notify you if there's a new update. You can then download and install the software update using the Wi-Fi or data connection. You can also manually check if there's an available software update.

Depending on the type of update, the update may erase all your personal data and customized settings, and also remove any applications you've installed. Make sure that you've backed up the information and files you want to keep.



Checking and downloading software updates may incur extra data fees.

Installing an update

When the Internet connection is on and there's a new update available, the system update dialog box appears and guides you through the process.

1. If you don't see the dialog box, check for the update notification icon  in the status bar.

Slide open the Notifications panel, and then tap the update notification.

2. In the system update dialog box, choose what type of connection to use for downloading the update.

Follow the onscreen prompts to start the download.

3. After the download is complete, tap **Install now** and then tap **OK** in the Install system software update dialog box.

Wait for the update to finish. HTC Explorer will then restart automatically.

Checking for updates manually

1. From the Home screen, press , and then tap **Settings**.
2. Tap **About phone** > **Software updates** > **Check now**.

Restarting HTC Explorer

If HTC Explorer is running slower than normal, an application is not performing properly, or HTC Explorer becomes unresponsive, try restarting HTC Explorer and see if that helps solve the problem.

1. If the display is off, press the POWER button to turn it back on.
2. Unlock the display.
3. Press and hold the POWER button, and then tap **Restart**.
4. When asked to confirm, tap **Restart**.



If these steps don't work, you can remove and replace the battery, and then turn HTC Explorer on to restart it.

Resetting HTC Explorer

Do a factory reset to return HTC Explorer to its original state before the first time you turned it on.

If you're passing HTC Explorer on to someone else or HTC Explorer has a persistent problem that cannot be solved, you can perform a factory reset (also called a hard reset). Factory reset is not a step to be taken lightly. It'll permanently delete all your data and customized settings, and will remove any applications you've downloaded and installed. Be sure to back up any data and files you want to keep before you do a factory reset.

Performing a factory reset via settings

The most convenient way to do a factory reset is via the settings.

1. From the Home screen, press , and then tap **Settings**.
2. Tap **SD & phone storage > Factory data reset**.
3. Tap **Reset phone**, and then tap **Erase everything**.

Performing a factory reset using hardware buttons

If you can't turn HTC Explorer on or access settings, you can still perform a factory reset by using the hardware buttons on HTC Explorer.

1. Remove the battery, wait for a few seconds, then reinsert the battery.
2. Press and hold the VOLUME DOWN button, and then briefly press the POWER button.
3. Wait for the screen with the three Android images to appear, and then release the VOLUME DOWN button.
4. Press VOLUME DOWN to select **FACTORY RESET**, and then press the POWER button.

Trademarks and copyrights

©2011 HTC Corporation. All Rights Reserved.

HTC, the HTC logo, the HTC quietly brilliant logo, HTC Explorer, HTC Sense, and HTC Sync are trademarks or service marks of HTC Corporation.

©2011 Google Inc. Used with permission. Google, the Google logo, Android, the Android logo, Android Market, the Android Market logo, Google Apps, Google Calendar, Google Checkout, Google Earth, Google Latitude, Google Maps, Google Talk, Gmail, Picasa, and YouTube are trademarks of Google Inc.

Microsoft, Windows, ActiveSync, Outlook, Windows Media, and Windows Vista are either registered trademarks or trademarks of Microsoft Corporation in the United States and/or other countries.

Bluetooth and the Bluetooth logo are trademarks owned by Bluetooth SIG, Inc.

This device contains Adobe® Flash® Player software under license from Adobe Systems Incorporated. Copyright ©1995–2011 Adobe Systems Incorporated. All rights reserved. Adobe is a trademark of Adobe Systems Incorporated.

Wi-Fi is a registered trademark of the Wireless Fidelity Alliance, Inc.

microSD is a trademark of SD Card Association.

Facebook is a trademark of Facebook, Inc.

iTunes is a trademark of Apple Inc.

All other company, product and service names mentioned herein are trademarks, registered trademarks or service marks of their respective owners.

HTC shall not be liable for technical or editorial errors or omissions contained herein, nor for incidental or consequential damages resulting from furnishing this material. The information is provided “as is” without warranty of any kind and is subject to change without notice. HTC also reserves the right to revise the content of this document at any time without prior notice.

No part of this document may be reproduced or transmitted in any form or by any means, electronic or mechanical, including photocopying, recording or storing in a retrieval system, or translated into any language in any form without prior written permission of HTC.

Index

Symbols

3G 150

A

Airplane mode 48

Alarm 96

Android Market 93

Apps

- deleting 94
- installing 93, 138

B

Back up contacts 66

Battery

- installing 13
- optimizing battery life 168

Bluetooth

- connecting a Bluetooth headset or car kit 155
- disconnecting or unpairing 156
- sending information 157
- sharing music 92
- turning on or off 155

Browser

- bookmarks 53
- navigating and zooming 51
- opening a new window 51
- options 54
- using 50

C

Calendar

- creating an event 122
- managing events 124
- reminders 126
- settings 126
- views 123
- widget 127

Call history 45

Camera

- basics 78

- effects 80

- recording a video 80

- taking a photo 79

- zooming 79

Change phone language 167

Sound

- audible selection 166

- lowering ring volume automatically 167

- Pocket mode 167

- switching profiles 166

- switching to speakerphone 167

Clock 95

Conference call 43

Contacts

- adding 63

- copying from SIM card 62

- deleting 67

Copying text 26

D

Data connection

- access point 150

- turning on or off 150

Delete apps 94

Delete contacts 67

Display

- adjusting screen brightness 165

- changing the time before the screen turns off 165

- recalibrating G-sensor 166

- turning off screen rotation 165

Downloading

- from Web 52

- viewing downloads 53

E

Email 113

Exchange ActiveSync

- Out of office 121

- sending a meeting request *121*
- working with Exchange ActiveSync email *120*

F

- Facebook
 - sharing your location *75*
- Facebook for HTC Sense *73*
- Factory reset *173*
- Firmware *172*
- Flight mode *48*
- FM Radio *100*

G

- Gallery
 - about *82*
 - editing photos *84*
 - sending photos and videos *85*
 - sharing photos and videos *86*
 - viewing photos *83*
 - viewing photos in social networks *88*
 - watching video *84*
- Getting started *8*
- Gmail *112*
- Google Account *56*
- Google Maps *128*

H

- Hands free *155*
- Hard reset *173*
- Headphones *155*
- Home dialing *46*
- Home screen
 - about *17*
 - adding widgets *30*
 - extended *17*
 - rearranging items *32*
 - rearranging the home panels *33*
- HTC Clock
 - Desk Clock *95*
 - setting an alarm *96*
 - World Clock *95*
- HTCSense.com *140*

I

- Icons
 - notification icons *22*
 - status icons *21*
- Internet calling *44*
- Internet connection
 - data connection *150*
 - Internet pass-through *154*
 - Tethering *154*
 - VPN *152*
 - Wi-Fi *151*
- Internet pass-through *154*

K

- Keyboard
 - copying and pasting text *148*
 - dictionary *145*
 - editing text *147*
 - entering text *143*
 - entering text by speaking *146*
 - predictive text *144*
 - selecting text *147*

L

- Language *167*
- Leap view *18*
- Locations
 - turning on location services *128*

M

- Mail
 - adding a POP3/IMAP account *114*
 - adding an Exchange account *114*
 - deleting an email account *121*
 - managing email messages *117*
 - sending *117*
 - sorting email messages *116*
 - unified inbox *115*
 - working with Exchange ActiveSync email *120*
- Making a call *38*
- Managing memory *169*
- Market *93*
- Master reset *173*
- Meeting request *121*
- Messages
 - copying to the SIM card *109*

- deleting 109
- deleting a conversation 110
- forwarding 107
- protecting from deletion 109
- viewing 106

microSD card 12

MMS 104

Modem

- USB tethering 154
- using your computer 154

Multimedia message 104

Music

- browsing the library 90
- copying music to storage card 25
- listening 89
- playing music from Lock screen 89
- playlist 90
- setting a song as ringtone 92
- sharing music using Bluetooth 92
- widget 90

N

Notifications

- icons 21
- panel 23

O

Online accounts

- about 56
- managing 57

Onscreen keyboard

- copying and pasting text 148
- dictionary 145
- editing text 147
- entering text 143
- entering text by speaking 146
- predictive text 144
- selecting text 147
- settings 148

Optimizing battery life 168

P

Pair a Bluetooth device 155

People

- adding a new contact 63
- deleting contacts 67
- editing a contact 67

- filtering your contacts 61
- groups 69
- merging contact information 65
- searching for a contact 63
- widget 71

Phone calls

- calling a number in a message 40
- calling a number in an email 40
- calling using Wi-Fi 44
- making an emergency call 40
- receiving 41
- setting up a conference call 43

Phone information 171

Phone settings

- About phone 171
- Applications 169
- Display 165
- Language & keyboard 167
- Power 168
- SD & phone storage 169
- Sound 166

Phone updates 172

Photos

- copying to/from storage card 25
- editing 84
- sharing 86
- viewing 83

Playing music from the Lock screen 89

PUK (PIN Unblock Key) 160

Q

Quick Settings 24

R

Radio 100

Record your voice 101

Ring volume

- lowering ring volume automatically 167
- making your phone ring louder 167

Ringtone

- setting 92

S

Scenes 28

Screen

- adjusting screen brightness 165

- changing the time before the screen turns off *165*
- recalibrating G-sensor *166*
- turning off screen rotation *165*

SD card *12*

Search *49, 50*

Security

- changing your screen lock *161*
- locking with a screen lock pattern, PIN, or password *160*
- locking your SIM card with a PIN *160*

Settings

- About phone *171*
- Applications *169*
- Language & keyboard *167*
- Power *168*
- SD & phone storage *169*
- Sound *166*

Sharing

- games and apps *102*

SIM card

- copying a message *109*
- inserting *11*
- removing *11*
- SIM PIN *160*

Sleep mode *20*

Slideshow *83*

Smart dial *39*

SMS *103*

Social networks

- adding *57*
- viewing photos *88*

Software update *172*

Sound set *34*

Speakerphone *43*

Speed dial *39*

Storage card

- copying files *25*
- moving apps to the storage card *170*

Sync

- online accounts *58*

T

Tethering *154*

Text message *103*

Translate *50*

U

Updating phone software *172*

Upgrade *172*

USB *25, 154*

V

Videos

- recording *80*
- sharing *86*
- watching *84*

Voice input *146*

Voice Recorder *101*

Volume

- adjusting during phone calls *19*
- adjusting media *19*
- adjusting ringer *19*

VPN

- adding a connection *153*
- connecting *153*

W

Wallpaper

- changing *29*

Weather

- adding cities *98*
- checking weather *98*

Web browser *50*

Wi-Fi

- calling *44*
- connecting to another network *152*
- network status *152*
- turning on *151*

Widgets

- adding *30*
- changing settings *31*
- removing *33*

Y

YouTube

- sharing videos *87*