



# FCC TEST REPORT (PART 22)

**REPORT NO.:** RF110805C09-2

**MODEL NO.:** PI86100

**FCC ID:** NM8PI86100

**RECEIVED:** Aug. 05, 2011

**TESTED:** Sep. 24 ~ Oct. 05, 2011

**ISSUED:** Oct. 07, 2011

**APPLICANT:** HTC Corporation

**ADDRESS:** 23, Xinghua Rd., Taoyuan 330, Taiwan, R.O.C.

**ISSUED BY:** Bureau Veritas Consumer Products Services  
(H.K.) Ltd., Taoyuan Branch

**LAB ADDRESS:** No. 47, 14th Ling, Chia Pau Vil., Lin Kou Dist.,  
New Taipei City, Taiwan ( R.O.C )

**TEST LOCATION:** No. 19, Hwa Ya 2nd Rd, Wen Hwa Tsuen, Kwei  
Shan Hsiang, Taoyuan Hsien 333, Taiwan, R.O.C.

This test report consists of 71 pages in total. It may be duplicated completely for legal use with the approval of the applicant. It should not be reproduced except in full, without the written approval of our laboratory. The client should not use it to claim product endorsement by TAF or any government agencies. The test results in the report only apply to the tested sample.





## TABLE OF CONTENTS

RELEASE CONTROL RECORD .....	4
1 CERTIFICATION .....	5
2 SUMMARY OF TEST RESULTS .....	6
2.1 MEASUREMENT UNCERTAINTY .....	6
3 GENERAL INFORMATION.....	7
3.1 GENERAL DESCRIPTION OF EUT.....	7
3.2 DESCRIPTION OF TEST MODES.....	8
3.2.1 CONFIGURATION OF SYSTEM UNDER TEST .....	9
3.2.2 TEST MODE APPLICABILITY AND TESTED CHANNEL DETAIL.....	10
3.3 GENERAL DESCRIPTION OF APPLIED STANDARDS .....	15
3.4 DESCRIPTION OF SUPPORT UNITS .....	15
4 TEST TYPES AND RESULTS.....	16
4.1 OUTPUT POWER MEASUREMENT .....	16
4.1.1 LIMITS OF OUTPUT POWER MEASUREMENT.....	16
4.1.2 TEST INSTRUMENTS .....	17
4.1.3 TEST PROCEDURES.....	18
4.1.4 TEST SETUP .....	19
4.1.5 EUT OPERATING CONDITIONS.....	19
4.1.6 TEST RESULTS .....	20
4.2 FREQUENCY STABILITY MEASUREMENT .....	23
4.2.1 LIMITS OF FREQUENCY STABILITY MEASUREMENT.....	23
4.2.2 TEST INSTRUMENTS .....	23
4.2.3 TEST PROCEDURE .....	24
4.2.4 TEST SETUP .....	24
4.2.5 TEST RESULTS .....	25
4.3 OCCUPIED BANDWIDTH MEASUREMENT.....	28
4.3.1 LIMITS OF OCCUPIED BANDWIDTH MEASUREMENT.....	28
4.3.2 TEST INSTRUMENTS .....	28
4.3.3 TEST SETUP .....	28
4.3.4 TEST PROCEDURES.....	29
4.3.5 EUT OPERATING CONDITION .....	29
4.3.6 TEST RESULTS .....	30
4.4 BAND EDGE MEASUREMENT .....	36
4.4.1 LIMITS OF BAND EDGE MEASUREMENT.....	36
4.4.2 TEST INSTRUMENTS .....	36
4.4.3 TEST SETUP .....	36
4.4.4 TEST PROCEDURES.....	37
4.4.5 EUT OPERATING CONDITION .....	37
4.4.6 TEST RESULTS .....	38
4.5 CONDUCTED SPURIOUS EMISSIONS.....	44
4.5.1 LIMITS OF CONDUCTED SPURIOUS EMISSIONS MEASUREMENT.....	44
4.5.2 TEST INSTRUMENTS .....	44
4.5.3 TEST PROCEDURE .....	45
4.5.4 TEST SETUP .....	45
4.5.5 EUT OPERATING CONDITIONS.....	45
4.5.6 TEST RESULTS .....	46
4.6 RADIATED EMISSION MEASUREMENT .....	58
4.6.1 LIMITS OF RADIATED EMISSION MEASUREMENT .....	58
4.6.2 TEST INSTRUMENTS .....	58



A D T

4.6.3	TEST PROCEDURES .....	59
4.6.4	DEVIATION FROM TEST STANDARD .....	59
4.6.5	TEST SETUP .....	60
4.6.6	EUT OPERATING CONDITIONS .....	60
4.6.7	TEST RESULTS .....	61
5	PHOTOGRAPHS OF THE TEST CONFIGURATION.....	69
6	INFORMATION ON THE TESTING LABORATORIES .....	70
7	APPENDIX A – MODIFICATIONS RECORDERS FOR ENGINEERING CHANGES TO THE EUT BY THE LAB.....	71



## RELEASE CONTROL RECORD

ISSUE NO.	REASON FOR CHANGE	DATE ISSUED
Original release	N/A	Oct. 07, 2011



## 1 CERTIFICATION

**PRODUCT:** Windows Phone  
**MODEL:** PI86100  
**BRAND:** HTC  
**APPLICANT:** HTC Corporation  
**TEST SAMPLE:** Production Unit  
**TESTED:** Sep. 24 ~ Oct. 05, 2011  
**STANDARDS:** **FCC Part 22, Subpart H**  
ANSI C63.4-2003

The above equipment (model: PI86100) has been tested by **Bureau Veritas Consumer Products Services (H.K.) Ltd., Taoyuan Branch**, and found compliance with the requirement of the above standards. The test record, data evaluation & Equipment Under Test (EUT) configurations represented herein are true and accurate accounts of the measurements of the sample's EMC characteristics under the conditions specified in this report.

PREPARED BY : Andrea Hsia, DATE : Oct. 07, 2011  
Andrea Hsia / Specialist

APPROVED BY : Gary Chang, DATE : Oct. 07, 2011  
Gary Chang / Technical Manager

## 2 SUMMARY OF TEST RESULTS

The EUT has been tested according to the following specifications:

APPLIED STANDARD: FCC Part 22 & Part 2			
STANDARD SECTION	TEST TYPE AND LIMIT	RESULT	REMARK
2.1046 22.913 (a)	Maximum Peak Output Power Limit: max. 7 watts e.r.p peak power	PASS	Meet the requirement of limit. Max. e.r.p is 30.6dBm at 836.4MHz.
2.1055	Frequency Stability AFC Freq. Error vs. Voltage AFC Freq. Error vs. Temperature Limit: max. $\pm 2.5$ ppm	PASS	Meet the requirement of limit.
2.1049 (h)	Occupied Bandwidth	PASS	Meet the requirement of limit.
22.917	Band Edge Measurements	PASS	Meet the requirement of limit.
2.1051 22.917	Conducted Spurious Emissions	PASS	Meet the requirement of limit.
2.1053 22.917	Radiated Spurious Emissions	PASS	Meet the requirement of limit. Minimum passing margin is -17.9dB at 2509.2MHz.

### 2.1 MEASUREMENT UNCERTAINTY

Where relevant, the following measurement uncertainty levels have been estimated for tests performed on the EUT as specified in CISPR 16-4-2:

MEASUREMENT	FREQUENCY	UNCERTAINTY
Conducted emissions	9kHz~30MHz	2.44 dB
Radiated emissions	30MHz ~ 200MHz	3.34 dB
	200MHz ~1000MHz	3.35 dB
	1GHz ~ 18GHz	2.26 dB
	18GHz ~ 40GHz	1.94 dB

This uncertainty represents an expanded uncertainty expressed at approximately the 95% confidence level using a coverage factor of  $k=2$ .

### 3 GENERAL INFORMATION

#### 3.1 GENERAL DESCRIPTION OF EUT

<b>EUT</b>	Windows Phone	
<b>MODEL NO.</b>	PI86100	
<b>FCC ID</b>	NM8PI86100	
<b>POWER SUPPLY</b>	5.0Vdc (adapter or host equipment) 3.8Vdc (battery)	
<b>MODULATION TYPE</b>	<b>GSM, GPRS, E-GPRS</b>	GMSK, 8PSK
	<b>WCDMA</b>	BPSK
<b>FREQUENCY RANGE</b>	<b>GSM, GPRS, E-GPRS</b>	824.2MHz ~ 848.8MHz
	<b>WCDMA</b>	826.4MHz ~ 846.6MHz
<b>MAX. ERP POWER</b>	<b>GSM</b>	1.1482Watts
	<b>E-GPRS</b>	0.4365Watts
	<b>WCDMA</b>	0.0832Watts
<b>MULTI-SLOTS CLASS</b>	10	
<b>WCDMA RELEASE VERSION</b>	6	
<b>ANTENNA TYPE</b>	Fixed antenna with -4dBi gain	
<b>I/O PORTS</b>	Refer to users' manual	
<b>DATA CABLE</b>	Refer to Note as below	
<b>ACCESSORY DEVICES</b>	Refer to Note as below	

**NOTE:**

- The EUT's accessories list refers to Ext Pho\_NM8PI86100.pdf.  
\*Main sample & 2nd sample + item 2, 3, 6 were for the final test.
- IMEI code: 3582490\*\*\*\*\*.
- The above EUT information was declared by manufacturer and for more detailed features description, please refer to the manufacturer's specifications or User's Manual.

### 3.2 DESCRIPTION OF TEST MODES

#### FOR GSM & E-GPRS:

124 channels are provided to this EUT. Therefore, the low, middle and high channels are chosen for testing.

	CHANNEL	FREQUENCY	TX MODE
LOW	128	824.2 MHz	GSM, GPRS, E-GPRS
MIDDLE	190	836.6 MHz	GSM, GPRS, E-GPRS
HIGH	251	848.8 MHz	GSM, GPRS, E-GPRS

#### NOTE:

1. Below 1 GHz, the channel 128, 190, and 251 were pre-tested in chamber. The channel 190 was chosen for final test.
2. Above 1 GHz, the channel 128, 190, and 251 were tested individually.
3. The worst case for final test is chosen when the power control level set 5.
4. The channel space is 0.2MHz.
5. The EUT is a GPRS class 10 device (Multislot class: 10), which provide 2 up-link. After pre-tested 2 functions, found up-link with 1 time slot is worse, therefore, test results of output power, frequency stability, occupied bandwidth and band edge tests came out from this.
6. The EUT is an E-GPRS class 10 device (Multislot class: 10, which provide 2 up-link. After pre-tested 2 functions, found up-link with 1 time slot is worse, therefore, test results of output power, frequency stability, occupied bandwidth and band edge tests came out from this.
7. The EUT has GSM, GPRS & E-GPRS functions. After pre-testing, GSM & E-GPRS function is the worst case for all the emission tests.

#### FOR WCDMA:

102 channels are provided to this EUT. Therefore, the low, middle and high channels are chosen for testing.

	CHANNEL	FREQUENCY	TX MODE
LOW	4132	826.4 MHz	WCDMA, HSDPA, HSUPA
MIDDLE	4182	836.4 MHz	WCDMA, HSDPA, HSUPA
HIGH	4233	846.6 MHz	WCDMA, HSDPA, HSUPA

#### NOTE:

1. Below 1 GHz, the channel 4132, 4182 and 4233 were pre-tested in chamber. The channel 4182 was chosen for final test.
2. Above 1 GHz, the channel 4132, 4182 and 4233 were tested individually.
3. The channel space is 0.2MHz.
4. After pretest of output power and spurious emission under WCDMA-RMC, HSDPA & HSUPA mode, find the worst mode is WCDMA-RMC. Therefore, select WCDMA-RMC mode to do final test



### 3.2.1 CONFIGURATION OF SYSTEM UNDER TEST FOR RADIATION EMISSION TEST

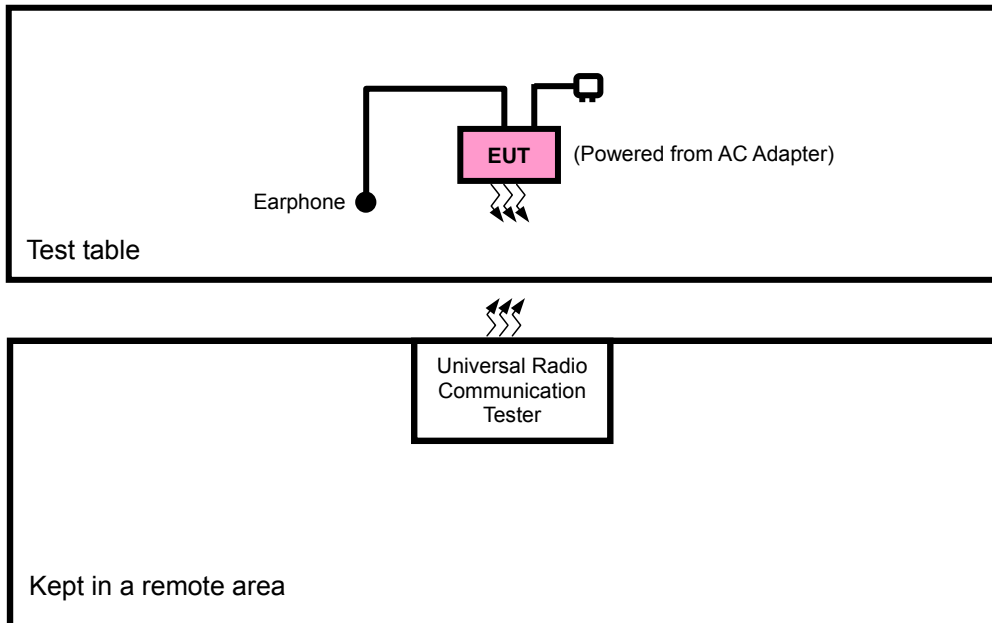

### FOR E.R.P. TEST

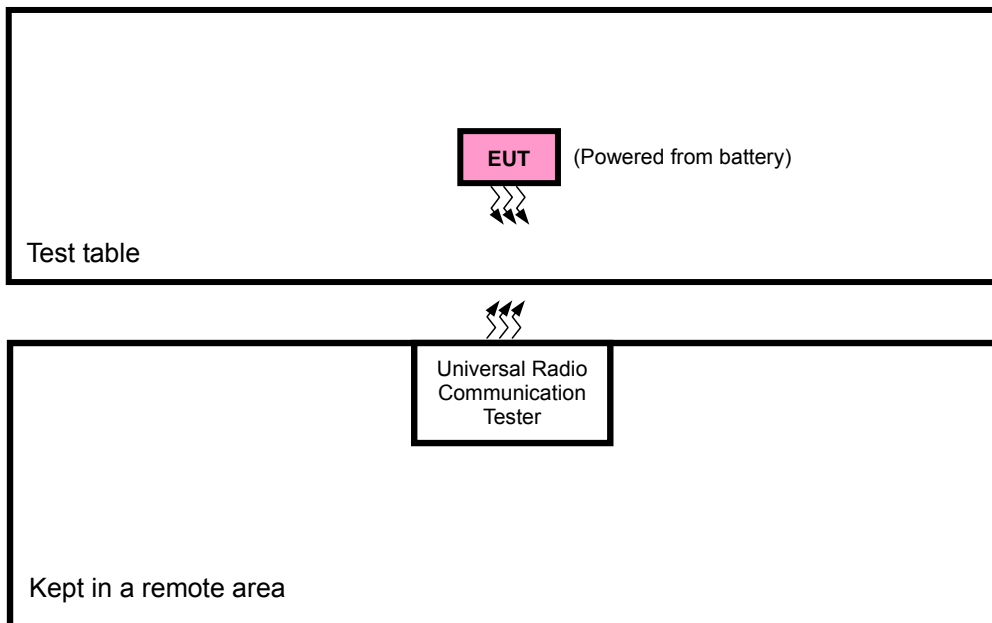

### 3.2.2 TEST MODE APPLICABILITY AND TESTED CHANNEL DETAIL FOR GSM, GPRS & E-GPRS:

EUT CONFIGURE MODE	APPLICABLE TO							DESCRIPTION
	OP	FS	OB	BE	CE	RE<1G	RE≥1G	
A	√	√	√	√	√	√	√	Main sample + Power from adapter 2
B	√	-	-	-	-	√	√	2nd sample + Power from adapter 2

Where **OP**: Output power **FS**: Frequency stability  
**OB**: Occupied bandwidth **BE**: Band edge  
**CE**: Conducted spurious emissions **RE<1G**: Radiated emission below 1GHz  
**RE≥1G**: Radiated emission above 1GHz **NOTE**: "-" means no effect.

#### **OUTPUT POWER MEASUREMENT:**

- Pre-Scan has been conducted to determine the worst-case mode from all possible combinations between available modulations, data rates, XYZ axis and antenna ports (if EUT with antenna diversity architecture).
- Following channel(s) was (were) selected for the final test as listed below.

EUT CONFIGURE MODE	AVAILABLE CHANNEL	TESTED CHANNEL	MODULATION TECHNOLOGY	AXIS
A	128 to 251	128, 190, 251	GSM, E-GPRS	Z
B	128 to 251	128, 190, 251	GSM	Z

#### **FREQUENCY STABILITY MEASUREMENT:**

- Pre-Scan has been conducted to determine the worst-case mode from all possible combinations between available modulations and antenna ports (if EUT with antenna diversity architecture).
- Following channel(s) was (were) selected for the final test as listed below.

EUT CONFIGURE MODE	AVAILABLE CHANNEL	TESTED CHANNEL	MODULATION TECHNOLOGY
A	128 to 251	190	GSM, E-GPRS

#### **OCCUPIED BANDWIDTH MEASUREMENT:**

- This item includes all test value of each mode, but only includes spectrum plot of worst value of each mode.
- Pre-Scan has been conducted to determine the worst-case mode from all possible combinations between available modulations and antenna ports (if EUT with antenna diversity architecture).
- Following channel(s) was (were) selected for the final test as listed below.

EUT CONFIGURE MODE	AVAILABLE CHANNEL	TESTED CHANNEL	MODULATION TECHNOLOGY
A	128 to 251	128, 190, 251	GSM, GPRS, E-GPRS

**BAND EDGE MEASUREMENT:**

- Pre-Scan has been conducted to determine the worst-case mode from all possible combinations between available modulations and antenna ports (if EUT with antenna diversity architecture).
- Following channel(s) was (were) selected for the final test as listed below.

EUT CONFIGURE MODE	AVAILABLE CHANNEL	TESTED CHANNEL	MODULATION TECHNOLOGY
A	128 to 251	128, 251	GSM, GPRS, E-GPRS

**CONDUCTED SPURIOUS EMISSIONS MEASUREMENT:**

- Pre-Scan has been conducted to determine the worst-case mode from all possible combinations between available modulations and antenna ports (if EUT with antenna diversity architecture).
- Following channel(s) was (were) selected for the final test as listed below.

EUT CONFIGURE MODE	AVAILABLE CHANNEL	TESTED CHANNEL	MODULATION TECHNOLOGY
A	128 to 251	128, 190, 251	GSM

**RADIATED EMISSION MEASUREMENT (BELOW 1 GHz):**

- Pre-Scan has been conducted to determine the worst-case mode from all possible combinations between available modulations, data rates, XYZ axis and antenna ports (if EUT with antenna diversity architecture).
- Following channel(s) was (were) selected for the final test as listed below.

EUT CONFIGURE MODE	AVAILABLE CHANNEL	TESTED CHANNEL	MODULATION TECHNOLOGY	AXIS
A	128 to 251	190	GSM, E-GPRS	Z
B	128 to 251	190	GSM	Z

**RADIATED EMISSION MEASUREMENT (ABOVE 1 GHz):**

- Pre-Scan has been conducted to determine the worst-case mode from all possible combinations between available modulations, data rates, XYZ axis and antenna ports (if EUT with antenna diversity architecture).
- Following channel(s) was (were) selected for the final test as listed below.

EUT CONFIGURE MODE	AVAILABLE CHANNEL	TESTED CHANNEL	MODULATION TECHNOLOGY	AXIS
A	128 to 251	190	GSM, E-GPRS	Z
B	128 to 251	190	GSM	Z



**TEST CONDITION:**

APPLICABLE TO	ENVIRONMENTAL CONDITIONS	INPUT POWER	TESTED BY
OP	26deg. C, 65%RH	3.8Vdc	Sam Chen
FS	26deg. C, 65%RH	3.8Vdc	Sam Chen
OB	26deg. C, 65%RH	3.8Vdc	Sam Chen
EM	26deg. C, 65%RH	3.8Vdc	Sam Chen
BE	26deg. C, 65%RH	3.8Vdc	Sam Chen
CE	26deg. C, 65%RH	3.8Vdc	Sam Chen
RE < 1G	26deg. C, 65%RH	120Vac, 60Hz	Sam Chen
RE ≥ 1G	26deg. C, 65%RH	120Vac, 60Hz	Sam Chen

### FOR WCDMA:

EUT CONFIGURE MODE	APPLICABLE TO							DESCRIPTION
	OP	FS	OB	BE	CE	RE<1G	RE≥1G	
A	√	√	√	√	√	√	√	Main sample + Power from adapter 2

Where **OP**: Output power **FS**: Frequency stability  
**OB**: Occupied bandwidth **BE**: Band edge  
**CE**: Conducted spurious emissions **RE<1G**: Radiated emission below 1GHz  
**RE≥1G**: Radiated emission above 1GHz

### OUTPUT POWER MEASUREMENT:

- Pre-Scan has been conducted to determine the worst-case mode from all possible combinations between available modulations, data rates, XYZ axis and antenna ports (if EUT with antenna diversity architecture).
- Following channel(s) was (were) selected for the final test as listed below.

EUT CONFIGURE MODE	AVAILABLE CHANNEL	TESTED CHANNEL	MODULATION TECHNOLOGY	AXIS
A	4132 to 4233	4132, 4182, 4233	WCDMA	Z

### FREQUENCY STABILITY MEASUREMENT:

- Pre-Scan has been conducted to determine the worst-case mode from all possible combinations between available modulations and antenna ports (if EUT with antenna diversity architecture).
- Following channel(s) was (were) selected for the final test as listed below.

EUT CONFIGURE MODE	AVAILABLE CHANNEL	TESTED CHANNEL	MODULATION TECHNOLOGY
A	4132 to 4233	4182	WCDMA

### OCCUPIED BANDWIDTH MEASUREMENT:

- This item includes all test value of each mode, but only includes spectrum plot of worst value of each mode.
- Pre-Scan has been conducted to determine the worst-case mode from all possible combinations between available modulations and antenna ports (if EUT with antenna diversity architecture).
- Following channel(s) was (were) selected for the final test as listed below.

EUT CONFIGURE MODE	AVAILABLE CHANNEL	TESTED CHANNEL	MODULATION TECHNOLOGY
A	4132 to 4233	4132, 4182, 4233	WCDMA, HSDPA, HSUPA

### BAND EDGE MEASUREMENT:

- Pre-Scan has been conducted to determine the worst-case mode from all possible combinations between available modulations and antenna ports (if EUT with antenna diversity architecture).
- Following channel(s) was (were) selected for the final test as listed below.

EUT CONFIGURE MODE	AVAILABLE CHANNEL	TESTED CHANNEL	MODULATION TECHNOLOGY
A	4132 to 4233	4132, 4233	WCDMA, HSDPA, HSUPA



**CONDUCTED SPURIOUS EMISSIONS MEASUREMENT:**

- Pre-Scan has been conducted to determine the worst-case mode from all possible combinations between available modulations and antenna ports (if EUT with antenna diversity architecture).
- Following channel(s) was (were) selected for the final test as listed below.

EUT CONFIGURE MODE	AVAILABLE CHANNEL	TESTED CHANNEL	MODULATION TECHNOLOGY
A	4132 to 4233	4132, 4182, 4233	WCDMA

**RADIATED EMISSION MEASUREMENT (BELOW 1 GHz):**

- Pre-Scan has been conducted to determine the worst-case mode from all possible combinations between available modulations, data rates, XYZ axis and antenna ports (if EUT with antenna diversity architecture).
- Following channel(s) was (were) selected for the final test as listed below.

EUT CONFIGURE MODE	AVAILABLE CHANNEL	TESTED CHANNEL	MODULATION TECHNOLOGY	AXIS
A	4132 to 4233	4182	WCDMA	Z

**RADIATED EMISSION MEASUREMENT (ABOVE 1 GHz):**

- Pre-Scan has been conducted to determine the worst-case mode from all possible combinations between available modulations, data rates, XYZ axis and antenna ports (if EUT with antenna diversity architecture).
- Following channel(s) was (were) selected for the final test as listed below.

EUT CONFIGURE MODE	AVAILABLE CHANNEL	TESTED CHANNEL	MODULATION TECHNOLOGY	AXIS
A	4132 to 4233	4182	WCDMA	Z

**TEST CONDITION:**

APPLICABLE TO	ENVIRONMENTAL CONDITIONS	INPUT POWER	TESTED BY
OP	26deg. C, 65%RH	3.8Vdc	Sam Chen
FS	26deg. C, 65%RH	3.8Vdc	Sam Chen
OB	26deg. C, 65%RH	3.8Vdc	Sam Chen
EM	26deg. C, 65%RH	3.8Vdc	Sam Chen
BE	26deg. C, 65%RH	3.8Vdc	Sam Chen
CE	26deg. C, 65%RH	3.8Vdc	Sam Chen
RE < 1G	26deg. C, 65%RH	120Vac, 60Hz	Sam Chen
RE ≥ 1G	26deg. C, 65%RH	120Vac, 60Hz	Sam Chen



### 3.3 GENERAL DESCRIPTION OF APPLIED STANDARDS

The EUT is a RF product. According to the specifications of the manufacturer, it must comply with the requirements of the following standards:

**FCC 47 CFR Part 2**

**FCC 47 CFR Part 22**

**ANSI C63.4-2003**

**ANSI/TIA/EIA-603-C 2004**

**NOTE:** All test items have been performed and recorded as per the above standards.

### 3.4 DESCRIPTION OF SUPPORT UNITS

The EUT has been tested as an independent unit together with other necessary accessories or support units. The following support units or accessories were used to form a representative test configuration during the tests.

NO.	PRODUCT	BRAND	MODEL NO.	SERIAL NO.	FCC ID
1	EARPHONE	HTC	HS G400	NA	NA
2	UNIVERSAL RADIO COMMUNICATION TESTER	R&S	CMU200	104484	NA
3	NJZ-2000 (GPRS+WCDMA SIMULATOR)	JRC	NJZ-2000	ET00054	NA

NO.	SIGNAL CABLE DESCRIPTION OF THE ABOVE SUPPORT UNITS
1	1.2m non-shielded cable without core
2	NA
3	NA

**NOTE 1:** All power cords of the above support units are non shielded (1.8m).

**NOTE 2:** Item 2-3 acted as a communication partners to transfer data.

## **4 TEST TYPES AND RESULTS**

### **4.1 OUTPUT POWER MEASUREMENT**

#### **4.1.1 LIMITS OF OUTPUT POWER MEASUREMENT**

The radiated peak output power shall be according to the specific rule Part 22.913 (a) that "Mobile / Portable station are limited to 7 watts e.r.p".





#### 4.1.2 TEST INSTRUMENTS

DESCRIPTION & MANUFACTURER	MODEL NO.	SERIAL NO.	DATE OF CALIBRATION	DUE DATE OF CALIBRATION
Test Receiver ROHDE & SCHWARZ	ESIB7	100212	Aug. 02, 2011	Aug. 01, 2012
Spectrum Analyzer ROHDE & SCHWARZ	FSP 40	100041	Jul. 21, 2011	Jul. 20, 2012
BILOG Antenna SCHWARZBECK	VULB9168	9168-160	Apr. 13, 2011	Apr. 12, 2012
HORN Antenna SCHWARZBECK	9120D	209	Aug. 25, 2011	Aug. 24, 2012
HORN Antenna SCHWARZBECK	BBHA 9170	BBHA9170243	Dec. 27, 2010	Dec. 26, 2011
Preamplifier Agilent	8447D	2944A10633	Nov. 02, 2010	Nov. 01, 2011
Preamplifier Agilent	8449B	3008A01964	Nov. 02, 2010	Nov. 01, 2011
RF signal cable HUBER+SUHNNER	SUCOFLEX 104	295014/4	Aug. 19, 2011	Aug. 18, 2012
RF signal cable HUBER+SUHNNER	SUCOFLEX 104	12738/6	Aug. 19, 2011	Aug. 18, 2012
Software ADT.	ADT_Radiated_ V7.6.15.9.2	NA	NA	NA
Antenna Tower inn-co GmbH	MA 4000	013303	NA	NA
Antenna Tower Controller inn-co GmbH	CO2000	017303	NA	NA
Turn Table ADT.	TT100.	TT93021703	NA	NA
Turn Table Controller ADT.	SC100.	SC93021703	NA	NA

- NOTE:**
1. The calibration interval of the above test instruments is 12 months and the calibrations are traceable to NML/ROC and NIST/USA.
  2. The test was performed in HwaYa Chamber 3.
  3. The horn antenna and HP preamplifier (model: 8449B) are used only for the measurement of emission frequency above 1GHz if tested.
  4. The FCC Site Registration No. is 988962.
  5. The IC Site Registration No. is IC 7450F-3.

### 4.1.3 TEST PROCEDURES

#### **EIRP / ERP MEASUREMENT:**

- a. The power was measured with R&S Spectrum Analyzer. All measurements were done at 3 channels, 128, 190 and 251 (GSM, GPRS & E-GPRS) / 4132, 4182 and 4233 (WCDMA) (low, middle and high operational frequency range.) RWB and VBW is 1MHz for GSM, GPRS & E-GPRS and 5MHz for WCDMA mode.
- b. Substitution method is used for E.I.R.P measurement. In the semi-anechoic chamber, EUT placed on the 0.8m height of Turn Table, rotated the table around 360 degrees to search the maximum radiation power and receiver antenna shall be rotated vertical and horizontal polarization and moved height from 1m to 4m to find the maximum polar radiated power. The “ Read Value ” is the spectrum reading the maximum power value.
- c. The substitution horn antenna is substituted for EUT at the same position and signals generator export the CW signal to the substitution antenna via a tx cable. Rotated the Turn Table and moved receiving antenna to find the maximum radiation power. Adjust output power level of S.G to get a Value of spectrum reading equal to “ Read Value “ of step c. Record the power level of S.G
- d.  $EIRP = \text{Output power level of S.G} - \text{TX cable loss} + \text{Antenna gain of substitution horn.}$
- e. E.R.P power can be calculated form E.I.R.P power by subtracting the gain of dipole,  $E.R.P \text{ power} = E.I.P.R \text{ power} - 2.15\text{dBi.}$

#### **CONDUCTED POWER MEASUREMENT:**

- a. The EUT was set up for the maximum power with GSM, GPRS, E-GPRS & WCDMA link data modulation and link up with simulator.
- b. Set the EUT to transmit under low, middle and high channel and record the power level shown on simulator.

#### 4.1.4 TEST SETUP EIRP POWER MEASUREMENT:

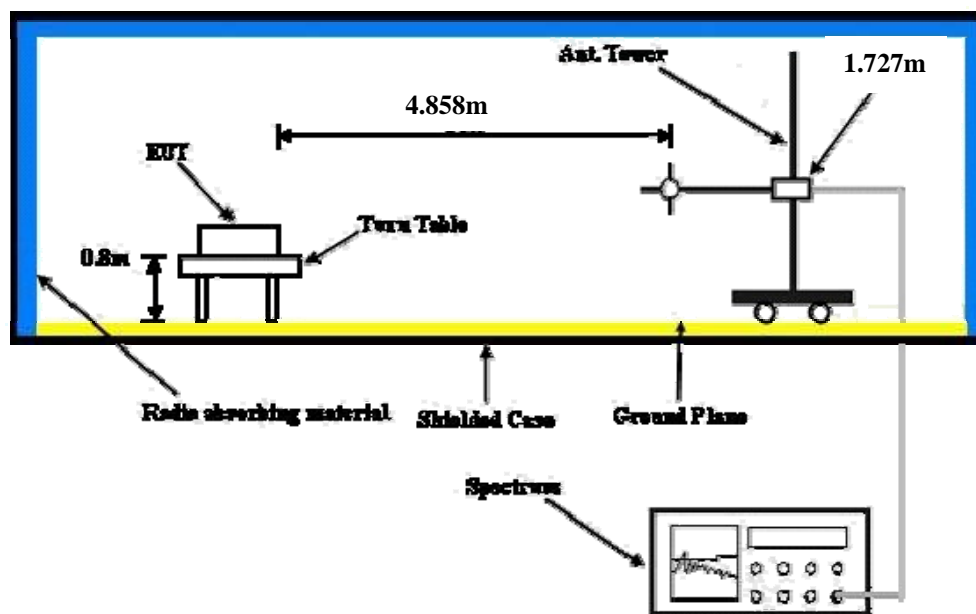

For the actual test configuration, please refer to the attached file (Test Setup Photo).

#### CONDUCTED POWER MEASUREMENT:

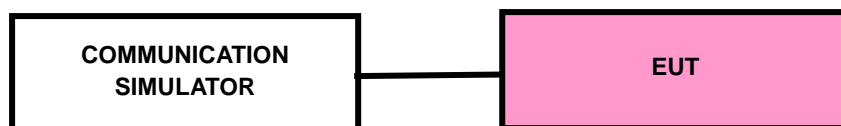

For the actual test configuration, please refer to the attached file (Test Setup Photo).

#### 4.1.5 EUT OPERATING CONDITIONS

- a. The EUT makes a call to the communication simulator.
- b. The communication simulator station system controlled a EUT to export maximum output power under transmission mode and specific channel frequency.

#### 4.1.6 TEST RESULTS

##### CONDUCTED OUTPUT POWER (dBm)

Band	GSM850		
Channel	128	190	251
Frequency (MHz)	824.2	836.6	848.8
GSM (1 Uplink)	33.87	33.77	33.91
GPRS 8 (1 Uplink)	33.63	33.47	33.66
GPRS 10 (2 Uplink)	32.75	32.94	32.57
EDGE 8 (1 Uplink)	26.98	27.04	27.03
EDGE 10 (2 Uplink)	25.74	25.75	25.92

Band	WCDMA V		
Channel	4132	4182	4233
Frequency (MHz)	826.4	836.4	846.6
RMC 12.2K	23.07	23.47	23.37
HSDPA Subtest-1	21.90	22.09	22.20
HSDPA Subtest-2	20.47	20.66	20.76
HSDPA Subtest-3	19.14	19.38	19.55
HSDPA Subtest-4	18.96	19.19	19.34
HSUPA Subtest-1	21.56	21.99	22.39
HSUPA Subtest-2	21.27	21.44	21.52
HSUPA Subtest-3	21.51	21.57	21.39
HSUPA Subtest-4	21.26	21.53	21.61
HSUPA Subtest-5	22.37	22.54	22.62



A D T

**ERP POWER (dBm)**

**TEST MODE A**

GSM 850_Class8 (Horizontal)					
CHANNEL NO.	FREQUENCY (MHz)	SPA Reading (dBm)	CORRECTION FACTOR (dB)	OUTPUT POWER	
				dBm	Watt
128	824.2	-0.8	33.1	30.2	1.0471
<b>190</b>	<b>836.6</b>	<b>-0.7</b>	<b>33.4</b>	<b>30.6</b>	<b>1.1482</b>
251	848.8	-1.8	33.5	29.6	0.9120

GSM 850_Class8 (Vertical)					
CHANNEL NO.	FREQUENCY (MHz)	SPA Reading (dBm)	CORRECTION FACTOR (dB)	OUTPUT POWER	
				dBm	Watt
128	824.2	-2.6	34.4	29.7	0.9333
190	836.6	-2.6	33.5	28.8	0.7586
251	848.8	-3.4	33.8	28.3	0.6761

E-GPRS 850 (1 Uplink) (Horizontal)					
CHANNEL NO.	FREQUENCY (MHz)	SPA Reading (dBm)	CORRECTION FACTOR (dB)	OUTPUT POWER	
				dBm	Watt
128	824.2	-5.6	33.1	25.4	0.3467
190	836.6	-4.9	33.4	26.4	0.4365
251	848.8	-5.7	33.5	25.7	0.3715

E-GPRS 850 (1 Uplink) (Vertical)					
CHANNEL NO.	FREQUENCY (MHz)	SPA Reading (dBm)	CORRECTION FACTOR (dB)	OUTPUT POWER	
				dBm	Watt
128	824.2	-7.0	34.4	25.3	0.3388
190	836.6	-6.9	33.5	24.5	0.2818
251	848.8	-7.3	33.8	24.4	0.2754

WCDMA Band V_RMC 12.2K (Horizontal)					
CHANNEL NO.	FREQUENCY (MHz)	SPA Reading (dBm)	CORRECTION FACTOR (dB)	OUTPUT POWER	
				dBm	Watt
4132	826.4	-12.2	33.1	18.8	0.0759
4182	836.4	-12.2	33.4	19.1	0.0813
4233	846.6	-12.2	33.5	19.2	0.0832

WCDMA Band V_RMC 12.2K (Vertical)					
CHANNEL NO.	FREQUENCY (MHz)	SPA Reading (dBm)	CORRECTION FACTOR (dB)	OUTPUT POWER	
				dBm	Watt
4132	826.4	-16.2	34.4	16.1	0.0407
4182	836.4	-15.6	33.5	15.8	0.0380
4233	846.6	-15.3	33.8	16.4	0.0437

**TEST MODE B**

GSM 850_Class8 (Horizontal)					
CHANNEL NO.	FREQUENCY (MHz)	SPA Reading (dBm)	CORRECTION FACTOR (dB)	OUTPUT POWER	
				dBm	Watt
128	824.2	-0.9	33.1	30.1	1.023.3
190	836.6	-1.1	33.4	30.2	1.047.1
251	848.8	-1.2	33.5	30.2	1.047.1
GSM 850_Class8 (Vertical)					
CHANNEL NO.	FREQUENCY (MHz)	SPA Reading (dBm)	CORRECTION FACTOR (dB)	OUTPUT POWER	
				dBm	Watt
128	824.2	-4.3	34.4	28.0	0.6310
190	836.6	-4.6	33.5	26.8	0.4786
251	848.8	-4.8	33.8	26.9	0.4898

**REMARKS:** 1. Output Power (dBm) = SPA Reading (dBm) + Correction Factor (dB).  
 2. Correction factor (dB) = Free Space Loss + Antenna Factor + Cable Loss.



## 4.2 FREQUENCY STABILITY MEASUREMENT

### 4.2.1 LIMITS OF FREQUENCY STABILITY MEASUREMENT

According to the FCC part 22.863 shall be tested the frequency stability. The rule is defined that "The frequency stability shall be sufficient to ensure that the fundamental emission stays within the authorized frequency block." The frequency error rate is according to the JTC standard that the frequency error rate shall be accurate to within 2.5ppm of the received frequency from the base station.

### 4.2.2 TEST INSTRUMENTS

DESCRIPTION & MANUFACTURER	MODEL NO.	SERIAL NO.	CALIBRATED UNTIL	CALIBRATED UNTIL
Spectrum Analyzer Agilent	E4446A	MY43360128	Feb. 22, 2011	Feb. 21, 2012
Hewlett Packard RF cable	8120-6192	01428251	NA	NA
RF cable	SUCOFLEX 104	257029	Jan. 07, 2011	Jan. 06, 2012
WIT Standard Temperature & Humidity Chamber	MHU-225AU	920842	Jun. 15, 2011	Jun. 14, 2012

**NOTE:** The calibration interval of the above test instruments is 12 months. And the calibrations are traceable to NML/ROC and NIST/USA.

#### 4.2.3 TEST PROCEDURE

- a. Because of the measure the carrier frequency under the condition of the AFC lock, it shall be used the mobile station in the GSM / E-GPRS / WCDMA link mode. This is accomplished with the use of the R&S CMU200 / JRC NJZ-2000 simulator station. The oven room could control the temperatures and humidity. The GSM & E-GPRS link channel is the 190 and the WCDMA link channel is the 4182.
- b. Power must be removed when changing from one temperature to another or one voltage to another voltage. Power warm up is at least 15 min and power applied should perform before recording frequency error.
- c. EUT is connected the external power supply to control the DC input power. The various Volts from the minimum 3.6Volts to 4.2Volts. Each step shall be record the frequency error rate.
- d. The temperature range step is 10 degrees in this test items. All temperature levels shall be hold the  $\pm 0.5$  during the measurement testing.
- e. The each temperature step shall be at least 0.5 hours, consider the EUT could be test under the stability condition.

**NOTE:** The frequency error was recorded frequency error from the communication simulator.

#### 4.2.4 TEST SETUP

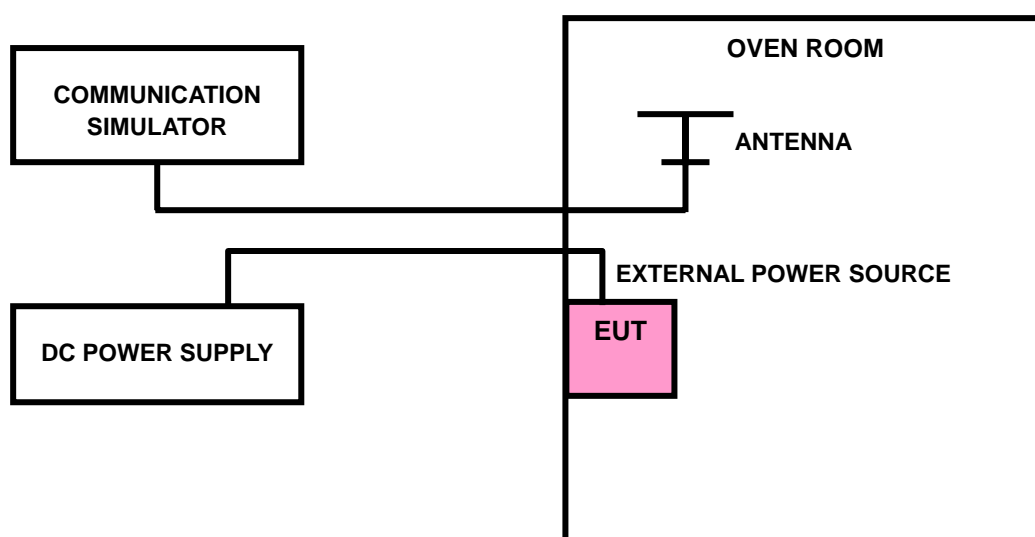



## 4.2.5 TEST RESULTS

### FOR GSM:

AFC FREQUENCY ERROR vs. VOLTAGE			
VOLTAGE (Volts)	FREQUENCY ERROR (Hz)	FREQUENCY ERROR (ppm)	LIMIT (ppm)
4.2	32	0.038	2.5
3.6	31	0.037	2.5

**NOTE:** The applicant defined the normal working voltage of the battery is from 3.6Vdc to 4.2Vdc.

AFC FREQUENCY ERROR vs. TEMP.			
TEMP. ( )	FREQUENCY ERROR (Hz)	FREQUENCY ERROR (ppm)	LIMIT (ppm)
55	38	0.045	2.5
50	36	0.043	2.5
40	34	0.041	2.5
30	33	0.039	2.5
20	31	0.037	2.5
10	32	0.038	2.5
0	33	0.039	2.5
-10	35	0.042	2.5

**FOR E-GPRS:**

AFC FREQUENCY ERROR vs. VOLTAGE			
VOLTAGE (Volts)	FREQUENCY ERROR (Hz)	FREQUENCY ERROR (ppm)	LIMIT (ppm)
4.2	39	0.047	2.5
3.6	37	0.044	2.5

**NOTE:** The applicant defined the normal working voltage of the battery is from 3.6Vdc to 4.2Vdc.

AFC FREQUENCY ERROR vs. TEMP.			
TEMP. ( )	FREQUENCY ERROR (Hz)	FREQUENCY ERROR (ppm)	LIMIT (ppm)
55	39	0.047	2.5
50	38	0.045	2.5
40	38	0.045	2.5
30	37	0.044	2.5
20	38	0.045	2.5
10	38	0.045	2.5
0	38	0.045	2.5
-10	37	0.044	2.5

**FOR WCDMA:**

AFC FREQUENCY ERROR vs. VOLTAGE			
VOLTAGE (Volts)	FREQUENCY ERROR (Hz)	FREQUENCY ERROR (ppm)	LIMIT (ppm)
4.2	52	0.062	2.5
3.6	50	0.060	2.5

**NOTE:** The applicant defined the normal working voltage of the battery is from 3.6Vdc to 4.2Vdc.

AFC FREQUENCY ERROR vs. TEMP.			
TEMP. ( )	FREQUENCY ERROR (Hz)	FREQUENCY ERROR (ppm)	LIMIT (ppm)
55	57	0.068	2.5
50	55	0.066	2.5
40	56	0.067	2.5
30	54	0.065	2.5
20	55	0.066	2.5
10	54	0.065	2.5
0	56	0.067	2.5
-10	57	0.068	2.5

### 4.3 OCCUPIED BANDWIDTH MEASUREMENT

#### 4.3.1 LIMITS OF OCCUPIED BANDWIDTH MEASUREMENT

The width of a frequency band such that, below the lower and above the upper frequency limits, the mean powers emitted are each equal to a specified percentage 0.5 %of the totalmean power of a given emission.

#### 4.3.2 TEST INSTRUMENTS

DESCRIPTION & MANUFACTURER	MODEL NO.	SERIAL NO.	DATE OF CALIBRATION	DUE DATE OF CALIBRATION
SPECTRUM ANALYZER R&S	FSP40	100039	Jan. 11, 2011	Jan. 10, 2012
Mini-Circuits Power Splitter	ZN2PD-9G	NA	May 25, 2011	May 24, 2012
RF cable	SUCOFLEX 104	274403/4	Jan. 07, 2011	Jan. 06, 2012
RF cable	SUCOFLEX 104	250729/4	Jan. 07, 2011	Jan. 06, 2012
RF cable	SUCOFLEX 104	214377/4	Jan. 07, 2011	Jan. 06, 2012
JFW 20dB attenuation	50HF-020-SMA	NA	NA	NA

**NOTE:** The calibration interval of the above test instruments is 12 months. And the calibrations are traceable to NML/ROC and NIST/USA.

#### 4.3.3 TEST SETUP

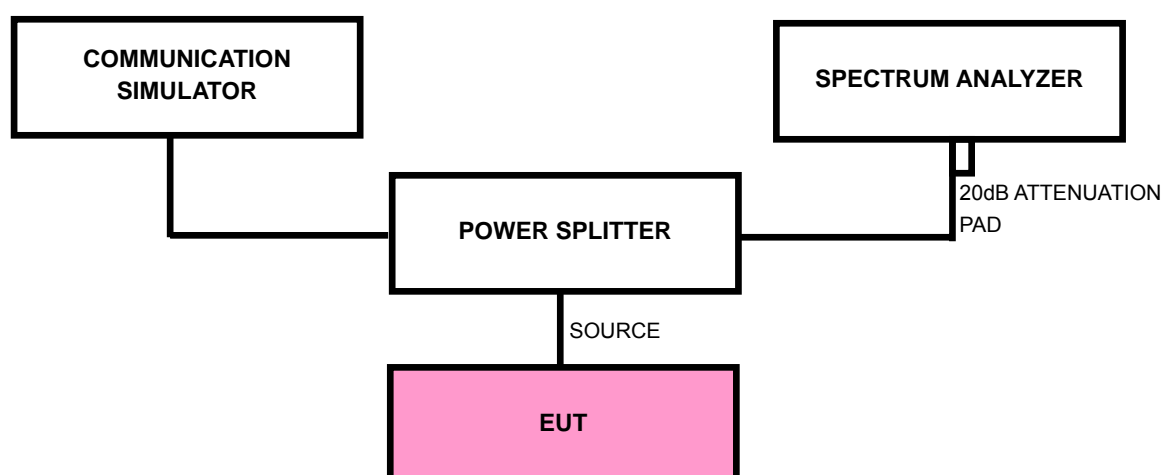

#### 4.3.4 TEST PROCEDURES

- a. The EUT makes a call to the communication simulator. The power was measured with R&S Spectrum Analyzer. All measurements were done at 3 channels, 128, 190 and 251 (GSM / GPRS / E-GPRS) / 4132, 4182 and 4233 (WCDMA) (low, middle and high operational frequency range.)
- b. The conducted occupied bandwidth used the power splitter via EUT RF power connector between simulation base station and spectrum analyzer.
- c. The communication simulator station system controlled a EUT to export maximum output power under transmission mode and specific channel frequency. Use OBW measurement function of Spectrum analyzer to measure 99 % occupied bandwidth.

#### 4.3.5 EUT OPERATING CONDITION

- a. The EUT makes a call to the communication simulator.
- b. The communication simulator station system controlled a EUT to export maximum and minimum output power under transmission mode and specific channel frequency.

### 4.3.6 TEST RESULTS

**FOR GSM, GPRS, E-GPRS:**

**FOR GSM MODE**

CHANNEL	FREQUENCY (MHz)	99% OCCUPIED BANDWIDTH (kHz)
128	824.2	244
190	836.6	244
251	848.8	244

#### CH 128

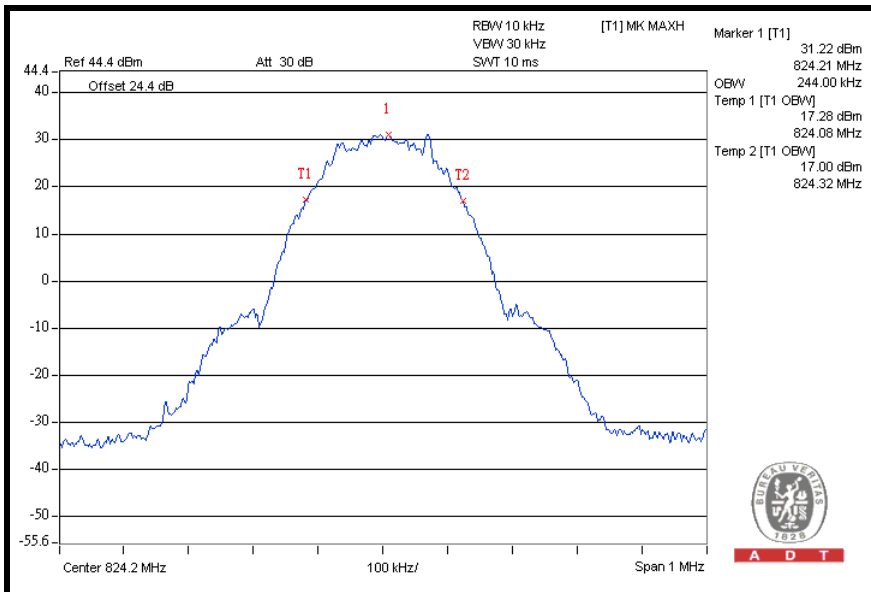

**FOR GPRS MODE (UP-LINK WITH 1 TIME SLOT)**

CHANNEL	FREQUENCY (MHz)	99% OCCUPIED BANDWIDTH (kHz)
128	824.2	244
190	836.6	242
251	848.8	246

**CH 251**

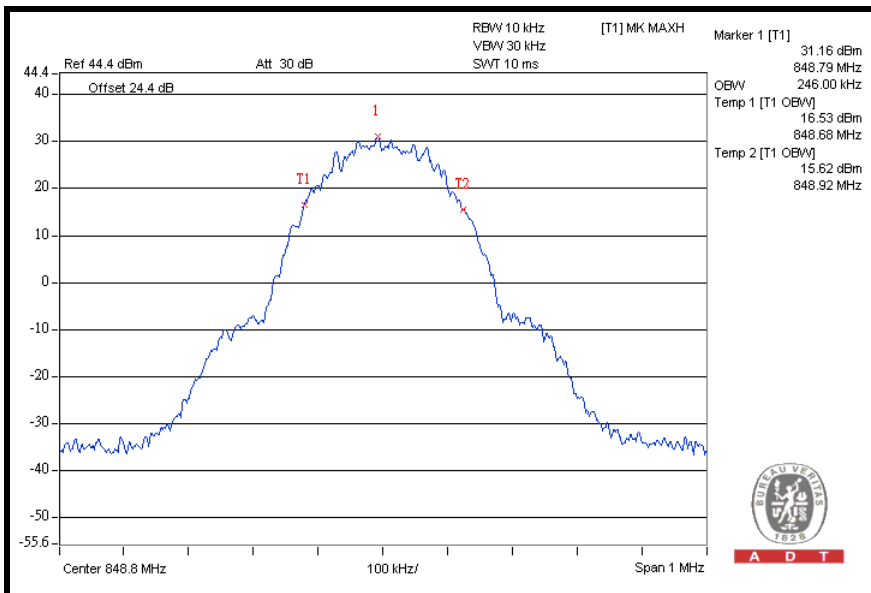

**FOR E-GPRS MODE (UP-LINK WITH 1 TIME SLOT)**

CHANNEL	FREQUENCY (MHz)	99% OCCUPIED BANDWIDTH (kHz)
128	824.2	244
190	836.6	238
251	848.8	238

**CH 128**

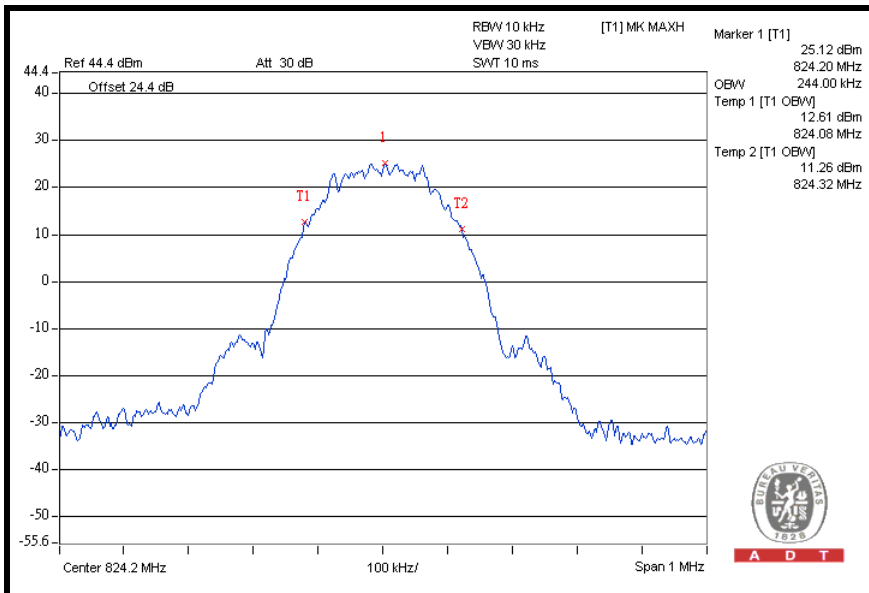



**FOR WCDMA:**

**FOR WCDMA-RMC:**

CHANNEL	FREQUENCY (MHz)	99% OCCUPIED BANDWIDTH (MHz)
4132	826.4	4.12
4182	836.4	4.16
4233	846.6	4.12

**CH 4182**

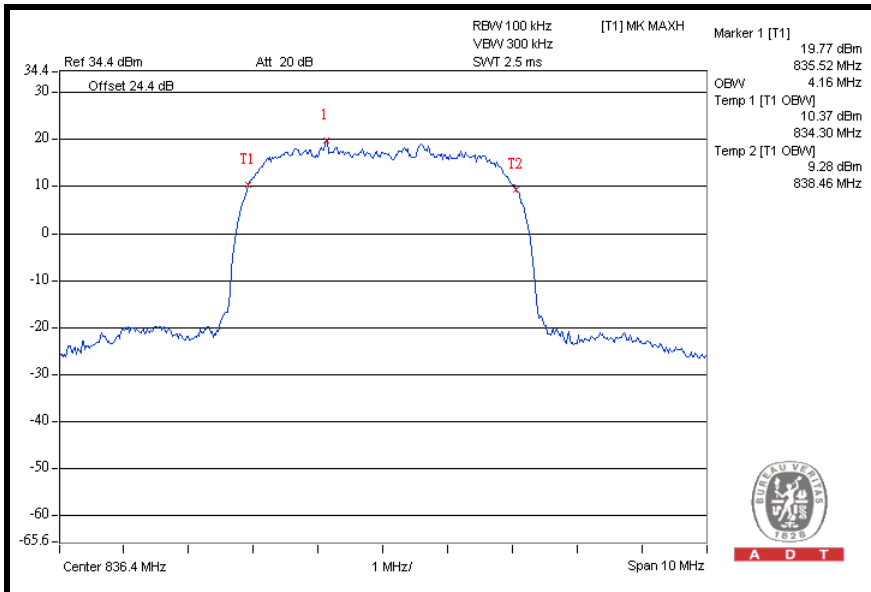

**FOR HSDPA:**

CHANNEL	FREQUENCY (MHz)	99% OCCUPIED BANDWIDTH (MHz)
4132	826.4	4.14
4182	836.4	4.16
4233	846.6	4.12

**CH 4182**

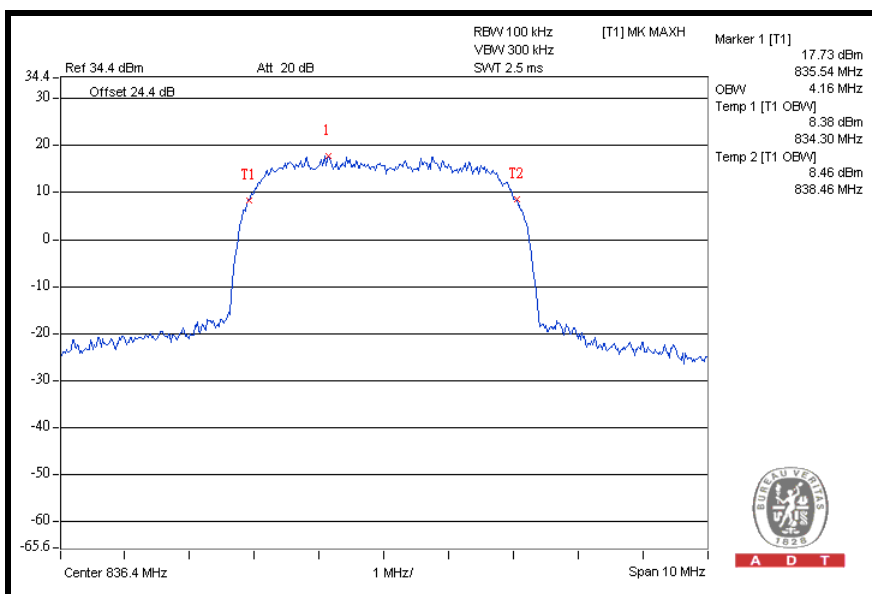

**FOR HSUPA:**

CHANNEL	FREQUENCY (MHz)	99% OCCUPIED BANDWIDTH (MHz)
4132	826.4	4.16
4182	836.4	4.16
4233	846.6	4.14

**CH 4132**

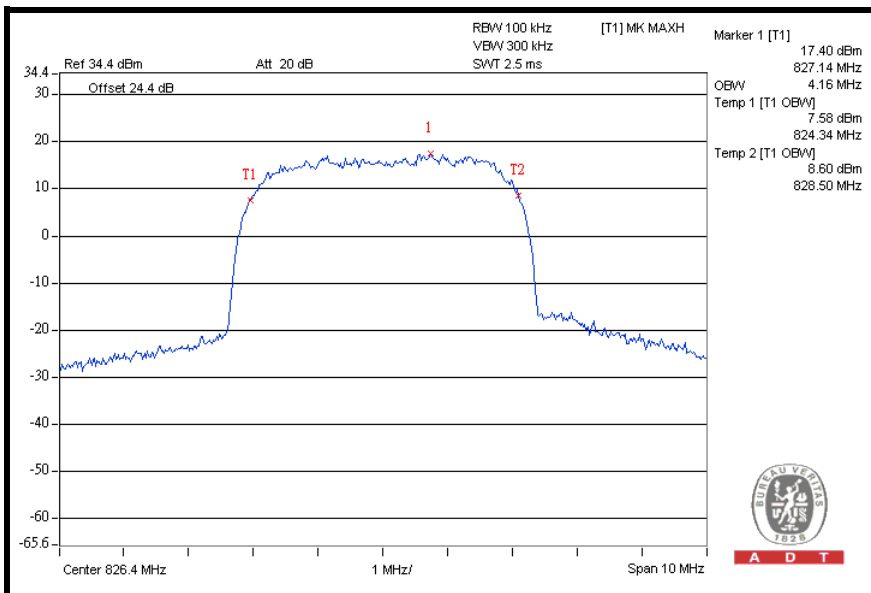

## 4.4 BAND EDGE MEASUREMENT

### 4.4.1 LIMITS OF BAND EDGE MEASUREMENT

According to FCC 22.917 specified that power of any emission outside of the authorized operating frequency ranges must be attenuated below the transmitting power (P) by a factor of at least  $43 + 10 \log(P)$  dB. In the 1 MHz bands immediately outside and adjacent to the frequency block a resolution bandwidth of at least one percent of the emission bandwidth of the fundamental emission of the transmitter may be employed.

### 4.4.2 TEST INSTRUMENTS

DESCRIPTION & MANUFACTURER	MODEL NO.	SERIAL NO.	DATE OF CALIBRATION	DUE DATE OF CALIBRATION
SPECTRUM ANALYZER R&S	FSP40	100039	Jan. 11, 2011	Jan. 10, 2012
Mini-Circuits Power Splitter	ZN2PD-9G	NA	May 25, 2011	May 24, 2012
RF cable	SUCOFLEX 104	274403/4	Jan. 07, 2011	Jan. 06, 2012
RF cable	SUCOFLEX 104	250729/4	Jan. 07, 2011	Jan. 06, 2012
RF cable	SUCOFLEX 104	214377/4	Jan. 07, 2011	Jan. 06, 2012
JFW 20dB attenuation	50HF-020-SMA	NA	NA	NA

**NOTE:** The calibration interval of the above test instruments is 12 months. And the calibrations are traceable to NML/ROC and NIST/USA.

### 4.4.3 TEST SETUP

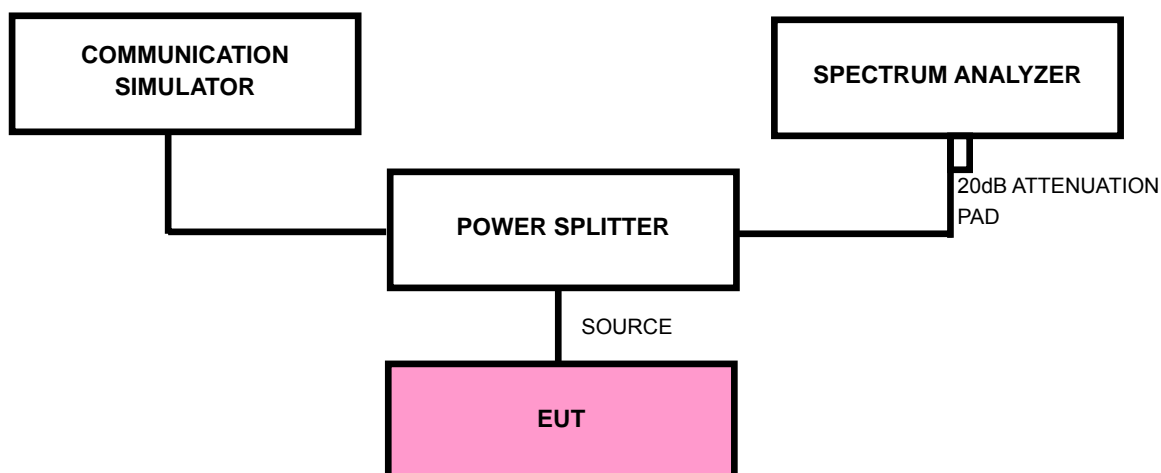

#### 4.4.4 TEST PROCEDURES

- a. The EUT makes a call to the communication simulator. The power was measured with R&S Spectrum Analyzer. All measurements were done at 2 channels, 128 and 251 (GSM/GPRS/E-GPRS) / 4132 and 4233 (WCDMA) (low and high operational frequency range.)
- b. The band edge measurement used the power splitter via EUT RF power connector between simulation base station and spectrum analyzer.
- c. The center frequency of spectrum is the band edge frequency and span is 1.5 MHz. RB of the spectrum is 3kHz and VB of the spectrum is 10kHz (GSM/GPRS/E-GPRS).
- d. The center frequency of spectrum is the band edge frequency and span is 10MHz. RB of the spectrum is 100kHz and VB of the spectrum is 300kHz (WCDMA).
- e. Record the max trace plot into the test report.

#### 4.4.5 EUT OPERATING CONDITION

- a. The EUT makes a phone call to the communication simulator.
- b. The communication simulator station system controlled a EUT to export maximum output power under transmission mode and specific channel frequency.

#### 4.4.6 TEST RESULTS

**FOR GSM / GPRS / E-GPRS:**

**FOR GSM**

#### LOWER BAND EDGE

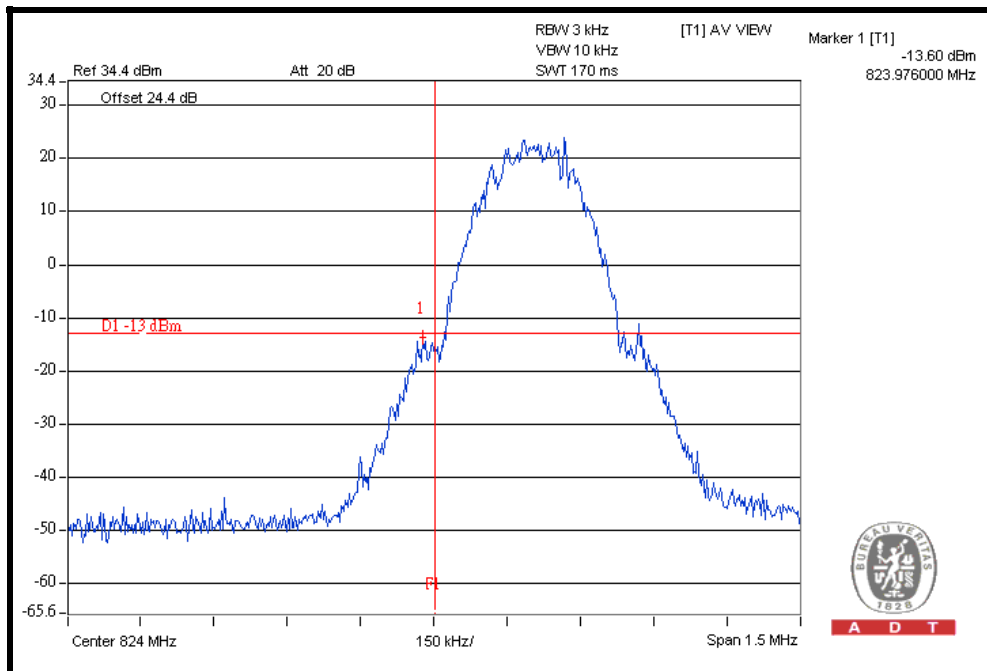

#### HIGHER BAND EDGE

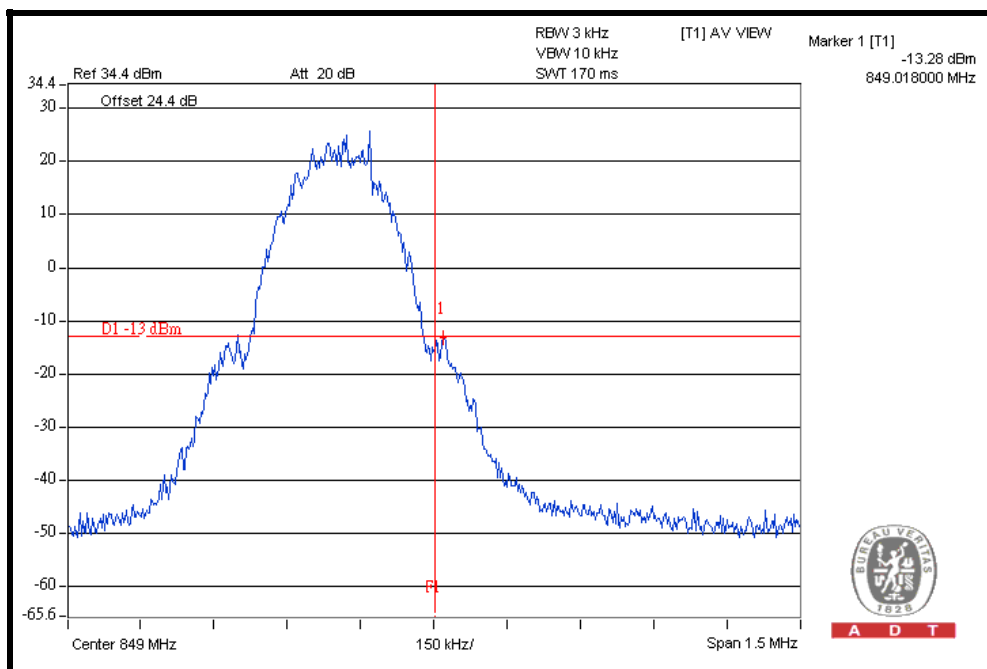

**FOR GPRS MODE (UP-LINK WITH 1 TIME SLOT)**

**LOWER BAND EDGE**

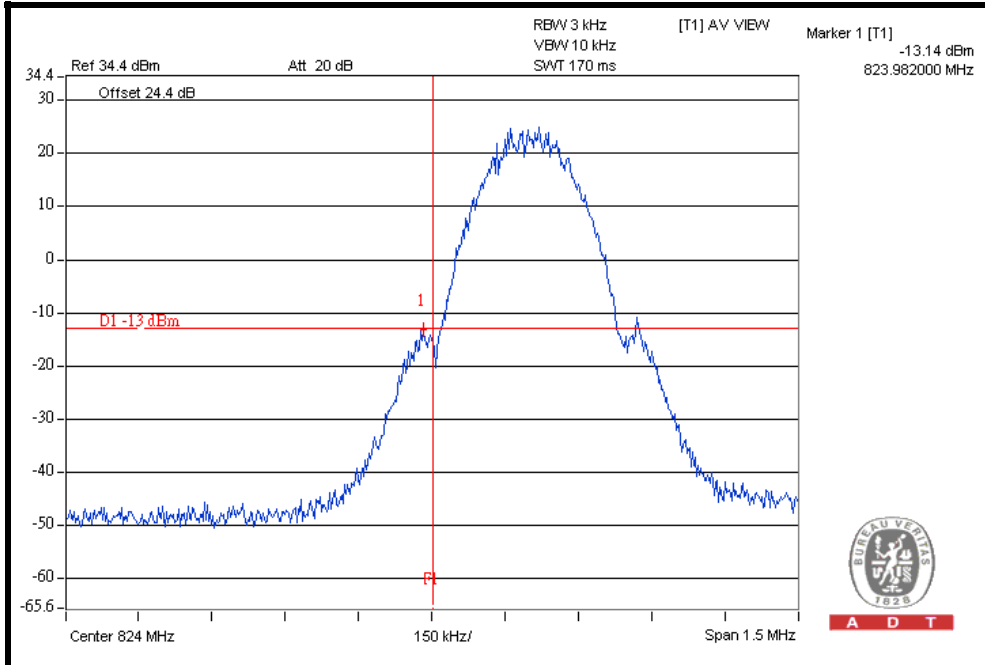

**HIGHER BAND EDGE**

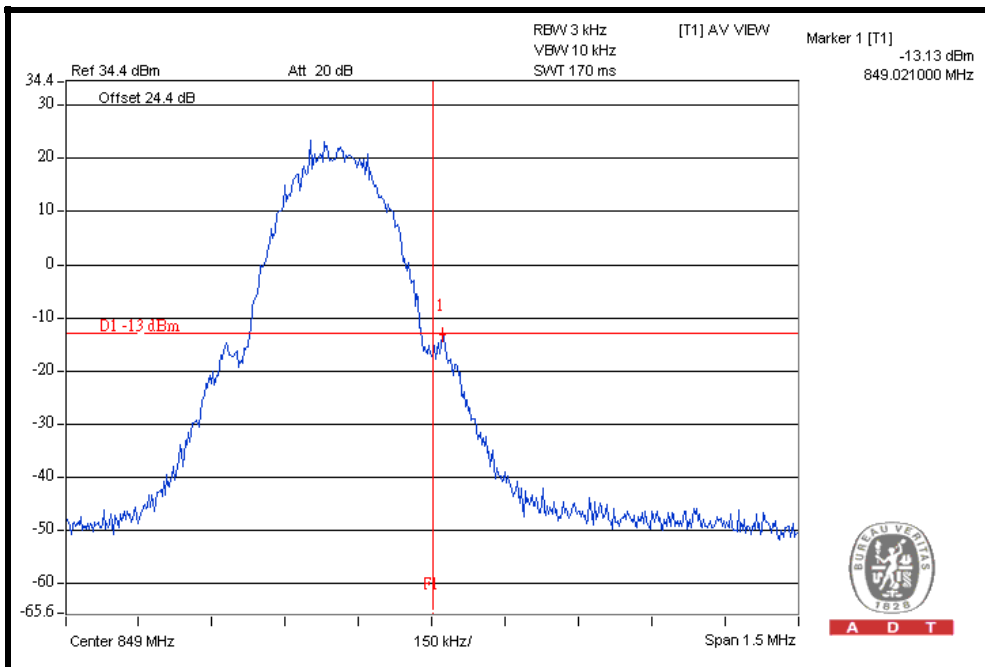

**FOR E-GPRS MODE (UP-LINK WITH 1 TIME SLOT)**

**LOWER BAND EDGE**

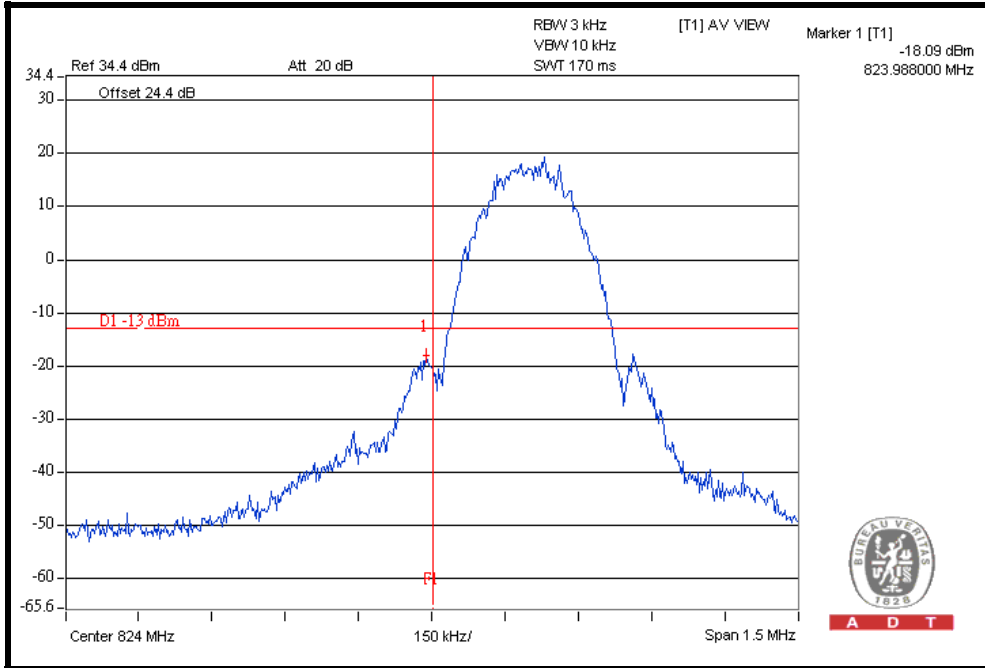

**HIGHER BAND EDGE**

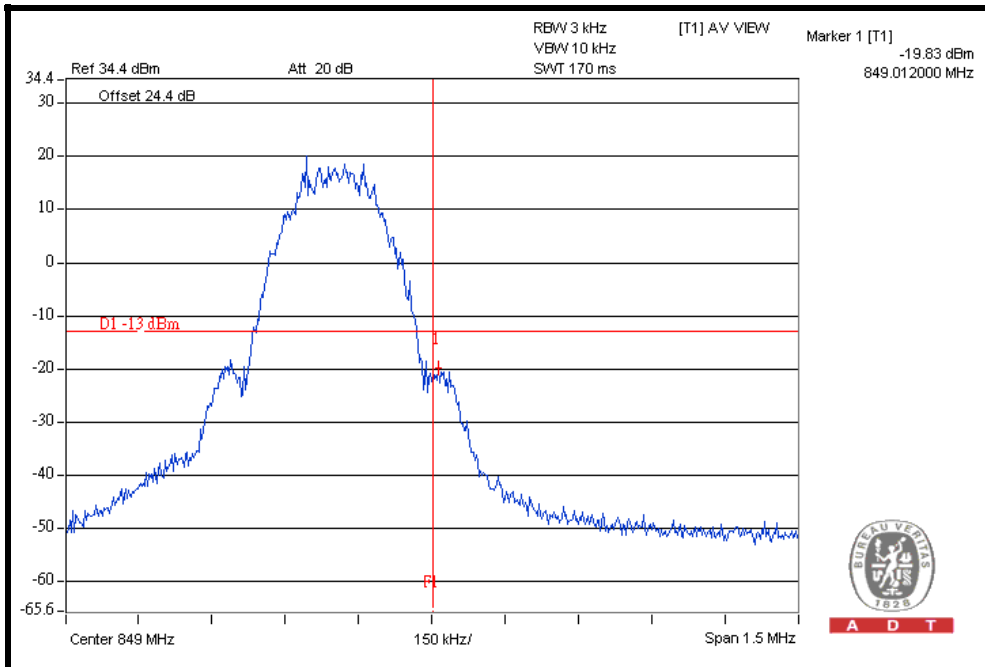



**FOR WCDMA:**

**WCDMA-RMC MODE**

**LOWER BAND EDGE**

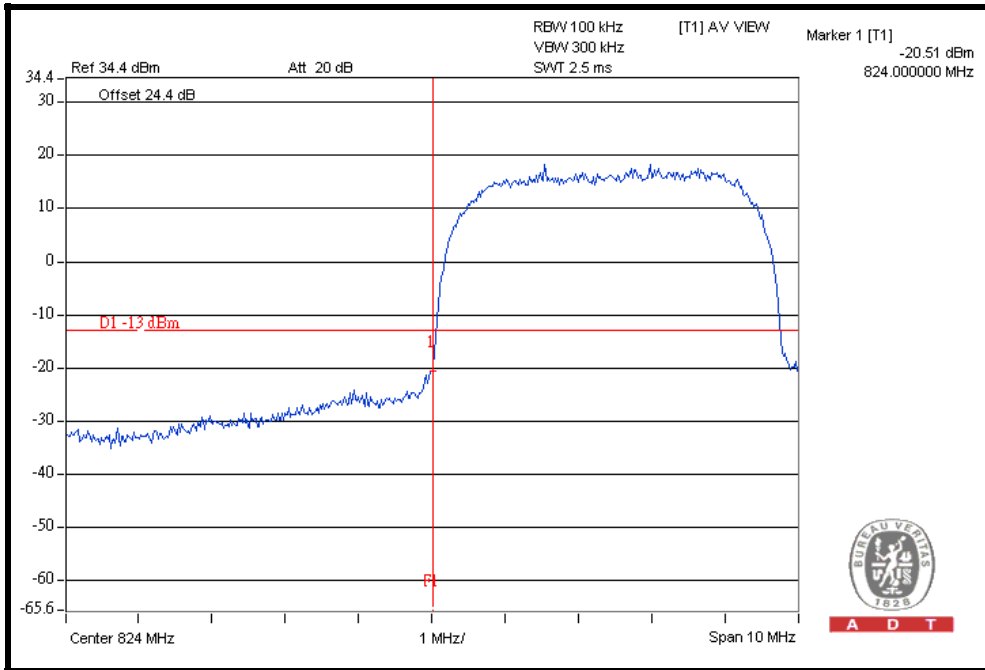

**HIGHER BAND EDGE**

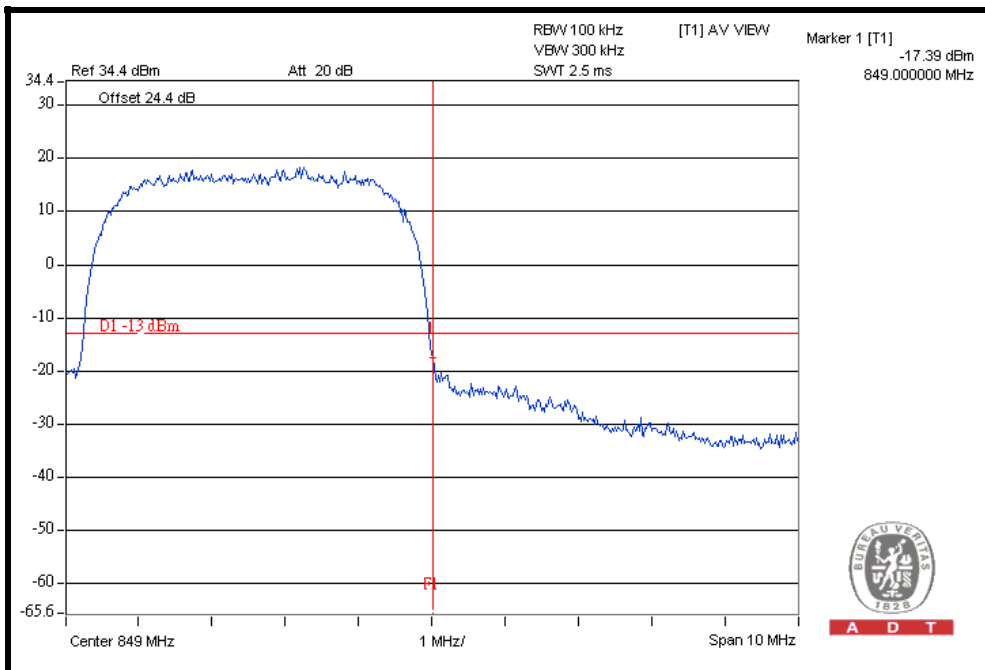

## HSDPA MODE

### LOWER BAND EDGE

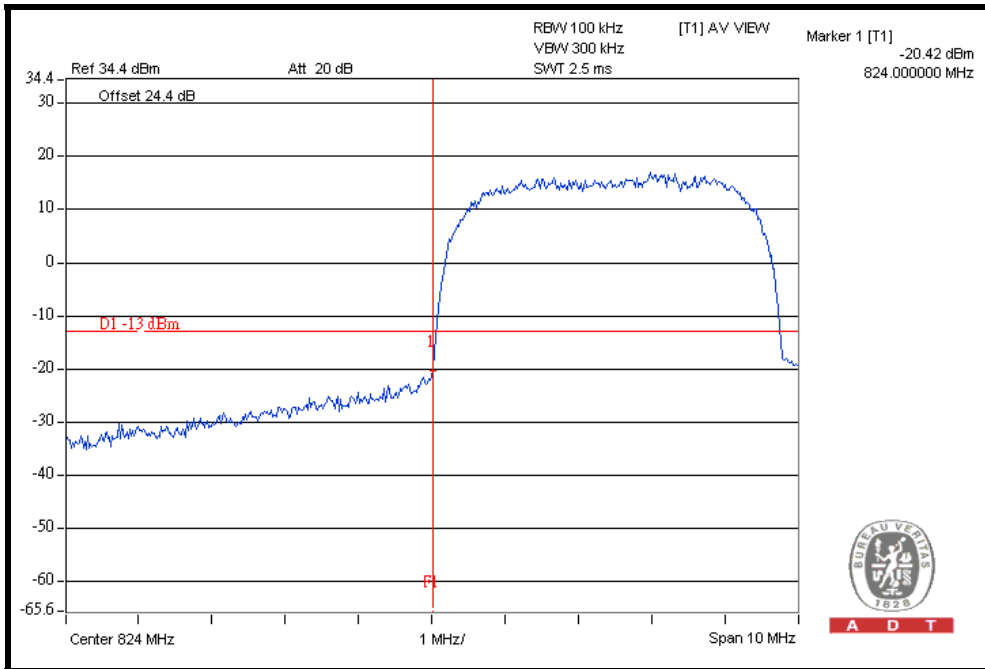

### HIGHER BAND EDGE

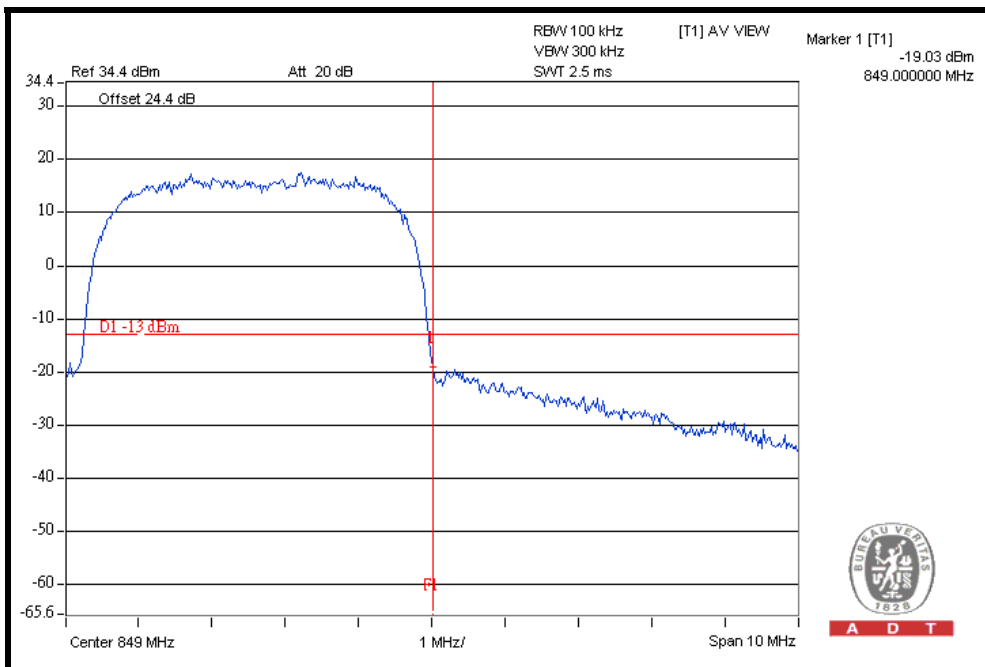

## HSUPA MODE

### LOWER BAND EDGE

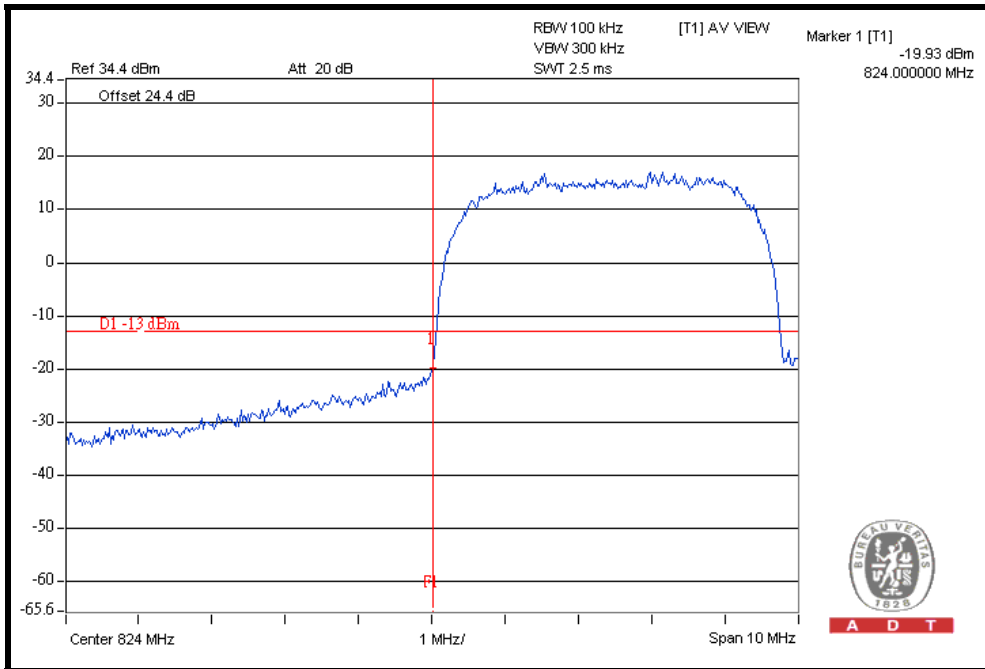

### HIGHER BAND EDGE

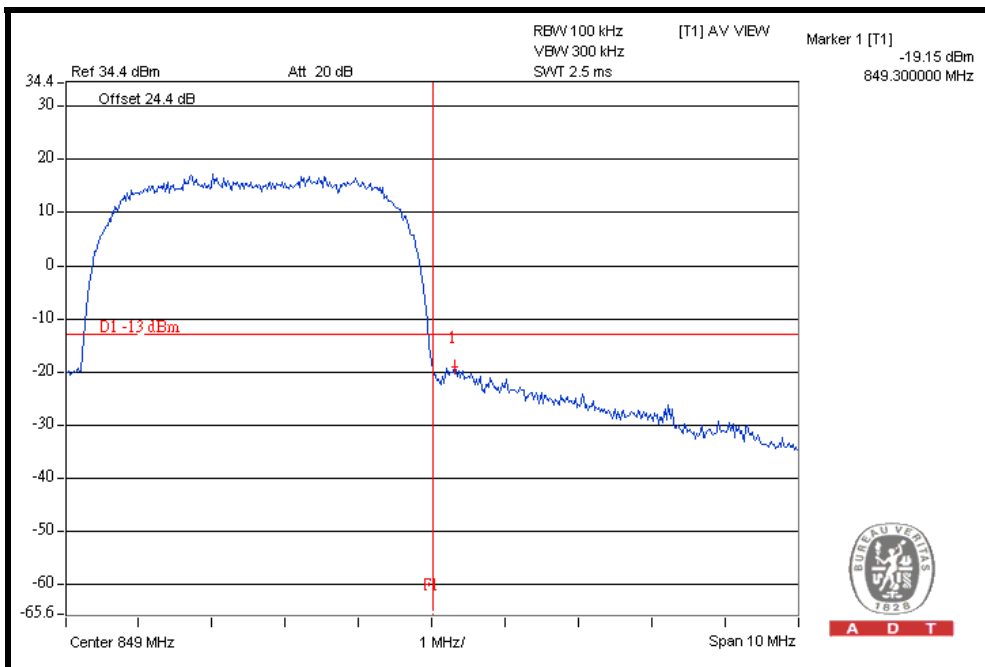



## 4.5 CONDUCTED SPURIOUS EMISSIONS

### 4.5.1 LIMITS OF CONDUCTED SPURIOUS EMISSIONS MEASUREMENT

In the FCC 22.917, On any frequency outside a licensee's frequency block within GPRS spectrum, the power of any emission shall be attenuated below the transmitter power (P) by at least  $43 + 10 \log (P)$  dB. The emission limit equal to  $-13\text{dBm}$ .

### 4.5.2 TEST INSTRUMENTS

DESCRIPTION & MANUFACTURER	MODEL NO.	SERIAL NO.	DATE OF CALIBRATION	DUE DATE OF CALIBRATION
SPECTRUM ANALYZER R&S	FSP40	100039	Feb. 23, 2011	Feb. 22, 2012
Mini-Circuits Power Splitter	ZN2PD-9G	NA	May 25, 2011	May 24, 2012
RF cable	SUCOFLEX 104	274403/4	Jan. 07, 2011	Jan. 06, 2012
RF cable	SUCOFLEX 104	250729/4	Jan. 07, 2011	Jan. 06, 2012
RF cable	SUCOFLEX 104	214377/4	Jan. 07, 2011	Jan. 06, 2012
JFW 20dB attenuation	50HF-020-SMA	NA	NA	NA

**NOTE:** The calibration interval of the above test instruments is 12 months. And the calibrations are traceable to NML/ROC and NIST/USA.

#### 4.5.3 TEST PROCEDURE

- a. The EUT makes a phone call to the communication simulator. The power was measured with R&S Spectrum Analyzer. All measurements were done at 3 channels, 128, 190 and 251 (GSM) / 4132, 4182 and 4233 (WCDMA) (low, middle and high operational frequency range.)
- b. The conducted spurious emission used the power splitter via EUT RF power connector between simulation base station and spectrum analyzer.
- c. Measuring frequency range is from 9 kHz to 9GHz. 20dB attenuation pad is connected with spectrum. RBW=1MHz and VBW=3MHz is used for conducted emission measurement.

#### 4.5.4 TEST SETUP

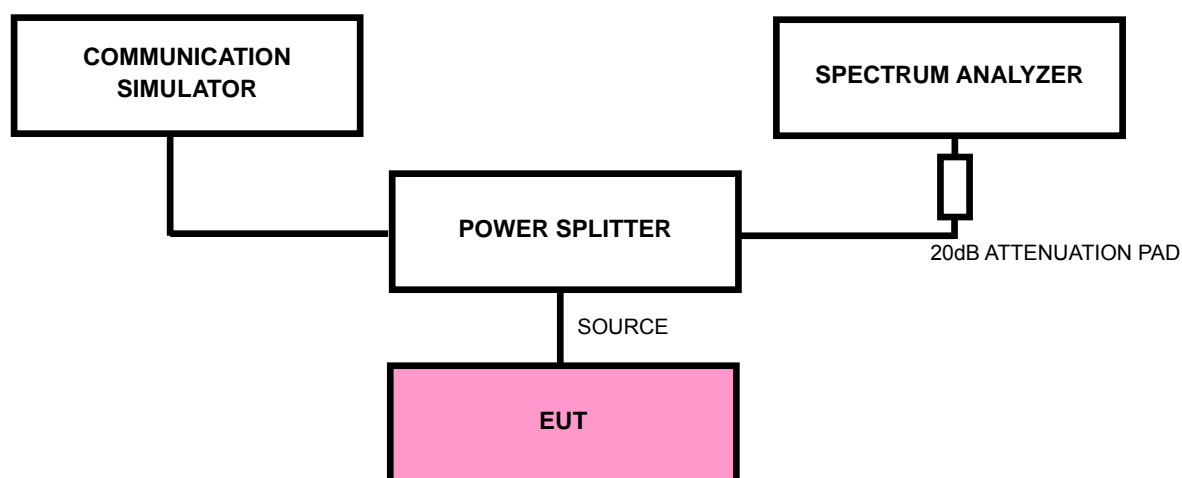

#### 4.5.5 EUT OPERATING CONDITIONS

- a. The EUT makes a call to the communication simulator.
- b. The communication simulator station system controlled a EUT to export maximum output power under transmission mode and specific channel frequency.

## 4.5.6 TEST RESULTS

### FOR GSM:

#### CH 128: 9kHz ~ 1GHz

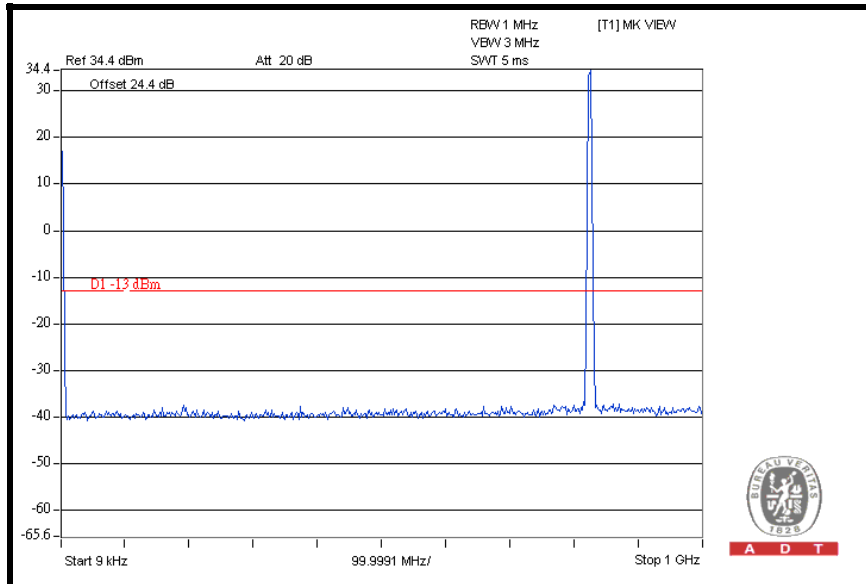

#### 1GHz ~ 4GHz

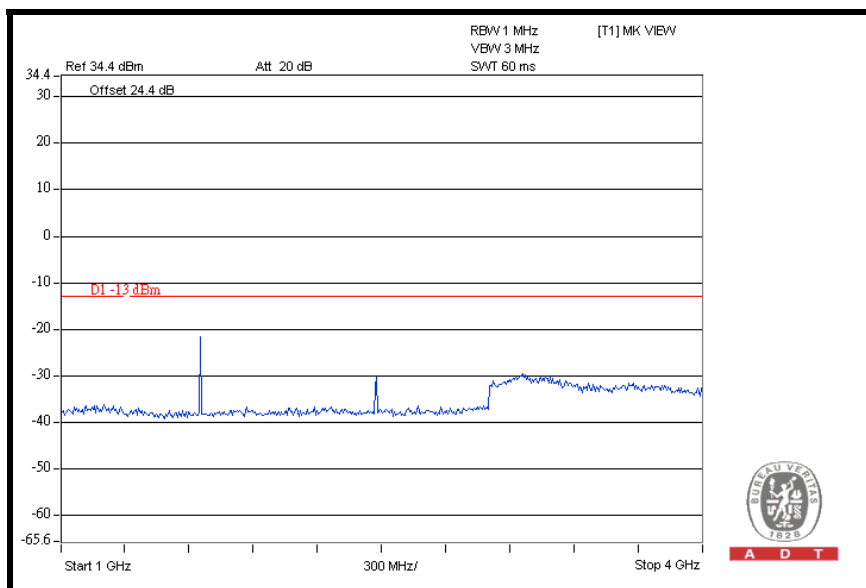

### 4GHz ~ 7GHz

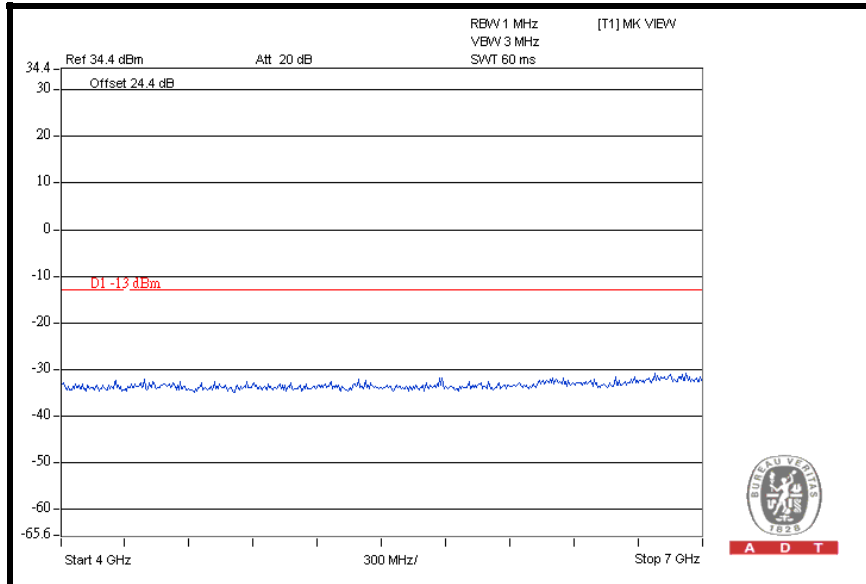

### 7GHz ~ 9GHz

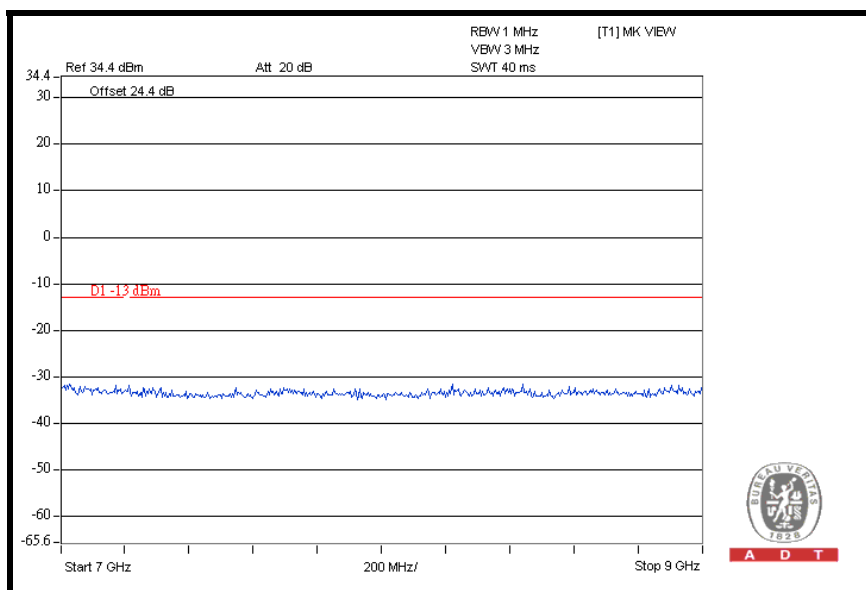

**CH 190: 9kHz ~ 1GHz**

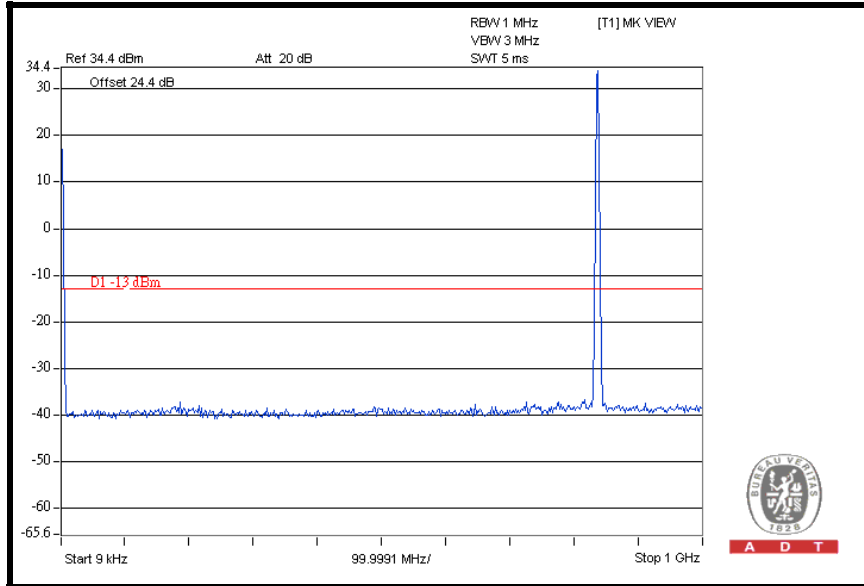

**1GHz ~ 4GHz**

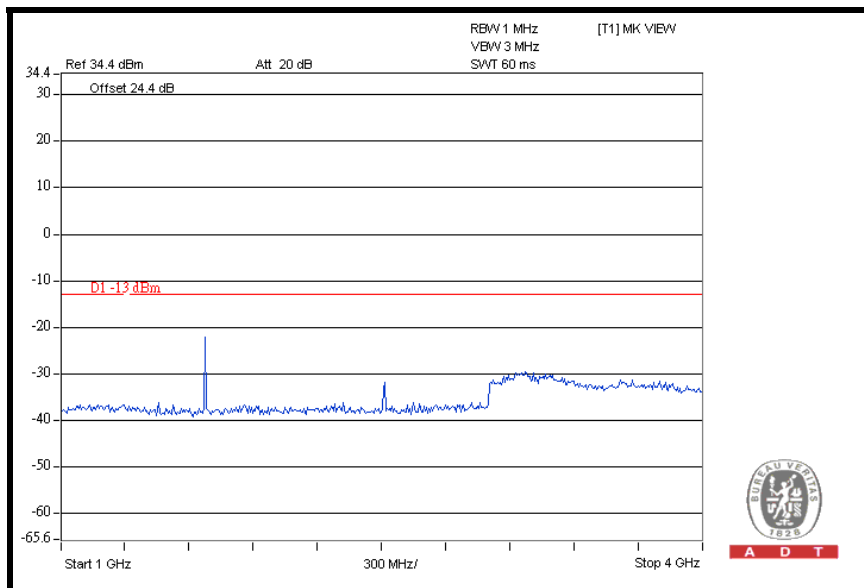



### 4GHz ~ 7GHz

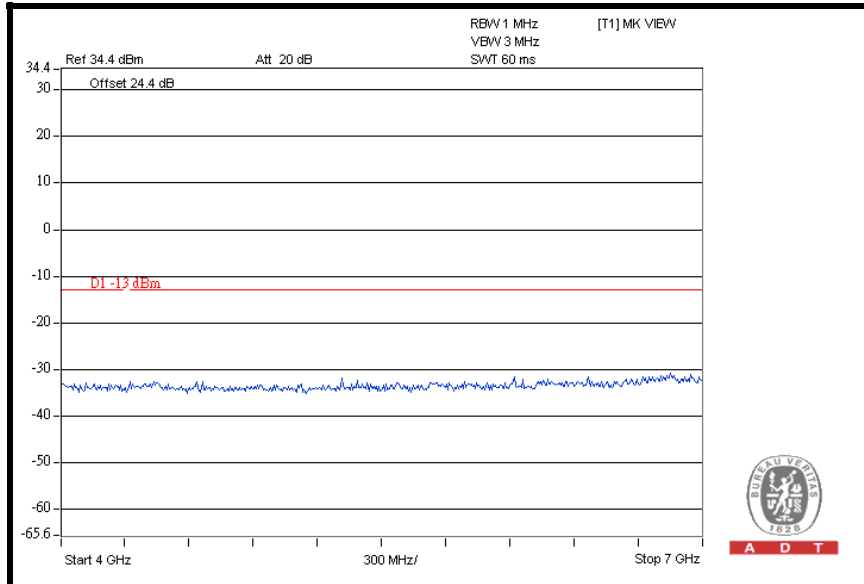

### 7GHz ~ 9GHz

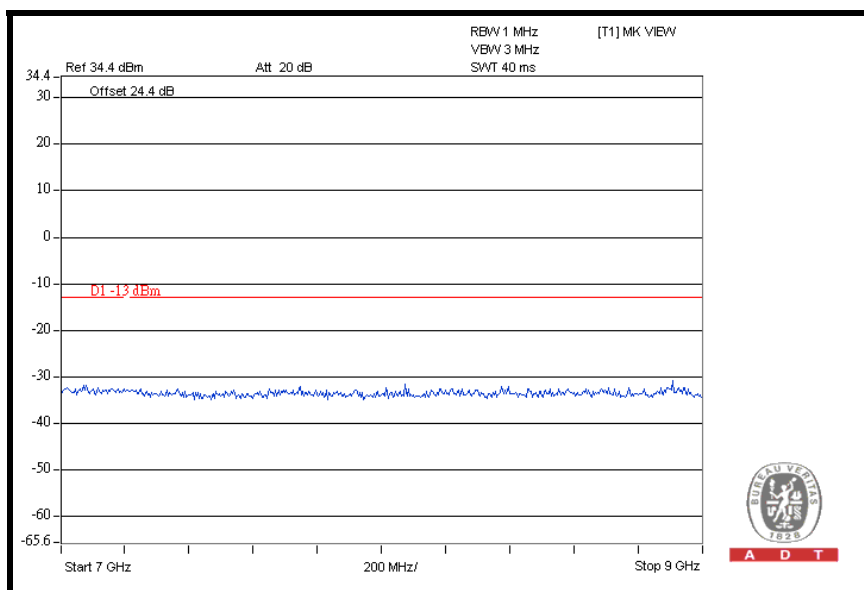

### CH 251: 9kHz ~ 1GHz

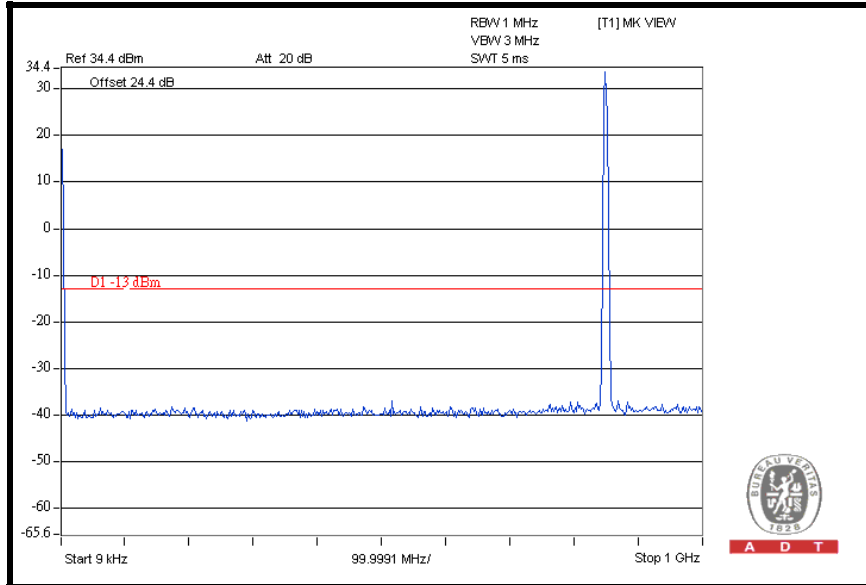

### 1GHz ~ 4GHz

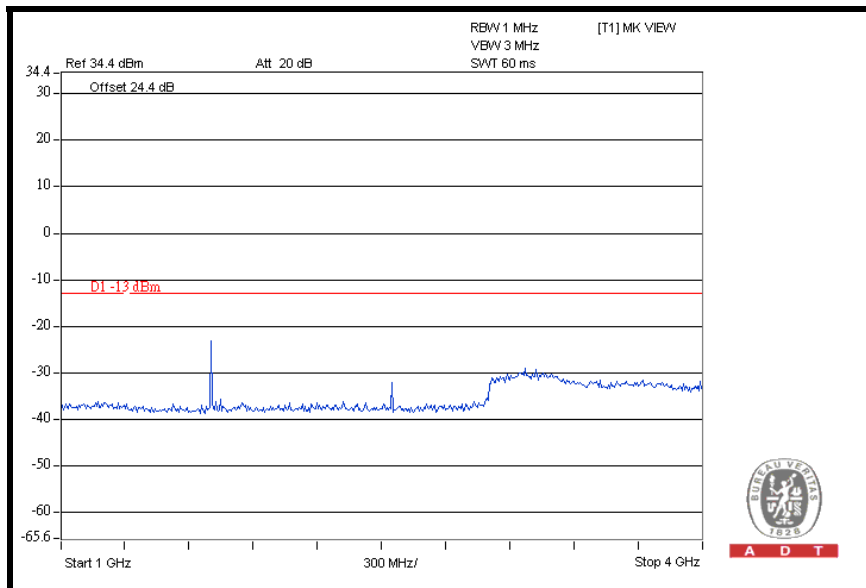

### 4GHz ~ 7GHz

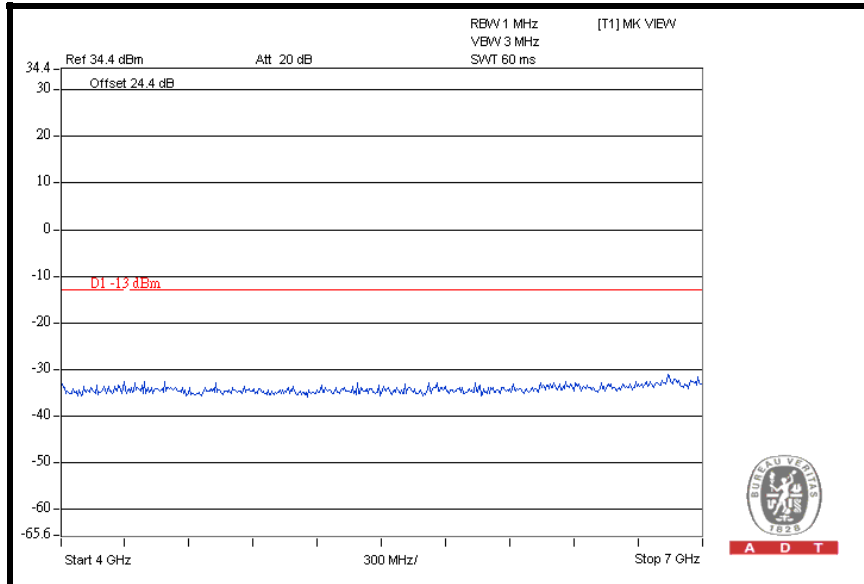

### 7GHz ~ 9GHz

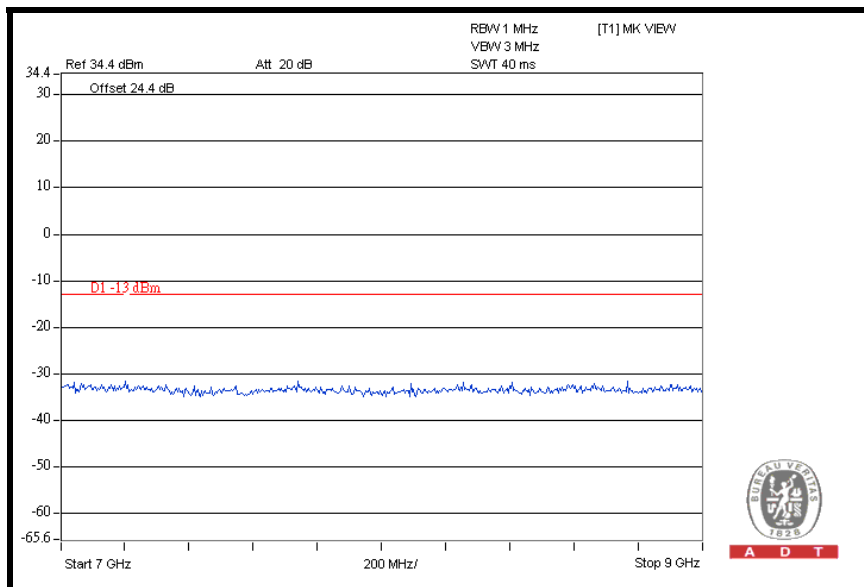

**FOR WCDMA-RMC:**

**CH 4132: 9kHz ~ 1GHz**

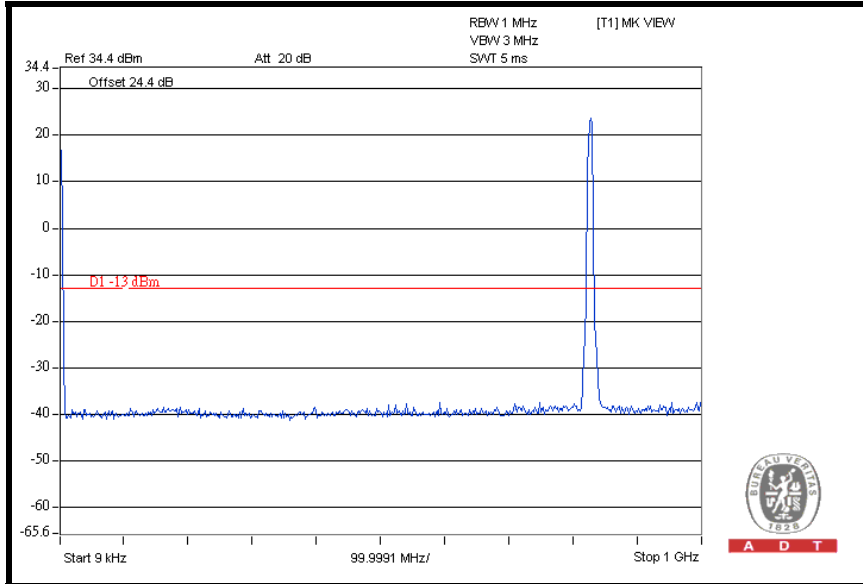

**1GHz ~ 4GHz**

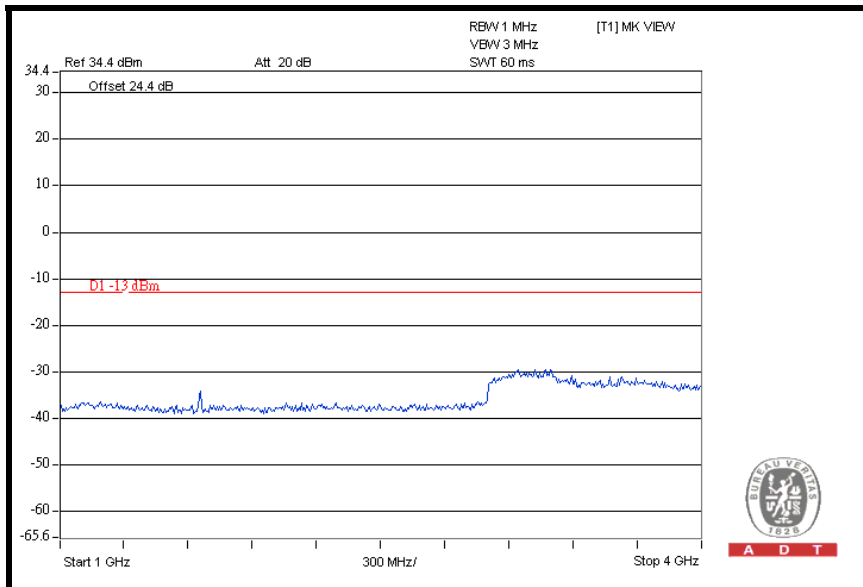

### 4GHz ~ 7GHz

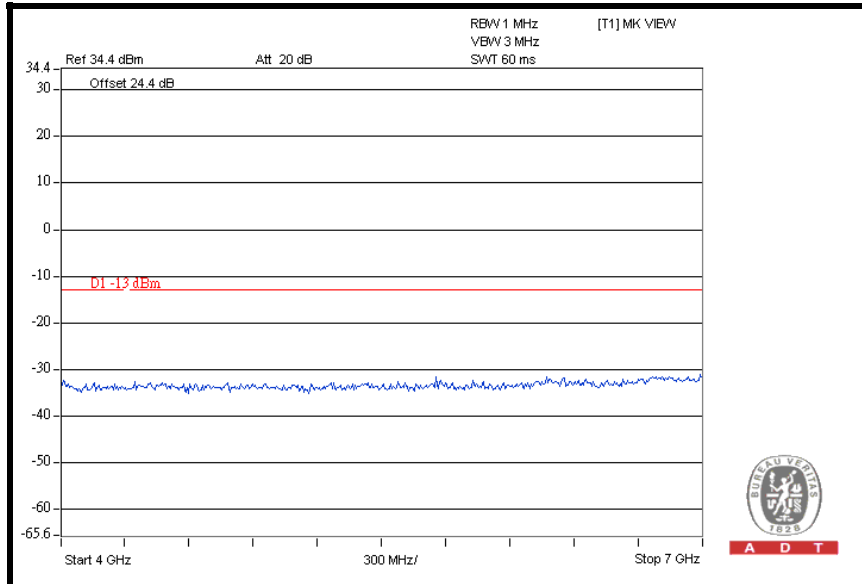

### 7GHz ~ 9GHz

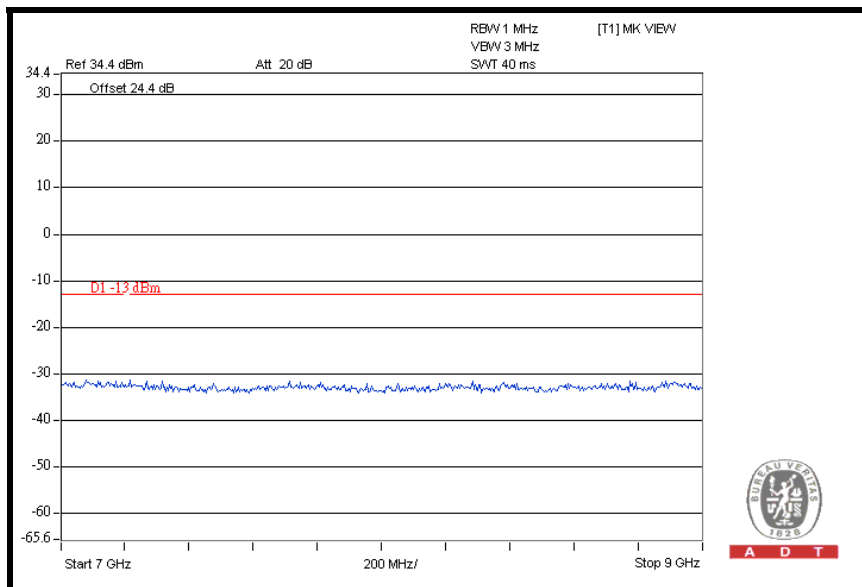

**CH 4182: 9kHz ~ 1GHz**

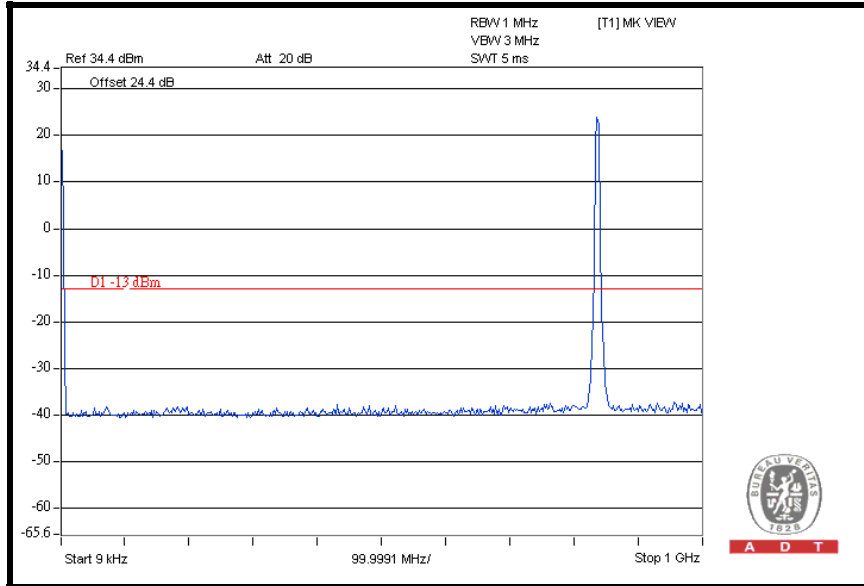

**1GHz ~ 4GHz**

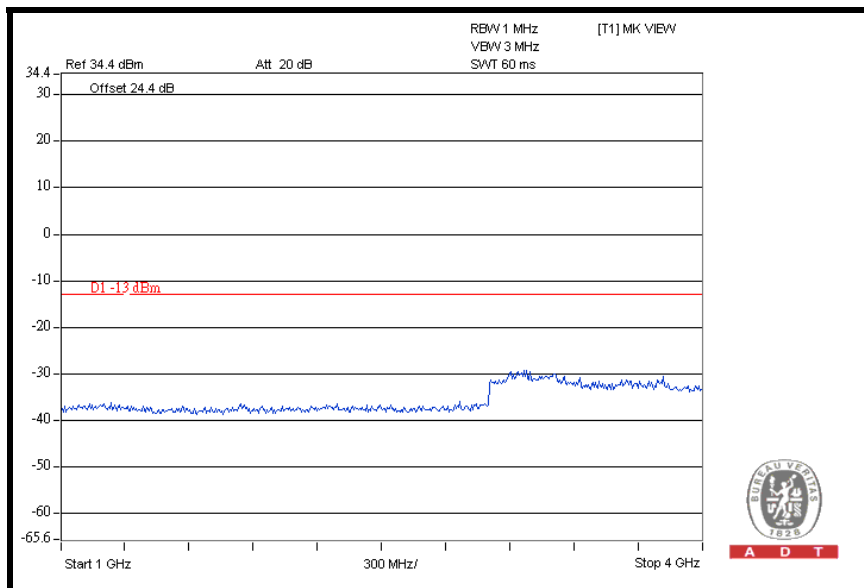

### 4GHz ~ 7GHz

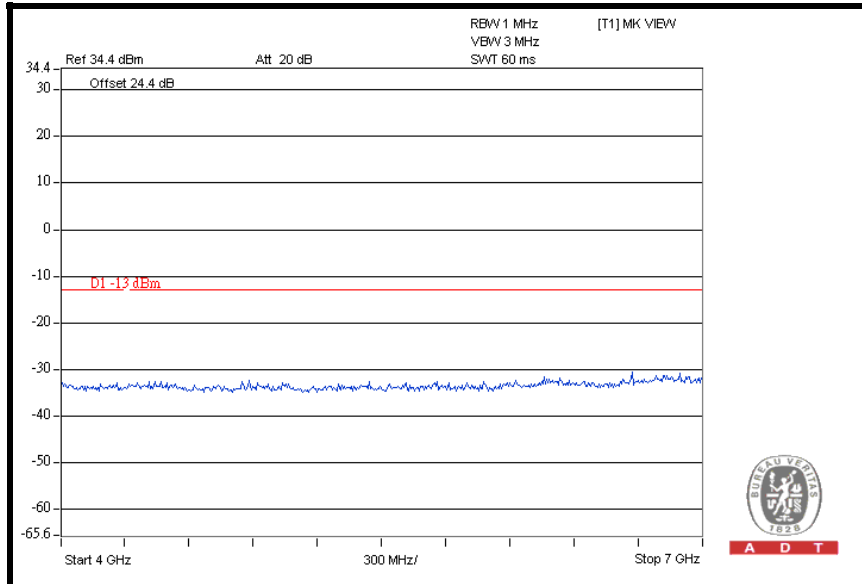

### 7GHz ~ 9GHz

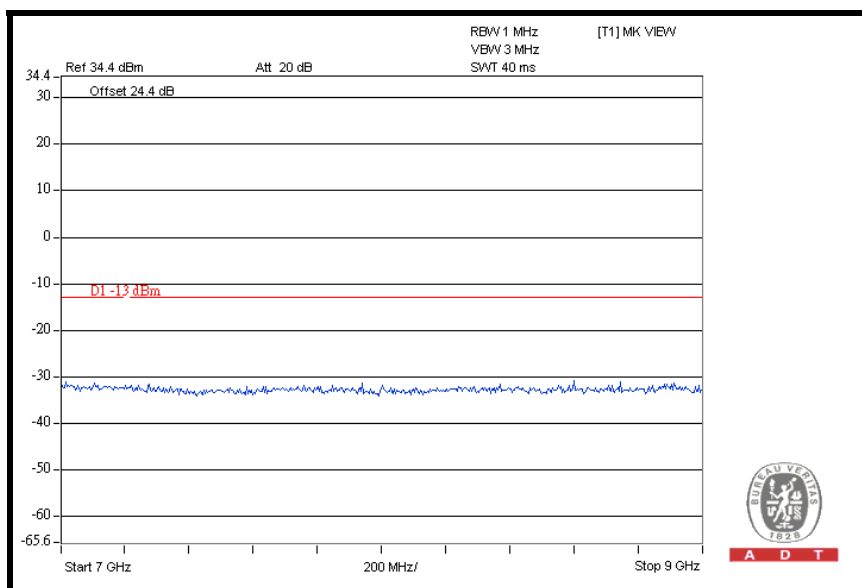

### CH 4233: 9kHz ~ 1GHz

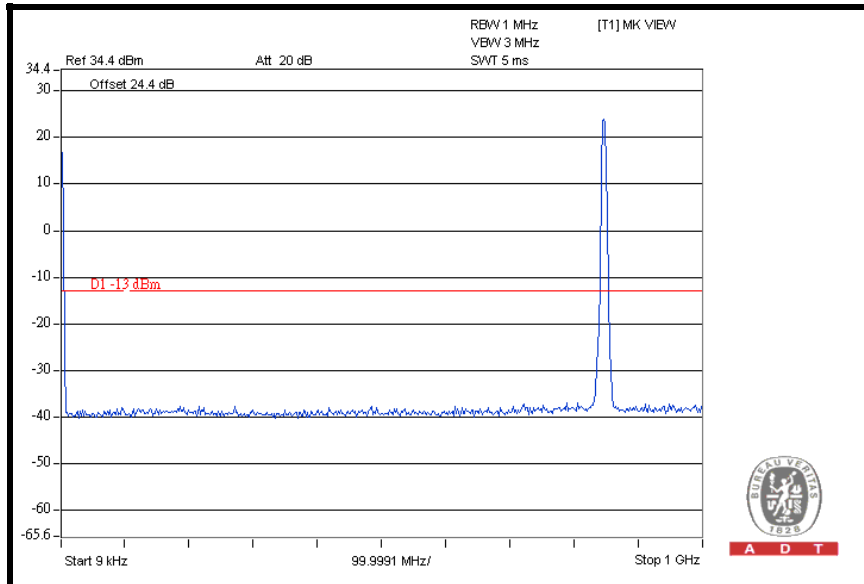

### 1GHz ~ 4GHz

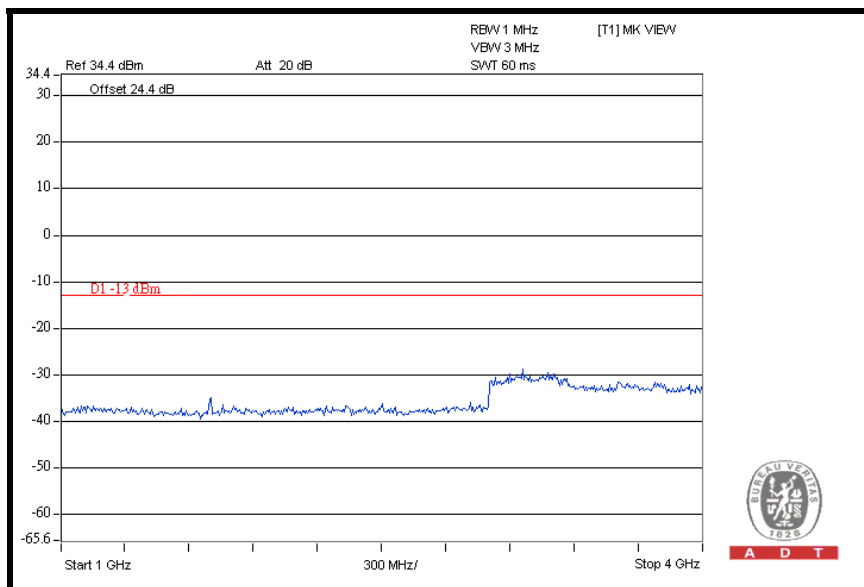



### 4GHz ~ 7GHz

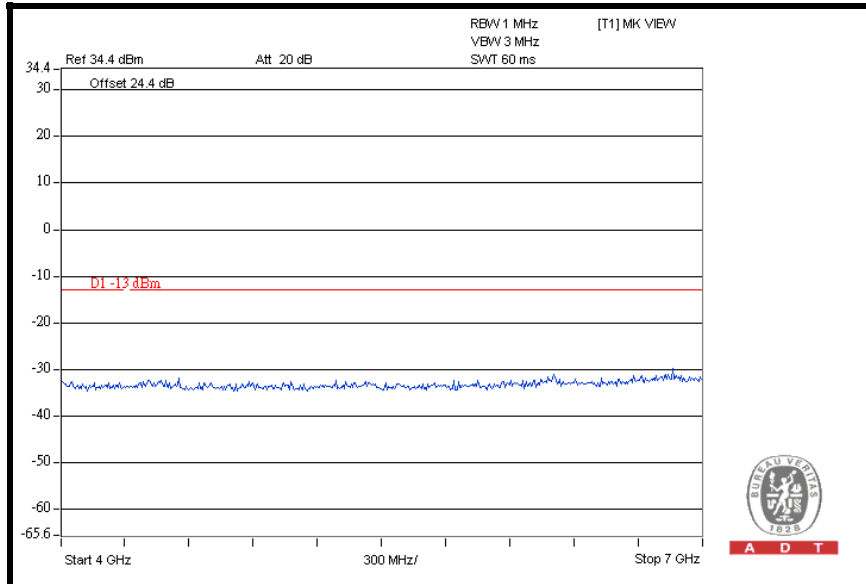

### 7GHz ~ 9GHz

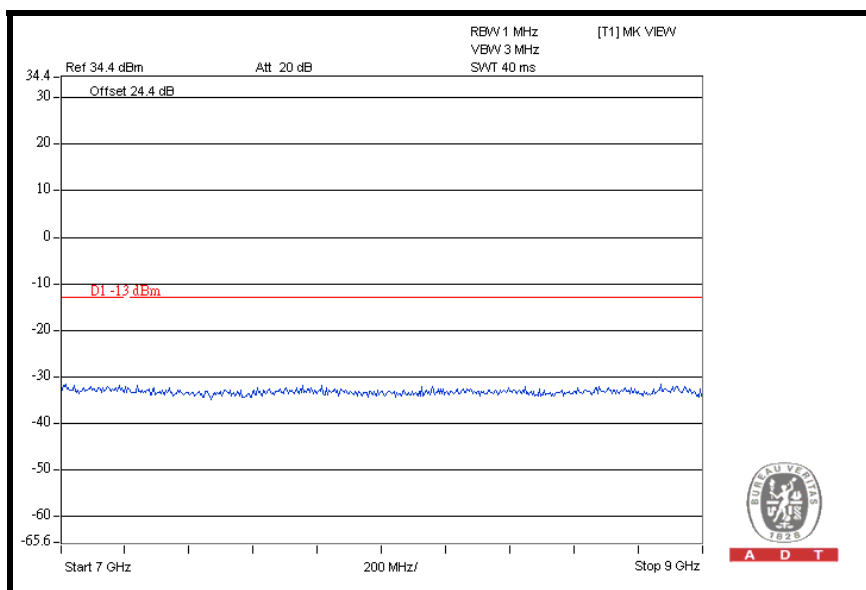



## **4.6 RADIATED EMISSION MEASUREMENT**

### **4.6.1 LIMITS OF RADIATED EMISSION MEASUREMENT**

In the FCC 22.917 (a), On any frequency outside a licensee's frequency block within USPCS spectrum, the power of any emission shall be attenuated below the transmitter power (P) by at least  $43 + 10 \log (P)$  dB. The emission limit equal to  $-13\text{dBm}$ .

### **4.6.2 TEST INSTRUMENTS**

Same as 4.1.2.

#### 4.6.3 TEST PROCEDURES

- a. Substitution method is used for E.I.R.P measurement. In the semi-anechoic chamber, EUT placed on the 0.8m height of Turn Table, rotated the table around 360 degrees to search the maximum radiation power and receiver antenna shall be rotated vertical and horizontal polarization and moved height from 1m to 4m to find the maximum polar radiated power. The “ Read Value ” is the spectrum reading the maximum power value.
- b. The substitution horn antenna is substituted for EUT at the same position and signals generator export the CW signal to the substitution antenna via a TX cable. Rotated the Turn Table and moved receiving antenna to find the maximum radiation power. Adjust output power level of S.G to get a Value of spectrum reading equal to “ Read Value “ of step a. Record the power level of S.G
- c. EIRP = Output power level of S.G – TX cable loss + Antenna gain of substitution horn.
- d. E.R.P power can be calculated form E.I.R.P power by subtracting the gain of dipole, E.R.P power = E.I.P.R power - 2.15dBi.

**NOTE:** The resolution bandwidth and video bandwidth of test receiver/spectrum analyzer is 1MHz/3MHz.

#### 4.6.4 DEVIATION FROM TEST STANDARD

No deviation

#### 4.6.5 TEST SETUP

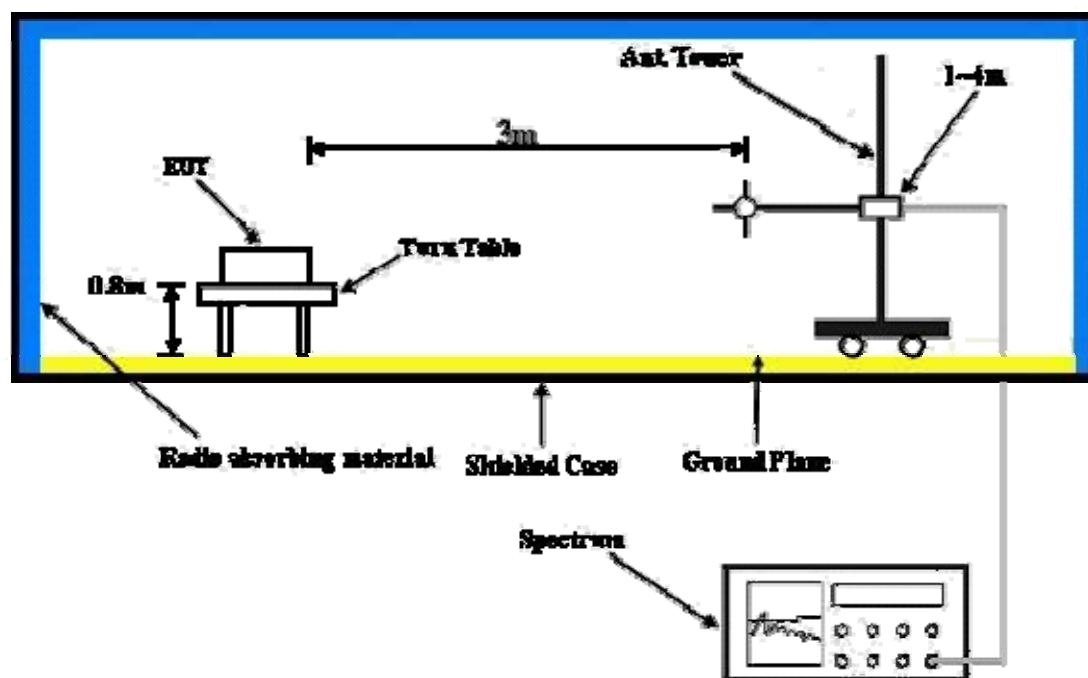

For the actual test configuration, please refer to the attached file (Test Setup Photo).

#### 4.6.6 EUT OPERATING CONDITIONS

- a. The EUT makes a call to the communication simulator.
- b. The communication simulator station system controlled a EUT to export maximum output power under transmission mode and specific channel frequency.



#### 4.6.7 TEST RESULTS

**Below 1GHz**

**FOR GSM:**

<b>MODE</b>	TX channel 190	<b>FREQUENCY RANGE</b>	Below 1000MHz
<b>ENVIRONMENTAL CONDITIONS</b>	26deg. C, 65%RH	<b>INPUT POWER</b>	120Vac, 60 Hz
<b>TEST MODE</b>	A	<b>TESTED BY</b>	Sam Chen

ANTENNA POLARITY & TEST DISTANCE: HORIZONTAL AT 3 M						
No.	Freq. (MHz)	Emission Level (dBUV)	Limit (dBm)	S.G Power Value (dBm)	Correction Factor (dB)	Power Value (dBm)
1	82.5	51.7	-13.0	-35.2	-7.7	-42.9
2	127.2	57.9	-13.0	-28.4	-7.7	-36.1
3	140.8	52.7	-13.0	-34.6	-7.7	-42.3
4	232.2	50.7	-13.0	-35.6	-7.7	-43.3
5	284.7	54.3	-13.0	-32.6	-7.7	-40.3
6	341.0	53.5	-13.0	-33.7	-7.8	-41.5
ANTENNA POLARITY & TEST DISTANCE: VERTICAL AT 3 M						
No.	Freq. (MHz)	Emission Level (dBUV)	Limit (dBm)	S.G Power Value (dBm)	Correction Factor (dB)	Power Value (dBm)
1	158.30	41.2	-13.0	-45.4	-7.7	-53.1
2	263.27	41.3	-13.0	-46.0	-7.7	-53.7
3	352.69	49.3	-13.0	-37.6	-7.8	-45.4
4	436.27	43.3	-13.0	-43.4	-7.8	-51.2
5	527.64	35.4	-13.0	-51.5	-7.8	-59.3
6	587.90	35.0	-13.0	-51.5	-7.8	-59.3

**REMARKS:** 1. Output Power (dBm) = S.G Value (dBm) + Correction Factor (dB).

2. Correction Factor (dB) = Substitution Antenna Gain (dB) + Cable Loss (dB).



<b>MODE</b>	TX channel 190	<b>FREQUENCY RANGE</b>	Below 1000MHz
<b>ENVIRONMENTAL CONDITIONS</b>	26deg. C, 65%RH	<b>INPUT POWER</b>	120Vac, 60 Hz
<b>TEST MODE</b>	B	<b>TESTED BY</b>	Sam Chen

<b>ANTENNA POLARITY &amp; TEST DISTANCE: HORIZONTAL AT 3 M</b>						
No.	Freq. (MHz)	Emission Level (dBUV)	Limit (dBm)	S.G Power Value (dBm)	Correction Factor (dB)	Power Value (dBm)
1	82.5	46.5	-13.0	-40.7	-7.7	-48.4
2	140.8	56.8	-13.0	-30.1	-7.7	-37.8
3	238.0	53.2	-13.0	-33.5	-7.7	-41.2
4	280.8	52.6	-13.0	-34.5	-7.7	-42.2
5	339.1	51.7	-13.0	-34.3	-7.8	-42.1
6	401.3	43.0	-13.0	-43.9	-7.8	-51.7
<b>ANTENNA POLARITY &amp; TEST DISTANCE: VERTICAL AT 3 M</b>						
No.	Freq. (MHz)	Emission Level (dBUV)	Limit (dBm)	S.G Power Value (dBm)	Correction Factor (dB)	Power Value (dBm)
1	45.6	47.1	-13.0	-39.6	-7.7	-47.3
2	88.3	42.6	-13.0	-44.5	-7.7	-52.2
3	138.9	48.0	-13.0	-39.2	-7.7	-46.9
4	304.1	46.1	-13.0	-40.6	-7.8	-48.4
5	368.2	45.3	-13.0	-41.2	-7.8	-49.0
6	609.3	36.8	-13.0	-50.1	-7.8	-57.9

**REMARKS:** 1. Output Power (dBm) = S.G Value (dBm) + Correction Factor (dB).  
 2. Correction Factor (dB) = Substitution Antenna Gain (dB) + Cable Loss (dB).

**FOR E-GPRS:**

<b>MODE</b>	TX channel 190	<b>FREQUENCY RANGE</b>	Below 1000MHz
<b>ENVIRONMENTAL CONDITIONS</b>	26deg. C, 65%RH	<b>INPUT POWER</b>	120Vac, 60 Hz
<b>TEST MODE</b>	A	<b>TESTED BY</b>	Sam Chen

<b>ANTENNA POLARITY &amp; TEST DISTANCE: HORIZONTAL AT 3 M</b>						
No.	Freq. (MHz)	Emission Level (dBUV)	Limit (dBm)	S.G Power Value (dBm)	Correction Factor (dB)	Power Value (dBm)
1	82.5	52.1	-13.0	-35.1	-7.7	-42.8
2	125.3	53.9	-13.0	-32.5	-7.7	-40.2
3	177.7	48.5	-13.0	-38.7	-7.7	-46.4
4	234.1	50.1	-13.0	-36.5	-7.7	-44.2
5	276.9	51.2	-13.0	-35.8	-7.7	-43.5
6	339.1	49.9	-13.0	-37.0	-7.8	-44.8
<b>ANTENNA POLARITY &amp; TEST DISTANCE: VERTICAL AT 3 M</b>						
No.	Freq. (MHz)	Emission Level (dBUV)	Limit (dBm)	S.G Power Value (dBm)	Correction Factor (dB)	Power Value (dBm)
1	82.5	48.9	-13.0	-37.8	-7.7	-45.5
2	135.0	49.7	-13.0	-37.1	-7.7	-44.8
3	181.6	45.8	-13.0	-41.1	-7.7	-48.8
4	296.3	46.6	-13.0	-40.2	-7.7	-47.9
5	337.1	51.3	-13.0	-35.1	-7.8	-42.9
6	543.2	36.9	-13.0	-50.0	-7.8	-57.8

**REMARKS:** 1. Output Power (dBm) = S.G Value (dBm) + Correction Factor (dB).  
 2. Correction Factor (dB) = Substitution Antenna Gain (dB) + Cable Loss (dB).



**FOR WCDMA-RMC:**

<b>MODE</b>	TX channel 4132	<b>FREQUENCY RANGE</b>	Below 1000MHz
<b>ENVIRONMENTAL CONDITIONS</b>	26deg. C, 65%RH	<b>INPUT POWER</b>	120Vac, 60 Hz
<b>TEST MODE</b>	A	<b>TESTED BY</b>	Sam Chen

<b>ANTENNA POLARITY &amp; TEST DISTANCE: HORIZONTAL AT 3 M</b>						
No.	Freq. (MHz)	Emission Level (dBuV)	Limit (dBm)	S.G Power Value (dBm)	Correction Factor (dB)	Power Value (dBm)
1	84.4	50.3	-13.0	-36.5	-7.7	-44.2
2	125.3	53.2	-13.0	-32.9	-7.7	-40.6
3	177.7	47.6	-13.0	-38.7	-7.7	-46.4
4	234.1	45.0	-13.0	-42.4	-7.7	-50.1
5	276.9	42.0	-13.0	-45.0	-7.7	-52.7
6	339.1	45.5	-13.0	-41.6	-7.8	-49.4
<b>ANTENNA POLARITY &amp; TEST DISTANCE: VERTICAL AT 3 M</b>						
No.	Freq. (MHz)	Emission Level (dBuV)	Limit (dBm)	S.G Power Value (dBm)	Correction Factor (dB)	Power Value (dBm)
1	41.66	42.2	-13.0	-44.8	-7.7	-52.5
2	82.48	46.4	-13.0	-40.4	-7.7	-48.1
3	133.03	50.1	-13.0	-36.9	-7.7	-44.6
4	179.68	44.5	-13.0	-42.3	-7.7	-50.0
5	218.56	42.0	-13.0	-45.3	-7.7	-53.0
6	339.08	48.6	-13.0	-38.2	-7.8	-46.0

**REMARKS:** 1. Output Power (dBm) = S.G Value (dBm) + Correction Factor (dB).

2. Correction Factor (dB) = Substitution Antenna Gain (dB) + Cable Loss (dB).



**Above 1GHz**  
**FOR GSM BAND:**

<b>MODE</b>	TX channel 190	<b>FREQUENCY RANGE</b>	Above 1000MHz
<b>ENVIRONMENTAL CONDITIONS</b>	26deg. C, 65%RH	<b>INPUT POWER</b>	120Vac, 60 Hz
<b>TEST MODE</b>	A	<b>TESTED BY</b>	Sam Chen

<b>ANTENNA POLARITY &amp; TEST DISTANCE: HORIZONTAL AT 3 M</b>						
No.	Freq. (MHz)	SPA READING (dBm)	Limit (dBm)	S.G Power Value (dBm)	Correction Factor (dB)	ERP (dBm)
1	1672.8	-43.0	-13.0	-47.5	7.7	-42.0
2	2509.2	-37.1	-13.0	-37.0	8.3	-30.9
3	3345.6	-59.0	-13.0	-58.6	9.9	-50.9
<b>ANTENNA POLARITY &amp; TEST DISTANCE: VERTICAL AT 3 M</b>						
No.	Freq. (MHz)	SPA READING (dBm)	Limit (dBm)	S.G Power Value (dBm)	Correction Factor (dB)	ERP (dBm)
1	1672.8	-39.6	-13.0	-45.0	7.7	-39.5
2	2509.2	-45.4	-13.0	-44.5	8.3	-38.4
3	3345.6	-57.0	-13.0	-56.4	9.9	-48.7

- NOTE:** 1. ERP(dBm) = S.G Power Value (dBm) + Correction Factor (dB).  
2. Correction Factor = gain of substitution antenna + cable loss



<b>MODE</b>	TX channel 190	<b>FREQUENCY RANGE</b>	Above 1000MHz
<b>ENVIRONMENTAL CONDITIONS</b>	26deg. C, 65%RH	<b>INPUT POWER</b>	120Vac, 60 Hz
<b>TEST MODE</b>	B	<b>TESTED BY</b>	Sam Chen

<b>ANTENNA POLARITY &amp; TEST DISTANCE: HORIZONTAL AT 3 M</b>						
No.	Freq. (MHz)	SPA READING (dBm)	Limit (dBm)	S.G Power Value (dBm)	Correction Factor (dB)	ERP (dBm)
1	1672.8	-47.7	-13.0	-52.2	7.7	-46.7
2	2509.2	-37.2	-13.0	-37.1	8.3	-31.0
3	3345.6	-55.2	-13.0	-54.8	9.9	-47.0
<b>ANTENNA POLARITY &amp; TEST DISTANCE: VERTICAL AT 3 M</b>						
No.	Freq. (MHz)	SPA READING (dBm)	Limit (dBm)	S.G Power Value (dBm)	Correction Factor (dB)	ERP (dBm)
1	1672.8	-44.8	-13.0	-50.2	7.7	-44.6
2	2509.2	-43.8	-13.0	-42.9	8.3	-36.8
3	3345.6	-59.1	-13.0	-58.5	9.9	-50.8
4	4182.0	-58.9	-13.0	-55.2	9.7	-47.6

- NOTE:** 1. ERP(dBm) = S.G Power Value (dBm) + Correction Factor (dB).  
 2. Correction Factor = gain of substitution antenna + cable loss



**FOR E-GPRS:**

<b>MODE</b>	TX channel 190	<b>FREQUENCY RANGE</b>	Below 1000MHz
<b>ENVIRONMENTAL CONDITIONS</b>	26deg. C, 65%RH	<b>INPUT POWER</b>	120Vac, 60 Hz
<b>TEST MODE</b>	A	<b>TESTED BY</b>	Sam Chen

<b>ANTENNA POLARITY &amp; TEST DISTANCE: HORIZONTAL AT 3 M</b>						
No.	Freq. (MHz)	SPA READING (dBm)	Limit (dBm)	S.G Power Value (dBm)	Correction Factor (dB)	ERP (dBm)
1	1672.8	-42.4	-13.0	-46.9	7.7	-41.4
2	2509.2	-43.4	-13.0	-43.3	8.3	-37.2
3	3345.6	-60.4	-13.0	-60.0	9.9	-52.3
<b>ANTENNA POLARITY &amp; TEST DISTANCE: VERTICAL AT 3 M</b>						
No.	Freq. (MHz)	SPA READING (dBm)	Limit (dBm)	S.G Power Value (dBm)	Correction Factor (dB)	ERP (dBm)
1	1672.8	-41.1	-13.0	-46.5	7.7	-41.0
2	2509.2	-50.3	-13.0	-49.4	8.3	-43.3
3	3345.6	-55.9	-13.0	-55.3	9.9	-47.6

**NOTE:** 1. ERP(dBm) = S.G Power Value (dBm) + Correction Factor (dB).

2. Correction Factor = gain of substitution antenna + cable loss



**FOR WCDMA BAND:**

<b>MODE</b>	TX channel 4182	<b>FREQUENCY RANGE</b>	Above 1000MHz
<b>ENVIRONMENTAL CONDITIONS</b>	26deg. C, 65%RH	<b>INPUT POWER</b>	120Vac, 60 Hz
<b>TEST MODE</b>	A	<b>TESTED BY</b>	Sam Chen

<b>ANTENNA POLARITY &amp; TEST DISTANCE: HORIZONTAL AT 3 M</b>						
No.	Freq. (MHz)	SPA READING (dBm)	Limit (dBm)	S.G Power Value (dBm)	Correction Factor (dB)	ERP (dBm)
1	1672.8	-48.3	-13.0	-52.8	7.7	-47.2
2	2509.2	-58.4	-13.0	-58.3	8.3	-52.1
3	3345.6	-61.5	-13.0	-61.1	9.9	-53.3
4	4182.0	-62.1	-13.0	-58.2	9.7	-50.6
<b>ANTENNA POLARITY &amp; TEST DISTANCE: VERTICAL AT 3 M</b>						
No.	Freq. (MHz)	SPA READING (dBm)	Limit (dBm)	S.G Power Value (dBm)	Correction Factor (dB)	ERP (dBm)
1	1672.8	-45.7	-13.0	-51.1	7.7	-45.5
2	2509.2	-60.5	-13.0	-59.6	8.3	-53.4
3	3345.6	-60.9	-13.0	-60.3	9.9	-52.5

- NOTE:** 1. ERP(dBm) = S.G Power Value (dBm) + Correction Factor (dB).  
 2. Correction Factor = gain of substitution antenna + cable loss



## 5 PHOTOGRAPHS OF THE TEST CONFIGURATION

Please refer to the attached file (Test Setup Photo).



## 6 INFORMATION ON THE TESTING LABORATORIES

We, Bureau Veritas Consumer Products Services (H.K.) Ltd., Taoyuan Branch, were founded in 1988 to provide our best service in EMC, Radio, Telecom and Safety consultation. Our laboratories are accredited and approved according to ISO/IEC 17025.

Copies of accreditation and authorization certificates of our laboratories obtained from approval agencies can be downloaded from our web site:

[www.adt.com.tw/index.5.phtml](http://www.adt.com.tw/index.5.phtml). If you have any comments, please feel free to contact us at the following:

**Linko EMC/RF Lab:**

Tel: 886-2-26052180

Fax: 886-2-26051924

**Hsin Chu EMC/RF Lab:**

Tel: 886-3-5935343

Fax: 886-3-5935342

**Hwa Ya EMC/RF/Safety/Telecom Lab:**

Tel: 886-3-3183232

Fax: 886-3-3185050

**Email:** [service.adt@tw.bureauveritas.com](mailto:service.adt@tw.bureauveritas.com)

**Web Site:** [www.adt.com.tw](http://www.adt.com.tw)

The address and road map of all our labs can be found in our web site also.



## **7 APPENDIX A – MODIFICATIONS RECORDERS FOR ENGINEERING CHANGES TO THE EUT BY THE LAB**

No any modifications are made to the EUT by the lab during the test.

**---END---**