



FCC TEST REPORT (15.247)

REPORT NO.: RF110805C09

MODEL NO.: PI86100

FCC ID: NM8PI86100

RECEIVED: Aug. 05, 2011

TESTED: Sep. 24 ~ Oct. 05, 2011

ISSUED: Oct. 07, 2011

APPLICANT: HTC Corporation

ADDRESS: 23, Xinghua Rd., Taoyuan 330, Taiwan, R.O.C.

ISSUED BY: Bureau Veritas Consumer Products Services
(H.K.) Ltd., Taoyuan Branch

LAB ADDRESS: No. 47, 14th Ling, Chia Pau Vil., Lin Kou Dist.,
New Taipei City, Taiwan (R.O.C)

TEST LOCATION: No. 19, Hwa Ya 2nd Rd, Wen Hwa Tsuen, Kwei
Shan Hsiang, Taoyuan Hsien 333, Taiwan, R.O.C.

This test report consists of 73 pages in total. It may be duplicated completely for legal use with the approval of the applicant. It should not be reproduced except in full, without the written approval of our laboratory. The client should not use it to claim product certification, approval, or endorsement by TAF or any government agency. The test results in the report only apply to the tested sample.





A D T

TABLE OF CONTENTS

RELEASE CONTROL RECORD	4
1. CERTIFICATION	5
2. SUMMARY OF TEST RESULTS	6
2.1 MEASUREMENT UNCERTAINTY	6
3. GENERAL INFORMATION	7
3.1 GENERAL DESCRIPTION OF EUT	7
3.2 DESCRIPTION OF TEST MODES	8
3.2.1 CONFIGURATION OF SYSTEM UNDER TEST	8
3.2.2 TEST MODE APPLICABILITY AND TESTED CHANNEL DETAIL	9
3.3 GENERAL DESCRIPTION OF APPLIED STANDARDS	11
3.4 DESCRIPTION OF SUPPORT UNITS	11
4. TEST TYPES AND RESULTS	12
4.1 RADIATED EMISSION MEASUREMENT	12
4.1.1 LIMITS OF RADIATED EMISSION MEASUREMENT	12
4.1.2 TEST INSTRUMENTS	13
4.1.3 TEST PROCEDURES	14
4.1.4 DEVIATION FROM TEST STANDARD	14
4.1.5 TEST SETUP	15
4.1.6 EUT OPERATING CONDITIONS	15
4.1.7 TEST RESULT	16
4.2 CONDUCTED EMISSION MEASUREMENT	36
4.2.1 LIMITS OF CONDUCTED EMISSION MEASUREMENT	36
4.2.2 TEST INSTRUMENTS	36
4.2.3 TEST PROCEDURES	37
4.2.4 DEVIATION FROM TEST STANDARD	37
4.2.5 TEST SETUP	38
4.2.6 EUT OPERATING CONDITIONS	38
4.2.7 TEST RESULTS	39
4.3 6dB BANDWIDTH MEASUREMENT	45
4.3.1 LIMITS OF 6dB BANDWIDTH MEASUREMENT	45
4.3.2 TEST INSTRUMENTS	45
4.3.3 TEST PROCEDURE	45
4.3.4 DEVIATION FROM TEST STANDARD	45
4.3.5 TEST SETUP	46
4.3.6 EUT OPERATING CONDITIONS	46
4.3.7 TEST RESULTS	47
4.4 MAXIMUM OUTPUT POWER	50
4.4.1 LIMITS OF MAXIMUM OUTPUT POWER MEASUREMENT	50
4.4.2 INSTRUMENTS	50
4.4.3 TEST PROCEDURE	50
4.4.4 DEVIATION FROM TEST STANDARD	51
4.4.5 TEST SETUP	51
4.4.6 EUT OPERATING CONDITIONS	51
4.4.7 TEST RESULTS	52
4.5 POWER SPECTRAL DENSITY MEASUREMENT	53
4.5.1 LIMITS OF POWER SPECTRAL DENSITY MEASUREMENT	53
4.5.2 TEST INSTRUMENTS	53
4.5.3 TEST PROCEDURE	53



A D T

4.5.4	DEVIATION FROM TEST STANDARD	54
4.5.5	TEST SETUP	54
4.5.6	EUT OPERATING CONDITION	54
4.5.7	TEST RESULTS	55
4.6	BAND EDGES MEASUREMENT	58
4.6.1	LIMITS OF BAND EDGES MEASUREMENT	58
4.6.2	TEST INSTRUMENTS	58
4.6.3	TEST PROCEDURE	58
4.6.4	DEVIATION FROM TEST STANDARD	58
4.6.5	EUT OPERATING CONDITION	58
4.6.6	TEST RESULTS	59
5.	PHOTOGRAPHS OF THE TEST CONFIGURATION	71
6.	INFORMATION ON THE TESTING LABORATORIES	72
7.	APPENDIX A - MODIFICATIONS RECORDERS FOR ENGINEERING CHANGES TO THE EUT BY THE LAB	73



RELEASE CONTROL RECORD

ISSUE NO.	REASON FOR CHANGE	DATE ISSUED
Original release	N/A	Oct. 07, 2011



A D T

1. CERTIFICATION

PRODUCT: Windows Phone

MODEL: PI86100

BRAND: HTC

APPLICANT: HTC Corporation

TEST SAMPLE: Production Unit

TESTED: Sep. 24 ~ Oct. 05, 2011

STANDARDS: **FCC Part 15, Subpart C (Section 15.247)**

ANSI C63.4-2003

ANSI C63.10-2009

The above equipment (Model: PI86100) has been tested by **Bureau Veritas Consumer Products Services (H.K.) Ltd., Taoyuan Branch**, and found compliance with the requirement of the above standards. The test record, data evaluation & Equipment Under Test (EUT) configurations represented herein are true and accurate accounts of the measurements of the sample's EMC characteristics under the conditions specified in this report.

PREPARED BY : Andrea Hsia , DATE : Oct. 07, 2011
Andrea Hsia / Specialist

APPROVED BY : Gary Chang , DATE : Oct. 07, 2011
Gary Chang / Technical Manager

2. SUMMARY OF TEST RESULTS

The EUT has been tested according to the following specifications:

APPLIED STANDARD: FCC PART 15, SUBPART C (SECTION 15.247)			
STANDARD SECTION	TEST TYPE AND LIMIT	RESULT	REMARK
15.207	AC Power Conducted Emission	PASS	Meet the requirement of limit. Minimum passing margin is -3.25dB at 0.248MHz.
15.247(a)(2)	Spectrum Bandwidth of a Direct Sequence Spread Spectrum System Limit: min. 500kHz	PASS	Meet the requirement of limit.
15.247(b)	Maximum Output Power Limit: max. 30dBm	PASS	Meet the requirement of limit.
15.247(d)	Radiated Emissions Limit: Table 15.209	PASS	Meet the requirement of limit. Minimum passing margin is -1.0dB at 4824.00MHz.
15.247(e)	Power Spectral Density Limit: max. 8dBm	PASS	Meet the requirement of limit.
15.247(d)	Band Edge Measurement Limit: 20dB less than the peak value of fundamental frequency	PASS	Meet the requirement of limit.
15.203	Antenna Requirement	PASS	No antenna connector is used.

2.1 MEASUREMENT UNCERTAINTY

Where relevant, the following measurement uncertainty levels have been estimated for tests performed on the EUT as specified in CISPR 16-4-2:

MEASUREMENT	FREQUENCY	UNCERTAINTY
Conducted emissions	9kHz~30MHz	2.44 dB
Radiated emissions	30MHz ~ 200MHz	3.34 dB
	200MHz ~1000MHz	3.35 dB
	1GHz ~ 18GHz	2.26 dB
	18GHz ~ 40GHz	1.94 dB

This uncertainty represents an expanded uncertainty expressed at approximately the 95% confidence level using a coverage factor of $k = 2$.



3. GENERAL INFORMATION

3.1 GENERAL DESCRIPTION OF EUT

EUT	Windows Phone
MODEL NO.	PI86100
FCC ID	NM8PI86100
POWER SUPPLY	5.0Vdc (adapter or host equipment) 3.8Vdc (battery)
MODULATION TYPE	CCK, DQPSK, DBPSK for DSSS 64QAM, 16QAM, QPSK, BPSK for OFDM
MODULATION TECHNOLOGY	DSSS, OFDM
TRANSFER RATE	802.11b: 11.0/ 5.5/ 2.0/ 1.0Mbps 802.11g: 54.0/ 48.0/ 36.0/ 24.0/ 18.0/ 12.0/ 9.0/ 6.0Mbps 802.11n (20MHz): up to 150.0Mbps
OPERATING FREQUENCY	2412 ~ 2462MHz
NUMBER OF CHANNEL	11
OUTPUT POWER	154.9mW
ANTENNA TYPE	PIFA antenna with -5dBi gain
ANTENNA CONNECTOR	NA
I/O PORTS	Refer to users' manual
DATA CABLE	Refer to Note as below
ACCESSORY DEVICES	Refer to Note as below

NOTE:

1. The EUT provides one completed transmitter and one receiver.

MODULATION MODE	TX FUNCTION
802.11b	1TX
802.11g	1TX
802.11n (20MHz)	1TX

2. The EUT's accessories list refers to Ext Pho_NM8PI86100.pdf.
*Main sample & 2nd sample + item 2, 3, 6 were for the final test.
3. The above EUT information is declared by manufacturer and for more detailed features description, please refer to the manufacturer's specifications or user's manual.

3.2 DESCRIPTION OF TEST MODES

11 channels are provided for 802.11b, 802.11g and 802.11n (20MHz):

CHANNEL	FREQUENCY	CHANNEL	FREQUENCY
1	2412MHz	7	2442MHz
2	2417MHz	8	2447MHz
3	2422MHz	9	2452MHz
4	2427MHz	10	2457MHz
5	2432MHz	11	2462MHz
6	2437MHz		

3.2.1 CONFIGURATION OF SYSTEM UNDER TEST

FOR RADIATION TEST

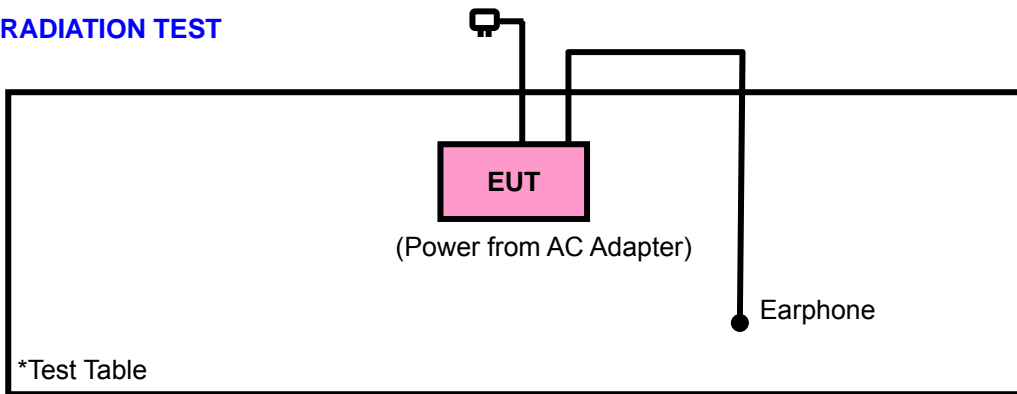

FOR CONDUCTION TEST

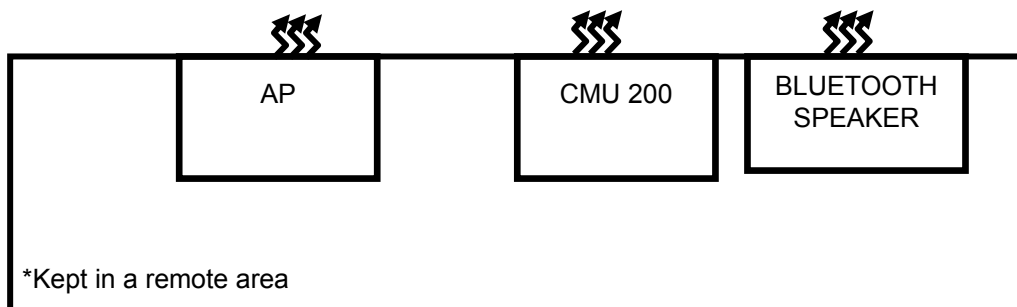
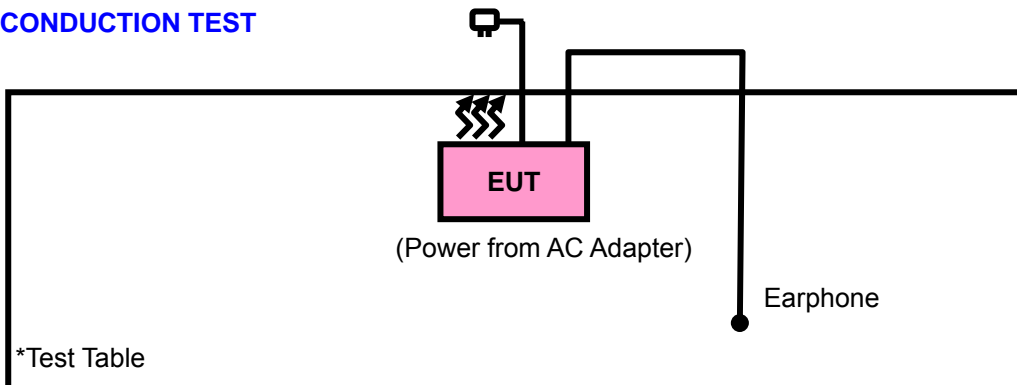



3.2.2 TEST MODE APPLICABILITY AND TESTED CHANNEL DETAIL

EUT CONFIGURE MODE	APPLICABLE TO				DESCRIPTION
	RE≥1G	RE<1G	PLC	APCM	
A	√	√	√	√	Main sample + Power from adapter 2
B	-	-	√	-	Main sample + Power from adapter 1
C	√	√	√	-	2nd sample + Power from adapter 2

Where **RE≥1G**: Radiated Emission above 1GHz **RE<1G**: Radiated Emission below 1GHz
PLC: Power Line Conducted Emission **APCM**: Antenna Port Conducted Measurement

NOTE: “-”: Means no effect.

RADIATED EMISSION TEST (ABOVE 1GHz):

- Pre-Scan has been conducted to determine the worst-case mode from all possible combinations between available modulations, XYZ axis and antenna ports (if EUT with antenna diversity architecture).
- Following channel(s) was (were) selected for the final test as listed below.

EUT CONFIGURE MODE	MODE	AVAILABLE CHANNEL	TESTED CHANNEL	MODULATION TECHNOLOGY	MODULATION TYPE	DATA RATE (Mbps)	AXIS
A	802.11b	1 to 11	1, 6, 11	DSSS	DBPSK	1.0	Y
A	802.11g	1 to 11	1, 6, 11	OFDM	BPSK	6.0	Y
A	802.11n (20MHz)	1 to 11	1, 6, 11	OFDM	BPSK	6.5	Y
C	802.11b	1 to 11	1	DSSS	DBPSK	1.0	Y

RADIATED EMISSION TEST (BELOW 1GHz):

- Pre-Scan has been conducted to determine the worst-case mode from all possible combinations between available modulations, XYZ axis and antenna ports (if EUT with antenna diversity architecture).
- Following channel(s) was (were) selected for the final test as listed below.

EUT CONFIGURE MODE	MODE	AVAILABLE CHANNEL	TESTED CHANNEL	MODULATION TECHNOLOGY	MODULATION TYPE	DATA RATE (Mbps)	AXIS
A	802.11b	1 to 11	1, 6, 11	DSSS	DBPSK	1.0	Y
A	802.11g	1 to 11	1, 6, 11	OFDM	BPSK	6.0	Y
A	802.11n (20MHz)	1 to 11	1, 6, 11	OFDM	BPSK	6.5	Y
C	802.11b	1 to 11	1	DSSS	DBPSK	1.0	Y



POWER LINE CONDUCTED EMISSION TEST:

- Pre-Scan has been conducted to determine the worst-case mode from all possible combinations between available modulations, data rates and antenna ports (if EUT with antenna diversity architecture).
- Following channel(s) was (were) selected for the final test as listed below.

EUT CONFIGURE MODE	MODE	AVAILABLE CHANNEL	TESTED CHANNEL	MODULATION TECHNOLOGY	MODULATION TYPE	DATA RATE (Mbps)
A, B & C	802.11b	1 to 11	1	DSSS	DBPSK	1.0

BANDEDGE MEASUREMENT:

- Pre-Scan has been conducted to determine the worst-case mode from all possible combinations between available modulations, data rates and antenna ports (if EUT with antenna diversity architecture).
- Following channel(s) was (were) selected for the final test as listed below.

EUT CONFIGURE MODE	MODE	AVAILABLE CHANNEL	TESTED CHANNEL	MODULATION TECHNOLOGY	MODULATION TYPE	DATA RATE (Mbps)
A	802.11b	1 to 11	1, 11	DSSS	DBPSK	1.0
A	802.11g	1 to 11	1, 11	OFDM	BPSK	6.0
A	802.11n (20MHz)	1 to 11	1, 11	OFDM	BPSK	6.5

ANTENNA PORT CONDUCTED MEASUREMENT:

- This item includes all test value of each mode, but only includes spectrum plot of worst value of each mode.
- Pre-Scan has been conducted to determine the worst-case mode from all possible combinations between available modulations, data rates and antenna ports (if EUT with antenna diversity architecture).
- Following channel(s) was (were) selected for the final test as listed below.

EUT CONFIGURE MODE	MODE	AVAILABLE CHANNEL	TESTED CHANNEL	MODULATION TECHNOLOGY	MODULATION TYPE	DATA RATE (Mbps)
A	802.11b	1 to 11	1, 6, 11	DSSS	DBPSK	1.0
A	802.11g	1 to 11	1, 6, 11	OFDM	BPSK	6.0
A	802.11n (20MHz)	1 to 11	1, 6, 11	OFDM	BPSK	6.5

TEST CONDITION:

APPLICABLE TO	ENVIRONMENTAL CONDITIONS	INPUT POWER	TESTED BY
RE≥1G	25deg. C, 65%RH	120Vac, 60Hz	Kay Wu
RE<1G	25deg. C, 65%RH	120Vac, 60Hz	Kay Wu
PLC	25deg. C, 65%RH	120Vac, 60Hz	Kay Wu
APCM	25deg. C, 68%RH	120Vac, 60Hz	Kay Wu



3.3 GENERAL DESCRIPTION OF APPLIED STANDARDS

The EUT is a RF Product. According to the specifications of the manufacturer, it must comply with the requirements of the following standards:

FCC Part 15, Subpart C (15.247)

ANSI C63.4-2003

ANSI C63.10-2009

All test items have been performed and recorded as per the above standards.

NOTE: The EUT is also considered as a kind of computer peripheral, because the connection to computer is necessary for typical use. It has been verified to comply with the requirements of FCC Part 15, Subpart B, Class B (DoC). The test report has been issued separately.

3.4 DESCRIPTION OF SUPPORT UNITS

The EUT has been tested as an independent unit together with other necessary accessories or support units. The following support units or accessories were used to form a representative test configuration during the tests.

NO.	PRODUCT	BRAND	MODEL NO.	SERIAL NO.	FCC ID
1	WIRELESS AP	BUFFALO	WBR2-G54	34059544811631	FDI-04600142-0
2	UNIVERSAL RADIO COMMUNICATION TESTER	R&S	CMU 200	101095	NA
3	BLUETOOTH SPEAKER	Hon Yuan	Ms-01B	AMB 08041000	NA
4	EARPHONE	HTC	HS G400	NA	NA

NO.	SIGNAL CABLE DESCRIPTION OF THE ABOVE SUPPORT UNITS
1	NA
2	NA
3	NA
4	1.2m non-shielded cable without core

NOTE:

1. All power cords of the above support units are non-shielded (1.8m).
2. Items 1-3 acted as communication partners to transfer data.
3. Item 4 was supplied from client.

4. TEST TYPES AND RESULTS

4.1 RADIATED EMISSION MEASUREMENT

4.1.1 LIMITS OF RADIATED EMISSION MEASUREMENT

Radiated emissions which fall in the restricted bands, as defined in Section 15.205(a), must also comply with the radiated emission limits specified in Section 15.209(a). Other emissions shall be at least 20dB below the highest level of the desired power.

FREQUENCIES (MHz)	FIELD STRENGTH (microvolts/meter)	MEASUREMENT DISTANCE (meters)
0.009 ~ 0.490	2400/F(kHz)	300
0.490 ~ 1.705	24000/F(kHz)	30
1.705 ~ 30.0	30	30
30 ~ 88	100	3
88 ~ 216	150	3
216 ~ 960	200	3
Above 960	500	3

NOTE:

1. The lower limit shall apply at the transition frequencies.
2. Emission level (dBuV/m) = 20 log Emission level (uV/m).
3. As shown in 15.35(b), for frequencies above 1000MHz, the field strength limits are based on average detector, however, the peak field strength of any emission shall not exceed the maximum permitted average limits, specified above by more than 20dB under any condition of modulation.



4.1.2 TEST INSTRUMENTS

DESCRIPTION & MANUFACTURER	MODEL NO.	SERIAL NO.	DATE OF CALIBRATION	DUE DATE OF CALIBRATION
Test Receiver ROHDE & SCHWARZ	ESIB7	100212	Aug. 02, 2011	Aug. 01, 2012
Spectrum Analyzer ROHDE & SCHWARZ	FSP 40	100041	Jul. 21, 2011	Jul. 20, 2012
BILOG Antenna SCHWARZBECK	VULB9168	9168-160	Apr. 13, 2011	Apr. 12, 2012
HORN Antenna SCHWARZBECK	9120D	209	Aug. 25, 2011	Aug. 24, 2012
HORN Antenna SCHWARZBECK	BBHA 9170	BBHA9170243	Dec. 27, 2010	Dec. 26, 2011
Preamplifier Agilent	8447D	2944A10633	Nov. 02, 2010	Nov. 01, 2011
Preamplifier Agilent	8449B	3008A01964	Nov. 02, 2010	Nov. 01, 2011
RF signal cable HUBER+SUHNNER	SUCOFLEX 104	295014/4	Aug. 19, 2011	Aug. 18, 2012
RF signal cable HUBER+SUHNNER	SUCOFLEX 104	12738/6	Aug. 19, 2011	Aug. 18, 2012
Software ADT.	ADT_Radiated_ V7.6.15.9.2	NA	NA	NA
Antenna Tower inn-co GmbH	MA 4000	013303	NA	NA
Antenna Tower Controller inn-co GmbH	CO2000	017303	NA	NA
Turn Table ADT.	TT100.	TT93021703	NA	NA
Turn Table Controller ADT.	SC100.	SC93021703	NA	NA

- NOTE:**
1. The calibration interval of the above test instruments is 12 months and the calibrations are traceable to NML/ROC and NIST/USA.
 2. The test was performed in HwaYa Chamber 3.
 3. The horn antenna and HP preamplifier (model: 8449B) are used only for the measurement of emission frequency above 1GHz if tested.
 4. The FCC Site Registration No. is 988962.
 5. The IC Site Registration No. is IC 7450F-3.

4.1.3 TEST PROCEDURES

- a. The EUT was placed on the top of a rotating table 0.8 meters above the ground at a 3 meters semi-anechoic chamber. The table was rotated 360 degrees to determine the position of the highest radiation.
- b. The EUT was set 3 meters away from the interference-receiving antenna, which was mounted on the top of a variable-height antenna tower.
- c. The antenna is a broadband antenna, and its height is varied from one meter to four meters above the ground to determine the maximum value of the field strength. Both horizontal and vertical polarizations of the antenna are set to make the measurement.
- d. For each suspected emission, the EUT was arranged to its worst case and then the antenna was tuned to heights from 1 meter to 4 meters and the rotatable table was turned from 0 degrees to 360 degrees to find the maximum reading.
- e. The test-receiver system was set to Peak Detect Function and Specified Bandwidth with Maximum Hold Mode.
- f. If the emission level of the EUT in peak mode was lower than the limit specified, then testing could be stopped and the peak values of the EUT would be reported. Otherwise the emissions would be re-tested one by one using peak, quasi-peak or average method as specified and then reported in a data sheet.

NOTE:

1. The resolution bandwidth and video bandwidth of test receiver/spectrum analyzer is 120kHz for Quasi-peak detection at frequency below 1GHz.
2. The resolution bandwidth of test receiver/spectrum analyzer is 1MHz and video bandwidth is 3MHz for Peak detection at frequency above 1GHz.
3. The resolution bandwidth of test receiver/spectrum analyzer is 1MHz and the video bandwidth is 10Hz for Average detection (AV) at frequency above 1GHz.
4. All modes of operation were investigated and the worst-case emissions are reported.

4.1.4 DEVIATION FROM TEST STANDARD

No deviation.

4.1.5 TEST SETUP

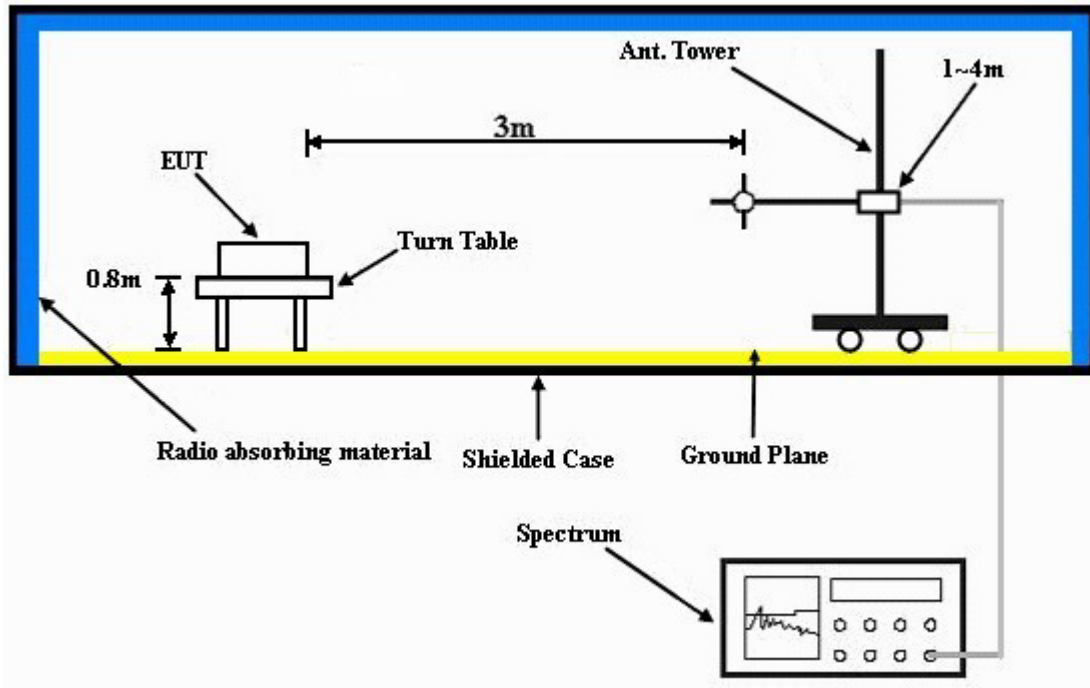

For the actual test configuration, please refer to the attached file (Test Setup Photo).

4.1.6 EUT OPERATING CONDITIONS

- Placed the EUT on a testing table.
- Use the software to control the EUT under transmission condition continuously at specific channel frequency.



4.1.7 TEST RESULT

Above 1GHz Data: 802.11b

802.11b

EUT TEST CONDITION		MEASUREMENT DETAIL	
CHANNEL	Channel 1	FREQUENCY RANGE	1 ~ 25GHz
INPUT POWER (SYSTEM)	120Vac, 60 Hz	DETECTOR FUNCTION	Peak (PK) Average (AV)
ENVIRONMENTAL CONDITIONS	25deg. C, 65%RH	TESTED BY	Kay Wu
TEST MODE	A		

ANTENNA POLARITY & TEST DISTANCE: HORIZONTAL AT 3 M								
NO.	FREQ. (MHz)	EMISSION LEVEL (dBuV/m)	LIMIT (dBuV/m)	MARGIN (dB)	ANTENNA HEIGHT (m)	TABLE ANGLE (Degree)	RAW VALUE (dBuV)	CORRECTION FACTOR (dB/m)
1	2385.70	56.2 PK	74.0	-17.8	1.00 H	142	25.10	31.10
2	2385.70	49.8 AV	54.0	-4.2	1.00 H	142	18.70	31.10
3	*2412.00	104.6 PK			1.00 H	142	73.40	31.20
4	*2412.00	100.6 AV			1.00 H	142	69.40	31.20
5	4824.00	55.7 PK	74.0	-18.3	1.09 H	183	18.80	36.90
6	4824.00	52.9 AV	54.0	-1.1	1.09 H	183	16.00	36.90
7	#7236.00	54.4 PK	84.6	-30.2	1.05 H	153	11.50	42.90
8	#7236.00	45.2 AV	80.6	-35.4	1.05 H	153	2.30	42.90
ANTENNA POLARITY & TEST DISTANCE: VERTICAL AT 3 M								
NO.	FREQ. (MHz)	EMISSION LEVEL (dBuV/m)	LIMIT (dBuV/m)	MARGIN (dB)	ANTENNA HEIGHT (m)	TABLE ANGLE (Degree)	RAW VALUE (dBuV)	CORRECTION FACTOR (dB/m)
1	2390.00	53.0 PK	74.0	-21.0	1.35 V	85	21.90	31.10
2	2390.00	46.4 AV	54.0	-7.6	1.35 V	85	15.30	31.10
3	*2412.00	101.2 PK			1.35 V	85	70.00	31.20
4	*2412.00	96.9 AV			1.35 V	85	65.70	31.20
5	4824.00	56.4 PK	74.0	-17.6	1.14 V	130	19.50	36.90
6	4824.00	53.0 AV	54.0	-1.0	1.14 V	130	16.10	36.90
7	#7236.00	56.2 PK	81.2	-25.0	1.08 V	178	13.30	42.90
8	#7236.00	48.7 AV	76.9	-28.2	1.08 V	178	5.80	42.90

- REMARKS:**
1. Emission level (dBuV/m) = Raw Value (dBuV) + Correction Factor (dB/m).
 2. Correction Factor (dB/m) = Antenna Factor (dB/m) + Cable Factor (dB).
 3. The other emission levels were very low against the limit.
 4. Margin value = Emission level – Limit value.
 5. “ * “: Fundamental frequency.
 6. “#“: The radiated frequency is out the restricted band.



A D T

EUT TEST CONDITION		MEASUREMENT DETAIL	
CHANNEL	Channel 6	FREQUENCY RANGE	1 ~ 25GHz
INPUT POWER (SYSTEM)	120Vac, 60 Hz	DETECTOR FUNCTION	Peak (PK) Average (AV)
ENVIRONMENTAL CONDITIONS	25deg. C, 65%RH	TESTED BY	Kay Wu
TEST MODE	A		

ANTENNA POLARITY & TEST DISTANCE: HORIZONTAL AT 3 M								
NO.	FREQ. (MHz)	EMISSION LEVEL (dBuV/m)	LIMIT (dBuV/m)	MARGIN (dB)	ANTENNA HEIGHT (m)	TABLE ANGLE (Degree)	RAW VALUE (dBuV)	CORRECTION FACTOR (dB/m)
1	*2437.00	103.2 PK			1.00 H	142	71.90	31.30
2	*2437.00	99.0 AV			1.00 H	142	67.70	31.30
3	4874.00	55.3 PK	74.0	-18.7	1.06 H	156	18.30	37.00
4	4874.00	52.5 AV	54.0	-1.5	1.06 H	156	15.50	37.00
5	7311.00	54.1 PK	74.0	-19.9	1.00 H	150	11.00	43.10
6	7311.00	41.9 AV	54.0	-12.1	1.00 H	150	-1.20	43.10

ANTENNA POLARITY & TEST DISTANCE: VERTICAL AT 3 M								
NO.	FREQ. (MHz)	EMISSION LEVEL (dBuV/m)	LIMIT (dBuV/m)	MARGIN (dB)	ANTENNA HEIGHT (m)	TABLE ANGLE (Degree)	RAW VALUE (dBuV)	CORRECTION FACTOR (dB/m)
1	*2437.00	101.1 PK			1.05 V	101	69.80	31.30
2	*2437.00	96.8 AV			1.05 V	101	65.50	31.30
3	4874.00	56.6 PK	74.0	-17.4	1.00 V	149	19.60	37.00
4	4874.00	52.7 AV	54.0	-1.3	1.00 V	149	15.70	37.00
5	7311.00	54.9 PK	74.0	-19.1	1.00 V	189	11.80	43.10
6	7311.00	45.4 AV	54.0	-8.6	1.00 V	189	2.30	43.10

- REMARKS:**
1. Emission level (dBuV/m) = Raw Value (dBuV) + Correction Factor (dB/m).
 2. Correction Factor (dB/m) = Antenna Factor (dB/m) + Cable Factor (dB).
 3. The other emission levels were very low against the limit.
 4. Margin value = Emission level – Limit value.
 5. “ * ”: Fundamental frequency.



A D T

EUT TEST CONDITION		MEASUREMENT DETAIL	
CHANNEL	Channel 11	FREQUENCY RANGE	1 ~ 25GHz
INPUT POWER (SYSTEM)	120Vac, 60 Hz	DETECTOR FUNCTION	Peak (PK) Average (AV)
ENVIRONMENTAL CONDITIONS	25deg. C, 65%RH	TESTED BY	Kay Wu
TEST MODE	A		

ANTENNA POLARITY & TEST DISTANCE: HORIZONTAL AT 3 M								
NO.	FREQ. (MHz)	EMISSION LEVEL (dBuV/m)	LIMIT (dBuV/m)	MARGIN (dB)	ANTENNA HEIGHT (m)	TABLE ANGLE (Degree)	RAW VALUE (dBuV)	CORRECTION FACTOR (dB/m)
1	*2462.00	103.2 PK			1.00 H	197	71.80	31.40
2	*2462.00	99.1 AV			1.00 H	197	67.70	31.40
3	2483.50	50.7 PK	74.0	-23.3	1.00 H	197	19.30	31.40
4	2483.50	40.9 AV	54.0	-13.1	1.00 H	197	9.50	31.40
5	4924.00	56.0 PK	74.0	-18.0	1.05 H	151	18.90	37.10
6	4924.00	52.3 AV	54.0	-1.7	1.05 H	151	15.20	37.10
7	7386.00	53.0 PK	74.0	-21.0	1.24 H	154	9.70	43.30
8	7386.00	41.4 AV	54.0	-12.6	1.24 H	154	-1.90	43.30

ANTENNA POLARITY & TEST DISTANCE: VERTICAL AT 3 M								
NO.	FREQ. (MHz)	EMISSION LEVEL (dBuV/m)	LIMIT (dBuV/m)	MARGIN (dB)	ANTENNA HEIGHT (m)	TABLE ANGLE (Degree)	RAW VALUE (dBuV)	CORRECTION FACTOR (dB/m)
1	*2462.00	100.7 PK			1.00 V	107	69.30	31.40
2	*2462.00	96.5 AV			1.00 V	107	65.10	31.40
3	2483.50	49.2 PK	74.0	-24.8	1.00 V	107	17.80	31.40
4	2483.50	39.5 AV	54.0	-14.5	1.00 V	107	8.10	31.40
5	4924.00	55.8 PK	74.0	-18.2	1.00 V	167	18.70	37.10
6	4924.00	52.9 AV	54.0	-1.1	1.00 V	167	15.80	37.10
7	7386.00	53.4 PK	74.0	-20.6	1.46 V	139	10.10	43.30
8	7386.00	41.8 AV	54.0	-12.2	1.46 V	139	-1.50	43.30

- REMARKS:**
1. Emission level (dBuV/m) = Raw Value (dBuV) + Correction Factor (dB/m).
 2. Correction Factor (dB/m) = Antenna Factor (dB/m) + Cable Factor (dB).
 3. The other emission levels were very low against the limit.
 4. Margin value = Emission level – Limit value.
 5. “ * “: Fundamental frequency.



A D T

EUT TEST CONDITION		MEASUREMENT DETAIL	
CHANNEL	Channel 1	FREQUENCY RANGE	1 ~ 25GHz
INPUT POWER (SYSTEM)	120Vac, 60 Hz	DETECTOR FUNCTION	Peak (PK) Average (AV)
ENVIRONMENTAL CONDITIONS	25deg. C, 65%RH	TESTED BY	Kay Wu
TEST MODE	C		

ANTENNA POLARITY & TEST DISTANCE: HORIZONTAL AT 3 M								
NO.	FREQ. (MHz)	EMISSION LEVEL (dBuV/m)	LIMIT (dBuV/m)	MARGIN (dB)	ANTENNA HEIGHT (m)	TABLE ANGLE (Degree)	RAW VALUE (dBuV)	CORRECTION FACTOR (dB/m)
1	2385.70	56.3 PK	74.0	-17.7	1.00 H	342	25.20	31.10
2	2385.70	49.2 AV	54.0	-4.8	1.00 H	342	18.10	31.10
3	*2412.00	104.1 PK			1.00 H	342	72.90	31.20
4	*2412.00	99.8 AV			1.00 H	342	68.60	31.20
5	4824.00	54.0 PK	74.0	-20.0	1.04 H	334	17.10	36.90
6	4824.00	51.1 AV	54.0	-2.9	1.04 H	334	14.20	36.90
7	#7236.00	56.1 PK	84.1	-28.0	1.00 H	329	13.20	42.90
8	#7236.00	48.8 AV	79.8	-31.0	1.00 H	329	5.90	42.90

ANTENNA POLARITY & TEST DISTANCE: VERTICAL AT 3 M								
NO.	FREQ. (MHz)	EMISSION LEVEL (dBuV/m)	LIMIT (dBuV/m)	MARGIN (dB)	ANTENNA HEIGHT (m)	TABLE ANGLE (Degree)	RAW VALUE (dBuV)	CORRECTION FACTOR (dB/m)
1	2385.70	48.8 PK	74.0	-25.2	1.00 V	130	17.70	31.10
2	2385.70	42.5 AV	54.0	-11.5	1.00 V	130	11.40	31.10
3	*2412.00	101.1 PK			1.00 V	130	69.90	31.20
4	*2412.00	96.8 AV			1.00 V	130	65.60	31.20
5	4824.00	53.3 PK	74.0	-20.7	1.00 V	346	16.40	36.90
6	4824.00	50.3 AV	54.0	-3.7	1.00 V	346	13.40	36.90
7	#7236.00	55.5 PK	81.1	-25.6	1.18 V	347	12.60	42.90
8	#7236.00	48.7 AV	76.8	-28.1	1.18 V	347	5.80	42.90

- REMARKS:**
1. Emission level (dBuV/m) = Raw Value (dBuV) + Correction Factor (dB/m).
 2. Correction Factor (dB/m) = Antenna Factor (dB/m) + Cable Factor (dB).
 3. The other emission levels were very low against the limit.
 4. Margin value = Emission level – Limit value.
 5. “ * “: Fundamental frequency.
 6. “#”: The radiated frequency is out the restricted band.



A D T

802.11g

EUT TEST CONDITION		MEASUREMENT DETAIL	
CHANNEL	Channel 1	FREQUENCY RANGE	1 ~ 25GHz
INPUT POWER (SYSTEM)	120Vac, 60 Hz	DETECTOR FUNCTION	Peak (PK) Average (AV)
ENVIRONMENTAL CONDITIONS	25deg. C, 65%RH	TESTED BY	Kay Wu
TEST MODE	A		

ANTENNA POLARITY & TEST DISTANCE: HORIZONTAL AT 3 M								
NO.	FREQ. (MHz)	EMISSION LEVEL (dBuV/m)	LIMIT (dBuV/m)	MARGIN (dB)	ANTENNA HEIGHT (m)	TABLE ANGLE (Degree)	RAW VALUE (dBuV)	CORRECTION FACTOR (dB/m)
1	2390.00	60.8 PK	74.0	-13.2	1.00 H	170	29.70	31.10
2	2390.00	47.8 AV	54.0	-6.2	1.00 H	170	16.70	31.10
3	*2412.00	105.4 PK			1.00 H	170	74.20	31.20
4	*2412.00	91.6 AV			1.00 H	170	60.40	31.20
5	4824.00	50.8 PK	74.0	-23.2	1.36 H	168	13.90	36.90
6	4824.00	36.8 AV	54.0	-17.2	1.36 H	168	-0.10	36.90
7	7326.00	53.2 PK	74.0	-20.8	1.32 H	145	10.10	43.10
8	7326.00	38.9 AV	54.0	-15.1	1.32 H	145	-4.20	43.10

ANTENNA POLARITY & TEST DISTANCE: VERTICAL AT 3 M								
NO.	FREQ. (MHz)	EMISSION LEVEL (dBuV/m)	LIMIT (dBuV/m)	MARGIN (dB)	ANTENNA HEIGHT (m)	TABLE ANGLE (Degree)	RAW VALUE (dBuV)	CORRECTION FACTOR (dB/m)
1	2390.00	59.2 PK	74.0	-14.8	1.06 V	67	28.10	31.10
2	2390.00	46.1 AV	54.0	-7.9	1.06 V	67	15.00	31.10
3	*2412.00	103.1 PK			1.06 V	67	71.90	31.20
4	*2412.00	89.3 AV			1.06 V	67	58.10	31.20
5	4824.00	52.3 PK	74.0	-21.7	1.00 V	150	15.40	36.90
6	4824.00	36.4 AV	54.0	-17.6	1.00 V	150	-0.50	36.90
7	#7236.00	54.3 PK	83.1	-28.8	1.00 V	47	11.40	42.90
8	#7236.00	38.5 AV	69.3	-30.8	1.00 V	47	-4.40	42.90

- REMARKS:**
1. Emission level (dBuV/m) = Raw Value (dBuV) + Correction Factor (dB/m).
 2. Correction Factor (dB/m) = Antenna Factor (dB/m) + Cable Factor (dB).
 3. The other emission levels were very low against the limit.
 4. Margin value = Emission level – Limit value.
 5. “ * “: Fundamental frequency.
 6. “#”:The radiated frequency is out the restricted band.



A D T

EUT TEST CONDITION		MEASUREMENT DETAIL	
CHANNEL	Channel 6	FREQUENCY RANGE	1 ~ 25GHz
INPUT POWER (SYSTEM)	120Vac, 60 Hz	DETECTOR FUNCTION	Peak (PK) Average (AV)
ENVIRONMENTAL CONDITIONS	25deg. C, 65%RH	TESTED BY	Kay Wu
TEST MODE	A		

ANTENNA POLARITY & TEST DISTANCE: HORIZONTAL AT 3 M								
NO.	FREQ. (MHz)	EMISSION LEVEL (dBuV/m)	LIMIT (dBuV/m)	MARGIN (dB)	ANTENNA HEIGHT (m)	TABLE ANGLE (Degree)	RAW VALUE (dBuV)	CORRECTION FACTOR (dB/m)
1	*2437.00	103.5 PK			1.00 H	171	72.20	31.30
2	*2437.00	90.1 AV			1.00 H	171	58.80	31.30
3	4874.00	52.7 PK	74.0	-21.3	1.06 H	156	15.70	37.00
4	4874.00	37.3 AV	54.0	-16.7	1.06 H	156	0.30	37.00
5	7311.00	52.1 PK	74.0	-21.9	1.49 H	147	9.00	43.10
6	7311.00	38.5 AV	54.0	-15.5	1.49 H	147	-4.60	43.10

ANTENNA POLARITY & TEST DISTANCE: VERTICAL AT 3 M								
NO.	FREQ. (MHz)	EMISSION LEVEL (dBuV/m)	LIMIT (dBuV/m)	MARGIN (dB)	ANTENNA HEIGHT (m)	TABLE ANGLE (Degree)	RAW VALUE (dBuV)	CORRECTION FACTOR (dB/m)
1	*2437.00	101.1 PK			1.08 V	25	69.80	31.30
2	*2437.00	87.7 AV			1.08 V	25	56.40	31.30
3	4874.00	49.6 PK	74.0	-24.4	1.00 V	154	12.60	37.00
4	4874.00	34.9 AV	54.0	-19.1	1.00 V	154	-2.10	37.00
5	7311.00	52.5 PK	74.0	-21.5	1.95 V	182	9.40	43.10
6	7311.00	38.3 AV	54.0	-15.7	1.95 V	182	-4.80	43.10

- REMARKS:**
1. Emission level (dBuV/m) = Raw Value (dBuV) + Correction Factor (dB/m).
 2. Correction Factor (dB/m) = Antenna Factor (dB/m) + Cable Factor (dB).
 3. The other emission levels were very low against the limit.
 4. Margin value = Emission level – Limit value.
 5. “ * ”: Fundamental frequency.



A D T

EUT TEST CONDITION		MEASUREMENT DETAIL	
CHANNEL	Channel 11	FREQUENCY RANGE	1 ~ 25GHz
INPUT POWER (SYSTEM)	120Vac, 60 Hz	DETECTOR FUNCTION	Peak (PK) Average (AV)
ENVIRONMENTAL CONDITIONS	25deg. C, 65%RH	TESTED BY	Kay Wu
TEST MODE	A		

ANTENNA POLARITY & TEST DISTANCE: HORIZONTAL AT 3 M								
NO.	FREQ. (MHz)	EMISSION LEVEL (dBuV/m)	LIMIT (dBuV/m)	MARGIN (dB)	ANTENNA HEIGHT (m)	TABLE ANGLE (Degree)	RAW VALUE (dBuV)	CORRECTION FACTOR (dB/m)
1	*2462.00	103.3 PK			1.00 H	183	71.90	31.40
2	*2462.00	89.1 AV			1.00 H	183	57.70	31.40
3	2483.50	64.7 PK	74.0	-9.3	1.00 H	183	33.30	31.40
4	2483.50	46.2 AV	54.0	-7.8	1.00 H	183	14.80	31.40
5	4924.00	49.1 PK	74.0	-24.9	1.00 H	160	12.00	37.10
6	4924.00	34.8 AV	54.0	-19.2	1.00 H	160	-2.30	37.10
ANTENNA POLARITY & TEST DISTANCE: VERTICAL AT 3 M								
NO.	FREQ. (MHz)	EMISSION LEVEL (dBuV/m)	LIMIT (dBuV/m)	MARGIN (dB)	ANTENNA HEIGHT (m)	TABLE ANGLE (Degree)	RAW VALUE (dBuV)	CORRECTION FACTOR (dB/m)
1	*2462.00	99.5 PK			1.02 V	64	68.10	31.40
2	*2462.00	85.8 AV			1.02 V	64	54.40	31.40
3	2483.50	60.0 PK	74.0	-14.0	1.02 V	64	28.60	31.40
4	2483.50	45.1 AV	54.0	-8.9	1.02 V	64	13.70	31.40
5	4924.00	47.9 PK	74.0	-26.1	1.00 V	10	10.80	37.10
6	4924.00	33.6 AV	54.0	-20.4	1.00 V	10	-3.50	37.10

- REMARKS:**
1. Emission level (dBuV/m) = Raw Value (dBuV) + Correction Factor (dB/m).
 2. Correction Factor (dB/m) = Antenna Factor (dB/m) + Cable Factor (dB).
 3. The other emission levels were very low against the limit.
 4. Margin value = Emission level – Limit value.
 5. “ * ”: Fundamental frequency.



A D T

802.11n (20MHz)

EUT TEST CONDITION		MEASUREMENT DETAIL	
CHANNEL	Channel 1	FREQUENCY RANGE	1 ~ 25GHz
INPUT POWER (SYSTEM)	120Vac, 60 Hz	DETECTOR FUNCTION	Peak (PK) Average (AV)
ENVIRONMENTAL CONDITIONS	25deg. C, 65%RH	TESTED BY	Kay Wu
TEST MODE	A		

ANTENNA POLARITY & TEST DISTANCE: HORIZONTAL AT 3 M								
NO.	FREQ. (MHz)	EMISSION LEVEL (dBuV/m)	LIMIT (dBuV/m)	MARGIN (dB)	ANTENNA HEIGHT (m)	TABLE ANGLE (Degree)	RAW VALUE (dBuV)	CORRECTION FACTOR (dB/m)
1	2390.00	59.6 PK	74.0	-14.4	1.00 H	172	28.50	31.10
2	2390.00	46.8 AV	54.0	-7.2	1.00 H	172	15.70	31.10
3	*2412.00	102.7 PK			1.00 H	172	71.50	31.20
4	*2412.00	89.2 AV			1.00 H	172	58.00	31.20
5	4824.00	50.1 PK	74.0	-23.9	1.08 H	166	13.20	36.90
6	4824.00	36.2 AV	54.0	-17.8	1.08 H	166	-0.70	36.90
7	#7236.00	52.9 PK	82.7	-29.8	1.40 H	149	10.00	42.90
8	#7236.00	38.5 AV	69.2	-30.7	1.40 H	149	-4.40	42.90

ANTENNA POLARITY & TEST DISTANCE: VERTICAL AT 3 M								
NO.	FREQ. (MHz)	EMISSION LEVEL (dBuV/m)	LIMIT (dBuV/m)	MARGIN (dB)	ANTENNA HEIGHT (m)	TABLE ANGLE (Degree)	RAW VALUE (dBuV)	CORRECTION FACTOR (dB/m)
1	2390.00	59.8 PK	74.0	-14.2	1.08 V	67	28.70	31.10
2	2390.00	45.9 AV	54.0	-8.1	1.08 V	67	14.80	31.10
3	*2412.00	100.8 PK			1.08 V	67	69.60	31.20
4	*2412.00	88.3 AV			1.08 V	67	57.10	31.20
5	4824.00	51.0 PK	74.0	-23.0	1.16 V	150	14.10	36.90
6	4824.00	35.5 AV	54.0	-18.5	1.16 V	150	-1.40	36.90
7	#7236.00	52.5 PK	80.8	-28.3	1.00 V	188	9.60	42.90
8	#7236.00	38.1 AV	68.3	-30.2	1.00 V	188	-4.80	42.90

- REMARKS:**
1. Emission level (dBuV/m) = Raw Value (dBuV) + Correction Factor (dB/m).
 2. Correction Factor (dB/m) = Antenna Factor (dB/m) + Cable Factor (dB).
 3. The other emission levels were very low against the limit.
 4. Margin value = Emission level – Limit value.
 5. “ * “: Fundamental frequency.
 6. “#”:The radiated frequency is out the restricted band.



A D T

EUT TEST CONDITION		MEASUREMENT DETAIL	
CHANNEL	Channel 6	FREQUENCY RANGE	1 ~ 25GHz
INPUT POWER (SYSTEM)	120Vac, 60 Hz	DETECTOR FUNCTION	Peak (PK) Average (AV)
ENVIRONMENTAL CONDITIONS	25deg. C, 65%RH	TESTED BY	Kay Wu
TEST MODE	A		

ANTENNA POLARITY & TEST DISTANCE: HORIZONTAL AT 3 M								
NO.	FREQ. (MHz)	EMISSION LEVEL (dBuV/m)	LIMIT (dBuV/m)	MARGIN (dB)	ANTENNA HEIGHT (m)	TABLE ANGLE (Degree)	RAW VALUE (dBuV)	CORRECTION FACTOR (dB/m)
1	*2437.00	102.0 PK			1.00 H	169	70.70	31.30
2	*2437.00	88.5 AV			1.00 H	169	57.20	31.30
3	4874.00	50.6 PK	74.0	-23.4	1.32 H	161	13.60	37.00
4	4874.00	35.6 AV	54.0	-18.4	1.32 H	161	-1.40	37.00
5	7311.00	50.7 PK	74.0	-23.3	1.27 H	136	7.60	43.10
6	7311.00	37.6 AV	54.0	-16.4	1.27 H	136	-5.50	43.10
ANTENNA POLARITY & TEST DISTANCE: VERTICAL AT 3 M								
NO.	FREQ. (MHz)	EMISSION LEVEL (dBuV/m)	LIMIT (dBuV/m)	MARGIN (dB)	ANTENNA HEIGHT (m)	TABLE ANGLE (Degree)	RAW VALUE (dBuV)	CORRECTION FACTOR (dB/m)
1	*2437.00	99.7 PK			1.02 V	98	68.40	31.30
2	*2437.00	86.1 AV			1.02 V	98	54.80	31.30
3	4874.00	48.3 PK	74.0	-25.7	1.00 V	156	11.30	37.00
4	4874.00	34.3 AV	54.0	-19.7	1.00 V	156	-2.70	37.00
5	7311.00	50.6 PK	74.0	-23.4	1.00 V	20	7.50	43.10
6	7311.00	36.3 AV	54.0	-17.7	1.00 V	20	-6.80	43.10

- REMARKS:**
1. Emission level (dBuV/m) = Raw Value (dBuV) + Correction Factor (dB/m).
 2. Correction Factor (dB/m) = Antenna Factor (dB/m) + Cable Factor (dB).
 3. The other emission levels were very low against the limit.
 4. Margin value = Emission level – Limit value.
 5. “ * ”: Fundamental frequency.



A D T

EUT TEST CONDITION		MEASUREMENT DETAIL	
CHANNEL	Channel 11	FREQUENCY RANGE	1 ~ 25GHz
INPUT POWER (SYSTEM)	120Vac, 60 Hz	DETECTOR FUNCTION	Peak (PK) Average (AV)
ENVIRONMENTAL CONDITIONS	25deg. C, 65%RH	TESTED BY	Kay Wu
TEST MODE	A		

ANTENNA POLARITY & TEST DISTANCE: HORIZONTAL AT 3 M								
NO.	FREQ. (MHz)	EMISSION LEVEL (dBuV/m)	LIMIT (dBuV/m)	MARGIN (dB)	ANTENNA HEIGHT (m)	TABLE ANGLE (Degree)	RAW VALUE (dBuV)	CORRECTION FACTOR (dB/m)
1	*2462.00	100.8 PK			1.00 H	173	69.40	31.40
2	*2462.00	86.8 AV			1.00 H	173	55.40	31.40
3	2483.50	58.6 PK	74.0	-15.4	1.00 H	173	27.20	31.40
4	2483.50	44.8 AV	54.0	-9.2	1.00 H	173	13.40	31.40
5	4924.00	53.2 PK	74.0	-20.8	1.04 H	156	16.10	37.10
6	4924.00	34.5 AV	54.0	-19.5	1.04 H	156	-2.60	37.10
ANTENNA POLARITY & TEST DISTANCE: VERTICAL AT 3 M								
NO.	FREQ. (MHz)	EMISSION LEVEL (dBuV/m)	LIMIT (dBuV/m)	MARGIN (dB)	ANTENNA HEIGHT (m)	TABLE ANGLE (Degree)	RAW VALUE (dBuV)	CORRECTION FACTOR (dB/m)
1	*2462.00	96.9 PK			1.00 V	96	65.50	31.40
2	*2462.00	84.2 AV			1.00 V	96	52.80	31.40
3	2483.50	59.2 PK	74.0	-14.8	1.00 V	96	27.80	31.40
4	2483.50	44.5 AV	54.0	-9.5	1.00 V	96	13.10	31.40
5	4924.00	48.5 PK	74.0	-25.5	1.00 V	154	11.40	37.10
6	4924.00	34.3 AV	54.0	-19.7	1.00 V	154	-2.80	37.10

- REMARKS:**
1. Emission level (dBuV/m) = Raw Value (dBuV) + Correction Factor (dB/m).
 2. Correction Factor (dB/m) = Antenna Factor (dB/m) + Cable Factor (dB).
 3. The other emission levels were very low against the limit.
 4. Margin value = Emission level – Limit value.
 5. “ * ”: Fundamental frequency.



BELOW 1GHz DATA : 802.11b

EUT TEST CONDITION		MEASUREMENT DETAIL	
CHANNEL	Channel 1	FREQUENCY RANGE	Below 1000MHz
INPUT POWER (SYSTEM)	120Vac, 60 Hz	DETECTOR FUNCTION	Quasi-Peak
ENVIRONMENTAL CONDITIONS	25deg. C, 65%RH	TESTED BY	Kay Wu
TEST MODE	A		

ANTENNA POLARITY & TEST DISTANCE: HORIZONTAL AT 3 M								
NO.	FREQ. (MHz)	EMISSION LEVEL (dBuV/m)	LIMIT (dBuV/m)	MARGIN (dB)	ANTENNA HEIGHT (m)	TABLE ANGLE (Degree)	RAW VALUE (dBuV)	CORRECTION FACTOR (dB/m)
1	82.40	31.5 QP	40.0	-8.5	4.00 H	331	22.40	9.10
2	138.78	30.5 QP	43.5	-13.0	2.00 H	130	16.50	14.00
3	179.61	27.4 QP	43.5	-16.1	1.00 H	94	14.80	12.60
4	237.94	25.0 QP	46.0	-21.0	1.00 H	10	12.60	12.40
5	278.77	27.5 QP	46.0	-18.5	1.00 H	10	13.40	14.10
6	335.15	25.4 QP	46.0	-20.6	1.00 H	1	9.60	15.80
ANTENNA POLARITY & TEST DISTANCE: VERTICAL AT 3 M								
NO.	FREQ. (MHz)	EMISSION LEVEL (dBuV/m)	LIMIT (dBuV/m)	MARGIN (dB)	ANTENNA HEIGHT (m)	TABLE ANGLE (Degree)	RAW VALUE (dBuV)	CORRECTION FACTOR (dB/m)
1	30.00	24.6 QP	40.0	-15.4	1.00 V	127	12.10	12.50
2	82.40	24.5 QP	40.0	-15.5	3.00 V	268	15.40	9.10
3	136.84	24.4 QP	43.5	-19.1	1.00 V	94	10.50	13.90
4	181.55	22.4 QP	43.5	-21.1	1.00 V	259	10.00	12.40
5	243.77	19.6 QP	46.0	-26.4	1.00 V	103	6.90	12.70
6	340.99	25.1 QP	46.0	-20.9	1.00 V	352	9.20	15.90

- REMARKS:**
1. Emission level (dBuV/m) = Raw Value (dBuV) + Correction Factor (dB/m).
 2. Correction Factor (dB/m) = Antenna Factor (dB/m) + Cable Factor (dB).
 3. The other emission levels were very low against the limit.
 4. Margin value = Emission level – Limit value.



A D T

EUT TEST CONDITION		MEASUREMENT DETAIL	
CHANNEL	Channel 6	FREQUENCY RANGE	Below 1000MHz
INPUT POWER (SYSTEM)	120Vac, 60 Hz	DETECTOR FUNCTION	Quasi-Peak
ENVIRONMENTAL CONDITIONS	25deg. C, 65%RH	TESTED BY	Kay Wu
TEST MODE	A		

ANTENNA POLARITY & TEST DISTANCE: HORIZONTAL AT 3 M								
NO.	FREQ. (MHz)	EMISSION LEVEL (dBuV/m)	LIMIT (dBuV/m)	MARGIN (dB)	ANTENNA HEIGHT (m)	TABLE ANGLE (Degree)	RAW VALUE (dBuV)	CORRECTION FACTOR (dB/m)
1	39.62	16.7 QP	40.0	-23.3	3.00 H	151	2.40	14.30
2	82.40	28.6 QP	40.0	-11.4	1.00 H	322	19.50	9.10
3	142.67	30.4 QP	43.5	-13.1	1.00 H	118	16.20	14.20
4	181.55	29.5 QP	43.5	-14.0	1.00 H	142	17.10	12.40
5	247.66	28.0 QP	46.0	-18.0	1.00 H	97	15.10	12.90
6	337.10	28.1 QP	46.0	-17.9	1.00 H	112	12.30	15.80

ANTENNA POLARITY & TEST DISTANCE: VERTICAL AT 3 M								
NO.	FREQ. (MHz)	EMISSION LEVEL (dBuV/m)	LIMIT (dBuV/m)	MARGIN (dB)	ANTENNA HEIGHT (m)	TABLE ANGLE (Degree)	RAW VALUE (dBuV)	CORRECTION FACTOR (dB/m)
1	39.62	22.1 QP	40.0	-17.9	1.00 V	211	7.80	14.30
2	99.89	18.6 QP	43.5	-24.9	2.00 V	94	8.40	10.20
3	187.39	18.2 QP	43.5	-25.3	1.00 V	58	6.40	11.80
4	228.22	22.3 QP	46.0	-23.7	2.00 V	256	10.50	11.80
5	335.15	22.8 QP	46.0	-23.2	1.00 V	292	7.00	15.80
6	562.64	23.5 QP	46.0	-22.5	2.00 V	343	1.90	21.60

- REMARKS:**
1. Emission level (dBuV/m) = Raw Value (dBuV) + Correction Factor (dB/m).
 2. Correction Factor (dB/m) = Antenna Factor (dB/m) + Cable Factor (dB).
 3. The other emission levels were very low against the limit.
 4. Margin value = Emission level – Limit value.



A D T

EUT TEST CONDITION		MEASUREMENT DETAIL	
CHANNEL	Channel 11	FREQUENCY RANGE	Below 1000MHz
INPUT POWER (SYSTEM)	120Vac, 60 Hz	DETECTOR FUNCTION	Quasi-Peak
ENVIRONMENTAL CONDITIONS	25deg. C, 65%RH	TESTED BY	Kay Wu
TEST MODE	A		

ANTENNA POLARITY & TEST DISTANCE: HORIZONTAL AT 3 M								
NO.	FREQ. (MHz)	EMISSION LEVEL (dBuV/m)	LIMIT (dBuV/m)	MARGIN (dB)	ANTENNA HEIGHT (m)	TABLE ANGLE (Degree)	RAW VALUE (dBuV)	CORRECTION FACTOR (dB/m)
1	82.40	31.9 QP	40.0	-8.1	2.00 H	202	22.80	9.10
2	134.89	31.8 QP	43.5	-11.7	2.00 H	136	18.10	13.70
3	179.61	29.6 QP	43.5	-13.9	2.00 H	163	17.00	12.60
4	245.72	27.5 QP	46.0	-18.5	1.00 H	52	14.70	12.80
5	286.55	26.7 QP	46.0	-19.3	1.00 H	10	12.30	14.40
6	337.10	27.8 QP	46.0	-18.2	1.00 H	196	12.00	15.80

ANTENNA POLARITY & TEST DISTANCE: VERTICAL AT 3 M								
NO.	FREQ. (MHz)	EMISSION LEVEL (dBuV/m)	LIMIT (dBuV/m)	MARGIN (dB)	ANTENNA HEIGHT (m)	TABLE ANGLE (Degree)	RAW VALUE (dBuV)	CORRECTION FACTOR (dB/m)
1	43.51	26.8 QP	40.0	-13.2	1.00 V	124	12.40	14.40
2	82.40	24.7 QP	40.0	-15.3	3.00 V	280	15.60	9.10
3	131.00	25.0 QP	43.5	-18.5	1.00 V	97	11.60	13.40
4	179.61	23.5 QP	43.5	-20.0	1.00 V	109	10.90	12.60
5	234.05	20.6 QP	46.0	-25.4	2.00 V	67	8.40	12.20
6	344.87	24.9 QP	46.0	-21.1	1.00 V	16	8.90	16.00

- REMARKS:**
1. Emission level (dBuV/m) = Raw Value (dBuV) + Correction Factor (dB/m).
 2. Correction Factor (dB/m) = Antenna Factor (dB/m) + Cable Factor (dB).
 3. The other emission levels were very low against the limit.
 4. Margin value = Emission level – Limit value.



A D T

EUT TEST CONDITION		MEASUREMENT DETAIL	
CHANNEL	Channel 1	FREQUENCY RANGE	Below 1000MHz
INPUT POWER (SYSTEM)	120Vac, 60 Hz	DETECTOR FUNCTION	Quasi-Peak
ENVIRONMENTAL CONDITIONS	25deg. C, 65%RH	TESTED BY	Kay Wu
TEST MODE	C		

ANTENNA POLARITY & TEST DISTANCE: HORIZONTAL AT 3 M								
NO.	FREQ. (MHz)	EMISSION LEVEL (dBuV/m)	LIMIT (dBuV/m)	MARGIN (dB)	ANTENNA HEIGHT (m)	TABLE ANGLE (Degree)	RAW VALUE (dBuV)	CORRECTION FACTOR (dB/m)
1	138.78	19.0 QP	43.5	-24.5	2.00 H	262	5.00	14.00
2	216.00	13.8 QP	43.5	-29.7	1.50 H	262	2.60	11.20
3	486.81	27.2 QP	46.0	-18.8	1.50 H	52	7.40	19.80
4	550.97	28.1 QP	46.0	-17.9	1.50 H	46	6.80	21.30
5	615.13	26.5 QP	46.0	-19.5	1.00 H	31	3.80	22.70
6	708.46	29.1 QP	46.0	-16.9	1.00 H	40	4.90	24.20

ANTENNA POLARITY & TEST DISTANCE: VERTICAL AT 3 M								
NO.	FREQ. (MHz)	EMISSION LEVEL (dBuV/m)	LIMIT (dBuV/m)	MARGIN (dB)	ANTENNA HEIGHT (m)	TABLE ANGLE (Degree)	RAW VALUE (dBuV)	CORRECTION FACTOR (dB/m)
1	39.62	23.1 QP	40.0	-16.9	1.50 V	334	8.80	14.30
2	59.06	26.0 QP	40.0	-14.0	1.50 V	118	12.70	13.30
3	97.95	24.1 QP	43.5	-19.4	1.50 V	55	14.20	9.90
4	302.10	20.8 QP	46.0	-25.2	1.00 V	121	5.80	15.00
5	459.59	27.0 QP	46.0	-19.0	2.00 V	142	7.90	19.10
6	550.97	30.9 QP	46.0	-15.1	2.00 V	277	9.60	21.30

- REMARKS:**
1. Emission level (dBuV/m) = Raw Value (dBuV) + Correction Factor (dB/m).
 2. Correction Factor (dB/m) = Antenna Factor (dB/m) + Cable Factor (dB).
 3. The other emission levels were very low against the limit.
 4. Margin value = Emission level – Limit value.

802.11g

EUT TEST CONDITION		MEASUREMENT DETAIL	
CHANNEL	Channel 1	FREQUENCY RANGE	Below 1000MHz
INPUT POWER (SYSTEM)	120Vac, 60 Hz	DETECTOR FUNCTION	Quasi-Peak
ENVIRONMENTAL CONDITIONS	25deg. C, 65%RH	TESTED BY	Kay Wu
TEST MODE	A		

ANTENNA POLARITY & TEST DISTANCE: HORIZONTAL AT 3 M								
NO.	FREQ. (MHz)	EMISSION LEVEL (dBuV/m)	LIMIT (dBuV/m)	MARGIN (dB)	ANTENNA HEIGHT (m)	TABLE ANGLE (Degree)	RAW VALUE (dBuV)	CORRECTION FACTOR (dB/m)
1	82.40	18.1 QP	40.0	-21.9	2.00 H	145	9.00	9.10
2	132.95	26.0 QP	43.5	-17.5	2.00 H	76	12.50	13.50
3	187.39	20.2 QP	43.5	-23.3	1.00 H	139	8.40	11.80
4	234.05	22.0 QP	46.0	-24.0	1.00 H	124	9.80	12.20
5	274.88	22.7 QP	46.0	-23.3	1.00 H	100	8.80	13.90
6	337.10	22.5 QP	46.0	-23.5	1.00 H	229	6.70	15.80
ANTENNA POLARITY & TEST DISTANCE: VERTICAL AT 3 M								
NO.	FREQ. (MHz)	EMISSION LEVEL (dBuV/m)	LIMIT (dBuV/m)	MARGIN (dB)	ANTENNA HEIGHT (m)	TABLE ANGLE (Degree)	RAW VALUE (dBuV)	CORRECTION FACTOR (dB/m)
1	43.51	20.4 QP	40.0	-19.6	1.00 V	82	6.00	14.40
2	64.90	23.6 QP	40.0	-16.4	1.00 V	145	11.00	12.60
3	132.95	25.7 QP	43.5	-17.8	1.00 V	58	12.20	13.50
4	179.61	25.3 QP	43.5	-18.2	1.00 V	70	12.70	12.60
5	267.10	19.4 QP	46.0	-26.6	2.00 V	253	5.80	13.60
6	342.93	27.1 QP	46.0	-18.9	1.00 V	10	11.10	16.00

- REMARKS:**
1. Emission level (dBuV/m) = Raw Value (dBuV) + Correction Factor (dB/m).
 2. Correction Factor (dB/m) = Antenna Factor (dB/m) + Cable Factor (dB).
 3. The other emission levels were very low against the limit.
 4. Margin value = Emission level – Limit value.



A D T

EUT TEST CONDITION		MEASUREMENT DETAIL	
CHANNEL	Channel 6	FREQUENCY RANGE	Below 1000MHz
INPUT POWER (SYSTEM)	120Vac, 60 Hz	DETECTOR FUNCTION	Quasi-Peak
ENVIRONMENTAL CONDITIONS	25deg. C, 65%RH	TESTED BY	Kay Wu
TEST MODE	A		

ANTENNA POLARITY & TEST DISTANCE: HORIZONTAL AT 3 M								
NO.	FREQ. (MHz)	EMISSION LEVEL (dBuV/m)	LIMIT (dBuV/m)	MARGIN (dB)	ANTENNA HEIGHT (m)	TABLE ANGLE (Degree)	RAW VALUE (dBuV)	CORRECTION FACTOR (dB/m)
1	84.34	22.6 QP	40.0	-17.4	4.00 H	10	13.70	8.90
2	129.06	20.9 QP	43.5	-22.6	4.00 H	10	7.70	13.20
3	181.55	15.2 QP	43.5	-28.3	4.00 H	13	2.80	12.40
4	286.55	19.8 QP	46.0	-26.2	4.00 H	10	5.40	14.40
5	469.31	17.9 QP	46.0	-28.1	4.00 H	10	-1.40	19.30
6	648.18	23.4 QP	46.0	-22.6	4.00 H	10	0.10	23.30

ANTENNA POLARITY & TEST DISTANCE: VERTICAL AT 3 M								
NO.	FREQ. (MHz)	EMISSION LEVEL (dBuV/m)	LIMIT (dBuV/m)	MARGIN (dB)	ANTENNA HEIGHT (m)	TABLE ANGLE (Degree)	RAW VALUE (dBuV)	CORRECTION FACTOR (dB/m)
1	43.51	21.7 QP	40.0	-18.3	1.00 V	151	7.30	14.40
2	66.84	24.7 QP	40.0	-15.3	1.00 V	31	12.30	12.40
3	82.40	23.5 QP	40.0	-16.5	3.00 V	310	14.40	9.10
4	131.00	25.3 QP	43.5	-18.2	1.00 V	100	11.90	13.40
5	177.67	24.3 QP	43.5	-19.2	2.00 V	49	11.60	12.70
6	333.21	25.5 QP	46.0	-20.5	1.00 V	334	9.80	15.70

- REMARKS:**
1. Emission level (dBuV/m) = Raw Value (dBuV) + Correction Factor (dB/m).
 2. Correction Factor (dB/m) = Antenna Factor (dB/m) + Cable Factor (dB).
 3. The other emission levels were very low against the limit.
 4. Margin value = Emission level – Limit value.



A D T

EUT TEST CONDITION		MEASUREMENT DETAIL	
CHANNEL	Channel 11	FREQUENCY RANGE	Below 1000MHz
INPUT POWER (SYSTEM)	120Vac, 60 Hz	DETECTOR FUNCTION	Quasi-Peak
ENVIRONMENTAL CONDITIONS	25deg. C, 65%RH	TESTED BY	Kay Wu
TEST MODE	A		

ANTENNA POLARITY & TEST DISTANCE: HORIZONTAL AT 3 M								
NO.	FREQ. (MHz)	EMISSION LEVEL (dBuV/m)	LIMIT (dBuV/m)	MARGIN (dB)	ANTENNA HEIGHT (m)	TABLE ANGLE (Degree)	RAW VALUE (dBuV)	CORRECTION FACTOR (dB/m)
1	82.40	29.7 QP	40.0	-10.3	2.00 H	340	20.60	9.10
2	140.72	30.3 QP	43.5	-13.2	2.00 H	127	16.20	14.10
3	179.61	28.7 QP	43.5	-14.8	1.50 H	106	16.10	12.60
4	284.60	27.5 QP	46.0	-18.5	1.50 H	16	13.20	14.30
5	321.54	25.5 QP	46.0	-20.5	1.00 H	10	10.00	15.50
6	453.75	18.8 QP	46.0	-27.2	2.00 H	262	-0.10	18.90

ANTENNA POLARITY & TEST DISTANCE: VERTICAL AT 3 M								
NO.	FREQ. (MHz)	EMISSION LEVEL (dBuV/m)	LIMIT (dBuV/m)	MARGIN (dB)	ANTENNA HEIGHT (m)	TABLE ANGLE (Degree)	RAW VALUE (dBuV)	CORRECTION FACTOR (dB/m)
1	59.06	24.7 QP	40.0	-15.3	1.00 V	181	11.40	13.30
2	84.34	21.7 QP	40.0	-18.3	1.00 V	70	12.80	8.90
3	138.78	25.6 QP	43.5	-17.9	1.50 V	85	11.60	14.00
4	179.61	24.0 QP	43.5	-19.5	1.50 V	112	11.40	12.60
5	243.77	20.8 QP	46.0	-25.2	1.50 V	115	8.10	12.70
6	348.76	25.4 QP	46.0	-20.6	1.50 V	10	9.30	16.10

- REMARKS:**
1. Emission level (dBuV/m) = Raw Value (dBuV) + Correction Factor (dB/m).
 2. Correction Factor (dB/m) = Antenna Factor (dB/m) + Cable Factor (dB).
 3. The other emission levels were very low against the limit.
 4. Margin value = Emission level – Limit value.



A D T

802.11n (20MHz)

EUT TEST CONDITION		MEASUREMENT DETAIL	
CHANNEL	Channel 1	FREQUENCY RANGE	Below 1000MHz
INPUT POWER (SYSTEM)	120Vac, 60 Hz	DETECTOR FUNCTION	Quasi-Peak
ENVIRONMENTAL CONDITIONS	25deg. C, 65%RH	TESTED BY	Kay Wu
TEST MODE	A		

ANTENNA POLARITY & TEST DISTANCE: HORIZONTAL AT 3 M								
NO.	FREQ. (MHz)	EMISSION LEVEL (dBuV/m)	LIMIT (dBuV/m)	MARGIN (dB)	ANTENNA HEIGHT (m)	TABLE ANGLE (Degree)	RAW VALUE (dBuV)	CORRECTION FACTOR (dB/m)
1	82.40	25.1 QP	40.0	-14.9	1.00 H	10	16.00	9.10
2	131.00	23.6 QP	43.5	-19.9	1.00 H	61	10.20	13.40
3	177.67	23.1 QP	43.5	-20.4	1.00 H	49	10.40	12.70
4	243.77	24.7 QP	46.0	-21.3	1.00 H	40	12.00	12.70
5	280.71	25.3 QP	46.0	-20.7	1.00 H	10	11.10	14.20
6	342.93	24.5 QP	46.0	-21.5	1.00 H	52	8.50	16.00

ANTENNA POLARITY & TEST DISTANCE: VERTICAL AT 3 M								
NO.	FREQ. (MHz)	EMISSION LEVEL (dBuV/m)	LIMIT (dBuV/m)	MARGIN (dB)	ANTENNA HEIGHT (m)	TABLE ANGLE (Degree)	RAW VALUE (dBuV)	CORRECTION FACTOR (dB/m)
1	35.73	22.3 QP	40.0	-17.7	1.00 V	142	9.60	12.70
2	70.73	19.1 QP	40.0	-20.9	2.00 V	100	7.30	11.80
3	101.84	19.7 QP	43.5	-23.8	1.00 V	196	9.30	10.40
4	136.84	19.2 QP	43.5	-24.3	2.00 V	109	5.30	13.90
5	183.50	18.1 QP	43.5	-25.4	1.00 V	73	5.90	12.20
6	234.05	20.5 QP	46.0	-25.5	2.00 V	55	8.30	12.20

- REMARKS:**
1. Emission level (dBuV/m) = Raw Value (dBuV) + Correction Factor (dB/m).
 2. Correction Factor (dB/m) = Antenna Factor (dB/m) + Cable Factor (dB).
 3. The other emission levels were very low against the limit.
 4. Margin value = Emission level – Limit value.



A D T

EUT TEST CONDITION		MEASUREMENT DETAIL	
CHANNEL	Channel 6	FREQUENCY RANGE	Below 1000MHz
INPUT POWER (SYSTEM)	120Vac, 60 Hz	DETECTOR FUNCTION	Quasi-Peak
ENVIRONMENTAL CONDITIONS	25deg. C, 65%RH	TESTED BY	Kay Wu
TEST MODE	A		

ANTENNA POLARITY & TEST DISTANCE: HORIZONTAL AT 3 M								
NO.	FREQ. (MHz)	EMISSION LEVEL (dBuV/m)	LIMIT (dBuV/m)	MARGIN (dB)	ANTENNA HEIGHT (m)	TABLE ANGLE (Degree)	RAW VALUE (dBuV)	CORRECTION FACTOR (dB/m)
1	82.40	15.3 QP	40.0	-24.7	1.00 H	166	6.20	9.10
2	132.95	22.7 QP	43.5	-20.8	1.00 H	160	9.20	13.50
3	156.28	21.1 QP	43.5	-22.4	1.00 H	136	6.40	14.70
4	249.60	22.3 QP	46.0	-23.7	1.00 H	106	9.30	13.00
5	319.60	22.1 QP	46.0	-23.9	1.00 H	10	6.70	15.40
6	492.64	20.2 QP	46.0	-25.8	1.00 H	19	0.20	20.00

ANTENNA POLARITY & TEST DISTANCE: VERTICAL AT 3 M								
NO.	FREQ. (MHz)	EMISSION LEVEL (dBuV/m)	LIMIT (dBuV/m)	MARGIN (dB)	ANTENNA HEIGHT (m)	TABLE ANGLE (Degree)	RAW VALUE (dBuV)	CORRECTION FACTOR (dB/m)
1	29.90	19.4 QP	40.0	-20.6	1.00 V	136	6.90	12.50
2	96.01	16.4 QP	43.5	-27.1	1.00 V	10	6.80	9.60
3	134.89	19.2 QP	43.5	-24.3	1.00 V	10	5.50	13.70
4	185.44	18.1 QP	43.5	-25.4	1.00 V	61	6.10	12.00
5	296.27	17.0 QP	46.0	-29.0	1.00 V	277	2.20	14.80
6	339.04	21.5 QP	46.0	-24.5	1.00 V	310	5.60	15.90

- REMARKS:**
1. Emission level (dBuV/m) = Raw Value (dBuV) + Correction Factor (dB/m).
 2. Correction Factor (dB/m) = Antenna Factor (dB/m) + Cable Factor (dB).
 3. The other emission levels were very low against the limit.
 4. Margin value = Emission level – Limit value.



A D T

EUT TEST CONDITION		MEASUREMENT DETAIL	
CHANNEL	Channel 11	FREQUENCY RANGE	Below 1000MHz
INPUT POWER (SYSTEM)	120Vac, 60 Hz	DETECTOR FUNCTION	Quasi-Peak
ENVIRONMENTAL CONDITIONS	25deg. C, 65%RH	TESTED BY	Kay Wu
TEST MODE	A		

ANTENNA POLARITY & TEST DISTANCE: HORIZONTAL AT 3 M								
NO.	FREQ. (MHz)	EMISSION LEVEL (dBuV/m)	LIMIT (dBuV/m)	MARGIN (dB)	ANTENNA HEIGHT (m)	TABLE ANGLE (Degree)	RAW VALUE (dBuV)	CORRECTION FACTOR (dB/m)
1	82.40	26.0 QP	40.0	-14.0	1.00 H	16	16.90	9.10
2	134.89	29.6 QP	43.5	-13.9	1.00 H	79	15.90	13.70
3	179.61	27.5 QP	43.5	-16.0	1.00 H	97	14.90	12.60
4	245.72	28.0 QP	46.0	-18.0	1.00 H	40	15.20	12.80
5	286.55	29.2 QP	46.0	-16.8	1.00 H	10	14.80	14.40
6	335.15	26.5 QP	46.0	-19.5	1.00 H	28	10.70	15.80

ANTENNA POLARITY & TEST DISTANCE: VERTICAL AT 3 M								
NO.	FREQ. (MHz)	EMISSION LEVEL (dBuV/m)	LIMIT (dBuV/m)	MARGIN (dB)	ANTENNA HEIGHT (m)	TABLE ANGLE (Degree)	RAW VALUE (dBuV)	CORRECTION FACTOR (dB/m)
1	45.45	21.4 QP	40.0	-18.6	1.00 V	154	7.00	14.40
2	64.90	22.9 QP	40.0	-17.1	1.00 V	307	10.30	12.60
3	82.40	22.1 QP	40.0	-17.9	1.00 V	28	13.00	9.10
4	132.95	25.3 QP	43.5	-18.2	1.00 V	166	11.80	13.50
5	183.50	24.4 QP	43.5	-19.1	1.00 V	106	12.20	12.20
6	340.99	26.4 QP	46.0	-19.6	1.00 V	43	10.50	15.90

- REMARKS:**
1. Emission level (dBuV/m) = Raw Value (dBuV) + Correction Factor (dB/m).
 2. Correction Factor (dB/m) = Antenna Factor (dB/m) + Cable Factor (dB).
 3. The other emission levels were very low against the limit.
 4. Margin value = Emission level – Limit value.

4.2 CONDUCTED EMISSION MEASUREMENT

4.2.1 LIMITS OF CONDUCTED EMISSION MEASUREMENT

FREQUENCY OF EMISSION (MHz)	CONDUCTED LIMIT (dB μ V)	
	Quasi-peak	Average
0.15 ~ 0.5	66 to 56	56 to 46
0.5 ~ 5	56	46
5 ~ 30	60	50

- NOTE:**
1. The lower limit shall apply at the transition frequencies.
 2. The limit decreases in line with the logarithm of the frequency in the range of 0.15 to 0.50MHz.
 3. All emanations from a class A/B digital device or system, including any network of conductors and apparatus connected thereto, shall not exceed the level of field strengths specified above.

4.2.2 TEST INSTRUMENTS

DESCRIPTION & MANUFACTURER	MODEL NO.	SERIAL NO.	DATE OF CALIBRATION	DUE DATE OF CALIBRATION
Test Receiver ROHDE & SCHWARZ	ESCS30	100291	Nov. 30, 2010	Nov. 29, 2011
RF signal cable Woken	5D-FB	Cable-HYC01-01	Dec. 30, 2010	Dec. 29, 2011
LISN ROHDE & SCHWARZ	ESH3-Z5	100312	Jul. 07, 2011	Jul. 06, 2012
LISN ROHDE & SCHWARZ	ESH2-Z5	100100	Jan. 06, 2011	Jan. 05, 2012
LISN ROHDE & SCHWARZ	ESH3-Z5	835239/001	Feb. 22, 2011	Feb. 21, 2012
V-LISN SCHWARZBECK	NNBL 8226-2	8226-142	Jun. 30, 2011	Jun. 29, 2012
LISN ROHDE & SCHWARZ	ENV216	100072	Jun. 10, 2011	Jun. 09, 2012
Software ADT	ADT_Cond_ V7.3.7	NA	NA	NA

- NOTE:**
1. The calibration interval of the above test instruments is 12 months and the calibrations are traceable to NML/ROC and NIST/USA.
 2. The test was performed in HwaYa Shielded Room 1.
 3. The VCCI Site Registration No. is C-2040.

4.2.3 TEST PROCEDURES

- a. The EUT was placed 0.4 meters from the conducting wall of the shielded room with EUT being connected to the power mains through a line impedance stabilization network (LISN). Other support units were connected to the power mains through another LISN. The two LISNs provide 50 ohm/ 50uH of coupling impedance for the measuring instrument.
- b. Both lines of the power mains connected to the EUT were checked for maximum conducted interference.
- c. The frequency range from 150kHz to 30MHz was searched. Emission levels under (Limit - 20dB) was not recorded.

NOTE: All modes of operation were investigated and the worst-case emissions are reported.

4.2.4 DEVIATION FROM TEST STANDARD

No deviation.

4.2.5 TEST SETUP

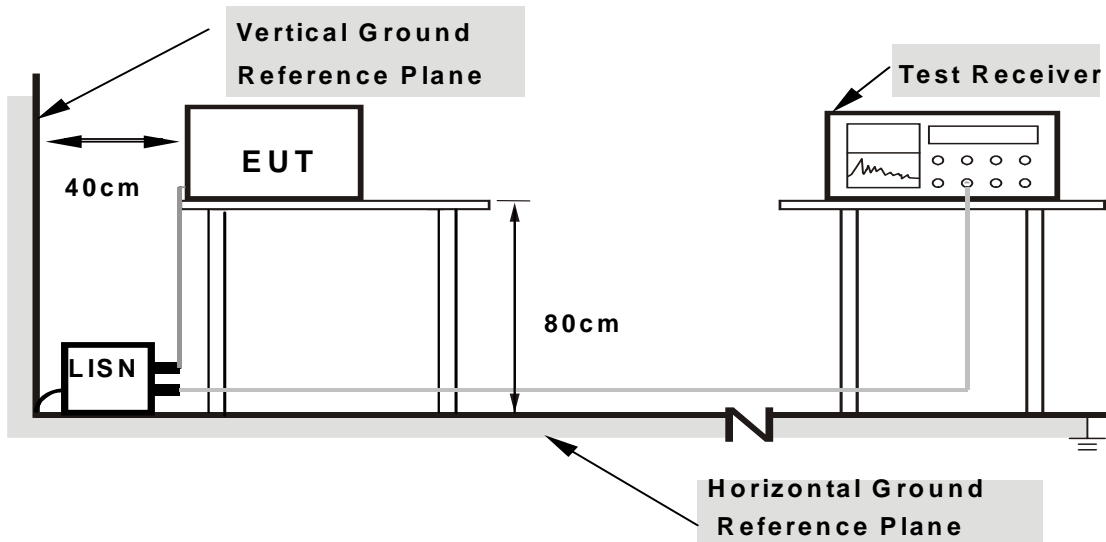

Note: 1. Support units were connected to second LISN.

2. Both of LISNs (AMN) are 80 cm from EUT and at least 80 from other units and other metal planes

For the actual test configuration, please refer to the attached file (Test Setup Photo).

4.2.6 EUT OPERATING CONDITIONS

Same as 4.1.6.



A D T

4.2.7 TEST RESULTS

CONDUCTED WORST-CASE DATA : 802.11g

PHASE	Line 1	6dB BANDWIDTH	9 kHz
TEST MODE	A		

No	Freq. [MHz]	Corr. Factor (dB)	Reading Value [dB (uV)]		Emission Level [dB (uV)]		Limit [dB (uV)]		Margin (dB)	
			Q.P.	AV.	Q.P.	AV.	Q.P.	AV.	Q.P.	AV.
1	0.201	0.12	47.07	-	47.19	-	63.58	53.58	-16.39	-
2	0.291	0.12	47.30	-	47.42	-	60.51	50.51	-13.09	-
3	0.516	0.13	43.76	-	43.89	-	56.00	46.00	-12.11	-
4	0.814	0.15	45.89	25.49	46.04	25.64	56.00	46.00	-9.96	-20.36
5	2.391	0.21	35.83	-	36.04	-	56.00	46.00	-19.96	-
6	15.336	0.89	28.81	-	29.70	-	60.00	50.00	-30.30	-

- REMARKS:**
1. Q.P. and AV. are abbreviations of quasi-peak and average individually.
 2. "-": The Quasi-peak reading value also meets average limit and measurement with the average detector is unnecessary.
 3. The emission levels of other frequencies were very low against the limit.
 4. Margin value = Emission level - Limit value
 5. Correction factor = Insertion loss + Cable loss
 6. Emission Level = Correction Factor + Reading Value.

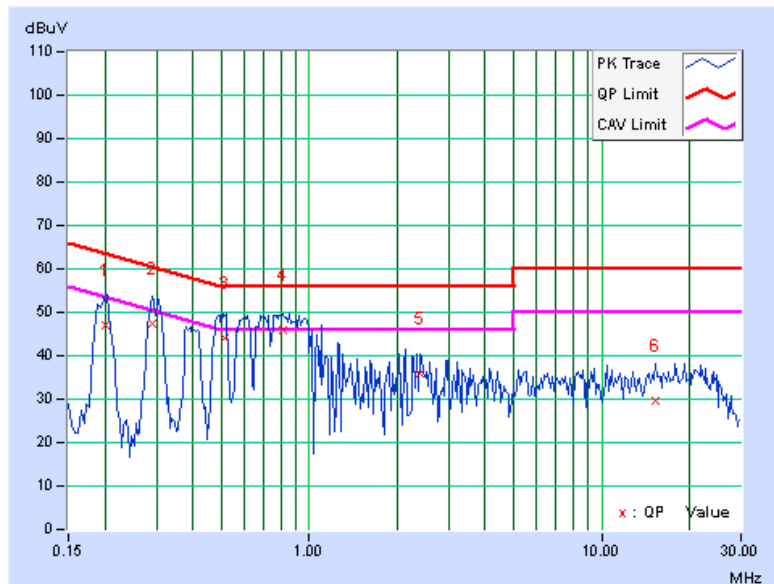



A D T

PHASE	Line 2	6dB BANDWIDTH	9 kHz
TEST MODE	A		

No	Freq. [MHz]	Corr. Factor (dB)	Reading Value		Emission Level		Limit		Margin	
			[dB (uV)]		[dB (uV)]		[dB (uV)]		(dB)	
			Q.P.	AV.	Q.P.	AV.	Q.P.	AV.	Q.P.	AV.
1	0.193	0.13	46.53	-	46.66	-	63.91	53.91	-17.25	-
2	0.295	0.13	47.46	-	47.59	-	60.40	50.40	-12.80	-
3	0.623	0.15	46.32	29.34	46.47	29.49	56.00	46.00	-9.53	-16.51
4	0.814	0.17	46.02	26.12	46.19	26.29	56.00	46.00	-9.81	-19.71
5	2.684	0.24	38.11	-	38.35	-	56.00	46.00	-17.65	-
6	14.141	0.73	30.49	-	31.22	-	60.00	50.00	-28.78	-

- REMARKS:**
1. Q.P. and AV. are abbreviations of quasi-peak and average individually.
 2. "-": The Quasi-peak reading value also meets average limit and measurement with the average detector is unnecessary.
 3. The emission levels of other frequencies were very low against the limit.
 4. Margin value = Emission level - Limit value
 5. Correction factor = Insertion loss + Cable loss
 6. Emission Level = Correction Factor + Reading Value.

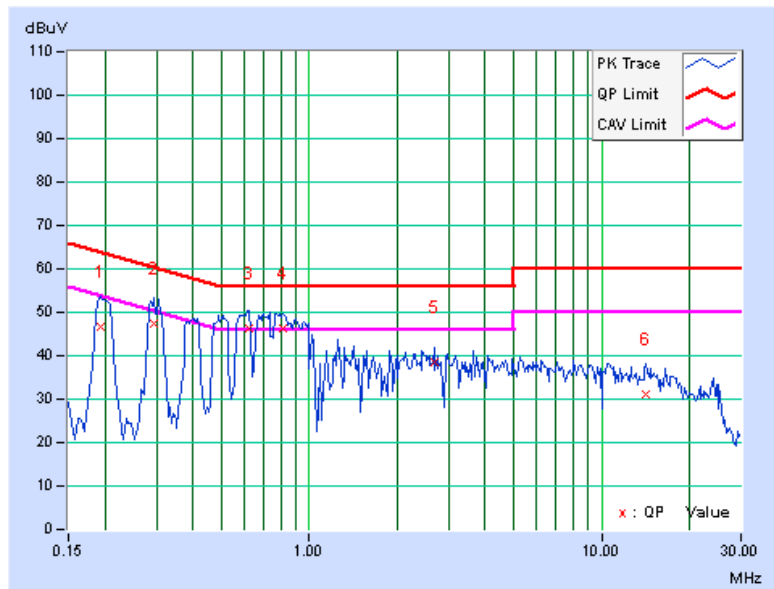



A D T

PHASE	Line 1	6dB BANDWIDTH	9 kHz
TEST MODE	B		

No	Freq. [MHz]	Corr. Factor (dB)	Reading Value		Emission Level		Limit		Margin	
			[dB (uV)]		[dB (uV)]		[dB (uV)]		(dB)	
			Q.P.	AV.	Q.P.	AV.	Q.P.	AV.	Q.P.	AV.
1	0.248	0.12	58.47	42.36	58.59	42.48	61.84	51.84	-3.25	-9.36
2	0.404	0.12	52.84	31.40	52.96	31.52	57.77	47.77	-4.81	-16.25
3	0.533	0.13	48.33	28.74	48.46	28.87	56.00	46.00	-7.54	-17.13
4	0.623	0.13	46.93	26.72	47.06	26.85	56.00	46.00	-8.94	-19.15
5	2.605	0.23	41.09	-	41.32	-	56.00	46.00	-14.68	-
6	23.211	1.28	32.53	-	33.81	-	60.00	50.00	-26.19	-

- REMARKS:**
1. Q.P. and AV. are abbreviations of quasi-peak and average individually.
 2. "-": The Quasi-peak reading value also meets average limit and measurement with the average detector is unnecessary.
 3. The emission levels of other frequencies were very low against the limit.
 4. Margin value = Emission level - Limit value
 5. Correction factor = Insertion loss + Cable loss
 6. Emission Level = Correction Factor + Reading Value.

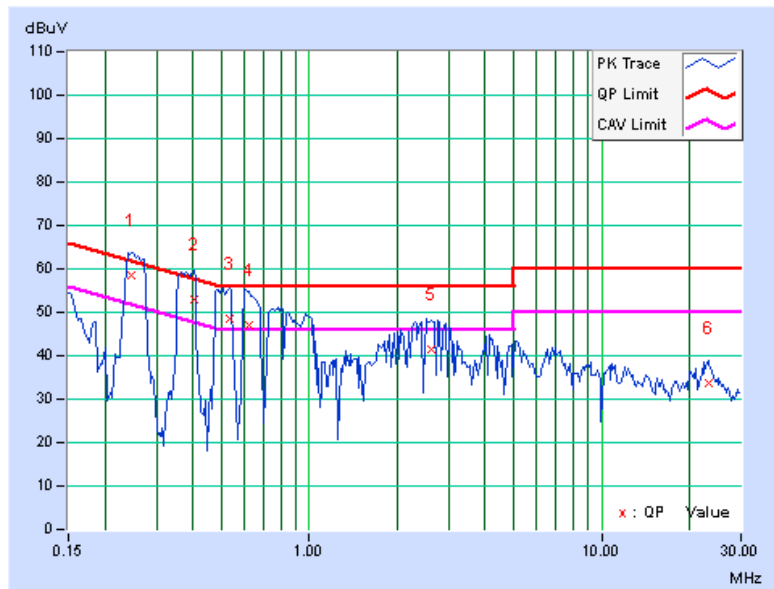



A D T

PHASE	Line 2	6dB BANDWIDTH	9 kHz
TEST MODE	B		

No	Freq. [MHz]	Corr. Factor (dB)	Reading Value		Emission Level		Limit		Margin	
			[dB (uV)]		[dB (uV)]		[dB (uV)]		(dB)	
			Q.P.	AV.	Q.P.	AV.	Q.P.	AV.	Q.P.	AV.
1	0.252	0.13	54.35	38.59	54.48	38.72	61.71	51.71	-7.22	-12.98
2	0.388	0.14	50.79	31.99	50.93	32.13	58.10	48.10	-7.17	-15.97
3	0.541	0.15	47.00	24.60	47.15	24.75	56.00	46.00	-8.85	-21.25
4	0.845	0.17	43.61	-	43.78	-	56.00	46.00	-12.22	-
5	2.633	0.24	41.38	-	41.62	-	56.00	46.00	-14.38	-
6	23.027	1.04	36.03	-	37.07	-	60.00	50.00	-22.93	-

- REMARKS:**
1. Q.P. and AV. are abbreviations of quasi-peak and average individually.
 2. "-": The Quasi-peak reading value also meets average limit and measurement with the average detector is unnecessary.
 3. The emission levels of other frequencies were very low against the limit.
 4. Margin value = Emission level - Limit value
 5. Correction factor = Insertion loss + Cable loss
 6. Emission Level = Correction Factor + Reading Value.

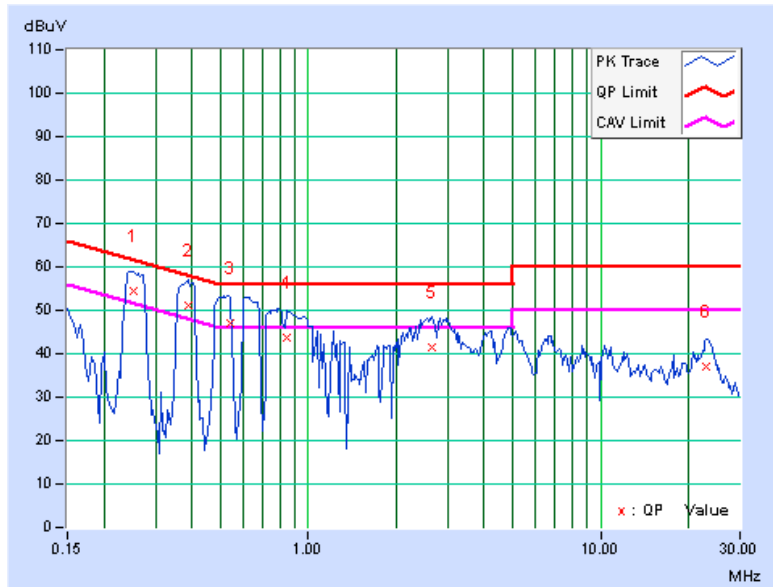



A D T

PHASE	Line 1	6dB BANDWIDTH	9 kHz
TEST MODE	C		

No	Freq. [MHz]	Corr. Factor (dB)	Reading Value		Emission Level		Limit		Margin	
			[dB (uV)]		[dB (uV)]		[dB (uV)]		(dB)	
			Q.P.	AV.	Q.P.	AV.	Q.P.	AV.	Q.P.	AV.
1	0.248	0.12	50.59	-	50.71	-	61.84	51.84	-11.13	-
2	0.380	0.12	47.20	-	47.32	-	58.27	48.27	-10.95	-
3	0.541	0.13	43.97	-	44.10	-	56.00	46.00	-11.90	-
4	0.814	0.15	39.17	-	39.32	-	56.00	46.00	-16.68	-
5	2.652	0.23	39.80	-	40.03	-	56.00	46.00	-15.97	-
6	23.598	1.30	30.37	-	31.67	-	60.00	50.00	-28.33	-

- REMARKS:**
1. Q.P. and AV. are abbreviations of quasi-peak and average individually.
 2. "-": The Quasi-peak reading value also meets average limit and measurement with the average detector is unnecessary.
 3. The emission levels of other frequencies were very low against the limit.
 4. Margin value = Emission level - Limit value
 5. Correction factor = Insertion loss + Cable loss
 6. Emission Level = Correction Factor + Reading Value.

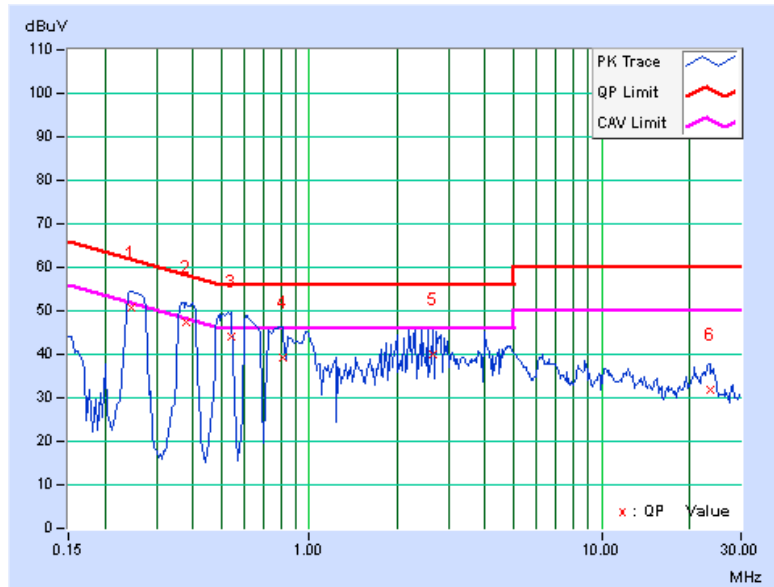



A D T

PHASE	Line 2	6dB BANDWIDTH	9 kHz
TEST MODE	C		

No	Freq. [MHz]	Corr. Factor (dB)	Reading Value		Emission Level		Limit		Margin	
			[dB (uV)]		[dB (uV)]		[dB (uV)]		(dB)	
			Q.P.	AV.	Q.P.	AV.	Q.P.	AV.	Q.P.	AV.
1	0.263	0.13	51.05	-	51.18	-	61.33	51.33	-10.14	-
2	0.392	0.14	48.70	29.70	48.84	29.84	58.02	48.02	-9.18	-18.18
3	0.533	0.15	45.33	-	45.48	-	56.00	46.00	-10.52	-
4	0.845	0.17	42.38	-	42.55	-	56.00	46.00	-13.45	-
5	2.898	0.25	40.93	-	41.18	-	56.00	46.00	-14.82	-
6	23.379	1.05	33.83	-	34.88	-	60.00	50.00	-25.12	-

- REMARKS:**
1. Q.P. and AV. are abbreviations of quasi-peak and average individually.
 2. "-": The Quasi-peak reading value also meets average limit and measurement with the average detector is unnecessary.
 3. The emission levels of other frequencies were very low against the limit.
 4. Margin value = Emission level - Limit value
 5. Correction factor = Insertion loss + Cable loss
 6. Emission Level = Correction Factor + Reading Value.

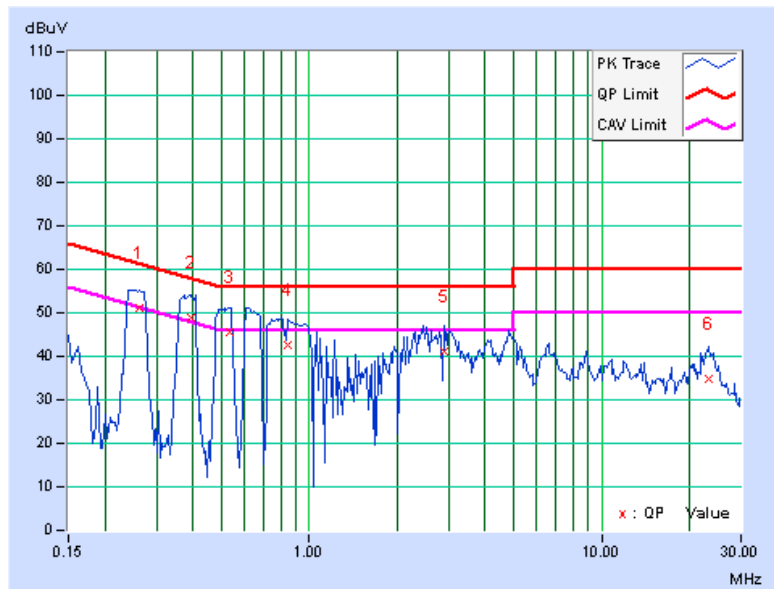



4.3 6dB BANDWIDTH MEASUREMENT

4.3.1 LIMITS OF 6dB BANDWIDTH MEASUREMENT

The minimum of 6dB Bandwidth Measurement is 0.5 MHz.

4.3.2 TEST INSTRUMENTS

DESCRIPTION & MANUFACTURER	MODEL NO.	SERIAL NO.	DATE OF CALIBRATION	DUE DATE OF CALIBRATION
SPECTRUM ANALYZER R&S	FSP40	100039	Feb. 23, 2011	Feb. 22, 2012

NOTE: The calibration interval of the above test instruments is 12 months and the calibrations are traceable to NML/ROC and NIST/USA.

4.3.3 TEST PROCEDURE

The transmitter output was connected to the spectrum analyzer through an attenuator. The bandwidth of the fundamental frequency was measured by spectrum analyzer with 100kHz RBW and 300kHz VBW. The 6dB bandwidth is defined as the total spectrum the power of which is higher than peak power minus 6dB.

4.3.4 DEVIATION FROM TEST STANDARD

No deviation.

4.3.5 TEST SETUP

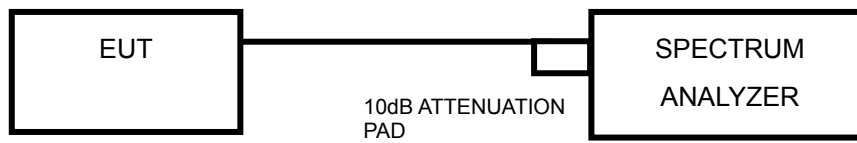

4.3.6 EUT OPERATING CONDITIONS

The software provided by client to enable the EUT under transmission condition continuously at lowest, middle and highest channel frequencies individually.



A D T

4.3.7 TEST RESULTS

802.11b

CHANNEL	CHANNEL FREQUENCY (MHz)	6dB BANDWIDTH (MHz)	MINIMUM LIMIT (MHz)	PASS / FAIL
1	2412	8.62	0.5	PASS
6	2437	9.11	0.5	PASS
11	2462	8.15	0.5	PASS

CH 6

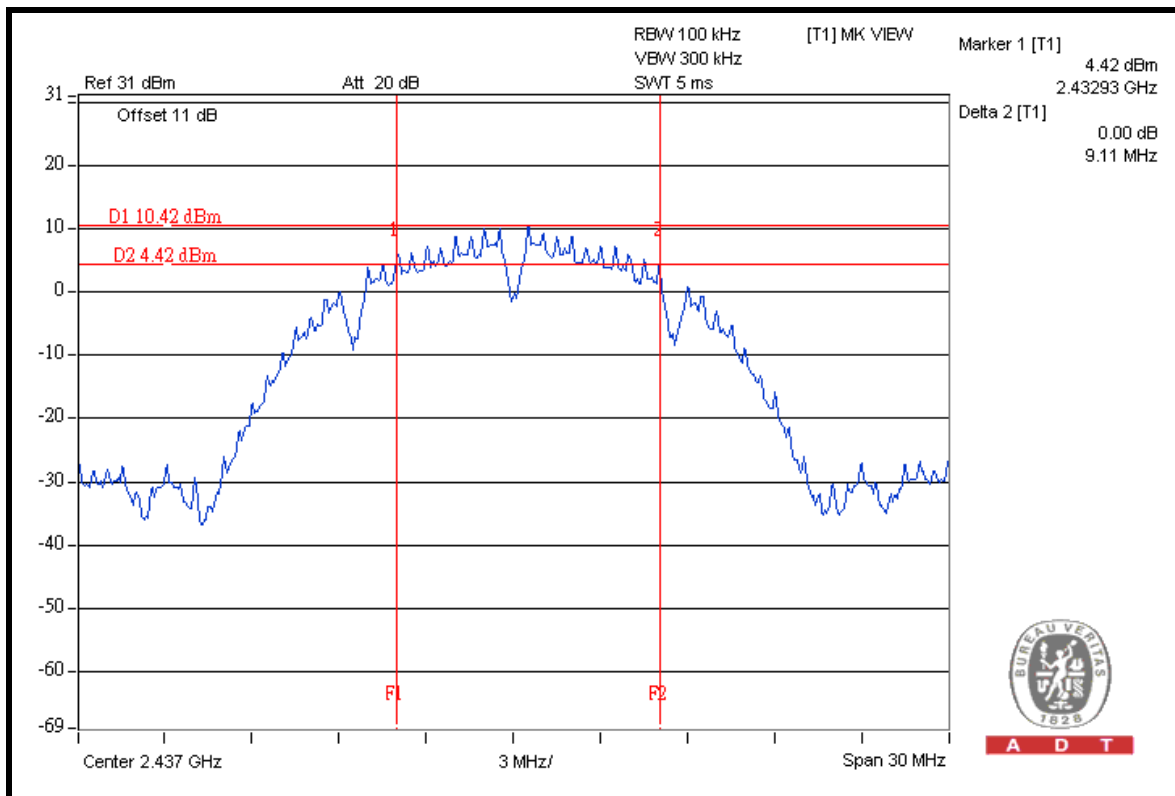



A D T

802.11g

CHANNEL	CHANNEL FREQUENCY (MHz)	6dB BANDWIDTH (MHz)	MINIMUM LIMIT (MHz)	PASS / FAIL
1	2412	15.74	0.5	PASS
6	2437	15.31	0.5	PASS
11	2462	15.84	0.5	PASS

CH 11

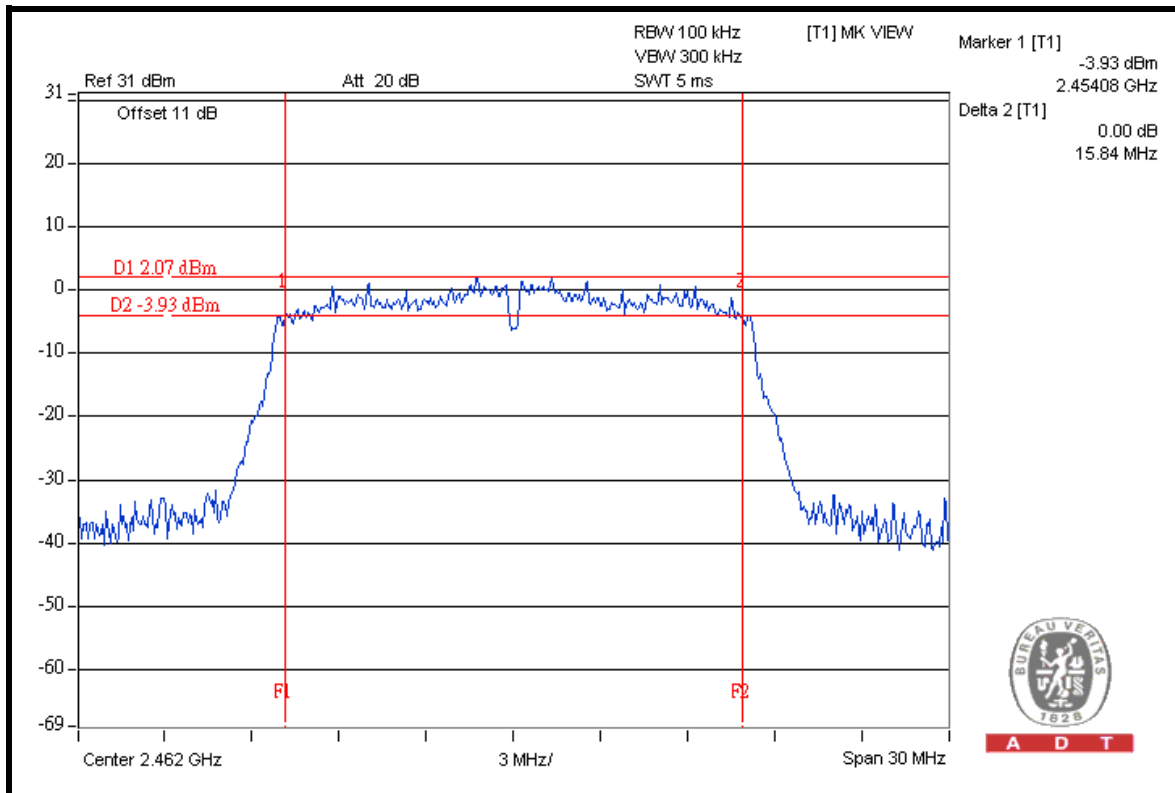



A D T

802.11n (20MHz)

CHANNEL	CHANNEL FREQUENCY (MHz)	6dB BANDWIDTH (MHz)	MINIMUM LIMIT (MHz)	PASS / FAIL
1	2412	16.94	0.5	PASS
6	2437	15.92	0.5	PASS
11	2462	16.04	0.5	PASS

CH 11

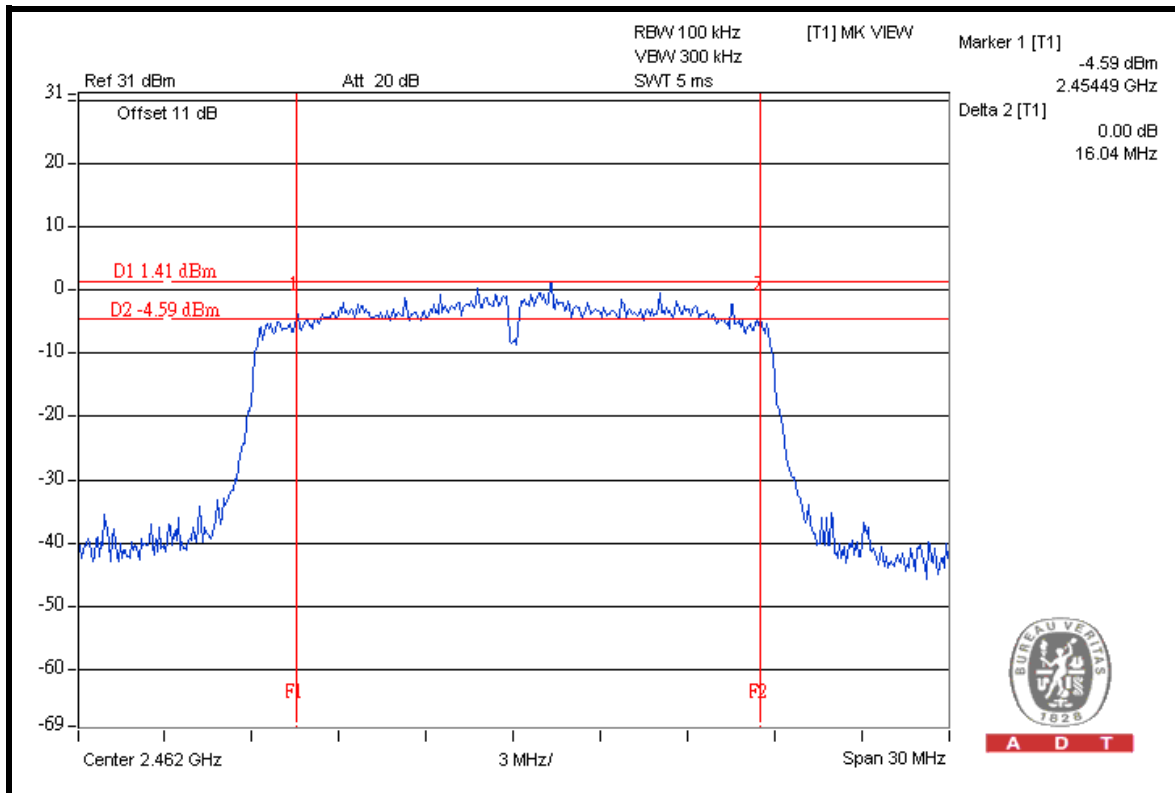



4.4 MAXIMUM OUTPUT POWER

4.4.1 LIMITS OF MAXIMUM OUTPUT POWER MEASUREMENT

The Maximum Output Power Measurement is 30dBm.

4.4.2 INSTRUMENTS

DESCRIPTION & MANUFACTURER	MODEL NO.	SERIAL NO.	DATE OF CALIBRATION	DUE DATE OF CALIBRATION
High Speed Peak Power Meter	ML2495A	0842014	Apr. 26, 2011	Apr. 25, 2012
Power Sensor	MA2411B	0738404	Apr. 26, 2011	Apr. 25, 2012

NOTE:

1. The calibration interval of the above test instruments is 12 months and the calibrations are traceable to NML/ROC and NIST/USA.
2. Measurement Bandwidth of ML2495A is 65MHz greater than 6dB bandwidth of emission.

4.4.3 TEST PROCEDURE

A power sensor was used on the output port of the EUT. A power meter was used to read the response of the power sensor. Record the power level.

4.4.4 DEVIATION FROM TEST STANDARD

No deviation.

4.4.5 TEST SETUP

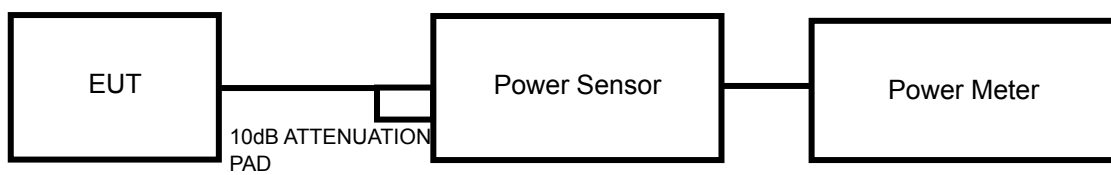

4.4.6 EUT OPERATING CONDITIONS

Same as Item 4.3.6.



4.4.7 TEST RESULTS

802.11b

CHANNEL	CHANNEL FREQUENCY (MHz)	POWER OUTPUT (mW)	POWER OUTPUT (dBm)	POWER LIMIT (dBm)	PASS/FAIL
1	2412	112.2	20.5	30	PASS
6	2437	117.5	20.7	30	PASS
11	2462	114.8	20.6	30	PASS

802.11g

CHANNEL	CHANNEL FREQUENCY (MHz)	POWER OUTPUT (mW)	POWER OUTPUT (dBm)	POWER LIMIT (dBm)	PASS/FAIL
1	2412	151.4	21.8	30	PASS
6	2437	154.9	21.9	30	PASS
11	2462	154.9	21.9	30	PASS

802.11n (20MHz)

CHANNEL	CHANNEL FREQUENCY (MHz)	POWER OUTPUT (mW)	POWER OUTPUT (dBm)	POWER LIMIT (dBm)	PASS/FAIL
1	2412	134.9	21.3	30	PASS
6	2437	128.8	21.1	30	PASS
11	2462	125.9	21.0	30	PASS



4.5 POWER SPECTRAL DENSITY MEASUREMENT

4.5.1 LIMITS OF POWER SPECTRAL DENSITY MEASUREMENT

The Maximum of Power Spectral Density Measurement is 8dBm.

4.5.2 TEST INSTRUMENTS

DESCRIPTION & MANUFACTURER	MODEL NO.	SERIAL NO.	DATE OF CALIBRATION	DUE DATE OF CALIBRATION
SPECTRUM ANALYZER R&S	FSP40	100039	Feb. 23, 2011	Feb. 22, 2012

NOTE: The calibration interval of the above test instruments is 12 months and the calibrations are traceable to NML/ROC and NIST/USA.

4.5.3 TEST PROCEDURE

The transmitter output was connected to the spectrum analyzer through an attenuator, the bandwidth of the fundamental frequency was measured with the spectrum analyzer using 3kHz RBW and 30kHz VBW, set sweep time = span/3kHz. The power spectral density was measured and recorded.

The sweep time is allowed to be longer than span/3kHz for a full response of the mixer in the spectrum analyzer.

4.5.4 DEVIATION FROM TEST STANDARD

No deviation.

4.5.5 TEST SETUP

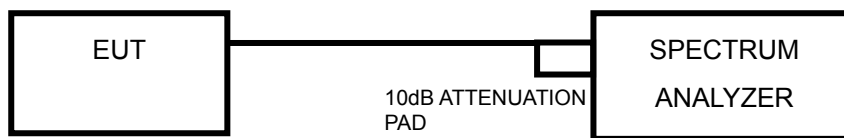

4.5.6 EUT OPERATING CONDITION

Same as Item 4.3.6.



A D T

4.5.7 TEST RESULTS

802.11b

CHANNEL	CHANNEL FREQUENCY (MHz)	RF POWER LEVEL IN 3 kHz BW (dBm)	MAXIMUM LIMIT (dBm)	PASS/FAIL
1	2412	-3.2	8	PASS
6	2437	-2.9	8	PASS
11	2462	-3.0	8	PASS

CH 6

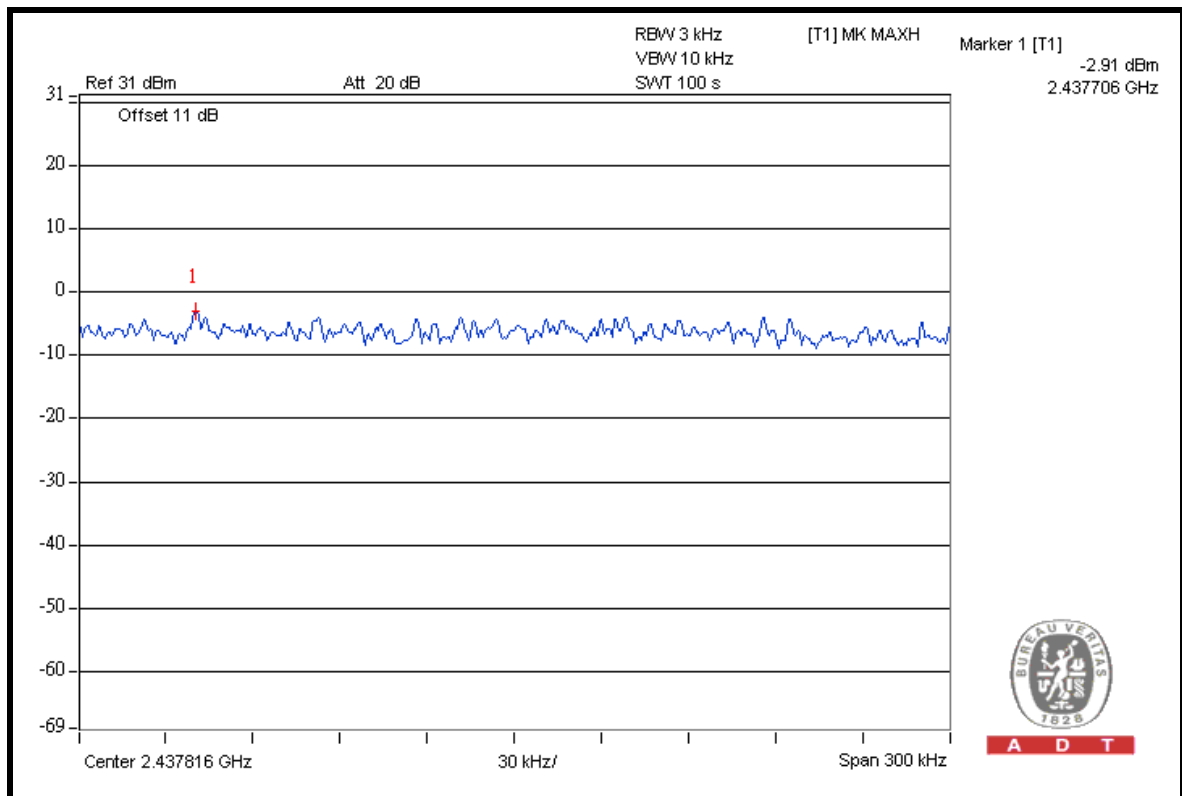

A D T



A D T

802.11g

CHANNEL	CHANNEL FREQUENCY (MHz)	RF POWER LEVEL IN 3 kHz BW (dBm)	MAXIMUM LIMIT (dBm)	PASS/FAIL
1	2412	-10.3	8	PASS
6	2437	-10.3	8	PASS
11	2462	-10.8	8	PASS

CH 6

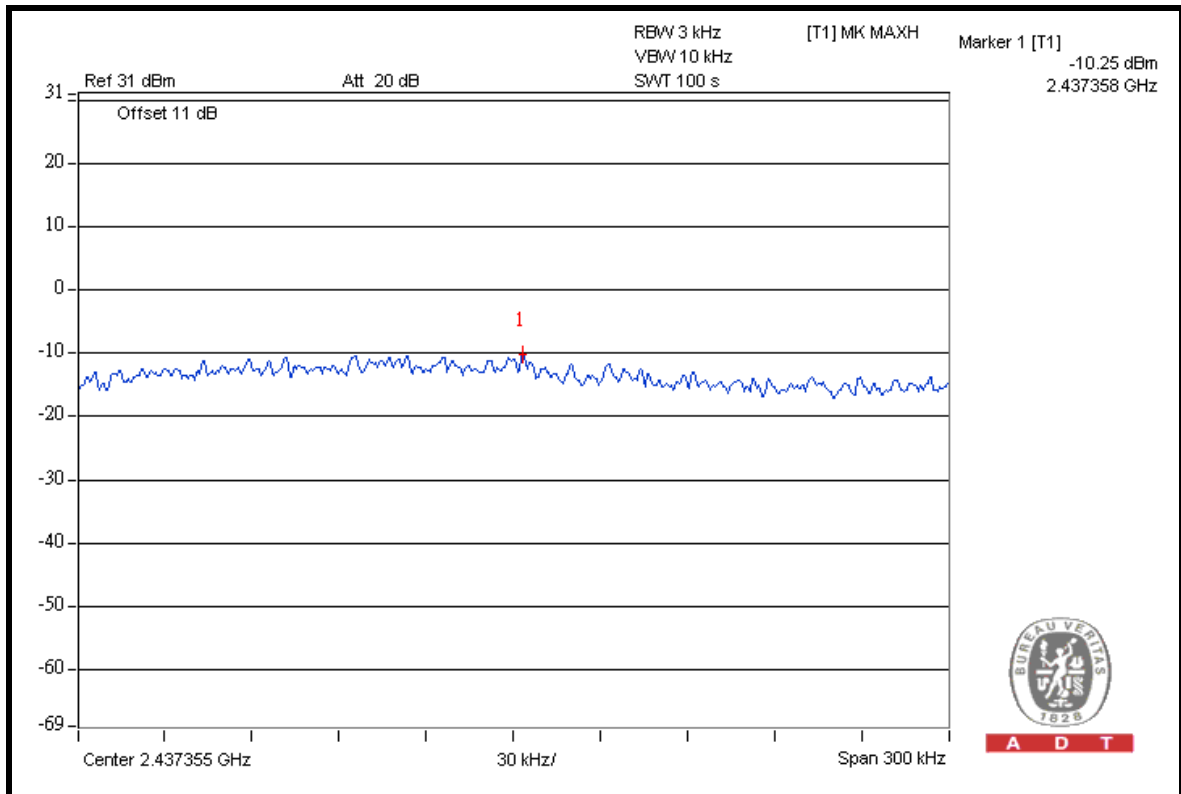



A D T

802.11n (20MHz)

CHANNEL	CHANNEL FREQUENCY (MHz)	RF POWER LEVEL IN 3 kHz BW (dBm)	MAXIMUM LIMIT (dBm)	PASS/FAIL
1	2412	-11.1	8	PASS
6	2437	-11.1	8	PASS
11	2462	-11.3	8	PASS

CH 1

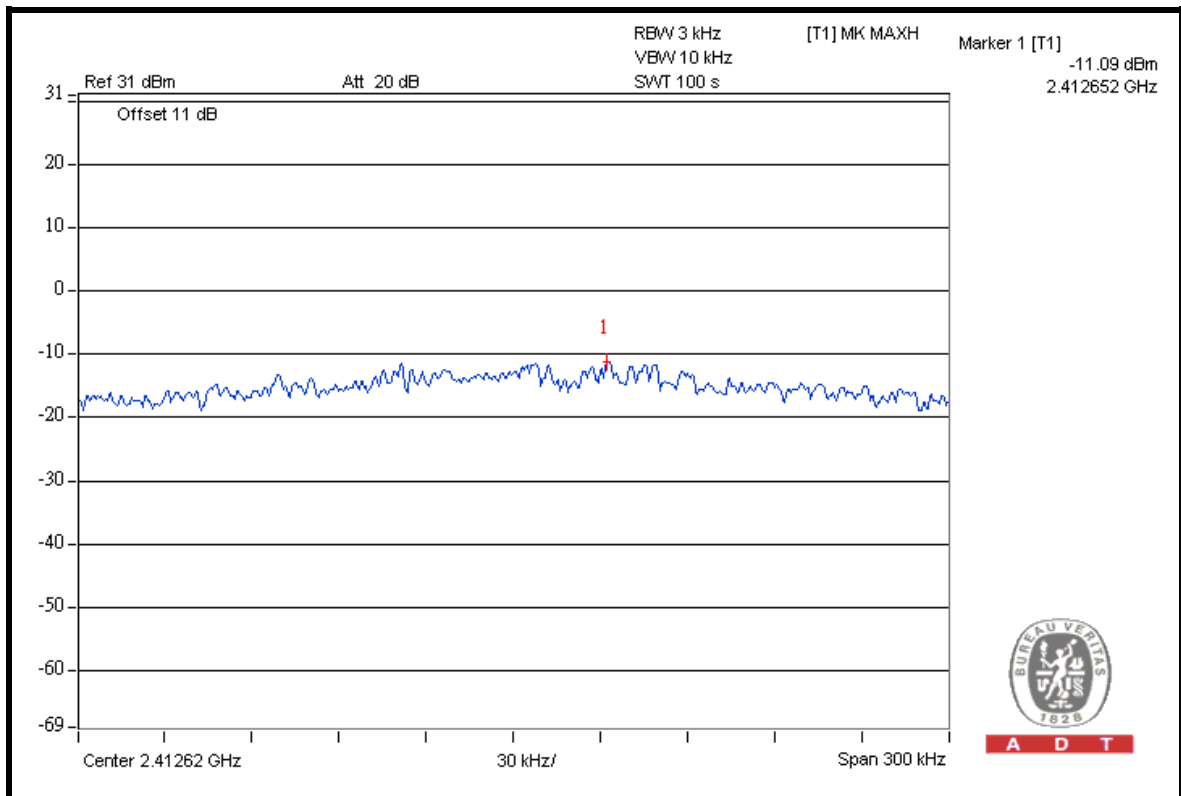

A D T

4.6 BAND EDGES MEASUREMENT

4.6.1 LIMITS OF BAND EDGES MEASUREMENT

Below -20dB of the highest emission level of operating band (in 100kHz Resolution Bandwidth).

Note: Follow DTS measurement, If the device complies with the use of power option 2 the attenuation under this paragraph shall be 30 dB instead of 20 dB.

4.6.2 TEST INSTRUMENTS

DESCRIPTION & MANUFACTURER	MODEL NO.	SERIAL NO.	DATE OF CALIBRATION	DUE DATE OF CALIBRATION
SPECTRUM ANALYZER R&S	FSP40	100039	Feb. 23, 2011	Feb. 22, 2012

NOTE: The calibration interval of the above test instruments is 12 months and the calibrations are traceable to NML/ROC and NIST/USA.

4.6.3 TEST PROCEDURE

The transmitter output was connected to the spectrum analyzer via a low lose cable. Set both RBW and VBW of spectrum analyzer to 100kHz and 300kHz with suitable frequency span including 100MHz bandwidth from band edge. The band edges was measured and recorded.

The spectrum plots (Peak RBW = 100kHz, VBW = 300kHz; Average RBW = 1MHz, VBW = 10Hz) are attached on the following pages.

4.6.4 DEVIATION FROM TEST STANDARD

No deviation.

4.6.5 EUT OPERATING CONDITION

Same as Item 4.3.6.

4.6.6 TEST RESULTS

The spectrum plots are attached on the following pages. D1 line indicates the highest level, and D2 line indicates the 20dB offset below D1. It shows compliance with the requirement in part 15.247(d).

802.11b TEST MODE A

RESTRICT BAND (2310 ~ 2390 MHz)

FREQUENCY (MHz)	FUNDAMENTAL EMISSION (dBuV/m)	DELTA (dB)	MAXIMUM FIELD STRENGTH IN RESTRICT BAND (dBuV/m)	LIMIT (dBuV/m)
2412.00 (PK)	104.6	55.09	49.51	74.00
2412.00 (AV)	100.6	56.74	43.86	54.00

RESTRICT BAND (2483.5 ~ 2500 MHz)

FREQUENCY (MHz)	FUNDAMENTAL EMISSION (dBuV/m)	DELTA (dB)	MAXIMUM FIELD STRENGTH IN RESTRICT BAND (dBuV/m)	LIMIT (dBuV/m)
2462.00 (PK)	103.2	50.76	50.94	74.00
2462.00 (AV)	99.1	51.77	45.83	54.00

TEST MODE C

RESTRICT BAND (2310 ~ 2390 MHz)

FREQUENCY (MHz)	FUNDAMENTAL EMISSION (dBuV/m)	DELTA (dB)	MAXIMUM FIELD STRENGTH IN RESTRICT BAND (dBuV/m)	LIMIT (dBuV/m)
2412.00 (PK)	104.1	55.09	49.01	74.00
2412.00 (AV)	99.8	56.74	43.06	54.00

NOTE:

- Delta = Amplitude between the peak of the fundamental and the peak of the band edge emission. Please check following 3 pages.
- Maximum field strength in restrict band = Fundamental emission – Delta.



A D T

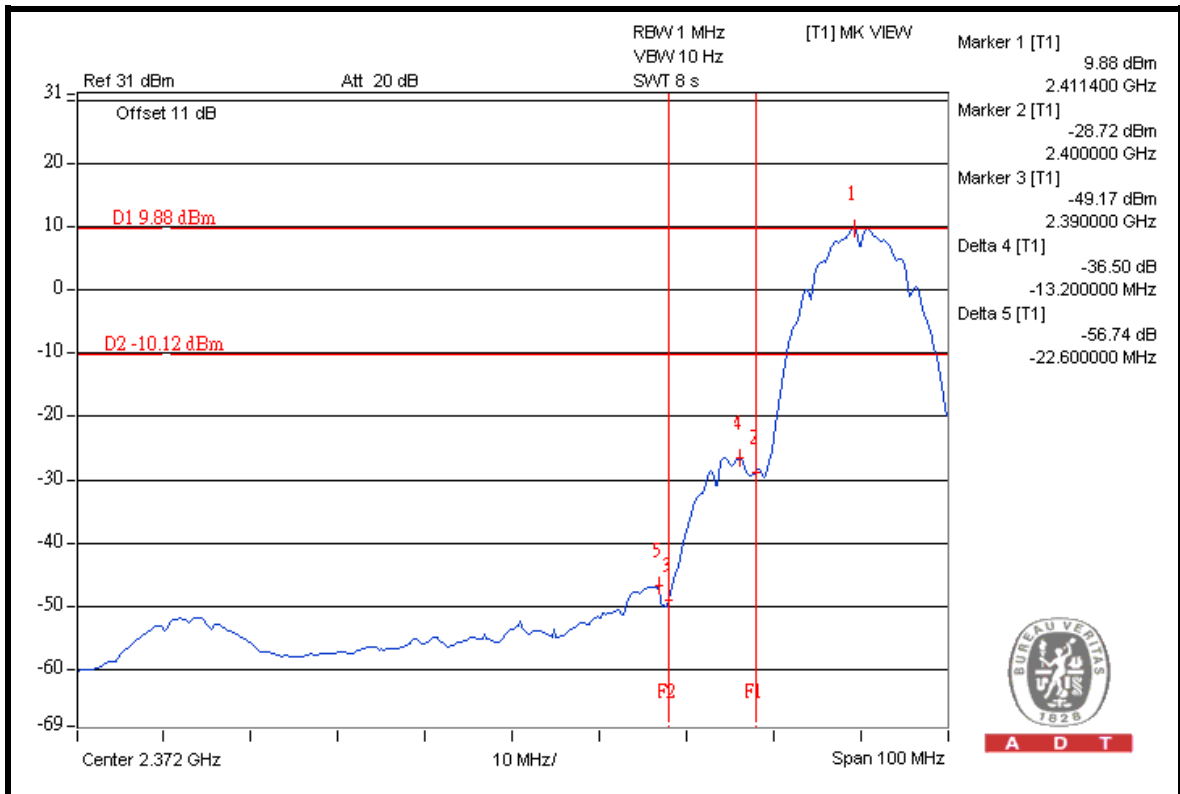
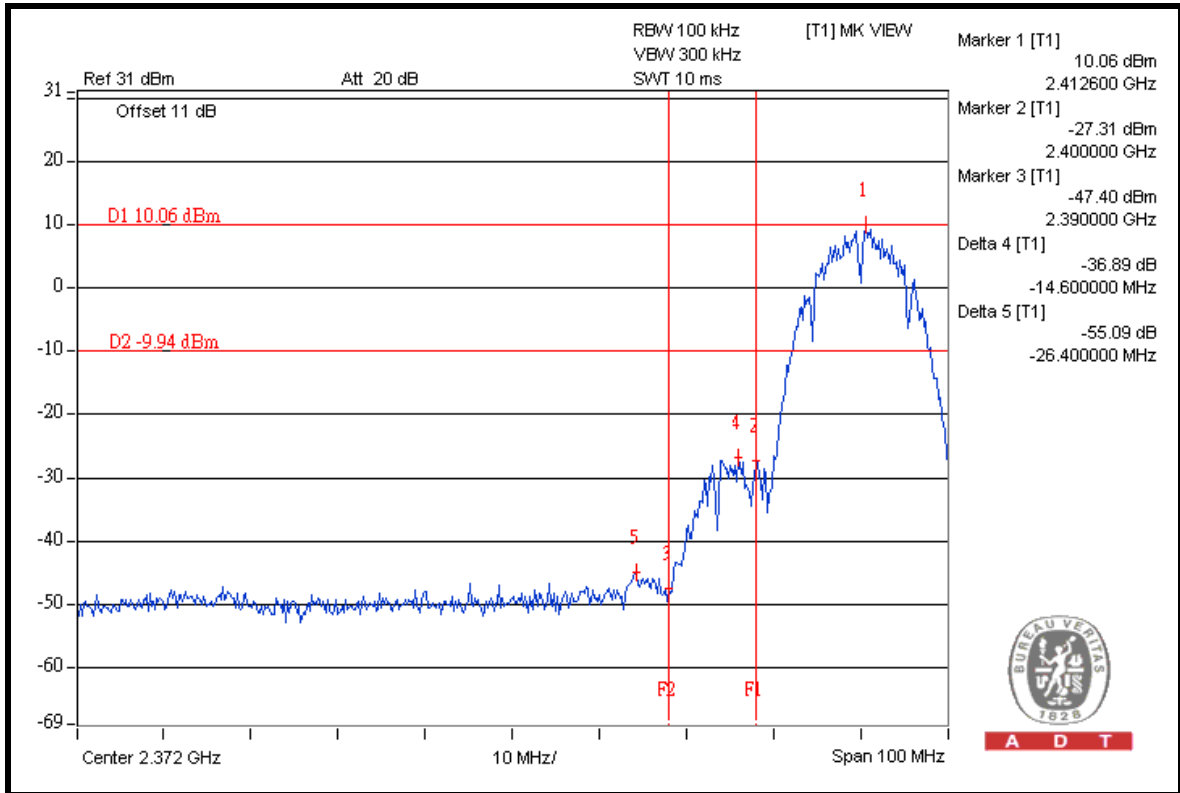



A D T

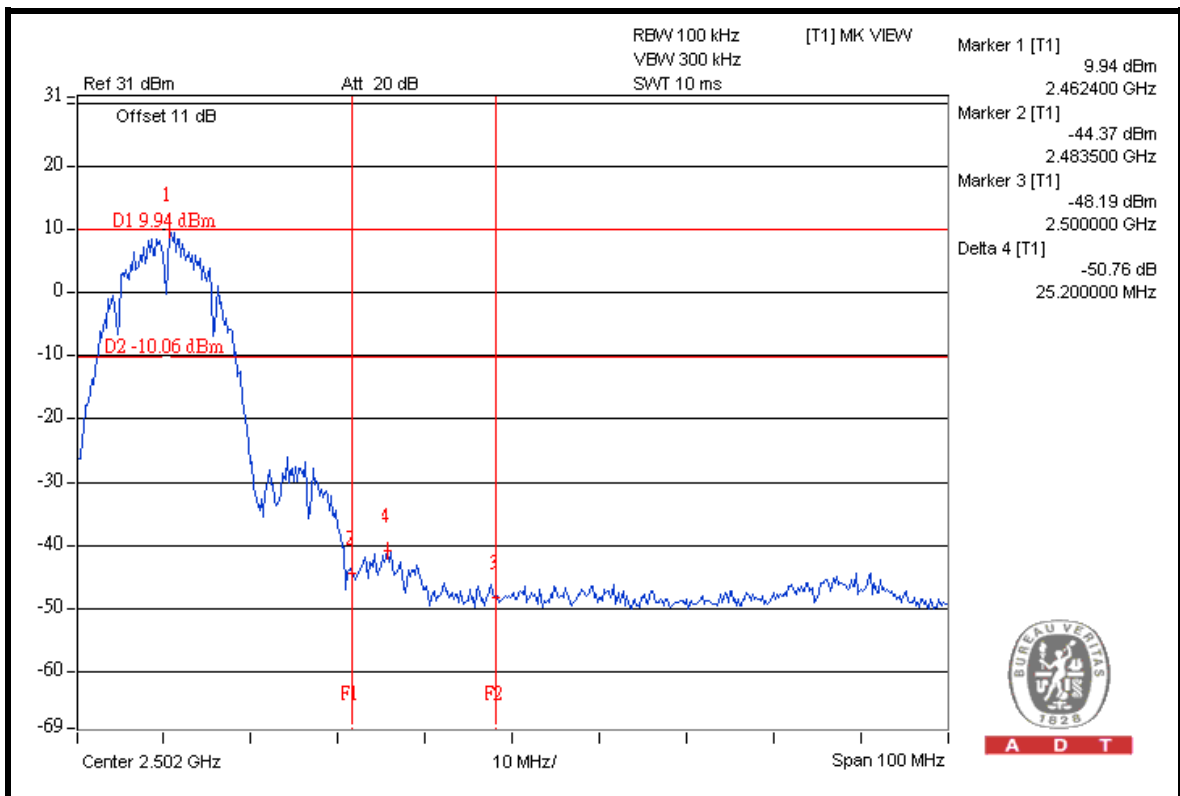
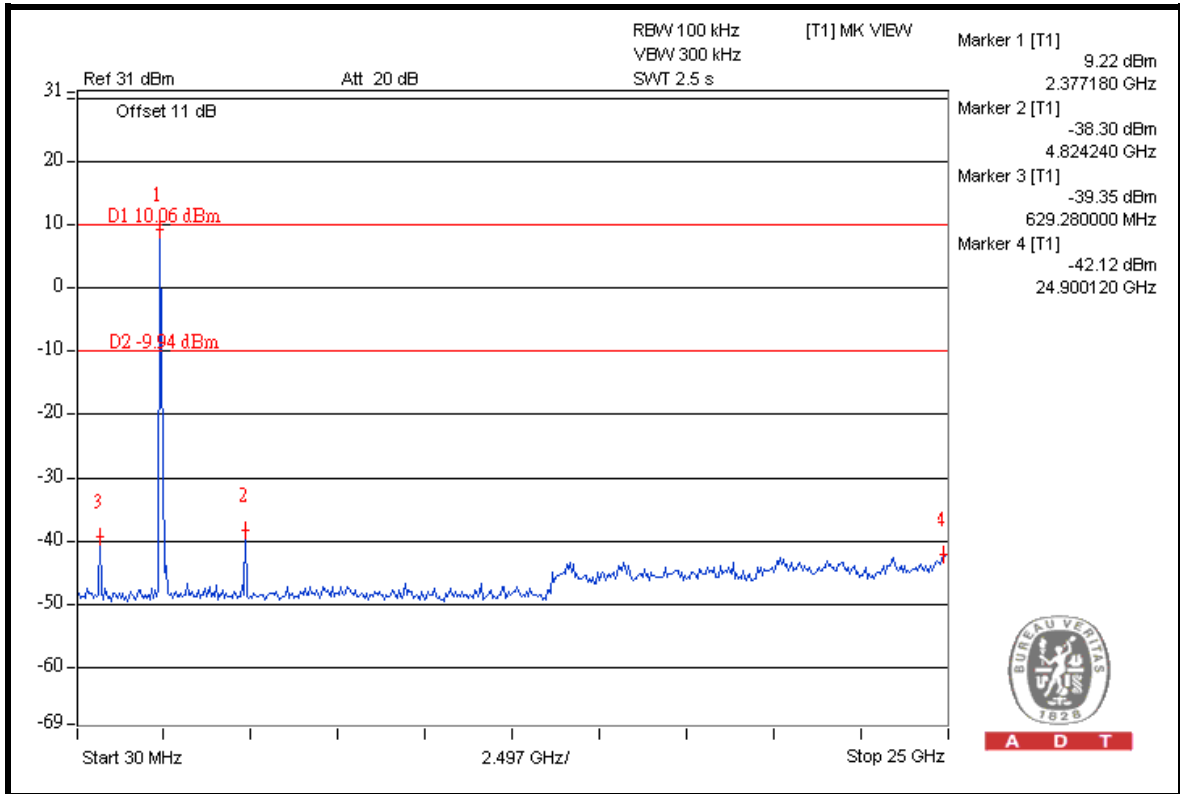



A D T

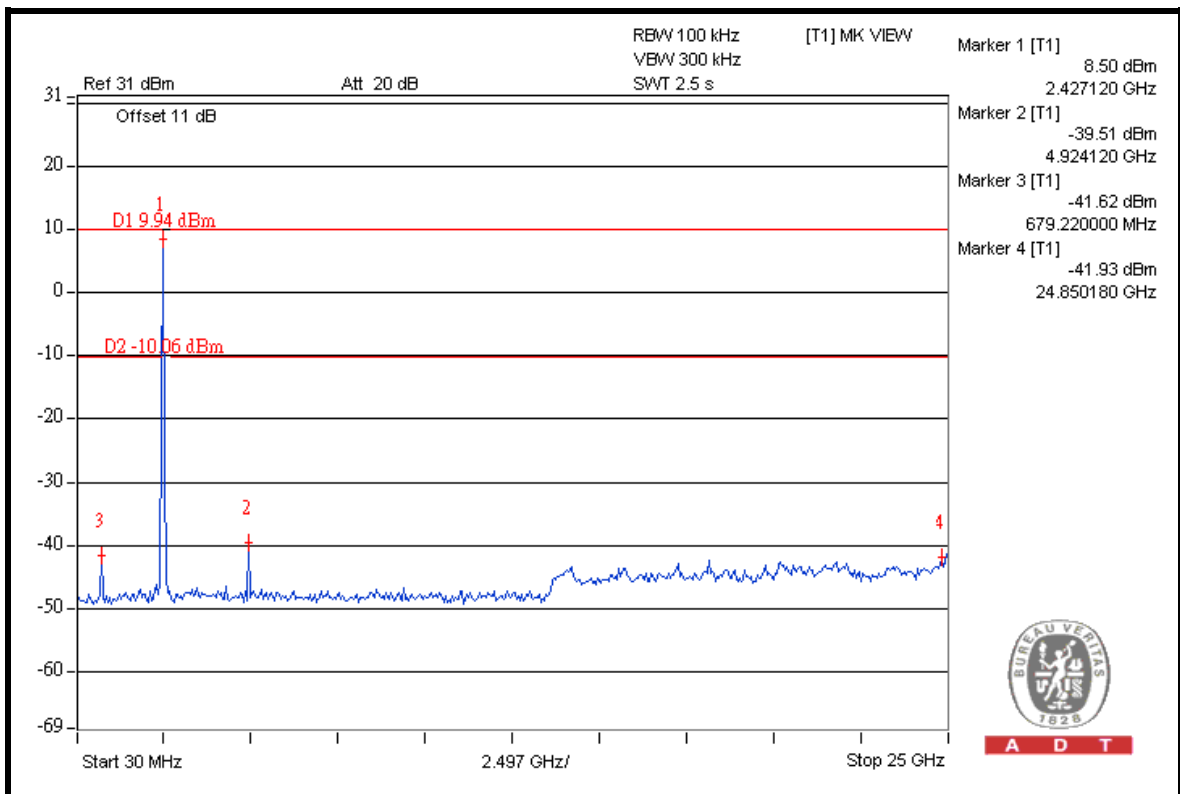
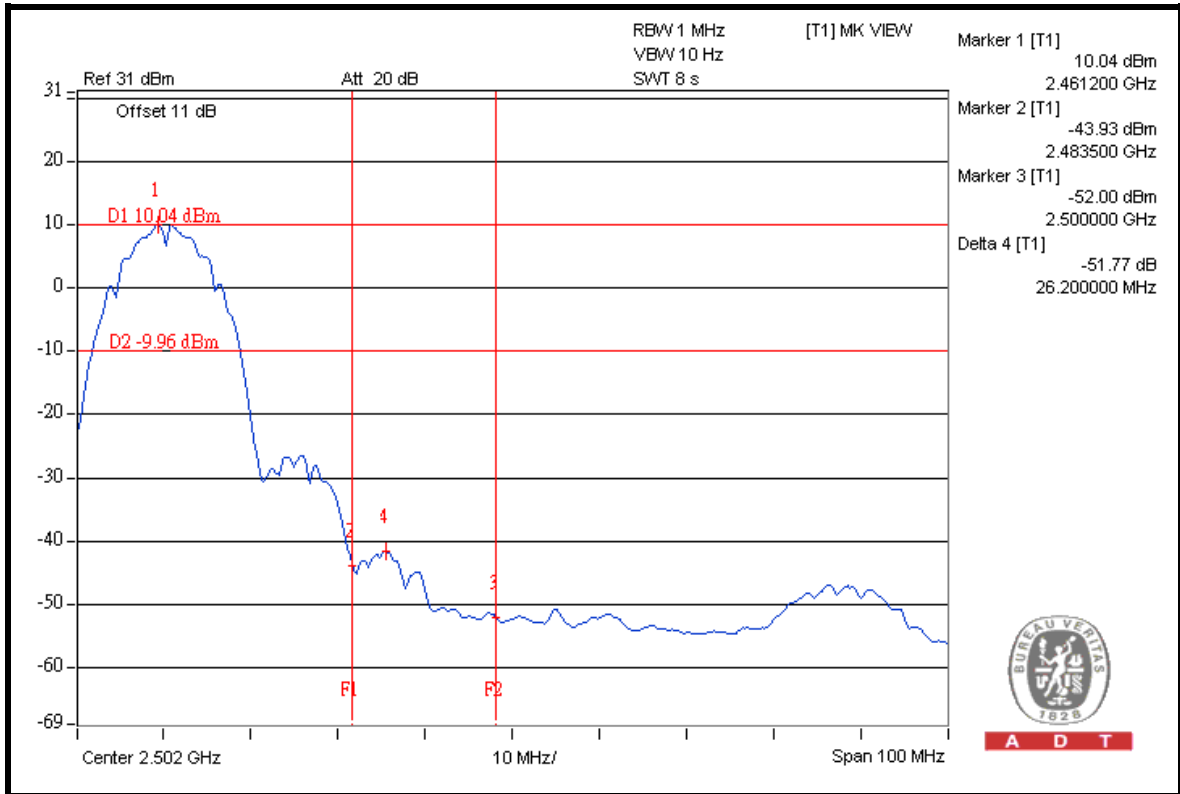

802.11g

RESTRICT BAND (2310 ~ 2390 MHz)

FREQUENCY (MHz)	FUNDAMENTAL EMISSION (dBuV/m)	DELTA (dB)	MAXIMUM FIELD STRENGTH IN RESTRICT BAND (dBuV/m)	LIMIT (dBuV/m)
2412.00 (PK)	105.4	46.18	59.22	74.00
2412.00 (AV)	91.6	47.35	44.25	54.00

RESTRICT BAND (2483.5 ~ 2500 MHz)

FREQUENCY (MHz)	FUNDAMENTAL EMISSION (dBuV/m)	DELTA (dB)	MAXIMUM FIELD STRENGTH IN RESTRICT BAND (dBuV/m)	LIMIT (dBuV/m)
2462.00 (PK)	103.3	43.54	59.76	74.00
2462.00 (AV)	89.1	47.27	41.83	54.00

NOTE:

- Delta = Amplitude between the peak of the fundamental and the peak of the band edge emission. Please check following 3 pages.
- Maximum field strength in restrict band = Fundamental emission – Delta.



A D T

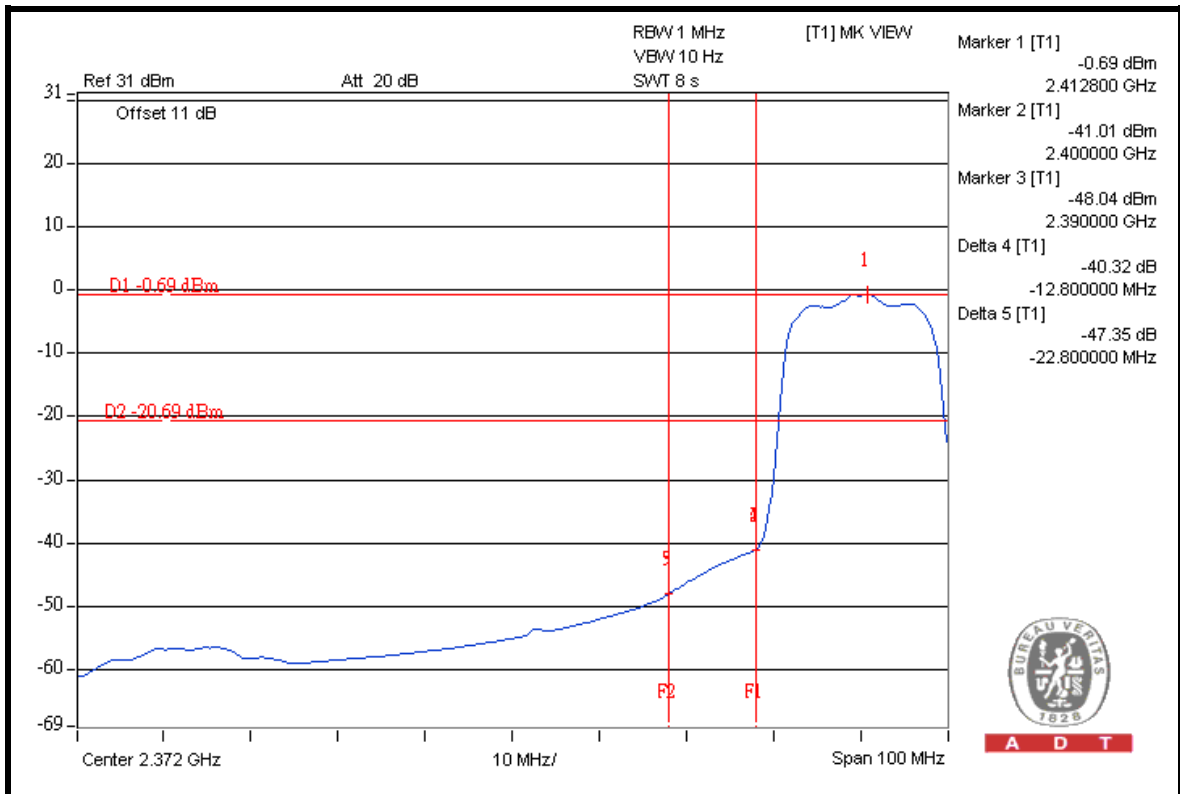
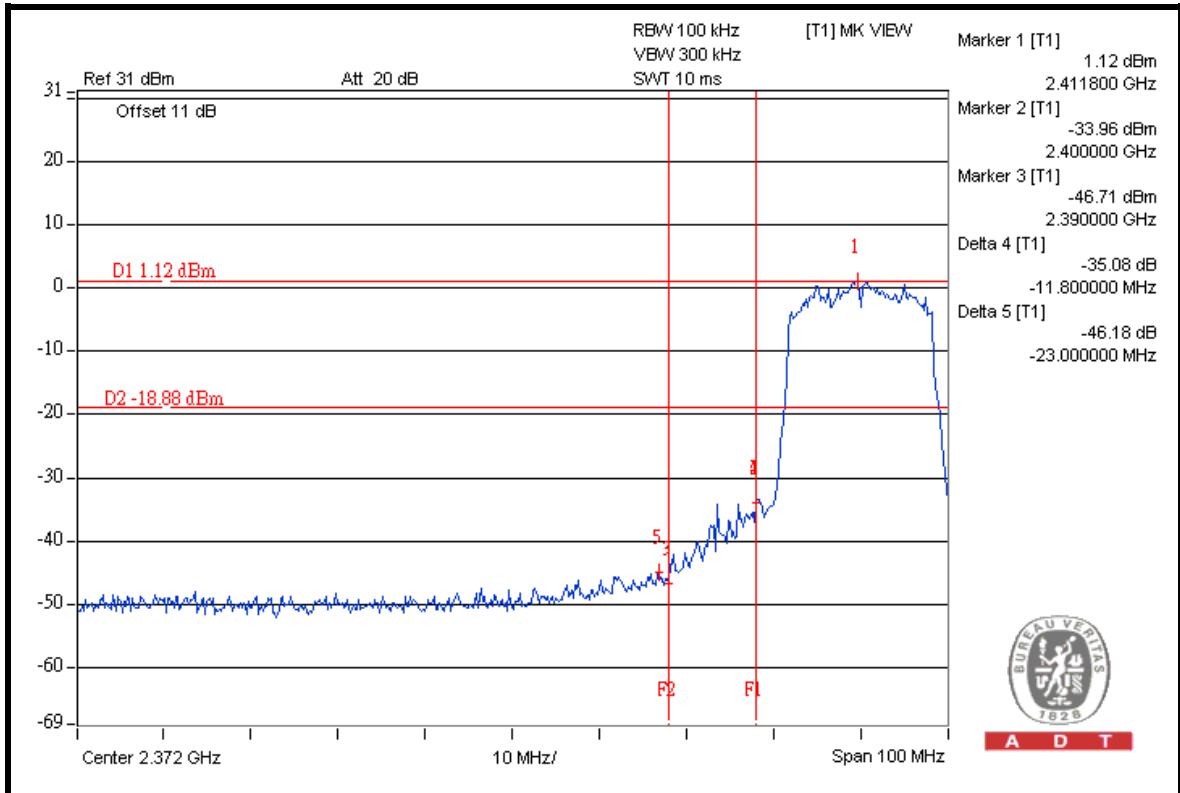



A D T

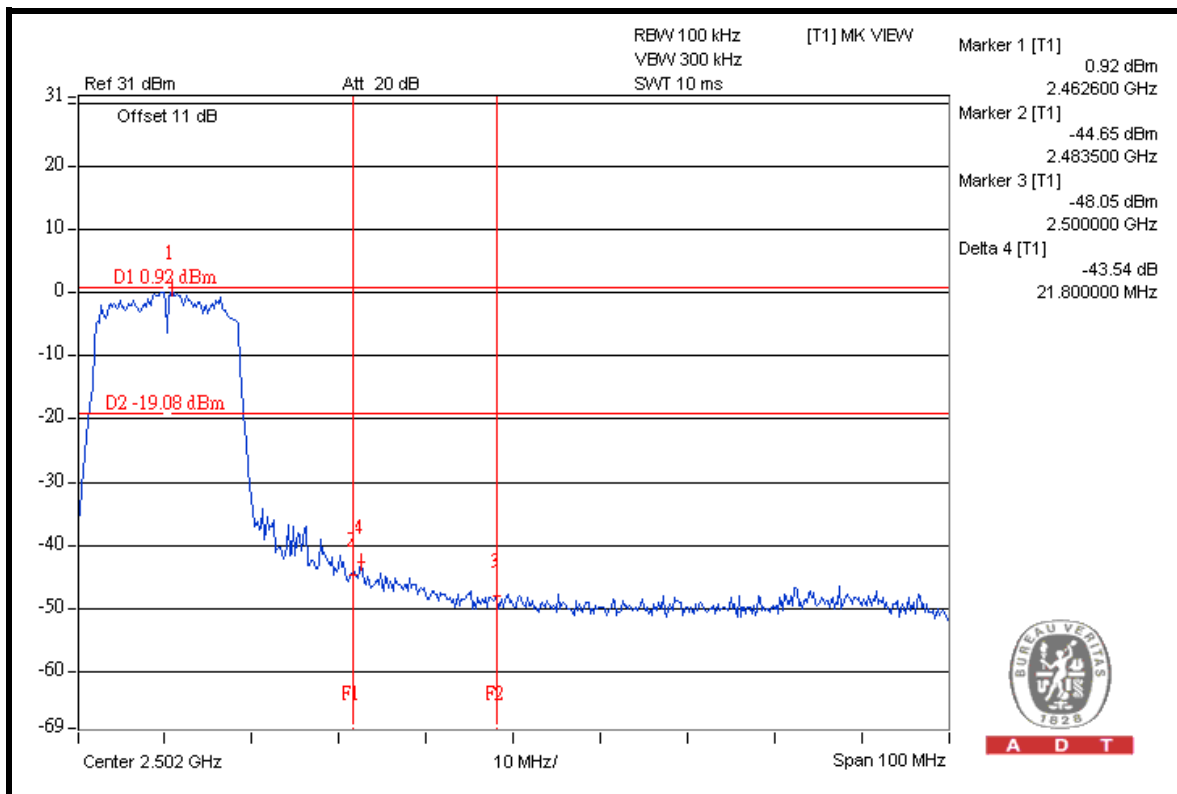
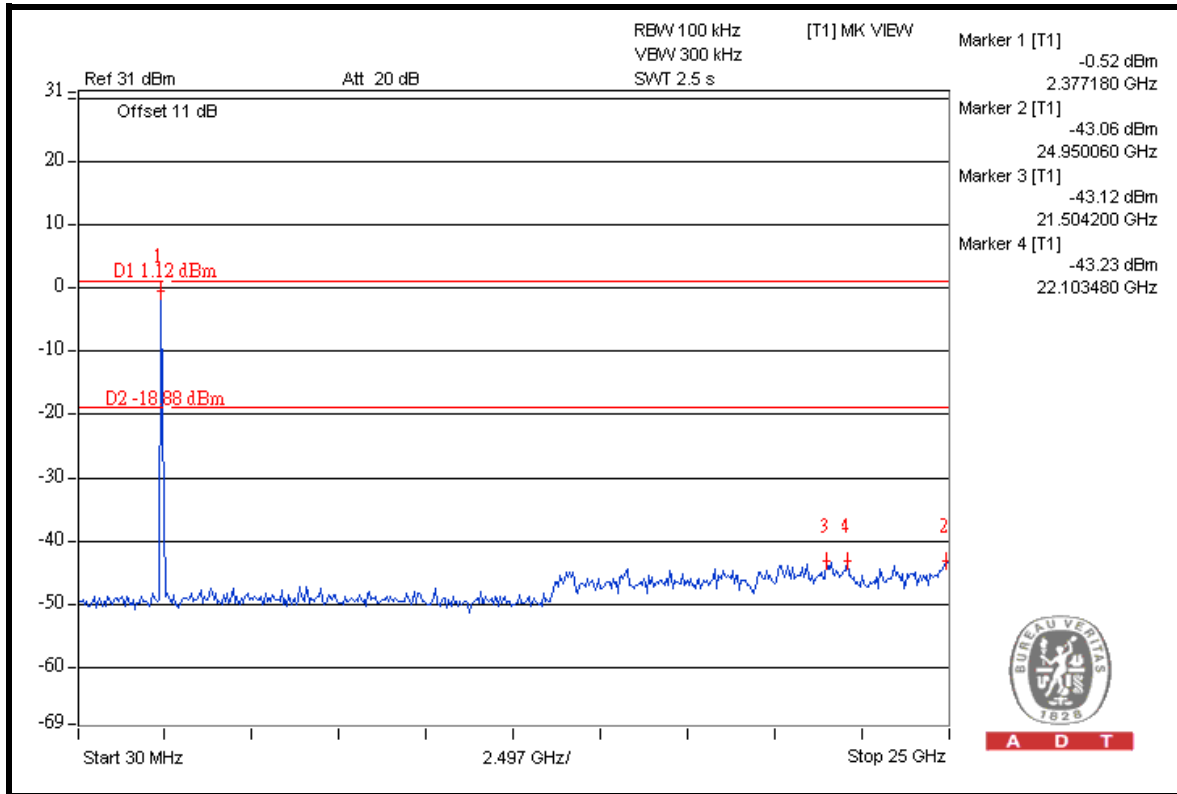



A D T

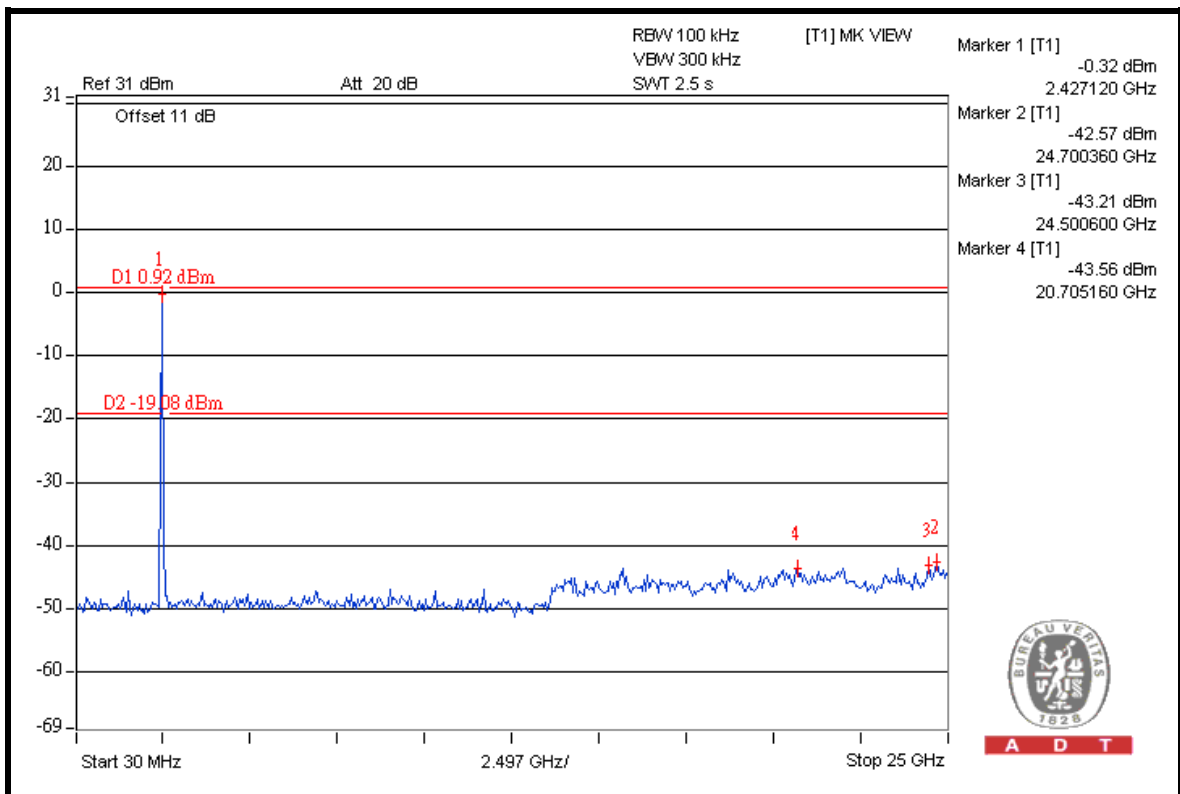
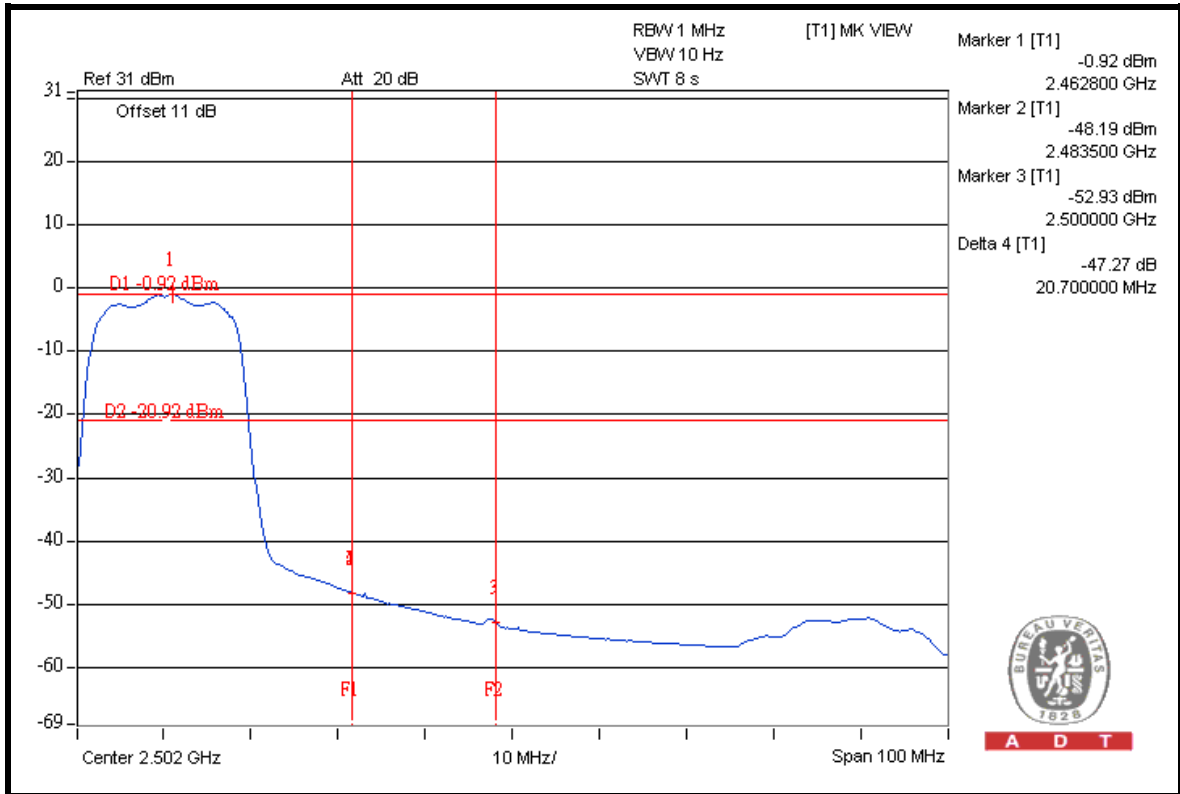

802.11n (20MHz)

RESTRICT BAND (2310 ~ 2390 MHz)

FREQUENCY (MHz)	FUNDAMENTAL EMISSION (dBuV/m)	DELTA (dB)	MAXIMUM FIELD STRENGTH IN RESTRICT BAND (dBuV/m)	LIMIT (dBuV/m)
2412.00 (PK)	102.7	45.33	57.37	74.00
2412.00 (AV)	89.2	46.37	42.83	54.00

RESTRICT BAND (2483.5 ~ 2500 MHz)

FREQUENCY (MHz)	FUNDAMENTAL EMISSION (dBuV/m)	DELTA (dB)	MAXIMUM FIELD STRENGTH IN RESTRICT BAND (dBuV/m)	LIMIT (dBuV/m)
2462.00 (PK)	100.8	44.96	55.84	74.00
2462.00 (AV)	86.8	45.45	41.35	54.00

NOTE:

1. Delta = Amplitude between the peak of the fundamental and the peak of the band edge emission. Please check following 3 pages.
2. Maximum field strength in restrict band = Fundamental emission – Delta.



A D T

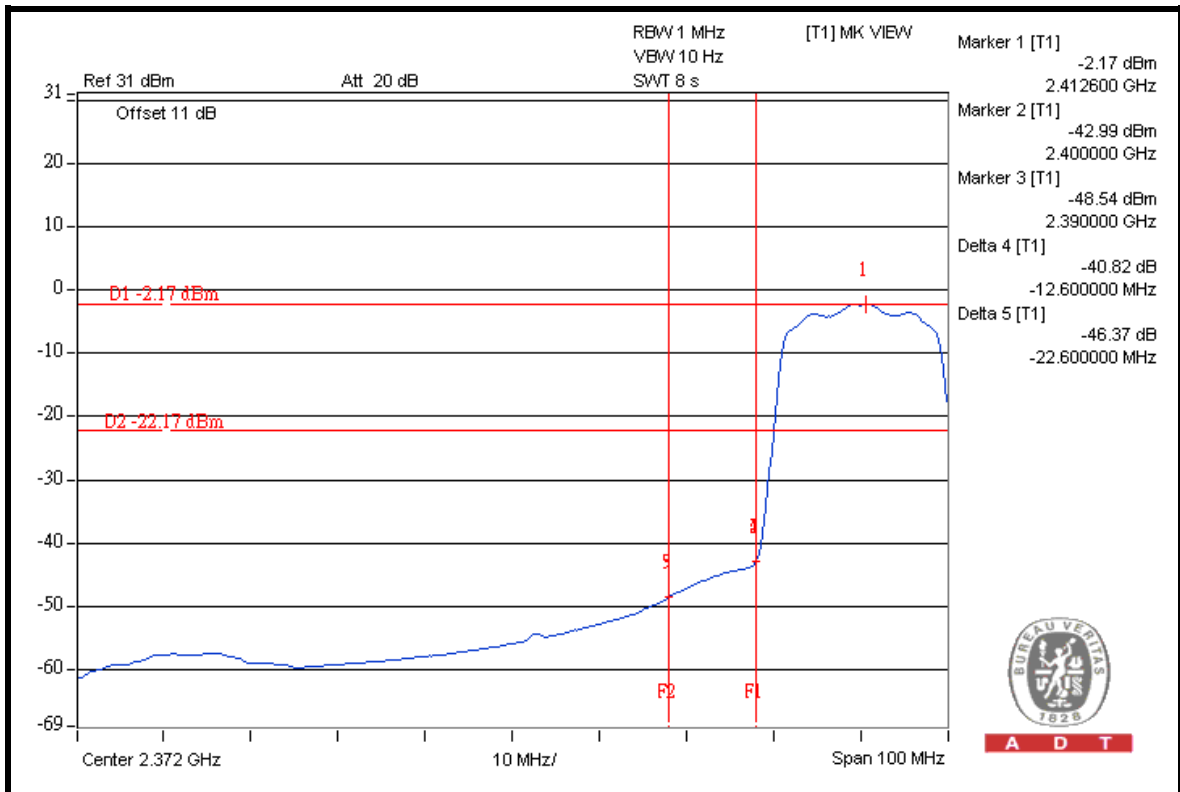
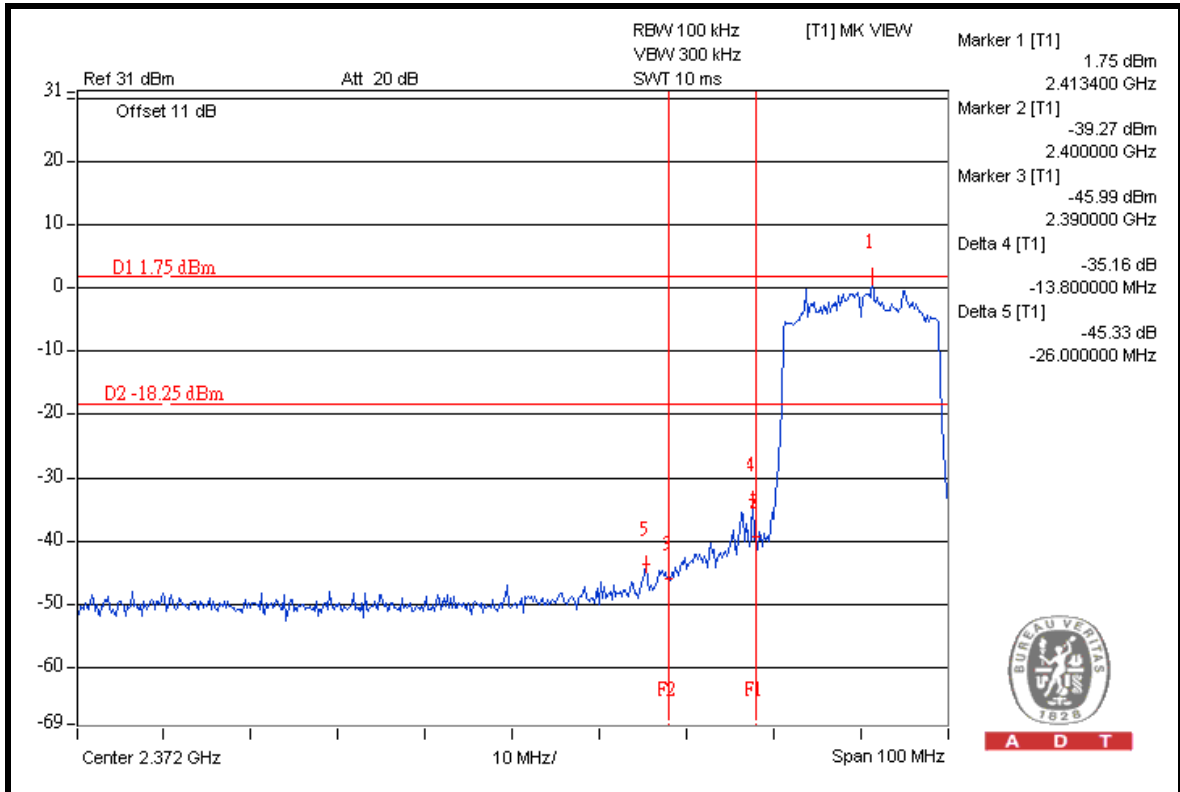



A D T

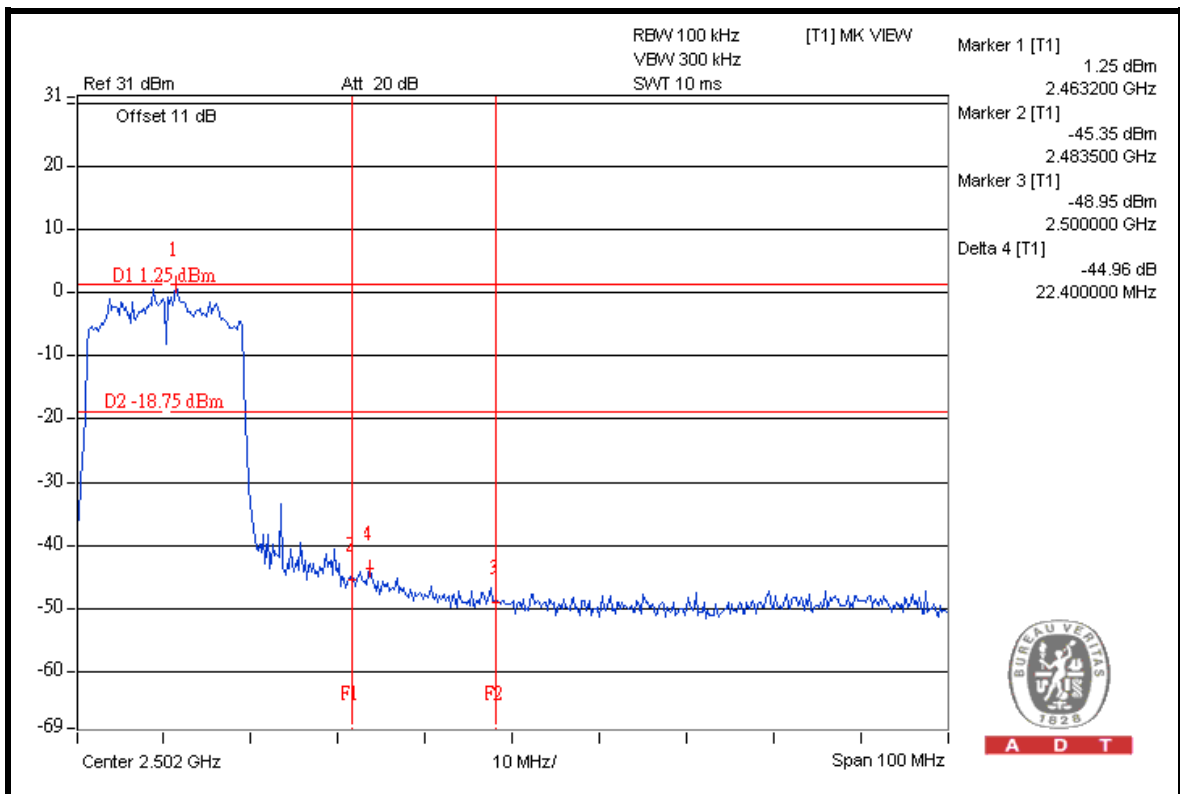
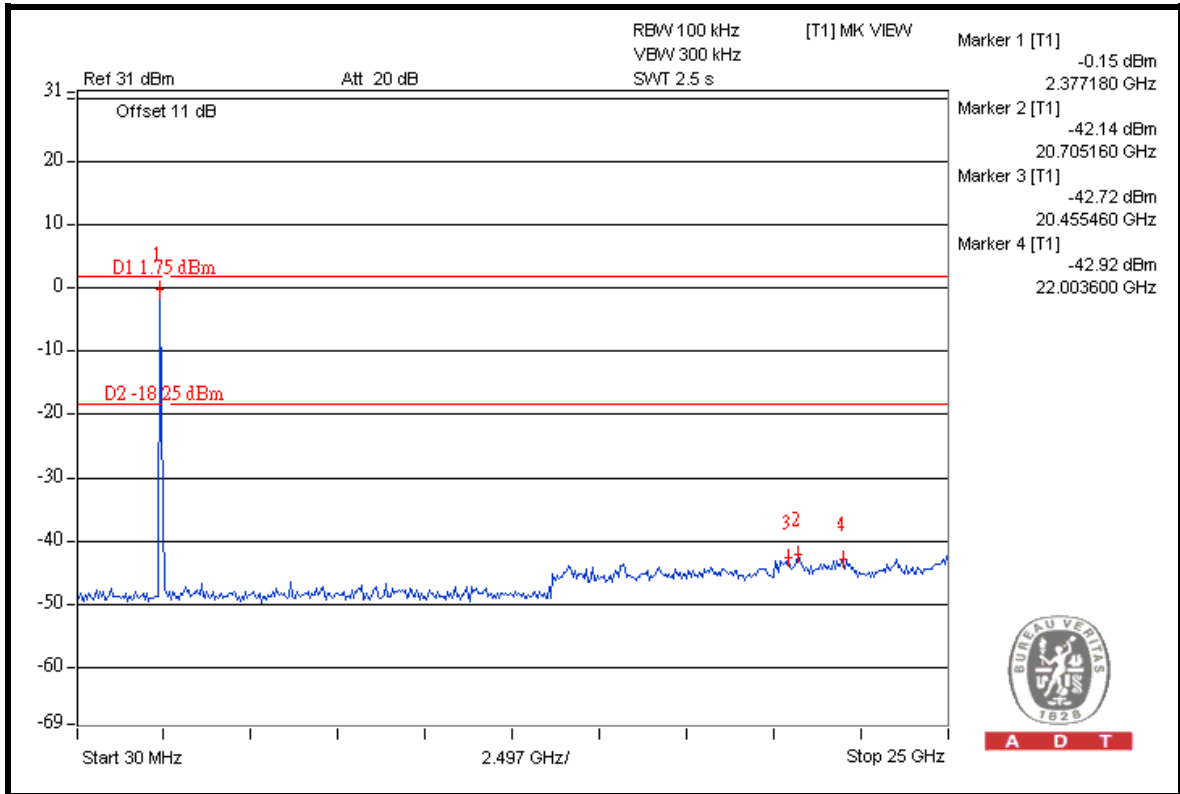



A D T

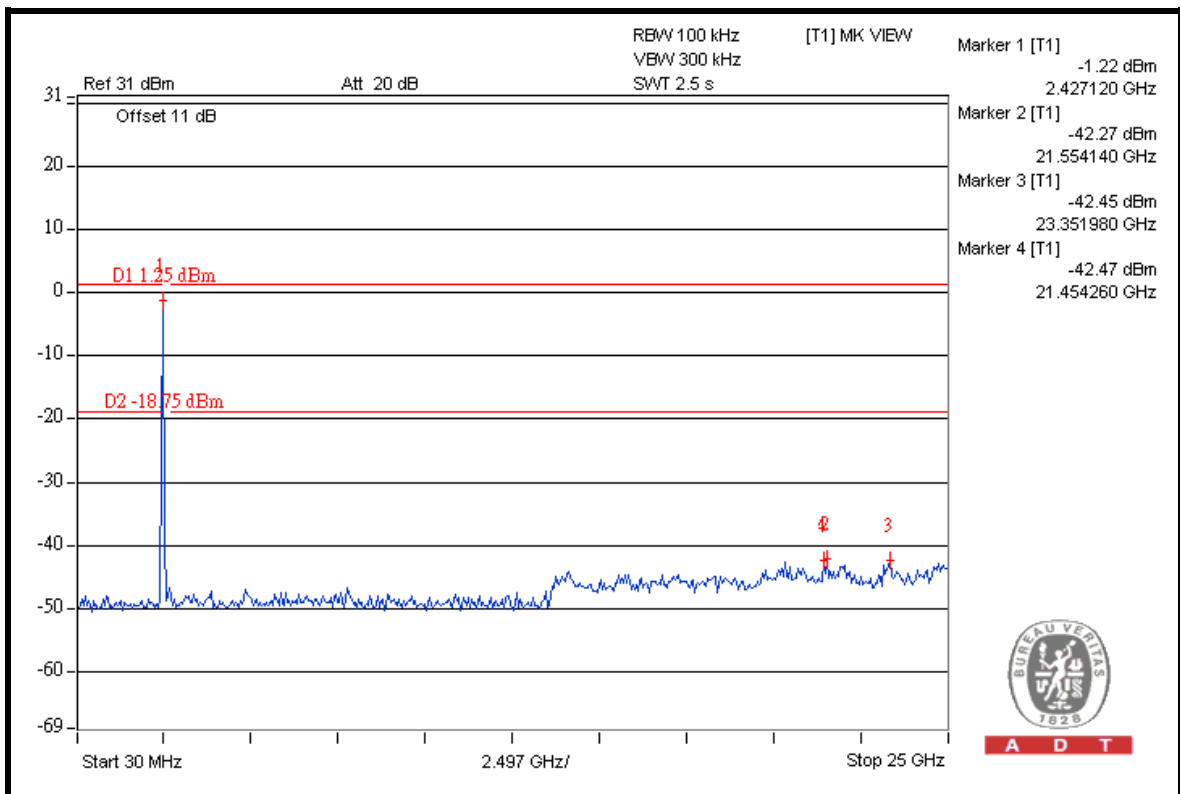
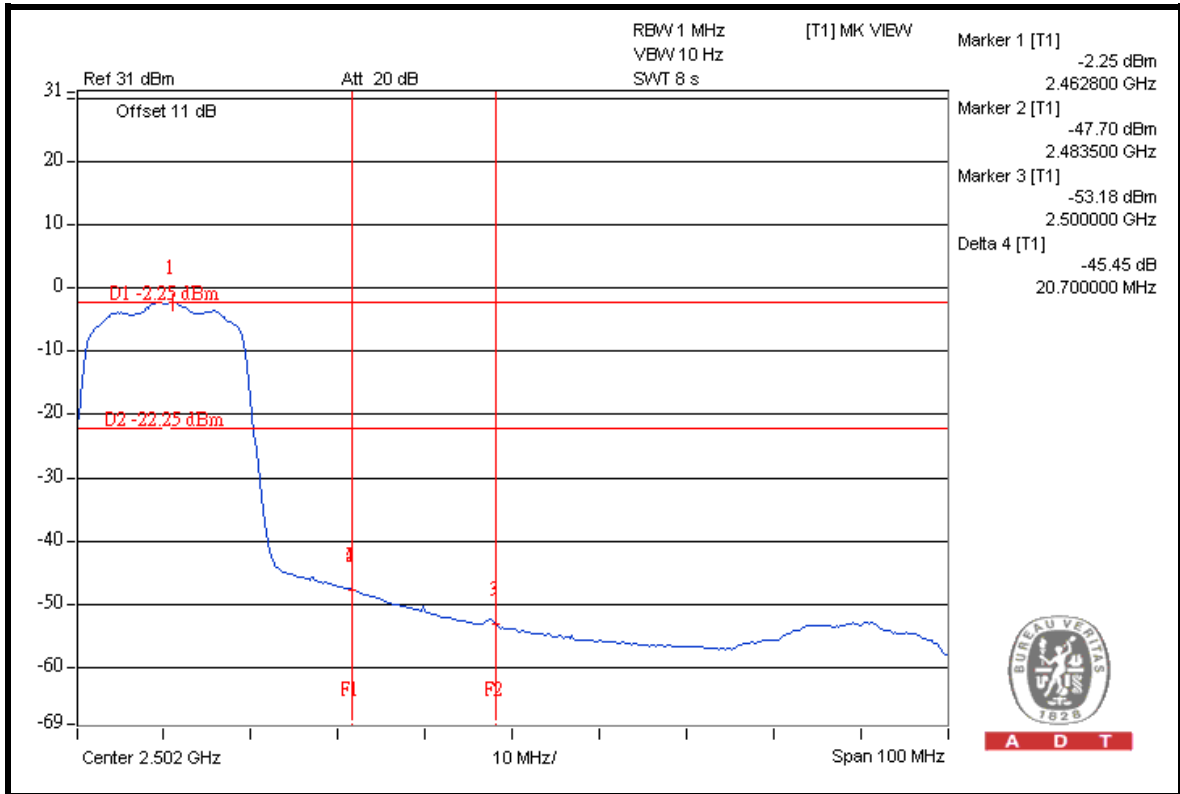



A D T

5. PHOTOGRAPHS OF THE TEST CONFIGURATION

Please refer to the attached file (Test Setup Photo).



6. INFORMATION ON THE TESTING LABORATORIES

We, Bureau Veritas Consumer Products Services (H.K.) Ltd., Taoyuan Branch., were founded in 1988 to provide our best service in EMC, Radio, Telecom and Safety consultation. Our laboratories are accredited and approved according to ISO/IEC 17025.

Copies of accreditation and authorization certificates of our laboratories obtained from approval agencies can be downloaded from our web site: www.adt.com.tw/index.5.phtml. If you have any comments, please feel free to contact us at the following:

Linko EMC/RF Lab:

Tel: 886-2-26052180
Fax: 886-2-26051924

Hsin Chu EMC/RF Lab:

Tel: 886-3-5935343
Fax: 886-3-5935342

Hwa Ya EMC/RF/Safety/TPCI Lab:

Tel: 886-3-3183232
Fax: 886-3-3185050

Email: service.adt@tw.bureauveritas.com

Web Site: www.adt.com.tw

The address and road map of all our labs can be found in our web site also.



7. APPENDIX A - MODIFICATIONS RECORDERS FOR ENGINEERING CHANGES TO THE EUT BY THE LAB

No any modifications are made to the EUT by the lab during the test.

---END---