

FCC RF Test Report

APPLICANT : HTC Corporation
EQUIPMENT : Smart Phone
MODEL NAME : PH44100
FCC ID : NM8PH44100
STANDARD : FCC Part 15 Subpart C §15.247
CLASSIFICATION : Digital Transmission System (DTS)

The product was received on Mar. 29, 2011 and completely tested on Apr. 22, 2011. We, SPORTON INTERNATIONAL INC., would like to declare that the tested sample has been evaluated in accordance with the procedures given in ANSI C63.4-2003 and shown the compliance with the applicable technical standards.

The test results in this report apply exclusively to the tested model / sample. Without written approval of SPORTON INTERNATIONAL INC., the test report shall not be reproduced except in full.

Reviewed by:



Jones Tsai / Manager



SPORTON INTERNATIONAL INC.

No. 52, Hwa Ya 1st Rd., Hwa Ya Technology Park, Kwei-Shan Hsiang, Tao Yuan Hsien, Taiwan, R.O.C.

SPORTON INTERNATIONAL INC.

TEL : 886-3-327-3456

FAX : 886-3-328-4978

FCC ID : NM8PH44100

Page Number : 1 of 72

Report Issued Date : May 20, 2011

Report Version : Rev. 01



TABLE OF CONTENTS

REVISION HISTORY 3

SUMMARY OF TEST RESULT 4

1 GENERAL DESCRIPTION 5

 1.1 Applicant 5

 1.2 Manufacturer 5

 1.3 Feature of Equipment Under Test 5

 1.4 Testing Site 6

 1.5 Applied Standards 6

 1.6 Ancillary Equipment List 6

2 TEST CONFIGURATION OF EQUIPMENT UNDER TEST 7

 2.1 RF Power 7

 2.2 Test Mode 8

 2.3 Connection Diagram of Test System 9

 2.4 RF Utility 9

3 TEST RESULT 10

 3.1 6dB Bandwidth Measurement 10

 3.2 Output Power Measurement 17

 3.3 Band Edges Measurement 19

 3.4 Spurious Emission Measurement 27

 3.5 Power Spectral Density Measurement 37

 3.6 AC Conducted Emission Measurement 44

 3.7 Radiated Emission Measurement 48

 3.8 Antenna Requirements 69

4 LIST OF MEASURING EQUIPMENT 70

5 UNCERTAINTY OF EVALUATION 71

APPENDIX A. SETUP PHOTOGRAPHS



REVISION HISTORY

| REPORT NO. | VERSION | DESCRIPTION | ISSUED DATE |
|------------|---------|-------------------------|--------------|
| FR132949B | Rev. 01 | Initial issue of report | May 20, 2011 |
| | | | |
| | | | |
| | | | |
| | | | |
| | | | |
| | | | |
| | | | |
| | | | |
| | | | |
| | | | |
| | | | |
| | | | |
| | | | |
| | | | |
| | | | |



SUMMARY OF TEST RESULT

| Report Section | FCC Rule | IC Rule | Description | Limit | Result | Remark |
|----------------|-----------------------|-----------|-------------------------------|--------------------------|--------|---------------------------------------|
| 3.1 | 15.247(a)(2) | A8.2(a) | 6dB Bandwidth | $\geq 0.5\text{MHz}$ | Pass | - |
| 3.2 | 15.247(b) | A8.4 | Power Output | $\leq 30\text{dBm}$ | Pass | - |
| 3.3 | 15.247(d) | A8.5 | Frequency Band Edges | $\leq 20\text{dBc}$ | Pass | - |
| 3.4 | 15.247(d) | A8.5 | Spurious Emission | $< 20\text{ dBc}$ | Pass | - |
| 3.5 | 15.247(e) | A8.2(b) | Power Spectral Density | $\leq 8\text{dBm}$ | Pass | - |
| 3.6 | 15.207 | Gen 7.2.2 | AC Conducted Emission | 15.207(a) | Pass | Under limit 7.7 dB at 0.79 MHz |
| 3.7 | 15.247(d) | A8.5 | Transmitter Radiated Emission | 15.209(a) & 15.247(d) | Pass | Under limit 3.78 dB at 4924 MHz |
| 3.8 | 15.203 & 15.247(b) | A8.4 | Antenna Requirement | N/A | Pass | - |



1 General Description

1.1 Applicant

HTC Corporation
1F., No. 6-3, Baoqiang Rd., Xindian City, Taipei, Taiwan

1.2 Manufacturer

HTC Corporation
1F., No. 6-3, Baoqiang Rd., Xindian City, Taipei, Taiwan

1.3 Feature of Equipment Under Test

| Product Feature & Specification | |
|-----------------------------------|---|
| Equipment | Smart Phone |
| Model Name | PH44100 |
| FCC ID | NM8PH44100 |
| Tx/Rx Frequency Range | 2400 MHz ~ 2483.5 MHz |
| Number of Channels | 11 |
| Carrier Frequency of Each Channel | 2412+(n-1)*5 MHz; n=1~11 |
| Channel Spacing | 5 MHz |
| Maximum Output Power to Antenna | 802.11b : 21.15 dBm (0.13 W) 802.11g : 23.24 dBm (0.21 W) 802.11n (BW 20MHz) : 22.57 dBm (0.18 W) |
| Antenna Type | PIFA Antenna with gain -3 dBi |
| Type of Modulation | 802.11b : DSSS (BPSK / QPSK / CCK) 802.11g/n : OFDM (BPSK / QPSK / 16QAM / 64QAM) |
| EUT Stage | Production Unit |

Remark:

1. For other wireless features of this EUT, test report will be issued separately.
2. This test report recorded only product characteristics and test results of Digital Transmission System (DTS).
3. The above EUT's information was declared by manufacturer. Please refer to the specifications or user's manual for more detailed description.

1.4 Testing Site

| | | | |
|---------------------------|--|-----------|--------------------------------|
| Test Site | SPORTON INTERNATIONAL INC. | | |
| Test Site Location | No. 52, Hwa Ya 1 st Rd., Hwa Ya Technology Park, Kwei-Shan Hsiang, Tao Yuan Hsien, Taiwan, R.O.C. TEL: +886-3-3273456 / FAX: +886-3-3284978 | | |
| Test Site No. | Sporton Site No. | | FCC/IC Registration No. |
| | CO05-HY | 03CH06-HY | 722060/4086B-1 |

1.5 Applied Standards

According to the specifications of the manufacturer, the EUT must comply with the requirements of the following standards:

- ♦ FCC Part 15 Subpart C §15.247
- ♦ FCC KDB Publication No. 558074 (Measurement Guidelines of DTS)
- ♦ ANSI C63.4-2003
- ♦ IC RSS-210 Issue 8

Remark:

1. All test items were verified and recorded according to the standards and without any deviation during the test.
2. This EUT has also been tested and complied with the requirements of FCC Part 15, Subpart B (DoC), recorded in a separate test report.

1.6 Ancillary Equipment List

| Item | Equipment | Trade Name | Model Name | FCC ID | Data Cable | Power Cord |
|------|--------------------|------------|-------------|-------------|------------|--|
| 1. | System Simulator | R&S | CMU 200 | N/A | N/A | Unshielded, 1.8 m |
| 2. | System Simulator | Agilent | E6651A | N/A | N/A | Unshielded, 1.8 m |
| 3. | GPS Station | T&E | GS-50 | N/A | N/A | Unshielded, 1.8 m |
| 4. | WLAN AP | D-Link | DIR-628 | KA2DIR628A2 | N/A | Unshielded, 1.8 m |
| 5. | Notebook | DELL | Vostro 1510 | FCC DoC | N/A | AC I/P: Unshielded, 1.2 m DC O/P: Shielded, 1.8 m |
| 6. | Bluetooth Earphone | Nokia | BH-102 | PYAHS-107W | N/A | N/A |

2 Test Configuration of Equipment Under Test

2.1 RF Power

Preliminary tests were performed in different data rate and recorded the RF peak power output in the following table:

| Channel | Frequency | 2.4GHz 802.11b RF Power (dBm) | | | |
|---------|-----------|-------------------------------|--------|----------|---------|
| | | DSSS Data Rate | | | |
| | | 1 Mbps | 2 Mbps | 5.5 Mbps | 11 Mbps |
| CH 06 | 2437 MHz | 20.86 | 21.11 | 21.1 | 21.15 |

| Channel | Frequency | 2.4GHz 802.11g RF Power (dBm) | | | | | | | |
|---------|-----------|-------------------------------|--------|---------|---------|---------|---------|---------|---------|
| | | OFDM Data Rate | | | | | | | |
| | | 6 Mbps | 9 Mbps | 12 Mbps | 18 Mbps | 24 Mbps | 36 Mbps | 48 Mbps | 54 Mbps |
| CH 06 | 2437 MHz | 23.24 | 23.09 | 22.65 | 22.74 | 22.96 | 22.77 | 22.87 | 22.90 |

| Channel | Frequency | 2.4GHz 802.11n (BW 20MHz) RF Power (dBm) | | | | | | | |
|---------|-----------|--|------|-------|-------|-------|-------|-------|-------|
| | | OFDM Data Rate | | | | | | | |
| | | MCS0 | MCS1 | MCS2 | MCS3 | MCS4 | MCS5 | MCS6 | MCS7 |
| CH 06 | 2437 MHz | 22.57 | 22.2 | 22.32 | 22.17 | 21.97 | 22.09 | 21.79 | 21.67 |

Remark:

1. The data rates of WLAN 802.11b/g/n were set in 11Mbps for 802.11b, 6Mbps for 802.11g, and MCS0 for 802.11n (BW 20MHz) for all the test cases due to the highest RF peak output power.
2. The EUT is programmed to transmit signals continuously for all testing.
3. Pre-scan has been conducted to determine the worst-case mode from all possible combinations between available modulations, data rates and antenna ports.

2.2 Test Mode

The EUT has been associated with peripherals pursuant to ANSI C63.4-2003 and configuration operated in a manner tended to maximize its emission characteristics in a typical application. Frequency range investigated: conducted emission (150 kHz to 30 MHz), radiated emission (30 MHz to the 10th harmonic of the highest fundamental frequency or to 40 GHz, whichever is lower).

The following tables are showing the test modes as the worst cases and recorded in this report.

| Test Cases | | |
|--|--|---|
| Test Item | 802.11b (Modulation : DSSS) | 802.11g/n (Modulation : OFDM) |
| Conducted TCs | Mode 1 : 802.11b CH01_2412 MHz Mode 2 : 802.11b CH06_2437 MHz Mode 3 : 802.11b CH11_2462 MHz | Mode 4: 802.11g_CH01_2412 MHz Mode 5: 802.11g_CH06_2437 MHz Mode 6: 802.11g_CH11_2462 MHz Mode 7: 802.11n (BW 20M)_CH01_2412 MHz Mode 8: 802.11n (BW 20M)_CH06_2437 MHz Mode 9: 802.11n (BW 20M)_CH11_2462 MHz |
| Radiated TCs | Mode 1 : 802.11b CH01_2412 MHz Mode 2 : 802.11b CH06_2437 MHz Mode 3 : 802.11b CH11_2462 MHz | Mode 4: 802.11g_CH01_2412 MHz Mode 5: 802.11g_CH06_2437 MHz Mode 6: 802.11g_CH11_2462 MHz Mode 7: 802.11n (BW 20M)_CH01_2412 MHz Mode 8: 802.11n (BW 20M)_CH06_2437 MHz Mode 9: 802.11n (BW 20M)_CH11_2462 MHz |
| AC Conducted Emission | Mode 1 : CDMA2000 BC0 Idle + Bluetooth Link + WLAN Link + GPS Rx + WiMAX Idle + Battery 1 + Earphone + USB Cable 1 (Charging from Adapter 1) Mode 2 : CDMA2000 BC1 Idle + Bluetooth Link + WLAN Link + GPS Rx + WiMAX Idle + Battery 2 + Earphone + USB Cable 2 (Charging from Adapter 2) | |
| Remark: | | |
| <ol style="list-style-type: none"> 1. The Radiation test was performed with Battery 1, USB Cable 3, Earphone, and Adapter 1. 2. The worst case of conducted emission is mode 2; only the test data of it was reported. | | |

2.3 Connection Diagram of Test System

<WLAN Tx Mode>

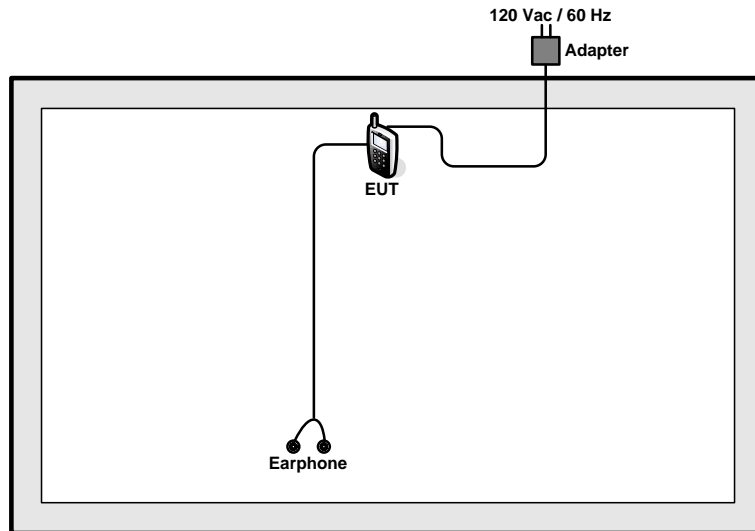

<AC Conducted Emission Mode>

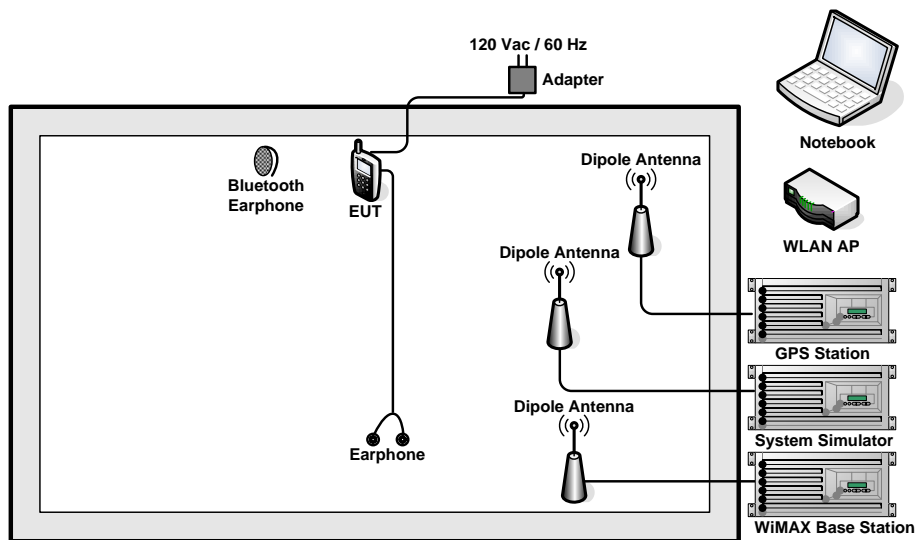

2.4 RF Utility

The programmed RF utility “WiFi Router” is installed in EUT to provide channel selection, power level, data rate and the application type. RF utility can send transmitting signal for all testing. The RF output power selection is for the setting of RF output power expected by the customer and is going to be fixed on the firmware of the final end product.

3 Test Result

3.1 6dB Bandwidth Measurement

3.1.1 Limit of 6dB Bandwidth

The minimum 6 dB bandwidth shall be at least 500 kHz.

3.1.2 Measuring Instruments

See list of measuring instruments of this test report.

3.1.3 Test Procedures

1. The testing follows FCC KDB Publication No. 558074 (Measurement Guidelines of DTS).
2. The RF output of EUT was connected to the spectrum analyzer by a low loss cable.
3. Make the measurement with the spectrum analyzer's resolution bandwidth (RBW) = 100 kHz. In order to make an accurate measurement, set the span greater than RBW. The 6 dB bandwidth must be greater than 500 kHz.
4. The marker-delta reading at this point is the 6 dB bandwidth of the emission.

3.1.4 Test Setup

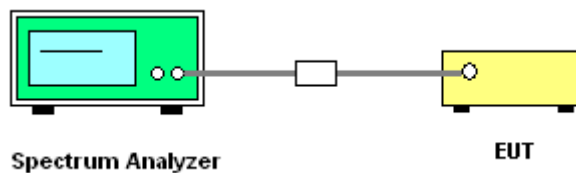



3.1.5 Test Result of 6dB Bandwidth

| | | | |
|-----------------|--------------|---------------------|---------|
| Test Mode : | Mode 1, 2, 3 | Temperature : | 24~26°C |
| Test Engineer : | Pinkston Tu | Relative Humidity : | 50~53% |

| Channel | Frequency (MHz) | 802.11b 6dB Bandwidth (MHz) | 6dB Bandwidth Min. Limit (MHz) | Pass/Fail |
|---------|-----------------|-----------------------------|--------------------------------|-----------|
| 01 | 2412 | 7.12 | 0.5 | Pass |
| 06 | 2437 | 7.48 | 0.5 | Pass |
| 11 | 2462 | 6.80 | 0.5 | Pass |

Mode 1 : 6 dB Bandwidth Plot on 802.11b Channel 01

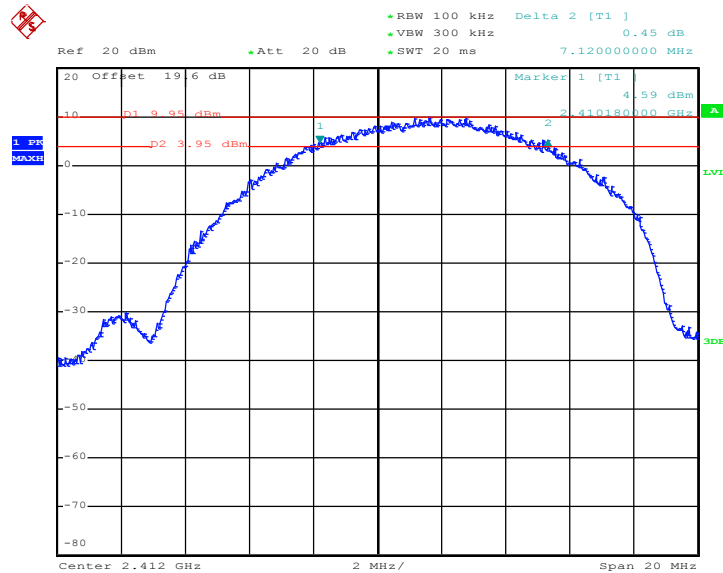

Date: 6.APR.2011 11:53:02



Mode 2 : 6 dB Bandwidth Plot on 802.11b Channel 06

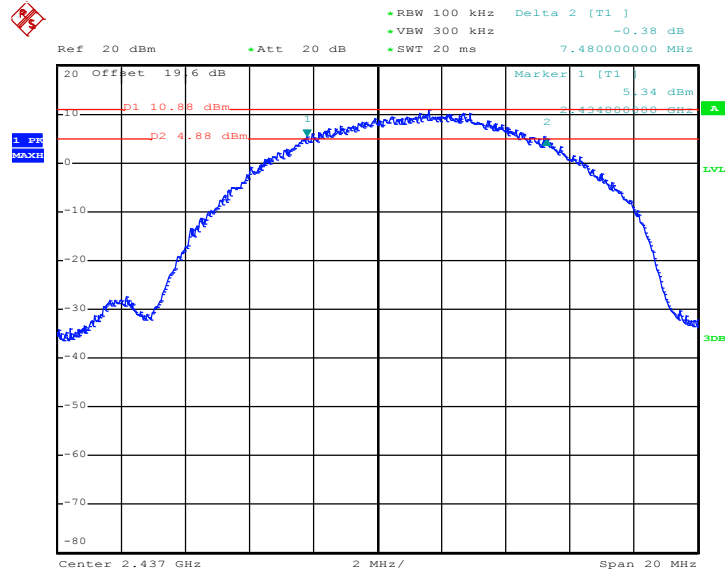

Date: 6.APR.2011 11:56:23

Mode 3 : 6 dB Bandwidth Plot on 802.11b Channel 11

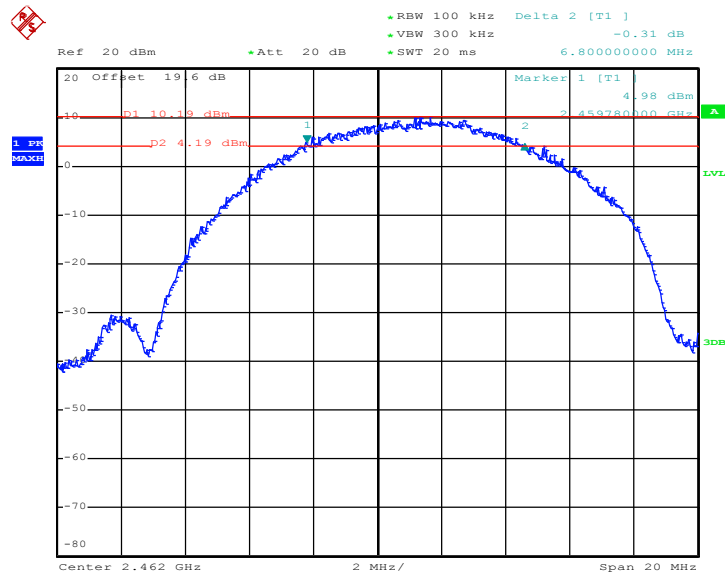

Date: 6.APR.2011 11:59:17



| | | | |
|-----------------|--------------|---------------------|---------|
| Test Mode : | Mode 4, 5, 6 | Temperature : | 24~26°C |
| Test Engineer : | Pinkston Tu | Relative Humidity : | 50~53% |

| Channel | Frequency (MHz) | 802.11g 6dB Bandwidth (MHz) | 6dB Bandwidth Min. Limit (MHz) | Pass/Fail |
|---------|-----------------|--------------------------------|-----------------------------------|-----------|
| 01 | 2412 | 15.12 | 0.5 | Pass |
| 06 | 2437 | 15.16 | 0.5 | Pass |
| 11 | 2462 | 15.08 | 0.5 | Pass |

Mode 4 : 6 dB Bandwidth Plot on 802.11g Channel 01

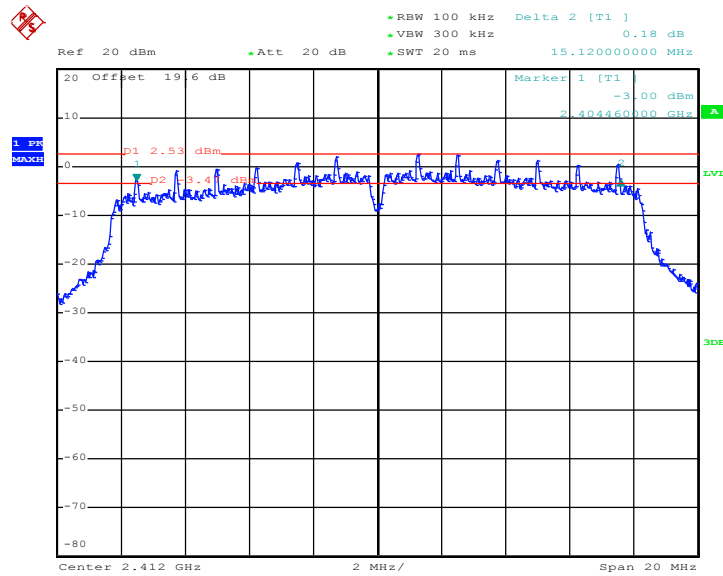

Date: 6.APR.2011 10:12:42



Mode 5 : 6 dB Bandwidth Plot on 802.11g Channel 06

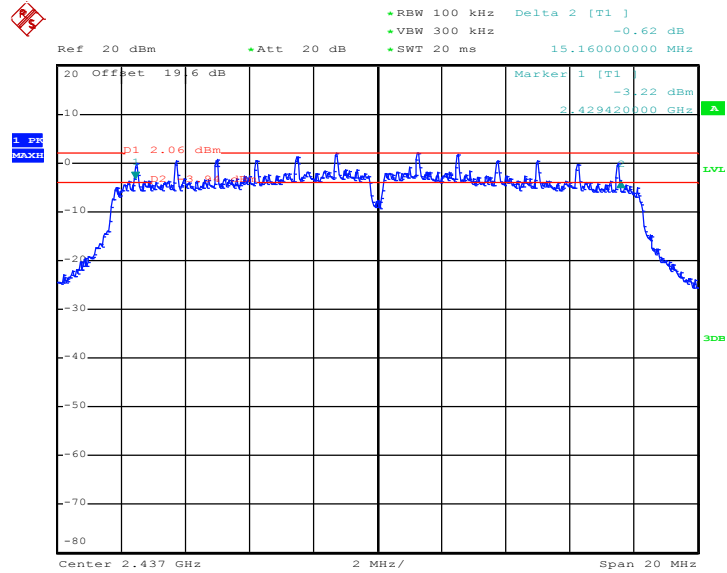

Date: 6.APR.2011 10:26:30

Mode 6 : 6 dB Bandwidth Plot on 802.11g Channel 11

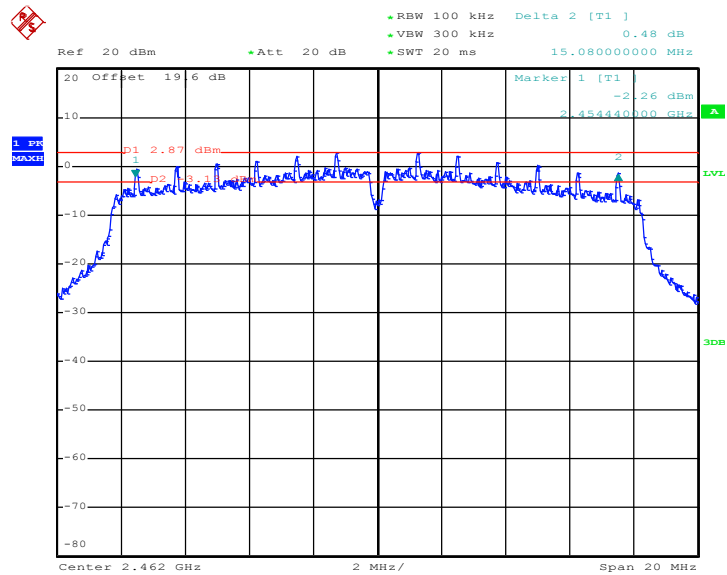

Date: 6.APR.2011 10:43:07



| | | | |
|-----------------|--------------|---------------------|---------|
| Test Mode : | Mode 7, 8, 9 | Temperature : | 24~26°C |
| Test Engineer : | Pinkston Tu | Relative Humidity : | 50~53% |

| Channel | Frequency (MHz) | 802.11n (BW 20MHz) 6dB Bandwidth (MHz) | 6dB Bandwidth Min. Limit (MHz) | Pass/Fail |
|---------|-----------------|--|--------------------------------|-----------|
| 01 | 2412 | 15.12 | 0.5 | Pass |
| 06 | 2437 | 15.12 | 0.5 | Pass |
| 11 | 2462 | 15.08 | 0.5 | Pass |

Mode 7 : 6 dB Bandwidth Plot on 802.11n(BW 20MHz) Channel 01

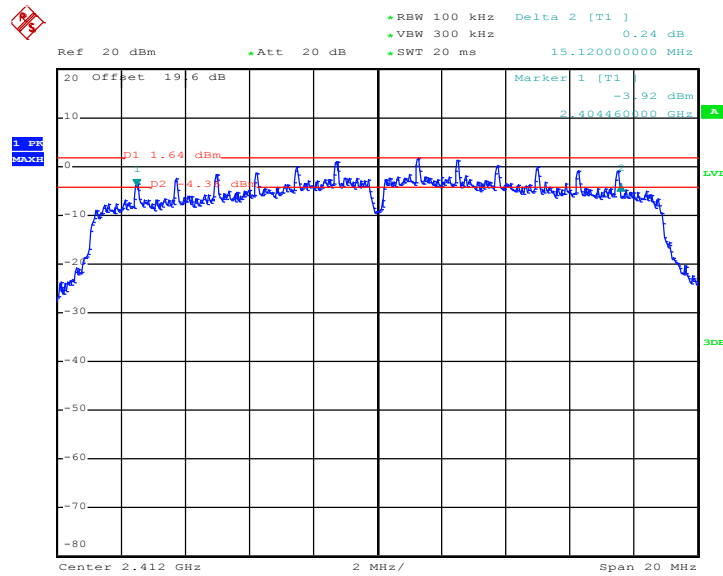

Date: 6.APR.2011 11:24:09



Mode 8 : 6 dB Bandwidth Plot on 802.11n(BW 20MHz) Channel 06

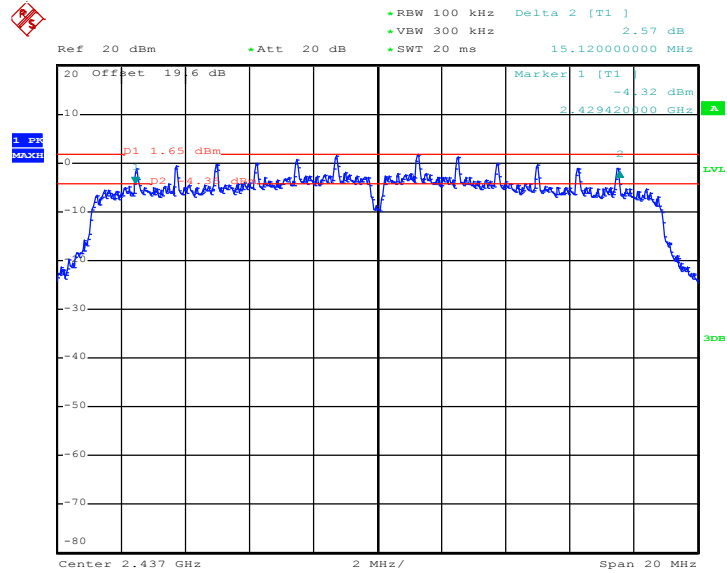

Date: 6.APR.2011 11:10:13

Mode 9 : 6 dB Bandwidth Plot on 802.11n(BW 20MHz) Channel 11

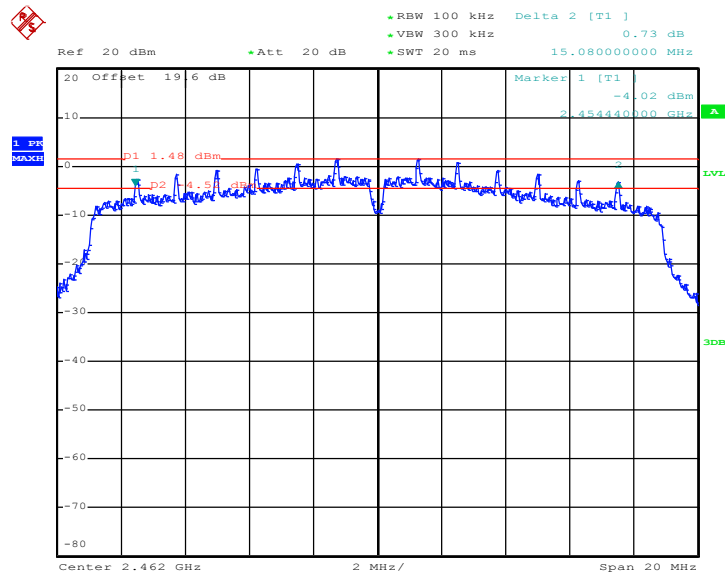

Date: 6.APR.2011 10:56:49

3.2 Output Power Measurement

3.2.1 Limit of Output Power

For systems using digital modulation in the 2400-2483.5MHz, the limit for peak output power is 30dBm. If transmitting antenna of directional gain greater than 6dBi are used the peak output power from the intentional radiator shall be reduced below the above stated value by the amount in dB that the directional gain of the antenna exceeds 6 dBi. In case of point-to-point operation, the limit has to be reduced by 1dB for every 3dB that the directional gain of the antenna exceeds 6dBi.

3.2.2 Measuring Instruments

See list of measuring instruments of this test report.

3.2.3 Test Procedures

1. The testing follows FCC KDB Publication No. 558074 (Measurement Guidelines of DTS).
2. The RF output of EUT was connected to the power meter by a low loss cable.
3. Measure the power by power meter.

3.2.4 Test Setup

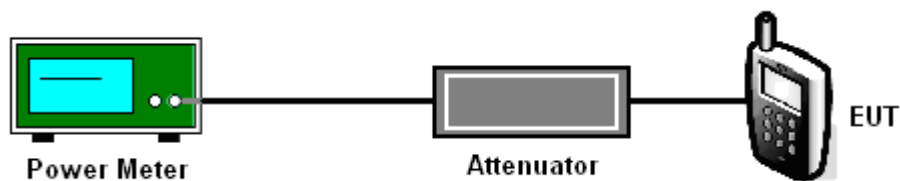



3.2.5 Test Result of Output Power

| | | | |
|-----------------|--------------|---------------------|---------|
| Test Mode : | Mode 1, 2, 3 | Temperature : | 24~26°C |
| Test Engineer : | Pinkston Tu | Relative Humidity : | 50~53% |

| Channel | Frequency (MHz) | 802.11b Measured Output Power (dBm) | Max. Limits (dBm) | Pass/Fail |
|---------|-----------------|-------------------------------------|-------------------|-----------|
| 01 | 2412 | 20.85 | 30 | Pass |
| 06 | 2437 | 21.15 | 30 | Pass |
| 11 | 2462 | 21.00 | 30 | Pass |

| | | | |
|-----------------|--------------|---------------------|---------|
| Test Mode : | Mode 4, 5, 6 | Temperature : | 24~26°C |
| Test Engineer : | Pinkston Tu | Relative Humidity : | 50~53% |

| Channel | Frequency (MHz) | 802.11g Measured Output Power (dBm) | Max. Limits (dBm) | Pass/Fail |
|---------|-----------------|-------------------------------------|-------------------|-----------|
| 01 | 2412 | 22.81 | 30 | Pass |
| 06 | 2437 | 23.24 | 30 | Pass |
| 11 | 2462 | 22.99 | 30 | Pass |

| | | | |
|-----------------|--------------|---------------------|---------|
| Test Mode : | Mode 7, 8, 9 | Temperature : | 24~26°C |
| Test Engineer : | Pinkston Tu | Relative Humidity : | 50~53% |

| Channel | Frequency (MHz) | 802.11n (BW 20MHz) Measured Output Power (dBm) | Max. Limits (dBm) | Pass/Fail |
|---------|-----------------|--|-------------------|-----------|
| 01 | 2412 | 22.48 | 30 | Pass |
| 06 | 2437 | 22.57 | 30 | Pass |
| 11 | 2462 | 22.30 | 30 | Pass |



3.3 Band Edges Measurement

3.3.1 Limit of Band Edges

In any 100 kHz bandwidth outside the intentional radiation frequency band, the radio frequency power shall be at least 20 dB below the highest level of the radiated power. If the output power of this device was measured by spectrum analyzer, the attenuation under this paragraph shall be 30 dB instead of 20 dB.

3.3.2 Measuring Instruments

See list of measuring instruments of this test report.

3.3.3 Test Procedures

1. The testing follows the guidelines in ANSI C63.4-2003 and FCC KDB Publication No. 558074 (Measurement Guidelines of DTS).
2. Conducted emission test: Set RBW = 100 kHz, Video bandwidth (VBW) \geq RBW. Band edge emissions must be at least 20 dB down from the highest emission level within the authorized band as measured with a 100 kHz RBW. Note: If the device complies with the use of power option 2 the attenuation under this paragraph shall be 30 dB instead of 20 dB.
3. Radiated emission test: Apply to band edge emissions that fall in the restricted bands listed in FCC Section 15.205. The maximum permitted average field strength is listed in FCC Section 15.209. A pre-amp is necessary for this measurement. For measurements above 1 GHz, set RBW = 1MHz, VBW = 10 Hz, Sweep=Auto. If the emission is pulsed, modify the unit for continuous operation; use the settings shown above, then correct the reading by subtracting the peak-average correction factor, derived from the appropriate duty cycle calculation as in FCC Section 15.35(b) and (c).

3.3.4 Test Setup

<Radiated Band Edges>

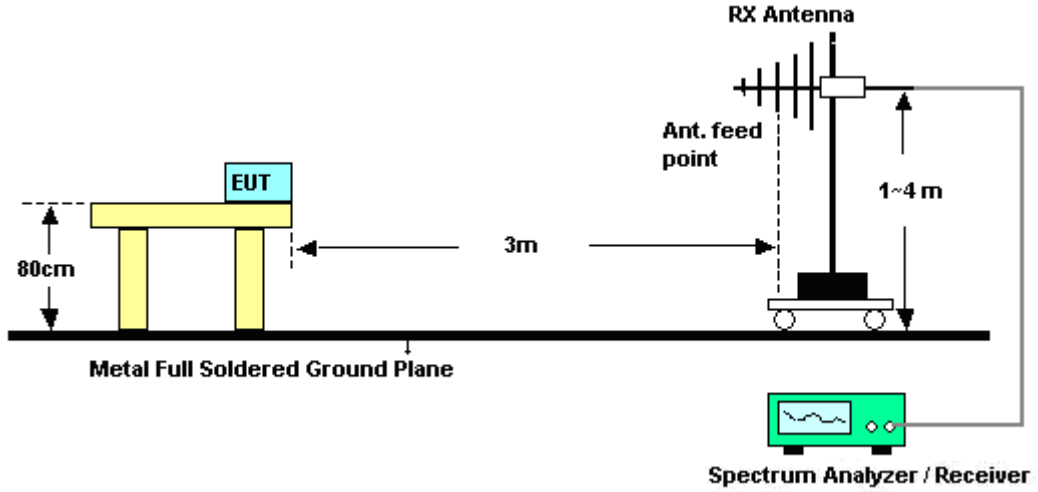

<Conducted Band Edges>

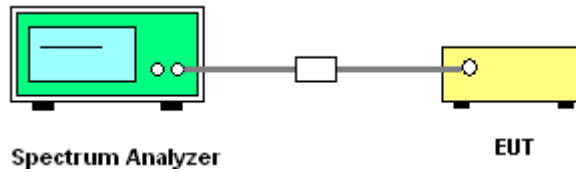



3.3.5 Test Result of Radiated Band Edges

| | | | |
|----------------|---------|---------------------|---------|
| Test Mode : | Mode 1 | Temperature : | 21~22°C |
| Test Band : | 802.11b | Relative Humidity : | 47~48% |
| Test Channel : | 01 | Test Engineer : | Kay Wu |

| ANTENNA POLARITY : HORIZONTAL | | | | | | | | | | |
|-------------------------------|------------------|-------------------|-----------------------|---------------------|-----------------------|-------------------|----------------------|----------------|-------------------|---------|
| Frequency (MHz) | Level (dBuV/m) | Over Limit (dB) | Limit Line (dBuV/m) | Read Level (dBuV) | Antenna Factor (dB) | Cable Loss (dB) | Preamp Factor (dB) | Ant Pos (cm) | Table Pos (deg) | Remark |
| 2389.99 | 50.83 | -23.17 | 74 | 47.92 | 31.9 | 5.4 | 34.39 | 100 | 337 | Peak |
| 2389.99 | 38.83 | -15.17 | 54 | 35.92 | 31.9 | 5.4 | 34.39 | 100 | 337 | Average |

| ANTENNA POLARITY : VERTICAL | | | | | | | | | | |
|-----------------------------|------------------|-------------------|-----------------------|---------------------|-----------------------|-------------------|----------------------|----------------|-------------------|---------|
| Frequency (MHz) | Level (dBuV/m) | Over Limit (dB) | Limit Line (dBuV/m) | Read Level (dBuV) | Antenna Factor (dB) | Cable Loss (dB) | Preamp Factor (dB) | Ant Pos (cm) | Table Pos (deg) | Remark |
| 2389.61 | 48.43 | -25.57 | 74 | 45.52 | 31.9 | 5.4 | 34.39 | 105 | 233 | Peak |
| 2389.61 | 35.88 | -18.12 | 54 | 32.97 | 31.9 | 5.4 | 34.39 | 105 | 233 | Average |

| | | | |
|----------------|---------|---------------------|---------|
| Test Mode : | Mode 3 | Temperature : | 21~22°C |
| Test Band : | 802.11b | Relative Humidity : | 47~48% |
| Test Channel : | 11 | Test Engineer : | Kay Wu |

| ANTENNA POLARITY : HORIZONTAL | | | | | | | | | | |
|-------------------------------|------------------|-------------------|-----------------------|---------------------|-----------------------|-------------------|----------------------|----------------|-------------------|---------|
| Frequency (MHz) | Level (dBuV/m) | Over Limit (dB) | Limit Line (dBuV/m) | Read Level (dBuV) | Antenna Factor (dB) | Cable Loss (dB) | Preamp Factor (dB) | Ant Pos (cm) | Table Pos (deg) | Remark |
| 2483.85 | 52.75 | -21.25 | 74 | 49.62 | 31.98 | 5.52 | 34.37 | 100 | 328 | Peak |
| 2483.85 | 40.14 | -13.86 | 54 | 37.01 | 31.98 | 5.52 | 34.37 | 100 | 328 | Average |

| ANTENNA POLARITY : VERTICAL | | | | | | | | | | |
|-----------------------------|------------------|-------------------|-----------------------|---------------------|-----------------------|-------------------|----------------------|----------------|-------------------|---------|
| Frequency (MHz) | Level (dBuV/m) | Over Limit (dB) | Limit Line (dBuV/m) | Read Level (dBuV) | Antenna Factor (dB) | Cable Loss (dB) | Preamp Factor (dB) | Ant Pos (cm) | Table Pos (deg) | Remark |
| 2483.5 | 51.77 | -22.23 | 74 | 48.64 | 31.98 | 5.52 | 34.37 | 103 | 0 | Peak |
| 2483.5 | 39.22 | -14.78 | 54 | 36.09 | 31.98 | 5.52 | 34.37 | 103 | 0 | Average |



| | | | |
|----------------|---------|---------------------|---------|
| Test Mode : | Mode 4 | Temperature : | 21~22°C |
| Test Band : | 802.11g | Relative Humidity : | 47~48% |
| Test Channel : | 01 | Test Engineer : | Kay Wu |

| ANTENNA POLARITY : HORIZONTAL | | | | | | | | | | |
|-------------------------------|---------------------|-------------------------|-----------------------------|---------------------------|-----------------------------|-------------------------|----------------------------|----------------------|-------------------------|---------|
| Frequency (MHz) | Level (dBuV/m) | Over Limit (dB) | Limit Line (dBuV/m) | Read Level (dBuV) | Antenna Factor (dB) | Cable Loss (dB) | Preamp Factor (dB) | Ant Pos (cm) | Table Pos (deg) | Remark |
| 2389.61 | 53.8 | -20.2 | 74 | 50.89 | 31.9 | 5.4 | 34.39 | 104 | 323 | Peak |
| 2389.61 | 37.05 | -16.95 | 54 | 34.14 | 31.9 | 5.4 | 34.39 | 104 | 323 | Average |

| ANTENNA POLARITY : VERTICAL | | | | | | | | | | |
|-----------------------------|---------------------|-------------------------|-----------------------------|---------------------------|-----------------------------|-------------------------|----------------------------|----------------------|-------------------------|---------|
| Frequency (MHz) | Level (dBuV/m) | Over Limit (dB) | Limit Line (dBuV/m) | Read Level (dBuV) | Antenna Factor (dB) | Cable Loss (dB) | Preamp Factor (dB) | Ant Pos (cm) | Table Pos (deg) | Remark |
| 2389.99 | 55.26 | -18.74 | 74 | 52.35 | 31.9 | 5.4 | 34.39 | 108 | 18 | Peak |
| 2389.99 | 37.74 | -16.26 | 54 | 34.83 | 31.9 | 5.4 | 34.39 | 108 | 18 | Average |

| | | | |
|----------------|---------|---------------------|---------|
| Test Mode : | Mode 6 | Temperature : | 21~22°C |
| Test Band : | 802.11g | Relative Humidity : | 47~48% |
| Test Channel : | 11 | Test Engineer : | Kay Wu |

| ANTENNA POLARITY : HORIZONTAL | | | | | | | | | | |
|-------------------------------|---------------------|-------------------------|-----------------------------|---------------------------|-----------------------------|-------------------------|----------------------------|----------------------|-------------------------|---------|
| Frequency (MHz) | Level (dBuV/m) | Over Limit (dB) | Limit Line (dBuV/m) | Read Level (dBuV) | Antenna Factor (dB) | Cable Loss (dB) | Preamp Factor (dB) | Ant Pos (cm) | Table Pos (deg) | Remark |
| 2483.5 | 66.29 | -7.71 | 74 | 63.16 | 31.98 | 5.52 | 34.37 | 101 | 313 | Peak |
| 2483.5 | 45.54 | -8.46 | 54 | 42.41 | 31.98 | 5.52 | 34.37 | 101 | 313 | Average |

| ANTENNA POLARITY : VERTICAL | | | | | | | | | | |
|-----------------------------|---------------------|-------------------------|-----------------------------|---------------------------|-----------------------------|-------------------------|----------------------------|----------------------|-------------------------|---------|
| Frequency (MHz) | Level (dBuV/m) | Over Limit (dB) | Limit Line (dBuV/m) | Read Level (dBuV) | Antenna Factor (dB) | Cable Loss (dB) | Preamp Factor (dB) | Ant Pos (cm) | Table Pos (deg) | Remark |
| 2483.5 | 68.42 | -5.58 | 74 | 65.29 | 31.98 | 5.52 | 34.37 | 105 | 17 | Peak |
| 2483.5 | 47.82 | -6.18 | 54 | 44.69 | 31.98 | 5.52 | 34.37 | 105 | 17 | Average |



| | | | |
|----------------|--------------------|---------------------|---------|
| Test Mode : | Mode 7 | Temperature : | 21~22°C |
| Test Band : | 802.11n (BW 20MHz) | Relative Humidity : | 47~48% |
| Test Channel : | 01 | Test Engineer : | Kay Wu |

| ANTENNA POLARITY : HORIZONTAL | | | | | | | | | | |
|-------------------------------|------------------|-------------------|-----------------------|---------------------|-----------------------|-------------------|----------------------|----------------|-------------------|---------|
| Frequency (MHz) | Level (dBuV/m) | Over Limit (dB) | Limit Line (dBuV/m) | Read Level (dBuV) | Antenna Factor (dB) | Cable Loss (dB) | Preamp Factor (dB) | Ant Pos (cm) | Table Pos (deg) | Remark |
| 2389.61 | 50.84 | -23.16 | 74 | 47.93 | 31.9 | 5.4 | 34.39 | 103 | 308 | Peak |
| 2389.61 | 35.67 | -18.33 | 54 | 32.76 | 31.9 | 5.4 | 34.39 | 103 | 308 | Average |

| ANTENNA POLARITY : VERTICAL | | | | | | | | | | |
|-----------------------------|------------------|-------------------|-----------------------|---------------------|-----------------------|-------------------|----------------------|----------------|-------------------|---------|
| Frequency (MHz) | Level (dBuV/m) | Over Limit (dB) | Limit Line (dBuV/m) | Read Level (dBuV) | Antenna Factor (dB) | Cable Loss (dB) | Preamp Factor (dB) | Ant Pos (cm) | Table Pos (deg) | Remark |
| 2389.42 | 53.51 | -20.49 | 74 | 50.6 | 31.9 | 5.4 | 34.39 | 130 | 19 | Peak |
| 2389.42 | 37.94 | -16.06 | 54 | 35.03 | 31.9 | 5.4 | 34.39 | 130 | 19 | Average |

| | | | |
|----------------|--------------------|---------------------|---------|
| Test Mode : | Mode 9 | Temperature : | 21~22°C |
| Test Band : | 802.11n (BW 20MHz) | Relative Humidity : | 47~48% |
| Test Channel : | 11 | Test Engineer : | Kay Wu |

| ANTENNA POLARITY : HORIZONTAL | | | | | | | | | | |
|-------------------------------|------------------|-------------------|-----------------------|---------------------|-----------------------|-------------------|----------------------|----------------|-------------------|---------|
| Frequency (MHz) | Level (dBuV/m) | Over Limit (dB) | Limit Line (dBuV/m) | Read Level (dBuV) | Antenna Factor (dB) | Cable Loss (dB) | Preamp Factor (dB) | Ant Pos (cm) | Table Pos (deg) | Remark |
| 2483.5 | 64.58 | -9.42 | 74 | 61.45 | 31.98 | 5.52 | 34.37 | 101 | 313 | Peak |
| 2483.5 | 44.6 | -9.4 | 54 | 41.47 | 31.98 | 5.52 | 34.37 | 101 | 313 | Average |

| ANTENNA POLARITY : VERTICAL | | | | | | | | | | |
|-----------------------------|------------------|-------------------|-----------------------|---------------------|-----------------------|-------------------|----------------------|----------------|-------------------|---------|
| Frequency (MHz) | Level (dBuV/m) | Over Limit (dB) | Limit Line (dBuV/m) | Read Level (dBuV) | Antenna Factor (dB) | Cable Loss (dB) | Preamp Factor (dB) | Ant Pos (cm) | Table Pos (deg) | Remark |
| 2483.5 | 64.59 | -9.41 | 74 | 61.46 | 31.98 | 5.52 | 34.37 | 105 | 18 | Peak |
| 2483.5 | 45.88 | -8.12 | 54 | 42.75 | 31.98 | 5.52 | 34.37 | 105 | 18 | Average |



3.3.6 Test Plots of Conducted Band Edges

| | | | |
|----------------|--------------|---------------------|-------------|
| Test Mode : | Mode 1 and 3 | Temperature : | 24~26°C |
| Test Band : | 802.11b | Relative Humidity : | 50~53% |
| Test Channel : | 01 and 11 | Test Engineer : | Pinkston Tu |

Low Band Edge Plot on 802.11b Channel 01

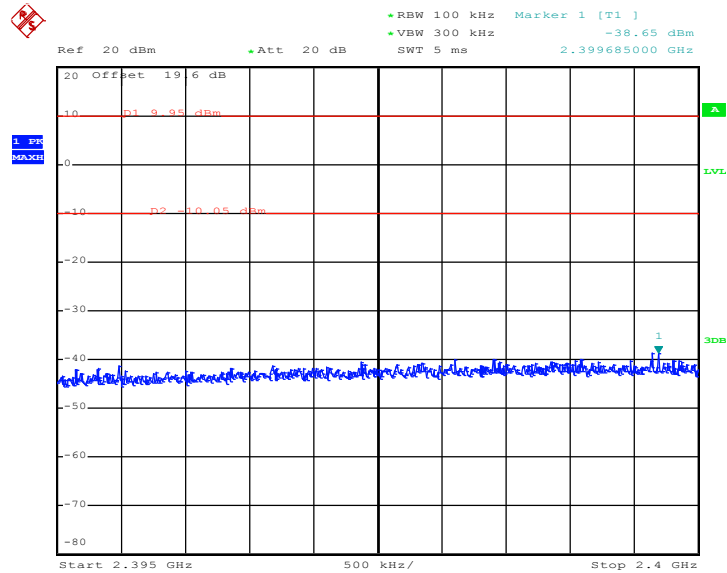

Date: 6.APR.2011 11:54:10

High Band Edge Plot on 802.11b Channel 11

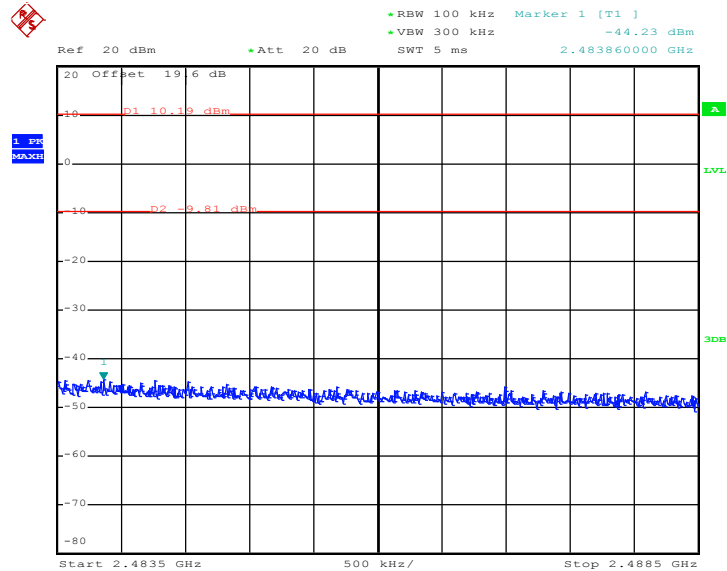

Date: 6.APR.2011 12:00:04



| | | | |
|----------------|--------------|---------------------|-------------|
| Test Mode : | Mode 4 and 6 | Temperature : | 24~26°C |
| Test Band : | 802.11g | Relative Humidity : | 50~53% |
| Test Channel : | 01 and 11 | Test Engineer : | Pinkston Tu |

Low Band Edge Plot on 802.11g Channel 01

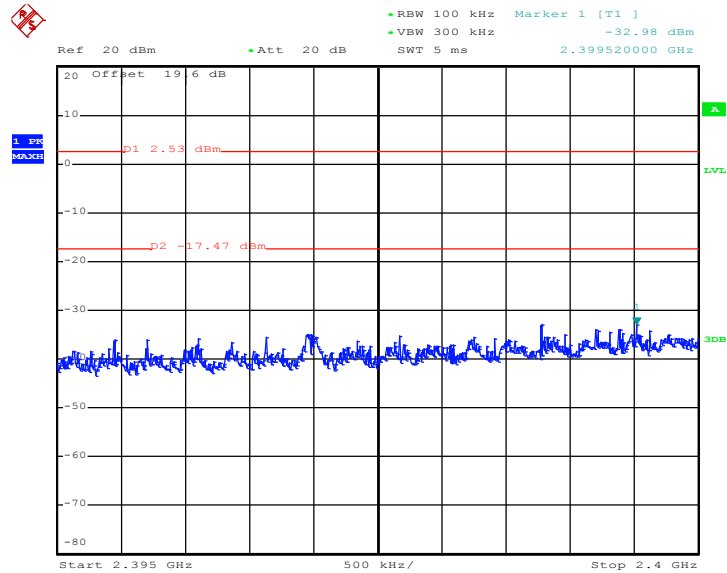

Date: 6.APR.2011 10:13:51

High Band Edge Plot on 802.11g Channel 11

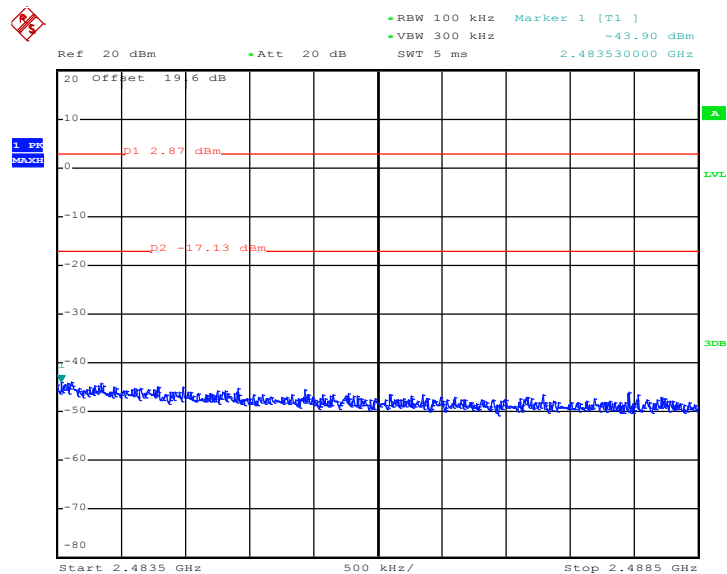

Date: 6.APR.2011 10:43:53



| | | | |
|----------------|--------------------|---------------------|-------------|
| Test Mode : | Mode 7 and 9 | Temperature : | 24~26°C |
| Test Band : | 802.11n (BW 20MHz) | Relative Humidity : | 50~53% |
| Test Channel : | 01 and 11 | Test Engineer : | Pinkston Tu |

Low Band Edge Plot on 802.11n (BW 20MHz) Channel 01

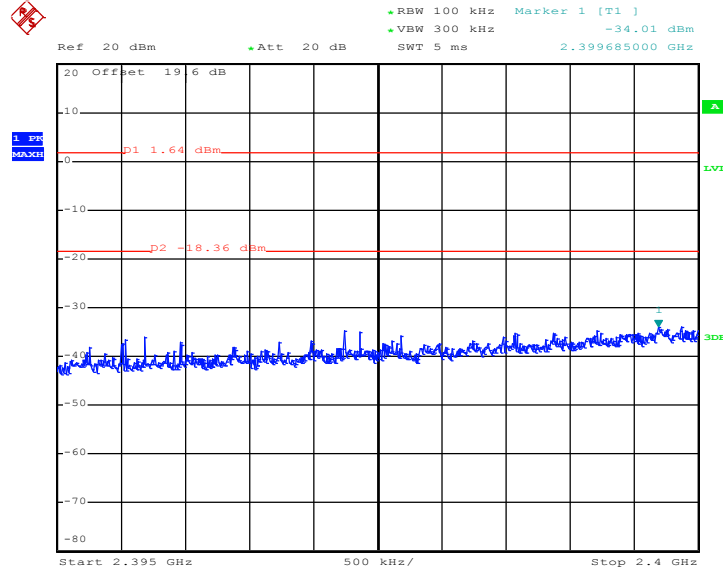

Date: 6.APR.2011 11:25:17

High Band Edge Plot on 802.11n (BW 20MHz) Channel 11

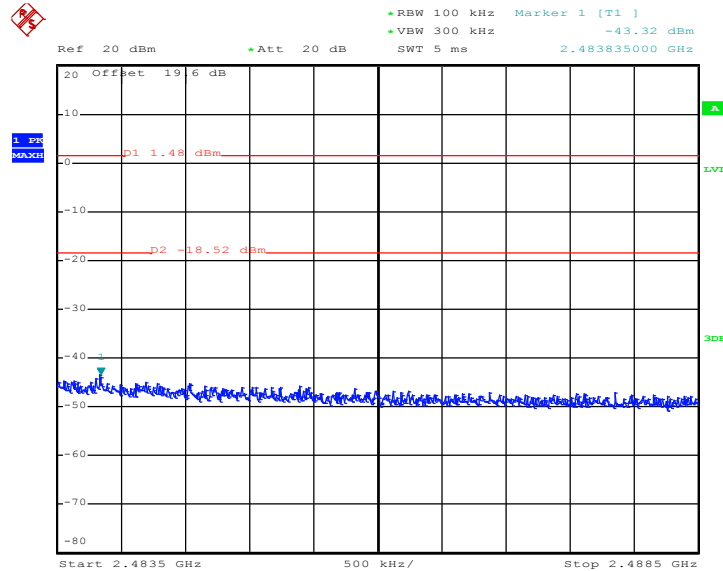

Date: 6.APR.2011 10:57:35

3.4 Spurious Emission Measurement

3.4.1 Limit of Spurious Emission Measurement

All harmonics/spurious must be at least 20 dB down from the highest emission level within the authorized band.

3.4.2 Measuring Instruments

See list of measuring instruments of this test report.

3.4.3 Test Procedure

1. The transmitter output was connected to the spectrum analyzer via a low lose cable.
2. Set RBW = 100 kHz, Video bandwidth (VBW) \geq RBW, scan up through 10th harmonic. All harmonics/spurs must be at least 20 dB down from the highest emission level within the authorized band as measured with a 100 kHz RBW.

3.4.4 Test Setup

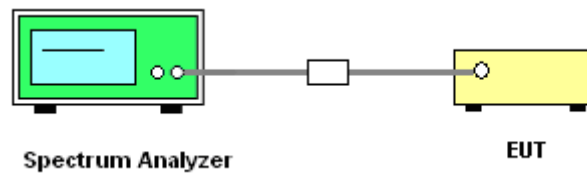



3.4.5 Test Plots of Spurious Emission

| | | | |
|----------------|---------|---------------------|-------------|
| Test Mode : | Mode 1 | Temperature : | 24~26°C |
| Test Band : | 802.11b | Relative Humidity : | 50~53% |
| Test Channel : | 01 | Test Engineer : | Pinkston Tu |

Conducted Spurious Emission Plot between 30MHz ~ 3 GHz

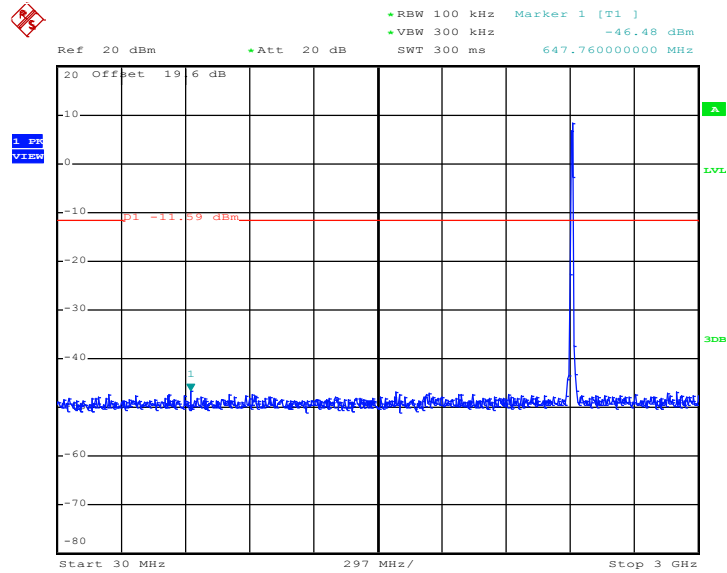

Date: 6.APR.2011 09:40:06

Conducted Spurious Emission Plot between 3 GHz ~ 25 GHz

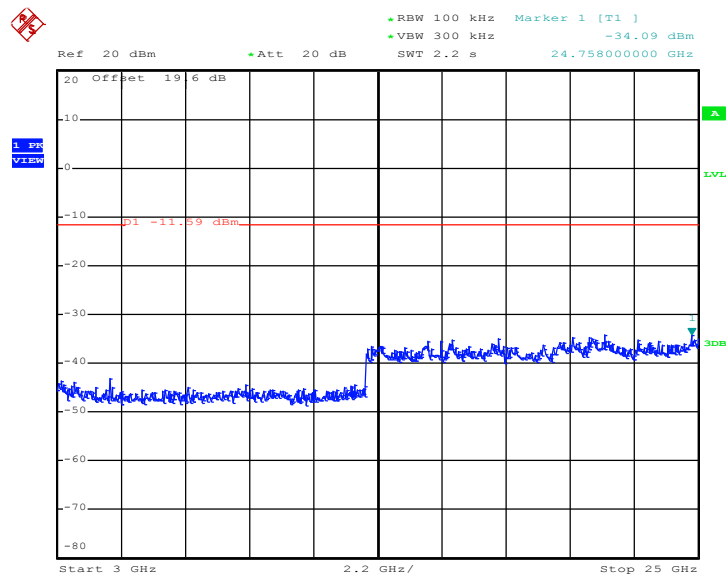

Date: 6.APR.2011 09:40:23



| | | | |
|----------------|---------|---------------------|-------------|
| Test Mode : | Mode 2 | Temperature : | 24~26°C |
| Test Band : | 802.11b | Relative Humidity : | 50~53% |
| Test Channel : | 06 | Test Engineer : | Pinkston Tu |

Conducted Spurious Emission Plot between 30MHz ~ 3 GHz

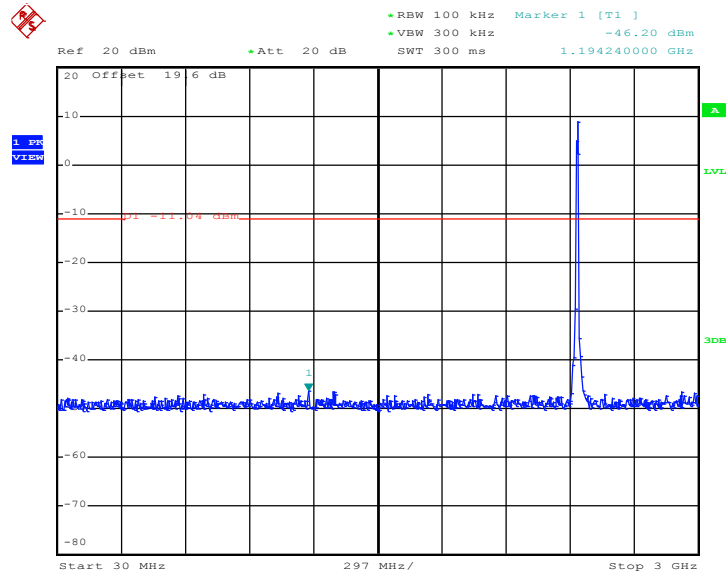

Date: 6.APR.2011 09:52:36

Conducted Spurious Emission Plot between 3 GHz ~ 25 GHz

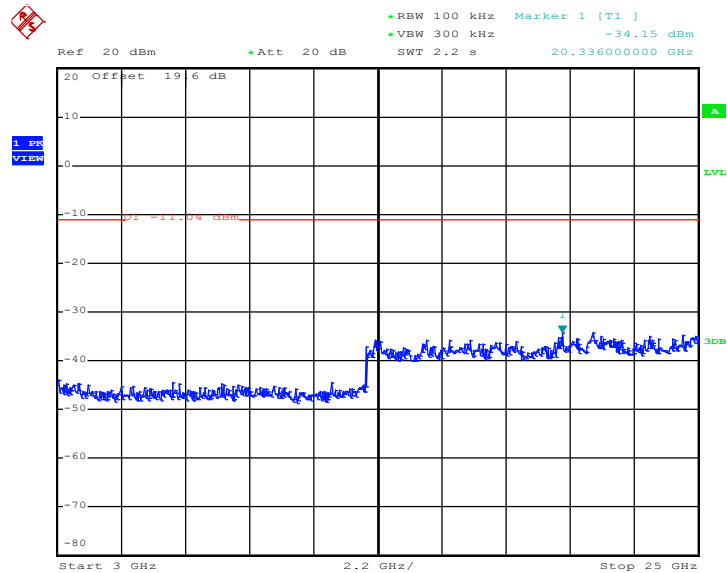

Date: 6.APR.2011 09:52:53



| | | | |
|----------------|---------|---------------------|-------------|
| Test Mode : | Mode 3 | Temperature : | 24~26°C |
| Test Band : | 802.11b | Relative Humidity : | 50~53% |
| Test Channel : | 11 | Test Engineer : | Pinkston Tu |

Conducted Spurious Emission Plot between 30MHz ~ 3 GHz

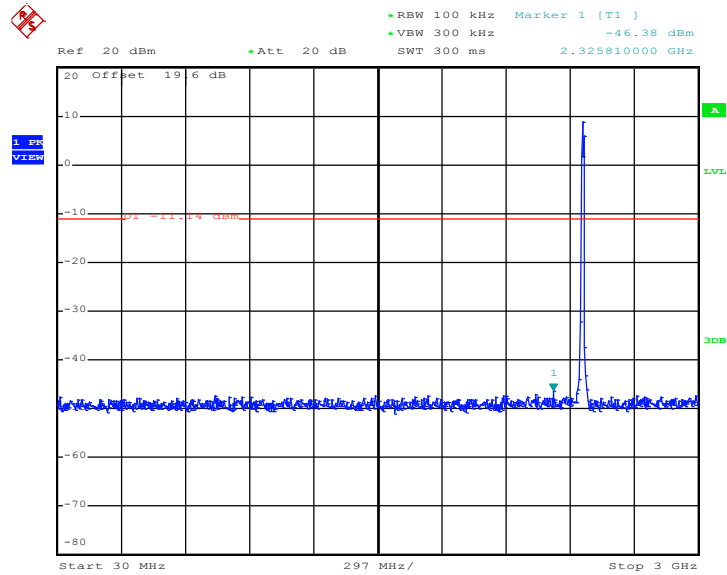

Date: 6.APR.2011 10:05:40

Conducted Spurious Emission Plot between 3 GHz ~ 25 GHz

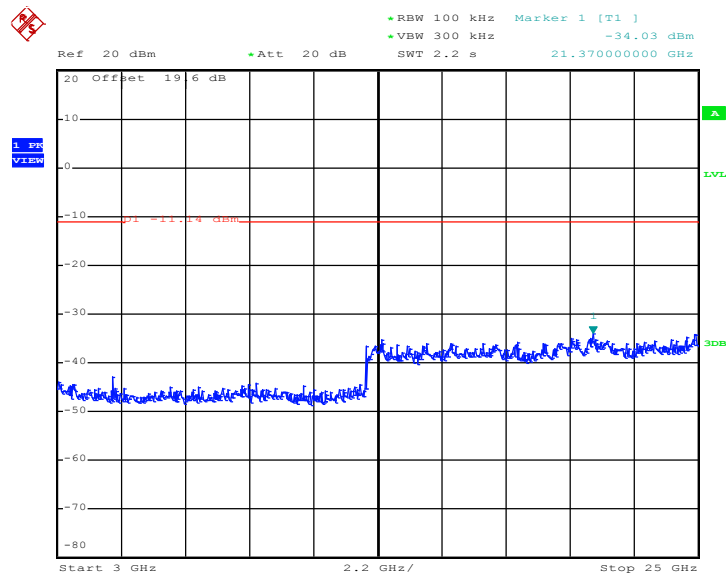

Date: 6.APR.2011 10:05:57



| | | | |
|----------------|---------|---------------------|-------------|
| Test Mode : | Mode 4 | Temperature : | 24~26°C |
| Test Band : | 802.11g | Relative Humidity : | 50~53% |
| Test Channel : | 01 | Test Engineer : | Pinkston Tu |

Conducted Spurious Emission Plot between 30MHz ~ 3 GHz

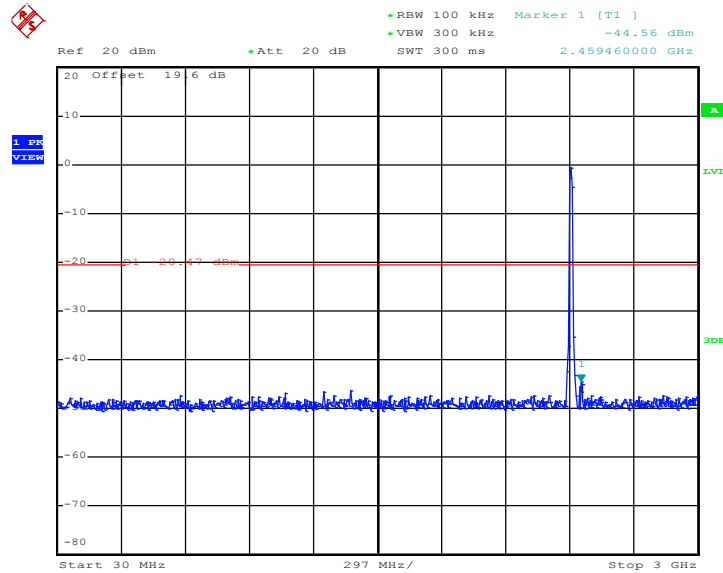

Date: 6.APR.2011 10:23:11

Conducted Spurious Emission Plot between 3 GHz ~ 25 GHz

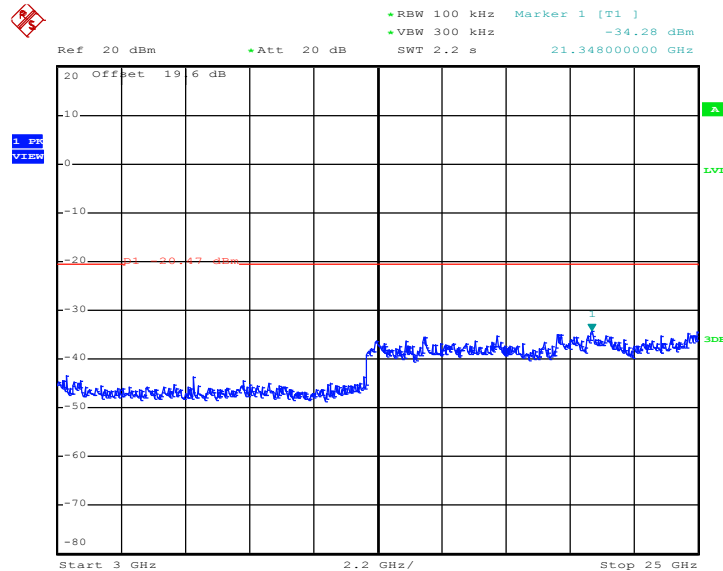

Date: 6.APR.2011 10:23:28



| | | | |
|----------------|---------|---------------------|-------------|
| Test Mode : | Mode 5 | Temperature : | 24~26 |
| Test Band : | 802.11g | Relative Humidity : | 50~53 |
| Test Channel : | 06 | Test Engineer : | Pinkston Tu |

Conducted Spurious Emission Plot between 30MHz ~ 3 GHz

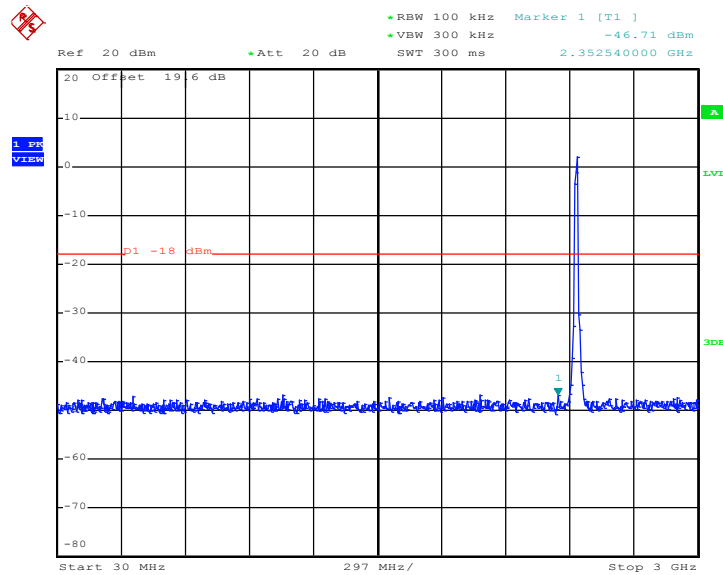

Date: 6.APR.2011 10:37:34

Conducted Spurious Emission Plot between 3 GHz ~ 25 GHz

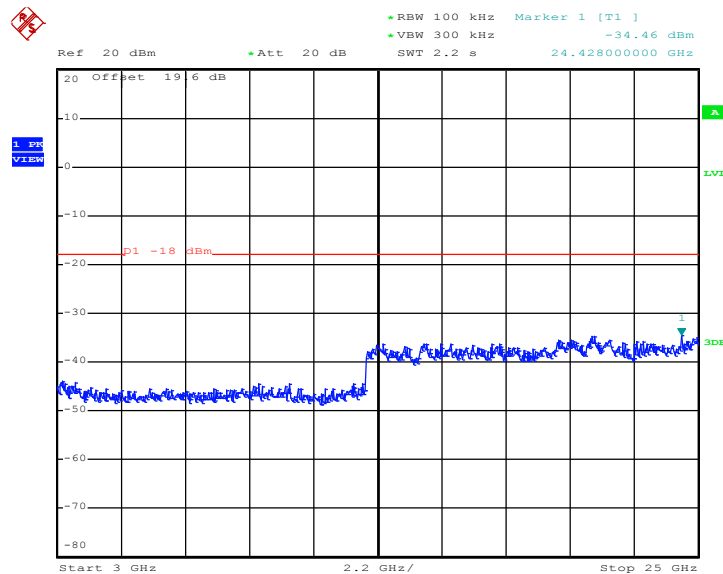

Date: 6.APR.2011 10:37:51



| | | | |
|----------------|---------|---------------------|-------------|
| Test Mode : | Mode 6 | Temperature : | 24~26°C |
| Test Band : | 802.11g | Relative Humidity : | 50~53% |
| Test Channel : | 11 | Test Engineer : | Pinkston Tu |

Conducted Spurious Emission Plot between 30MHz ~ 3 GHz

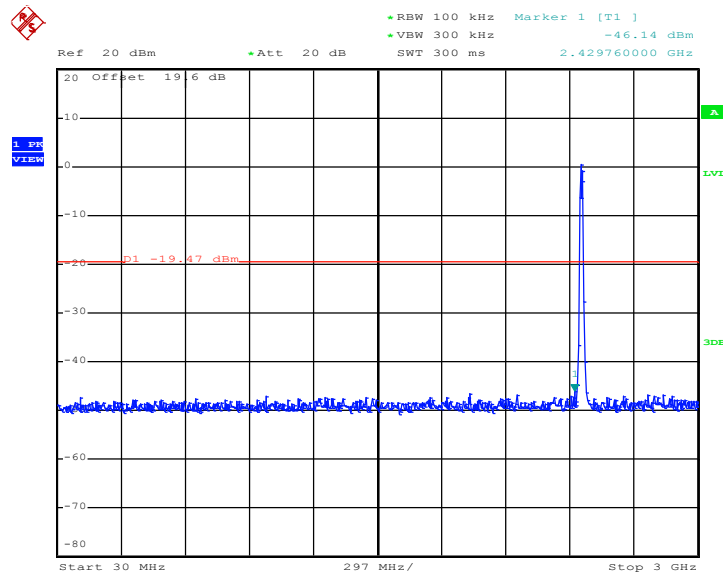

Date: 6.APR.2011 10:53:33

Conducted Spurious Emission Plot between 3 GHz ~ 25 GHz

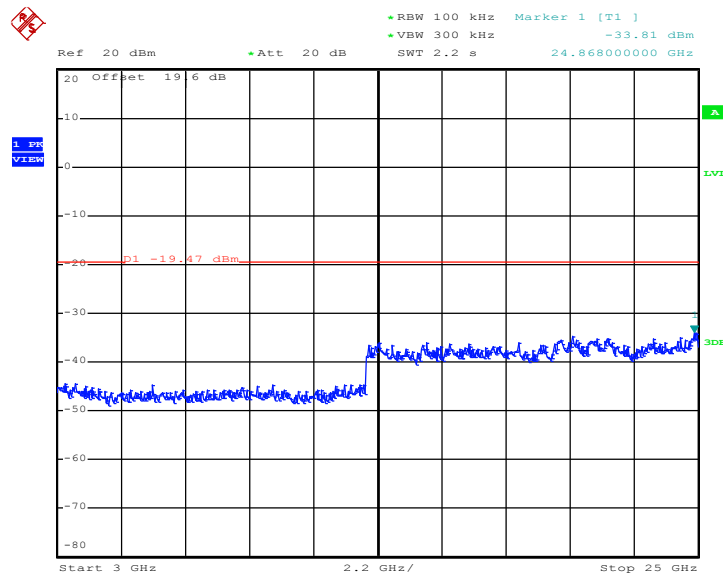

Date: 6.APR.2011 10:53:50



| | | | |
|----------------|--------------------|---------------------|-------------|
| Test Mode : | Mode 7 | Temperature : | 24~26°C |
| Test Band : | 802.11n (BW 20MHz) | Relative Humidity : | 50~53% |
| Test Channel : | 01 | Test Engineer : | Pinkston Tu |

Conducted Spurious Emission Plot between 30MHz ~ 3 GHz

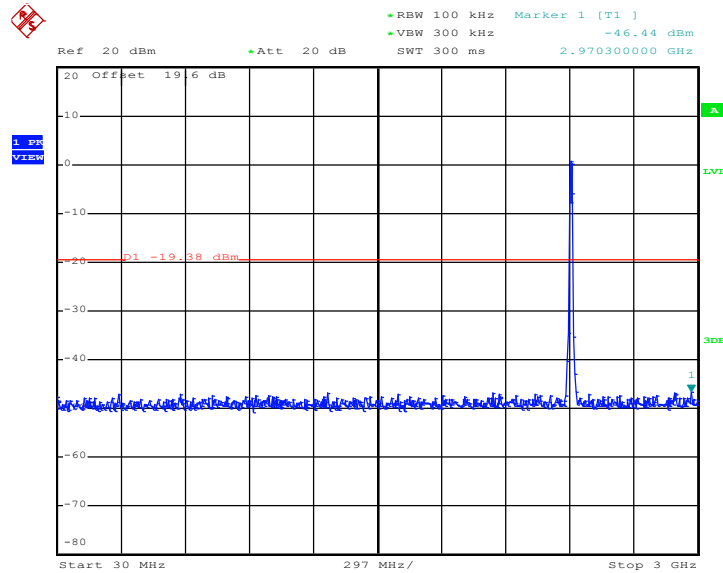

Date: 6.APR.2011 11:34:37

Conducted Spurious Emission Plot between 3 GHz ~ 25 GHz

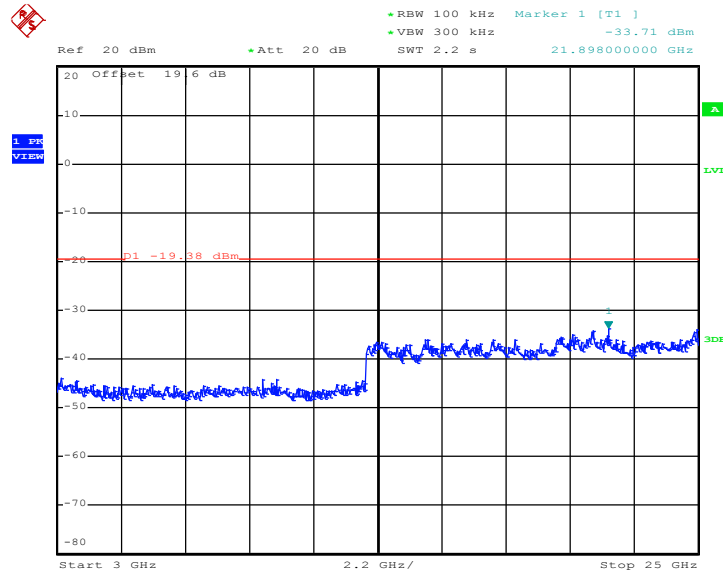

Date: 6.APR.2011 11:34:54



| | | | |
|----------------|--------------------|---------------------|-------------|
| Test Mode : | Mode 8 | Temperature : | 24~26°C |
| Test Band : | 802.11n (BW 20MHz) | Relative Humidity : | 50~53% |
| Test Channel : | 06 | Test Engineer : | Pinkston Tu |

Conducted Spurious Emission Plot between 30MHz ~ 3 GHz

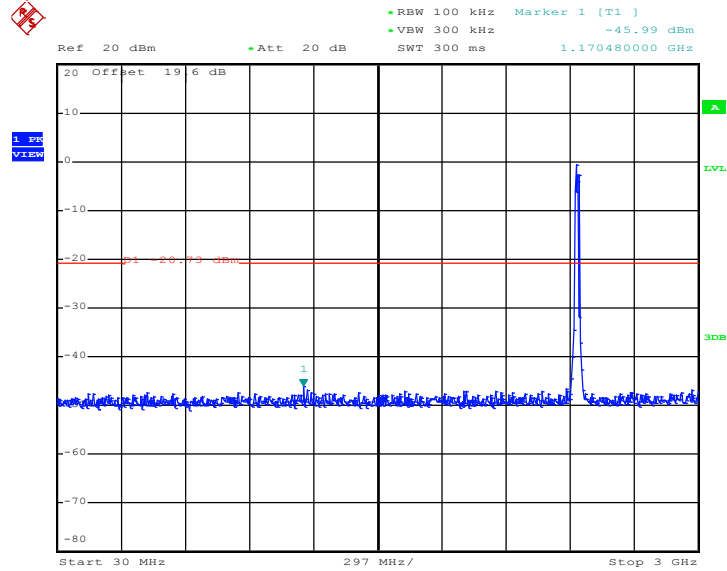

Date: 6.APR.2011 11:19:36

Conducted Spurious Emission Plot between 3 GHz ~ 25 GHz

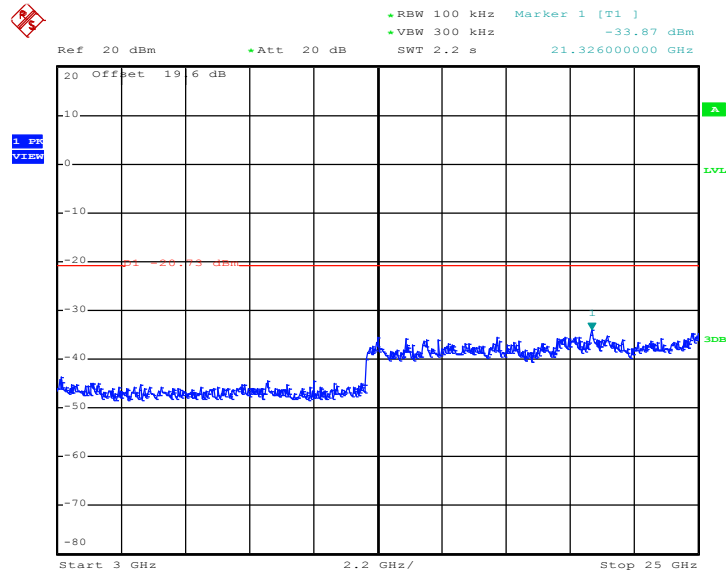

Date: 6.APR.2011 11:19:53



| | | | |
|----------------|--------------------|---------------------|-------------|
| Test Mode : | Mode 9 | Temperature : | 24~26°C |
| Test Band : | 802.11n (BW 20MHz) | Relative Humidity : | 50~53% |
| Test Channel : | 11 | Test Engineer : | Pinkston Tu |

Conducted Spurious Emission Plot between 30MHz ~ 3 GHz

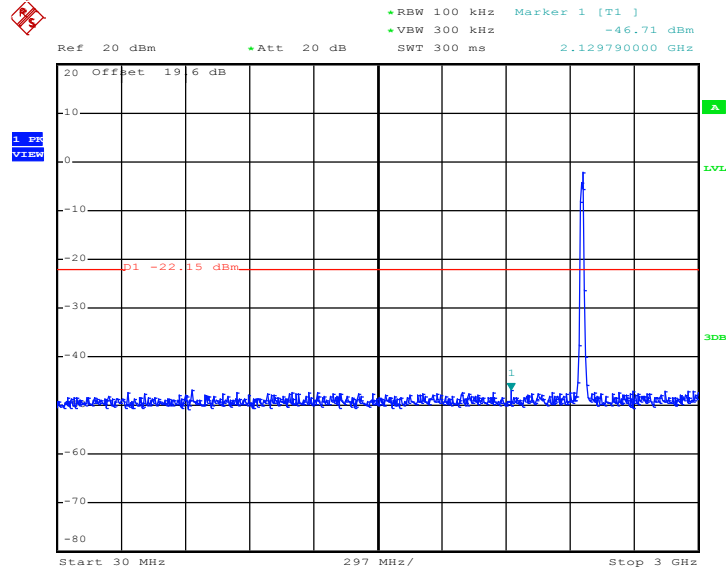

Date: 6.APR.2011 11:06:57

Conducted Spurious Emission Plot between 3 GHz ~ 25 GHz

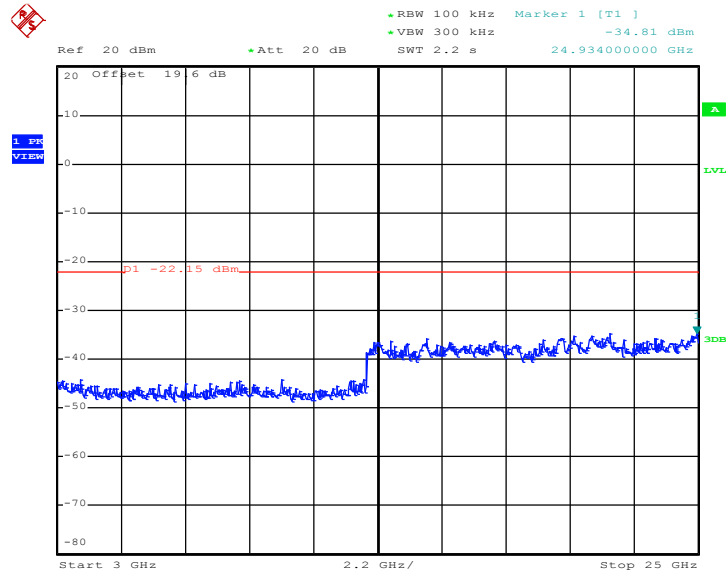

Date: 6.APR.2011 11:07:14

3.5 Power Spectral Density Measurement

3.5.1 Limit of Power Spectral Density

The peak power spectral density shall not be greater than 8dBm in any 3kHz band at any time interval of continuous transmission.

3.5.2 Measuring Instruments

See list of measuring instruments of this test report.

3.5.3 Test Procedures

1. The test follows FCC KDB Publication No. 558074 (Measurement Guidelines of DTS).
2. The RF output of EUT was connected to the spectrum analyzer by a low loss cable.
3. Take the measured data from spectrum analyzer.

3.5.4 Test Setup

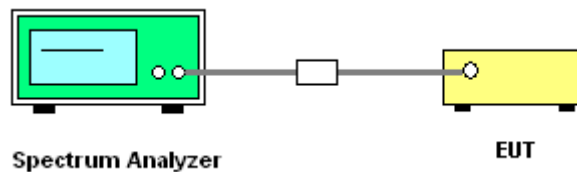



3.5.5 Test Result of Power Spectral Density

| | | | |
|-----------------|--------------|---------------------|---------|
| Test Mode : | Mode 1, 2, 3 | Temperature : | 24~26°C |
| Test Engineer : | Pinkston Tu | Relative Humidity : | 50~53% |

| Channel | Frequency (MHz) | 802.11b Measured PSD (dBm) | Max. Limits (dBm) | Pass/Fail |
|---------|-----------------|----------------------------|-------------------|-----------|
| 01 | 2412 | -4.62 | 8 | Pass |
| 06 | 2437 | -4.37 | 8 | Pass |
| 11 | 2462 | -4.29 | 8 | Pass |

Mode 1 : PSD Plot on 802.11b Channel 01

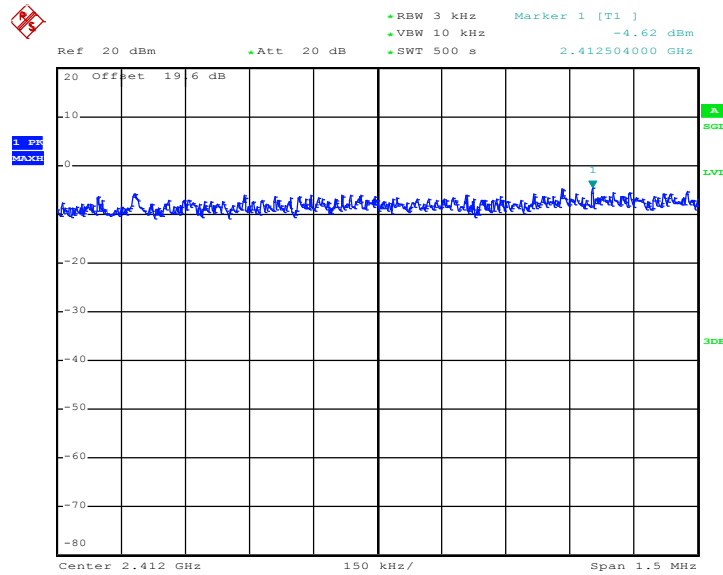

Date: 6.APR.2011 12:39:45



Mode 2 : PSD Plot on 802.11b Channel 06

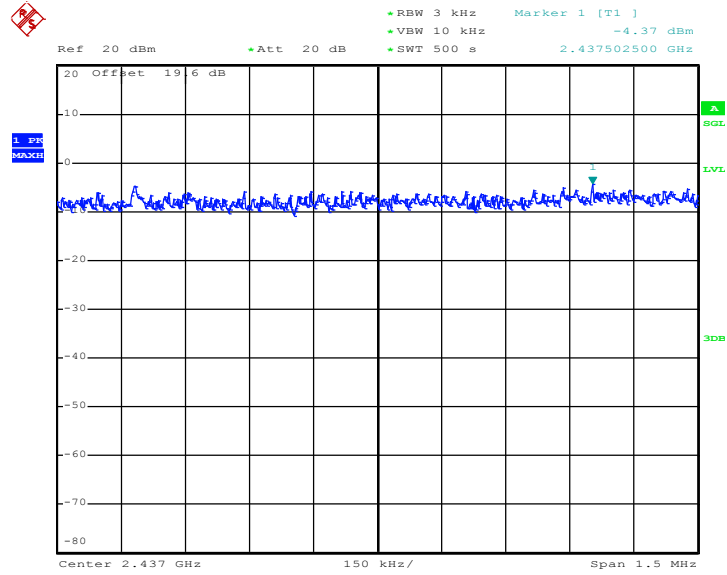

Date: 6.APR.2011 12:29:50

Mode 3 : PSD Plot on 802.11b Channel 11

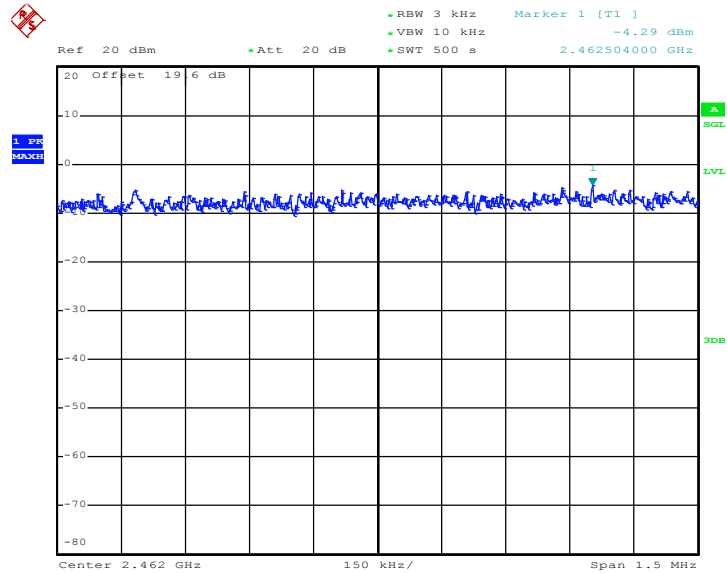

Date: 6.APR.2011 12:20:03



| | | | |
|-----------------|--------------|---------------------|---------|
| Test Mode : | Mode 4, 5, 6 | Temperature : | 24~26°C |
| Test Engineer : | Pinkston Tu | Relative Humidity : | 50~53% |

| Channel | Frequency (MHz) | 802.11g Measured PSD (dBm) | Max. Limits (dBm) | Pass/Fail |
|---------|-----------------|----------------------------|-------------------|-----------|
| 01 | 2412 | -12.65 | 8 | Pass |
| 06 | 2437 | -12.57 | 8 | Pass |
| 11 | 2462 | -11.42 | 8 | Pass |

Mode 4 : PSD Plot on 802.11g Channel 01

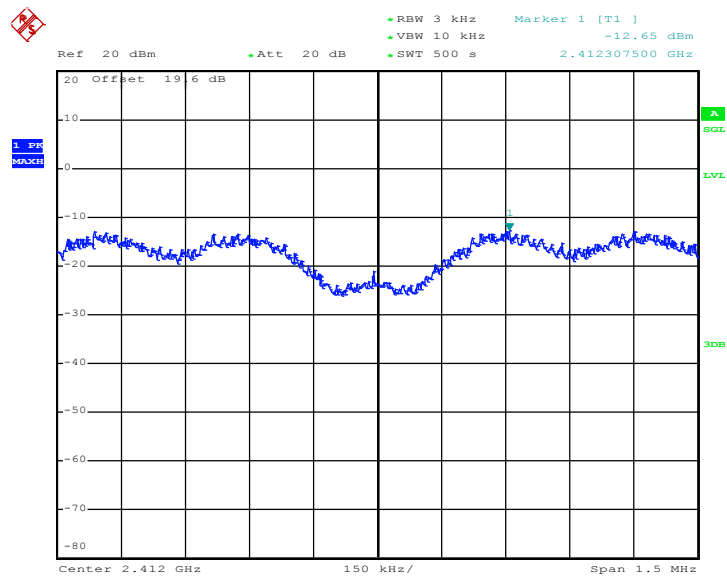

Date: 6.APR.2011 10:22:50



Mode 5 : PSD Plot on 802.11g Channel 06

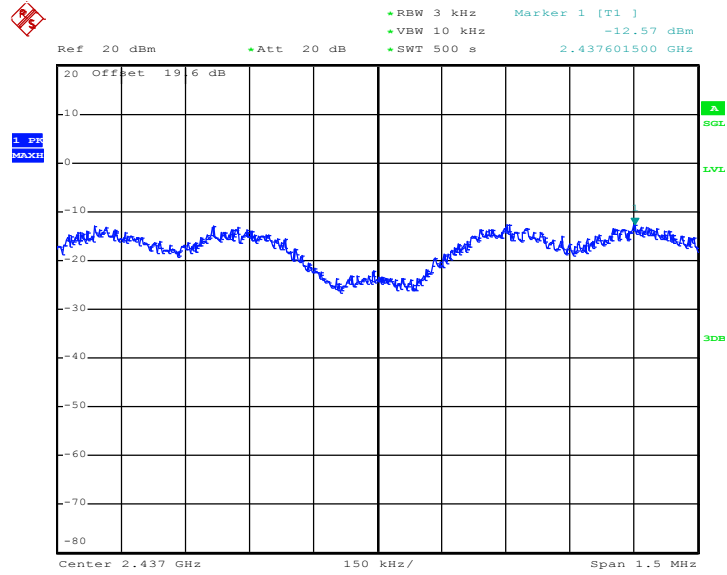

Date: 6.APR.2011 10:37:13

Mode 6 : PSD Plot on 802.11g Channel 11

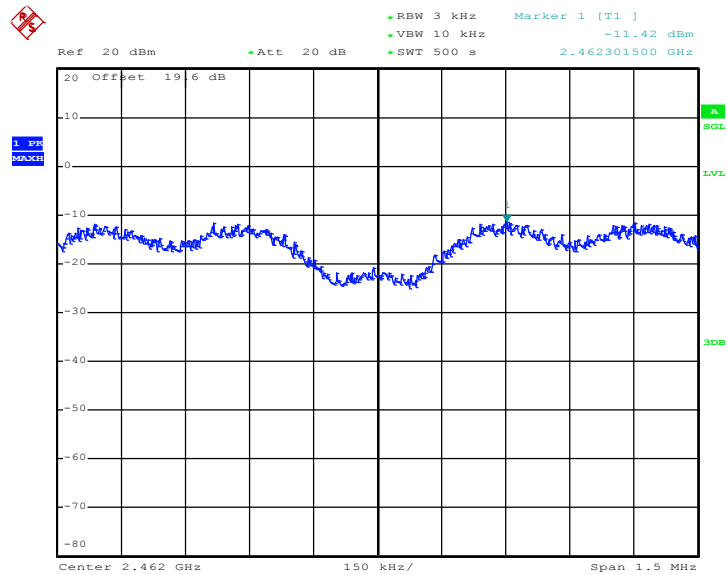

Date: 6.APR.2011 10:53:12



| | | | |
|-----------------|--------------|---------------------|---------|
| Test Mode : | Mode 7, 8, 9 | Temperature : | 24~26°C |
| Test Engineer : | Pinkston Tu | Relative Humidity : | 50~53% |

| Channel | Frequency (MHz) | 802.11n (BW 20MHz) Measured PSD (dBm) | Max. Limits (dBm) | Pass/Fail |
|---------|-----------------|---------------------------------------|-------------------|-----------|
| 01 | 2412 | -11.89 | 8 | Pass |
| 06 | 2437 | -11.93 | 8 | Pass |
| 11 | 2462 | -11.77 | 8 | Pass |

Mode 7 : PSD Plot on 802.11n (BW 20MHz) Channel 01

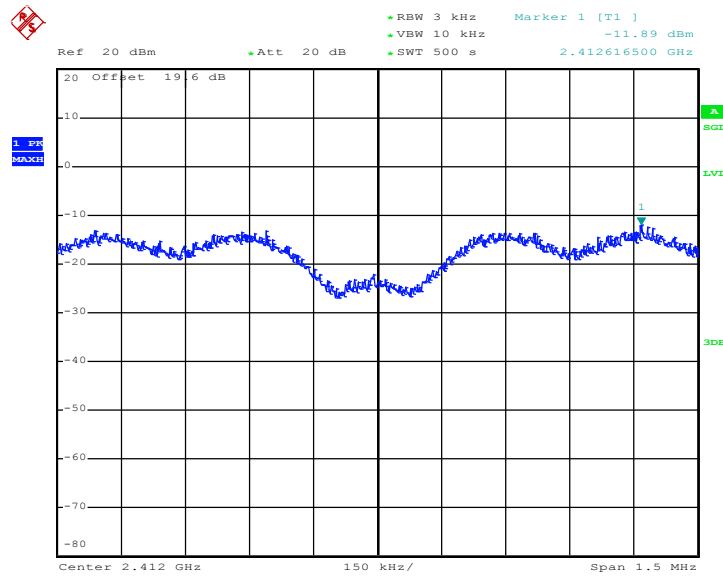

Date: 6.APR.2011 11:34:16



Mode 8 : PSD Plot on 802.11n (BW 20MHz) Channel 06

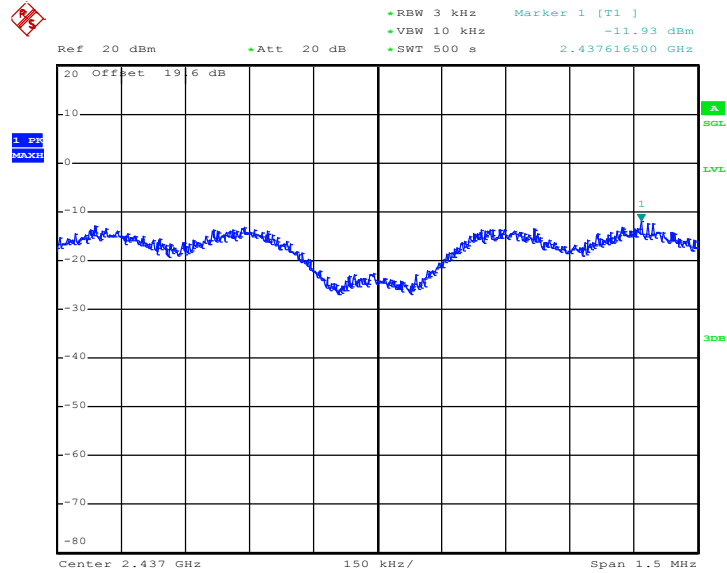

Date: 6.APR.2011 11:19:15

Mode 9 : PSD Plot on 802.11n (BW 20MHz) Channel 11

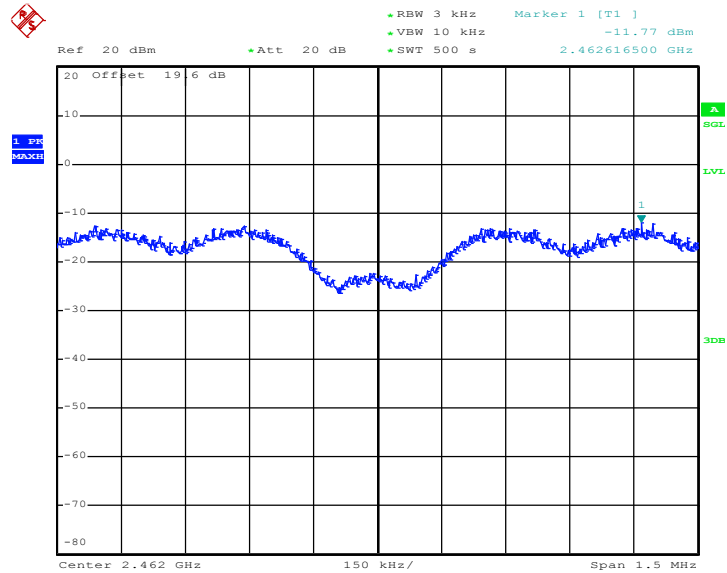

Date: 6.APR.2011 11:06:36

3.6 AC Conducted Emission Measurement

3.6.1 Limit of AC Conducted Emission

For equipment that is designed to be connected to the public utility (AC) power line, the radio frequency voltage that is conducted back onto the AC power line on any frequency or frequencies within the band 150 kHz to 30 MHz shall not exceed the limits in the following table.

| Frequency of Emission (MHz) | Conducted Limit (dBuV) | |
|--------------------------------|------------------------|-----------|
| | Quasi-Peak | Average |
| 0.15-0.5 | 66 to 56* | 56 to 46* |
| 0.5-5 | 56 | 46 |
| 5-30 | 60 | 50 |

*Decreases with the logarithm of the frequency.

3.6.2 Measuring Instruments

See list of measuring instruments of this test report.

3.6.3 Test Procedures

1. The testing follows the guidelines in ANSI C63.4-2003.
2. The EUT was placed 0.4 meter from the conducting wall of the shielding room, and it was kept at least 80 centimeters from any other grounded conducting surface.
3. Connect EUT to the power mains through a line impedance stabilization network (LISN).
4. All the support units are connecting to the other LISN.
5. The LISN provides 50 ohm coupling impedance for the measuring instrument.
6. The FCC states that a 50 ohm, 50 microhenry LISN should be used.
7. Both sides of AC line were checked for maximum conducted interference.
8. The frequency range from 150 kHz to 30 MHz was searched.
9. Set the test-receiver system to Peak Detect Function and specified bandwidth with Maximum Hold Mode.

3.6.4 Test Setup

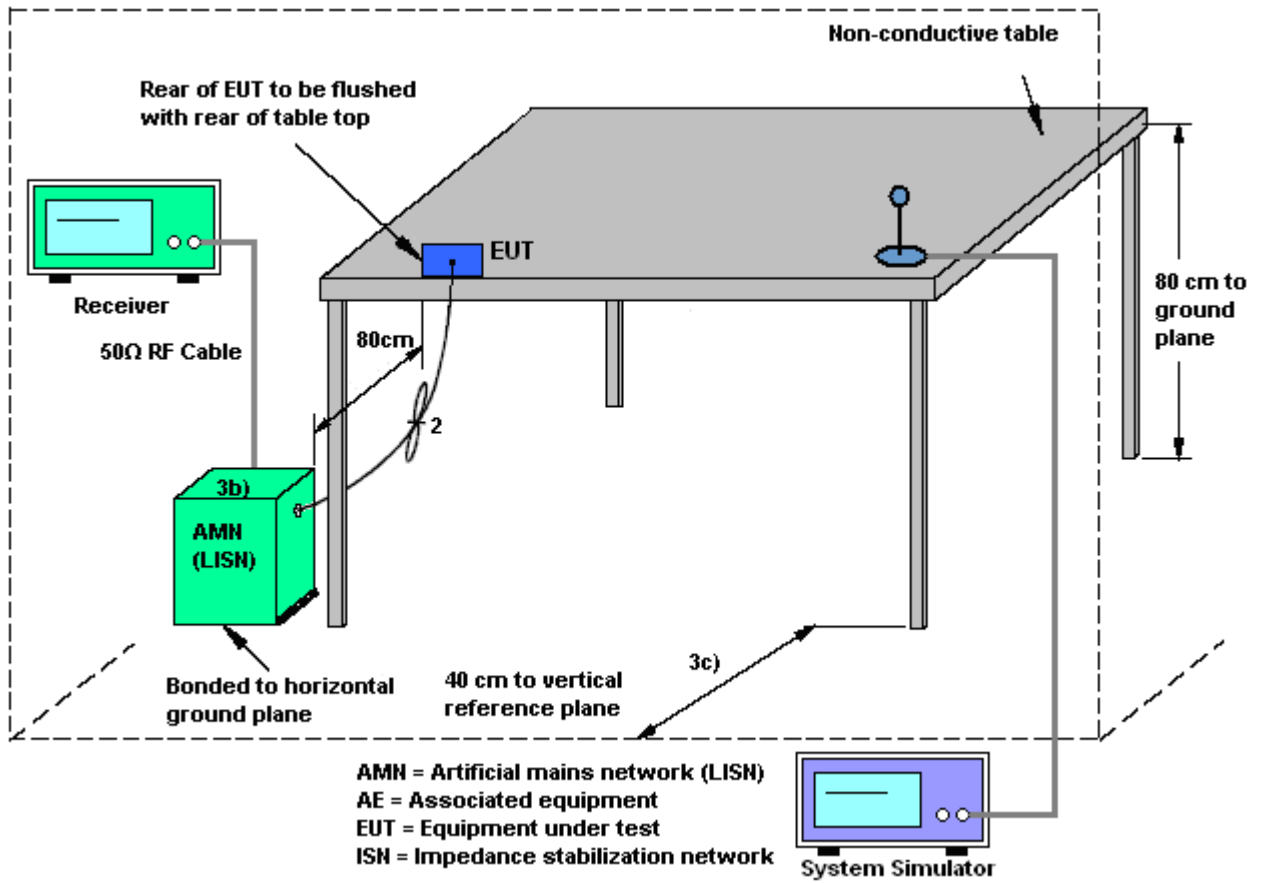

3.6.5 Test Result of AC Conducted Emission

| | | | |
|-----------------|---|---------------------|---------|
| Test Mode : | Mode 2 | Temperature : | 20~22°C |
| Test Engineer : | Novic Chiang | Relative Humidity : | 40~42% |
| Test Voltage : | 120Vac / 60Hz | Phase : | Line |
| Function Type : | CDMA2000 BC1 Idle + Bluetooth Link + WLAN Link + GPS Rx + WiMAX Idle + Battery 2 + Earphone + USB Cable 2 (Charging from Adapter 2) | | |
| Remark : | All emissions not reported here are more than 10 dB below the prescribed limit. | | |

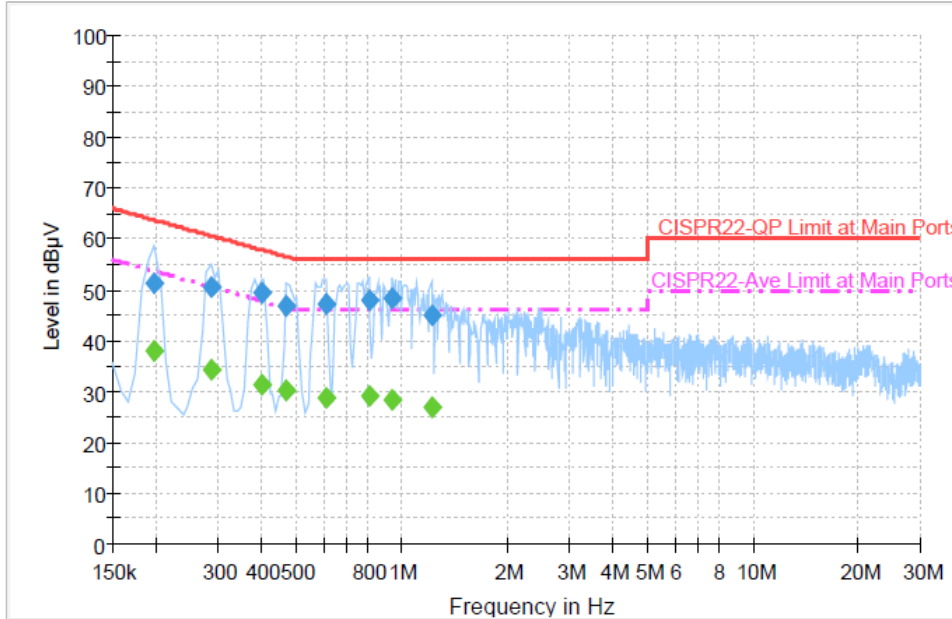

Final Result 1

| Frequency (MHz) | QuasiPeak (dBµV) | Filter | Line | Corr. (dB) | Margin (dB) | Limit (dBµV) |
|-----------------|------------------|--------|------|------------|-------------|--------------|
| 0.198000 | 51.2 | Off | L1 | 19.4 | 12.5 | 63.7 |
| 0.286000 | 50.5 | Off | L1 | 19.4 | 10.1 | 60.6 |
| 0.398000 | 49.6 | Off | L1 | 19.4 | 8.3 | 57.9 |
| 0.470000 | 46.9 | Off | L1 | 19.4 | 9.6 | 56.5 |
| 0.606000 | 47.2 | Off | L1 | 19.4 | 8.8 | 56.0 |
| 0.806000 | 48.0 | Off | L1 | 19.4 | 8.0 | 56.0 |
| 0.942000 | 48.2 | Off | L1 | 19.4 | 7.8 | 56.0 |
| 1.214000 | 45.1 | Off | L1 | 19.4 | 10.9 | 56.0 |

Final Result 2

| Frequency (MHz) | Average (dBµV) | Filter | Line | Corr. (dB) | Margin (dB) | Limit (dBµV) |
|-----------------|----------------|--------|------|------------|-------------|--------------|
| 0.198000 | 37.9 | Off | L1 | 19.4 | 15.8 | 53.7 |
| 0.286000 | 34.3 | Off | L1 | 19.4 | 16.3 | 50.6 |
| 0.398000 | 31.3 | Off | L1 | 19.4 | 16.6 | 47.9 |
| 0.470000 | 30.4 | Off | L1 | 19.4 | 16.1 | 46.5 |
| 0.606000 | 28.8 | Off | L1 | 19.4 | 17.2 | 46.0 |
| 0.806000 | 29.3 | Off | L1 | 19.4 | 16.7 | 46.0 |
| 0.942000 | 28.5 | Off | L1 | 19.4 | 17.5 | 46.0 |
| 1.214000 | 26.8 | Off | L1 | 19.4 | 19.2 | 46.0 |



| | | | |
|-----------------|---|---------------------|---------|
| Test Mode : | Mode 2 | Temperature : | 20~22°C |
| Test Engineer : | Novic Chiang | Relative Humidity : | 40~42% |
| Test Voltage : | 120Vac / 60Hz | Phase : | Neutral |
| Function Type : | CDMA2000 BC1 Idle + Bluetooth Link + WLAN Link + GPS Rx + WiMAX Idle + Battery 2 + Earphone + USB Cable 2 (Charging from Adapter 2) | | |
| Remark : | All emissions not reported here are more than 10 dB below the prescribed limit. | | |

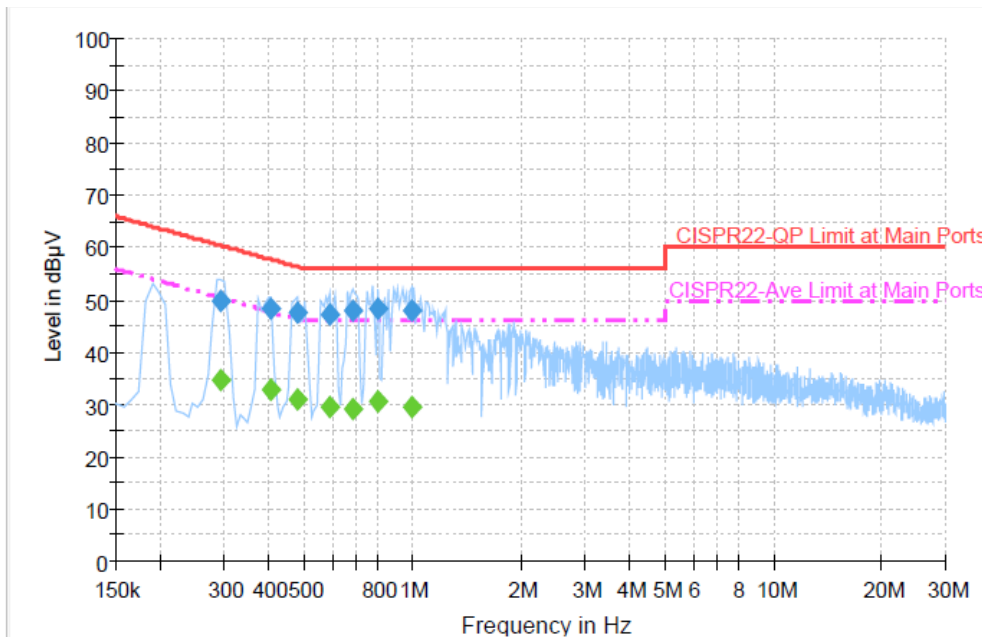

Final Result 1

| Frequency (MHz) | QuasiPeak (dBµV) | Filter | Line | Corr. (dB) | Margin (dB) | Limit (dBµV) |
|-----------------|------------------|--------|------|------------|-------------|--------------|
| 0.294000 | 49.7 | Off | N | 19.4 | 10.7 | 60.4 |
| 0.406000 | 48.3 | Off | N | 19.5 | 9.4 | 57.7 |
| 0.478000 | 47.5 | Off | N | 19.4 | 8.9 | 56.4 |
| 0.590000 | 47.3 | Off | N | 19.4 | 8.7 | 56.0 |
| 0.686000 | 47.8 | Off | N | 19.5 | 8.2 | 56.0 |
| 0.798000 | 48.3 | Off | N | 19.4 | 7.7 | 56.0 |
| 0.990000 | 48.1 | Off | N | 19.5 | 7.9 | 56.0 |

Final Result 2

| Frequency (MHz) | Average (dBµV) | Filter | Line | Corr. (dB) | Margin (dB) | Limit (dBµV) |
|-----------------|----------------|--------|------|------------|-------------|--------------|
| 0.294000 | 34.8 | Off | N | 19.4 | 15.6 | 50.4 |
| 0.406000 | 32.9 | Off | N | 19.5 | 14.8 | 47.7 |
| 0.478000 | 31.0 | Off | N | 19.4 | 15.4 | 46.4 |
| 0.590000 | 29.7 | Off | N | 19.4 | 16.3 | 46.0 |
| 0.686000 | 29.0 | Off | N | 19.5 | 17.0 | 46.0 |
| 0.798000 | 30.7 | Off | N | 19.4 | 15.3 | 46.0 |
| 0.990000 | 29.4 | Off | N | 19.5 | 16.6 | 46.0 |

3.7 Radiated Emission Measurement

3.7.1 Limit of Radiated Emission

In any 100 kHz bandwidth outside the intentional radiator frequency band, all harmonics/spurious must be at least 20 dB below the highest emission level within the authorized band. If the output power of this device was measured by spectrum analyzer, the attenuation under this paragraph shall be 30 dB instead of 20 dB. In addition, radiated emissions which fall in the restricted bands must also comply with the FCC section 15.209 limits as below.

| Frequency (MHz) | Field Strength (microvolts/meter) | Measurement Distance (meters) |
|-----------------|-----------------------------------|-------------------------------|
| 0.009 – 0.490 | 2400/F(kHz) | 300 |
| 0.490 – 1.705 | 24000/F(kHz) | 30 |
| 1.705 – 30.0 | 30 | 30 |
| 30 – 88 | 100 | 3 |
| 88 – 216 | 150 | 3 |
| 216 - 960 | 200 | 3 |
| Above 960 | 500 | 3 |

3.7.2 Measuring Instruments

See list of measuring instruments of this test report.

3.7.3 Test Procedures

- The testing follows the guidelines in FCC KDB Publication No. 558074 (Measurement Guidelines of DTS).
- Use the following spectrum analyzer settings:
 - Span = wide enough to fully capture the emission being measured; RBW = 1 MHz for $f \geq 1$ GHz, 100 kHz for $f < 1$ GHz; VBW \geq RBW; Sweep = auto; Detector function = peak; Trace = max hold.
 - Above 18 GHz shall be extrapolated to the specified distance using an extrapolation factor of 20 dB/decade from 3m to 1m.
Distance extrapolation factor = $20 \log(\text{specific distance [3m]} / \text{test distance [1m]})$ (dB)
- Follow the guidelines in ANSI C63.4-2003 with respect to maximizing the emission by rotating the EUT, measuring the emission for three EUT orthogonal planes, and adjusting the measurement antenna height and polarization. A pre-amp and a high pass filter are used for this test in order to get the good signal level.

3.7.4 Test Setup

For radiated emissions below 30MHz

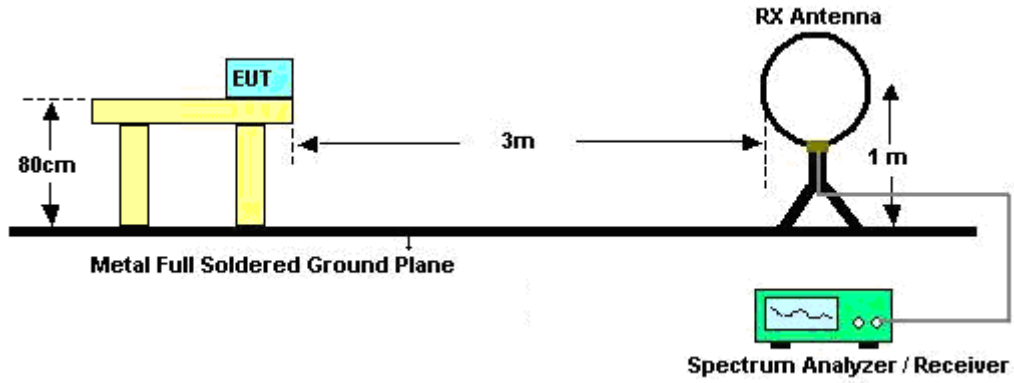

For radiated emissions from 30MHz to 1GHz

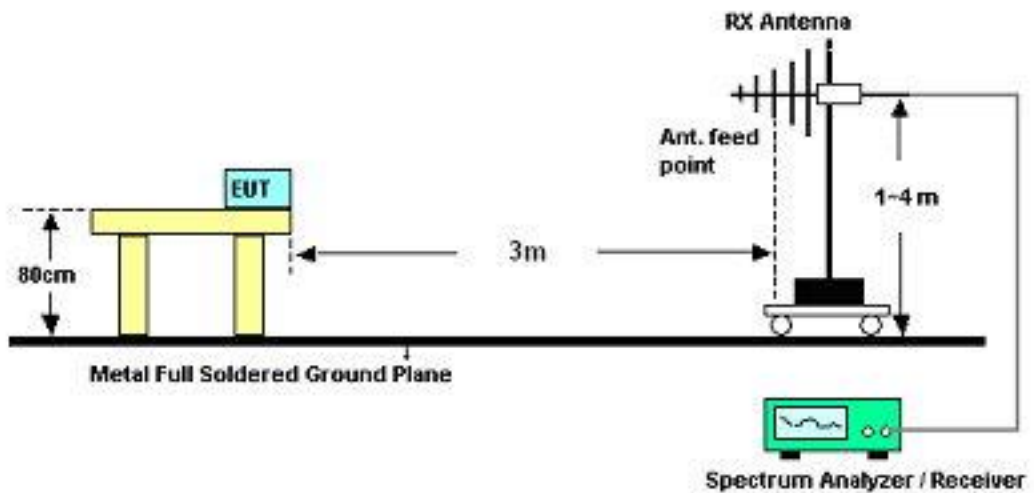

For radiated emissions above 1GHz

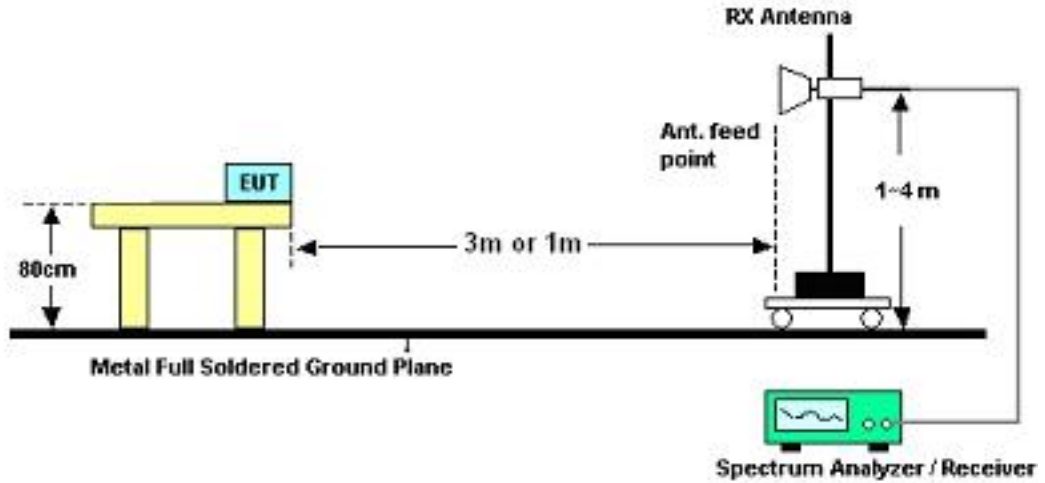

3.7.5 Test Results of Radiated Emissions (9 kHz ~ 30 MHz)

| Test Engineer : | Kay Wu | Temperature : | 21~22°C | |
|-----------------|--------------|---------------------|-------------------|----------|
| | | Relative Humidity : | 47~48% | |
| Frequency (MHz) | Level (dBuV) | Over Limit (dB) | Limit Line (dBuV) | Remark |
| - | - | - | - | See Note |

Note:

The amplitude of spurious emissions that are attenuated by more than 20dB below the permissible value has no need to be reported.

Distance extrapolation factor = 40 log (specific distance / test distance) (dB);

Limit line = specific limits (dBuV) + distance extrapolation factor.



3.7.6 Test Result of Radiated Emission (30 MHz ~ 10th Harmonic)

| | | | |
|-----------------|---|---------------------|------------|
| Test Mode : | Mode 1 | Temperature : | 21~22°C |
| Test Channel : | 01 | Relative Humidity : | 47~48% |
| Test Engineer : | Kay Wu | Polarization : | Horizontal |
| Remark : | 2412 MHz is Fundamental Signals which can be ignored. | | |

| Frequency (MHz) | Level (dBuV/m) | Over Limit (dB) | Limit Line (dBuV/m) | Read Level (dBuV) | Antenna Factor (dB) | Cable Loss (dB) | Preamp Factor (dB) | Ant Pos (cm) | Table Pos (deg) | Remark |
|----------------------|---------------------|-------------------------|-----------------------------|---------------------------|-----------------------------|-------------------------|----------------------------|----------------------|-------------------------|---------|
| 30 | 16.9 | -23.1 | 40 | 29.99 | 17.91 | 0.72 | 31.72 | - | - | Peak |
| 51.06 | 23.44 | -16.56 | 40 | 46.35 | 7.92 | 0.87 | 31.7 | 110 | 217 | Peak |
| 219.54 | 17.94 | -28.06 | 46 | 37.26 | 10.63 | 1.73 | 31.68 | - | - | Peak |
| 764.8 | 22.78 | -23.22 | 46 | 31.21 | 20.29 | 3.35 | 32.07 | - | - | Peak |
| 805.4 | 24.06 | -21.94 | 46 | 31.83 | 20.81 | 3.38 | 31.96 | - | - | Peak |
| 861.4 | 24.91 | -21.09 | 46 | 31.86 | 21.3 | 3.59 | 31.84 | - | - | Peak |
| 2389.99 | 50.83 | -23.17 | 74 | 47.92 | 31.9 | 5.4 | 34.39 | 100 | 337 | Peak |
| 2389.99 | 38.83 | -15.17 | 54 | 35.92 | 31.9 | 5.4 | 34.39 | 100 | 337 | Average |
| 2412 | 106.18 | - | - | 103.23 | 31.91 | 5.43 | 34.39 | 100 | 337 | Peak |
| 2412 | 93.51 | - | - | 90.56 | 31.91 | 5.43 | 34.39 | 100 | 337 | Average |
| 2500 | 45.69 | -28.31 | 74 | 42.54 | 32 | 5.52 | 34.37 | 100 | 337 | Peak |
| 2500 | 33.61 | -20.39 | 54 | 30.46 | 32 | 5.52 | 34.37 | 100 | 337 | Average |
| 4824 | 54.82 | -19.18 | 74 | 68.91 | 34.4 | 7.96 | 56.45 | 100 | 47 | Peak |
| 4824 | 40.14 | -13.86 | 54 | 54.23 | 34.4 | 7.96 | 56.45 | 100 | 47 | Average |



| | | | |
|------------------------|---|----------------------------|----------|
| Test Mode : | Mode 1 | Temperature : | 21~22°C |
| Test Channel : | 01 | Relative Humidity : | 47~48% |
| Test Engineer : | Kay Wu | Polarization : | Vertical |
| Remark : | 2412 MHz is Fundamental Signals which can be ignored. | | |

| Frequency (MHz) | Level (dBuV/m) | Over Limit (dB) | Limit Line (dBuV/m) | Read Level (dBuV) | Antenna Factor (dB) | Cable Loss (dB) | Preamp Factor (dB) | Ant Pos (cm) | Table Pos (deg) | Remark |
|----------------------|---------------------|-------------------------|-----------------------------|---------------------------|-----------------------------|-------------------------|----------------------------|----------------------|-------------------------|---------|
| 48.09 | 29.38 | -10.62 | 40 | 51.47 | 8.78 | 0.84 | 31.71 | - | - | Peak |
| 53.22 | 34.44 | -5.56 | 40 | 57.65 | 7.6 | 0.88 | 31.69 | 101 | 156 | Peak |
| 57.54 | 34.1 | -5.9 | 40 | 57.91 | 6.95 | 0.92 | 31.68 | - | - | Peak |
| 742.4 | 22.52 | -23.48 | 46 | 31.3 | 19.97 | 3.34 | 32.09 | - | - | Peak |
| 784.4 | 24.33 | -21.67 | 46 | 32.42 | 20.56 | 3.36 | 32.01 | - | - | Peak |
| 859.3 | 24.67 | -21.33 | 46 | 31.66 | 21.28 | 3.58 | 31.85 | - | - | Peak |
| 2389.61 | 48.43 | -25.57 | 74 | 45.52 | 31.9 | 5.4 | 34.39 | 105 | 233 | Peak |
| 2389.61 | 35.88 | -18.12 | 54 | 32.97 | 31.9 | 5.4 | 34.39 | 105 | 233 | Average |
| 2412 | 104.83 | - | - | 101.88 | 31.91 | 5.43 | 34.39 | 105 | 233 | Peak |
| 2412 | 90.86 | - | - | 87.91 | 31.91 | 5.43 | 34.39 | 105 | 233 | Average |
| 2484 | 46.5 | -27.5 | 74 | 43.37 | 31.98 | 5.52 | 34.37 | 105 | 233 | Peak |
| 2484 | 32.68 | -21.32 | 54 | 29.55 | 31.98 | 5.52 | 34.37 | 105 | 233 | Average |
| 4824 | 55.72 | -18.28 | 74 | 69.81 | 34.4 | 7.96 | 56.45 | 100 | 41 | Peak |
| 4824 | 43.82 | -10.18 | 54 | 57.91 | 34.4 | 7.96 | 56.45 | 100 | 41 | Average |



| | | | |
|------------------------|---|----------------------------|------------|
| Test Mode : | Mode 2 | Temperature : | 21~22°C |
| Test Channel : | 06 | Relative Humidity : | 47~48% |
| Test Engineer : | Kay Wu | Polarization : | Horizontal |
| Remark : | 2437 MHz is Fundamental Signals which can be ignored. | | |

| Frequency (MHz) | Level (dBuV/m) | Over Limit (dB) | Limit Line (dBuV/m) | Read Level (dBuV) | Antenna Factor (dB) | Cable Loss (dB) | Preamp Factor (dB) | Ant Pos (cm) | Table Pos (deg) | Remark |
|----------------------|---------------------|-------------------------|-----------------------------|---------------------------|-----------------------------|-------------------------|----------------------------|----------------------|-------------------------|---------|
| 50.79 | 24.04 | -15.96 | 40 | 46.81 | 8.08 | 0.86 | 31.71 | 100 | 291 | Peak |
| 92.64 | 16.47 | -27.03 | 43.5 | 37.46 | 9.56 | 1.16 | 31.71 | - | - | Peak |
| 153.39 | 17.71 | -25.79 | 43.5 | 37.41 | 10.51 | 1.47 | 31.68 | - | - | Peak |
| 533.8 | 21 | -25 | 46 | 31.79 | 18.27 | 2.79 | 31.85 | - | - | Peak |
| 805.4 | 24.06 | -21.94 | 46 | 31.83 | 20.81 | 3.38 | 31.96 | - | - | Peak |
| 946.8 | 25.31 | -20.69 | 46 | 30.84 | 21.84 | 3.79 | 31.16 | - | - | Peak |
| 2390 | 46.28 | -27.72 | 74 | 43.37 | 31.9 | 5.4 | 34.39 | 100 | 343 | Peak |
| 2390 | 34.12 | -19.88 | 54 | 31.21 | 31.9 | 5.4 | 34.39 | 100 | 343 | Average |
| 2437 | 103.87 | - | - | 100.84 | 31.95 | 5.46 | 34.38 | 100 | 343 | Peak |
| 2437 | 91.41 | - | - | 88.38 | 31.95 | 5.46 | 34.38 | 100 | 343 | Average |
| 2484 | 47.33 | -26.67 | 74 | 44.2 | 31.98 | 5.52 | 34.37 | 100 | 343 | Peak |
| 2484 | 33.24 | -20.76 | 54 | 30.11 | 31.98 | 5.52 | 34.37 | 100 | 343 | Average |
| 4874 | 50.39 | -23.61 | 74 | 64.5 | 34.37 | 8.01 | 56.49 | 100 | 220 | Peak |
| 4874 | 38.38 | -15.62 | 54 | 52.49 | 34.37 | 8.01 | 56.49 | 100 | 220 | Average |



| | | | |
|------------------------|---|----------------------------|----------|
| Test Mode : | Mode 2 | Temperature : | 21~22°C |
| Test Channel : | 06 | Relative Humidity : | 47~48% |
| Test Engineer : | Kay Wu | Polarization : | Vertical |
| Remark : | 2437 MHz is Fundamental Signals which can be ignored. | | |

| Frequency (MHz) | Level (dBuV/m) | Over Limit (dB) | Limit Line (dBuV/m) | Read Level (dBuV) | Antenna Factor (dB) | Cable Loss (dB) | Preamp Factor (dB) | Ant Pos (cm) | Table Pos (deg) | Remark |
|----------------------|---------------------|-------------------------|-----------------------------|---------------------------|-----------------------------|-------------------------|----------------------------|----------------------|-------------------------|---------|
| 48.09 | 29.38 | -10.62 | 40 | 51.47 | 8.78 | 0.84 | 31.71 | - | - | Peak |
| 52.68 | 35.29 | -4.71 | 40 | 58.34 | 7.76 | 0.88 | 31.69 | 100 | 58 | Peak |
| 92.64 | 27.65 | -15.85 | 43.5 | 48.64 | 9.56 | 1.16 | 31.71 | - | - | Peak |
| 612.9 | 22.36 | -23.64 | 46 | 32.3 | 19.2 | 2.95 | 32.09 | - | - | Peak |
| 784.4 | 24.33 | -21.67 | 46 | 32.42 | 20.56 | 3.36 | 32.01 | - | - | Peak |
| 899.9 | 25.65 | -20.35 | 46 | 31.86 | 21.63 | 3.76 | 31.6 | - | - | Peak |
| 2364 | 46.25 | -27.75 | 74 | 43.42 | 31.86 | 5.37 | 34.4 | 100 | 229 | Peak |
| 2364 | 33.37 | -20.63 | 54 | 30.54 | 31.86 | 5.37 | 34.4 | 100 | 229 | Average |
| 2437 | 102.33 | - | - | 99.3 | 31.95 | 5.46 | 34.38 | 100 | 229 | Peak |
| 2437 | 88.21 | - | - | 85.18 | 31.95 | 5.46 | 34.38 | 100 | 229 | Average |
| 2484 | 46.97 | -27.03 | 74 | 43.84 | 31.98 | 5.52 | 34.37 | 100 | 229 | Peak |
| 2484 | 33.38 | -20.62 | 54 | 30.25 | 31.98 | 5.52 | 34.37 | 100 | 229 | Average |
| 4874 | 50.36 | -23.64 | 74 | 64.47 | 34.37 | 8.01 | 56.49 | 100 | 44 | Peak |
| 4874 | 38.96 | -15.04 | 54 | 53.07 | 34.37 | 8.01 | 56.49 | 100 | 44 | Average |



| | | | |
|------------------------|---|----------------------------|------------|
| Test Mode : | Mode 3 | Temperature : | 21~22°C |
| Test Channel : | 11 | Relative Humidity : | 47~48% |
| Test Engineer : | Kay Wu | Polarization : | Horizontal |
| Remark : | 2462 MHz is Fundamental Signals which can be ignored. | | |

| Frequency (MHz) | Level (dBuV/m) | Over Limit (dB) | Limit Line (dBuV/m) | Read Level (dBuV) | Antenna Factor (dB) | Cable Loss (dB) | Preamp Factor (dB) | Ant Pos (cm) | Table Pos (deg) | Remark |
|----------------------|---------------------|-------------------------|-----------------------------|---------------------------|-----------------------------|-------------------------|----------------------------|----------------------|-------------------------|---------|
| 49.98 | 24.35 | -15.65 | 40 | 47.12 | 8.08 | 0.86 | 31.71 | 100 | 39 | Peak |
| 153.93 | 18.1 | -25.4 | 43.5 | 37.86 | 10.45 | 1.47 | 31.68 | - | - | Peak |
| 222.24 | 18.7 | -27.3 | 46 | 37.8 | 10.82 | 1.74 | 31.66 | - | - | Peak |
| 512.8 | 20.04 | -25.96 | 46 | 31.13 | 18 | 2.72 | 31.81 | - | - | Peak |
| 768.3 | 23.45 | -22.55 | 46 | 31.83 | 20.33 | 3.35 | 32.06 | - | - | Peak |
| 906.9 | 25.08 | -20.92 | 46 | 31.19 | 21.66 | 3.76 | 31.53 | - | - | Peak |
| 2364 | 46.12 | -27.88 | 74 | 43.29 | 31.86 | 5.37 | 34.4 | 100 | 328 | Peak |
| 2364 | 39.75 | -14.25 | 54 | 36.92 | 31.86 | 5.37 | 34.4 | 100 | 328 | Average |
| 2462 | 105.8 | - | - | 102.72 | 31.97 | 5.49 | 34.38 | 100 | 328 | Peak |
| 2462 | 92.88 | - | - | 89.8 | 31.97 | 5.49 | 34.38 | 100 | 328 | Average |
| 2483.85 | 52.75 | -21.25 | 74 | 49.62 | 31.98 | 5.52 | 34.37 | 100 | 328 | Peak |
| 2483.85 | 40.14 | -13.86 | 54 | 37.01 | 31.98 | 5.52 | 34.37 | 100 | 328 | Average |
| 4924 | 62.81 | -11.19 | 74 | 76.95 | 34.34 | 8.04 | 56.52 | 102 | 14 | Peak |
| 4924 | 49.09 | -4.91 | 54 | 63.23 | 34.34 | 8.04 | 56.52 | 102 | 14 | Average |



| | | | |
|------------------------|---|----------------------------|----------|
| Test Mode : | Mode 3 | Temperature : | 21~22°C |
| Test Channel : | 11 | Relative Humidity : | 47~48% |
| Test Engineer : | Kay Wu | Polarization : | Vertical |
| Remark : | 2462 MHz is Fundamental Signals which can be ignored. | | |

| Frequency (MHz) | Level (dBuV/m) | Over Limit (dB) | Limit Line (dBuV/m) | Read Level (dBuV) | Antenna Factor (dB) | Cable Loss (dB) | Preamp Factor (dB) | Ant Pos (cm) | Table Pos (deg) | Remark |
|----------------------|---------------------|-------------------------|-----------------------------|---------------------------|-----------------------------|-------------------------|----------------------------|----------------------|-------------------------|---------|
| 48.63 | 30.26 | -9.74 | 40 | 52.35 | 8.78 | 0.84 | 31.71 | - | - | Peak |
| 52.68 | 34.53 | -5.47 | 40 | 57.58 | 7.76 | 0.88 | 31.69 | 100 | 289 | Peak |
| 91.29 | 26.99 | -16.51 | 43.5 | 48.32 | 9.24 | 1.15 | 31.72 | - | - | Peak |
| 386.8 | 18.74 | -27.26 | 46 | 32.67 | 15.47 | 2.36 | 31.76 | - | - | Peak |
| 715.8 | 22.3 | -23.7 | 46 | 31.44 | 19.6 | 3.3 | 32.04 | - | - | Peak |
| 868.4 | 25.33 | -20.67 | 46 | 32.15 | 21.35 | 3.62 | 31.79 | - | - | Peak |
| 2340 | 45.96 | -28.04 | 74 | 43.19 | 31.84 | 5.34 | 34.41 | 103 | 0 | Peak |
| 2340 | 35.62 | -18.38 | 54 | 32.85 | 31.84 | 5.34 | 34.41 | 103 | 0 | Average |
| 2462 | 102.1 | - | - | 99.02 | 31.97 | 5.49 | 34.38 | 103 | 0 | Peak |
| 2462 | 91.4 | - | - | 88.32 | 31.97 | 5.49 | 34.38 | 103 | 0 | Average |
| 2483.5 | 51.77 | -22.23 | 74 | 48.64 | 31.98 | 5.52 | 34.37 | 103 | 0 | Peak |
| 2483.5 | 39.22 | -14.78 | 54 | 36.09 | 31.98 | 5.52 | 34.37 | 103 | 0 | Average |
| 4924 | 62.79 | -11.21 | 74 | 76.93 | 34.34 | 8.04 | 56.52 | 100 | 53 | Peak |
| 4924 | 50.22 | -3.78 | 54 | 64.36 | 34.34 | 8.04 | 56.52 | 100 | 53 | Average |



| | | | |
|------------------------|---|----------------------------|------------|
| Test Mode : | Mode 4 | Temperature : | 21~22°C |
| Test Channel : | 01 | Relative Humidity : | 47~48% |
| Test Engineer : | Kay Wu | Polarization : | Horizontal |
| Remark : | 2412 MHz is Fundamental Signals which can be ignored. | | |

| Frequency (MHz) | Level (dBuV/m) | Over Limit (dB) | Limit Line (dBuV/m) | Read Level (dBuV) | Antenna Factor (dB) | Cable Loss (dB) | Preamp Factor (dB) | Ant Pos (cm) | Table Pos (deg) | Remark |
|----------------------|---------------------|-------------------------|-----------------------------|---------------------------|-----------------------------|-------------------------|----------------------------|----------------------|-------------------------|---------|
| 49.98 | 24.26 | -15.74 | 40 | 47.03 | 8.08 | 0.86 | 31.71 | 100 | 189 | Peak |
| 153.39 | 18.27 | -25.23 | 43.5 | 37.97 | 10.51 | 1.47 | 31.68 | - | - | Peak |
| 222.24 | 18.41 | -27.59 | 46 | 37.51 | 10.82 | 1.74 | 31.66 | - | - | Peak |
| 497.4 | 19.93 | -26.07 | 46 | 31.28 | 17.77 | 2.66 | 31.78 | - | - | Peak |
| 691.3 | 22.27 | -23.73 | 46 | 31.67 | 19.37 | 3.23 | 32 | - | - | Peak |
| 880.3 | 25.24 | -20.76 | 46 | 31.82 | 21.46 | 3.68 | 31.72 | - | - | Peak |
| 2389.61 | 53.8 | -20.2 | 74 | 50.89 | 31.9 | 5.4 | 34.39 | 104 | 323 | Peak |
| 2389.61 | 37.05 | -16.95 | 54 | 34.14 | 31.9 | 5.4 | 34.39 | 104 | 323 | Average |
| 2412 | 100.2 | - | - | 97.25 | 31.91 | 5.43 | 34.39 | 104 | 323 | Peak |
| 2412 | 87.9 | - | - | 84.95 | 31.91 | 5.43 | 34.39 | 104 | 323 | Average |
| 2484 | 45.31 | -28.69 | 74 | 42.18 | 31.98 | 5.52 | 34.37 | 104 | 323 | Peak |
| 2484 | 33.08 | -20.92 | 54 | 29.95 | 31.98 | 5.52 | 34.37 | 104 | 323 | Average |



| | | | |
|------------------------|---|----------------------------|----------|
| Test Mode : | Mode 4 | Temperature : | 21~22°C |
| Test Channel : | 01 | Relative Humidity : | 47~48% |
| Test Engineer : | Kay Wu | Polarization : | Vertical |
| Remark : | 2412 MHz is Fundamental Signals which can be ignored. | | |

| Frequency (MHz) | Level (dBuV/m) | Over Limit (dB) | Limit Line (dBuV/m) | Read Level (dBuV) | Antenna Factor (dB) | Cable Loss (dB) | Preamp Factor (dB) | Ant Pos (cm) | Table Pos (deg) | Remark |
|----------------------|---------------------|-------------------------|-----------------------------|---------------------------|-----------------------------|-------------------------|----------------------------|----------------------|-------------------------|---------|
| 48.63 | 29.06 | -10.94 | 40 | 51.15 | 8.78 | 0.84 | 31.71 | - | - | Peak |
| 52.68 | 35.11 | -4.89 | 40 | 58.16 | 7.76 | 0.88 | 31.69 | 100 | 352 | Peak |
| 92.64 | 27.58 | -15.92 | 43.5 | 48.57 | 9.56 | 1.16 | 31.71 | - | - | Peak |
| 504.4 | 20.31 | -25.69 | 46 | 31.54 | 17.88 | 2.68 | 31.79 | - | - | Peak |
| 754.3 | 23.3 | -22.7 | 46 | 31.91 | 20.14 | 3.35 | 32.1 | - | - | Peak |
| 932.8 | 25.17 | -20.83 | 46 | 30.9 | 21.78 | 3.78 | 31.29 | - | - | Peak |
| 2389.99 | 55.26 | -18.74 | 74 | 52.35 | 31.9 | 5.4 | 34.39 | 108 | 18 | Peak |
| 2389.99 | 37.74 | -16.26 | 54 | 34.83 | 31.9 | 5.4 | 34.39 | 108 | 18 | Average |
| 2412 | 101.56 | - | - | 98.61 | 31.91 | 5.43 | 34.39 | 108 | 18 | Peak |
| 2412 | 89.21 | - | - | 86.26 | 31.91 | 5.43 | 34.39 | 108 | 18 | Average |
| 2484 | 45.87 | -28.13 | 74 | 42.74 | 31.98 | 5.52 | 34.37 | 108 | 18 | Peak |
| 2484 | 33.3 | -20.7 | 54 | 30.17 | 31.98 | 5.52 | 34.37 | 108 | 18 | Average |



| | | | |
|------------------------|---|----------------------------|------------|
| Test Mode : | Mode 5 | Temperature : | 21~22°C |
| Test Channel : | 06 | Relative Humidity : | 47~48% |
| Test Engineer : | Kay Wu | Polarization : | Horizontal |
| Remark : | 2437 MHz is Fundamental Signals which can be ignored. | | |

| Frequency (MHz) | Level (dBuV/m) | Over Limit (dB) | Limit Line (dBuV/m) | Read Level (dBuV) | Antenna Factor (dB) | Cable Loss (dB) | Preamp Factor (dB) | Ant Pos (cm) | Table Pos (deg) | Remark |
|----------------------|---------------------|-------------------------|-----------------------------|---------------------------|-----------------------------|-------------------------|----------------------------|----------------------|-------------------------|---------|
| 50.79 | 23.13 | -16.87 | 40 | 45.9 | 8.08 | 0.86 | 31.71 | 100 | 49 | Peak |
| 175.53 | 18.24 | -25.26 | 43.5 | 38.81 | 9.55 | 1.56 | 31.68 | - | - | Peak |
| 222.24 | 18.37 | -27.63 | 46 | 37.47 | 10.82 | 1.74 | 31.66 | - | - | Peak |
| 496.7 | 19.51 | -26.49 | 46 | 30.88 | 17.75 | 2.66 | 31.78 | - | - | Peak |
| 668.9 | 22.24 | -23.76 | 46 | 31.77 | 19.32 | 3.13 | 31.98 | - | - | Peak |
| 873.3 | 25.14 | -20.86 | 46 | 31.86 | 21.4 | 3.64 | 31.76 | - | - | Peak |
| 2390 | 45.48 | -28.52 | 74 | 42.57 | 31.9 | 5.4 | 34.39 | 100 | 318 | Peak |
| 2390 | 33.67 | -20.33 | 54 | 30.76 | 31.9 | 5.4 | 34.39 | 100 | 318 | Average |
| 2437 | 100.06 | - | - | 97.03 | 31.95 | 5.46 | 34.38 | 100 | 318 | Peak |
| 2437 | 87.81 | - | - | 84.78 | 31.95 | 5.46 | 34.38 | 100 | 318 | Average |
| 2484 | 45.61 | -28.39 | 74 | 42.48 | 31.98 | 5.52 | 34.37 | 100 | 318 | Peak |
| 2484 | 33.33 | -20.67 | 54 | 30.2 | 31.98 | 5.52 | 34.37 | 100 | 318 | Average |



| | | | |
|------------------------|---|----------------------------|----------|
| Test Mode : | Mode 5 | Temperature : | 21~22°C |
| Test Channel : | 06 | Relative Humidity : | 47~48% |
| Test Engineer : | Kay Wu | Polarization : | Vertical |
| Remark : | 2437 MHz is Fundamental Signals which can be ignored. | | |

| Frequency (MHz) | Level (dBuV/m) | Over Limit (dB) | Limit Line (dBuV/m) | Read Level (dBuV) | Antenna Factor (dB) | Cable Loss (dB) | Preamp Factor (dB) | Ant Pos (cm) | Table Pos (deg) | Remark |
|----------------------|---------------------|-------------------------|-----------------------------|---------------------------|-----------------------------|-------------------------|----------------------------|----------------------|-------------------------|---------|
| 30.54 | 27.42 | -12.58 | 40 | 41.11 | 17.31 | 0.72 | 31.72 | - | - | Peak |
| 52.68 | 34.25 | -5.75 | 40 | 57.3 | 7.76 | 0.88 | 31.69 | 100 | 129 | Peak |
| 91.29 | 26.62 | -16.88 | 43.5 | 47.95 | 9.24 | 1.15 | 31.72 | - | - | Peak |
| 567.4 | 21.19 | -24.81 | 46 | 31.56 | 18.73 | 2.87 | 31.97 | - | - | Peak |
| 712.3 | 22.16 | -23.84 | 46 | 31.35 | 19.55 | 3.29 | 32.03 | - | - | Peak |
| 906.9 | 25.64 | -20.36 | 46 | 31.75 | 21.66 | 3.76 | 31.53 | - | - | Peak |
| 2390 | 45.83 | -28.17 | 74 | 42.92 | 31.9 | 5.4 | 34.39 | 130 | 15 | Peak |
| 2390 | 33.67 | -20.33 | 54 | 30.76 | 31.9 | 5.4 | 34.39 | 130 | 15 | Average |
| 2437 | 101.76 | - | - | 98.73 | 31.95 | 5.46 | 34.38 | 130 | 15 | Peak |
| 2437 | 89.34 | - | - | 86.31 | 31.95 | 5.46 | 34.38 | 130 | 15 | Average |
| 2484 | 46.08 | -27.92 | 74 | 42.95 | 31.98 | 5.52 | 34.37 | 130 | 15 | Peak |
| 2484 | 33.85 | -20.15 | 54 | 30.72 | 31.98 | 5.52 | 34.37 | 130 | 15 | Average |



| | | | |
|------------------------|---|----------------------------|------------|
| Test Mode : | Mode 6 | Temperature : | 21~22°C |
| Test Channel : | 11 | Relative Humidity : | 47~48% |
| Test Engineer : | Kay Wu | Polarization : | Horizontal |
| Remark : | 2462 MHz is Fundamental Signals which can be ignored. | | |

| Frequency (MHz) | Level (dBuV/m) | Over Limit (dB) | Limit Line (dBuV/m) | Read Level (dBuV) | Antenna Factor (dB) | Cable Loss (dB) | Preamp Factor (dB) | Ant Pos (cm) | Table Pos (deg) | Remark |
|----------------------|---------------------|-------------------------|-----------------------------|---------------------------|-----------------------------|-------------------------|----------------------------|----------------------|-------------------------|---------|
| 49.98 | 24.23 | -15.77 | 40 | 47 | 8.08 | 0.86 | 31.71 | 100 | 108 | Peak |
| 154.74 | 17.83 | -25.67 | 43.5 | 37.64 | 10.39 | 1.47 | 31.67 | - | - | Peak |
| 224.94 | 18.62 | -27.38 | 46 | 37.5 | 11.01 | 1.75 | 31.64 | - | - | Peak |
| 525.4 | 21.35 | -24.65 | 46 | 32.25 | 18.17 | 2.76 | 31.83 | - | - | Peak |
| 761.3 | 23.75 | -22.25 | 46 | 32.25 | 20.23 | 3.35 | 32.08 | - | - | Peak |
| 920.9 | 26.43 | -19.57 | 46 | 32.34 | 21.72 | 3.77 | 31.4 | - | - | Peak |
| 2388 | 48.04 | -25.96 | 74 | 45.13 | 31.9 | 5.4 | 34.39 | 101 | 313 | Peak |
| 2388 | 34.97 | -19.03 | 54 | 32.06 | 31.9 | 5.4 | 34.39 | 101 | 313 | Average |
| 2462 | 101.1 | - | - | 98.02 | 31.97 | 5.49 | 34.38 | 101 | 313 | Peak |
| 2462 | 89.09 | - | - | 86.01 | 31.97 | 5.49 | 34.38 | 101 | 313 | Average |
| 2483.5 | 66.29 | -7.71 | 74 | 63.16 | 31.98 | 5.52 | 34.37 | 101 | 313 | Peak |
| 2483.5 | 45.54 | -8.46 | 54 | 42.41 | 31.98 | 5.52 | 34.37 | 101 | 313 | Average |
| 4924 | 52.93 | -21.07 | 74 | 67.06 | 34.35 | 8.03 | 56.51 | 102 | 6 | Peak |
| 4924 | 40.85 | -13.15 | 54 | 54.99 | 34.34 | 8.04 | 56.52 | 102 | 6 | Average |



| | | | |
|------------------------|---|----------------------------|----------|
| Test Mode : | Mode 6 | Temperature : | 21~22°C |
| Test Channel : | 11 | Relative Humidity : | 47~48% |
| Test Engineer : | Kay Wu | Polarization : | Vertical |
| Remark : | 2462 MHz is Fundamental Signals which can be ignored. | | |

| Frequency (MHz) | Level (dBuV/m) | Over Limit (dB) | Limit Line (dBuV/m) | Read Level (dBuV) | Antenna Factor (dB) | Cable Loss (dB) | Preamp Factor (dB) | Ant Pos (cm) | Table Pos (deg) | Remark |
|----------------------|---------------------|-------------------------|-----------------------------|---------------------------|-----------------------------|-------------------------|----------------------------|----------------------|-------------------------|---------|
| 30 | 21.66 | -18.34 | 40 | 34.75 | 17.91 | 0.72 | 31.72 | - | - | Peak |
| 52.68 | 34.98 | -5.02 | 40 | 58.03 | 7.76 | 0.88 | 31.69 | 100 | 138 | Peak |
| 91.29 | 26.15 | -17.35 | 43.5 | 47.48 | 9.24 | 1.15 | 31.72 | - | - | Peak |
| 463.8 | 19.47 | -26.53 | 46 | 31.68 | 17.07 | 2.55 | 31.83 | - | - | Peak |
| 638.8 | 21.75 | -24.25 | 46 | 31.47 | 19.26 | 3.02 | 32 | - | - | Peak |
| 875.4 | 25.66 | -20.34 | 46 | 32.34 | 21.42 | 3.65 | 31.75 | - | - | Peak |
| 2388 | 50.71 | -23.29 | 74 | 47.8 | 31.9 | 5.4 | 34.39 | 105 | 17 | Peak |
| 2388 | 37.83 | -16.17 | 54 | 34.92 | 31.9 | 5.4 | 34.39 | 105 | 17 | Average |
| 2462 | 103.31 | - | - | 100.23 | 31.97 | 5.49 | 34.38 | 105 | 17 | Peak |
| 2462 | 90.54 | - | - | 87.46 | 31.97 | 5.49 | 34.38 | 105 | 17 | Average |
| 2483.5 | 68.42 | -5.58 | 74 | 65.29 | 31.98 | 5.52 | 34.37 | 105 | 17 | Peak |
| 2483.5 | 47.82 | -6.18 | 54 | 44.69 | 31.98 | 5.52 | 34.37 | 105 | 17 | Average |
| 4924 | 56.15 | -17.85 | 74 | 70.29 | 34.34 | 8.04 | 56.52 | 100 | 44 | Peak |
| 4924 | 41.52 | -12.48 | 54 | 55.66 | 34.34 | 8.04 | 56.52 | 100 | 44 | Average |



| | | | |
|------------------------|---|----------------------------|------------|
| Test Mode : | Mode 7 | Temperature : | 21~22°C |
| Test Channel : | 01 | Relative Humidity : | 47~48% |
| Test Engineer : | Kay Wu | Polarization : | Horizontal |
| Remark : | 2412 MHz is Fundamental Signals which can be ignored. | | |

| Frequency (MHz) | Level (dBuV/m) | Over Limit (dB) | Limit Line (dBuV/m) | Read Level (dBuV) | Antenna Factor (dB) | Cable Loss (dB) | Preamp Factor (dB) | Ant Pos (cm) | Table Pos (deg) | Remark |
|----------------------|---------------------|-------------------------|-----------------------------|---------------------------|-----------------------------|-------------------------|----------------------------|----------------------|-------------------------|---------|
| 49.98 | 24.97 | -15.03 | 40 | 47.74 | 8.08 | 0.86 | 31.71 | 100 | 119 | Peak |
| 152.58 | 18.46 | -25.04 | 43.5 | 38.11 | 10.58 | 1.46 | 31.69 | - | - | Peak |
| 223.59 | 18.36 | -27.64 | 46 | 37.3 | 10.95 | 1.75 | 31.64 | - | - | Peak |
| 607.3 | 21.26 | -24.74 | 46 | 31.25 | 19.18 | 2.94 | 32.11 | - | - | Peak |
| 782.3 | 23.62 | -22.38 | 46 | 31.75 | 20.53 | 3.36 | 32.02 | - | - | Peak |
| 911.8 | 25.29 | -20.71 | 46 | 31.32 | 21.68 | 3.77 | 31.48 | - | - | Peak |
| 2389.61 | 50.84 | -23.16 | 74 | 47.93 | 31.9 | 5.4 | 34.39 | 103 | 308 | Peak |
| 2389.61 | 35.67 | -18.33 | 54 | 32.76 | 31.9 | 5.4 | 34.39 | 103 | 308 | Average |
| 2412 | 99.32 | - | - | 96.37 | 31.91 | 5.43 | 34.39 | 103 | 308 | Peak |
| 2412 | 86.79 | - | - | 83.84 | 31.91 | 5.43 | 34.39 | 103 | 308 | Average |
| 2492 | 45.83 | -28.17 | 74 | 42.68 | 32 | 5.52 | 34.37 | 103 | 308 | Peak |
| 2492 | 33.11 | -20.89 | 54 | 29.96 | 32 | 5.52 | 34.37 | 103 | 308 | Average |



| | | | |
|------------------------|---|----------------------------|----------|
| Test Mode : | Mode 7 | Temperature : | 21~22°C |
| Test Channel : | 01 | Relative Humidity : | 47~48% |
| Test Engineer : | Kay Wu | Polarization : | Vertical |
| Remark : | 2412 MHz is Fundamental Signals which can be ignored. | | |

| Frequency (MHz) | Level (dBuV/m) | Over Limit (dB) | Limit Line (dBuV/m) | Read Level (dBuV) | Antenna Factor (dB) | Cable Loss (dB) | Preamp Factor (dB) | Ant Pos (cm) | Table Pos (deg) | Remark |
|----------------------|---------------------|-------------------------|-----------------------------|---------------------------|-----------------------------|-------------------------|----------------------------|----------------------|-------------------------|---------|
| 47.28 | 31.02 | -8.98 | 40 | 52.76 | 9.12 | 0.84 | 31.7 | - | - | Peak |
| 52.68 | 35.3 | -4.7 | 40 | 58.35 | 7.76 | 0.88 | 31.69 | 100 | 39 | Peak |
| 91.29 | 24.8 | -18.7 | 43.5 | 46.13 | 9.24 | 1.15 | 31.72 | - | - | Peak |
| 498.8 | 19.87 | -26.13 | 46 | 31.2 | 17.79 | 2.66 | 31.78 | - | - | Peak |
| 661.9 | 22.3 | -23.7 | 46 | 31.88 | 19.3 | 3.1 | 31.98 | - | - | Peak |
| 896.4 | 25.79 | -20.21 | 46 | 32.07 | 21.6 | 3.74 | 31.62 | - | - | Peak |
| 2389.42 | 53.51 | -20.49 | 74 | 50.6 | 31.9 | 5.4 | 34.39 | 130 | 19 | Peak |
| 2389.42 | 37.94 | -16.06 | 54 | 35.03 | 31.9 | 5.4 | 34.39 | 130 | 19 | Average |
| 2412 | 100.71 | - | - | 97.76 | 31.91 | 5.43 | 34.39 | 130 | 19 | Peak |
| 2412 | 88.32 | - | - | 85.37 | 31.91 | 5.43 | 34.39 | 130 | 19 | Average |
| 2486 | 46.81 | -27.19 | 74 | 43.68 | 31.98 | 5.52 | 34.37 | 130 | 19 | Peak |
| 2486 | 33.51 | -20.49 | 54 | 30.38 | 31.98 | 5.52 | 34.37 | 130 | 19 | Average |



| | | | |
|------------------------|---|----------------------------|------------|
| Test Mode : | Mode 8 | Temperature : | 21~22°C |
| Test Channel : | 06 | Relative Humidity : | 47~48% |
| Test Engineer : | Kay Wu | Polarization : | Horizontal |
| Remark : | 2437 MHz is Fundamental Signals which can be ignored. | | |

| Frequency (MHz) | Level (dBuV/m) | Over Limit (dB) | Limit Line (dBuV/m) | Read Level (dBuV) | Antenna Factor (dB) | Cable Loss (dB) | Preamp Factor (dB) | Ant Pos (cm) | Table Pos (deg) | Remark |
|----------------------|---------------------|-------------------------|-----------------------------|---------------------------|-----------------------------|-------------------------|----------------------------|----------------------|-------------------------|---------|
| 49.44 | 25.76 | -14.24 | 40 | 48.19 | 8.43 | 0.85 | 31.71 | 100 | 176 | Peak |
| 152.04 | 19.67 | -23.83 | 43.5 | 39.32 | 10.58 | 1.46 | 31.69 | - | - | Peak |
| 222.78 | 18.89 | -27.11 | 46 | 37.91 | 10.88 | 1.75 | 31.65 | - | - | Peak |
| 567.4 | 22.05 | -23.95 | 46 | 32.42 | 18.73 | 2.87 | 31.97 | - | - | Peak |
| 771.8 | 23.16 | -22.84 | 46 | 31.48 | 20.38 | 3.35 | 32.05 | - | - | Peak |
| 943.3 | 25.71 | -20.29 | 46 | 31.27 | 21.83 | 3.79 | 31.18 | - | - | Peak |
| 2326 | 46.08 | -27.92 | 74 | 43.35 | 31.83 | 5.31 | 34.41 | 100 | 316 | Peak |
| 2326 | 33.2 | -20.8 | 54 | 30.47 | 31.83 | 5.31 | 34.41 | 100 | 316 | Average |
| 2437 | 97.05 | - | - | 94.02 | 31.95 | 5.46 | 34.38 | 100 | 316 | Peak |
| 2437 | 84.49 | - | - | 81.46 | 31.95 | 5.46 | 34.38 | 100 | 316 | Average |
| 2500 | 45.79 | -28.21 | 74 | 42.64 | 32 | 5.52 | 34.37 | 100 | 316 | Peak |
| 2500 | 33.12 | -20.88 | 54 | 29.97 | 32 | 5.52 | 34.37 | 100 | 316 | Average |
| 4874 | 48.36 | -25.64 | 74 | 62.48 | 34.37 | 8 | 56.49 | 100 | 0 | Peak |



| | | | |
|------------------------|---|----------------------------|----------|
| Test Mode : | Mode 8 | Temperature : | 21~22°C |
| Test Channel : | 06 | Relative Humidity : | 47~48% |
| Test Engineer : | Kay Wu | Polarization : | Vertical |
| Remark : | 2437 MHz is Fundamental Signals which can be ignored. | | |

| Frequency (MHz) | Level (dBuV/m) | Over Limit (dB) | Limit Line (dBuV/m) | Read Level (dBuV) | Antenna Factor (dB) | Cable Loss (dB) | Preamp Factor (dB) | Ant Pos (cm) | Table Pos (deg) | Remark |
|----------------------|---------------------|-------------------------|-----------------------------|---------------------------|-----------------------------|-------------------------|----------------------------|----------------------|-------------------------|---------|
| 52.68 | 35.77 | -4.23 | 40 | 58.82 | 7.76 | 0.88 | 31.69 | 100 | 182 | Peak |
| 90.48 | 25.73 | -17.77 | 43.5 | 47.24 | 9.08 | 1.14 | 31.73 | - | - | Peak |
| 152.58 | 23.36 | -20.14 | 43.5 | 43.01 | 10.58 | 1.46 | 31.69 | - | - | Peak |
| 502.3 | 20.44 | -25.56 | 46 | 31.69 | 17.86 | 2.68 | 31.79 | - | - | Peak |
| 656.3 | 22.6 | -23.4 | 46 | 32.2 | 19.29 | 3.08 | 31.97 | - | - | Peak |
| 913.9 | 25.7 | -20.3 | 46 | 31.7 | 21.69 | 3.77 | 31.46 | - | - | Peak |
| 2334 | 45.89 | -28.11 | 74 | 43.13 | 31.83 | 5.34 | 34.41 | 131 | 17 | Peak |
| 2334 | 33.36 | -20.64 | 54 | 30.6 | 31.83 | 5.34 | 34.41 | 131 | 17 | Average |
| 2437 | 87.3 | - | - | 84.27 | 31.95 | 5.46 | 34.38 | 131 | 17 | Average |
| 2437 | 99.4 | - | - | 96.37 | 31.95 | 5.46 | 34.38 | 131 | 17 | Peak |
| 2484 | 46.85 | -27.15 | 74 | 43.72 | 31.98 | 5.52 | 34.37 | 131 | 17 | Peak |
| 2484 | 33.44 | -20.56 | 54 | 30.31 | 31.98 | 5.52 | 34.37 | 131 | 17 | Average |



| | | | |
|------------------------|---|----------------------------|------------|
| Test Mode : | Mode 9 | Temperature : | 21~22°C |
| Test Channel : | 11 | Relative Humidity : | 47~48% |
| Test Engineer : | Kay Wu | Polarization : | Horizontal |
| Remark : | 2462 MHz is Fundamental Signals which can be ignored. | | |

| Frequency (MHz) | Level (dBuV/m) | Over Limit (dB) | Limit Line (dBuV/m) | Read Level (dBuV) | Antenna Factor (dB) | Cable Loss (dB) | Preamp Factor (dB) | Ant Pos (cm) | Table Pos (deg) | Remark |
|----------------------|---------------------|-------------------------|-----------------------------|---------------------------|-----------------------------|-------------------------|----------------------------|----------------------|-------------------------|---------|
| 49.98 | 26.87 | -13.13 | 40 | 49.64 | 8.08 | 0.86 | 31.71 | 100 | 126 | Peak |
| 150.69 | 18.87 | -24.63 | 43.5 | 38.4 | 10.7 | 1.46 | 31.69 | - | - | Peak |
| 223.59 | 20.39 | -25.61 | 46 | 39.33 | 10.95 | 1.75 | 31.64 | - | - | Peak |
| 518.4 | 20.32 | -25.68 | 46 | 31.32 | 18.08 | 2.74 | 31.82 | - | - | Peak |
| 766.9 | 23.17 | -22.83 | 46 | 31.57 | 20.31 | 3.35 | 32.06 | - | - | Peak |
| 943.3 | 26.35 | -19.65 | 46 | 31.91 | 21.83 | 3.79 | 31.18 | - | - | Peak |
| 2388 | 47.34 | -26.66 | 74 | 44.43 | 31.9 | 5.4 | 34.39 | 101 | 313 | Peak |
| 2388 | 34.58 | -19.42 | 54 | 31.67 | 31.9 | 5.4 | 34.39 | 101 | 313 | Average |
| 2462 | 98.77 | - | - | 95.69 | 31.97 | 5.49 | 34.38 | 101 | 313 | Peak |
| 2462 | 86.68 | - | - | 83.6 | 31.97 | 5.49 | 34.38 | 101 | 313 | Average |
| 2483.5 | 64.58 | -9.42 | 74 | 61.45 | 31.98 | 5.52 | 34.37 | 101 | 313 | Peak |
| 2483.5 | 44.6 | -9.4 | 54 | 41.47 | 31.98 | 5.52 | 34.37 | 101 | 313 | Average |
| 4924 | 52.86 | -21.14 | 74 | 66.99 | 34.35 | 8.03 | 56.51 | 100 | 19 | Peak |
| 4924 | 39.61 | -14.39 | 54 | 53.75 | 34.34 | 8.04 | 56.52 | 100 | 19 | Average |



| | | | |
|------------------------|---|----------------------------|----------|
| Test Mode : | Mode 9 | Temperature : | 21~22°C |
| Test Channel : | 11 | Relative Humidity : | 47~48% |
| Test Engineer : | Kay Wu | Polarization : | Vertical |
| Remark : | 2462 MHz is Fundamental Signals which can be ignored. | | |

| Frequency (MHz) | Level (dBuV/m) | Over Limit (dB) | Limit Line (dBuV/m) | Read Level (dBuV) | Antenna Factor (dB) | Cable Loss (dB) | Preamp Factor (dB) | Ant Pos (cm) | Table Pos (deg) | Remark |
|----------------------|---------------------|-------------------------|-----------------------------|---------------------------|-----------------------------|-------------------------|----------------------------|----------------------|-------------------------|---------|
| 53.49 | 35.48 | -4.52 | 40 | 58.69 | 7.6 | 0.88 | 31.69 | 100 | 256 | Peak |
| 92.64 | 24.71 | -18.79 | 43.5 | 45.7 | 9.56 | 1.16 | 31.71 | - | - | Peak |
| 151.23 | 22.86 | -20.64 | 43.5 | 42.45 | 10.64 | 1.46 | 31.69 | - | - | Peak |
| 528.9 | 20.32 | -25.68 | 46 | 31.18 | 18.21 | 2.77 | 31.84 | - | - | Peak |
| 747.3 | 23.17 | -22.83 | 46 | 31.89 | 20.03 | 3.35 | 32.1 | - | - | Peak |
| 952.4 | 25.29 | -20.71 | 46 | 30.74 | 21.87 | 3.79 | 31.11 | - | - | Peak |
| 2388 | 46.99 | -27.01 | 74 | 44.08 | 31.9 | 5.4 | 34.39 | 105 | 18 | Peak |
| 2388 | 35.45 | -18.55 | 54 | 32.54 | 31.9 | 5.4 | 34.39 | 105 | 18 | Average |
| 2462 | 100.28 | - | - | 97.2 | 31.97 | 5.49 | 34.38 | 105 | 18 | Peak |
| 2462 | 87.58 | - | - | 84.5 | 31.97 | 5.49 | 34.38 | 105 | 18 | Average |
| 2483.5 | 64.59 | -9.41 | 74 | 61.46 | 31.98 | 5.52 | 34.37 | 105 | 18 | Peak |
| 2483.5 | 45.88 | -8.12 | 54 | 42.75 | 31.98 | 5.52 | 34.37 | 105 | 18 | Average |
| 4924 | 53.74 | -20.26 | 74 | 67.88 | 34.34 | 8.04 | 56.52 | 100 | 43 | Peak |
| 4924 | 43.56 | -10.44 | 54 | 57.7 | 34.34 | 8.04 | 56.52 | 100 | 43 | Average |



3.8 Antenna Requirements

3.8.1 Standard Applicable

If directional gain of transmitting antennas is greater than 6dBi, the power shall be reduced by the same level in dB comparing to gain minus 6dBi. For the fixed point-to-point operation, the power shall be reduced by one dB for every 3 dB that the directional gain of the antenna exceeds 6 dBi. The use of a permanently attached antenna or of an antenna that uses a unique coupling to the intentional radiator shall be considered sufficient to comply with the FCC rule.

3.8.2 Antenna Connected Construction

The antennas type used in this product is PIFA Antenna without connector and it is considered to meet antenna requirement.

3.8.3 Antenna Gain

The antenna peak gain of EUT is less than 6 dBi. Therefore, it is not necessary to reduce maximum peak output power limit.



4 List of Measuring Equipment

| Instrument | Manufacturer | Model No. | Serial No. | Characteristics | Calibration Date | Due Date | Remark |
|---------------------------------------|-------------------|------------|-------------|-----------------|------------------|---------------|-----------------------|
| System Simulator | R&S | CMU200 | 117995 | N/A | Jun. 08, 2009 | Jun. 07, 2011 | Conducted (TH02-HY) |
| Spectrum Analyzer | R&S | FSP40 | 100055 | 9kHz~40GHz | Jun. 11, 2010 | Jun. 10, 2011 | Conducted (TH02-HY) |
| Power Meter | Anritsu | ML2495A | 0932001 | N/A | Sep. 13, 2010 | Sep. 12, 2011 | Conducted (TH02-HY) |
| Power Sensor | Anritsu | MA2411B | 0846202 | N/A | Sep. 14, 2010 | Sep. 13, 2011 | Conducted (TH02-HY) |
| Thermal Chamber | Ten Billion | TTH-D35P | TBN-930701 | N/A | Jul. 30, 2010 | Jul. 29, 2011 | Conducted (TH02-HY) |
| EMI Test Receive | R&S | ESCS 30 | 100356 | 9KHz – 2.75GHz | Aug. 16, 2010 | Aug. 15, 2011 | Conduction (CO05-HY) |
| Two-LISN | R&S | ENV216 | 11-100081 | 9KHz – 30MHz | Dec. 03, 2010 | Dec. 02, 2011 | Conduction (CO05-HY) |
| Two-LISN | R&S | ENV216 | 11-100080 | 9KHz – 30MHz | Dec. 01, 2010 | Nov. 30, 2011 | Conduction (CO05-HY) |
| System Simulator | R&S | CMU200 | 117591 | N/A | Oct. 18, 2010 | Oct. 17, 2011 | Conduction (CO05-HY) |
| WiMAX Base Station (System Simulator) | Agilent | E6651A | N/A | N/A | N/A | N/A | Conduction (CO05-HY) |
| AC Power Source | APC | APC-1000 W | N/A | N/A | N/A | N/A | Radiation (03CH06-HY) |
| Spectrum Analyzer | R&S | FSP40 | 100057 | 9KHz-40GHz | Oct. 25, 2010 | Oct. 24, 2011 | Radiation (03CH06-HY) |
| EMI Test Receiver | R&S | ESVS10 | 834468/003 | 20MHz-1000MHz | Apr. 28, 2010 | Apr. 27, 2011 | Radiation (03CH06-HY) |
| Bilog Antenna | SCHAFFNER | CBL6112B | 2885 | 30MHz -2GHz | Oct. 31, 2010 | Oct. 31, 2011 | Radiation (03CH06-HY) |
| Double Ridge Horn Antenna | EMCO | 3117 | 00066583 | 1GHz~18GHz | Aug. 02, 2010 | Aug. 01, 2011 | Radiation (03CH06-HY) |
| Double Ridge Horn Antenna | Training Research | AH-0801 | 95119 | 8GHz~18GHz | Oct. 20, 2010 | Oct. 19, 2011 | Radiation (03CH06-HY) |
| SHF-EHF Horn Antenna | SCHWARZBECK | BBHA 9170 | BBHA9170251 | 15GHz- 40GHz | Oct. 18, 2010 | Oct. 17, 2011 | Radiation (03CH06-HY) |
| Pre Amplifier | Agilent | 8449B | 3008A01917 | 1GHz- 26.5GHz | Apr. 14, 2011 | Apr. 13, 2012 | Radiation (03CH06-HY) |
| Amplifier | Agilent | 310N | 186713 | 9KHz~1GHz | Apr. 14, 2011 | Apr. 13, 2012 | Radiation (03CH06-HY) |
| Loop Antenna | R&S | HFH2-Z2 | 860004/001 | 9 kHz~30 MHz | Jul. 29, 2010 | Jul. 28, 2011 | Radiation (03CH06-HY) |

5 Uncertainty of Evaluation

Uncertainty of Conducted Emission Measurement (150 kHz ~ 30 MHz)

| Contribution | Uncertainty of X_i | | $u(X_i)$ |
|--|----------------------|--------------------------|----------|
| | dB | Probability Distribution | |
| Receiver Reading | 0.10 | Normal (k=2) | 0.05 |
| Cable Loss | 0.10 | Normal (k=2) | 0.05 |
| AMN Insertion Loss | 2.50 | Rectangular | 0.63 |
| Receiver Specification | 1.50 | Rectangular | 0.43 |
| Site Imperfection | 1.39 | Rectangular | 0.80 |
| Mismatch | +0.34 / -0.35 | U-Shape | 0.24 |
| Combined Standard Uncertainty $U_c(y)$ | 1.13 | | |
| Measuring Uncertainty for a Level of Confidence of 95% ($U = 2U_c(y)$) | 2.26 | | |

Uncertainty of Radiated Emission Measurement (30 MHz ~ 1000 MHz)

| Contribution | Uncertainty of X_i | | $u(X_i)$ |
|--|----------------------|--------------------------|----------|
| | dB | Probability Distribution | |
| Receiver Reading | 0.41 | Normal (k=2) | 0.21 |
| Antenna Factor Calibration | 0.83 | Normal (k=2) | 0.42 |
| Cable Loss Calibration | 0.25 | Normal (k=2) | 0.13 |
| Pre-Amplifier Gain Calibration | 0.27 | Normal (k=2) | 0.14 |
| RCV/SPA Specification | 2.50 | Rectangular | 0.72 |
| Antenna Factor Interpolation for Frequency | 1.00 | Rectangular | 0.29 |
| Site Imperfection | 1.43 | Rectangular | 0.83 |
| Mismatch | +0.39 / -0.41 | U-Shape | 0.28 |
| Combined Standard Uncertainty $U_c(y)$ | 1.27 | | |
| Measuring Uncertainty for a Level of Confidence of 95% ($U = 2U_c(y)$) | 2.54 | | |



Uncertainty of Radiated Emission Measurement (1 GHz ~ 40 GHz)

| Contribution | Uncertainty of X_i | | $u(X_i)$ | C_i | $C_i * u(X_i)$ |
|--|----------------------|--------------------------|----------|-------|----------------|
| | dB | Probability Distribution | | | |
| Receiver Reading | ±0.10 | Normal (k=2) | 0.10 | 1 | 0.10 |
| Antenna Factor Calibration | ±1.70 | Normal (k=2) | 0.85 | 1 | 0.85 |
| Cable Loss Calibration | ±0.50 | Normal (k=2) | 0.25 | 1 | 0.25 |
| Receiver Correction | ±2.00 | Rectangular | 1.15 | 1 | 1.15 |
| Antenna Factor Directional | ±1.50 | Rectangular | 0.87 | 1 | 0.87 |
| Site Imperfection | ±2.80 | Triangular | 1.14 | 1 | 1.14 |
| Mismatch Receiver VSWR $\Gamma_1 = 0.197$ Antenna VSWR $\Gamma_2 = 0.194$ Uncertainty = $20\text{Log}(1-\Gamma_1*\Gamma_2)$ | +0.34 / -0.35 | U-Shape | 0.244 | 1 | 0.244 |
| Combined Standard Uncertainty $U_c(y)$ | 2.36 | | | | |
| Measuring Uncertainty for a Level of Confidence of 95% ($U = 2U_c(y)$) | 4.72 | | | | |